

How to get the best from **Your Refrigerator**

Contents

Appliance Registration	2	Shelves	15
Base Grille	4	Solid State Monitor	6-9
Care and Cleaning	18, 19	Door Alarm	7
Condenser	19	Status Check—Reset	7
Countermaker Compartment	10	Warm Temperature	7
Diagnostic Codes	6-9	Storage Drawers	16, 17
Energy Saver System	5	Drawer & Cover Removal	17
Energy-Saving Tips	2	Temperature Controls	5
Food Storage Suggestions	14	Vacation & Moving Tips	19
Storage Times	14	Warranty	Back Cover
Ice Dispenser	11-13	Water Filter Accessory	13
Icemaker	11-13		
Installation	3,4		
Adapter Plug	4		
Adjustable Rollers	4		
Clearances	4		
Electrical Requirements	3,4		
Extension Cord	4		
Grounding	3		
Location	4		
Water Supply to Icemaker	4		
Light Bulb Replacement	19		
Model and Serial Numbers	2		
Problem Solver	20-22		
Repair Service	23	GE Answer Center™	
Safety Instructions	3	800.626.2000	

Use and Care of
models
CSX27C
and
CSXW27C

Ice & Water Dispenser

Countermaker
Compartment

Solid State Monitor &
Diagnostic System

HOTPOINT

Help us help you...

Read this book carefully.

It is intended to help you operate and maintain your new refrigerator properly.

Keep it handy for answers to your questions.

If you don't understand something or need more help, write (include your phone number):

Consumer Affairs
Hotpoint
Appliance Park
Louisville, KY 40225

Write down the model and serial numbers.

You'll see them on a label at the bottom, just inside the fresh food compartment door.

These numbers are also on the Consumer Product Ownership Registration Card that came with your refrigerator.

Before sending in this card, please write these numbers here:

Model Number

Serial Number

Use these numbers in any correspondence or service calls concerning your refrigerator.

If you received a damaged refrigerator, immediately contact the dealer (or builder) that sold you the refrigerator.

Save time and money. Before you request service, check the Problem Solver on pages 20 through 22. It lists causes of minor operating problems that you can correct yourself.

Energy-saving tips

- Location of your refrigerator is important. Avoid locating it next to your range, a heating vent or where the sun will shine directly on it.
- Don't open the doors more often than necessary.
- Close the doors as soon as possible, particularly in hot, humid weather.
- Be sure the doors are closed tightly. Before leaving the house or retiring for the night, check to be sure the doors haven't been **left** open accidentally.
- Store only those foods requiring refrigeration in your refrigerator.
- Wipe moisture from bottles and cartons before putting them in the refrigerator.
- Keep foods covered to reduce moisture buildup inside the refrigerator.
- If you turn the controls to the coldest position for quick chilling or freezing, be sure to turn them back to regular settings.
- Don't overcrowd your refrigerator. Overcrowding can require extra electrical energy to keep everything cool.

IMPORTANT SAFETY INSTRUCTIONS

Read all instructions before using this appliance.

WARNING—when using this appliance, always exercise basic safety precautions, including the following:

- Use this appliance only for its intended purpose as described in this Use and Care Book.

- This refrigerator must be properly installed in We-e with the Installation Instructions before it is used. See grounding instructions below and on page 4.

- Never unplug your-rater by pulling on the power cord. Always grip plug firmly and pull straight out from the outlet.

- Repair or replace immediately all elect* service cords that have become frayed or otherwise damaged. Do not use a cord that shows cracks or abrasion damage along its length or at either the plug or connector end,

- When moving your refrigerator away from the wall, be careful not to roll over or damage the power cord.

- After your refrigerator is in operation, do not touch the cold surfaces, particularly when hands are damp or wet. Skin may adhere to these extremely cold surfaces.

- Do not on the automatic icemaking mechanism while the *rotor is plugged in. This will prevent contact with the moving parts of the ejector mechanism, or with the heating element that releases the cubes.

- Do not allow anyone to climb, sit, stand or hang on the Countermaker Compartment door (seepage 10). They could damage the refrigerator and maybe even tip it over, causing severe personal injury.

- Don't refreeze frozen foods which have thawed completely.

The United States Department of Agriculture in Home and Garden Bulletin No. 69 says:

“... You may safely refreeze frozen foods that have thawed if they still contain ice crystals or if they are still cold-below 40°F.

“... Thawed ground meats, poultry, or fish that have any off-odor or off-color should not be refrozen and should not be eaten. Thawed ice cream should be discarded. If the odor or color of any food is poor or questionable, get rid of it. The food may be dangerous to eat.

“Even partial thawing and reduce the eating quality of foods,

particularly fruits, vegetables and prepared foods. The eating quality of red meats is affected less than that of-y other foods. Use refrozen foods as soon as possible to save as much of their eating quality as you can.”

- If your old refrigerator is still around the house but not in use, be sure to remove the doors. This will reduce the possibility of danger to children.

- Unplug your refrigerator.

A. Before making any repairs.

Note: We strongly recommend that any servicing be performed by a qualified individual.

B. Before cleaning.

C. Before replacing a burned-out light bulb, the refrigerator should be unplugged in order to avoid contact with alive wire filament. (A burned-out light bulb may break when being replaced.)

Note: Turning control to OFF position does not remove power to the light circuit.

- Do not operate your refrigerator in the presence of explosive fumes.

SAVE THESE INSTRUCTIONS

Installation Requirements—IMPORTANT: Please read carefully.

How to connect electricity

For personal safety, this appliance must be properly grounded.

The power cord of this appliance is equipped with a grounding plug which mates with a standard grounded wall outlet (Fig. 1) to minimize the possibility of electric shock hazard from this appliance.

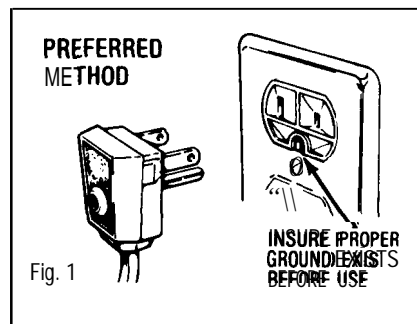

Have the wall outlet checked by a qualified electrician to make sure the outlet is properly grounded.

Where a standard two-prong wall outlet is encountered, it is your personal responsibility and obligation to have it replaced with a properly grounded three-prong wall outlet.

DO NOT, UNDER ANY CIRCUMSTANCES, CUT OR REMOVE THE THIRD (GROUND) PRONG FROM THE POWER CORD.

(continued next page)

Installation Requirements (continued)—IMPORTANT... Please Read Carefully

Use of Adapter Plug

Because of potential safety hazards under certain conditions, we strongly recommend against use of an adapter plug. However, if you still elect to use an adapter, where local codes permit, a **TEMPORARY CONNECTION** may be made to a properly grounded two-prong wall outlet by use of a UL listed adapter (Fig. 2) available at most local hardware stores.

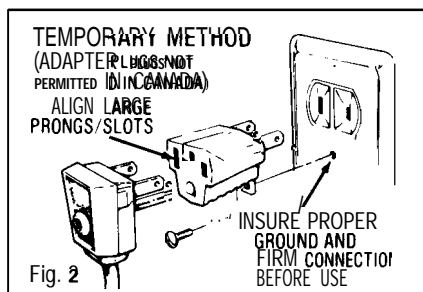

The larger slot in the adapter must be aligned with the larger slot in the wall outlet to provide proper polarity in the connection of the power cord.

CAUTION: Attaching an adapter ground terminal to wall outlet cover screw does not ground appliance unless cover screw is metal, and not insulated, and wall outlet is grounded through house wiring. You should have circuit checked by a qualified electrician to make sure the outlet is properly grounded.

When disconnecting the power cord from the adapter, always hold the adapter with one hand. If this is not done, the adapter ground terminal is very likely to break with repeated use.

Should the adapter ground terminal break, DO NOT USE the appliance until a proper ground has again been established.

Use of Extension Cords

Because of potential safety hazards under certain conditions, we strongly recommend against the use of an extension cord. However, if you still elect to use an extension cord, it is absolutely necessary that it be a UL listed 3-wire grounding type appliance extension cord having

a grounding type plug and outlet and that the electrical rating of the cord be 15 amperes (minimum) and 120 volts.

The refrigerator should always be plugged into its own individual electrical outlet—(115 volt, 60 Hertz, or 100 volt, 50 Hertz, single phase AC). This is recommended for best performance and to prevent overloading house wiring circuits, which could cause a fire hazard from overheating wires.

Refrigerator Location

Do not install refrigerator where temperature will go below 60°F, because it will not run often enough to maintain proper temperatures.

Do install it on a floor strong enough to support a fully loaded refrigerator.

Also see Energy-Saving Tips.

Clearances

Allow the following clearances for ease of installation, proper air circulation and plumbing and electrical connections:

Sides	5/8"
Top	0"
Back	1"

Allow following door clearances:

Countertop Side	3 5/8"
Freezer Side	1 3/4"

Water Supply to Icemaker

You will need to connect your icemaker to a cold water line. A water supply kit containing copper tubing, shutoff valve, fittings and instructions is available at extra cost from your dealer. There should be sufficient tubing for the icemaker from the cold water supply to allow moving the refrigerator out from the wall several feet (approximately 8 feet of 1/4" copper tubing in three 10-inch diameter coils.)

Rollers

Adjustable rollers behind the base grille enable you to move the refrigerator away from the wall for cleaning. These rollers should be set so the refrigerator rests firmly on the floor. To assure that the doors will close automatically from a halfway-open position, there is a built-in tilt from the front to the back of the cabinet. Side-by-side refrigerators also have specially designed door hinges that lift both doors slightly when opened, allowing the force of gravity to help close them securely.

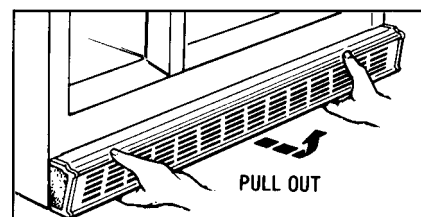

To adjust rollers, remove the base grille by grasping it at the bottom and pulling it out.

Turn roller adjusting screws clockwise to raise refrigerator, counterclockwise to lower it. Use adjustable wrench (3/8" hex head bolt) or pliers.

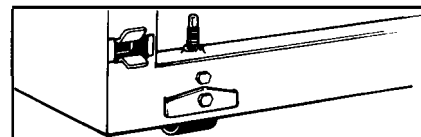

When adjusting front rollers for proper door closure, we recommend that the bottom front edge of the cabinet be approximately 3/4" from the floor.

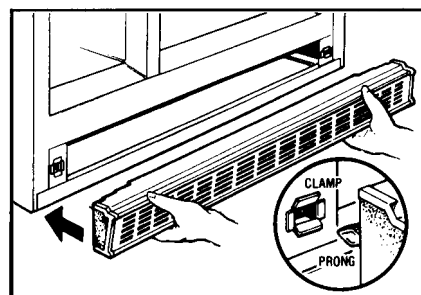

To replace base grille, align prongs on back of grille with clamps in cabinet and push forward until the grille snaps into place.

Operating Your Refrigerator

Set the Temperature Controls

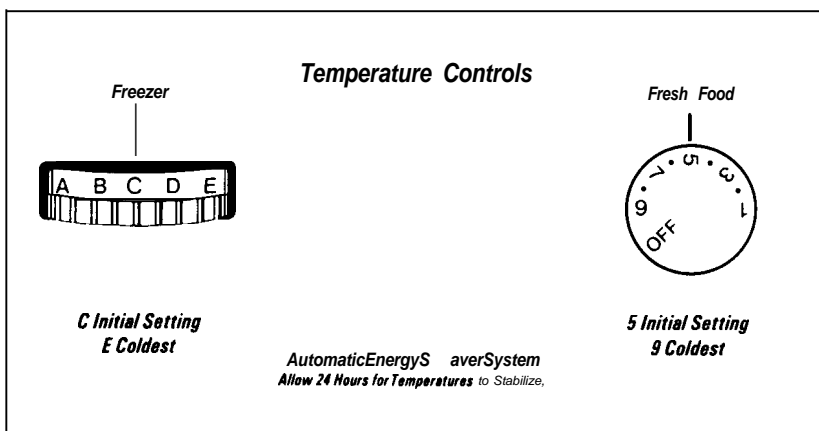

Your refrigerator has two controls that let you regulate the temperature in the fresh food and freezer compartments.

INITIALLY, set the FRESH FOOD control at 5 and the FREEZER control at C.

For colder or warmer temperatures, adjust the desired compartment control one letter or number at a time.

IMPORTANT

When initially setting the controls, or when adjusting them, allow 24 hours for the temperatures to stabilize, or even out. Do this before filling the refrigerator with large amounts of fresh or frozen foods.

Note: Turning the fresh food control to “OFF” stops cooling in BOTH compartments—fresh food AND freezer—but does not shut off power to the refrigerator.

How to Test Temperatures

Use the milk test for the fresh food compartment. Place a container of milk on the top shelf in the fresh food compartment. Check it a day later. If the milk is too warm or too cold, adjust the temperature controls.

Use the ice cream test for the freezer compartment. Place a container of ice cream in the center of the freezer compartment. Check it after a day. If it's too hard or too soft, adjust the temperature controls.

Always allow 24 hours for the refrigerator to reach the temperature you set.

If you turn your household thermostat below 60°F. at night

...you may want to turn the *lettered* control one step colder, as from “C” to “D.” Cooler temperatures in the house may cause the compressor to operate less frequently, thus allowing the freezer compartment to warm somewhat. To protect your frozen food supply, leave your *lettered* setting at this colder setting for the entire winter or for whatever period of time you are turning down your thermostat. This is especially important when the thermostat is turned down for an extended period.

This change should have no effect on your fresh food compartment. However, if freezing occurs, turn the numbered control one step warmer, as from “5” to “4.”

When you stop turning the thermostat down, turn temperature controls back to their regular settings.

Automatic Energy Saver System

You won't find an “energy saver” switch on this refrigerator.

Warm liquid from the refrigerator's condenser is automatically circulated around the front edge of the freezer compartment to help keep moisture from forming on the outside of the refrigerator during humid weather.

Many refrigerators use special electric heaters. This refrigerator needs none. That's why there is no “energy saver” switch. there's no need for it.

No Defrosting

It is not necessary to defrost the freezer or fresh food compartments. Your refrigerator is designed and equipped to defrost itself automatically.

Solid State Monitor System

It keeps an eye on things for you.

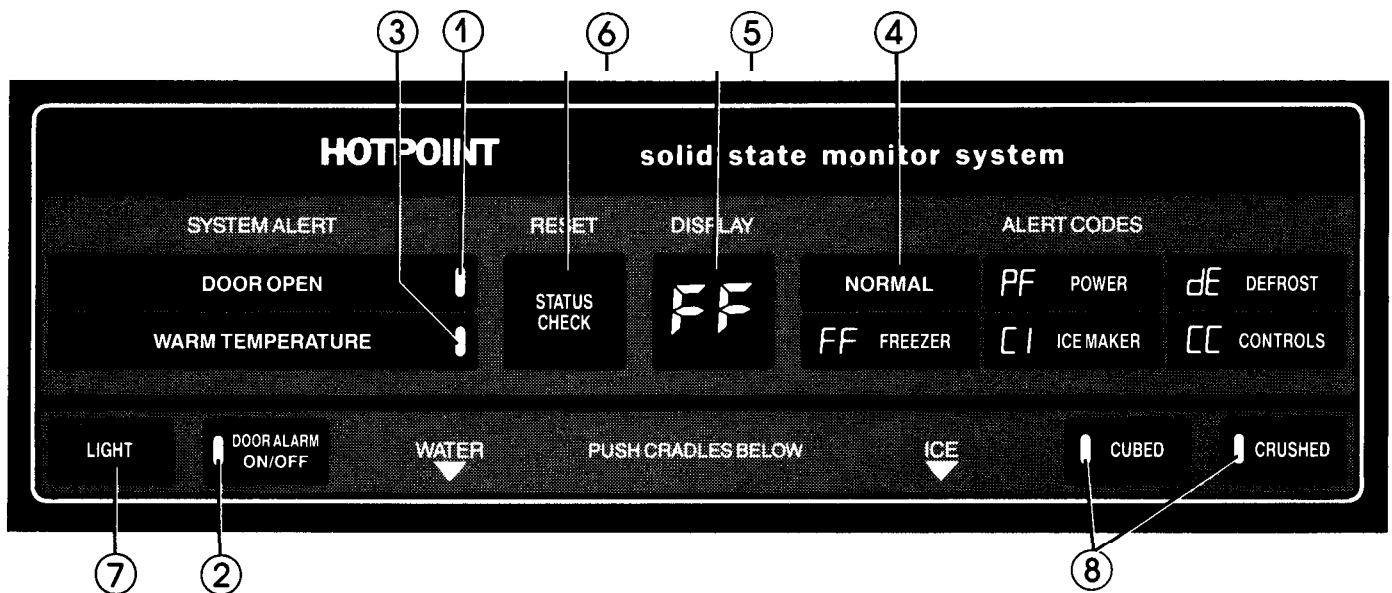

@Red signal light flashes to tell you when either door is open.

@Signal light tells you that the Door Alarm beeper has been set to sound after either door has been open 30 seconds.

@Red signal light tells you when freezer foodkeeping temperature is above normal.

@Lighted word NORMAL indicates that no failure has been detected by the diagnostic system.

@Flashing diagnostic codes in the display warn you when:

- frozen foods should be checked.
- power has been interrupted.
- icemaker may not be operating properly.
- defrost system has failed.
- freezer control may need to be set for a colder temperature.

What these codes mean—and what to do when they appear—is summarized on the inside of the freezer compartment door and explained more thoroughly on the following pages.

@STATUS CHECK pad puts a review of the electronic diagnosis of five coded functions at your fingertip and also allows you to erase codes and reset the display.

⑦ Electronic control allows you to turn night light in water-and-ice service on and off.

⑧ Electronic control allows you to select ice cubes or crushed ice, and signal light confirms your choice.

When your refrigerator is first plugged in...

All panel lights come on for five seconds, a beep sounds, and lights go off except as follows:

- PF flashes in the display. Touch STATUS CHECK-RESET pad to erase it.
- Word NORMAL glows.
- Red WARM TEMPERATURE light glows if freezer compartment temperature is higher than normal. It goes off when proper foodkeeping temperature is reached.
- Door alarm beeper is activated and light on DOOR ALARM pad glows.
- CRUSHED ice selection light glows.
- Red DOOR OPEN light flashes if either door is open, goes out when doors are shut.
- Night light in water-and-ice service is off.

How to Set the Door Alarm

You don't have to set the visual alarm. As long as either door is open, the red DOOR OPEN signal light flashes.



If the signal light on the DOOR ALARM pad is glowing, the beeper alarm is set. If it's not, touch the pad to turn it on.

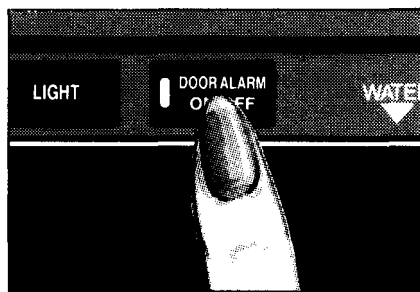

If either door is open for more than 30 seconds, a recurring beep sounds.

The light goes out and the beeping stops when you close the door.

There are times when you'll want the Door Alarm beeper turned off. When you're rearranging a lot of food, for example. Just touch the pad. The light will go out and the beeping will stop.

Deactivating the Door Alarm beeper does not turn the red DOOR OPEN light off—it keeps flashing until the door is closed.

Why the Red Warm Temperature Light Glows.

At first, it's probably because your newly installed refrigerator hasn't completely cooled down yet. Wait a few hours for it to cool, and then the light will go out.



From then on, the red light will glow whenever temperatures inside get too high for proper food storage. If this happens, open the doors only when absolutely necessary, and close them as quickly as possible.

As soon as inside temperatures return to normal, the light goes out.

How the Solid State Monitor System Works.

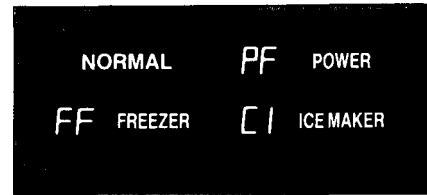

The word NORMAL is lighted except when a failure has been detected.

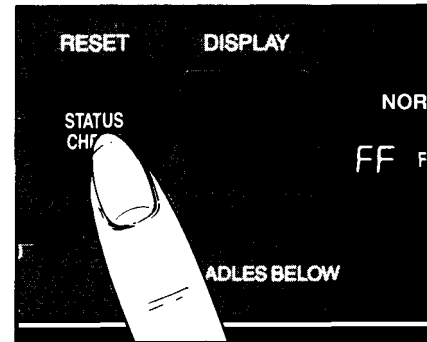

The STATUS CHECK-RESET pad has two functions:

1. You can touch the STATUS CHECK-RESET pad and get a review of the electronic diagnostic codes in order of their priority.
2. You can touch the STATUS CHECK-RESET pad to erase three flashing codes immediately. Two codes (DE and FF) cannot be erased until the condition that caused them to flash has been corrected (see page 8).

(continued next page)

Solid State Monitor System (continued)

The Solid State Monitor System alerts you when something starts to go wrong.

If a diagnostic code appears on the display, something needs special attention. To get your attention, the display code flashes until you erase it. The first 6 flashes are accompanied by beeps.

If more than one coded function requires attention at the same time, the one with the highest priority will be displayed first.

Pressing the STATUS CHECK-RESET pad will evaluate all other coded functions. If the NORMAL display is lit during the displaying of a code, that function is operating properly.

Pressing the STATUS CHECK-RESET pad will erase three codes immediately—*PF*, *CI* and *CC*. The *DE* and *FF* codes can only be erased by touching the STATUS CHECK-RESET pad *after* the condition that caused the code to flash has been corrected.

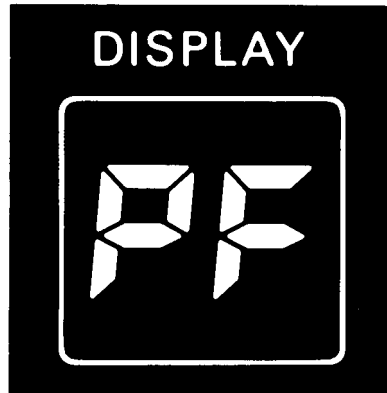

This flashing code tells you the power to the refrigerator has been interrupted for more than 2 seconds. Check the condition of food in both the fresh food and freezer compartments. Touch STATUS CHECK-RESET pad to erase code.

There is no fault with the refrigerator when *PF* code flashes.

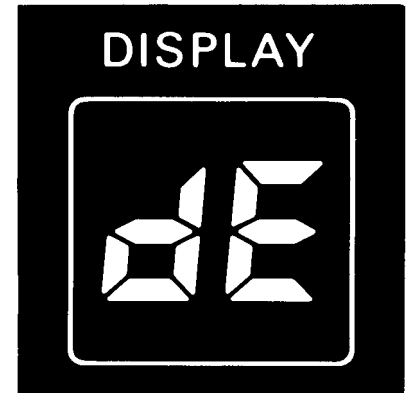

This flashing code tells you something's wrong with the defrost system—**keep doors closed to retain cold and call for service.** Code flashes until problem is corrected.

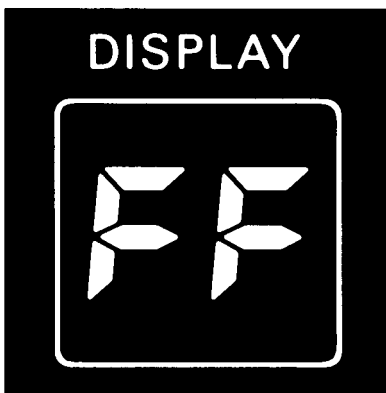

This flashing code tells you to **check your frozen food.** Has any of it started to thaw? A package may be holding the freezer compartment door open. Don't open the door more often than absolutely necessary while this code is displayed. Touching the STATUS CHECK-RESET pad after the freezer compartment temperature has returned to normal will erase the code.

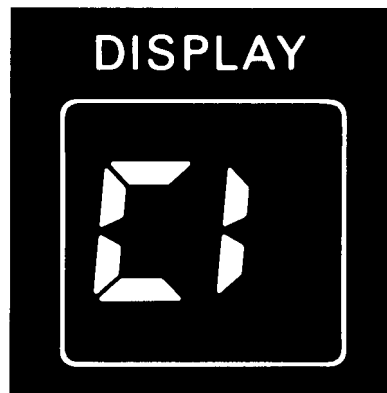

This flashing code tells you to **check the automatic icemaker.** Ice clumps in the storage bin may have stalled the icemaker. Follow corrective measures described on page 13. If water supply to the icemaker is not connected or not turned on, make sure manual icemaker switch is in the OFF position (see page 11). Code stops flashing when problem is corrected or STATUS CHECK-RESET pad is touched.

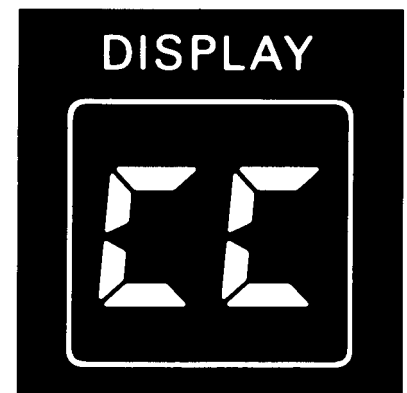

This flashing code tells you to **check temperature controls** and adjust them if necessary. (See directions on page 5.) Touch STATUS CHECK-RESET pad to erase code. If code reappears after 4 hours, call for service.

Signal Lights and Diagnostic Codes

What they mean, and what to do when they alert you, is summarized on this panel on the inside of the freezer compartment door.

SOLID STATE MONITOR SYSTEM	
DISPLAY	EXPLANATION / RECOMMENDED ACTION
NORMAL	ALL SYSTEMS OPERATING NORMALLY <div style="border: 1px solid black; padding: 2px; display: inline-block; margin: 5px;"> RESET STATUS CHECK </div> TO CHECK SYSTEM ... TOUCH STATUS CHECK ... LOOK FOR "NORMAL" READOUT DURING EACH CODE DISPLAY
DOOR OPEN	DOORS NOT COMPLETELY CLOSED ... CHECK FOR OPEN BINS ... PACKAGES MAY BE BLOCKING DOOR
WARM TEMPERATURE	THIS MAY OCCUR WHEN REFRIGERATOR IS FIRST TURNED ON OR DOORS LEFT OPEN TOO LONG
FF FREEZER	CHECK FOR THAWING OF FROZEN FOODS ... LIMIT DOOR OPENINGS TO RETAIN COLD ... CALL FOR SERVICE IF NECESSARY
PF POWER	POWER HAS BEEN OFF FOR SOME PERIOD OF TIME ... CHECK CONDITION OF FOOD ... TOUCH RESET
CI ICE MAKER	CHECK ICE BIN FOR BLOCKAGE ... TOUCH RESET ... IF CODE APPEARS AGAIN, CALL FOR SERVICE
DE DEFROST	LIMIT DOOR OPENINGS TO RETAIN COLD ... CALL FOR SERVICE
CC CONTROLS	CHECK TEMPERATURE CONTROLS ... ADJUST IF NECESSARY ... TOUCH RESET ... IF CODE REAPPEARS WITHIN 4 HRS. CALL FOR SERVICE
SEE YOUR USE AND CARE BOOK FOR COMPLETE INSTRUCTIONS	

Panel located on the inside of the freezer compartment door.

This refrigerator features an Automatic Icemaker, an Ice & Water Dispenser and a special Countermaker Compartment with its own door that becomes a counter when you open it.

Icemaker

- It replaces the ice you use. . . automatically.

Ice & Water Dispenser

- It dispenses ice cubes, crushed ice and chilled water through the freezer compartment door.

Countermaker Compartment

- It makes frequently used items stored on the fresh food door readily accessible through the Countermaker Compartment door without having to open the main refrigerator door.

. It provides an extra counter-high work surface with its own light right at the refrigerator when the Countermaker Compartment door is open. To open, lift compartment door handle and pull down. Close door after use.

Although durable, stain- and scratch-resistant, the work surface on the Countermaker door should not be used as a cutting board. Sharp utensils can damage it.

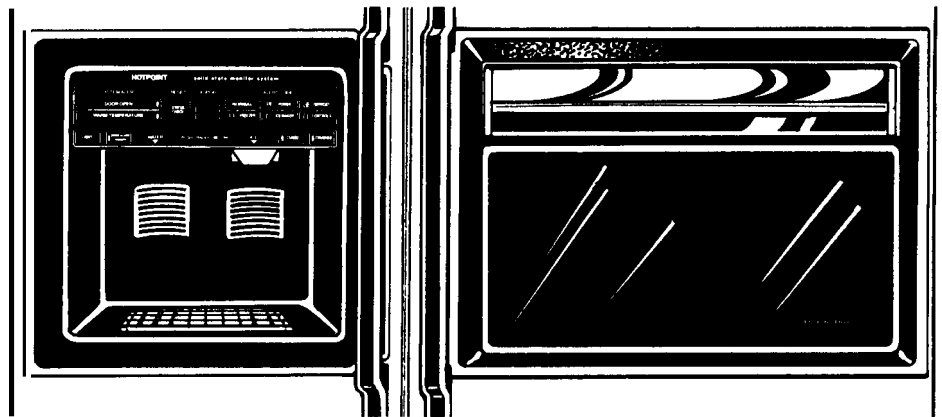

To remove the Countermaker Compartment door bin, open the outer door to free the lip on the bin from the overlapping door.

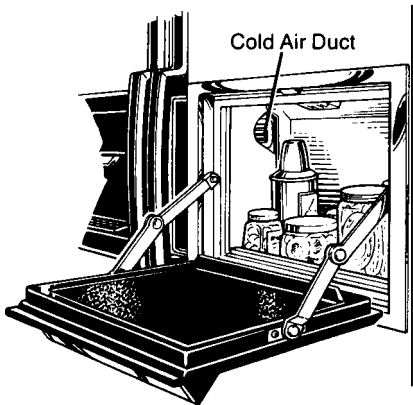

Cold air entering from the freezer compartment keeps the temperature in the Countermaker Compartment at proper food-keeping levels.

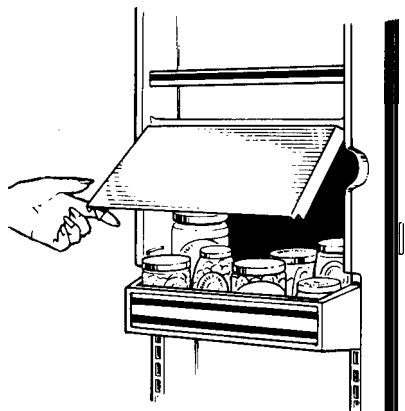

The Countermaker Compartment is also accessible through a lift-up door on the inside of the fresh food compartment door.

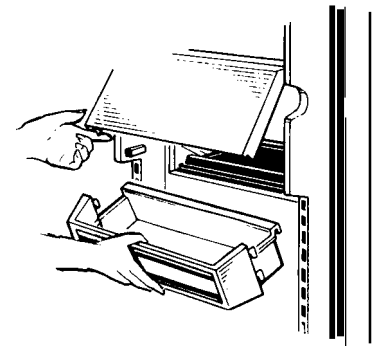

Then raise the inner door and lift the bin straight up until hooks on bin come out of tracks on door.

Countermaker Compartment door bin must be replaced in its original position,

Ice & Chilled Water Dispenser

Automatic Icemaker and Ice & Water Dispenser

Your refrigerator has an automatic icemaker and a dispenser that dispenses chilled water and ice cubes through the freezer compartment door. Here's how they work.

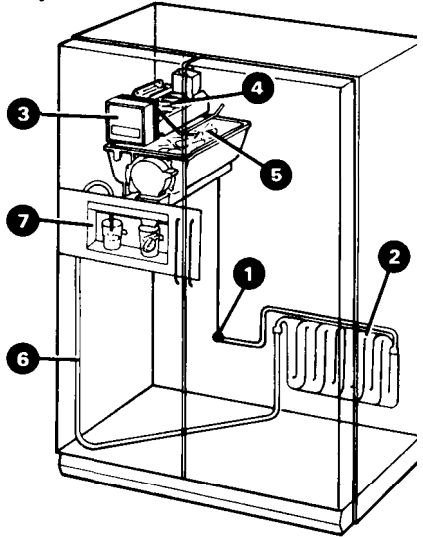

Water flows from the household supply through a

- (1) dual solenoid valve to the
- (2) water reservoir and to the
- (3) automatic icemaker as needed.

Water is frozen in the

- (4) cube mold and ejected into the
- (5) storage bin where a motor-powered auger moves cubes forward into the dispensing unit.

When you touch the CUBED pad on front of freezer compartment door, ice cubes will dispense through chute in door when cradle is pressed.

When you touch the CRUSHED pad, baffle in housing channels cubes through the crusher and crushed ice falls through chute into glass when cradle is pressed.

Chilled water from reservoir flows through the

- (6) tubing in the door and is dispensed when the cradle is pressed.
- (7) A **light switch** turns the night light in the dispenser on or off when the **LIGHT** pad is touched.

Important Facts about Your Ice & Water Dispenser

- **Your icemaker will produce eight cubes per cycle**—approximately 120 cubes in a 24-hour **period**—depending on freezer compartment temperature, room temperature, number of door openings and other use conditions.

- **Intermittent dispensing of ice is normal.** If ice flow interruption is more than brief, ice clump(s) may be the cause and should be removed following instructions below and on page 13.

- **Avoid overfilling glasses with ice and using narrow or extra-tall glasses.** This can jam the chute or cause the door in the chute to freeze shut. Periodically open the freezer compartment door and look down into the chute. If ice is blocking the chute, poke it through with a wooden spoon.

- **To help keep bits of ice from being sprayed beyond the glass,** place glass close to ice **chute**—but not so close that it blocks **outcoming** ice.

- **Ice should not be dispensed into thin glasses, fine china or delicate crystal**—they can crack or chip from the combined pressure of your hand pressing them against the cradle and ice dropping into the container.

- **Ice should be dispensed before filling glass with soda or other beverage mixes.** This will prevent splashing which is annoying and which, if the splash reaches the ice and water selector switch, could cause it to stick or bind.

- **Beverages and foods should not be quick-chilled in the ice storage bin.** Cans, bottles or food packages in the storage bin may cause the icemaker to malfunction.

- **Ice other than that produced by your icemaker should not be added to the ice storage bin—it may not crush or dispense well.**

Before Using Your Icemaker and Dispenser

If you use your refrigerator before the water connection is made, raise the ice access door and make sure the icemaker feeler arm is in the OFF (up) position as shown below.

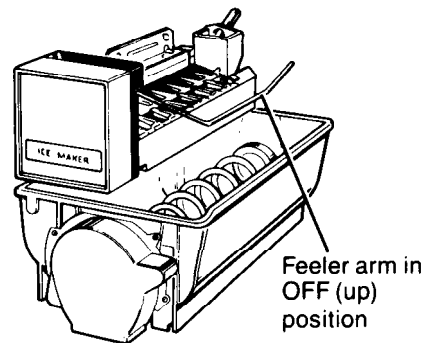
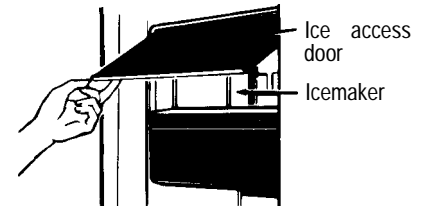

When water supply has been connected to icemaker, move feeler arm to ON (down) position.

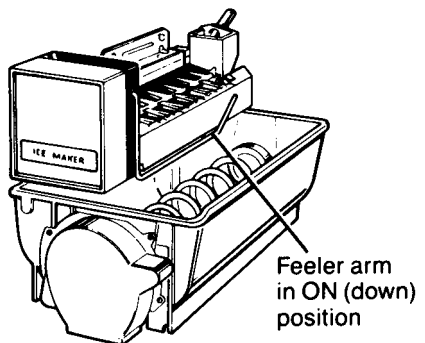

Depress water dispenser cradle for about two minutes to remove trapped air from water line and to fill water reservoir automatically.

Ice cube mold automatically fills with water after cooling to freezing temperatures. First cubes normally freeze after several hours.

NOTE: With a newly-installed refrigerator, allow about 24 hours for the freezer compartment to cool down to the proper icemaking temperature.

(continued next page)

Ice & Chilled Water Dispenser (continued)

Once Your Icemaker and Dispenser Are in Operation

Throw away the first few batches of ice cubes (16 or 24 cubes). This will flush away any impurities in the water line. Do the same thing after vacations or extended periods when ice isn't used.

Discard the first six glassfuls of water in the kitchen sink. This will eliminate the slight "plastic" taste temporarily imparted to the water by the water reservoir.

Keep ice level to keep icemaker productive. Cubes ejected into an empty storage bin will pile up close to the icemaker and push the feeler arm up to the OFF position prematurely when the bin is only partially full. Open the ice access door, reach in, level the cubes by hand and icemaking will resume. Keeping cubes distributed evenly will allow the icemaker to produce enough ice to fill the bin to its maximum capacity.

Caution:

Under certain rare circumstances, ice cubes may be discolored, usually appearing with a greenish hue. The cause of this unusual discoloration is apparently due to a combination of factors such as certain characteristics of local waters, household plumbing and the accumulation of copper salts in an inactive water supply line which feeds the icemaker. Continued consumption of such discolored ice cubes may be injurious to health. If such discoloration is observed, discard the ice cubes and contact your Hotpoint Factory Service Center or an authorized Customer Care® Servicer.

To Dispense Ice and Water

- For ice, touch CUBED or CRUSHED pad. For water, simply position glass beneath words CHILLED WATER.

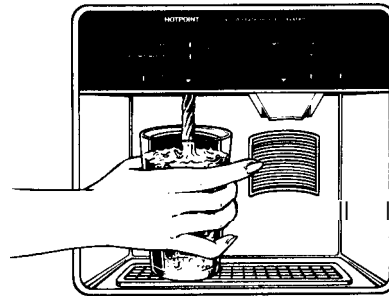
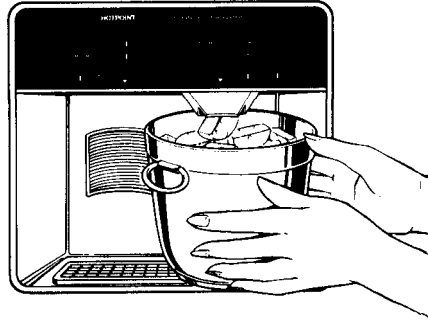

- Grip glass or other container gently near the rim and press rim firmly against ice or water dispenser cradle.

Caution:

Never put fingers or other objects into the ice crusher discharge opening.

When Dispensing Ice...

Some crushed ice may be dispensed even though you touched the CUBED pad. This happens occasionally when a few cubes inadvertently get diverted to the crusher.

Sometimes a mound of snow will form on the door in the ice chute. This condition is normal, and usually occurs when you have dispensed crushed ice repeatedly. The snow will eventually evaporate.

When Dispensing Water...

The water system provides approximately six successive 6-ounce glassfuls—after which several hours must be allowed for replenished water reservoir supply to cool. You probably will not drain all the chilled water from the reservoir on a single occasion.

The first glass of water dispensed may be warmer than the following ones. This is normal.

Dispensed water is chilled, not iced. For colder water, simply add ice before dispensing water.

To Stop Dispensing

Release pressure from cradle and withdraw slowly to catch last ice cubes or drops of water.

Some slight dripping may occur following dispensing of chilled water. If excessive, the spill should be wiped dry immediately.

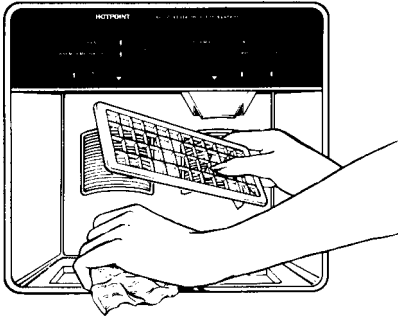

Do not pour water in spill shelf because it is not self-draining—pour it in kitchen sink. The shelf and its grille should be cleaned regularly according to instructions on page 18.

If Ice Clumps Form in Storage Bin...

The Icemaker ejects cubes in groups of eight, and it is normal for several cubes to be joined together. However, if you don't use the ice very often, ice clumps may form in the storage bin and can clog the dispenser.

If this happens:

- Remove storage bin from freezer compartment.
- Break up ice clumps with fingertip pressure and discard remaining clumps.
- Replace bin before remaining cubes melt and fuse together.

To Remove Ice Cube Storage Bin...

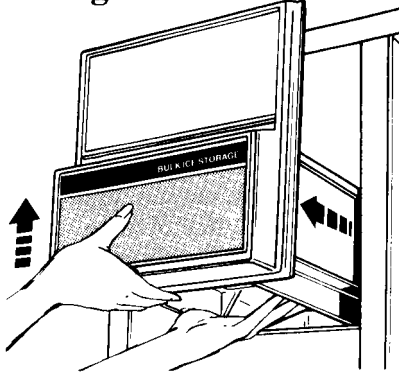

Lift the left corner to free the bin from the shelf, and pull the bin straight out while supporting it at front and back.

To Replace Ice Cube Storage Bin...

Slide the bin back until the tab on the bin locks into the slot in the shelf.

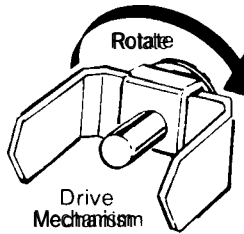

If bin does not go all the way back, remove it and rotate the drive mechanism 1/4 turn. Then push bin back again until the tab on the bin locks into the slot in the shelf.

If Ice Is Not Used Often...

Old ice cubes will become cloudy and taste stale. Empty ice storage bin periodically and wash it in lukewarm water. Be sure to allow storage bin to cool before replacing it—otherwise ice cubes will stick to the metal auger.

Move Icemaker Feeler Arm to OFF (up) Position when...

- Home water supply is to be turned off for several hours.
- Ice storage bin is to be removed for a period of time.
- Going away on vacation, at which time you should also turn off the valve in the water supply line to your refrigerator.

If This Is Your First Icemaker...

You'll hear occasional sounds that may be unfamiliar. These are normal icemaking sounds and are not cause for concern.

Water Filter Icemaker Accessory

Your ice cubes can only be as fresh-tasting as the water that produces them. That's why it's a good idea to purify your water with a water filter.

Its activated charcoal removes musty, stale odors and unpleasant medicinal, **metallic tastes**. A porous fiber cartridge catches dirt, rust particles, sand and silt, while special crystals reduce deposits of hard scale.

The filter is an option at extra cost, available from your **Hotpoint** dealer. Specify **WR97X0214**. It has complete installation instructions and installs in minutes on 1/4" O.D. copper water line.

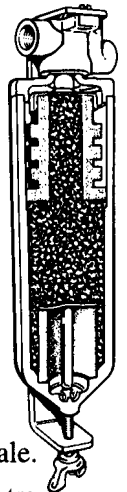

Food Storage Suggestions

Suggested storage times for meat and poultry*

Eating quality drops after time shown	DAYS IN REFRIGERATOR AT 35° to 40°F.		MONTHS IN FREEZER AT 0°F.
Fresh Meats			
Roasts (Beef & Lamb)	3to 5		6 to 12
Roasts (Pork & Veal) ...	3 to 5		4 to 8
Steaks (Beef)	3to5		6 to 12
Chops (Lamb)	3to5		6 to 9
Chops (Pork)	1 to 2		3 to 4
Ground & Stew Meats	1 to 2		3 to 4
Variety Meats.	1 to 2		3 to 4
Sausage (Pork) ..	1 to2		1 to 2
Processed Meats			
Bacon ...	7		1
Frankfurters. ..	7		1/2
Ham (Whole)	7		1 to 2
Ham (Half)	3to 5		1 to 2
Ham (Slices)	3		1 to 2
Luncheon Meats	3 to 5		Freezing not recommended.
Sausage (Smoked)	7		
Sausage (Dry & Semi-Dry)...	14 to 21		
Cooked Meats			
Cooked Meats and			
Meat Dishes ...	3to4		2 to 3
Gravy & Meat Broth	lto2		2 to 3
Fresh Poultry			
Chicken & Turkey (Whole)	1 to2		12
Chicken (Pieces)	lto2		9
Turkey (Pieces)...	1 to2		6
Duck & Goose (Whole),	lto2		6
Giblets	lto2		3
Cooked Poultry			
Pieces (Covered with Broth), ..	1 to2		6
Pieces (Not Covered)	3to4		1
Cooked Poultry Dishes.	3to4		4 to 6
Fried Chicken	3to4		4
(Other than for meats & poultry) FREEZER			
Most fruits and vegetables			8-12 months
Lean fish	6-B		months
Fatty fish, rolls and breads, soups, stew, casseroles.			2-3 months
Cakes, pies, sandwiches, leftovers (cooked),			
Ice cream (original carton). ...			1 month max.

New techniques are constantly being developed, Consult the College or County Extension Service or your local Utility Company for the latest information on freezing and storing foods,

● U.S. Department of Agriculture

Meats, fish and poultry purchased from the store vary in quality and age; consequently, safe storage time in your refrigerator will vary.

To store unfrozen meats, fish and poultry:

- Always remove store wrappings.
- Rewrap in foil, film or wax paper and refrigerate immediately.

To store cheese, wrap well with wax paper or aluminum foil, or put in a plastic bag.

- Carefully wrap to expel air and help prevent mold.
- Store pre-packaged cheese in its own wrapping if you wish.

To store vegetables, use the vegetable drawers—they've been designed to preserve the natural moisture and freshness of produce.

- Covering vegetables with a moist towel helps maintain crispness.
- As a further aid to freshness, pre-packaged vegetables can be stored in their original wrapping.

Note: The Sealed and Fresh drawer makes it unnecessary to wrap certain foods which it has been designed to preserve. This drawer is described on page 16.

To store ice cream—Fine-quality ice cream, with high cream content, will normally require slightly lower temperatures than more “airy” already-packaged brands with low cream content.

. It will be necessary to experiment to determine the freezer compartment location and temperature control setting to keep your ice cream at the right serving temperature.

- The rear of the freezer compartment is slightly colder than the front.

Tips on freezing foods

There are three essential requirements for efficient home freezing:

1. **Initial quality.** Freeze only top-quality foods. Freezing retains quality and flavor; it cannot improve quality.
2. **Speed.** The quicker fruits and vegetables are frozen after picking, the better the frozen product will be. You'll save time, too, with less culling and sorting to do.
3. **Proper packaging.** Use food wraps designed especially for freezing.

To freeze meat, fish and poultry, wrap well in freezer-weight foil (or other heavy-duty wrapping material) forming it carefully to the shape of the contents. This expels air. Fold and crimp ends of the package to provide a good, lasting seal.

Don't refreeze meat that has completely thawed; meat, whether raw or cooked, can be frozen successfully only once.

Limit freezing of fresh (unfrozen) meats or seafoods to 29 pounds at a time.

For convenience...

- Store all like things together. This not only saves time, but electricity—because you can find foods faster.
- Place the oldest items up front so they can be used up promptly.
- Use shelves on the door for most often used sauces and condiments.
- Use the meat drawer for meats you do not freeze.

To save money in energy and food costs:

- Place most perishable items, such as milk, cream or cottage cheese, toward the rear of the top shelf; they will stay coldest in this part of the fresh food compartment.
- Cover moist foods with tight lids, plastic film or foil.
- Leaf vegetables and fruits placed in storage drawers will last longer when stored in closed plastic containers or wrapped in plastic film.
- Do not overload your fresh food or freezer compartment with a lot of warm food at once.
- . Open the door the fewest times possible to save electrical energy.
- When going out of town for several days, leave as few perishables as possible in the refrigerator. Set the icemaker to the OFF position and shut off water to the refrigerator.

Shelves

Shelves in the fresh food and freezer compartments are adjustable, enabling you to make efficient shelf arrangements to fit your family's food storage needs.

Adjustable Shelves in Fresh Food Compartment

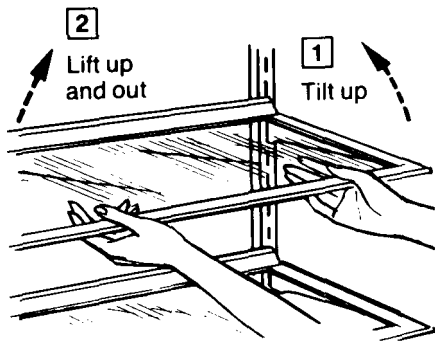

To remove shelves: Tilt shelf up at front, then lift it up and out of tracks on rear wall of refrigerator.

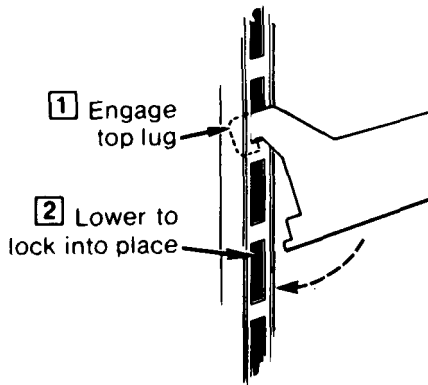

To replace shelves: Select desired shelf height. With shelf front raised slightly, engage top lugs in tracks at rear of cabinet. Then lower front of shelf until it locks into position.

Removable Bins on Fresh Food Compartment Door

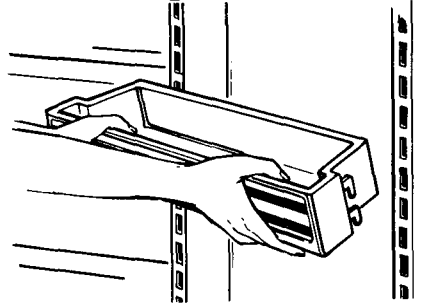

To remove bins: Lift bin straight up until mounting hooks disengage.

To relocate bins: Select desired bin height, engage hooks in slots on the tracks of the door, and push in. Bin will lock in place.

Removable Shelves in Freezer Compartment

Shelves in the freezer compartment are easily removed and replaced.

To remove shelves:

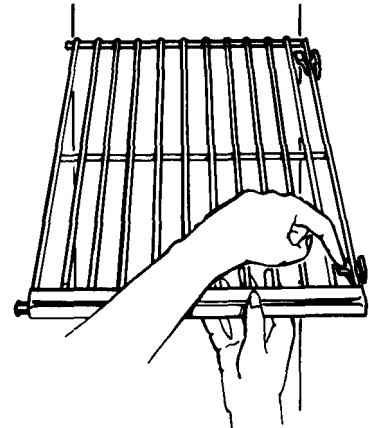

1. While pressing tabs on shelf supports on right wall, lift shelf out of grooves in supports.

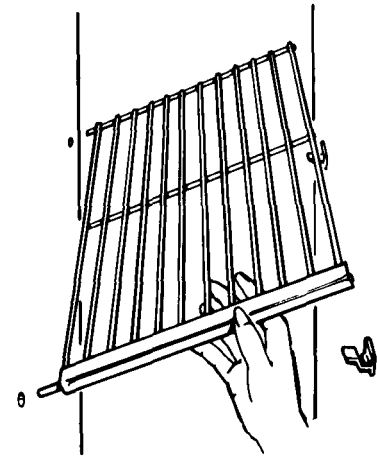

2. Pull shelf sideways until rods come out of holes on left wall.

To replace shelves: Insert rods into holes. Then, while pressing tabs, lower shelf into grooves in supports. Be sure shelf wire is fully inserted into grooves.

Storage Drawers

Convertible Meat Keeper

The Convertible Meat Pan drawer has its own cold air duct to allow a stream of cold air from the freezer compartment to flow around the drawer.

The variable temperature control regulates the air flow from the freezer compartment.

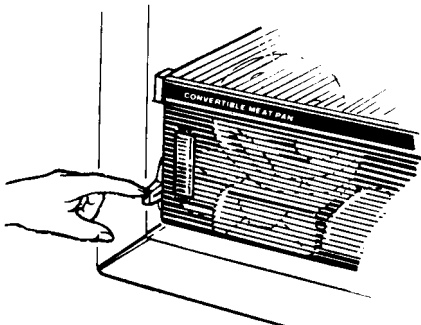

Set control lever to MEATS—the coldest setting—to store fresh meats. If lever is left in MEATS position for a long period of time, some frost may form on the inside of the drawer.

Set control lever to VEGETABLES to convert the drawer to normal refrigerator temperature and provide extra vegetable storage space. Cold air duct is turned off.

Variable settings between these extremes can be selected.

Sealed Snack Pan

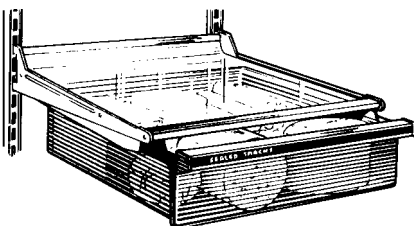

The Sealed Snack Pan-and shelf to which it is attached-can be relocated within the Fresh Food compartment. The sealed drawer retains high humidity for convenient storage of meats and cheese, bacon, hors d'oeuvres, spreads and snacks.

Sealed and fresh Drawer

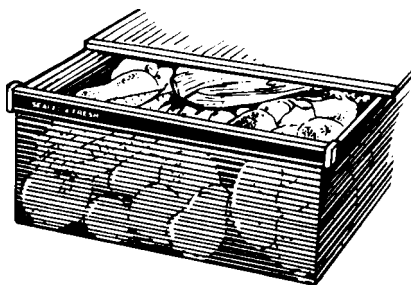

This refrigerated drawer is designed to keep unwrapped foods fresh by retaining the natural moisture content of foods such as:

- Artichokes
- Asparagus
- Beets, topped
- Blueberries
- Carrots
- Celery
- Cherries
- Corn
- Currants
- Greens, leafy
- Lettuce
- Parsley
- Peas, green
- Plums
- Radishes
- Rhubarb
- Spinach
- Tomatoes, ripe

As in any refrigerated storage area, it is recommended that odorous foods be stored wrapped—foods such as:

- Broccoli
- Brussels Sprouts
- Cabbage
- Cauliflower
- Green Onions
- Parsnips
- Turnips

Storage time will depend upon the type of food and its condition when placed in the drawer.

Excess water which may accumulate in the bottom of the Sealed and Fresh Drawer should be poured out and the drawer wiped dry.

The Sealed and Fresh Drawer is partially sealed by gaskets attached to the cover at the front and back edges. Always replace the drawer in this cover and push the drawer all the way in.

Serve and Store System

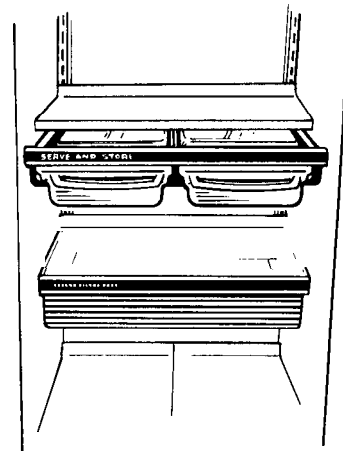

Cooking-serving-storage dishes with Lexan® polycarbonate resin see-through lids fit into a slide-out tray that, together with the shelf to which it attaches, can be located anywhere in the fresh food compartment.

Note: Reach in and support the rear of the tray with one hand when pulling the tray out past the second “stop” location. Otherwise the tray may slip out of your grasp and dishes may fall out of the tray.

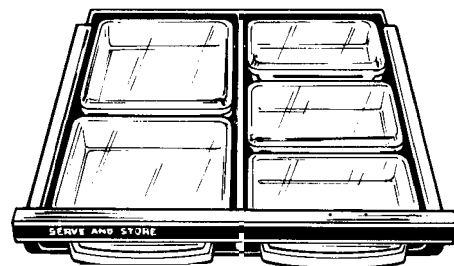

Dishes and lids are:

- safe for use in microwave ovens.
- safe for use in refrigerators and freezers.
- dishwasher safe.

Dishes only are safe for use in conventional ovens at temperatures up to 400°F.

CAUTION:

Dishes and lids are not designed for range top cooking or broiler use. Such use can be hazardous.

Lids cannot withstand the heat generated in conventional ovens.

To Remove Drawers

1. Remove food from the shelf above the Sealed and Fresh drawer and take out the shelf. Take food off the glass cover and out of the drawer.

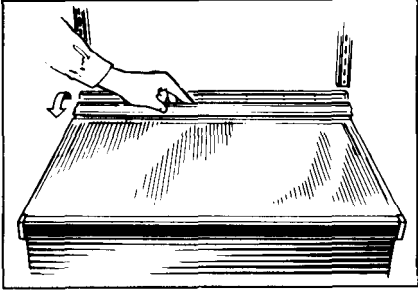

2. Put your fingers behind the gasket at the rear of the drawer and pull forward. Remove the gasket.

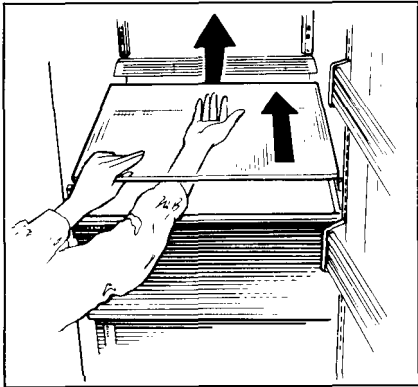

3. Pull the drawer partway out. Reach in, push the rear of the glass up; at the same time, push it back until it clears front-corner retainers.

4. Tilt and remove the cover.

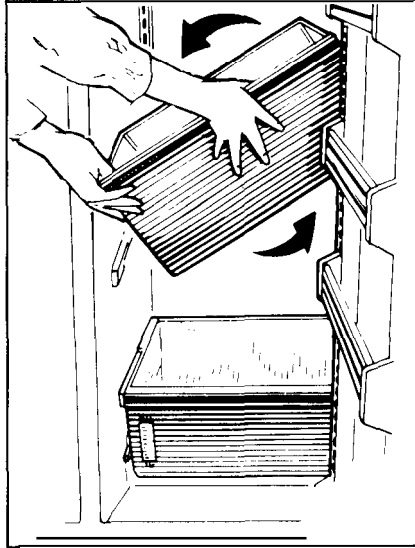

5. Pull the drawer forward. lift the front to clear stops, and remove the drawer. If the refrigerator door doesn't open completely, pull the drawer out until it hits the door. Then lift the drawer up until it is higher than the drawer supports, tilt it and take it out.

6. If tape holds Convertible Meat Pan cover to drawer supports, remove the tape. Pull drawer partway out. Reach in, push the rear of the glass up and, at the same time, back, until it clears front-corner retainers.

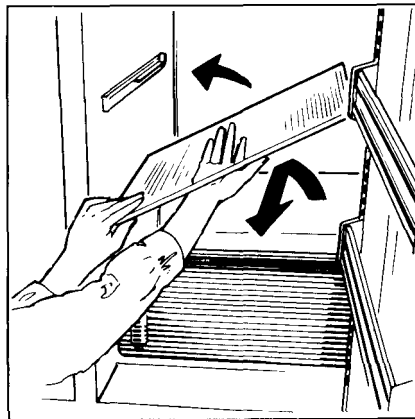

7. Tilt and remove the cover.

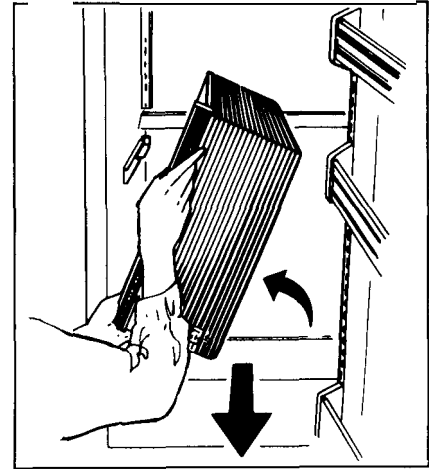

8. Tilt and remove the drawer.

After cleaning, replace in reverse order.

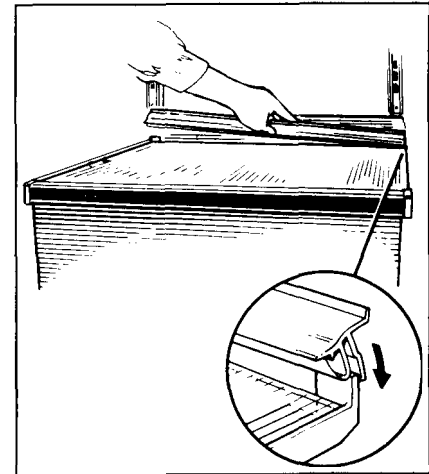

When drawers and covers are back in place, reinstall the gasket at the rear of the Sealed and Fresh drawer. Fit the end of the plastic drawer support into the slot on the gasket, with the rubber gasket flap facing you. Make sure the gasket snaps into place.

Care and Cleaning

Cleaning—Outside

Countermaker Compartment door—outside. It's important that you use only Windex brand window cleaner or a damp cloth to clean the glass and trim. Other glass cleaners may damage the trim. Avoid using wax on the Countermaker Compartment door.

Electronic monitor and diagnostic system panels. Clean the panels on the outside and inside of the freezer compartment door with a soft, clean cloth lightly dampened with water. Do not use cleaning sprays or large amounts of water—the liquid can run down and damage the control mechanisms.

The water and ice dispenser spill shelf should be wiped dry immediately to prevent spotting. Water left on the shelf may leave deposits that you can remove by soaking in undiluted vinegar. You can also use a paste of non-precipitating water softener (such as Calgon brand) and water, or one teaspoon of citric acid powder per pint of hot tap water. Soak until the deposit disappears or becomes loose enough to rinse away. Usually 30 minutes soaking time is adequate. Avoid using wax on the spill shelf and trim.

The door handles and trim can be cleaned with a cloth dampened with a solution of mild liquid dishwashing detergent and water. Dry with a soft cloth. Don't use wax on the door handles and trim.

Keep the finish clean. Wipe with a clean cloth lightly dampened with kitchen appliance wax or mild liquid dishwashing detergent. Dry and polish with a clean, soft cloth. Do not wipe the refrigerator with a soiled dishwashing cloth or wet towel. These may leave a residue that can damage the paint. Do not use scouring pads, powdered cleaners, bleach or cleaners containing bleach because these products can scratch and weaken the paint finish.

Protect the paint finish. The outside of the refrigerator has a high quality, baked-on paint finish. With proper care, it will stay new-looking and rust-free for years. Apply kitchen/appliance wax when the refrigerator is new and then at least twice a year.

Appliance Polish Wax & Cleaner (Cat. No. WR92X0216) is available from Hotpoint Appliance Parts Marts.

Cleaning—Inside

Countermaker Compartment door—inside. Wipe up spills right away. Use one tablespoon of baking soda in one quart of water to clean the inside door surface, refreshment center bin and inside access door. Rinse, wipe dry.

Inside the fresh food and freezer compartments should be cleaned at least once a year. Unplug the refrigerator before cleaning. If this is not practical, wring excess moisture out of sponge or cloth when cleaning around switches, lights or controls.

Use warm water and baking soda solution—about a tablespoon of baking soda to a quart of water. This both cleans and neutralizes odors. Rinse thoroughly with water and wipe dry.

Other parts of the refrigerator—including door gaskets, meat and vegetable drawers, ice storage bin and all plastic parts—can be cleaned the same way. Do not use cleansing powders or other abrasive cleaners.

To help prevent odors, leave an open box of baking soda in the rear of the refrigerator, on the top shelf. Change the box every three months. An open box of baking soda in the freezer will absorb stale freezer odors.

Do not wash any plastic parts from your refrigerator in your automatic dishwasher.

Serve and Store bowls and covers can be cleaned in an automatic dishwasher or by hand with liquid dishwashing detergent and water. You can remove stains by soaking them in a bleach-and-water solution—one part chlorine bleach to three parts water. (Stubborn stains may require two or more hours of soaking.) Use a plastic scouring pad to remove burned-on soil. Do not use cleansing powders or other abrasive cleaners.

Drain opening in freezer compartment. During yearly cleaning, remove bottom freezer basket and flush a solution of baking soda—one teaspoon and two cups of hot (not boiling) water—through the drain line with the help of a meat baster. This will help eliminate odor and reduce the likelihood of a clogged drain line.

If drain becomes clogged, use a meat baster and baking-soda-and-water solution to force the clog through the drain line.

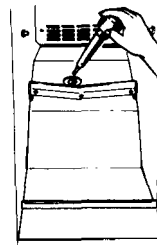

Behind Refrigerator

Care should be taken in moving your refrigerator away from the wall. All types of floor coverings can be damaged, particularly cushioned coverings and those with embossed surfaces. Pull the refrigerator straight out and return it to position by pushing it straight in. Moving your refrigerator in a side direction may result in damage to your floor covering or refrigerator.

Condenser

For most efficient operation, remove the base grille (see page 4) and either sweep away or vacuum up dust that is readily accessible.

For best results, use a brush specially designed for this purpose.

It is available at most appliance parts stores. This easy cleaning operation should be done at-least once a year.

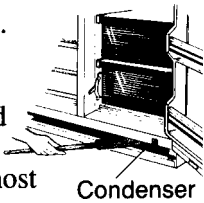

Light Bulb Replacement

In Fresh Food Compartment

1. Unplug refrigerator.
2. Turn numbered temperature control to OFF and pull off knob.

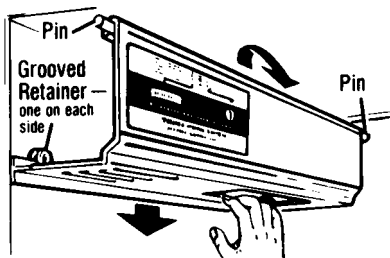

3. Pull bottom of light panel down about 1/4"—just enough to disengage lip at rear from grooves in retainers on rear wall.

4. Lift panel to disengage top from pins on side walls; remove panel.

After replacing with same size bulb, reinstall panel (hang top on pins; pull bottom down, push it back and release it to let lip engage

grooves in retainers). Replace temperature control knob in OFF position, turn it to previous setting, and plug refrigerator back in.

In Freezer Compartment

1. Unplug refrigerator.

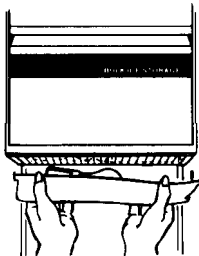

2. Remove shelf just below light shield. (Shelf will be easier to remove if it is emptied first.)
3. Pull plastic light shield toward you. (It will bend to free tabs from grooves.)

After replacing with same size bulb, reinstall shield and shelf and plug refrigerator back in.

In Countermaker Compartment

1. Unplug refrigerator.
2. Open fresh food compartment door, remove top door bin and raise Countermaker Compartment inner door.

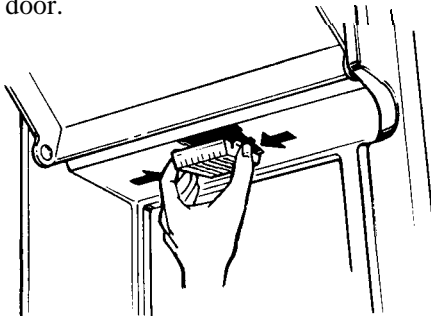

3. Press sides of flexible light shield to release locking tabs and allow the shield to swing down.
4. Unscrew burned-out bulb and replace it with night-light bulb of same wattage.
5. Place rear tab of light shield into door and rotate shield up until tabs lock into slots above.
6. Plug refrigerator back in.

When You Go on Vacation

For extended vacations or absences, shut off power to refrigerator, turn the numbered control to OFF, clean interior with baking soda solution of one tablespoon of baking soda to one quart of water. Wipe dry. To prevent odors, leave open box of baking soda in refrigerator. Leave doors open.

For shorter vacations, remove perishable foods and leave controls at regular settings. However, if room temperature is expected to drop below 60°F., follow same instructions as for extended vacations.

Move icemaker feeler arm to OFF (up) position and be sure to shut off water supply to the refrigerator.

When You Move

Disconnect power cord from wall outlet, remove all food and clean and dry the interior.

Secure all loose items such as grille, shelves and storage pans by taping them securely in place to prevent damage.

Be sure refrigerator stays in *upright position only* during actual moving and in van. Refrigerator must be secured in van to prevent movement. Protect outside of refrigerator with blanket.



Questions? Use This Problem Solver

PROBLEM	POSSIBLE CAUSE AND REMEDY
NO PANEL TOUCH PAD RESPONSE	<ul style="list-style-type: none">. If interior light is not on, refrigerator may not be plugged in at wall outlet.• If plug is secure and the refrigerator still fails to operate, plug a lamp or a small appliance into the same outlet to determine if there is a tripped circuit breaker or burned out fuse.
REFRIGERATOR DOES NOT OPERATE	<ul style="list-style-type: none">• Maybe in defrost cycle when motor does not operate for about 30 minutes.. Temperature control in OFF position.• If interior light is not on, refrigerator may not be plugged in at wall outlet.. If plug is secure and the refrigerator still fails to operate, plug a lamp or a small appliance into the same outlet to determine if there is a tripped circuit breaker or burned out fuse.
MOTOR OPERATES FOR LONG PERIODS	<ul style="list-style-type: none">• Modern refrigerators with more storage space and a larger freezer compartment require more operating time.. Normal when refrigerator is first delivered to your home—usually requires 24 hours to completely cool down.• Large amounts of food placed in refrigerator to be cooled or frozen.• Hot weather—frequent door openings.• Door left open.. Temperature controls are set too cold. Refer to instructions for use of TEMPERATURE CONTROLS on page 5.. Grille and condenser need cleaning. Refer to page 18.. Check ENERGY-SAVING TIPS on page 2.
MOTOR STARTS & STOPS FREQUENTLY	<ul style="list-style-type: none">• Temperature control starts and stops motor to maintain even temperatures.
VIBRATION OR RATTLING	<ul style="list-style-type: none">• If refrigerator vibrates, more than likely it is not resting solidly on the floor and front roller screws need adjusting or floor is weak or uneven. Refer to ROLLERS on page 4.. If dishes vibrate on shelves, try moving them. Slight vibration is normal.
HOT AIR FROM BOTTOM OF REFRIGERATOR	<ul style="list-style-type: none">. Normal air flow cooling motor. In the refrigeration process, it is normal that heat be expelled in the area under the refrigerator. Some floor coverings will discolor at these normal and safe operating temperatures. Your floor covering supplier should be consulted if you object to this discoloration.
DOOR NOT CLOSING PROPERLY	<ul style="list-style-type: none">. Door gasket on hinge side sticking or folding over. To correct, put a small amount of petroleum jelly on face of gasket.

PROBLEM	POSSIBLE CAUSE AND REMEDY
OPERATING SOUNDS	<ul style="list-style-type: none"> • The high speed compressor motor required to maintain near zero temperatures in the large freezer compartment may produce higher sound levels than your old refrigerator. • Normal fan airflow—one fan blows cold air through the refrigerator and freezer compartments, another fan cools the compressor motor. • These NORMAL sounds will also be heard from time to time: <ul style="list-style-type: none"> • Defrost timer switch clicks at defrost. • Defrost water dripping. • Temperature control clicks ON or OFF. • Refrigerant boiling or gurgling. • Cracking or popping of cooling coils caused by expansion and contraction during defrost and refrigeration following defrost. • With automatic icemaker, the sound of cubes dropping into the bin and water running in pipes as icemaker refills.
FRESH FOOD OR FREEZER COMPARTMENT TEMPERATURE TOO WARM	<ul style="list-style-type: none"> . Temperature control not set cold enough. Refer to TEMPERATURE CONTROLS on page 5. • Warm weather—frequent door openings. • Door left open for too long time. • Package may be holding door open.
FOODS DRY OUT	<ul style="list-style-type: none"> • Foods not covered, wrapped or sealed properly.
FROST OR ICE CRYSTALS ON FROZEN FOOD	<ul style="list-style-type: none"> . Door may have been left ajar or package holding door open. • Too frequent and too long door openings. • Frost within package is normal.
SLOW ICE CUBE FREEZING	<ul style="list-style-type: none"> . Door may have been left ajar. • Turn temperature of freezer compartment colder.
ICE CUBES HAVE ODOR/TASTE	<ul style="list-style-type: none"> • Old cubes need to be discarded. • Ice storage bin needs to be emptied or washed. • Unsealed packages in refrigerator and/or freezer compartments may be transmitting odor/taste to ice cubes. • Interior of refrigerator needs cleaning—refer to page 18. • Poor-tasting incoming water. Install a water filter-see page 13.
AUTOMATIC ICEMAKER DOES NOT WORK	<ul style="list-style-type: none"> • Icemaker feeler arm in OFF (up) position. . Water supply turned off or not connected. • Freezer compartment too warm. • Cubes too small—water shutoff valve connecting refrigerator to home water line may be clogged. • Sometimes cubes fuse to the side of the ice mold and hold the feeler arm in the OFF (up) position. Remove this ice to restart the icemaker. • When reaching for cubes by hand, you may have pushed the feeler arm into the OFF (up) position by mistake. • Piled up cubes in storage bin may cause icemaker to shut off prematurely. With icemaker feeler arm in OFF (up) position, level cubes in bin by hand.

(continued next page)

The Problem Solver (continued)

PROBLEM	POSSIBLE CAUSE AND REMEDY
CUBE DISPENSER DOES NOT WORK	<p>. No ice cubes. Remove storage container. If cubes are frozen to wire arm, remove cubes.</p> <ul style="list-style-type: none"> • No ice cubes. Icemaker turned off or water supply turned off. <p>. Irregular ice clumps in storage container. Breakup as many as you can with fingertip pressure and discard the remaining clumps.</p>
WATER HAS POOR TASTE/ODOR	<p>. If water dispenser has not been used for an extended period, dispense water in regular manner until all water in reservoir is replenished with freshwater.</p> <ul style="list-style-type: none"> • Poor-tasting incoming water. Install a water filter-see page 13.
WATER IN FIRST GLASS IS WARM	<ul style="list-style-type: none"> • Allow about 24 hours for water to cool to proper temperature after refrigerator is first installed. <p>. If water dispenser has not been used for extended period, water in first glass will not be as cool as in succeeding glasses.</p> <ul style="list-style-type: none"> • If water reservoir has been drained, allow several hours for replenished supply to chill.
WATER DISPENSER DOES NOT WORK	<ul style="list-style-type: none"> • Water supply line turned off or not connected. • Supply line maybe clogged with sediment.
DIVIDER BETWEEN FRESH FOOD AND FREEZER COMPARTMENTS FEELS WARM	<ul style="list-style-type: none"> • Normal warmth is created by automatic energy saver system circulating warm liquid around front edge of freezer compartment to help prevent condensation on outside of refrigerator in hot, humid weather.
MOISTURE FORMS ON OUTSIDE OF REFRIGERATOR	<ul style="list-style-type: none"> • Not unusual during period of high humidity.
MOISTURE COLLECTS INSIDE	<ul style="list-style-type: none"> • Too frequent and too long door openings. • In humid weather air carries moisture into refrigerator when doors are opened.
WATER ON KITCHEN FLOOR OR ON BOTTOM OF FREEZER	<p>. The drain in the bottom of the freezer may be clogged. Remove any ice on the freezer bottom and clean the drain. Refer to page 18.</p> <ul style="list-style-type: none"> • If you use a glass over 6 inches tall, you maybe jamming cubes in the funnel chute. They can fuse inside the chute and drop out later, leaving water or ice on the floor.
REFRIGERATOR HAS ODOR	<ul style="list-style-type: none"> • Foods with strong odors should be tightly covered. • Check for spoiled food. • Interior needs cleaning. Refer to page 18. • Keep open box of baking soda in refrigerator; replace monthly.
INTERIOR LIGHT DOES NOT LIGHT	<p>. No power at outlet.</p> <p>. Light bulb needs replacing. Seepage 19.</p>

If you need more help.. call, toll free:
GE Answer Center®
800.626.2000
consumer information service

If You Need Service

To obtain service, see your warranty on the back page of this book.

We're proud of our service and want you to be pleased. If for some reason you are not happy with the service you receive, here are three steps to follow for further help.

FIRST, contact the people who serviced your appliance. Explain why you are not pleased. In most cases, this will solve the problem.

NEXT, if you are still not pleased, write **all** the details—including your phone number—to:

Manager, Consumer Relations
Hotpoint
Appliance Park
Louisville, Kentucky 40225

FINALLY, if your problem is still not resolved, write:

Major Appliance
Consumer Action Panel
20 North **Wacker** Drive
Chicago, Illinois 60606

YOUR HOTPOINT REFRIGERATOR WARRANTY

Save proof of original purchase date such as your sales slip or cancelled check to establish warranty period.

WHAT IS COVERED

FULL ONE-YEAR WARRANTY

For one year from date of original purchase, we will provide, free of charge, parts and service labor in your home to repair or replace **any part of the refrigerator** that fails because of a manufacturing defect.

FULL FIVE-YEAR WARRANTY

For five years from date of original purchase, we will provide, free of charge, parts and service labor in your home to repair or replace **any part of the sealed refrigerating system** (the compressor, condenser, evaporator and all connecting tubing) that fails because of a manufacturing defect.

LIMITED LIFETIME WARRANTY

For the life of the refrigerator, we will replace, free of charge, **any tinted see-through storage drawer made from Lexan® polycarbonate resin** and furnished with the refrigerator if the drawer breaks during normal household use. Drawer covers are not included. The drawers can be exchanged at a Hotpoint Appliance Parts Mart, Factory Service Center, or by writing to the address below.

This warranty is extended to the original purchaser and any succeeding owner for products purchased for ordinary home use in the 48 mainland states, Hawaii and Washington, D.C. In Alaska the warranty is the same except that it is LIMITED because you must pay to ship the product to the service shop or for the service technician's travel costs to your home.

All warranty service will be provided by our Factory Service Centers or by our authorized Customer Care® servicers during normal working hours.

Look in the White or Yellow Pages of your telephone directory for HOTPOINT FACTORY SERVICE, GENERAL ELECTRIC-HOTPOINT FACTORY SERVICE or HOTPOINT CUSTOMER CARE® SERVICE.

WHAT IS NOT COVERED

• Service trips to your home to teach you how to use the product.

Read your Use and Care material.

If you then have any questions about operating the product, please contact your dealer or our Consumer Affairs office at the address below, or call, toll free:

GE Answer Center®
800.626.2000
consumer information service

• Improper installation.

If you have an installation problem, contact your dealer or installer. You are responsible for providing adequate electrical, plumbing and other connecting facilities.

• Replacement of house fuses or resetting of circuit breakers.

• Failure of the product if it is used for other than its intended purpose or used commercially.

• Damage to product caused by accident, fire, floods or acts of God.

WARRANTOR IS *NOT* RESPONSIBLE FOR CONSEQUENTIAL DAMAGES.

Some states do not allow the exclusion or limitation of incidental or consequential damages, so the above limitation or exclusion may not apply to you. This warranty gives you specific legal rights, and you may also have other rights which vary from state to state. To know what your legal rights are in your state, consult your local or state consumer affairs office or your state's Attorney General.

Warrantor: General Electric Company

If further help is needed concerning this warranty, write:
Manager—Consumer Affairs, GE Appliances, Appliance Park, Louisville, KY 40225

Part No. 162 D2533P005
Pub. No. 39-6277

HOTPOINT

CSX27C
CSXW27

Free Manuals Download Website

<http://myh66.com>

<http://usermanuals.us>

<http://www.somanuals.com>

<http://www.4manuals.cc>

<http://www.manual-lib.com>

<http://www.404manual.com>

<http://www.luxmanual.com>

<http://aubethermostatmanual.com>

Golf course search by state

<http://golfingnear.com>

Email search by domain

<http://emailbydomain.com>

Auto manuals search

<http://auto.somanuals.com>

TV manuals search

<http://tv.somanuals.com>