

OS 897D P /HP S
OS 897D P IX /HP S

GB

English

Operating Instructions

OVEN

Contents

Operating Instructions,	1
Warnings,	2
Description of the appliance,	3
Description of the appliance,	4
Installation,	5
Oven structure,	7
Start-up and use,	8
Precautions and tips,	14
Maintenance and care,	14
Afetr Sales Service,	17
Guarantee,	18

 **Hotpoint**

Warnings

WARNING: The appliance and its accessible parts become hot during use. Care should be taken to avoid touching heating elements. Children less than 8 years of age shall be kept away unless continuously supervised. This appliance can be used by children aged from 8 years and above and persons with reduced physical, sensory or mental capabilities or lack of experience and knowledge if they have been given supervision or instruction concerning use of the appliance in a safe way and understand the hazards involved. Children shall not play with the appliance. Cleaning and user maintenance shall not be made by children without supervision.

Do not use harsh abrasive cleaners or sharp metal scrapers to clean the oven door glass since they can scratch the surface, which may result in shattering of the glass.

“Before initiating the automatic cleaning cycle:

- clean the oven door;
- remove large or coarse food residues from the inside of the oven using a damp sponge. Do not use detergents;
- remove all accessories and the sliding rack kit (where present);
- do not place tea towels”

Keep children away from the appliance during the automatic cleaning cycle as surfaces may become very hot.

Never use steam cleaners or pressure cleaners on the appliance.

WARNING: Ensure that the appliance is switched off before replacing the lamp to avoid the possibility of electric shock.

! When you place the rack inside, make sure that the stop is directed upwards and in the back of the cavity.

Description of the appliance

Overall view

1. POSITION 1
2. POSITION 2
3. POSITION 3
4. POSITION 4
5. POSITION 5
6. DIVIDER "D" POSITION
7. POSITION 6
8. POSITION 7
9. GUIDES for the sliding racks
10. DRIPPING PAN
11. RACK shelf
12. DIVIDER shelf
13. Control panel

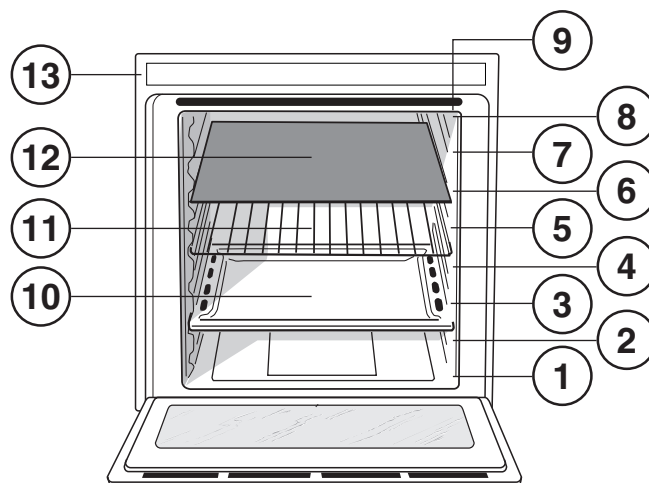

Description of the appliance

Control panel

1. **SMALL SPACE FUNCTION** knob
2. **DISPLAY**
3. **SET TIME** button
4. **EXTRALARGE SPACE FUNCTION** knob
5. **SET TEMPERATURE/TIMER** knob
6. **SELECT RECESS** button
7. **MAIN SPACE FUNCTION** knob

Display

8. **TEMPERATURE** and **TIME** digits
9. **DOOR LOCK** Indicator
10. **TIMER** Icon
11. **END OF COOKING** Icon
12. **DURATION** Icon
13. **RECESS SELECTED** icon

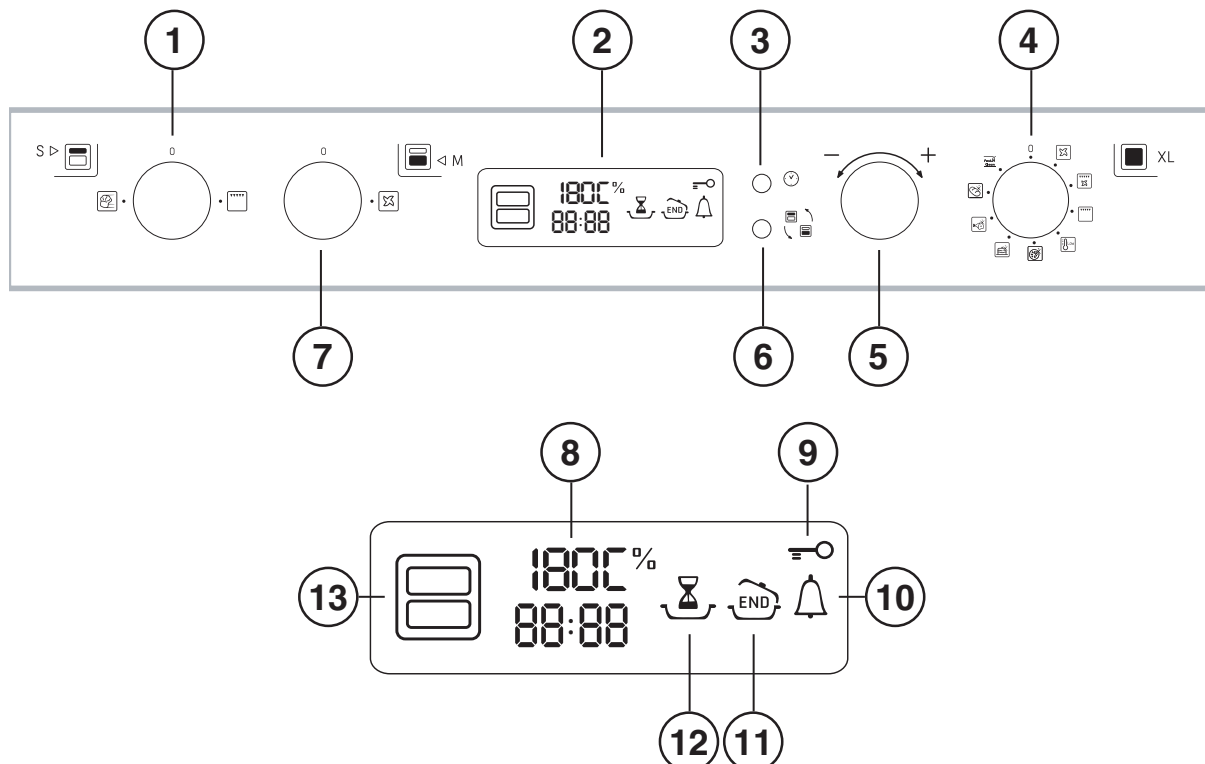

Installation

! Please keep this instruction booklet in a safe place for future reference. If the appliance is sold, given away or moved, please make sure the booklet is also passed on to the new owners so that they may benefit from the advice contained within it.

! Please read this instruction manual carefully: it contains important information concerning the safe operation, installation and maintenance of the appliance.

Positioning

! Do not let children play with the packaging material; it should be disposed of in accordance with local separated waste collection standards (see Precautions and tips).

! The appliance must be installed by a qualified professional in accordance with the instructions provided. Incorrect installation may damage property or cause harm to people or animals.

Built-in appliances

Use an appropriate cabinet to ensure that the appliance operates properly:

- The panels adjacent to the oven must be made of heat-resistant material.
- Cabinets with a veneer exterior must be assembled with glues which can withstand temperatures of up to 100°C.
- To install the oven **under the counter** (see diagram) or in a **kitchen unit**, the cabinet must have the following dimensions:

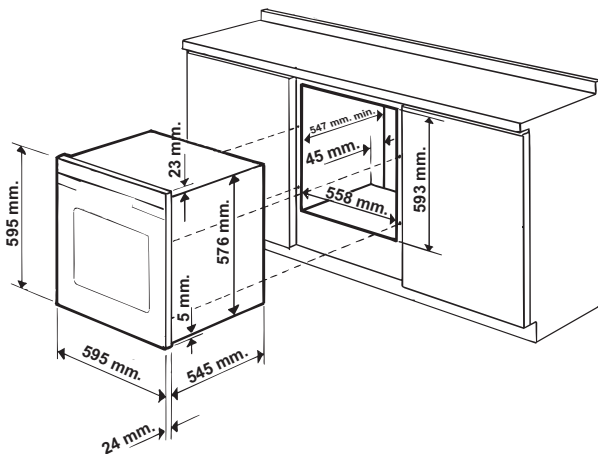

! The appliance must not come into contact with electrical parts once it has been installed. The indications for consumption given on the data plate have been calculated for this type of installation.

Ventilation

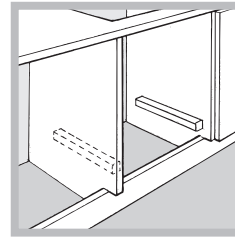

To ensure adequate ventilation, the back panel of the cabinet must be removed. It is advisable to install the oven so that it rests on two strips of wood, or on a completely flat surface with an opening of at least 45 x 560 mm (see diagrams).

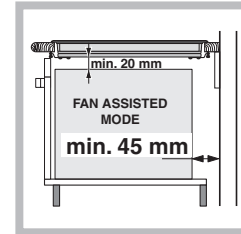
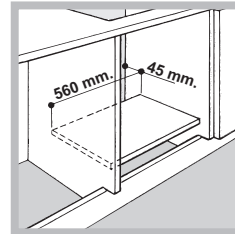

Centring and fixing

Position the 4 tabs on the side of the oven so that they are lined up with the 4 holes on the outer frame. Adjust the tabs according to the thickness of the cabinet side panel, as shown below:

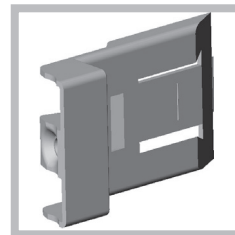

20 mm thick: take off the removable part of the tab (see diagram).;

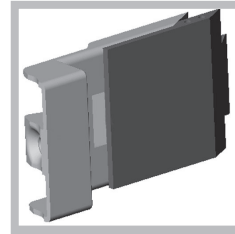

18 mm thick: use the first groove, which has already been set in the factory (see diagram).

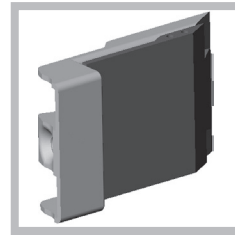

16 mm thick: use the second groove (see diagram).

Secure the appliance to the cabinet by opening the oven door and putting 4 screws into the 4 holes on the outer frame.

! All parts which ensure the safe operation of the appliance must not be removable without the aid of a tool.

Electrical connection

Ovens equipped with a three-pole power supply cable are designed to operate with alternating current at the voltage and frequency indicated on the data plate located on the appliance (see below).

Fitting the power supply cable

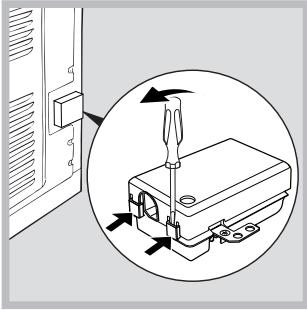

1. Open the terminal board by inserting a screwdriver into the side tabs of the cover. Use the screwdriver as a lever by pushing it down to open the cover (see diagram).

2. Install the power supply cable by loosening the cable clamp screw and the three wire contact screws L-N- \perp .

Connect the wires to the corresponding terminals: the Blue wire to the terminal marked (N), the Brown wire to the terminal marked (L) and the Yellow/Green wire to the terminal marked \perp (see diagram).

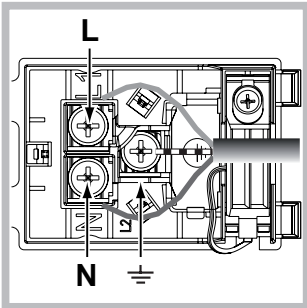

3. Secure the cable by fastening the clamp screw.
4. Close the cover of the terminal board.

Connecting the supply cable to the mains

Install a standardised plug corresponding to the load indicated on the data plate (see table).

The appliance must be directly connected to the mains using an omnipolar switch with a minimum contact opening of 3 mm installed between the appliance and the mains. The switch must be suitable for the charge indicated and must comply with current electrical regulations (the earthing wire must not be interrupted by the switch). The supply cable must be positioned so that it does not come into contact with temperatures higher than 50°C at any point (the back panel of the oven, for example).

! The installer must ensure that the correct electrical connection has been performed and that it is fully compliant with safety regulations.

Before connecting the appliance to the power supply, make sure that

- The appliance is earthed and the plug is compliant with the law.
- The socket can withstand the maximum power of the appliance, which is indicated on the data plate.
- The voltage is in the range between the values indicated on the data plate.
- The socket is compatible with the plug of the appliance. If the socket is incompatible with the plug, ask an authorised technician to replace it. Do not use extension cords or multiple sockets.



! Once the appliance has been installed, the power supply cable and the electrical socket must be easily accessible.

! The cable must not be bent or compressed.

! The cable must be checked regularly and replaced by authorised technicians only (see Assistance).

! The manufacturer declines any liability should these safety measures not be observed.

APPLIANCE SPECIFICATIONS

Dimension*	width 43.5 cm height 41 cm depth 41 cm
Volume*	74 l
Dimension**	width 45.6 cm height 41 cm depth 41 cm
Volume**	77 l
Electrical connections	voltage: 230 - 240 V~ 50Hz maximum power absorbed 3400-3600 W (see data plate)
ENERGY LABEL	Directive 2002/40/EC on the label of electric ovens. Standard EN 50304 Declared energy consumption for Forced convection Class – heating mode: Gratin 
 	This appliance conforms to the following European Economic Community directives: 2006/95/EEC dated 12/12/06 (Low Voltage) and subsequent amendments – 2004/108/EEC dated 15/12/04 and subsequent amendments – 93/68/EEC dated 22/07/93 and subsequent amendments – 2002/96/EC and subsequent amendments. 1275/2008 Standby/off mode

* Only for models with drawn rails.

** Only for models with wire rails.

Oven structure

The oven has a capacity of 70 litres and offers users the option of cooking on 4 shelves at the same time or cooking large quantities, which would not necessarily be possible in a traditional oven.

Thanks to the ExtraLarge Space, oven offers 10 cooking functions, 6 of which are universal (Creation) and suitable for any type of cooking, while the remaining 4 are automatic (Success) programmes which can be used to achieve perfect results for any recipe.

The oven also offers maximum comfort for all requirements, with 4 different operating options: the oven is one large compartment but can be divided into separate spaces of various sizes, each with its own independent temperature

and duration controls.

This is made possible thanks to the heat-insulating DIVIDER, which divides the whole ExtraLarge Space into two different-sized spaces: the Main Space and the Small Space.

The Main and Small Space compartments may be used at the same time to cook different dishes more quickly, or they may be used separately so that only the space necessary is used.

When the two compartments are used at the same time, the cooking temperature of each may be adjusted to a value between 50° and 250°. There may be a difference in temperature of 100° between the two zones, which means it is possible to cook very different dishes without any flavours or aromas intermingling.

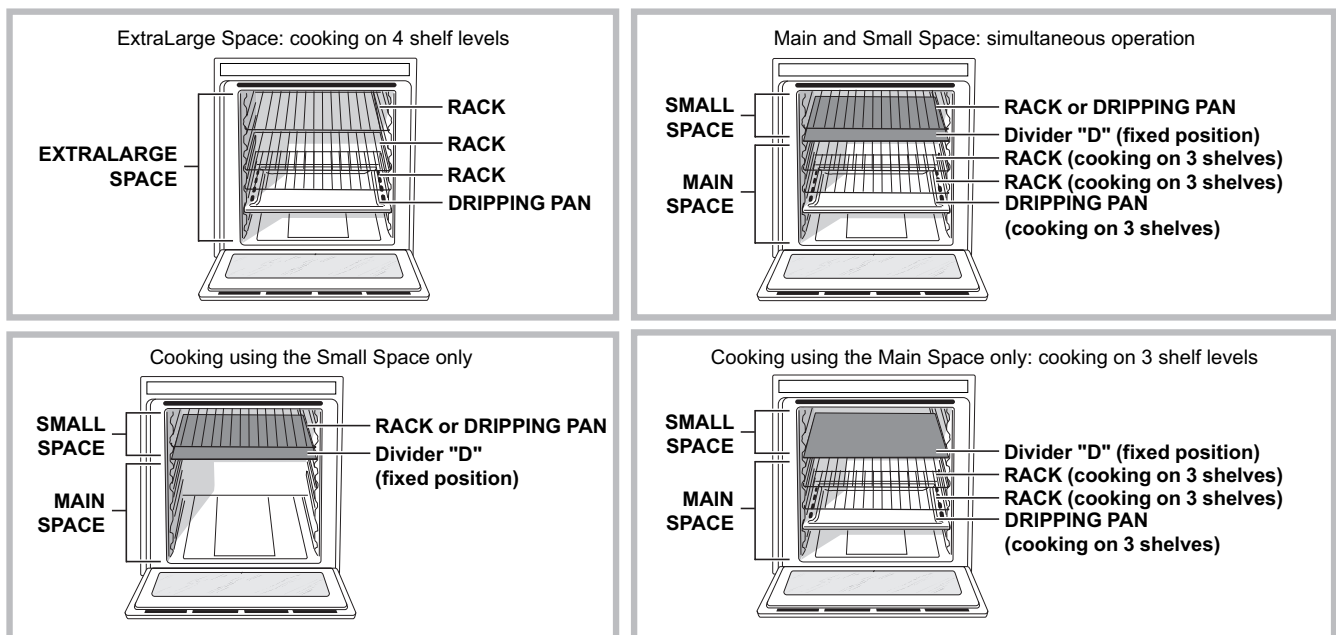

The table below lists the possible temperature values which may be set. The intelligent display will guide you through

the correct procedure used to adjust the temperature of the two cavities.

Temperature in the first cavity (Main or Small Space)	Temperature in the second cavity (Small or Main Space)
Between 40°C and 150°C	The temperature difference in relation to the first recess selected is no greater than 50°C <i>For example: if you set one recess to 90°C, you may set a value of between 40°C (90°C-50°C) and 140°C (90°C+50°C) for the other.</i>
Between 155°C and 200°C	The temperature difference in relation to the first recess selected is no greater than 70°C <i>For example: if you set one recess to 180°C, you may set a value of between 110°C (180°C-70°C) and 250°C (180°C+70°C) for the other.</i>
Between 205°C and 250°C	The temperature difference in relation to the first recess selected is no greater than 100°C <i>For example: if you set one recess to 210°C, you may set a value of between 110°C (210°C-100°C) and 250°C (maximum temperature setting) for the other.</i>

To cancel any of the settings, simply turn the Small Space or Main Space function knob to the “0” position.

Start-up and use

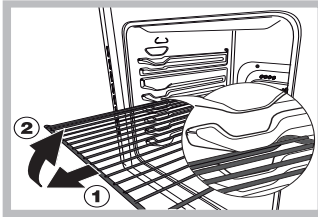

WARNING! The oven is provided with a stop system to extract the racks and prevent them from coming out of the oven (1).

As shown in the drawing, to extract them completely, simply lift the racks, holding

them on the front part, and pull (2).

! The first time you use your appliance, heat the empty oven with its door closed at its maximum temperature for at least half an hour. Make sure that the room is well ventilated before switching the oven off and opening the oven door. The appliance may emit a slightly unpleasant odour caused by protective substances used during the manufacturing process burning away.

! Never put objects directly on the bottom of the oven; this will prevent the enamel coating from being damaged.

! Always place cookware on the racks provided.

! During operation, we recommend the removal of any crockery or delicate foodstuffs from the cavities not being used.

! We recommend that you do not open the door when cooking foodstuffs which require proving, so as to not compromise cooking results.

! Once the cooking programme has begun, before the DIVIDER is removed, the oven must be switched off using the button.

! In order to optimise the cooking performance, when starting the selected function, product settings will be applied that could cause a delayed start of the fan and heating elements.

Cooling ventilation

In order to reduce the external temperature of the oven, a cooling fan generates a stream of air which escapes underneath the oven control panel.

! Once cooking has been completed, the cooling fan continues to operate until the oven has cooled down sufficiently.

Setting the clock

! This may only be set while the oven is switched off.

1. Press the button until the first numerical digit flashes on the DISPLAY and the , and icons are switched off.

2. Turn the SET TIME KNOB towards “+” and “-” to adjust the hour value.

3. Press the button again so that the other two numerical digits on the DISPLAY begin to flash.

4. Turn the SET TIME KNOB towards “+” and “-” to adjust the minute value.

5. Press the button again to confirm.

Setting the minute minder

! This function does not interrupt cooking and does not affect the oven; it is simply used to activate the buzzer when the set amount of time has elapsed.

1. Press the button until the icon and the three digits on the DISPLAY begin to flash.

2. Turn the SET TIME KNOB towards “+” and “-” to adjust

the minute value.

3. Press the button again to confirm.

The display will then show the time as it counts down. When this period of time has elapsed the buzzer will be activated.

ExtraLarge Space

! Do not use position “D” for racks.

Starting the oven

1. Select the desired cooking function by turning the EXTRALARGE SPACE FUNCTION knob. If the icon on the display is lit, this indicates that the ExtraLarge Space has been selected and therefore that only the settings corresponding to the ExtraLarge Space may be used.

2. The oven will begin its preheating stage. The temperature may be changed by turning the TEMPERATURE knob. The indicator light flashes during the preheating stage.

3. Once the preheating stage is completed, the icon stops flashing (becomes fixed) and a buzzer sounds. Food may now be placed in the oven.

4. During cooking it is always possible to:

- change the cooking function by turning the EXTRALARGE SPACE FUNCTION knob;

- adjust the temperature using the TEMPERATURE knob (for the Creation cooking functions only);

- set a duration (for Creation cooking functions only) and the cooking end time;

- stop cooking by turning the EXTRALARGE SPACE FUNCTION knob to the “0” position.

5. If a blackout occurs while the oven is already in operation, an automatic system within the appliance will reactivate the cooking function from the point at which it was interrupted, as long as the temperature has not dropped below a certain level. The clock and programmed cooking modes which have not yet started will not be restored and must be reprogrammed.

! When using the oven in its ExtraLarge configuration, it will not be possible to use the Main and Small Space features: the SMALL SPACE and MAIN SPACE FUNCTION knobs will be disabled.

!The oven will begin its preheating phase after 2 seconds from selecting the desired cycle.

Universal cooking functions

! All functions have a default cooking temperature which may be adjusted manually to a value between 40°C and 250°C as desired.

For the BARBECUE function, the default power level value is indicated as a percentage (%) and may also be adjusted manually.

MULTILEVEL function

All heating elements and the fan are activated. Since the heat remains constant throughout the oven, the air cooks and browns food in a uniform manner. A maximum of four racks may be used at the same time. If you are using several racks at the same time, we recommend you place the dripping pan on the lower rack. If you are cooking on 4 levels at the same

time, we recommend you place the shelves on racks 3, 5 and 6 and the dripping pan on rack 1.



GRATIN function

The top heating element are activated and the fan begins to operate. During part of the cycle the circular heating element is also activated. This combination of features increases the effectiveness of the unidirectional thermal radiation provided by the heating elements through the forced circulation of the air throughout the oven.

This helps prevent food from burning on the surface and allows the heat to penetrate right into the food. Always cook in this mode with the oven door closed.



BARBECUE function

The top heating element are activated. By turning the TEMPERATURE knob, the different power levels which may be set will appear on the display; these range between 5% and 100%. The high and direct temperature of the grill is recommended for food which requires a high surface temperature. Always cook in this mode with the oven door closed.



LOW TEMPERATURE function

This type of cooking can be used for proving, defrosting, preparing yoghurt, heating dishes at the required speed and slow cooking at low temperatures. The temperature options are: 40, 65 and 90 °C.



FAST CLEAN mode

This mode cleans the oven automatically and thoroughly by pyrolysis (see *Maintenance and care*).

! The default setting is 90 minutes.

Automatic cooking functions

! The **temperature** and **cooking duration** are **pre-set** values, guaranteeing a perfect result every time - automatically. These values are set using the **C.O.P.® (Programmed Optimal Cooking)** system. The cooking cycle stops automatically and the oven indicates when the dish is cooked. The cooking duration may be modified by a period of several minutes, as specified in the description of the individual functions below.



ROAST function

Use this function to cook veal, pork, lamb and beef. Place the food inside the oven while it is still cold. The dish may also be placed in a preheated oven. It will only be possible to adjust the duration by -10/+10 minutes.



BAKED CAKES function

This function is ideal for baking cakes. Place the food inside the oven while it is still cold. The dish may also be placed in a preheated oven. It will only be possible to adjust the duration by -10/+15 minutes.



BREAD function

Use this function to make bread. Please see the following chapter for the recipe and further details.

To achieve the best possible results, we recommend that you carefully observe the instructions below:

- Follow the recipe.
- **Remember to pour 150 g (150 ml) of cold water into the baking tray, which should be placed in position 7.**

Place the food inside the oven while it is still cold. If you wish to place the food in the oven after it has been preheated, immediately following a high-temperature cooking programme, the text "Hot" will appear on the display until the temperature of the oven has fallen to 40°. At this point it will be possible to place the bread in the oven.



PIZZA function

Use this function to make pizza. Please see the following chapter for further details. It will only be possible to adjust the duration by -5/+12 minutes.

To achieve the best possible results, we recommend that you carefully observe the instructions below:

- Follow the recipe.
- The weight of the dough should be between 350 g and 500 g.
- Lightly grease the dripping pan and the baking trays.

Place the food inside the oven while it is still cold. If you wish to place the food in the oven after it has been preheated, immediately following a high-temperature cooking programme, the text "Hot" will appear on the display until the temperature of the oven has fallen to 120°. At this point it will be possible to place the pizza in the oven.

Recipe for PIZZA:

Makes 3 or 4 pizzas: 1000 g flour, 500 ml water, 20 g salt, 20 g sugar, 100 ml olive oil, 20 g fresh yeast (or 2 sachets of powder yeast)

- Leavening at room temperature: 1 hour, or LOW TEMPERATURE manual function set to 40°. Leave to rise for approximately 30-45 minutes.
- Place the food inside the oven while it is still cold.
- Start the  PIZZA cooking mode.

Recipe for BREAD (maximum amount of dough):

Ingredients:

- 1.3 kg flour
- 700 g water
- 25 g salt
- 50 g fresh baker's yeast or 4 sachets dried yeast powder.

Method:

- Mix the flour and salt in a large bowl.
- Dilute the yeast in lukewarm water (approximately 35 degrees).
- Make a small well in the mound of flour.
- Pour in the water and yeast mixture.
- Knead the dough by stretching and folding it over itself with the palm of your hand for 10 minutes, until it has a uniform consistency and is not too sticky.
- Form the dough into a ball shape, place it in a large bowl and cover it with transparent plastic wrap to prevent the surface of the dough from drying out. Place the bowl in

the oven, set to 40° using the LOW TEMPERATURE manual function, and leave to rise for approximately 30–45 minutes. Alternatively, leave at room temperature for approximately 1 hour (until the dough has doubled in volume).

- Break up the dough, kneading gently, and divide it to create several loaves.
- Place them on a sheet of baking paper (cut to the same size as the inside of the dripping pan) on top of the rack (or on 2 or 3 racks if you wish to cook the loaves on different shelves) and dust them lightly with flour.
- Make a few incisions in the top using a sharp blade.
- Place the rack in the oven, on shelf level 2 if using only one level, or place two racks on shelf levels 1 and 4 if using two levels, or place three racks on shelf levels 1, 3 and 5 if using three levels.
- **Place the dripping pan on shelf level 7 and pour in 150 g cold water.**
- Place the food inside the oven while it is still cold.
- Start the automatic function  BREAD.
- When the cooking process has finished, leave the loaves to rest on the rack until they have completely cooled.

Small Space

Starting the oven

1. Fit the DIVIDER to the DIVIDER shelf “D” using the pin, with the arrows turned towards the rear part of the oven. A buzzer will sound to confirm that the DIVIDER has been fitted correctly; it will then be possible to use the two Main and Small Space compartments separately or at the same time.

! The EXTRALARGE SPACE FUNCTION knob will be disabled.

2. Select the desired cooking function by turning the SMALL SPACE FUNCTION knob.

3. The oven will begin its preheating stage. The temperature may be changed by turning the TEMPERATURE knob. The  indicator light flashes during the preheating stage.

4. Once the preheating stage is completed, the  icon stops flashing (becomes fixed) and a buzzer sounds. Food may now be placed inside the oven.

5. During cooking it is always possible to:

- change the cooking function by turning the SMALL SPACE FUNCTION knob;
- change the temperature by turning the TEMPERATURE knob;
- set the cooking duration and the cooking end time;
- stop cooking by turning the SMALL SPACE FUNCTION knob to the “0” position.

6. If a blackout occurs while the oven is already in operation, an automatic system within the appliance will reactivate the cooking function from the point at which it was interrupted, as long as the temperature has not dropped below a certain level. The clock and programmed cooking modes which have not yet started will not be restored and must be reprogrammed.

Cooking functions

GRILL function

The top heating element comes on. By turning the TEMPERATURE knob, the different power levels which may be set will appear on the display; these range between 5% and 100%. The high and direct temperature of the grill is recommended for food which requires a high surface temperature. This function is particularly suitable for browning food, cooking gratins, colouring meringues, making toasted sandwiches and grilling small quantities of thin, lean meat. Always cook in this mode with the oven door closed.

FAST COOKING function

This function requires the oven to be preheated. This function is particularly suitable for cooking pre-packed food quickly (frozen or pre-cooked).

Main Space

Starting the oven

1. Fit the DIVIDER to the DIVIDER shelf “D” using the pin, with the arrows turned towards the rear part of the oven. A buzzer will sound to confirm that the DIVIDER has been fitted correctly; it will then be possible to use the two Main and Small Space compartments separately or at the same time.

! The EXTRALARGE SPACE FUNCTION knob will be disabled.

2. Select the desired cooking function by turning the MAIN SPACE FUNCTION knob.

3. The oven will begin its preheating stage. The temperature may be changed by turning the TEMPERATURE knob. The  indicator light flashes during the preheating stage.

4. Once the preheating stage is completed, the  icon stops flashing (becomes fixed) and a buzzer sounds. Food may now be placed inside the oven.

5. During cooking it is always possible to:

- change the temperature by turning the TEMPERATURE knob;
- set the cooking duration and the cooking end time;
- stop cooking by turning the MAIN SPACE FUNCTION knob to the “0” position.

6. If a blackout occurs while the oven is already in operation, an automatic system within the appliance will reactivate the cooking function from the point at which it was interrupted, as long as the temperature has not dropped below a certain level. Programmed cooking modes which have not yet started will not be restored and must be reprogrammed.

Cooking functions

UNIVERSAL function

All heating elements and the fan are activated. Since the heat remains constant throughout the oven, the air cooks and browns food in a uniform manner. A maximum of three racks may be used at the same time.

If you are using several racks at the same time, we

recommend you place the dripping pan on shelf level 1. If you are cooking on 3 levels at the same time, we recommend you place the shelves on racks 3 and 5, and the dripping pan on rack 1.

Using the Small Space and Main Space at the same time

! Simultaneous operation is only possible when using the Creation functions



Starting the oven

1. Fit the DIVIDER to the DIVIDER shelf "D" using the pin, with the arrows turned towards the rear part of the oven. A buzzer will sound to confirm that the DIVIDER has been fitted correctly; it will then be possible to use the two Main and Small Space compartments separately or at the same time.

! The EXTRALARGE SPACE FUNCTION knob will be disabled.

! In order to improve the energy efficiency of the oven, the preheating time of the SMALL SPACE cavity lasts about 15 minutes.

! If the MAIN SPACE is set to a temperature below 175°C, in order to safeguard the cooking results, the grill function will not start: the text "OFF" will appear on the display.

2. Select the desired cooking function for each cavity by turning the SMALL SPACE FUNCTION and/or MAIN SPACE FUNCTION knobs. The  icon indicates that the Small Space has been selected and that it is therefore possible to adjust the Small Space settings; the  icon lit up on the display indicates that the Main Space has been selected and that it is therefore possible to adjust the Main Space settings.

3. Both ovens will begin the preheating stage. The temperature may be changed by turning the TEMPERATURE knob. The  indicator light flashes during the preheating stage.

4. Once the preheating stage is completed, the  icon stops flashing (becomes fixed) and a buzzer sounds. Food may now be placed inside the oven.

5. The digits on the display become brighter to indicate which cavity you are adjusting. To modify the settings for the other

cavity, press the  button. The Small Space and Main Space settings may actually be changed during simultaneous cooking:



- change the cooking function by turning the SMALL SPACE FUNCTION and/or MAIN SPACE FUNCTION knob;
 - change the temperature by turning the TEMPERATURE knob;
 - set the cooking duration and the cooking end time;
 - stop cooking by turning the SMALL SPACE FUNCTION and/or MAIN SPACE FUNCTION knob to the "0" position.
6. If a blackout occurs while the oven is already in operation, an automatic system within the appliance will reactivate the cooking function from the point at which it was interrupted, as long as the temperature has not dropped below a certain level. The clock and programmed cooking modes which have not yet started will not be restored and must be reprogrammed.

Programming cooking

! A cooking function must be selected before programming can take place.







Programming is possible in all oven configurations: EXTRALARGE, MAIN and SMALL SPACE, even if the latter two are being used simultaneously.

Programming the cooking duration

1. Press the  button several times until the  icon and the three numerical digits on the DISPLAY begin to flash.
2. Turn the SET TIME KNOB towards "+" and "-" to adjust the duration.
3. Press the  button again to confirm.
4. When the set time has elapsed, the text END appears on the DISPLAY, the oven will stop cooking and a buzzer sounds.
 - For example: it is 9:00 a.m. and a duration of 1 hour and 15 minutes is programmed. The function will stop automatically at 10:15 a.m.

Setting the end time for a cooking mode

! A cooking duration must be set before the cooking end time can be scheduled.

1. Follow steps 1 to 3 to set the duration as detailed above.
2. Next, press the  button until the  icon and the two digits on the DISPLAY begin to flash.
3. Turn the SET TIME KNOB towards "+" and "-" to adjust the hour value.
4. Press the  button again so that the other two numerical digits on the DISPLAY begin to flash.
5. Turn the SET TIME KNOB towards "+" and "-" to adjust the minute value.
6. Press the  button again to confirm.
7. When the set time has elapsed, the text END appears on the DISPLAY, the oven will stop cooking and a buzzer sounds. Programming has been completed when the  and  icons light up. The DISPLAY shows the cooking end time and the cooking duration alternately. To cancel programming, turn the FUNCTION knob to the "0" position.

Practical cooking advice

MULTILEVEL

- Use positions 1, 3, 5 and 6.
- Place the dripping pan at the bottom and the rack at the top.

BARBECUE

- Preheat the oven for 5 minutes.
- Keep the oven door closed when cooking in this mode.
- Place the dripping pan on shelf level 3. Place the rack in a position between 4 and 7, depending on how bulky the food is, and make sure the food is in the centre of the rack. Examples: beef ribs should be cooked on shelf level 4 and bacon on shelf level 6 or 7.

PIZZA or FOCACCIA

- Use a light aluminium tray with a maximum diameter of 30 cm, placing it on top of the rack supplied.
- If the pizza has a lot of toppings, we recommend adding the mozzarella cheese on top of the pizza halfway through the cooking process.

FAST COOKING

- Preheat the oven, making sure the dripping pan is on shelf level 6.
- When cooking frozen foods, always follow the instructions on the packaging.

GRILL

- Preheat the oven for 5 minutes.
- Fit the DIVIDER to the DIVIDER rack "D".
- Keep the oven door closed when cooking in this mode.
- Place the rack in position 7. Position the food in the centre of the rack. Position the dripping pan on shelf level 6.
- This function is particularly suitable for browning food, cooking gratins, colouring meringues, making toasted sandwiches and grilling small quantities of thin, lean meat.
- We recommend that the power level is set to maximum. The top heating element is regulated by a thermostat and may not always operate constantly.

Cooking advice table for ovens with an ExtraLarge Space cavity

Function	Foods	Weight (in kg)	Cook on no. of shelves	Rack position			Preheating	Recommended temperature (°C)	Cooking duration (minutes)	
				No.	Dripping pan	Rack 1				Rack 2
Multilevel*	Pies / Tarts		1	2 or 3				Yes	180	30-40
			2	1 to 2	3 to 5			Yes	180	35-45
			3	1	3	5		Yes	180	40-50
			4	1	3	5	6	Yes	180	45-55
	Cream puffs		1	2 or 3				Yes	190	25-35
			2	1 to 2	3 to 5			Yes	190	25-35
			3	1	3	5		Yes	190	30-40
			4	1	3	5	6	Yes	190	30-40
	Pizza		1	2 or 3				Yes	220	15-25
			2	1 to 2	3 to 5			Yes	220	20-30
			3	1	3	5		Yes	220	25-35
			4	1	3	5	6	Yes	220	30-40
	Biscuits		1	2 or 3				Yes	180	15-25
			2	1 to 2	3 to 5			Yes	180	15-25
		3	1	3	5		Yes	180	20-30	
		4	1	3	5	6	Yes	180	20-30	
Pastries		1	2 or 3				Yes	200	30-40	
		2	2	5			Yes	200	35-45	
		3	1	4	6		Yes	200	40-50	
Crème caramel (bain-marie)		1	2 or 3				Yes	170	35-45	
		2	2	5			Yes	170	35-45	
		3	1	4	6		Yes	170	40-50	
Panettone		1	1 or 2				Yes	160	45-60	
Sponge cake made with yoghurt		1	2 or 3				Yes	160	60-75	
		2	1	4 or 5			Yes	160	60-75	
Sponge cake		1	2 or 3				Yes	190	30-35	
		2	2	5			Yes	190	35-40	
		3	1	4	6		Yes	190	40-45	
Large cut of meat		1	1	2			Yes	160	90-240	
Gratin*	Rotisserie		1	2	3			No	200	35-75
	Gratin		1	3 or 4				No	190	40-60
	Large roast		1	1	2			No	200	90-120
	Large roast game		1	1	2			No	200	90-120
Barbecue*	Beef ribs		1	3	4 or 5			Yes	100%	20-30
	Sausages		1	3	5 to 7			Yes	100%	10-20
	Pork ribs		1	3	5 to 7			Yes	100%	15-25
	Bacon		1	3	5 to 7			Yes	100%	3-6
Low temperature	Proving / Defrosting		1	2				No	40	
	White meringues		4	1	3	5	6	No	65	8-12 hours**
	Meat / Fish		3	1	3	5		No	90	90-180**
Automatic bread	Bread (see recipe)		2	1	7***	2		No		
			2	2	7***	1	4	No		
			3	3	7***	1	3	5	No	
Automatic roast	Roasts		1	2	3			No		60-90**
Automatic baked cakes	Desserts		1	2				No		35-60**
			2	2	5			No		35-60**
Automatic pizza	Pizza (see recipe)		1	2				No		23-30**
			2	2	5			No		25-35**
			3	1	3	5		No		30-35**
			4	1	3	5	6	No		35-40**

* The cooking times listed above are intended as guidelines only and may be modified according to personal tastes. Oven preheating times are set as standard and may not be modified manually.

** The duration of the automatic cooking functions are set by default. The values in the table refer to the minimum and maximum duration, which may be modified by the user, taking the default value as a starting point.

*** As stated in the recipe, pour 150 g water into the dripping pan.

Cooking advice table for the Small Space feature

Function	Foods	Weight (in kg)	Cook on no. of shelves No.	Rack position			Preheating	Recommended temperature (°C)	Cooking duration (minutes)
				Dripping pan	Rack 1	Divider			
Fast cooking*	Fish fillets		1	6		D	Yes	180-200	20-30
	Meat fillets		1	6		D	Yes	180-200	30-40
	Frozen pizza		1	6		D	Yes		
	Frozen prepared foods		1	6		D	Yes		
Grill	Toast		1	-	6-7	D	Yes	100%	3-5
	Bacon		1	6	7	D	Yes	100%	3-6
	Pork steaks		1	6	7	D	Yes	100%	15-25

* The cooking times listed above are intended as guidelines only and may be modified in accordance with personal tastes. Oven preheating times are set as standard and may not be modified manually.

Cooking advice table for the Main Space feature

Function	Foods	Weight (in kg)	Cook on no. of shelves No.	Rack position			Preheating	Recommended temperature (°C)	Cooking duration (minutes)
				Dripping pan	Rack 1	Divider			
Universal*	Pies / Tarts		1	2		D	Yes	200	30-40
			2	1	3	D	Yes	200	35-45
	Cream puffs		1	2		D	Yes	190	25-35
			2	1	3	D	Yes	190	25-35
	Pizza		1	2		D	Yes	220	15-25
			2	1	3	D	Yes	220	20-30
	Biscuits		1	2		D	Yes	180	15-25
			2	1	3	D	Yes	180	15-25
	Pastries		1	2		D	Yes	200	30-40
			2	1	3	D	Yes	200	35-45
Crème caramel (bain-marie)		1	2		D	Yes	170	35-45	
Sponge cake made with yoghurt		1	2		D	Yes	160	60-75	
Sponge cake		1	2		D	Yes	190	30-35	
		2	1	3	D	Yes	190	35-40	
Small roasting joints		1	2	3	D	Yes	210	30-60	

* The cooking times listed above are intended as guidelines only and may be modified in accordance with personal tastes. Oven preheating times are set as standard and may not be modified manually.

Cooking advice table for using the Small Space and Main Space at the same time

Small Space

Function	Foods	Weight (in kg)	Cook on no. of shelves No.	Rack position			Preheating	Recommended temperature (°C)	Cooking duration (minutes)
				Dripping pan	Rack 1	Divider			
Fast cooking*	Fish fillets		1	6		D	Yes	200-220	20-30
	Meat fillets		1	6		D	Yes	200-220	30-40
	Frozen pizza		1	6-7		D	Yes		
	Frozen prepared foods		1	6-7		D	Yes		
	"Pilaf" rice		1	6		D	Yes	180-200	30-45
Grill	Browning		1	6-7		D	Yes	100%	3-6

Main Space

Function	Foods	Weight (in kg)	Cook on no. of shelves No.	Rack position			Preheating	Recommended temperature (°C)	Cooking duration (minutes)
				Dripping pan	Rack 1	Divider			
Universal*	Cakes, pies / tarts		1	2		D	Yes	200	30-40
			2	1 and 2	3 to 5	D	Yes	200	35-45
	Biscuits		1	2		D	Yes	180	15-25
			2	1 and 2	3 to 5	D	Yes	180	15-25
	Crème caramel (bain-marie)		1	2		D	Yes	160	45
	Pizza		1	2		D	Yes	220	15-25
			2	1 and 2	3 to 5	D	Yes	220	20-30
	Potato gratin		1	2		D	Yes	200	60
	Roasting joint		1	2		D	Yes	200	60-90
	Dishes with pastry crust		1	2		D	Yes	200	35-45

* The cooking times listed above are intended as guidelines only and may be modified in accordance with personal tastes. Oven preheating times are set as standard and may not be modified manually.

Precautions and tips

! This appliance has been designed and manufactured in compliance with international safety standards. The following warnings are provided for safety reasons and must be read carefully.

General safety

- The appliance was designed for domestic use inside the home and is not intended for commercial or industrial use.
- The appliance must not be installed outdoors, even in covered areas. It is extremely dangerous to leave the appliance exposed to rain and storms.
- When moving or positioning the appliance, always use the handles provided on the sides of the oven.
- Do not touch the appliance while barefoot or with wet or damp hands and feet.
- **The appliance must be used by adults only for the preparation of food, in accordance with the instructions provided in this booklet. Any other use of the appliance (e.g. for heating the room) constitutes improper use and is dangerous. The manufacturer may not be held responsible for any damage caused as a result of improper, incorrect and unreasonable use of the appliance.**
- **Do not touch the heating elements or certain parts of the oven door when the appliance is in use; these parts become extremely hot. Keep children well away from the appliance.**
- Make sure that the power supply cables of other electrical appliances do not come into contact with the hot parts of the oven.
- The ventilation and heat dispersal openings must never be obstructed.
- Always grip the oven door handle in the centre: the ends may be hot.
- Always use oven gloves when placing cookware in the oven or when removing it.
- Do not use aluminium foil to line the bottom of the oven.
- Do not place flammable materials in the oven: if the appliance is switched on accidentally, the materials could catch fire.
- Always make sure the knobs are in the “●”/“○” position when the appliance is not in use.
- When unplugging the appliance, always pull the plug from the mains socket; do not pull on the cable.
- Do not perform any cleaning or maintenance work without having disconnected the appliance from the electricity mains.
- If the event of malfunctions, under no circumstances should you attempt to perform the repairs yourself. Contact an authorised Service Centre (see Assistance).
- Do not rest objects on the open oven door.
- Do not let children play with the appliance.
- The appliance should not be operated by people (including children) with reduced physical, sensory or mental capacities, by inexperienced individuals or by anyone who is not familiar with the product. These individuals should, at the very least, be supervised by someone who assumes responsibility for their safety or receive preliminary instructions relating to the operation of the appliance.

- **The appliance is not intended to be operated by means of an external timer or separate remote-control system.**

Disposal

- When disposing of packaging material: observe local legislation so that the packaging may be reused.
- The European Directive 2012/19/EC on Waste Electrical and Electronic Equipment (WEEE), requires that old household electrical appliances must not be disposed of in the normal unsorted municipal waste stream. Old appliances must be collected separately in order to optimise the recovery and recycling of the materials they contain and reduce the impact on human health and the environment. The crossed out “wheeled bin” symbol on the product reminds you of your obligation, that when you dispose of the appliance it must be separately collected. Consumers should contact their local authority or retailer for information concerning the correct disposal of their old appliance.

Respecting and conserving the environment

- You can help to reduce the peak load of the electricity supply network companies by using the oven in the hours between late afternoon and the early hours of the morning. The cooking mode programming options, the “delayed cooking” mode (see Cooking modes) and “delayed automatic cleaning” mode (see Care and Maintenance) in particular, enable the user to organise their time efficiently.
- Check the door seals regularly and wipe them clean to ensure they are free of debris so that they adhere properly to the door, thus avoiding the dispersal of heat.

! This product complies with the requirements of the latest European Directive on the limitation of power consumption of the standby mode.

If no operations are carried out for a period of 2 minutes, the appliance automatically switches to the standby mode. The standby mode is visualised by the high luminosity “Watch Icon”.

As soon as interaction with the machine resumes, the system’s operating mode is restored.

Maintenance and care

Switching the appliance off

Disconnect your appliance from the electricity supply before carrying out any work on it.

Cleaning the appliance

- Slight differences in colour on the front of the oven are due to the different materials used, i.e. glass, plastic or metal.
- Any shady areas resembling grooves on the oven door glass are caused by reflections from the oven light.
- The enamel is branded at very high temperatures. This process may cause colour variations. This is normal and will not affect appliance operation in any way. The thin edges of the sheet metal cannot be entirely enamelled and may therefore appear to be unfinished. This will not

affect the rust protection.

- The stainless steel or enamel-coated external parts and the rubber seals may be cleaned using a sponge that has been soaked in lukewarm water and neutral soap. Use specialised products for the removal of stubborn stains. After cleaning, rinse and dry thoroughly. Do not use abrasive powders or corrosive substances.
- The inside of the oven should ideally be cleaned after each use, while it is still lukewarm. Use hot water and detergent, then rinse well and dry with a soft cloth. Do not use abrasive products.
- All accessories can be washed like everyday crockery, and are even dishwasher safe.

! Never use steam cleaners or pressure cleaners on the appliance.

Cleaning the oven door

Clean the glass part of the oven door using a sponge and a non-abrasive cleaning product, then dry thoroughly with a soft cloth. Do not use rough abrasive material or sharp metal scrapers as these could scratch the surface and cause the glass to crack. For more thorough cleaning purposes, the oven door may be removed:

1. Open the oven door fully (see diagram).
2. Use a screwdriver to lift up and turn the small levers **F** located on the two hinges (see diagram).

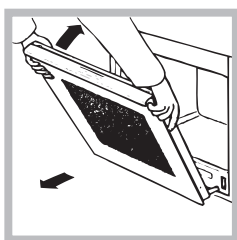
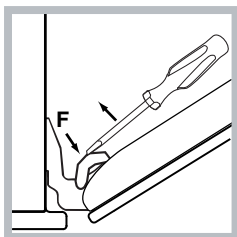
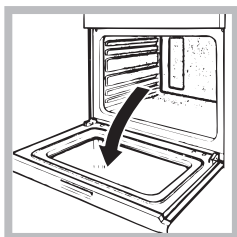

3. Grip the door on the two outer sides and close it approximately half way. Pull the door towards you, lifting it out of its slot (see diagram). To replace the door, reverse this sequence.

VERY HOT SURFACES

Food or grease on these surfaces could cause smoke and possibly even burn

YOU MUST KEEP THE OVEN AND GRILL CAVITIES CLEAN

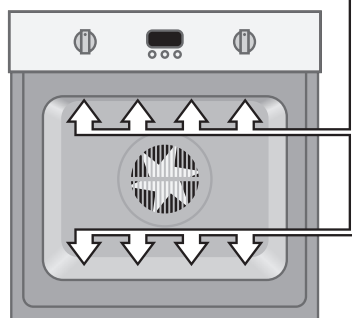

Inspecting the seals

Check the door seals around the oven regularly. If the seals are damaged, please contact your nearest Service Centre (see Assistance). We recommend that the oven is not used until the seals have been replaced.

Replacing the light bulb

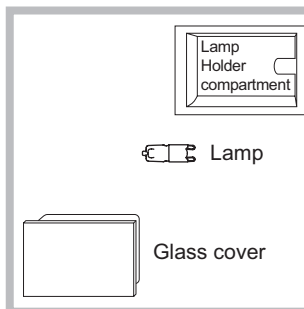

To replace the oven light bulb:

1. Remove the glass cover of the lamp-holder.
2. Remove the light bulb and replace it with a similar one: halogen lamp voltage 230 V, wattage 25 W, cap G 9.
3. Replace the glass cover (see diagram).

! Do not touch the light bulb directly with your hands.

! Do not use the oven lamp as/for ambient lighting.

Automatic cleaning using the FAST CLEAN function

During the FAST CLEAN cycle, the internal temperature of the oven reaches 500°C. The pyrolytic cycle is activated, burning away food and grime residues. Dirt is literally incinerated. Keep children well away from the appliance during the automatic cleaning cycle, as the surfaces may become extremely hot. Particles may ignite inside the oven due to the combustion process. This is not a cause for concern; it is a normal process and is completely safe.

Before initiating the FAST CLEAN mode:

! We recommend the duration of the first automatic cleaning cycle is set to 120 minutes.

! The oven should be cold. If the oven is too hot, the pyrolytic cycle may not start. Wait for the oven to cool down.

- Remove larger food residues from inside the oven using a damp sponge. Do not use detergent.
- Remove all accessories.
- Remove the DIVIDER.
- Do not leave tea towels or pot holders on the oven handle.

! The cycle will only begin once the oven door has been closed.

To start the FAST CLEAN cycle, turn the EXTRALARGE SPACE FUNCTION knob to **Fast Clean**.

The SET TIME button may be used to select the desired cleaning level. There are three default time settings, which cannot be modified:

1. Economy (ECO): turn the knob towards “-”. Duration: 1 hour.
2. Normal (NOR): initial level. Duration: 1 hour and 30 minutes.
3. Intensive (INT): turn the knob towards “+”. Duration: 2 hours.
4. Press the  button to confirm.

The end of the FAST CLEAN cycle may be programmed in the same way as a normal cooking cycle (see Programming the automatic cleaning end time).





! The desired Fast Clean mode will be confirmed and started automatically if the CLOCK icon button is not pressed within 10 seconds from selecting the cooking time.



! If the oven is too hot, the pyrolysis cycle may not begin or the word END may appear on the display. Wait for the oven to cool down.

Safety devices

- The  icon on the display, when lit, indicates that the oven door was automatically locked as soon as the temperature reached a high value.
- If a malfunction occurs, the heating elements will be switched off.
- Once the oven door has been locked, it will no longer be possible to modify the duration and end of cycle settings.

Programming the automatic cleaning end time

1. Press the  button until the  icon and the two numerical digits on the DISPLAY begin to flash.
2. Turn the SET TIME knob towards “+” and “-” to adjust the time.
3. Press the  button again, until the other numerical digits on the DISPLAY begin to flash.
4. Turn the SET TIME knob towards “+” and “-” to adjust the minute value.
5. Press the  button again to confirm.
6. Once the set time period has elapsed, the text END appears on the DISPLAY and a buzzer sounds.
 - For example: it is 9:00 and you have selected the Economy (ECO) FAST CLEAN mode, which has a default time of 1 hour. The end of the cycle is scheduled for 12:30, meaning it will begin automatically at 11:30.

If programming has been scheduled and confirmed, the  and  buttons will be illuminated. The duration and the FAST CLEAN end time will appear alternately on the DISPLAY.

At the end of the automatic cleaning cycle,

you will have to wait until the temperature inside the oven has cooled down sufficiently before you can open the oven door. You will notice some white dust deposits on the bottom and the sides of your oven; remove them with a damp sponge once the oven has cooled down completely. If, on the other hand, you wish to make use of the residual heat inside the oven, you do not have to remove the dust deposits as they are completely harmless and will not affect your food in any way.

NOTICE

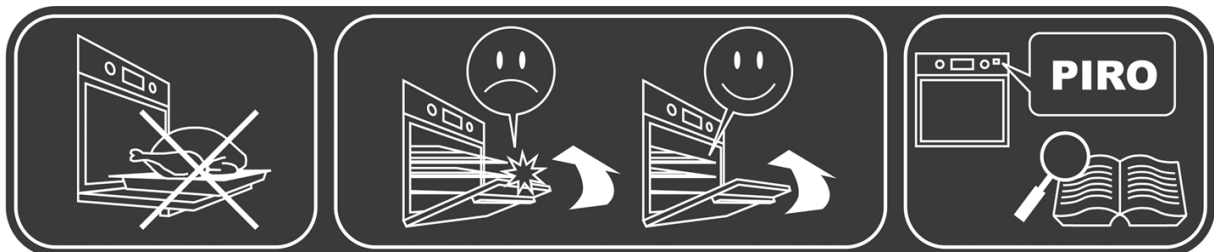

Do not place or rest anything on the open door

Make sure that the racks and dripping pans have been inserted fully before closing the door

Please read the manual carefully for information regarding the automatic cleaning (pyrolytic) cycle

Afetr Sales Service

No one is better placed to care for your Hotpoint appliance during the course of its working life than us – the manufacturer.

Essential Contact Information

Hotpoint Service

We are the largest service team in the country offering you access to 400 skilled telephone advisors and 1000 fully qualified engineers on call to ensure you receive fast, reliable, local service.

UK: 08448 224 224
Republic of Ireland: 0818 313 413
www.hotpointservice.co.uk

Please note: Our advisors will require the following information:

Model number:

Serial number:

Parts and Accessories

We supply a full range of genuine replacement parts as well as accessory products that protect and hygienically clean your appliance to keep it looking good and functioning efficiently throughout its life.

UK: 08448 225 225
Republic of Ireland: 0818 313 413
www.hotpointservice.co.uk

Appliance Registration

We want to give you additional benefits of Hotpoint ownership. To activate your free 5 year parts guarantee you must register your appliance with us.

UK: 08448 24 24 24
Republic of Ireland: 01 230 0800
www.hotpointservice.co.uk

Indesit Company UK Ltd. Morley Way, Peterborough, PE2 9JB
Indesit Company Unit 49 Airways Industrial Estate, Dublin 17

Recycling and Disposal Information

As part of Hotpoint's continued commitment to helping the environment, Hotpoint reserves the right to use quality, recycled components to keep down customer costs and minimise material wastage.

Please dispose of packaging and old appliances carefully. To minimise the risk of injury to children, remove the door, plug, and cut the mains cable off flush with the appliance. Dispose of these parts separately to ensure that the appliance can no longer be plugged into mains socket, and the door cannot be locked shut.

Guarantee

12 months Parts and Labour Guarantee

Your appliance has the benefit of our manufacturer's guarantee, which covers the cost of breakdown repairs for twelve months from the date of purchase.

This gives you the reassurance that if, within that time, your appliance is proven to be defective because of either workmanship or materials, we will, at our discretion, either repair or replace the appliance at no cost to you.

This guarantee is subject to the following conditions:

- The appliance has been installed and operated correctly and in accordance with our operating and maintenance instructions.
- The appliance is used only on the electricity or gas supply printed on the rating plate.
- The appliance has been used for normal domestic purposes only.
- The appliance has not been altered, serviced, maintained, dismantled, or otherwise interfered with by any person not authorised by us.
- Any repair work must be undertaken by us or our appointed agent.
- Any parts removed during repair work or any appliance that is replaced become our property.
- The appliance is used in the United Kingdom or Republic of Ireland.

The guarantee does not cover:

- Damage resulting from transportation, improper use, neglect or interference or as a result of improper installation
- Replacement of any consumable item or accessory. These included but not limited to: plugs, cables, batteries, light bulbs, fluorescent tubes and starters, covers and filters.
- Replacement of any removable parts made of glass or plastic.

THIS GUARANTEE WILL NOT APPLY IF THE APPLIANCE HAS BEEN USED IN COMMERCIAL OR NON-DOMESTIC PREMISES.

5 Year Parts Guarantee

Hotpoint also offers you a free 5 year parts guarantee. This additional guarantee is conditional on you registering your appliance with us and the parts being fitted by one of our authorised engineers. There will be a charge for our engineer's time. To activate the extra parts warranty on your appliance, simply call our registration line on **08448 24 24 24 (Republic of Ireland 01 230 0800)**

Extended Guarantees

We offer a selection of protection plans that enable you to fully cover yourself against the expense of repair bills for the life of your policy. To find the ideal plan for you please call our advice line on **08448 226 226 (Republic of Ireland 01 230 0233)**.

Free Helpdesk Service

We have a dedicated team who can provide free advice and assistance with your appliance if you experience any technical difficulties within the first 90 days of ownership. Simply call our Hotpoint Service Hotline on **08448 224 224 (Republic of Ireland 0818 313 413)** for telephone assistance, or, where necessary, to arrange for an engineer to call.

Free Manuals Download Website

<http://myh66.com>

<http://usermanuals.us>

<http://www.somanuals.com>

<http://www.4manuals.cc>

<http://www.manual-lib.com>

<http://www.404manual.com>

<http://www.luxmanual.com>

<http://aubethermostatmanual.com>

Golf course search by state

<http://golfingnear.com>

Email search by domain

<http://emailbydomain.com>

Auto manuals search

<http://auto.somanuals.com>

TV manuals search

<http://tv.somanuals.com>