



kitchen think

Instructions for Installation and Use

Electric Multifunction Oven Model ST87X

To the Installer

**Before installation fill in the product details on the back cover of this book.
The information can be found on the rating plate.**

To the User

**You must read the instructions prior to installing and using the appliance and
then retain them for future reference.**

CONTENTS

Introduction	4
For Your Safety	5
Know your Oven	6
The Controls	7-9
Cooking Advice	10-11
Cooking Chart	12
Care and Cleaning	13
Installation	14
Electrical Connection	15
After Sales Service	18
Hotpoint Guarantee	19
Key Contacts	Back Cover

Retention of this Instruction Book

This Instruction Book must be kept handy for reference as it contains important details on the safe and proper use of the appliance.

If you sell or pass the appliance to someone else, or move house and leave it behind, make sure this Book is also provided so the new owner can become familiar with the appliance and safety warnings.

If the Book is lost or damaged a copy may be obtained from:
GDA LTD., Morley Way, Peterborough, PE2 9JB

Introduction

Your new electric oven is guaranteed* and will give lasting service. This guarantee is only applicable if the appliance has been installed in accordance with the installation instructions detailed in this booklet.

To help make best use of your cooking equipment, please read this booklet carefully.

The oven is designed specifically for domestic use and responsibility will not be accepted for use in any other installation.

Note: When the oven is first used, an odour may be omitted - this will cease after a short period of use.

To help remove the 'new' smell, heat the empty oven to maximum temperature for a minimum of two to three hours, keeping the door/s closed. Ensure that the room is well ventilated (eg. open a window or use an extractor fan) and that persons who may be sensitive to the odour avoid any fumes. It is suggested that any pets be removed from the room until the smell has ceased.

This odour is due to any temporary finish on oven linings and elements and any moisture absorbed by the insulation.

*** The guarantee is subject to the provisions that the appliance:**

- (a) Has been used solely in accordance with this booklet.**
- (b) Has been properly connected to a suitable supply voltage as stated on the rating plate, attached to the appliance.**
- (c) Has not been subjected to misuse or accident or been modified or repaired by any person other than the manufacturers authorised employee or agent.**
- (d) Has been correctly installed.**

For Your Safety

When used properly your appliance is completely safe but as with any electrical product there are certain precautions that must be observed.

PLEASE READ THE BELOW PRECAUTIONS BEFORE USING YOUR APPLIANCE.

To maintain the efficiency and safety of this appliance, we recommend you do the following:

- only call the Service Centres authorised by the manufacturer.
- always use genuine spare parts.

ALWAYS:

- make sure you remove all packaging and literature from inside the appliance before switching on for the first time.
- check the soundness of the appliance after it has been unpacked.
- make sure you understand the controls before using the appliance.
- keep children away from the appliance during use, as surfaces will get extremely hot during and after cooking. Care should be taken to avoid touching the heating elements inside the oven during use.
- make sure the controls are turned off when you have finished cooking and when not in use.
- grip the handle in the centre when opening the door.
- stand back when opening the door to allow any build up of steam or heat to disperse.
- use dry, good quality oven gloves when removing items.
- take care to avoid heat/steam burns when operating the controls.
- switch off the electricity supply at the wall switch, and allow to cool, before cleaning or performing maintenance..
- make sure the shelves are in the correct position before switching on the oven.
- keep the door partially open when grilling.
- keep the door closed when the appliance is not in use.
- keep the appliance clean as a build up of grease or fat from cooking can cause a fire.
- follow the basic principles of food handling and hygiene to prevent the possibility of bacterial growth.
- keep any ventilation slots clear of obstructions.

NEVER:

- attempt to install or repair the appliance without the assistance of qualified personnel.
- operate the grill with the door closed (except when using the rotisserie) as this may cause the appliance to overheat.
- remove the oven shelves whilst the oven is hot.
- allow anyone to sit or stand on any part of the appliance.
- store items above the appliance that children may attempt to reach.
- heat up unopened food containers, as pressure can build up causing the container to burst.
- use the appliance to heat up anything other than food.
- use the appliance as a room heater.
- use the grill to warm plates.
- dry items on the oven doors.
- install the appliance next to curtains of other soft furnishings.
- allow children to play with or tamper with the controls.
- use steam cleaners.
- use the oven for storage purposes.
- use flammable liquids near the appliance.
- use adapters, multiple sockets and/or extension leads.
- pull on the appliance or the supply cable to unplug it from the electrical outlet.
- allow power cables of other appliances to come into contact with hot parts of this appliance.
- expose the appliance to atmospheric agents, such as rain or sunlight.
- operate the appliance with wet hands.
- operate the appliance when barefoot.

Know your Oven

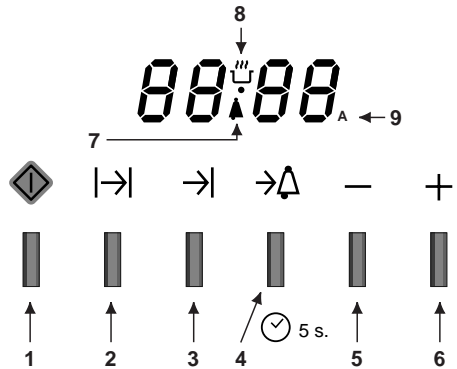
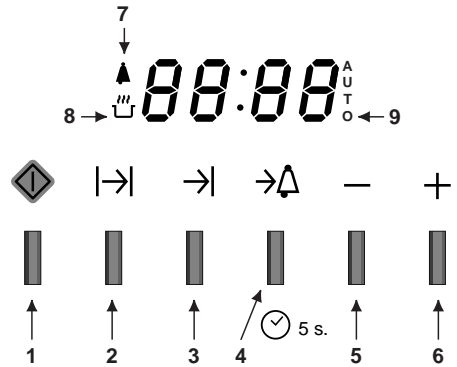
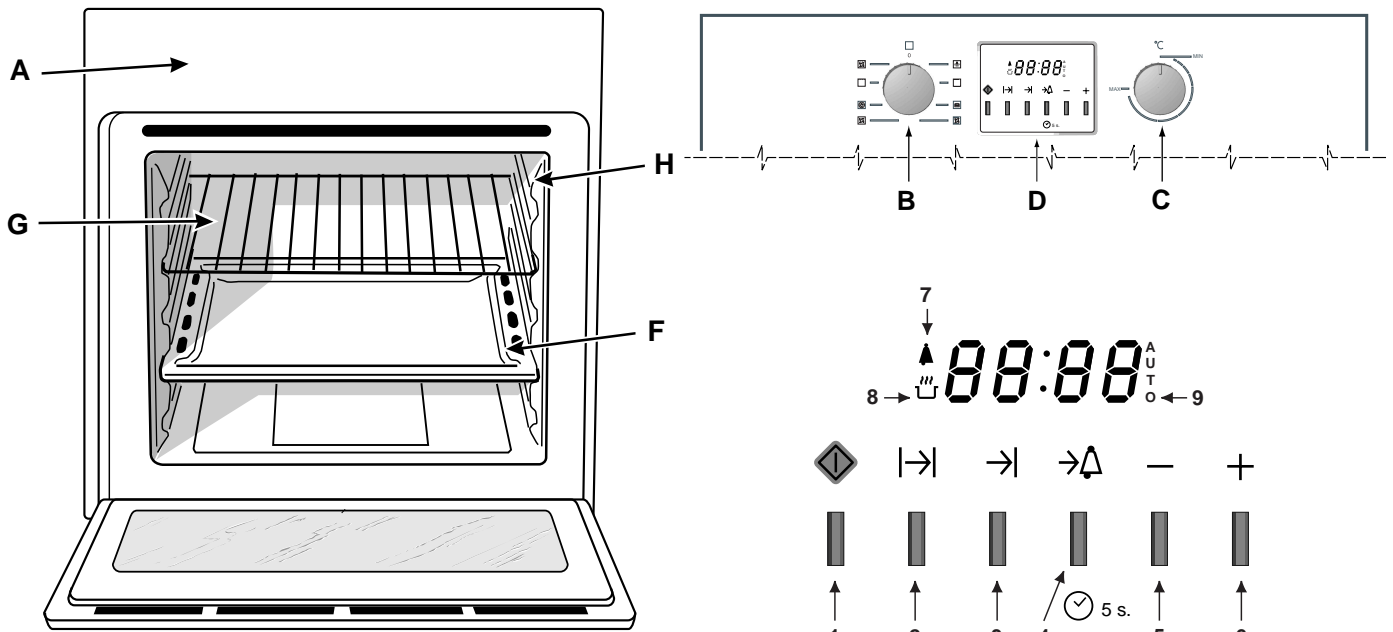

- A. **Control Panel**
- B. **Function selector**
- C. **Temperature control**
- D. **Electronic programmer** - Allows you to programme the desired cooking mode by selecting the cooking time and the end cooking time. It can also be used as a timer.
- F. **Grill Pan or Baking Tray**
- G. **Oven Shelf**
- H. **Guides for sliding the shelf or grill pan/baking tray in and out**

- 1. **Cooking start**
- 2. **Cooking time**
- 3. **End cooking time**
- 4. **Minute Minder**
- 5. **Decrease / Buzzer volume**
- 6. **Increase / Temperature display**
- 7. **Minute Minder indicator**
- 8. **Pre-heating (□ flashing) or cooking (□ on) under way indicator**
- 9. **Programming complete indicator**

The Controls

The **7 Chefs** oven combines the advantages of a convection oven with those of fan assisted models in a single appliance.

It is extremely versatile allowing you to choose easily and safely between 7 different cooking modes. The various features offered by the oven are selected by means of the function selector "B" situated on the control panel.

Setting the digital clock

The time can only be set on the clock when the function selector "B" is in position 0.

After the appliance has been connected to the power supply, or after a power failure, the clock display will automatically reset to **0:00** and begin to blink. **0.00**.

Press button — or + to increase or decrease the time.

Upon releasing these buttons, the time set will be memorised, but you still have another 3 seconds to continue your modification.

Any changes to the time can be made by pressing button $\rightarrow\Delta$ and holding it down, until the time appears back on the display and then pressing button — or + . Upon releasing these buttons, the time set will be memorised, and you still have another 3 seconds to continue your modification.

The oven light

Set the function selector "B" to the  symbol to turn it on. It lights the oven and stays on when any of the electrical heating elements in the oven come on.

Please remember that once cooking is over, the oven light will stay on until the function selector "B" is set back to position 0 or until the oven has cooled down sufficiently.

Cooking without the Programmer

When function selector "B" is in position 0, temperature control "C" and buttons , |\rightarrow| , \rightarrow| and + are disabled.

Set the function selector "B" to the desired cooking mode and the recommended cooking temperature will appear on the display (**which is independent from the position of the temperature control "C"**).

If the value offered is not the one you require, you can change the temperature, 10° at a time, by turning the temperature control "C".

Each cooking mode is also associated with a recommended cooking time, which can be decreased down to 2 min or increased up to 9h59min, by pressing the |\rightarrow| button, fol-

lowed by — and/or + . Upon releasing button  or + , the cooking time set will be memorised, but you still have another 3 seconds to continue your modification.

Keep in mind that, in the case of non programmed cooking, the set cooking time does not include the time required for the oven to heat up to the appropriate temperature.

Notice: the cooking start will automatically be postponed by 2 minutes when you press the \rightarrow| button. To cancel this setting, set the function control "B" back to position 0.

To start cooking, press the  button. for safety reasons, if you fail to do the above within one minute after you have set the function control "B", the word -END will come up on the display and the buttons will be disabled. To enable the buttons again, just set the function control "B" back to position 0.

Once cooking has started, the oven begins the pre-heating phase, during which icon  flashes on the display and the cooking temperature set comes up too.

When it is reached, you will hear three consecutive beeps and icon  will come on permanently. Now you can place the food to be cooked inside the pre-heated oven.

Note: The pre-heating phase is not foreseen for the FAST COOKING and GRILL modes, and the oven will consequently start cooking immediately after button  is pressed.

Please remember that when cooking is under way, you can always:

- modify the cooking mode (by turning the function control "B") without this affecting the temperature and cooking time set;
- Check the selected temperature by pressing button + .
- modify the temperature (by turning the temperature control "C");
- modify the cooking time (by pressing button |\rightarrow| and then — or + to increase or decrease the amount of time).
- stop it at any time by setting the function selector "B" back to 0.

When the set cooking time is up, a buzzer will sound, and will stop doing so after 1 minute or if you press any button whatsoever. The word -END will appear, the control panel and the temperature control "C" will be disabled until the function selector "B" is set to position 0.

The Controls

Keep warm phase

To keep food you have just cooked warm, the oven keeps the internal fan on at the end of all cooking modes that foresee the use of the fan. The forced circulation of air will stop when knob "B" is set to position 0 or when the oven has cooled down.

The Cooking Modes:

Convection

Position the temperature selector "C" between **40°C** and **250°C**.

The top and bottom heating elements are used. In this mode, the coolest part of the oven is the centre. The convection oven is best for cooking dishes made up of several ingredients, e.g. tender veal strips with rice, braised meats, stews, goulash etc.) and dishes that need to cook slowly and require basting or the addition of liquid and cooking using covered casserole dishes for oven baking. When cooking in convection mode, only use one baking tray or shelf at a time, otherwise the heat distribution will be uneven. Using the different shelf position available, you can balance the amount of heat between the top and the bottom of the oven. Select from among the various shelf positions based on whether the dish needs more or less heat from the top.

Baking

Position the temperature control "C": between **40°C** and **250°C**.

The rear heating element and the fan come on, guaranteeing delicate heat distributed uniformly throughout the oven. This mode is ideal for baking and cooking delicate foods - especially cakes that need to rise - and for the preparation of certain tartlets on 3 shelves at the same time. Here are a few examples: cream puffs, sweet and savoury biscuits, savoury puffs, Swiss rolls and small portions of vegetables au gratin, etc.....

"Fast cooking" Mode

Position the temperature control "C": between **40°C** and **250°C**.

All the heating elements and the fan come on, guaranteeing constant heat distributed uniformly throughout the oven. This mode is especially recommended for cooking pre-packed food quickly (as pre-heating is not necessary), such as for example: frozen or pre-cooked food) as well as for a few "home-made" dishes.

The best results when cooking using the "Fast cooking" mode are obtained if you use one cooking shelf only (the second from the bottom), please see the table entitled "Cooking Advice".

Multi-cooking Mode

Position the temperature control "C": between **40°C** and **250°C**.

All the heating elements and the fan, will come on. Since the heat remains constant and uniform throughout the oven, the air cooks and browns food uniformly over its entire surface. With this mode, you can also cook various dishes at the same time, as long as their respective cooking temperatures are the same. A maximum of 2 shelves can be used at the same time, following the instructions in the section entitled: "Cooking On More Than One Shelf".

This Multi-cooking mode is particularly recommended for dishes

requiring a gratin finish or for those requiring considerably prolonged cooking times, such as for example: lasagne, pasta bakes, roast chicken and potatoes, etc... Moreover, the excellent heat distribution makes it possible to use lower temperatures when cooking roasts. This results in less loss of juices, meat which is more tender and a decrease in the loss of weight for the roast. The Multi-cooking mode is especially suited for cooking fish, which can be prepared with the addition of a limited amount of condiment, thus maintaining their flavour and appearance.

The Multi-cooking mode is also perfect for baking leavened cakes.

Moreover, this mode can also be used to thaw quickly white or red meat and bread by setting the temperature control to 80 °C. Defrosting - this mode can be used to thaw more delicate foods, set the temperature control to 60°C or use only the cold air circulation feature by setting the temperature control to 0°C.

Pizza Mode

Position the temperature control "C": between **40°C** and **250°C**.

The bottom and circular heating elements, as well as the fan, will come on. This combination rapidly heats the oven due to the large amounts of power used by the appliance (2800 W), which results in the production of considerable heat coming mostly from the bottom.

The pizza mode is ideal for foods requiring high temperatures to cook, like pizzas and large roasts. Only use one baking tray or shelf at a time. However, if more than one is used, these must be switched halfway through the cooking process.

Grill /

Position the temperature control "C": between **1** and **5**.

(1 being the minimum setting and 5 being the maximum).

The top central heating element and the rotisserie come on. The extremely high and direct temperature of the grill makes it possible to brown the surface of meats and roasts while locking in the juices to keep them tender. The grill is also highly recommended for dishes that require a high temperature on the surface: beef steaks, veal, rib steak, filets, hamburgers etc...

Always leave the oven door ajar during cooking, except when using the rotisserie.

Some grilling examples are included in the "Cooking Advice" section.

Gratin /

Position the temperature control "C": between **40°C** and **250°C**.

The top central heating element, the fan and the rotisserie come on.



This combination of features increases the effectiveness of the unidirectional thermal radiation of the heating elements through forced circulation of the air throughout the oven. This helps prevent food from burning on the surface, allowing the heat to penetrate right into the food. Excellent results are achieved with kebabs made with meats and vegetables, sausages, ribs, lamb chops, chicken in a spicy sauce, pork chops, swordfish, tuna steaks etc.

All cooking using the "Gratin" must be done with the oven door shut.

The Controls

The rotisserie

To start the rotisserie, proceed as follows:

- place the grill pan on the 1st shelf.
- insert the special rotisserie support on the 3rd shelf and position the spit by inserting it through the special hole into the rotisserie at the back of the oven.
- start the rotisserie by setting the function selector "B" to  / .

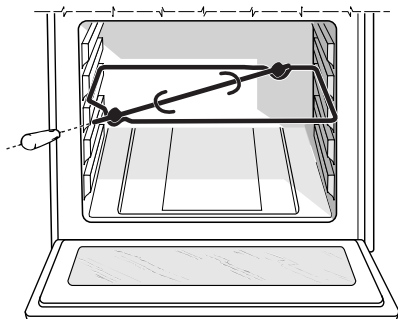

Burn-free system



When using the rotisserie, remember that the oven is fitted with a special system which allows the food to continue to rotate even when the cooking time is up. This will prevent the thermal inertia of the oven from affecting in any way the quality of the food cooked in rotisserie mode.



Please remember that once cooking is over, the spit will continue to rotate until the function selector "B" is set back to position 0 or until the oven has cooled down sufficiently.

Minute Minder Feature

The timer can only operate with the oven switched off and the function selector "B" set to position 0.

Please remember that the timer does not control the starting or stopping of the oven, it merely sounds a buzzer when the time is up and can be interrupted at any time just by pressing any button.

To set the timer, briefly press button  and then make adjustments using  or .

Upon releasing button  or , the time set is memorised but you still have another 3 seconds to continue making any changes. The display will reset to show the time and countdown will begin immediately. The  icon will remind you the Minute Minder is on.

Once the countdown is over, a buzzer will sound, and will stop doing so after 1 minute or if you press any button whatsoever.









Please remember that the countdown is reset and the  icon comes off once cooking starts.

Buzzer volume

The volume of the buzzer can be adjusted, either with the oven switched off or even during cooking, just by pressing button  until you attain the desired tone.

How to set a programme to automatically switch off and on:

To programme the cooking mode, follow the instructions below:

- select the cooking mode by turning function selector "B", and turn the temperature control "C" to required setting.
- select the cooking time by pressing button . The recommended cooking time will appear on the display, and it can be altered by pressing  or  until the desired cooking time comes up. Upon releasing the buttons, the cooking time set will be memorised, but you still have another 3 seconds to continue your modification. Remember that, in this case, the value entered also includes the time required for the oven to reach the desired temperature.
- select the end cooking time by pressing button . The current end cooking time is displayed. This is calculated by adding the cooking time previously set to the current time. Press button  or  until the display shows the time you want the food to be ready. Upon releasing the buttons, the end cooking time set will be memorised, but you still have another 3 seconds to continue your modification.
- press button  to activate the programme. For safety reasons, if button  is not pressed within one minute after you have set function selector "B", the word **-END** will come up on the display and the buttons will be disabled. To enable the buttons again, just set knob "B" back to position 0.

When awaiting a delayed start, indicated by icon "A"/"Auto", the display will remind you of the end cooking time alternated with the temperature set. During this wait, you may not make any changes to the settings made except for those pertaining to the temperature and cooking mode.

Note: if the oven is already hot, the light and the fan on the inside will stay on until it has cooled down sufficiently.

To cancel a cooking schedule already programmed

To cancel any programming you have made, set the function selector "B" to position "0".

The cancellation will be confirmed by the word **-OFF** that appears for 3 seconds on the display.

Cooling ventilation

In order to cool down the exterior of the appliance, some models are equipped with a cooling fan which comes on automatically when the oven is hot.

When the fan is on, a normal flow of air can be heard exiting between the oven door and the control panel.



Note: When cooking is finished, the fan stays on until the oven cools down sufficiently.

Note: In "Fast Cooking" mode, the fan comes on automatically only once the oven is hot.

Notice: the appliance is fitted with a diagnosis system which detects any malfunctions. The user is informed of the latter by messages such as "Fn Fm" that come up on the display (*n and m = single digit numbers*). In these cases, you need to call for technical assistance as the oven is faulty.

The oven offers a wide range of alternatives which allows you to cook any type of food in the best possible way. With time you will learn to make the best use of this versatile cooking appliance and the following are only a guide, which may be varied according to your own personal taste.

Cooking on More Than One Shelf

If you have to cook food on several shelves, use either the “baking” mode  or the  “Multi-cooking” mode, as these are the only modes that allow you to do so.

When cooking delicate food on more than one shelf, use the “baking” mode,  which allows you to cook on 3 shelves at the same time (the 1st, 3rd and 5th from the bottom). Some examples are included in the “Cooking Chart”.



When cooking other food on several shelves, use the “Multi-cooking” mode  keeping the following suggestions in mind:

- The oven is fitted with 5 shelves. During fan assisted cooking, use two of the three central shelves; the lowest and highest shelves receive the hot air directly and therefore delicate foodstuffs could be burnt on these shelves.
- As a general rule, use the 2nd and 4th shelf from the bottom, placing the foodstuffs that require greater heat on the 2nd shelf from the bottom. For example, when cooking meat roasts together with other food, place the roast on the 2nd shelf position from the bottom and the more delicate food on the 4th shelf position from the bottom.
- When cooking food that require differing times and temperatures, set a temperature that is somewhere between the two temperatures required, place the more delicate food on the 4th shelf position from the bottom and take the food requiring less time out of the oven first.
- Use the baking tray on the lower shelf position and the shelf on the upper;

Using the “Fast Cooking” Mode



Functional, fast and practical for those of you who use frozen or pre-cooked food along with other food items. You will find useful suggestions in the “Cooking Chart” .

Using the Grill

The “7 Chefs” oven offers you several different grilling modes. Use the  /  “grill” mode, **with the oven door ajar**, placing the food in the centre of the grill pan (situated on the 3rd or 4th shelf from the bottom).

When using this mode, we recommend you set the temperature control to the highest setting. Lower temperatures can also be set, simply by setting the temperature control to the temperature required.

In models fitted with a rotisserie , you can use the spit kit provided when using the “grill” mode. In this case, cook with the oven door shut, placing the spit kit on the third oven shelf from the bottom and the grill pan on the bottom shelf to collect any sauce and /or dripping fat.

Setting  /  “Gratin”, is extremely useful for grilling foods rapidly, as the distribution of heat makes it possible not only to brown the surface, but also to cook the bottom part.

Moreover, it can also be used for browning foods at the end of the cooking process, such as adding that gratin finish to pasta bakes.

When using this mode, place the shelf on the 2nd or 3rd shelf position from the bottom (see cooking table) then, to prevent fat and grease from dripping onto the bottom of the oven and thus smoke from forming, place a baking tray on the 1st shelf position from the bottom.

Important: always cook in “Gratin” mode with the oven door shut. This will allow you both to obtain excellent results and to save on energy (approximately 10%).

When using this mode, we advise you to set the temperature control to 200°C, as it is the most efficient way to use the grill, which is based on the use of infrared rays. However, this does not mean you cannot use lower temperatures, simply by adjusting the thermostat knob to the desired temperature.

In models fitted with a rotisserie , you can use the spit kit provided when using the “gratin” mode. In this case, place the spit kit on the third shelf position from the bottom and the baking tray on the bottom shelf to collect any sauce and /or dripping fat.

Cooking Advice

Baking Cakes

When baking cakes, always preheat the oven. Make sure you wait until the oven has preheated thoroughly (the red oven indicator light "E" will go out). Do not open the oven door during baking to prevent the cake from dropping. In general, if:

Pastry is too dry

Increase the temperature by 10°C and reduce the cooking time.

Pastry has dropped

Use less liquid or lower the temperature by 10°C.

Pastry is too dark on top

Place it on a lower shelf, lower the temperature and increase the cooking time.

It is cooked well on the inside but sticky on the outside

Use less liquid, lower the temperature, and increase the cooking time.

The pastry sticks to the pan

Grease the pan well and sprinkle it with a dusting of flour or use greaseproof paper.

You used more than one shelf (in the fan assisted oven mode) and they are not all at the same cooking point.

Use a lower temperature setting. It is not necessary to remove the food from all the shelves at the same time.

Cooking Fish and Meat

When cooking white meat, fowl and fish, use temperature settings from 180 °C to 200 °C.



For red meat that should be well done on the outside while tender and juicy in the inside, it is a good idea to start with a high temperature setting (200°C-220°C) for a short time, then turn the oven down afterwards.

In general, the larger the roast, the lower the temperature setting. Place the meat on the centre of the shelf and place the grill pan/baking tray beneath it to catch the fat.









Make sure that the shelf is inserted so that it is in the centre of the oven. If you would like to increase the amount of heat from below, use the low shelf positions.

Cooking Pizza

For best results when cooking pizza, use setting  for “**Pizza Mode**”:

- Preheat the oven for at least 10 minutes
- Use a light aluminium pizza pan, placing it on the shelf supplied with the oven. If the baking tray is used, this will extend the cooking time, making it difficult to get a crispy crust;
- Do not open the oven door frequently while the pizza is cooking;
- If the pizza has a lot of toppings (three or four), we recommend you add the mozzarella cheese on top halfway through the cooking process.
- If cooking on more than one shelf (up to 2), we advise you to use the Multi-cooking Mode  as the Pizza Mode  would heat the bottom shelf more than the others.

Cooking Chart

Cooking Function	Type of food	Weight (in kg)	Shelf position from bottom of the oven.	Preheating time (min.)	Thermostat setting	Cooking time (min.)
1 Convection 	Duck	1	3	15	200	65-75
	Roast veal or beef	1	3	15	200	70-75
	Pork roast	1	3	15	200	70-80
	Biscuits (short pastry)	-	3	15	180	15-20
	Tarts	1	3	15	180	30-35
2 Baking 	Tarts	0.5	3	15	180	20-30
	Fruit cakes	1	2/3	15	180	40-45
	Plum cake	0.7	3	15	180	40-50
	Sponge cake	0.5	3	15	160	25-30
	Stuffed pancakes (on 2 shelves)	1.2	2-4	15	200	30-35
	Small cakes (on 2 shelves)	0.6	2-4	15	190	20-25
	Cheese puffs (on 2 shelves)	0.4	2-4	15	210	15-20
	Cream puffs (on 3 shelves)	0.7	1-3-5	15	180	20-25
	Biscuits (on 3 shelves)	0.7	1-3-5	15	180	20-25
	Meringues (on 3 shelves)	0.5	1-3-5	15	90	180
3 Fast cooking 	Frozen food					
	Pizza	0.3	2	-	Max	12
	Courgette and prawn pie	0.4	2	-	200	20
	Country style spinach pie	0.5	2	-	220	30-35
	Turnovers	0.3	2	-	200	25
	Lasagne	0.5	2	-	200	35
	Golden Rolls	0.4	2	-	180	25-30
	Chicken morsels	0.4	2	-	220	15-20
	Pre-cooked food					
	Golden chicken wings	0.4	2	-	200	20-25
	Fresh Food					
	Biscuits (short pastry)	0.3	2	-	200	15-18
	Plum cake	0.6	2	-	180	45
Cheese puffs	0.2	2	-	210	10-12	
4 Multi-cooking 	Pizza (on 2 shelves)	1	2-4	15	230	15-20
	Lasagne	1	3	10	180	30-35
	Lamb	1	2	10	180	40-45
	Roast chicken + potatoes	1+1	2-4	15	200	60-70
	Mackerel	1	2	10	180	30-35
	Plum cake	1	2	10	170	40-50
	Cream puffs (on 2 shelves)	0.5	2-4	10	190	20-25
	Biscuits (on 2 shelves)	0.5	2-4	10	180	10-15
	Sponge cake (on 1 shelf)	0.5	2	10	170	15-20
	Sponge cake (on 2 shelves)	1.0	2-4	10	170	20-25
	Savoury pies	1.5	3	15	200	25-30
5 Pizza 	Pizza	0.5	3	15	220	15-20
	Roast veal or beef	1	2	10	220	25-30
	Chicken	1	2/3	10	180	60-70
6 Grill  	Sole	1	4	-	5	8-10
	Squid and prawn kebabs	1	4	-	5	6-8
	Cod filet	1	4	-	5	10
	Grilled vegetables	1	3/4	-	5	10-15
	Veal steak	1	4	-	5	15-20
	Cutlets	1	4	-	5	15-20
	Hamburgers	1	4	-	5	7-10
	Mackerels	1	4	-	5	15-20
	Toasted sandwiches	n.° 4	4	-	5	2-3
	With rotisserie (where present)					
	Veal on the spit	1.0	-	-	5	80-90
	Chicken on the spit	1.5	-	-	5	70-80
	Lamb on the spit	1.0	-	-	5	70-80
7 Gratin  	Grilled chicken	1.5	2	10	200	55-60
	Cuttlefish	1.5	2	10	200	30-35
	With rotisserie (where present)					
	Veal on the spit	1.5	-	10	200	70-80
	Lamb on the spit	1.5	-	10	200	70-80
	Chicken (on the spit) + potatoes (roasted)	1.5	-	10	200	70-75
		-	2	10	200	70-75

NB. The cooking times shown in this chart are approximate and may vary according to personal taste.

Care and Cleaning

Before carrying out any cleaning and maintenance to your appliance you must disconnect it from the power supply.

Inside the oven

We recommend you clean your oven each time you use it, especially after cooking roasts. In fact, it is advisable to prevent food residue from building up during cooking: the residue would be re-cooked each time the oven is used and would **char and release smoke and unpleasant odours**.

Oven exterior

Clean the enamelled or stainless steel exterior surfaces of your oven using a sponge soaked in soapy water, making sure you rinse and dry these thoroughly, without using abrasive or corrosive products which could damage them.

Stainless steel

Rinse stainless steel parts and dry them thoroughly using a soft cloth. Use a specific non-abrasive product to remove tougher stains,

DO NOT use aluminium foil to line the bottom of the oven.

To avoid having to clean the bottom of the oven, you may be tempted to line it with some aluminium foil. **We strongly advise against this. The aluminium foil sheet in direct contact with the heated enamel coating could melt and damage the enamel coating inside the oven irreversibly.**

Cleaning the rotisserie and other accessories

The rotisserie can be removed completely thanks to the 2 wing nuts. The elements comprising the rotisserie assembly should be cleaned together with the other accessories (dripping pan, grid) in the sink using a damp sponge and ordinary detergent or even in your dishwasher.

Rubber Seal

There is a rubber seal surrounding the oven opening which guarantees its perfect functioning. Check the condition of this seal on a regular basis. If necessary, clean it using warm water and dry thoroughly.

DO NOT use abrasive products or objects to do so. Should the seal become damaged, please contact Hotpoint Service (see KEY CONTACTS, back page). We recommend you avoid using the oven until it has been repaired.

Disassembling the oven door

The oven door can easily be removed to clean the space between the bottom of the door and the front of the oven. To disassemble the door, proceed as follows:

- open the oven door fully,
- lift up and turn the small levers situated on the two hinges,
- shut the door, but not completely,
- grip the door on the two external sides and pull it towards you, pulling it out of its seat.

Reassemble the door by following the above procedures in reverse order.

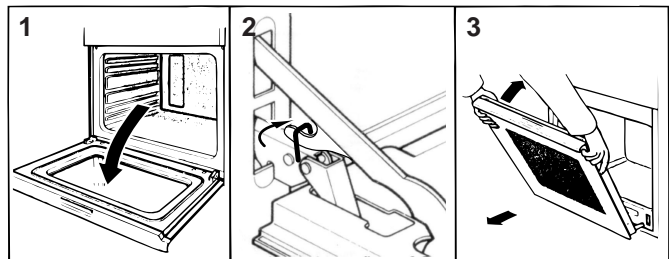

Replacing the Oven Lamp

- Disconnect the oven from the power supply by means of the omnipolar switch used to connect the appliance to the electrical mains; or unplug the appliance if the plug is accessible.
- Remove the glass cover of the lamp-holder;
- Remove the lamp and replace with a lamp resistant to high temperatures (300°C) with the following characteristics:
 - Voltage: 230/240 V
 - Wattage 25W
 - Type E14
- Replace the glass cover and reconnect the oven to the power supply.

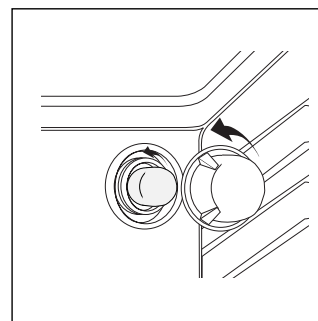

Installation

The appliance must be installed only by a qualified person in compliance with the instructions provided. The manufacturer declines all responsibility for improper installation which may harm persons and animals and damage property.

Important: The power supply to the appliance must be cut off before any adjustments or maintenance work is done on it.

Installation of Built-in Ovens

In order to ensure that the built-in appliance functions properly, the cabinet containing it must be appropriate. The figure below gives the dimensions of the cut-out for installation under the counter or in a wall cabinet unit.

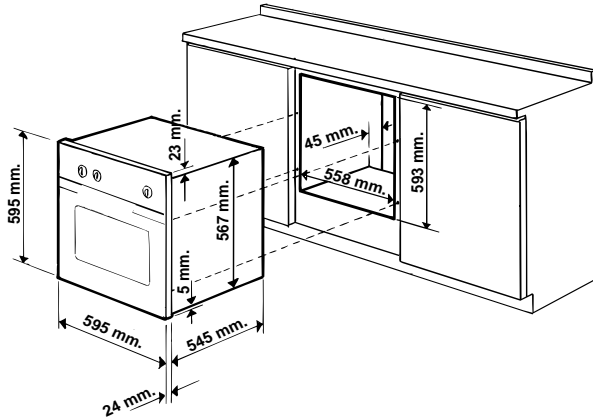

N.B.: Installation in compliance with the consumption declaration

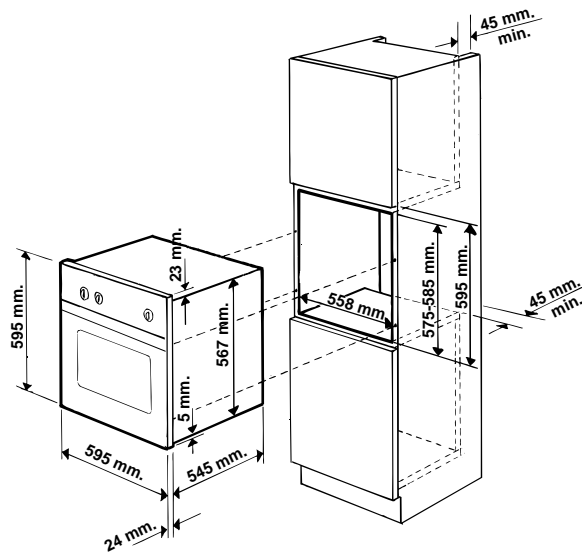

In order to ensure adequate ventilation, the back panel of the cabinet unit must be removed. Installing the oven so that it rests on two strips of wood is preferable. If the oven rests on a continuous, flat surface, there must be an aperture of at least 45 x 560 mm.

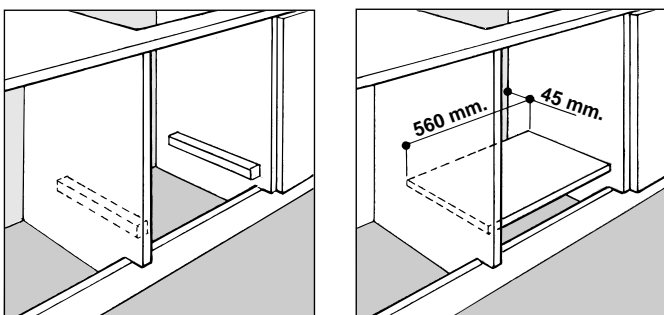

The panels of the adjacent cabinets must be made of heat-resistant material. In particular, cabinets with a veneer exterior must be assembled with glues which can withstand temperatures of up to 100 °C.

In compliance with current safety standards, contact with the electrical parts of the oven must not be possible once it has been installed.

All parts which ensure the safe operation of the appliance must be removable only with the aid of a tool.

For the correct centring of your appliance, position the 4 tabs on the sides of the oven in correspondence with the 4 holes on the perimeter of the frame. In particular, if the cabinet side panel:

- is 20 mm thick: the removable part of the tab must be removed (Fig. A);
- is 18 mm thick: use the first groove, which is factory-set (Fig. B);
- is 16 mm thick: use the second groove (Fig. C)

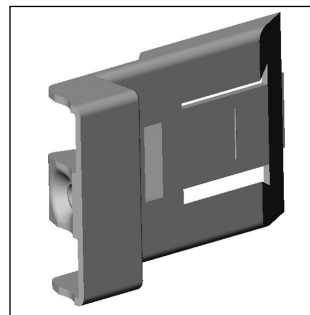

Fig. A

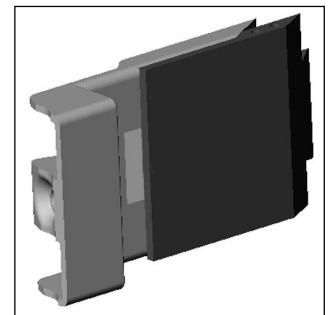

Fig. B

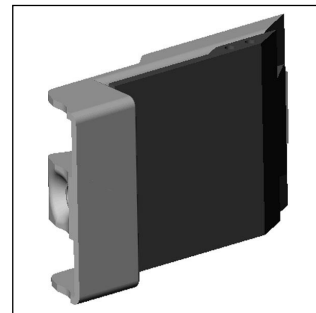
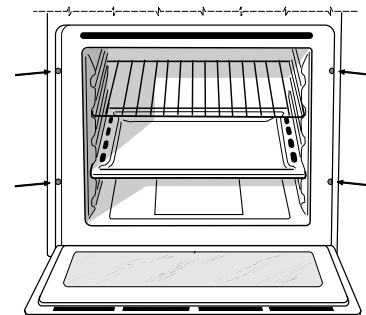

Fig. C

To fasten the oven to the cabinet, open the door of the oven and attach it by inserting the 4 wood screws into the 4 holes located on the perimeter of the frame.



Electrical Connection

Those ovens equipped with a three-pole power supply cable are designed to operate with an alternating current with the voltage and frequency indicated on the data plate (located on the appliance) and in the instruction manual. The wire for earthing the appliance is yellow-green in colour.

Electrical Connection

Electrical connection

The electrical connection to the mains must be made on the appliance. The power voltage and frequency are as indicated on the rating plate.

WARNING: THIS APPLIANCE MUST BE EARTHED.

Mounting the power supply cable

To open the terminal board:

- Using a screwdriver, press on the tabs situated on each side of the terminal board cover.
- Pull open the terminal board cover.

To mount the power supply cable, proceed as follows:

- Unscrew the cable clamp screw and the contact screws.
- Position the jumpers accordingly to the type of connection you wish to make as per the diagrams below.
- **Note:** The jumpers are factory set for a 230V single phase connection.
- Fasten the power supply cable in the corresponding cable clamp and close the cover.

Electrical Connections:

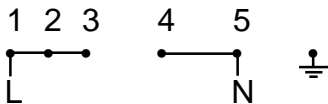

Voltage Frequency: 230 V-1+N 50Hz

Fuse Section: 32A 4mm³

You can connect your oven to the system means of a terminal board. Refer to above information for the minimal cable sections and the calibration of the protective elements according to the connection.

If the appliance is installed **with a junction box**, an **omnipolar circuit breaker** - with a minimum contact opening of 3mm - should be installed between the appliance and the mains.

Power cable supply connection to the electrical mains:

We recommend you use a power supply cable which is long enough to allow you to take the oven out of its recess in the event of maintenance operations (only use HAR - H 05 - RRF quality cables fitted with a plug conforming to the regulations in force.

The plug must be accessible at all times.

Unplug the appliance before all operations, even when replacing the oven lamp.

Using the appliance without correct earthing is highly dangerous.

IMPORTANT:

After connecting the appliance to the flexible cable, tighten all the screws on the terminal board.

This appliance conforms to the following EEC Directives:

Low Voltage Equipment

73/23/EEC

93/68/EEC

Electromagnetic Compatibility

89/336/EEC

93/68/EEC

Inner dimensions of the oven:

width 43.5cm

depth 40.0cm

height 32.0cm

Voltage and frequency of power supply:

230-240V

50-60Hz

2250-2400W

ENERGY LABEL

Directive 2002/40/EC on the label of electric ovens

Norm EN 50304

Energy consumption for Natural convection

heating mode: Convection

Declared energy consumption for Forced convection Class

heating mode: Baking



After Sales Service

"No company is better positioned to offer an after sales service on a Hotpoint appliance than us - the manufacturer"

As part of our commitment to you, all Hotpoint appliances have the added benefit of a fully inclusive parts and labour guarantee for the first 12 months. In addition to this you also have the advantage of **free replacement parts for the first 5 years** when fitted by a Hotpoint engineer. When the 12 months parts and labour guarantee expires we offer the following after sales service options:

Repair Service and Information Help Desk

UK: 08709 066066

www.theservicecentre.co.uk

Republic of Ireland: 1850 302 200

Note: Our operators will require the Model number and the Serial number of your appliance

Available 364 days a year with a fast, effective and value for money service. We have the largest white goods repair service in the UK with over 1200 of our own fully trained engineers. All repairs include a parts and labour guarantee for 12 months from the date of the repair.

If you require any information or have any questions about your appliance, our operators are on hand with help and advice.

All this ensures that you will receive the best available after sales service possible.

Extended Warranties

UK: 08709 088 088

www.theservicecentre.co.uk

Republic of Ireland: 1850 502 200

Whether you have just one or a number of Hotpoint appliances in your kitchen, we offer two service cover plans to give you total peace of mind.

- Repair Protection Plan - FREE service repairs for a single Hotpoint appliance during the period of cover.
- Kitchen Cover - FREE service repairs for all your Hotpoint appliances less than 8 years old.

Genuine Parts and Accessories UK: 08709 077 077

www.theservicecentre.co.uk

Republic of Ireland: (01) 842 6836

A wide range of genuine parts and accessories are available from our hotline or through our web site.

Genuine parts and accessories, extended warranties and service repairs are all available on our web-site at:



www.theservicecentre.co.uk





Guarantee

"Satisfaction guaranteed or your money back"

We give you a unique 'satisfaction guaranteed' promise - **valid for 90 days** - after you have purchased your Hotpoint appliance. If there is a technical problem simply call Hotpoint Repair service or visit our web-site at www.theservicecentre.co.uk and where necessary, we will arrange for an engineer to call. If the technical problem is not resolved under this guarantee, **we will replace your machine or, if you prefer, give you your money back.**

All Hotpoint appliances carry a fully inclusive 12 month parts and labour guarantee as well as free replacement parts for the first 5 years (except microwaves, selected integrated appliances and cooker hoods, which have a one year guarantee) provided that they are fitted by a Hotpoint engineer.

Guarantee terms and conditions

Your guarantee is only applicable in the United Kingdom or Republic of Ireland and is subject to the following provisions that your appliance:

- Has been installed and used correctly in accordance with this instruction booklet.
- Has been used solely for domestic purposes and is located on domestic premises (ie. not for commercial or trade use).
- Has been properly connected to a suitable electrical supply voltage as stated on the appliance rating plate.
- Has not been subject to misuse, accident, modified or repaired by anyone other than one of our own service engineers.

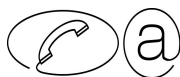

For pre purchase information on any other Hotpoint product call: 08701 50 60 70
or visit: www.hotpoint.co.uk



Recycling & Disposal Information

As part of Hotpoint's continued commitment to helping the environment, Hotpoint reserves the right to use quality recycled components to keep down customer costs and minimise material wastage.

Please dispose of packaging and old appliances carefully.

To minimise risk of injury to children, remove the door, plug and cut mains cable off flush with the appliance. Dispose of these parts separately to ensure that the appliance can no longer be plugged into a mains socket, and the door cannot be locked shut.



Key Contacts

After Sales Service

Over 1200 trained specialists, directly employed by us, ensure that you can have complete confidence in both the appliances and services we offer.



Repair Service and Information Desk

UK: 08709 066 066

(Open 8 to 8 Mon - Fri, 8 to 6 Sat, 10 to 4 Sun & Bank Holidays)

www.theservicecentre.co.uk

Republic of Ireland: 1850 302 200

Note: Our operators will require the following information:

Model number:

Serial number:

Extended Warranties

UK: 08709 088 088

(Open 8 to 8 Mon - Sun)

www.theservicecentre.co.uk

Republic of Ireland: 1850 502 200

Genuine Parts and Accessories

UK: 08709 077 077

(Open 8-30 to 5-30 Mon - Fri & 9 to 12 Sat)

www.theservicecentre.co.uk

Republic of Ireland: (01) 842 6836

Free Manuals Download Website

<http://myh66.com>

<http://usermanuals.us>

<http://www.somanuals.com>

<http://www.4manuals.cc>

<http://www.manual-lib.com>

<http://www.404manual.com>

<http://www.luxmanual.com>

<http://aubethermostatmanual.com>

Golf course search by state

<http://golfingnear.com>

Email search by domain

<http://emailbydomain.com>

Auto manuals search

<http://auto.somanuals.com>

TV manuals search

<http://tv.somanuals.com>