



kitchen think

Instructions for Installation and Use

**Dual Fuel Cooker
Model EG600X**

To the Installer

**Before installation fill in the product details on the back cover of this book.
The information can be found on the rating plate.**

To the User

**You must read the instructions prior to installing and using the appliance and
then retain them for future reference.**

CONTENTS

Introduction	3
For Your Safety	4
Know your Cooker	5
How to use your Hob	6
How to use your Oven	7
Know your Timer	8
Cooking Advice	9
Cooking Chart	10
Care and Cleaning	11
Troubleshooting	12
Installation	13-14
Electrical Connection	15
Burner and Nozzle Specifications and Oven Specifications	16
After Sales Service	18
Hotpoint Guarantee	19
Key Contacts	Back Cover

Retention of this Instruction Book

This Instruction Book must be kept handy for reference as it contains important details on the safe and proper use of the appliance.

If you sell or pass the appliance to someone else, or move house and leave it behind, make sure this Book is also provided so the new owner can become familiar with the appliance and safety warnings.

If the Book is lost or damaged a copy may be obtained from:
GDA LTD., Morley Way, Peterborough, PE2 9JB

INTRODUCTION

Your new dual fuel cooker is guaranteed* and will give lasting service. This guarantee is only applicable if the appliance has been installed in accordance with the installation instructions detailed in this booklet.

To help make best use of your cooking equipment, please read this booklet carefully.

The appliance is designed specifically for domestic use and responsibility will not be accepted for use in any other installation.

Note: When the appliance is first used, an odour may be omitted - this will cease after a short period of use.

To help remove the 'new' smell, heat the empty oven to maximum temperature for a minimum of two to three hours, keeping the door closed. Ensure that the room is well ventilated (eg. open a window or use an extractor fan) and that persons who may be sensitive to the odour avoid any fumes. It is suggested that any pets be removed from the room until the smell has ceased.

This odour is due to any temporary finish on oven linings and elements and any moisture absorbed by the insulation.

*** The guarantee is subject to the provisions that the appliance:**

- (a) Has been used solely in accordance with this booklet.**
- (b) Has been properly connected to a suitable supply voltage as stated on the rating plate, attached to the appliance.**
- (c) Has not been subjected to misuse or accident or been modified or repaired by any person other than the manufacturers authorised employee or agent.**
- (d) Has been correctly installed.**

IMPORTANT INFORMATION

- this appliance has been designed for private, non-professional domestic use in the home.
- read this instruction book carefully, as it provides important advice regarding safe installation, use and maintenance. Keep the instruction book in a safe place for future reference.
- the oven accessories that may come into contact with food are made of materials which comply with the provisions set forth by the EEC Directive 89/109 of 21/12/88 and the applicable national norms in force.
- after removing packaging, check that the appliance is intact. If in doubt, DO NOT use the appliance and contact a qualified serviceman.
- some parts are covered with a removable scratch-proof film. Before using the appliance, the film should be removed and the underlying part cleaned with a cloth and a non-abrasive household cleaning product.
- when switching the appliance on for the first time, we recommend you heat the oven on maximum temperature setting for about 30 minutes with nothing in it, to eliminate any residue from manufacture.
- all installation and adjustment operations should be carried out by a qualified serviceman in accordance with the applicable norms in force. Specific instructions are provided within the installation section of this instruction book.
- before connecting the appliance, make sure that the data on the rating plate (situated underneath the appliance) correspond to the mains electricity and gas supplies.
- check that the capacity of the electrical system and the power outlets are suitable for the maximum power of the appliance (indicated on the rating plate). If in doubt, consult a qualified technical engineer.
- check the condition of the gas pipe regularly and have it replaced by a qualified technical engineer as soon as it shows any signs of wear or anomaly.
- under no circumstances should the user replace the power supply cable of the gas connection pipe of this appliance. In the event of damage or the need for replacement, contact an authorised service centre only (see Key Contacts, back page).
- DO NOT leave the appliance plugged in if it is not in use. Switch off at the mains electrical switch and turn off the gas supply.
- During operation, the oven glass door and adjacent parts of the appliance become hot. Make sure, therefore, that children do not touch the appliance. For greater safety, an additional child-safety device is available from our Head Office and our Authorised Service Centres (see enclosed list). When ordering this, please give the code: BAB - followed by the appliance model. The model is stamped on the rating plate affixed to the rear of the appliance and at the back of this booklet.

FOR YOUR SAFETY

When used properly your appliance is completely safe but as with any electrical product there are certain precautions that must be observed. PLEASE READ THE BELOW PRECAUTIONS BEFORE USING YOUR APPLIANCE.

To maintain the efficiency and safety of this appliance, we recommend you do the following:

- only call the Service Centres authorised by the manufacturer.
- always use genuine spare parts.

ALWAYS:

- make sure you remove all packaging and dispose of safely.
- make sure you understand the controls before using the appliance.
- keep children away from the appliance during use.
- take care to avoid heat/steam burns when operating the controls.
- check the shelves are in the correct position before switching on the oven.
- make sure the controls are turned off when you have finished cooking and when not in use.
- ensure the door is closed when using the grill.
- disconnect from the power supply, and allow to cool, before cleaning or performing any maintenance.
- keep the door closed when the appliance is not in use.
- refer servicing to a qualified appliance service engineer.
- keep the appliance clean as a build up of grease or fat from cooking can cause a fire.
- follow the basic principles of food handling and hygiene to prevent the possibility of bacterial growth.
- keep any ventilation slots clear of obstructions.
- grip the handle in the centre when opening the door.
- stand back when opening the door to allow any build up of steam or heat to disperse.
- use dry, good quality oven gloves when removing items.
- dry food thoroughly before frying and lower it slowly into the hot oil or fat. Frozen food in particular, will cause frothing and spitting if added too quickly.
- keep outside of pans clean and free from streaks of oil or fat.
- place pans centrally over the cooking areas making sure handles are kept away from the edge of the hob and cannot be heated by other heating areas/pans.

SAFETY ADVICE

IMPORTANT - As with any cooking appliance there could be some fire risk attached to the heating of oil, particularly for deep fat frying. Cooking utensils containing oil must not be left unattended (eg. to answer the telephone) on or in close proximity to the cooking areas.

IN THE EVENT OF A CHIP PAN OR ANY OTHER PAN FIRE:

1. Turn off the burners.
2. Cover the pan with a fire blanket or damp cloth, this will smother the flames and extinguish the fire.
3. Leave the pan to cool for at least 60 minutes before moving it. Injuries are often caused by picking up a hot pan and rushing outside with it.

NEVER USE A FIRE EXTINGUISHER TO PUT OUT A PAN FIRE as the force of the extinguisher is likely to tip the pan over. Never use water to extinguish oil or fat fires.

NEVER:

- use steam cleaners.
- attempt to install or repair the appliance without the assistance of qualified personnel.
- store items above the appliance that children may attempt to reach.
- heat up unopened food containers, as pressure can build up causing the container to burst.
- use the appliance to heat up anything other than food.
- use the appliance as a room heater.
- dry any items on the hob.
- install the appliance next to curtains or other soft furnishings.
- allow children to play with or tamper with the controls.
- leave children unsupervised where cooking appliances are installed as all the cooking surfaces get hot during and after use.
- store chemicals, foodstuffs or pressurised containers in or on the appliance, or in cabinets immediately above or next to the appliance.
- use plastic items on or near the appliance.
- use flammable liquids, such as alcohol or gasoline etc. near the appliance when it is in use.
- use adapters, multiple sockets and/or extension leads.
- fill a deep fat frying pan more than 1/3 full of oil, or use a lid on a deep fat frying pan. **DO NOT LEAVE UNATTENDED WHILE COOKING.**
- pull on the appliance or the supply cable to unplug it from the electrical outlet.
- allow power cables of other appliances to come into contact with hot parts of this appliance.
- expose the appliance to atmospheric agents, such as rain or sunlight.
- operate the appliance with wet hands.
- allow anyone to sit or stand on any part of the appliance.
- remove the oven shelves whilst the oven is hot.
- burners and cast iron pan supports remain hot for a long time **DO NOT** touch them.
- use the oven for storage purposes.
- use the grill to warm plates.
- dry items on the oven doors.
- fry too much food at a time, especially frozen food. This only lowers the temperature or the oil or fat too much, resulting in greasy food.
- use misshapen pans which may be unstable.
- use round base woks directly on the gas pan supports.
- use fish kettles or large preserving pans across two gas burners.
- operate the appliance when barefoot.

KNOW YOUR COOKER

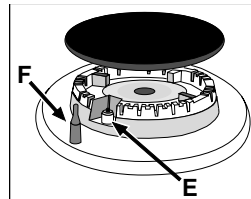
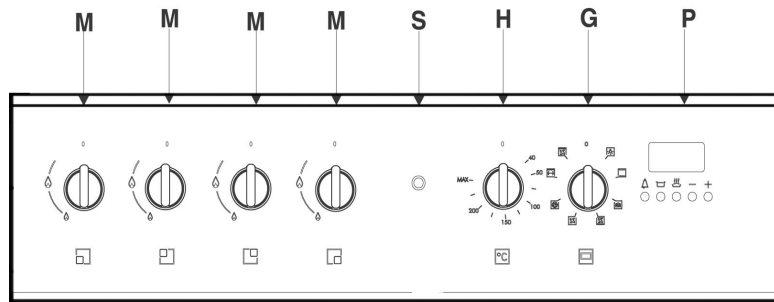

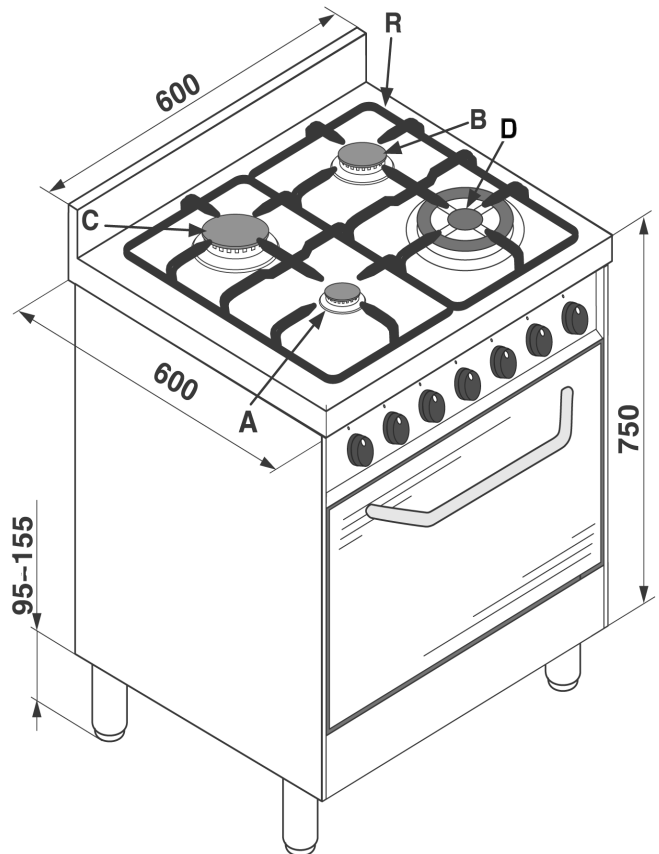

- A Auxiliary gas burner
- B Semi-rapid gas burner
- C Rapid gas burner
- D Triple crown gas burner (wok burner)
- E Ignitor for gas burners
- F Flame Failue Device - Activates if the flame accidentally goes out (spills, drafts, etc.), interrupting the supply of gas to the burner.
- G Function Selector
- H Temperature Selector
- M Control knobs for gas burners
- R Pan support for cookware
- P Timer
- S Electric heating element indicator light



HOW TO USE YOUR HOB

Gas burners

On the control panel, the following symbols are indicated around each knob "M".

Off 
High flame 
Low flame 

The symbols  near the knobs indicate the position of each burner on the hob.

The burners are fitted with a flame failure device. This device interrupts the gas supply should the burner flame go out during operation.

To **light one of the burners**, proceed as follows:

- turn the appropriate control knob anti-clockwise until the pointer is on the high-flame symbol.
- press the knob down fully to activate the automatic gas ignition.
- keep the knob pressed down for about 6 seconds with the flame lit to allow the flame failure device to heat.
- release the knob, checking that the flame is stable. If it is not, repeat the operation.

For minimum power, turn the knob towards the low flame symbol. Intermediate positions are possible by simply setting the knob anywhere between the high and the low flame symbol.

Important:

- Do not activate the automatic ignition device for more than 15 consecutive seconds.
- Difficulty in ignition is sometimes due to air inside the gas duct.
- If a burner flame accidentally goes out, the gas continues to exit for a few moments before the flame failure device is activated. Turn the control knob to the off position and do not attempt ignition again for at least 1 minute, thereby letting the gas disperse, which could otherwise be a danger.
- When the appliance is not in operation, check that all control knobs are set to the off position "●". The main gas supply tap should also be turned off.

Practical advice on using the hob:

To obtain maximum efficiency from the burners, we recommend you only use pans with a diameter suitable for the burner being used, so that the flame does not extend beyond the pan base (see the following table).

When a liquid starts boiling, we recommend you turn the flame down just enough to keep the liquid simmering.

BURNER	∅ Pan Diameter (cm)
A. Auxiliary	6 - 14
B. Semi-rapid	15 - 20
C. Rapid	21 - 26
D. Triple ring	24 - 26

The hob is fitted with a reducing pan stand (shown right) which should only be used on the auxiliary burner 'A'.

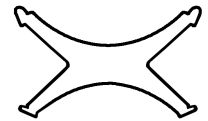

For the best performance of your burners, keep the following in mind:

All types of pans can be used on the burners. The important thing is that the bottom should be completely flat.

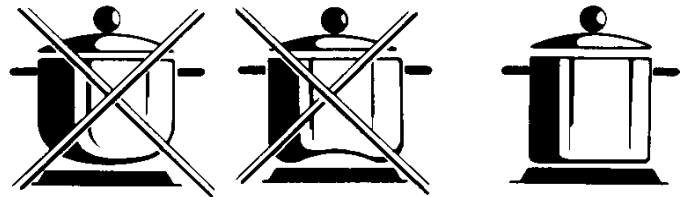

The **'Multi-function'** oven combines the advantages of convection ovens with those of fan assisted models in a single appliance. It is an extremely versatile appliance that allows you to choose easily between 7 different cooking modes. The various cooking modes are selected by means of the function selector **'G'** situated on the control panel:

Interior light

By turning the function selector to  the interior light is switched on and allows you to observe the food in the oven without having to open the door.

Warning: Never place anything on the bottom of the oven when it is in operation because this could damage the enamel. Always place your cookware (dishes, aluminium foil, etc.) on the shelves provided with the appliance inserted along the oven shelf guides.

The Cooking Modes:

The grill

Position the temperature control **"H"** between **40°C** and **Max**. Your oven is equipped with an electric grill. **The extremely high and direct temperature of the grill makes it possible to brown the surface of meats and roasts while locking in the juices to keep them tender. The grill is also highly recommended for dishes that require a high temperature on the surface: such as beef steaks, veal, rib steak, filets, hamburgers etc...**

The grill is controlled by a thermostatic device that regulates its operation.

Important: when using the grill, the oven door must be kept shut.

Convection

Position the temperature control **"H"** between **40°C** and **Max**. The top and bottom heating elements are used. In this mode, the coolest part of the oven is the centre. The convection oven is best for cooking dishes made up of several ingredients, e.g. tender veal strips with rice, braised meats, stews, goulash etc.) and dishes that need to cook slowly and require basting or the addition of liquid and cooking using covered casserole dishes for oven baking. When cooking in convection mode, only use one baking tray or shelf at a time, otherwise the heat distribution will be uneven. Using the different shelf position available, you can balance the amount of heat between the top and the bottom of the oven. Select from among the various shelf positions based on whether the dish needs more or less heat from the top.

Baking

Position the temperature control **"H"**: between **40°C** and **Max**.

The rear heating element and the fan come on, guaranteeing delicate heat distributed uniformly throughout the oven.

This mode is ideal for baking and cooking delicate foods - especially cakes that need to rise - and for the preparation of certain tartlets on more than one shelf at the same time. Here are a few examples: cream puffs, sweet and savoury biscuits, savoury puffs, Swiss rolls and small portions of vegetables au gratin, etc.....

"Fast cooking" Mode

Position the temperature control **"H"**: between **40°C** and **Max**. All the heating elements and the fan come on, guaranteeing constant heat distributed uniformly throughout the oven.

This mode is especially recommended for cooking pre-packed food quickly (as pre-heating is not necessary), such as for example: frozen or pre-cooked food) as well as for a few "home-made" dishes.

The best results when cooking using the "Fast cooking" mode are obtained if you use one cooking shelf only (the second from the bottom), please see the "Cooking Chart".

Multi-cooking Mode

Position the temperature control **"H"**: between **40°C** and **Max**. All the heating elements and the fan, will come on. Since the heat remains constant and uniform throughout the oven, the air cooks and browns food uniformly over its entire surface. With this mode, you can also cook various dishes at the same time, as long as their respective cooking temperatures are the same.

A maximum of 2 shelves can be used at the same time, following the instructions in the section entitled: "Cooking On More Than One Shelf".

This Multi-cooking mode is particularly recommended for dishes requiring a gratin finish or for those requiring considerably prolonged cooking times, such as for example: lasagne, pasta bakes, roast chicken and potatoes, etc...

Moreover, the excellent heat distribution makes it possible to use lower temperatures when cooking roasts. This results in less loss of juices, meat which is more tender and a decrease in the loss of weight for the roast. The Multi-cooking mode is especially suited for cooking fish, which can be prepared with the addition of a limited amount of condiment, thus maintaining their flavour and appearance.

The Multi-cooking mode is also perfect for baking leavened cakes.

Moreover, this mode can also be used to thaw quickly white or red meat and bread by setting the temperature control to 80 °C. Defrosting - this mode can be used to thaw more delicate foods, set the temperature control to 60°C or use only the cold air circulation feature by setting the temperature control to 0°C.

Pizza Mode

Position the temperature control **"H"**: between **40°C** and **Max**. The bottom and circular heating elements, as well as the fan, will come on. This combination rapidly heats the oven due to the large amounts of power used by the appliance (2800 W), which results in the production of considerable heat coming mostly from the bottom.

The pizza mode is ideal for foods requiring high temperatures to cook, like pizzas and large roasts. Only use one baking tray or shelf at a time. However, if more than one is used, these must be switched halfway through the cooking process. Refer to the 'Cooking Advice' section.

Fan grilling

The fan grilling is extremely useful for grilling foods rapidly, as the distribution of heat makes it possible - not only to brown the surface but also to cook the bottom part.

This mode can also be used for browning foods at the end of the cooking process.

This feature allows you to program the oven and the grill to:

- delay start for a specific length of time;
- immediate start for a specific length of time;
- timer.

Button Functions:

 : timer - hours and minutes

 : cooking time





 : end cooking time

 : set cooking time - backward

 : set cooking time - forward

How to reset the digital clock.

After the appliance has been connected to the power supply, or when the power has gone out, the clock display will automatically reset to **0:00** and begin to flash.

- Press the  and  buttons at the same time and then reset the time (within 4 seconds) using the  and  buttons.



The  button sets the time forward.

The  button sets the time backward.

Whenever the time needs to be reset, repeat all of the steps listed above.

Manual operation of the Oven



After resetting the time, the program automatically switches to the manual mode.

Note: To reset to manual mode after each "automatic" cooking, Press the  and  buttons at the same time

Preset cooking time with delayed start



The length of the cooking program as well as the time at which the cooking program ends must be set.

If we assume that the time displayed on the timer is 10:00

1. Turn the function selector to the required cooking mode and turn the temperature selector to the desired temperature (e.g. conventional oven, 200°C);
2. Press the  button and then set the cooking time (within four seconds) using the  and  buttons. Let us suppose that we set the cooking time at 30 minutes. The display will read as follows:

A 

Release the button and after 4 seconds, the current time will be displayed again, along with the  symbol and the letter "A" (AUTO);



3. Press the  button and then use the  and  buttons to set the time for when the cooking program should end. Let us suppose this time to be 1p.m.



A 

4. After the button has been released, the current time will be displayed after approximately 4 seconds:

A 

The letter "A" will light up reminding you that the length and end cooking time were programmed in automatic mode. At this point, the oven will turn on automatically at 12:30 and then turn off after 30 minutes. When the oven is turned



on, the  symbol will be displayed for the entire cooking time. At any time during the cooking process, the length of the cooking time can be displayed by pressing the  button, and the end cooking time by pressing the  button.

At the end of cooking time, a buzzer will sound for several minutes, to turn it off, simply press any of the buttons except the  and  buttons.

Preset cooking time with immediate start

By programming just the duration (points 1 and 2 of the "Start delayed cooking with preset duration" section), cooking will start up immediately.

To cancel a preset cooking time



Press the  and  buttons at the same time.

Timer Feature



The timer feature allows you to enter a given amount of time from which the timer begins to count down. This feature does not turn the oven on or off, it only emits an alarm when the time has expired.

When the  button has been pressed, the display will read as follows:





Then use the  and  buttons to set the desired time. After the button has been released, the timer will start to count down and the current time will be displayed.





After the time has expired, an alarm will sound, which can be turned off by pressing any of the buttons (except the  and  buttons) at this point the  symbol will turn off.

Changing and cancellation settings

- The data entered can be changed at any time by pressing the corresponding button and the  and  buttons.
- When the data for the length of the cooking time is cancelled, the data for the end cooking time are also cancelled automatically, and vice versa.
- If the oven has been programmed, it will not accept end cooking times which are before the start of the cooking process.

The oven offers a wide range of alternatives which allows you to cook any type of food in the best possible way. With time you will learn to make the best use of this versatile cooking appliance and the following are only a guide, which may be varied according to your own personal taste.

Cooking on More Than One Shelf

If you have to cook food on several shelves, use either the “baking” mode  or the  “Multi-cooking” mode, as these are the only modes that allow you to do so.

When cooking delicate food on more than one shelf, use the “baking” mode,  which allows you to cook on 3 shelves at the same time (the 1st, 3rd and 5th from the bottom).

Some examples are included in the “Cooking Chart”.

When cooking other food on several shelves, use the “Multi-cooking” mode  keeping the following suggestions in mind:

- The oven is fitted with 5 shelf positions. During fan assisted cooking, use two of the three central shelf positions: the lowest and highest shelves receive the hot air directly and therefore delicate foodstuffs could be burnt using these shelf positions.
- As a general rule, use the 2nd and 4th shelf position from the bottom, placing the foodstuffs that require greater heat on the 2nd shelf from the bottom. For example, when cooking meat roasts together with other food, place the roast on the 2nd shelf position from the bottom and the more delicate food on the 4th shelf position from the bottom.
- When cooking food that require differing times and temperatures, set a temperature that is somewhere between the two temperatures required, place the more delicate food on the 4th shelf position from the bottom and take the food requiring less time out of the oven first.
- Use the baking tray on the lower shelf position and the shelf on the upper position.

Baking Cakes

When baking cakes, always preheat the oven. Make sure you wait until the oven has preheated thoroughly. Do not open the oven door during baking to prevent the cake from dropping. In general, if:

Pastry is too dry
Increase the temperature by 10°C and reduce the cooking time.
Pastry has dropped
Use less liquid or lower the temperature by 10°C.
Pastry is too dark on top
Place it on a lower shelf, lower the temperature, and increase the cooking time.
It is cooked well on the inside but sticky on the outside
Use less liquid, lower the temperature, and increase the cooking time.

The pastry sticks to the pan
Grease the pan well and sprinkle it with a dusting of flour or use greaseproof paper.
You used more than one shelf (in the fan assisted oven mode) and they are not all at the same cooking point.
Use a lower temperature setting. It is not necessary to remove the food from all the shelves at the same time.

Using the 'Fast Cooking' mode

Functional, fast and practical for those of you who use frozen or pre-cooked food along with other food items. You will find useful suggestions in the 'Cooking Chart'.

Cooking Fish and Meat

When cooking white meat, fowl and fish, use temperature settings from 180 °C to 200 °C.

For red meat that should be well done on the outside while tender and juicy in the inside, it is a good idea to start with a high temperature setting (200°C-220°C) for a short time, then turn the oven down afterwards.



In general, the larger the roast, the lower the temperature setting. Place the meat on the centre of the shelf and place the grill pan/baking tray beneath it to catch the fat.

Make sure that the shelf is inserted so that it is in the centre of the oven. If you would like to increase the amount of heat from below, use the low shelf positions.

Cooking Pizza

For best results when cooking pizza, use setting  for “**Pizza Mode**”:

- Preheat the oven for at least 10 minutes
- Use a light aluminium pizza pan, placing it on the shelf supplied with the oven. If the baking tray is used, this will extend the cooking time, making it difficult to get a crispy crust;
- Do not open the oven door frequently while the pizza is cooking;
- If the pizza has a lot of toppings (three or four), we recommend you add the mozzarella cheese on top halfway through the cooking process.
- If cooking on more than one shelf (up to 2), we advise

you to use the Multi-cooking Mode  as the Pizza Mode  would heat the bottom shelf more than the others.

Cooling ventilation







In order to cool down the exterior of the appliance, it is fitted with a cooling fan that comes on when the function selector “G” is turned. In this case, the fan is always on and a normal flow of air can be heard exiting between the oven door and the control panel.

Note: when cooking is finished, the fan stays on until the oven has cooled down sufficiently, even if the function selector “G” is set to “0”.

In "Fast cooking" mode, the fan comes on automatically only when the oven is hot.

Once you have removed the food from the oven, we recommend you leave the oven door ajar for a few minutes, this will drastically reduce the duration of the cooling cycle. The process is controlled by an additional thermostat and can consist of one or more cycles.

COOKING CHART

Cooking Function	Type of food	Weight (in kg)	Shelf position from bottom of the oven	Preheating time (minutes)	Temp °C	Cooking time (minutes)
1. Convection 	Duck	1	3	15	200	65-75
	Roast Veal or Beef	1	3	15	200	70-75
	Pork Roast	1	3	15	200	70-80
	Biscuits (short pastry)	-	3	15	180	15-20
	Tarts	1	3	15	180	30-35
2. Baking 	Tarts	0.5	3	15	180	20-30
	Fruit cakes	1	2/3	15	180	40-45
	Plum cake	0.7	3	15	180	40-50
	Sponge cake	0.5	3	15	160	25-30
	Stuffed pancakes (on 2 shelves)	1.2	2-4	15	200	30-35
	Small cakes (on 2 shelves)	0.6	2-4	15	190	20-25
	Cheese puffs (on 2 shelves)	0.4	2-4	15	210	15-20
	Cream puffs (on 3 shelves)	0.7	1-3-5	15	180	20-25
	Biscuits (on 3 shelves)	0.7	1-3-5	15	180	20-25
	Meringues (on 3 shelves)	0.5	1-3-5	15	90	180
3. Fast Cooking 	Frozen Food					
	Pizza	0.3	2	-	Max	12
	Courgette and prawn pie	0.4	2	-	200	20
	Country style spinach pie	0.5	2	-	220	30-35
	Turnovers	0.3	2	-	200	25
	Lasagne	0.5	2	-	200	35
	Golden rolls	0.4	2	-	180	25-30
	Chicken morsels	0.4	2	-	220	15-20
	Pre-cooked Food					
	Golden Chicken wings	0.4	2	-	200	20-25
	Fresh Food					
	Biscuits (short pastry)	0.3	2	-	200	15-18
	Plum Cake	0.6	2	-	180	45
Cheese Puffs	0.2	2	-	210	10-12	
4. Multi-Cooking 	Pizza (on 2 shelves)	1	2-4	15	230	15-20
	Lasagne	1	3	10	180	30-35
	Lamb	1	2	10	180	40-45
	Roast Chicken and Potatoes	1+1	2-4	15	200	60-70
	Mackerel	1	2	10	180	30-35
	Plum Cake	1	2	10	170	40-50
	Cream Puffs (on 2 shelves)	0.5	2-4	10	190	20-25
	Biscuits (on 2 shelves)	0.5	2-4	10	180	10-15
	Sponge Cake (on 1 shelf)	0.5	2	10	170	15-20
	Sponge Cake (on 2 shelves)	1	2-4	10	170	20-25
Savoury pies	1.5	3	15	200	25-30	
5. Pizza 	Pizza	0.5	3	15	220	15-20
	Roast Veal or Beef	1	2	10	220	25-30
	Chicken	1	2/3	10	180	60-70
6. Grill 	Sole	1	4	-	5	8-10
	Squid and prawn kebabs	1	4	-	5	6-8
	Cod fillet	1	4	-	5	10
	Grilled vegetables	1	3/4	-	5	10-15
	Veal steak	1	4	-	5	15-20
	Cutlets	1	4	-	5	15-20
	Hamburgers	1	4	-	5	7-10
	Mackerels	1	4	-	5	15-20
	Toasted sandwiches	No.4	4	-	5	2-3

N.B.: The cooking times shown in this chart are approximate and may vary according to personal taste.

CARE AND CLEANING

Before cleaning or carrying out any maintenance on your appliance, you must disconnect it from the power supply.

To extend the life of your appliance, it must be cleaned frequently, keeping in mind that:

The hob:

- The enamelled parts must be washed with warm water without using any abrasive powders or corrosive substances which could cause damage.
- The removeable parts of the burners should be washed with warm soapy water, making sure to remove caked on substances.
- The end of the electronic ignition device must be cleaned carefully and frequently, making sure that the gas holes are not clogged.
- Stainless steel may become marked if it comes into contact with very hard water or harsh detergents (containing phosphorous) for long periods of time. After cleaning, rinse with water and dry thoroughly. Use a specific non-abrasive product to remove tougher stains. It is also recommended that any spills be cleared immediately.

Inside the oven

We recommend you clean your oven each time you use it, especially after cooking roasts. In fact, it is advisable to prevent food residue from building up during cooking: the residue would be re-cooked each time the oven is used and would char and release smoke and unpleasant odours.

Oven exterior

Clean the stainless steel exterior surfaces of your oven using a sponge soaked in soapy water, making sure you rinse and dry these thoroughly, without using abrasive or corrosive products which could damage them.

DO NOT use aluminium foil to line the bottom of the oven.

To avoid having to clean the bottom of the oven, you may be tempted to line it with some aluminium foil. We strongly advise against this. The aluminium foil sheet in direct contact with the heated enamel coating could melt and damage the enamel coating inside the oven irreversibly.

Oven rubber Seal

There is a rubber seal surrounding the oven opening which guarantees its perfect functioning. Check the condition of this seal on a regular basis. If necessary, clean it using warm water and dry thoroughly.

DO NOT use abrasive products or objects to do so.

Should the seal become damaged, please contact Hotpoint Service (see KEY CONTACTS, back page). We recommend you avoid using the oven until it has been repaired.

Replacing the Oven Lamp

- Disconnect from the mains electricity supply and ensure the appliance is cool.
- Remove the glass cover of the lamp-holder.
- Remove the lamp and replace with a lamp resistant to high temperatures (300°C) with the following characteristics:
 - Voltage: 230/240 V
 - Power: 15W
 - Type E14
- Replace the glass cover and reconnect to the mains electricity supply.

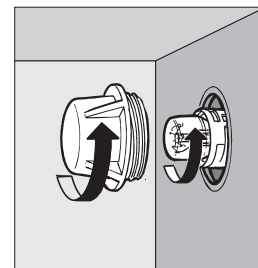

Disassembling/assembling the oven door

To make it easier to clean the inside of your oven, the oven door can be removed, by proceeding as follows (fig. 3-4):

- Open the door completely and raise the 2 levers "B" (fig. 3);
- Now, shutting the door slightly, you can lift it out by pulling out the hooks "A" as shown in figure 4.

To **reassemble** the door:

- With the door in a vertical position, insert the two hooks "A" into the slots;
- Ensure that seat "D" is hooked perfectly onto the edge of the slot (move the oven door backwards and forward slightly);
- Keep the oven door open fully, unhook the 2 levers "B" downwards and then shut the door again.

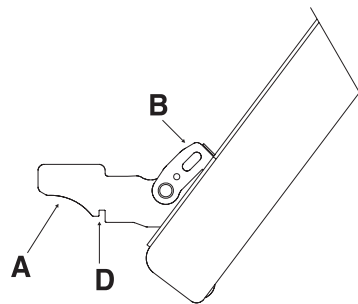

fig 3

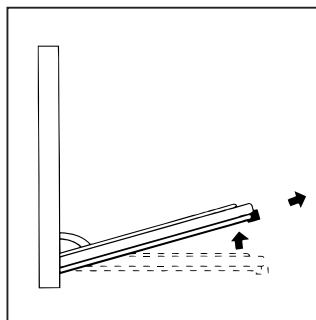

fig 4

Troubleshooting

Before calling service for assistance, check through the following list, there may be nothing wrong.

First of all, check to see that there are no interruptions in the gas and electrical supplies, and, in particular, that the gas valves for the mains are open.

If the burner does not light or the flame is not uniform around the burner.

Check to make sure that:

- The gas holes on the burner are not clogged.
- All of the movable parts that make up the burner are mounted correctly.
- There are no draughts around the cooking surface.

If the flame does not stay lit.

Check to make sure that:

- You press the knob all the way in.
- You keep the knob pressed in long enough to activate the flame failure device.
- The gas holes are not clogged in the area corresponding to the flame failure device.

If the burner does not remain on when set to "Low".

Check to make sure that:

- The gas holes are not clogged.
- There are no draughts near the cooking surface.
- The minimum has been adjusted correctly (see Installation section, "Minimum Regulation").

If the cookware is not stable.

Check to make sure that:

- The bottom of the cookware is perfectly flat.
- The cookware is centered correctly on the burner .
- The support grids have not been inverted.

If your oven releases a lot of smoke during cooking.

Check to make sure that:

- You have selected the correct cooking mode for the type of food and the dish is in the correct recommended shelf position.
- The temperature is correct for the type of cooking required.
- The oven interior is clean. Food residue encrusted onto the enamel coating inside the oven becomes charred and creates both smoke and odours.
- Dish is placed onto baking tray, splashes of grease or overflows onto very hot surfaces create smoke.

If, despite all of these checks, the cooker does not function properly and problem persists, call Hotpoint Service (see KEY CONTACTS, back page), informing them of:

- The type of problem.
- The abbreviation used to identify the model (Mod. ...) as indicated on the warranty.

IMPORTANT:

Never call upon technicians not authorized by the manufacturer, and refuse to accept spare parts that are not original.

INSTALLATION

The following instructions are provided for qualified installers so that they may carry out installation, adjustment and technical maintenance operations correctly and in compliance with the applicable norms in force.

Important: Disconnect the appliance from the electrical and gas supply before performing any maintenance or repair.

The cooker has the following technical specifications:

- Cat. II2H3+

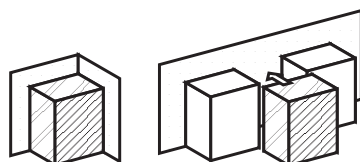

Class 1 Class 2 sub-class 1

The dimensions of the appliance are given in the figure on page 5, 'KNOW YOUR COOKER'. For trouble-free operation of appliances installed in furniture cabinets, the minimum distances shown in fig. 5 should be observed. Adjacent surfaces and the wall at the rear should also be able to withstand a temperature rise of 65 °C.

fig.5

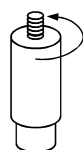
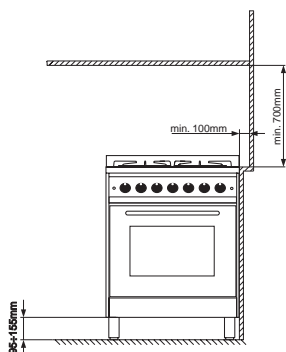

fig.6

Prior to installing the cooker, the 95 - 155 mm high supporting feet (provided) should be fitted into the holes to be underneath the cooker (fig. 6). These feet are screw-adjustable and whenever necessary should be used to make sure the cooker is level.

Positioning

This appliance may only be installed and operated in permanently ventilated rooms in compliance with the regulations in force. The following requirements must be observed:

- The appliance must vent flue gases into a special hood, which must be connected to a chimney, flue pipe or directly to the outside (fig. 7).
- If it is impossible to fit a hood, the use of an electric fan is permitted, either installed on a window or on an external wall, which must be switched on at the same time as the appliance.

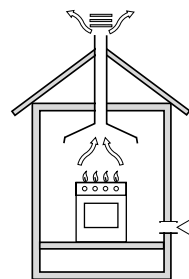

In a chimney stack or branched flue
(reserved for cooking appliances)

fig.7

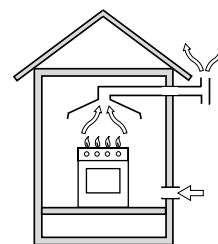

Directly to the outside

Kitchen ventilation

The air flow into the room where the appliance is installed must equal the quantity of air that is required for regular combustion of the gas and for ventilating the same room. Air must enter naturally through permanent apertures made in the outside walls of the room or through single or branching collective ventilation ducts in compliance with the norms. The air must be taken directly from the outside, from an area far from sources of pollution. The ventilation aperture must have the following characteristics (fig. 8A):

- total free cross section of passage of at least 6 cm² for every kW of rated heating capacity of the appliance, with a minimum of 100 cm² (the heating capacity is indicated on the rating plate);
- it must be made in such a way that the aperture, both on the inside and outside of the wall, cannot be obstructed;
- it must be protected, e.g. with grates, wire mesh, etc. in such a way that the above-mentioned free section is not reduced;
- it must be situated as near to floor level as possible.

Detail A

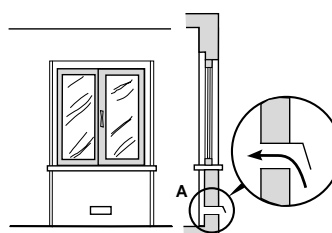

Examples of ventilation
holes for comburant air

fig. 8A

Adjacent room Room to be ventilated

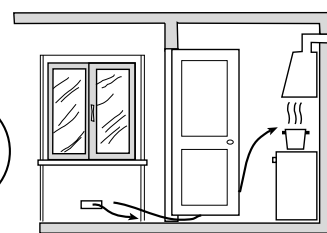

Enlarging the ventilation slot
between window and floor

fig.8B

The air inflow may also be obtained from an adjoining room, provided the latter is not a bedroom or a room where there is a risk of fire, such as warehouses, garages, fuel stores, etc. and is ventilated in compliance with the norms. The air flow from the adjoining room to the one to be ventilated may pass freely through permanent apertures with a cross section at least equal to that indicated above. These apertures may also be obtained by increasing the gap between the door and the floor (fig. 8B). If an electric fan is used for extracting the combustion products, the ventilation aperture must be increased in relation to its maximum performance. The electric fan should have a sufficient capacity to guarantee an hourly exchange of air equal to 3 ÷ 5 times the volume of the kitchen. Prolonged, intensive use of the appliance may require extra ventilation,

INSTALLATION

e.g. an open window or a more efficient ventilation system by increasing the extraction power of the electric fan if installed. Liquid petroleum gas descends towards the floor as it is heavier than air. Apertures in the outside walls in rooms containing LPG cylinders should therefore be at floor level, in order to allow any gas from leaks to be expelled. Do not store LPG cylinders (even when empty) in basements or rooms below ground level; it is advisable to keep only the cylinder in use in the room at any one time and connected far from heat sources which could raise its temperature to above 50 °C.

Gas connection for the gas hob

The hob should be connected to the gas supply by a CORGI registered installer. During installation of this product it is essential to fit an approved gas tap to isolate the supply from the appliance for the convenience of any subsequent removal or servicing. Connection of the appliance to the gas mains or liquid gas must be carried out according to the prescribed regulations in force, and only after it has been ascertained that it is adaptable to the type of gas to be used. If not, follow instructions indicated in the paragraph headed, 'Adapting to different types of gas'.

In the case of connection to liquid gas, in a cylinder, a pressure regulator, that conform to the regulations in force, must be inserted.

Important: for safety, for the correct regulation of gas use and long life of the appliance, ensure that the gas pressure conforms to the indications given in table 1, 'Burner and Nozzle Specifications'.

Connection to non-flexible tube (copper or steel)

Connection to the gas source must be done in such a way as to not create any stress points at any part of the appliance. The appliance is fitted with an adjustable, 'L' shaped connector and a gasket for the attachment to the gas supply. Should this connector have to be turned, the gasket must be replaced (supplied with the appliance).

The feeding connector of the gas to the appliance is threaded 1/2 gas male cylinder.

Connection to flexible steel tube

The gas feed connector to the appliance is a threaded, male 1/2" connector for round gas pipe. Only use pipes and sealing gaskets that conform to the standards currently in force.

- it should be as short as possible, with a maximum length of 1.5 metres;
- it should not be bent or kinked;
- it should not be in contact with the rear panel of the appliance or in any case with parts which may reach a temperature of 50°;
- it should not pass through holes or slits used for discharging the oven flue gases;
- it should not come into contact with pointed parts or sharp corners;
- it should be easy to inspect along its entire length in order to be able to check its condition;
- it should be replaced before the date printed on the actual pipe.

Check the seal

Upon completion of installation, check for leaks from the gas circuit using a soapy water solution (never use a flame). Make sure that the natural gas pipe is adequate for a sufficient supply to the appliance when all the burners are lit.

Adapting to different types of gas (instructions for the hob)

To adapt the hob to a different type of gas from the factory-set one (indicated on the rating plate at the top of the hood or on the packaging), the burner nozzles should be replaced as follows:

- Remove the pan supports and slide the burners off their seats.
- Unscrew the nozzles (fig. 9, using a 7 mm socket spanner and replace them with nozzles for the new type of gas (see table 1 "Burner and nozzle specifications").
- Reassemble the parts following the above procedure in the reverse order.
- On completion of this operation, replace the old rating label with the one indicating the new type of gas used. This sticker is available from Hotpoint Service (see KEY CONTACTS, back page).

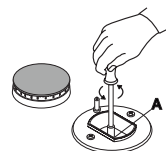

fig.9

Adjusting the primary air of the burners

The primary air of the burners does not need to be adjusted.

Adjusting the low flame

- Turn the tap to the low flame position;
- Remove the knob and turn the adjusting screw, situated to the right of the tap (fig. 10) until you obtain a regular small flame, using a screwdriver (loosening the screw increases the height of the flame, tightening decreases it).

N.B.: In the case of liquid gas, the regulation screw must be screwed in all the way.

- Having obtained the low flame setting required and with the burner lit, change the position of the knob several times from minimum to maximum and vice versa and check that the flame does not go out.
- In appliances fitted with the safety device (thermocouple), should the device fail to work with the burners set to the low flame setting, increase the low flame setting of the same on the adjusting screw.

Once the adjustment has been made, remount the seals on the by-passes using leak detection fluid.

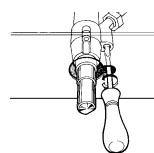

fig.10

Those ovens equipped with a three-pole power supply cable are designed to operate with an alternating current with the voltage and frequency indicated on the data plate (located on the appliance) and in the instruction booklet.

WARNING: THIS APPLIANCE MUST BE EARTHED.

The wire for earthing the appliance is yellow-green in colour.



The appliance should be installed by a qualified electrician in accordance with the latest edition of the IEE regulations.

Fitting on a power supply cable

Opening the terminal board:

- Using a screwdriver, press on the side tabs on each side of the terminal board cover.
- Pull open the cover of the terminal board.

To mount the power supply cable, proceed as follows:

- Remove the wire clamp screw and the three contact screws L-N- 
- Fasten the wires beneath the screwheads using the following colour scheme:
Blue (N) Brown (L) Yellow-Green 
- Secure the supply cable in place with the clamp and close the cover of the terminal board.

Connecting the supply cable to the mains

The appliance must be connected to a double pole isolating switch having a minimum contact separation of 3 mm.

The supply cable must be in such a position that no part of it can reach a temperature of 50°C above room temperature.

Before connecting to the power supply, make sure that:

- The electrical safety of this appliance can only be guaranteed if the cooker is correctly and efficiently earthed, in compliance with regulations on electrical safety. Always ensure that the earthing is efficient; if you have any doubts call in a qualified technician to check the system. The manufacturer denies all responsibility for damage resulting from a system which has not been earthed.
- Before plugging the appliance into the mains, check that the specifications indicated on the rating plate (on the appliance and packaging) correspond to those of the electrical and gas mains of your home.
- Check that the electrical capacity of the system and sockets will support the maximum power of the appliance, as indicated on the data plate. If in doubt, consult a qualified technical engineer.
- If the socket and appliance plug are not compatible, have the socket replaced with a suitable model by a qualified technical engineer. The latter, in particular, will also have to ensure that the cross section of the socket cables are suitable for the power absorbed by the appliance. The use of adapters, multiple sockets and/or extensions, is not recommended. If their use cannot be avoided, remember to use only single or multiple adapters and extensions which comply with current safety regulations. In these cases, never exceed the maximum current capacity indicated on the single adapter or extension and the maximum power indicated on the multiple adapter. **The plug and socket must be easily accessible.**

BURNER AND NOZZLE SPECIFICATIONS

Table 1

BURNER	Diameter (mm)	Thermal Power kW (H.s.)*		Liquid gas				Natural gas	
		Nominal	Reduced	By-pass 1/100 (mm)	Nozzle 1/100 (mm)	Flow * g/h		Nozzle 1/100 (mm)	Flow * l/h
						G30	G31		
C. Rapid	100	3.00	0.7	40	86	218	214	116	286
B. Semi-rapid	75	1.65	0.4	30	64	120	118	96	157
A. Auxiliary	55	1.0	0.3	27	50	73	71	71	95
D. Triple Ring	130	3.25	1.3	57	91	236	232	124	309
Supply pressures		Nominal (mbar)				28-30	37		20
		Minimum (mbar)				20	25		17
		Maximum (mbar)				35	45		25

* At 15°C and 1013 mbar-dry gas
 Propane P.C.S. = 50.37 MJ/Kg
 Butane P.C.S. = 49.47 MJ/Kg
 Natural P.C.S. = 37.78 MJ/m³



This appliance conforms to the following European Economic Community directives:

- 73/23/EEC of 19/02/73 (Low Voltage) and subsequent modifications;
- 89/336/EEC of 03/05/89 (Electromagnetic Compatibility) and subsequent modifications;
- 90/336/EEC of 29/06/90 (Gas) and subsequent modifications;
- 93/68/EEC of 22/07/93 and subsequent modifications.

OVEN SPECIFICATIONS

Inner Volume of the ELECTRIC Oven:

56 litres

Voltage and Frequency of Power Supply:

230V ~ 50Hz 2800W



After Sales Service

"No company is better positioned to offer an after sales service on a Hotpoint appliance than us - the manufacturer"

As part of our commitment to you, all Hotpoint appliances have the added benefit of a fully inclusive parts and labour guarantee for the first 12 months. In addition to this you also have the advantage of **free replacement parts for the first 5 years** when fitted by a Hotpoint engineer.

When the 12 months parts and labour guarantee expires we offer the following after sales service options:

Repair Service and Information Help Desk

UK: 08709 066066

www.theservicecentre.co.uk

Republic of Ireland: 1850 302 200

Note: Our operators will require the Model number and the Serial number of your appliance

Available 364 days a year with a fast, effective and value for money service. We have the largest white goods repair service in the UK with over 1200 of our own fully trained engineers. All repairs include a parts and labour guarantee for 12 months from the date of the repair.

If you require any information or have any questions about your appliance, our operators are on hand with help and advice.

All this ensures that you will receive the best available after sales service possible.

Extended Warranties

UK: 08709 088 088

www.theservicecentre.co.uk

Republic of Ireland: 1850 502 200

Whether you have just one or a number of Hotpoint appliances in your kitchen, we offer two service cover plans to give you total peace of mind.

- Repair Protection Plan - FREE service repairs for a single Hotpoint appliance during the period of cover.
- Kitchen Cover - FREE service repairs for all your Hotpoint appliances less than 8 years old.

Genuine Parts and Accessories UK: 08709 077 077

www.theservicecentre.co.uk

Republic of Ireland: (01) 842 6836

A wide range of genuine parts and accessories are available from our hotline or through our web site.

Genuine parts and accessories, extended warranties and service repairs are all available on our web-site at:



www.theservicecentre.co.uk



Guarantee

"Satisfaction guaranteed or your money back"

We give you a unique 'satisfaction guaranteed' promise - **valid for 90 days** - after you have purchased your Hotpoint appliance. If there is a technical problem simply call Hotpoint Repair service or visit our web-site at www.theservicecentre.co.uk and where necessary, we will arrange for an engineer to call. If the technical problem is not resolved under this guarantee, **we will replace your machine or, if you prefer, give you your money back.**

All Hotpoint appliances carry a fully inclusive 12 month parts and labour guarantee as well as free replacement parts for the first 5 years (except microwaves, selected integrated appliances and cooker hoods, which have a one year guarantee) provided that they are fitted by a Hotpoint engineer.

Guarantee terms and conditions

Your guarantee is only applicable in the United Kingdom or Republic of Ireland and is subject to the following provisions that your appliance:

- Has been installed and used correctly in accordance with this instruction booklet.
- Has been used solely for domestic purposes and is located on domestic premises (ie. not for commercial or trade use).
- Has been properly connected to a suitable electrical supply voltage as stated on the appliance rating plate.
- Has not been subject to misuse, accident, modified or repaired by anyone other than one of our own service engineers.

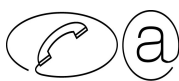

For pre purchase information on any other Hotpoint product call: 08701 50 60 70
or visit: www.hotpoint.co.uk



Recycling & Disposal Information

As part of Hotpoint's continued commitment to helping the environment, Hotpoint reserves the right to use quality recycled components to keep down customer costs and minimise material wastage.

Please dispose of packaging and old appliances carefully.

To minimise risk of injury to children, remove the door, plug and cut mains cable off flush with the appliance. Dispose of these parts separately to ensure that the appliance can no longer be plugged into a mains socket, and the door cannot be locked shut.





Key Contacts

After Sales Service

Over 1200 trained specialists, directly employed by us, ensure that you can have complete confidence in both the appliances and services we offer.



Repair Service and Information Desk

UK: 08709 066 066

(Open 8 to 8 Mon - Fri, 8 to 6 Sat, 10 to 4 Sun & Bank Holidays)

www.theservicecentre.co.uk

Republic of Ireland: 1850 302 200

Note: Our operators will require the following information:

Model number:

Serial number:

Extended Warranties

UK: 08709 088 088

(Open 8 to 8 Mon - Sun)

www.theservicecentre.co.uk

Republic of Ireland: 1850 502 200

Genuine Parts and Accessories

UK: 08709 077 077

(Open 8-30 to 5-30 Mon - Fri & 9 to 12 Sat)

www.theservicecentre.co.uk

Republic of Ireland: (01) 842 6836

General Domestic Appliances Limited, Morley Way, Peterborough, PE2 9JB.

Free Manuals Download Website

<http://myh66.com>

<http://usermanuals.us>

<http://www.somanuals.com>

<http://www.4manuals.cc>

<http://www.manual-lib.com>

<http://www.404manual.com>

<http://www.luxmanual.com>

<http://aubethermostatmanual.com>

Golf course search by state

<http://golfingnear.com>

Email search by domain

<http://emailbydomain.com>

Auto manuals search

<http://auto.somanuals.com>

TV manuals search

<http://tv.somanuals.com>