

Hotpoint®

KEY CONTACT NUMBERS

SERVICE

UK: 0541 500 500

Republic of Ireland: 1850 302 200

GENUINE SPARES MAIL

ORDER HOTLINE

UK: 0541 530 530

Republic of Ireland: (01) 84268636

ACCESSORIES MAIL ORDER

HOTLINE

0541 530 530

EXTENDED WARRANTY

To join: 0800 716 356

Administration: 01782 388 252



All Hotpoint Services are offered as an extra benefit and do not affect your statutory rights. Applicable to UK only.

HOTPOINT LTD, PETERBOROUGH, PE2 9/B.

COOKER HOOD

USER HANDBOOK FOR INSTALLATION AND OPERATION MODEL BH11

Hotpoint®

Your new Hotpoint Cooker Hood

Using your new Cooker Hood is very simple. Nevertheless, to get the best results it is important that you read right through this handbook **before** installing and using your hood for the first time.

Electrical Requirements

Any permanent electrical installation must comply with the latest I.E.E. Regulations and local electricity company regulations. For your own safety this should be undertaken by a qualified electrician e.g. your local electricity company or a contractor who is on the roll of the National Inspection Council for Electrical Installation Contracting (NICEIC).

Please ensure that when the appliance is installed it is easily accessible for the engineer in the event of a breakdown.

INCORRECT INSTALLATION COULD AFFECT THE SAFETY OF THE APPLIANCE

If the Hood is permanently wired in this must be via a suitable double pole isolating switch placed in a readily accessible position adjacent to the unit.

Electrical Connection

Before connecting to the mains supply ensure that the mains voltage corresponds to the voltage on the rating plate inside the Cooker Hood.

This is fitted with a 3 core mains supply cable and must be permanently connected to the electricity supply via a double pole switch having 3mm minimum contact gap on each pole. A Switched Fuse Connection Unit to BS.1363 Part 4, is a recommended mains supply connection accessory to ensure compliance with the Safety Requirements applicable to fixed wiring instructions.

DISCONNECT THE COOKER HOOD FROM THE MAINS SUPPLY BEFORE CARRYING OUT ANY KIND OF MAINTENANCE OR CLEANING.

WARNING:

CHILDREN SHOULD NOT BE ALLOWED TO PLAY WITH THE APPLIANCE OR TAMPER WITH THE CONTROLS.

Note: CE Marking certifies that this appliance complies with the requirements laid down in EEC Directive 89:336 (Electromagnetic Compatibility) and subsequent modifications and Low Voltage Directive 72/23/EEC.

Contents

| | page |
|---|------------------|
| Get to know the main parts of your Cooker Hood | 4 |
| Installing your Cooker Hood | 5-7 |
| Installation for Recirculation | |
| Installation for Extraction | |
| Mounting Height | |
| Wall Fixing | |
| Under-cupboard Fixing | |
| Operating your Cooker Hood | 8 |
| The Controls and Don'ts | |
| Caring for your Cooker Hood | 9-10 |
| Cleaning | |
| Filters and their Replacement | |
| How to replace the Hob Light | |
| If your Cooker Hood won't work | 11 |
| Hotpoint Service Cover | 12 |
| Hotpoint Service Offices | back page |
| Appliance Manufactured in Italy. | |

Retention of the Instruction Book

This Instruction Book must be kept handy for reference as it contains important details on the safe and proper use of the appliance.

If you sell or pass the appliance to someone else, or move house and leave it behind, make sure this Book is also provided so the new owner can become familiar with the appliance and safety warnings.

If the Book is lost or damaged a copy may be obtained from Hotpoint Ltd, Morley Way, Peterborough, PE2 9JB.

Get to know the main parts of your Cooker Hood

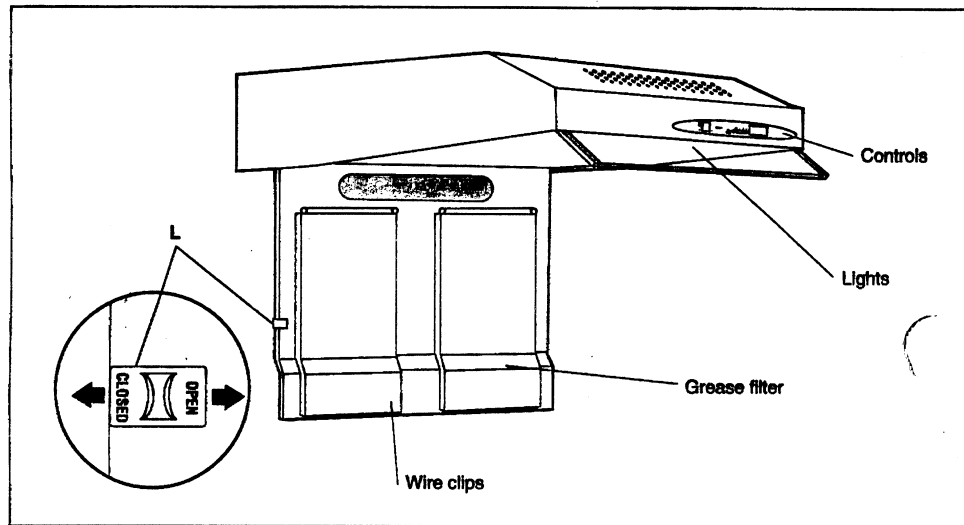

Unpacking

Before installation, ensure that you have removed any packing pieces.

Installing your new Cooker Hood

Your new Cooker Hood can be installed either for recirculation or extraction through an outside wall.

Dimensions of your Cooker Hood

Height 15cm (5³/₄in)
Width 60cm (23¹/₂in)
Depth 55cm (21¹/₂in)
Including visor.

Installation

These distances between hobs and grease filter must be observed.

Minimum 65cm – over an electric hob.

Minimum 75cm – over a gas hob.

Minimum 40-45cm – over a high level grill/top oven.

See page 7.

SATISFACTION GUARANTEED OR YOUR MONEY BACK

Hotpoint gives you a unique 'Satisfaction Guaranteed' promise – valid for ninety days after you have purchased your Hotpoint product. If there is a technical problem with your Hotpoint appliance, just call Hotpoint Service. If necessary

we will arrange for an engineer to call. If the technical problem is not resolved under this Guarantee, Hotpoint will replace your appliance or, if you prefer, give you your money back. Your statutory rights are not affected, and the Guarantee is additional and subject to the terms of Hotpoint's Five Year Parts Guarantee.

HOTPOINT'S EXTENDED WARRANTIES

Whether you have just one or a number of Hotpoint appliances in your kitchen, Hotpoint has a range of Service Plans to give you complete peace of mind. They enable you to extend your one year labour guarantee so that you can have repairs completed **FREE** during the membership period.

SERVICE COVER

We offer a number of payment methods; cheque, credit card or you can spread the cost and pay by direct debit (full details can be obtained on free phone 0800 716356). This covers you for all repairs during the period of cover, which can be from 1 to 4 years. Service Cover also includes loss of food, up to the value of £250, subject to verification by one of our engineers in refrigeration appliances. There is also an option of Service Cover with Maintenance at an additional cost. This includes an annual Electrical and Safety check and replacement of any parts as necessary.

KITCHEN COVER

An annual payment covers you for all repairs for all your Hotpoint appliances which are less than ten years old. It also covers the cost of loss of food up to £250 subject to verification by one of our engineers in our refrigeration and freezer products. There is also the option of Kitchen Cover with Maintenance at an additional cost. Any additional Hotpoint appliances purchased after you have joined Hotpoint Kitchen Cover will automatically be included during the annual period of cover without further charge.

APPLIANCE REGISTRATION

To ensure that you have the opportunity to benefit from any of the above Service Schemes and other offers you should complete and return immediately the Appliance Registration Form/Questionnaire supplied with this appliance. Full details and costs of our Service Schemes, together with an application form, will be sent to you at the end of the first year of the guarantee.

ANNUAL SAFETY/MAINTENANCE CHECKS

Hotpoint strongly recommends that all its appliances are regularly checked for electrical and mechanical safety, whether or not they are covered by a Service Plan. Worn door gaskets or hoses may cause a leak on an appliance, which could become dangerous if neglected.

PROOF OF PURCHASE

For future reference please attach your purchase receipt to this booklet and keep it in a safe place.

SPARES AND ACCESSORIES

Spares and accessories can be ordered from your local Hotpoint Genuine Spares Mail Order Hotline (see back page).

HOTPOINT'S FREE FIVE YEAR GUARANTEE

From the moment your appliance is delivered, Hotpoint guarantees it for **FIVE YEARS**.

- ★ In the Five Years all replacement parts are **FREE** provided that they are fitted by our own Service Engineer. During the first year our Engineer's time and labour is also free.
- ★ Our guarantee covers loss of food in our refrigeration and freezer products up to £250 during the first year, subject to verification by one of our engineers
- ★ After the first year we will charge for our Engineer's time and labour. We do, however, operate a range of Service Plans (see opposite) which, for an annual payment, enables you to cover any repair costs which may be necessary.
- ★ All our service repairs are guaranteed for twelve months in respect of our labour and any parts fitted.
- ★ The appliance must be used in the United Kingdom, and must not be tampered with or taken apart by anyone other than our own Service Engineers.
- ★ You may however, buy parts which can be safely fitted without specialist knowledge or equipment. The correct fitting of such parts, provided they are genuine Hotpoint spares, will not affect your Guarantee. Parts are available from our Hotpoint Genuine Spares Mail Order Hotline (see back page).
- ★ Our Guarantee does not cover the cost of any repair, or loss of food in refrigeration products, due to power failure, accidents or misuse. Nor does it cover the cost of any visits to advise you on the use of your appliance.
- ★ If at any time during the Guarantee period we are unable to repair your appliance, we will refund any repair costs paid to us in the previous twelve months. We will also offer you a new appliance at a reduced charge instead of a repair.
- ★ Our Guarantee is in addition to and does not affect your legal rights.
- ★ Should you need independent advice on your consumer rights, help is available from your Consumer Advice Centre, Law Centre, Trading Standards Department and Citizens Advice Bureau.
- ★ All Hotpoint servicing is carried out by our own Service Organisation located throughout the United Kingdom and Eire. We will be happy to deal with any problems which you may have.

NOTE: Our Engineers will use every effort to avoid damage to floor coverings and adjacent units when carrying out repairs/service work, but in locations where the Engl advises you that it will be impossible to move the appliance without risk of damage, he will only proceed with your approval that no liability is accepted.

Installing your new Cooker Hood (cont'd)

Installation for Recirculation

If it is not possible to exhaust to the outside, the Hood can be used to filter and recirculate the air (Fig. 1).

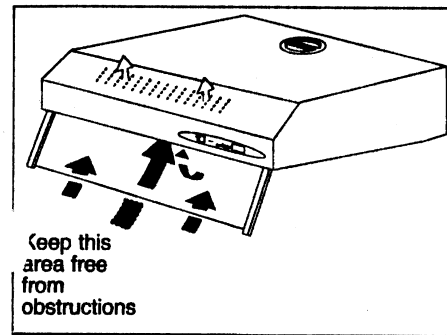

Fig. 1

To check that the Cooker Hood is set up for recycling, open the grille panel and make sure that the conversion lever is in the recycling position. (Fig. 2). Lever F in position F.

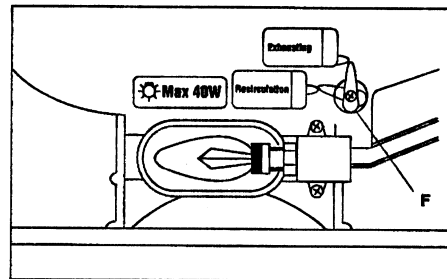

Fig. 2

NOTE: The hood is more efficient in the exhaust mode, therefore this position should be selected during the warmer months of the year when no heating is being used. When the room is being heated if the recycle position is selected heat will not be wasted.

To obtain the best performance it is advisable to switch on the hood a few minutes before you start cooking and leave it running approximately 15 minutes after finishing.

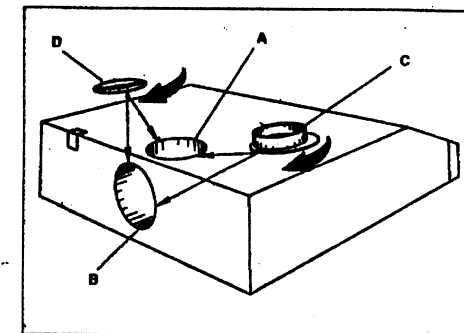

Fig. 3

Installation for Extraction

This method is recommended if at all possible. Fumes and grease laden air are drawn into the underside of the Hood and expelled outside the kitchen. The air can be expelled either upwards through a ventilating shaft **A** or directly through the wall to the outside **B**. Ducting will be required if the Cooker Hood is mounted away from the outside vent.

To connect the pipe fit the coupling ring 'C' in the outlet selected. Use cover 'D' to close the unused outlet.

IMPORTANT: The exhaust air must not be expelled through a smoke or waste-gas chimney which is in use or through a shaft used for ventilating rooms or into the cavity of a cavity wall.

NOTE: Before installing for extraction check on the local authority ruling on the extraction of waste air into the atmosphere.

Installing your new Cooker Hood (cont'd)

If the room contains a flued fuel burning appliance, such as a gas or oil fired central heating boiler which is not of the 'Balanced Flue' type, you should make sure that there is an adequate air inlet into the room at all times so that fumes from the boiler are not drawn back into the room by the Cooker Hood.

Top Extraction (Fig. 4)

If the exhaust air is being drawn upwards, a pipe with a diameter of 100mm is necessary and the blanking plate must be fitted in the rear outlet. To check that the hood is set up for extraction open the grille panel and make sure that the conversion lever on the unit is in the ducting position.

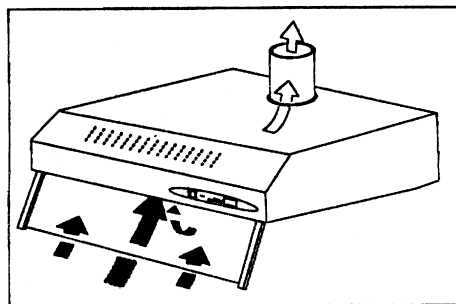

Fig. 4

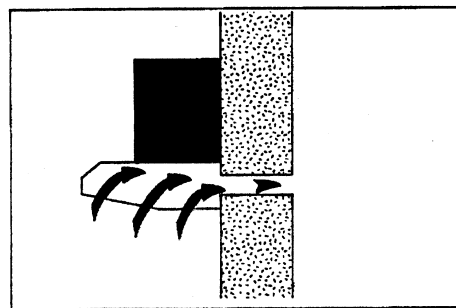

Fig. 5

Rear Extraction (Fig. 5)

If the air is to be drawn off to the rear, a pipe with a diameter of 100mm is necessary and the blanking plate should be inserted in the top outlet.

Important:

When using the rear outlet, the large rear section of the upward facing pipe must first be completely removed breaking away the section via the top outlet hole down through the double lines seen at both sides and the bottom (arrowed 1). Using pliers grip the tabs and pull away E (Fig. 6).

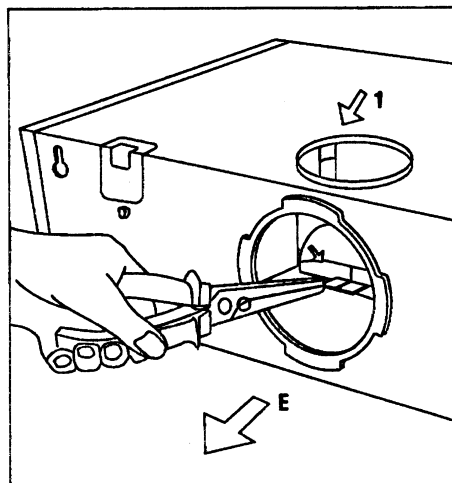

Fig. 6

Ducting

In order to obtain satisfactory air extraction long ducts should not be used. Pipes with a minimum internal diameter of 100mm and with as smooth an inner wall as possible are recommended. The ducting **MUST** be manufactured from a fire retardant material.

If your Cooker Hood won't work

... don't panic.

Just quickly check through these points before calling a Hotpoint engineer.

1. If you have wired the mains lead directly into a double pole isolating switch check that the wires in the mains lead are correctly connected (see page 2).
2. If the Cooker Hood does not appear to be working satisfactorily check that:
 - i. You have selected the correct fan speed
 - ii. You have left the cover (extraction only) over the recirculation grille on top of the Hood (see page 6).
 - iii. The Grease filter does not need replacing (see page 9).
3. Should the hob light fail to work see page 10.
4. If the Cooker Hood intermittently switches off, check that the mounting height above the hob is correct. The heat from the hob may cause the motor to overheat/cut out (see page 7).

If, after following these instructions, you are still having problems, contact your nearest Hotpoint Service Centre (or local importer if outside the United Kingdom). The telephone number is shown on the back page.

When you contact us we need to know:

1. Your name, address and post code.
2. Your telephone number.
3. Clear and concise details of the fault.

4. The model number of your appliance and colour.
5. When it was purchased.

Please put the date here

Make sure you have all these details before you call.

Spare Parts

Please remember your new appliance is a complex piece of equipment.

'DIY' repairs or unqualified and untrained service people may put you in danger, could damage the appliance and might mean you lose cover under Hotpoint's Parts Guarantee.

If you do experience a problem with the appliance don't take risks; call in Hotpoint's own Service Engineer. See back page.

Our spare parts are designed exclusively to fit only Hotpoint appliances. Do not use them for any other purpose as you may create a safety hazard.

4. Replace the retaining clips.
5. Close the grille panel.

How to replace the Hob Light

Should the light fail to work, switch off the mains supply to the Hood. Open the grille and check that the bulb is screwed securely into the bulb holder and switch on at the mains supply and at the Hood.

If the light still fails to work, do not worry it will not affect the working of your Hood. Obtain a replacement 40 watt (E14) bulb and then switch off the mains supply and replace the bulb. Refit the filter grille.

NOTE: When changing the bulb, an identical replacement must be fitted to ensure the safe operation of the Hood.

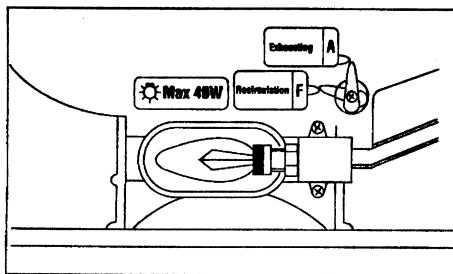

To remove turn the bulb anti-clockwise. To replace turn the bulb clockwise.

Cleaning the exterior of the Cooker Hood

The exterior of the Cooker Hood should be cleaned regularly to keep it looking like new. Wipe over with a soft cloth wrung out in hot water and dry with a soft clean cloth. Wear protective gloves.

You can use mild **non abrasive** cleaners but always read the manufacturer's instructions first.

Always test their suitability on a small area of the Cooker Hood not noticeable in normal use.

NOTE: DO NOT use scouring pads or abrasive cleaners as they may scratch the surface.

Wall Vent Kit

For connecting the Hood either directly through a wall or in conjunction with a ducting pipe we recommend the use of a Wall Vent Kit. A 3m extension pipe is also available. Both of these are 100mm diameter, and may be obtained from your nearest Retailer or Hotpoint Spares Mail Order Hotline and must be used where there is a cavity wall.

Mounting

Mounting Height

Your Cooker Hood is suitable for wall mounting or fixing to the underside of a wall cupboard. In either case the bottom of the Hood should be 650mm (25¹/₂in approx) above an electric hob and 750mm (29¹/₂in) above a gas hob, 400-450mm (15³/₄-17³/₄in) in the case of an eye level grille/top oven.

For the best results the Hood should be mounted as near as possible to the lower recommended height.

WARNING: The fan motor of this appliance incorporates a thermal cut-out device which will operate if the Hood is installed below the minimum heights recommended above, or if the motor becomes overheated. If the cut-out device is activated, switch off the fan motor and allow the Hood to cool.

The cut-out device will reset itself when the fan motor has cooled significantly.

NOTE: This Hood has been designed and approved for installation over an electric hob with a maximum input of 7kW or a gas hob with a maximum input of 10kW when fitted in accordance with the heights recommended above.

A template is enclosed for both wall and under-cupboard fixing.

Fixing to the cabinet

Make holes at the bottom of the cabinet using the template supplied. Fit the 44.2 x 35 screws supplied, from inside the cabinet in the holes on the appliance (Fig. 7).

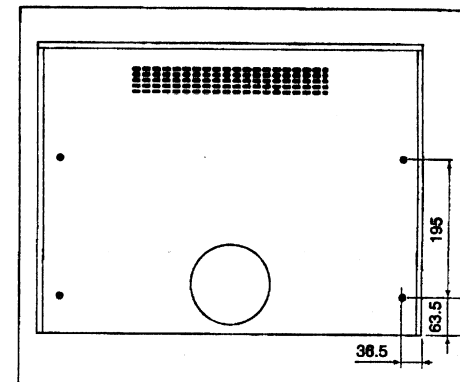

Fig. 7

Fixing to the wall

Fit the template to the wall.

Make 3 x 8mm dia holes on the wall, 2 on **H**, and 1 hole on either of the points **I**.

Fit 3 x 8mm wall plugs.

Fit 2 x 5mm dia x 45mm long screws on **H**.

Do not tighten completely.

Now hang the Hood (holes **H**) tighten the 2 screws and fit the third screw in hole **I** from inside the Hood (Fig. 8).

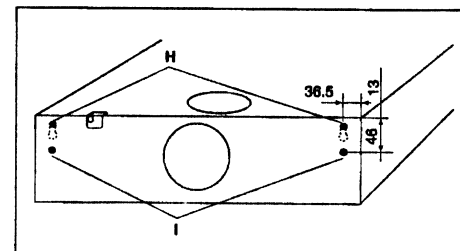
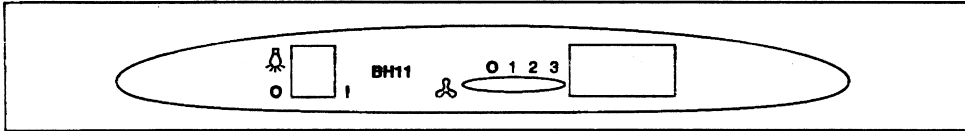



Fig. 8



Operating your Cooker Hood

The Controls



Make sure that the Cooker Hood is wired in and the power supply is switched on.

Your Cooker Hood has three speeds – Low 1, Normal 2 or Boost 3 to give you the correct extraction level to suit your cooking conditions. The control marked with the adjacent symbol  controls the fan speed. Position 1 should be selected when simmering or when using only one pan. Position 2 should be selected for normal cooking up to four pans and position 3 should be selected when frying or cooking foods with strong odours. Simply slide the selector to the required setting. It is advisable to leave it running for approximately 15 minutes afterwards to ensure that all odours are extracted.

There is a separate selector for the light. The switch marked with the adjacent symbol  controls the worktop illumination and indicates the illumination is operating. Position  indicates the switch/light is in the off position. The visor can be adjusted to enlarge the extraction area.

Do's and Don'ts

DO

Do have the 'Visor' open when using the hob even if the fan on the Hood is not switched on.

Do take extra care when frying.

Do keep the heating areas on your hob covered over with pots and pans etc when using the hob and Cooker Hood simultaneously.

Do make sure that there is an adequate air inlet if you are venting externally and have a boiler or fire in the room, so that fumes are not drawn back from the flue.

DON'T

Don't use the Hood without the grease filter.

Don't leave a naked flame under the Hood.

Don't obstruct the recirculation grille on top of the Hood (if using the Hood for recirculation).

The area above the grille should be kept clear of obstruction for at least 150mm (6in) above the Cooker Hood.

Don't leave cooker hot-plates 'On' when not covered as the fan motor of this Cooker Hood incorporates a thermal cut-out device which will operate if the Hood overheats. The fan motor will take approximately 20 minutes to automatically reset at which point the Hood will resume normal functions.

NEVER do flambé cooking beneath this Cooker Hood.

NEVER leave frying pans or deep fat fryers unattended during use as overheated fats and oil may catch fire.

Caring for your Cooker Hood

Before doing any cleaning or replacing the filters or light bulb always check that the electricity supply to the Hood is switched off.

Cleaning your Cooker Hood

Clean the outside of the Hood with a damp cloth using a small amount of detergent, followed by wiping down with a clean cloth. **Don't** use any abrasive cleaners or metal polish otherwise you will damage the surface.

Filters and their replacement

The Grease Filter

Your Cooker Hood is fitted with a grease filter which absorbs grease, dust, etc, and helps to keep the appliance clean inside. Gradually the filter will become saturated with grease and when this happens the visual indicator stripes will start to be seen through the filter grille.

When the stripes are clearly visible from outside the hood – the grease filter must be replaced.

IMPORTANT: There could be a possible fire hazard if the grease filter is not replaced when necessary and according to these instructions.

Replacement Grease Filters are available from your nearest Retailer or Hotpoint Spares Mail Order Hotline.

Releasing the Grille Panel

To open the grille panel press the  into the centre of the grille. The grille will be released and will fall down pivoting to the rear (Fig. 9). Remove the metal filter retainer by pulling gently to release it from the slot in the casing.

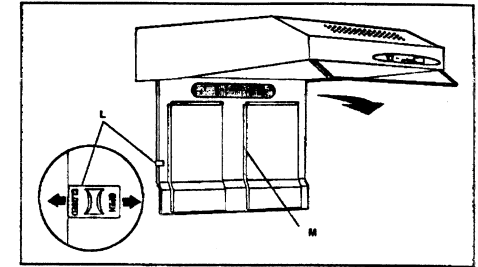

Fig. 9

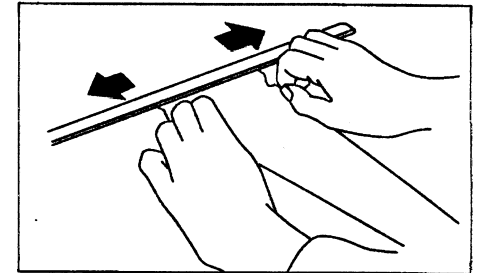

Fig. 10

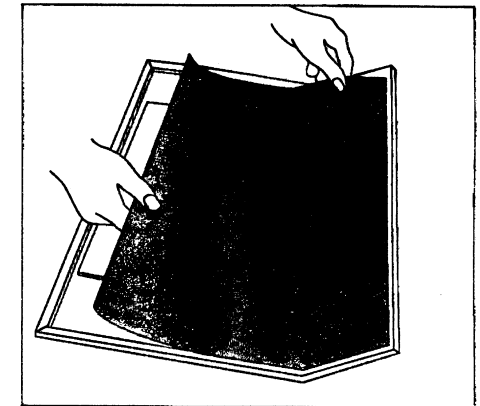

Fig. 11

To replace the grease filter:

1. Push the wire clips to one side and remove (Fig. 10).
2. Remove the saturated grease filter.
3. Place new grease filter in the filter grille (Fig. 11).

Free Manuals Download Website

<http://myh66.com>

<http://usermanuals.us>

<http://www.somanuals.com>

<http://www.4manuals.cc>

<http://www.manual-lib.com>

<http://www.404manual.com>

<http://www.luxmanual.com>

<http://aubethermostatmanual.com>

Golf course search by state

<http://golfingnear.com>

Email search by domain

<http://emailbydomain.com>

Auto manuals search

<http://auto.somanuals.com>

TV manuals search

<http://tv.somanuals.com>