



kitchen think

Instructions for Installation and Use

Electric Hood

To the Installer

**Before installation fill in the product details on the back cover of this book.
The information can be found on the rating plate.**

To the User

**You must read the instructions prior to installing and using the appliance and
then retain them for future reference.**



CE marking certifies that this appliance conforms to the following EEC directives:-

- Low Voltage Equipment 72/23/EEC
- Electromagnetic Compatibility 89/336/EEC

Retention of this Instruction Book

This Instruction Book must be kept handy for reference as it contains important details on the safe and proper use of the appliance.

If you sell or pass the appliance to someone else, or move house and leave it behind, make sure this Book is also provided so the new owner can become familiar with the appliance and safety warnings.

If the Book is lost or damaged a copy may be obtained from:
Merloni Elettrodomestici UK Ltd., Morley Way , Peterborough, PE2 9JB

Installation

! It is important to conserve this booklet for consultation at any moment. In the case of sale, cession or move, make sure it is together with the product.

! Read the instructions carefully: there is important information about installation, use and safety.

! Do not carry out electrical or mechanical variations on the product or on the discharge conduits.

Installation

Electric connection

! The power tension must correspond with the tension shown on the characteristics label situated inside the hood. If provided with a plug, attach the hood to a socket conforming to the regulations in force and placed in an accessible zone. If without a plug, (*connected directly to the power supply*), use a regulation bipolar switch with a distance of the contacts on opening not less than 3mm (*accessible*).

! If necessary, the situating of the supply cable must be carried out by the technical assistance service or a qualified person.

! An authorized installer must carry out the electrical connection of the hood.

! The company declines any responsibility whenever these regulations are not respected.

Preliminary Information for installation of the hood:

Disconnect the hood during electrical connection, by turning the home mains switch off.

Expansion wall plugs are provided to secure the hood to most types of walls/ceilings. However, a qualified technician must verify suitability of the materials in accordance with the type of wall/ceiling. The wall/ceiling must be strong enough to take the weight of the hood.

Do not tile, grout or silicone this appliance to the wall. Surface mounting only.

Do not fix chimney flue to furniture or fly over shelves unless the chimney flue can be easily removed, in case maintenance is ever required.

Where foreseen remove the grease collecting panels.

Remove the grease filter/s

Do not tile, grout or silicone this appliance to the wall. Surface mounting only.

Do not fix chimney flue to furniture or fly over shelves unless the chimney flue can be easily removed, in case maintenance is ever required.

The minimum distance between the supporting surface for the cooking vessels on the hob and the lowest part of the range hood must be not less than 50cm from electric cookers and 65 cm from gas or mixed cookers. If the instructions for installation for the gas hob specify a greater distance, this must be adhered to.

1. Using a pencil, draw a line on the wall, extending up to the ceiling, to mark the centre. This will facilitate installation.

2. Rest the drilling template against the wall: the vertical centre line printed on the drilling template must correspond to the centre line drawn on the wall, and the bottom edge of the drilling template must correspond to the bottom edge of the hood: bear in mind that, when installation is complete, the underside of the hood must be at least 50 cm above the cooker top in the case of electric cookers, and at least 65 cm above the cooker top in the case of gas or mixed cookers.

3. Rest the support bracket on the drilling template so that it coincides with the dotted rectangle, mark the two outer holes and drill them, remove the drilling template, insert 2 wall plugs and fix the hood support bracket into place using two 5x45mm screws.

4. Hang the hood on the bracket.

5. Adjust the distance of the hood from the wall.

6. Adjust the horizontal position of the hood.

7. Using a pencil mark the cooker hood permanent drill hole inside the suction group (two drill holes are necessary for fastening).

8. Remove the hood from the bracket.

9. Drill at the point marked (Ø8mm - see operation 7).

10. Insert 2 wall plugs.

11. Rest the chimney support bracket **,G'** against the wall, touching the ceiling. Use the support bracket as a drilling template (the small slot formed on the support must coincide with the line drawn on the wall as above

– operation 1) and mark 2 holes with a pencil, drill the holes (Ø8mm), insert 2 wall plugs.

12. Fix the chimney support bracket to the wall using two 5x45mm screws.

13. Hook the hood onto the bottom bracket.

14. Fix the hood into its final position on the wall (ABSOLUTELY ESSENTIAL).

15. Connect a pipe (pipe and pipe clamps not provided, to be purchased separately) for discharge of fumes to the connection ring located over the suction motor unit.

If the hood is to be used in ducting version, the other end of the pipe must be connected to a device expelling the fumes to the outside. If the hood is to be used in filter version, then fix the deflector **F** to the chimney support bracket **G** and connect the other extremity of the pipe to the connection ring placed on the deflector **F**.

16. Make the electrical connections.

17. Apply the chimney stacks and fasten them at the top to the chimney support, **G*** (**17b**) using 2 screws (**17a**).

18. Slide the bottom section of the chimney down until it completely covers the suction unit and slots into the housing provided on top of the hood.

Replace the grease filter/s (and where foreseen the grease collecting panels) and check that the hood is operating correctly.

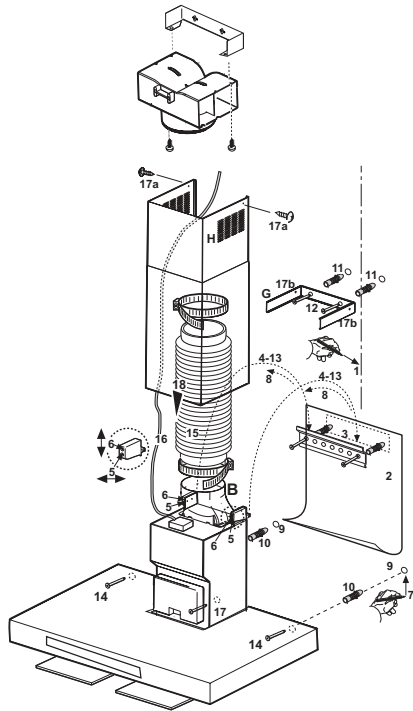





Description of the appliance





Control panel



Calibrating the control panel



When the plug is inserted (or after a blackout) the system calibrates the keys; during calibration the display point flashes. Calibration lasts 15". The point stops flashing at the end of calibration.





 **Off/Stand by:** the On condition is obtained by pressing  for 3 seconds; in this case keys  and  are enabled, the display point and the blue led of the relative keys light up. The Off condition is obtained by pressing  again for 3 seconds.

 **On/Off lights:** press  to switch on the lights, which turn amber. Contemporaneously the symbols at the sides  and  turn blue: the intensity of the light can be increased and diminished with these.

Once the luminosity has been set, pressing  rapidly again memorises it (the symbol turns blue) and the light switches off.

Secondary light (only for the models envisaged): press





 for a long time to switch it on (at least a second); press  again for at least a second to switch it off.

 **On/Off motor:** press  to switch the motor on. It turns amber. Contemporaneously the symbols at the sides  and  as well as  turn blue.

Press  or  to adjust the intensity of

suction. Pressing  again switches the motor off and the last speed set is memorised.



 **Intensive timing:** by pressing this key the suction of the hood becomes intensive for a maximum time of 5 minutes. At the end the hood returns to the speed

previously set. To exit from the function earlier press  or one of the following keys: ,  or .

 **Fats filter signal:** this symbol (red led) lights up

after 40 hours. Reset the signal by pressing  for a long time (at least 3 seconds) until the beep confirms it.

 **Carbon filter signal action.**
This signal is shown only if it has been previously set.

Proceed as follows: press  with the hood in Off: first  turns red, after about 1 second  also turns red. If you want to eliminate the carbon filter

signal previously set, press  with the hood in Off. Reset the carbon filter signal (after 160 hours) by

pressing  for a long time (about 3 seconds, until the beep).

Operation

! We advise switching the hood on, at minimum power, before beginning to cook to favour the optimal expulsion of odours. In addition we advise turning it off every time 10/15 minutes after finishing cooking.

! We advise frying under the hood only under constant supervision.

! It is forbidden to cook flambé under the hood because there is the risk of causing a fire.

The best performance of the apparatus is obtained with external expulsion: we advise using the hood in this version if possible.

External exhausting version

In this case the fumes are conveyed outside by means of a special pipe connected with the connection ring located on top of the hood. Diameter of the exhausting pipe must be equal to that of the connection ring = 150mm.

In the horizontal runs the exhausting pipe must be slightly slanted (about 10°) and directed upwards to vent the air easily from the room to the outside.

Attention! If the hood is supplied with active charcoal filter, then it must be removed.

Filtering version

One active charcoal filter is needed for this and can be obtained from your usual retailer.

The filter removes the grease and smells from the extracted air before sending it back into the room through the upper outlet grid.

Maintenance

! It is always necessary to isolate the hood from the power supply during cleaning and maintenance. Therefore remove the plug.

We recommend carrying out our maintenance regularly (about every 10 days) to ensure efficacious and constant performance of the hood.

Cleaning the hood

The hood should be cleaned frequently, both internally and externally. Use a cloth damped in neutral detergent liquids.

Avoid the use of products containing abrasives.

Attention: failure to observe the cleaning regulations of the hood and the substitution and cleaning of the filters leads to the risk of fire. We therefore recommend keeping to the suggested instructions.

Cleaning the grease filters

The fats filter serves to capture the particles of fat in suspension that come from the cooking.

It must be cleaned once a month with non-aggressive detergents manually or in a dishwasher at low temperature and short cycle.

If washed in a dishwasher it can become opaque over time but its filtering ability is not lessened in any way. Dismantle it using the corresponding handles, pushing them backward first and then pulling them down.

After having washed it, dry it carefully and assemble it again in its seat, reversing the procedure.

Clean the perimeter suction panel (when envisaged) with the same frequency as the anti-fat filter. Use a cloth and a not too concentrated liquid detergent. Never use abrasive substances.

Mounting and changing the filter

To remove the grease filter, pull the spring release handle

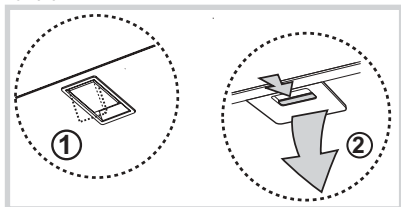

Carbon filter

Remove the filter holder frame by turning the knobs (g) 90° that affix the chimney to the cooker hood.

Insert the pad (l) of activated carbon into the frame (h) and fit the whole back into its housing (j).

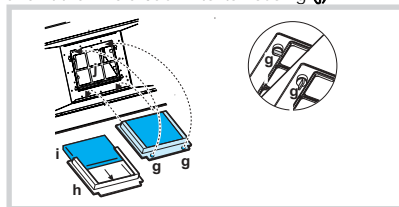

Replacing lamps



Remove the plug!
Bulb/s:
Remove the overhead light and remove the bulb to change. Only use 40W lamps.
Make sure the bulbs are cold before touching them.

Halogen bulbs:

Use a small screwdriver or other tool suitable for prising.

Substitute the halogen bulb with another of equal value. Close with the trigger fixing.

Changing the Neon (only for the models envisaged)

Unscrew the screws and remove the overhead light on the upper part of the hood.

Change the damaged bulb with one with identical technical characteristics.

Caution

General safety

! The hood has been designed and constructed in conformity with international safety regulations. These warnings are provided for safety reasons and must be carefully read.

- This apparatus has been designed for use by adults.
 - Children and invalids are not allowed to use this apparatus without supervision. Check that children do not play with the apparatus.
 - The premises must have sufficient ventilation when the hood is being used at the same time as other apparatuses that use gas and other fuels. If the hood must be installed in a kitchen where there is a water-heater or a gas heating system we recommend, for safety reasons, not using the suction version. It is therefore necessary to equip the apparatus with an active carbon filter, in this way allowing recycling use.
 - For safe performance, low pressure should not exceed 0.04 mbar; in this way re-suction of the expulsion gas will be avoided. This can be obtained ensuring entry of air into the room through openings that cannot be closed.
 - The sucked air must not be conveyed in a conduit used for the discharge of fumes from apparatuses supplied with energy other than electricity.
 - It is severely forbidden to cook food on the flame under the hood.
 - The use of naked flame damages the filters and can cause fires. It must therefore be avoided in any case.
 - Frying must be carried out under control to avoid the overheated oil catching fire.
 - As far as the technical and safety measures to adopt for the discharge of fumes are concerned, keep strictly to what is envisaged by the regulations of the competent authorities.
 - For any problem regarding the expulsion of fumes, keep to the instructions of the competent authority.
- The company declines any responsibility in the case of damage or fire caused by apparatus resulting from failure to observe the above-mentioned instructions.

Disposal

- Disposing of the packaging material: keep to the local regulations so that the packaging can be re-used.
- European directive 2002/96/CE on electric and electronic apparatus waste provides that domestic appliance should not be disposed of in the normal flow of solid urban waste. The disused apparatuses must be collected separately to make the rate of recovering and recycling of the materials they consist of and prevent potential damage to health and the environment. The symbol of the barred basket is shown on all the products to remind users of the need for separate collection.

- Disused domestic appliances can be delivered to the public collecting service, taken to suitable local authority areas or, if envisaged by national laws on the matter, resold to dealers at the same time as purchasing new, equivalent, types of product.
- All the main producers of domestic appliances are active in the creation and management of collecting systems of disused apparatuses.

! In case of anomalies apply to the authorized technical assistance service and require original spare parts.

! The information and technical data are subject to change and the producer, in line with technical progress, maintains the right to make modifications that he considers necessary without prior notice.

This appliance is marked according to the European directive 2002/96/EC on Waste Electrical and Electronic Equipment (WEEE). By ensuring this product is disposed of correctly, you will help prevent potential negative consequences for the environment and human health, which could otherwise be caused by inappropriate waste handling of this product.



The symbol  on the product, or on the documents accompanying the product, indicates that this appliance may not be treated as household waste. Instead it shall be handed over to the applicable collection point for the recycling of electrical and electronic equipment. Disposal must be carried out in accordance with local environmental regulations for waste disposal.

For more detailed information about treatment, recovery and recycling of this product, please contact your local city office, your household waste disposal service or the shop where you purchased the product.



After Sales Service

"No company is better positioned to offer an after sales service on a Hotpoint appliance than us - the manufacturer"

As part of our commitment to you, all Hotpoint appliances have the added benefit of a fully inclusive parts and labour guarantee for the first 12 months. In addition to this you also have the advantage of **free replacement parts for the first 5 years** when fitted by a Hotpoint engineer. When the 12 months parts and labour guarantee expires we offer the following after sales service options:

Repair Service and Information Help Desk

UK: 08709 066066

www.hotpointservice.co.uk

Republic of Ireland: 1850 302 200

Note: Our operators will require the Model number and the Serial number of your appliance

Available 364 days a year with a fast, effective and value for money service. We have the largest white goods repair service in the UK with over 1000 of our own fully trained engineers. All repairs include a parts and labour guarantee for 12 months from the date of the repair. If you require any information or have any questions about your appliance, our operators are on hand with help and advice.

All this ensures that you will receive the best available after sales service possible.

Extended Warranties

UK: 08709 088 088

www.hotpointservice.co.uk

Republic of Ireland: 1850 502 200

Whether you have just one or a number of Hotpoint appliances in your kitchen, we offer two service cover plans to give you total peace of mind.

- Repair Protection Plan - FREE service repairs for a single Hotpoint appliance during the period of cover.
- Kitchen Cover - FREE service repairs for all your Hotpoint appliances less than 8 years old.

Genuine Parts and Accessories

UK: 08709 077 077

www.hotpointservice.co.uk

Republic of Ireland: (01) 842 6836

A wide range of genuine parts and accessories are available from our hotline or through our website.

Genuine parts and accessories, extended warranties and service repairs are all available on our web-site at:



Key Contacts

After Sales Service

Over 1200 trained specialists, directly employed by us, ensure that you can have complete confidence in both the appliances and services we offer.



Repair Service and Information Desk

UK: 08709 066 066

(Open 8 to 8 Mon - Fri, 8 to 6 Sat, 10 to 4 Sun & Bank Holidays)

www.hotpointservice.co.uk

Republic of Ireland: 1850 302 200

Note: Our operators will require the following information:

Model number:

Serial number:

Extended Warranties

UK: 08709 088 088

(Open 8 to 8 Mon - Sun)

www.hotpointservice.co.uk

Republic of Ireland: 1850 502 200

Genuine Parts and Accessories

UK: 08709 077 077

(Open 8-30 to 5-30 Mon - Fri & 9 to 12 Sat)

www.hotpointservice.co.uk

Republic of Ireland: (01) 842 6836

Indesit Company, Morley Way , Peterborough, PE2 9JB

Free Manuals Download Website

<http://myh66.com>

<http://usermanuals.us>

<http://www.somanuals.com>

<http://www.4manuals.cc>

<http://www.manual-lib.com>

<http://www.404manual.com>

<http://www.luxmanual.com>

<http://aubethermostatmanual.com>

Golf course search by state

<http://golfingnear.com>

Email search by domain

<http://emailbydomain.com>

Auto manuals search

<http://auto.somanuals.com>

TV manuals search

<http://tv.somanuals.com>