

How to get the best from

# Your Range

## Contents

Aluminum Foil	4,5, 17, 18,20,29	Oven Vents	4,5, 13,30
Anti-Tip Device	3,33,40	Preheating	16
Appliance Registration	2	Roasting, Roasting Guide	18, 19
Care and Cleaning	25-30	Self-Cleaning Instructions	22-24
Clock and Timer	10, 11	Shelves	12, 16,22,27
Consumer Services	47	Thermostat Adjustment	13
Features	6,7	Power Outage	11, 12
Flooring Under Range	34	Problem Solver	45,46
Installation Instructions	32-44	Safety Instructions	2-5
Leveling	40	Set the Clock	10, 11
Minor Adjustments	31	Set the Timer	10, 11
Model and Serial Numbers	2,6,34	<b>Surface Cooking</b>	<b>8,9</b>
<b>Oven</b>	12-24	Burner Grates	26
Air Adjustment	31,39	Burners	25,26
Baking	14-17	Control Settings	8
Broiler Pan and Rack	18,20,26	Cookware Tips	9
Broiling, Broiling Guide	20,21	Flame Size	9,38,44,45
Control Settings	10	Lighting Instructions	8
Door Latch	14, 18,20,22-24	Warranty	Back Cover
Door Removal	28	<b>Installation</b>	<b>32-44</b>
Light; Bulb Replacement	13,30	<b>GE Answer Center™</b>	
Oven Bottom	29,31,39	800.626.2000	

Use and Care  
& Installation  
of Model  
RGB747GER

# HOTPOINT



## HELP US HELP YOU

### Read this book carefully.

It is intended to help you operate and maintain your new range properly.

Keep it handy for answers to your questions.

If you don't understand something or need more help, write (include your phone number):

Consumer Affairs  
Hotpoint  
Appliance Park  
Louisville, KY 40225

### Write down the model and serial numbers.

Depending on your range, you'll find the model and serial numbers on a label on the front of the range, behind the kick panel, storage drawer or broiler drawer.

These numbers are also on the Consumer Product Ownership Registration Card that came with your range. Before sending in this card, please write these numbers here:

\_\_\_\_\_

Model Number

\_\_\_\_\_

Serial Number

Use these numbers in any correspondence or service calls concerning your range.

### If you received a damaged range...

Immediately contact the dealer (or builder) that sold you the range.

### Save time and money. Before you request service...

Check the Problem Solver in the back of this book. It lists causes of minor operating problems that you can correct yourself.



## IF YOU NEED SERVICE...

To obtain service, see the Consumer Services page in the back of this book.

To obtain replacement parts, contact GE/Hotpoint Service Centers.

We're proud of our service and want you to be pleased. If for some reason you are not happy with the service you receive, here are three steps to follow for further help.

**FIRST**, contact the people who serviced your appliance. Explain why you are not pleased. In most cases, this will solve the problem.

**NEXT**, if you are still not pleased, write all the details—including your phone number—to:

Manager, Consumer Relations  
Hotpoint  
Appliance Park  
Louisville, KY 40225

**FINALLY**, if your problem is still not resolved, write:

Major Appliance Consumer  
Action Panel  
20 North Wacker Drive  
Chicago, IL 60606

**WARNING:** If the information in this manual is not followed exactly, a fire or explosion may result causing property damage, personal injury or death.

—Do not store or use gasoline or other flammable vapors and liquids in the vicinity of this or any other appliance.

#### —WHAT TO DO IF YOU SMELL GAS

- Do not try to light any appliance.
- Do not touch any electrical switch; do not use any phone in your building.

- Immediately call your gas supplier from a neighbor's phone. Follow the gas supplier's instructions.
- If you cannot reach your gas supplier, call the fire department.
- Installation and service must be performed by a qualified installer, service agency or the gas supplier.

# IMPORTANT SAFETY INSTRUCTIONS

Read all instructions before using this appliance.



## IMPORTANT SAFETY NOTICE

The California Safe Drinking Water and Toxic Enforcement Act requires the Governor of California to publish a list of substances known to the state to cause cancer, birth defects or other reproductive harm, and requires businesses to warn customers of potential exposure to such substances.

Gas appliances can cause minor exposure to four of these substances, namely benzene, carbon monoxide, formaldehyde and soot, caused primarily by the incomplete combustion of natural gas or LP fuels. Properly adjusted burners, indicated by a bluish rather than a yellow flame, will minimize incomplete combustion. Exposure to these substances can be minimized by venting with an open window or using a ventilation fan or hood.

## When You Get Your Range

- Have the installer show you the location of the range gas cut-off valve and how to shut it off if necessary.
- Have your range installed and properly grounded by a qualified installer, in accordance with the Installation Instructions. Any adjustment and service should be performed only by qualified gas range installers or service technicians.
- Plug your range into a 120-volt grounded outlet only. Do not remove the round grounding prong from the plug. If in doubt about the grounding of the home electrical system, it is your personal responsibility and obligation to have an ungrounded outlet replaced with a properly grounded, three-prong outlet in accordance with the National Electrical Code. In Canada, the appliance must be electrically grounded in accordance with the Canadian Electrical Code. Do not use an extension cord with this appliance.
- Be sure all packing materials are removed from the range before operating it to prevent fire or smoke damage should the packing material ignite.
- Locate range out of kitchen traffic path and out of drafty locations to prevent poor air circulation.
- Be sure your range is correctly adjusted by a qualified service technician or installer for the type of gas (natural or LP) that is to be used. Your range can be converted for use with either type of gas. See Installation Instructions.

- After prolonged use of a range, high floor temperatures may result and many floor coverings will not withstand this kind of use. Never install the range over vinyl tile or linoleum that cannot withstand such type of use. Never install it directly over interior kitchen carpeting.

## Using Your Range

- Don't leave children alone or unattended where a range is hot or in operation. They could be seriously burned.
- Don't allow anyone to climb, stand or hang on the door, storage or broiler drawer (on models so equipped) or range top. They could damage the range and even tip it over, causing severe personal injury.
- CAUTION: ITEMS OF INTEREST TO CHILDREN SHOULD NOT BE STORED IN CABINETS ABOVE A RANGE OR ON THE BACKSPASH OF A RANGE-CHILDREN CLIMBING ON THE RANGE TO REACH ITEMS COULD BE SERIOUSLY INJURED.

**WARNING**—All ranges can tip, and injury could result. To prevent accidental tipping of the range, attach an approved Anti-Tip device to the wall. (See Installation Instructions.) To check if the device is installed and engaged properly, carefully tip the range forward. The Anti-Tip device should engage and prevent the range from tipping over.

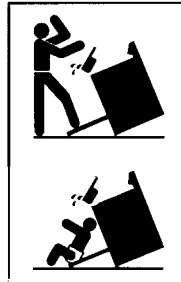

If you pull the range out from the wall for any reason, make sure the Anti-Tip device is engaged-when you push the range back against the wall.

- Let burner grates and other surfaces cool before touching them or leaving them where children can reach them.
- Never wear loose fitting or hanging garments while using the appliance. Be careful when reaching for items stored in cabinets over the cooktop. Flammable material could be ignited if brought in contact with flame or hot oven surfaces and may cause severe burns.

(continued next page)



# IMPORTANT SAFETY INSTRUCTIONS

(continued)

- For your safety, never use your appliance for warming or heating the room.
- Do not use water **on** grease fires. Never pick up a flaming pan. Turn off burner, then smother flaming pan by covering pan completely with well-fitting lid, cookie sheet or flat tray. Flaming grease outside a pan can be put out by covering with baking soda or, if available, a multi-purpose dry chemical or foam-type fire extinguisher.
- Do not store flammable materials in an oven, a range storage drawer or near a cooktop.
- Do **not store or use combustible** materials, gasoline or other flammable vapors and liquids in the vicinity of this or any other appliance.
- Do not let cooking grease or other flammable materials accumulate in or near the range.
- **When cooking pork**, follow the directions exactly and always cook the meat to an internal temperature of at least 170°F. This assures that, in the remote possibility that trichina may be present in the meat, it will be killed and the meat will be safe to eat.



---

## Surface Cooking

- Always use the LITE position when igniting top burners and make sure the burners have ignited.
- Never leave surface burners unattended at high flame settings. Boilover causes smoking and greasy spillovers that may catch on fire.
- Adjust top burner flame size so it does not extend beyond the edge of the cookware. Excessive flame is hazardous.
- Use **only dry pot holders**—**moist** or damp pot holders on hot surfaces may result in burns from steam. Do not let pot holders come near open flames when lifting cookware. Do not use a towel or other bulky cloth in place of a pot holder.
- To minimize the possibility of burns, ignition of flammable materials, and spillage, turn cookware handles toward the side or back of the range without extending over adjacent burners,



- Always turn surface burner to OFF before removing cookware.
- Carefully watch foods being fried at a high flame setting.
- Never block the vents (air openings) of the range. They provide the air inlet and outlet that are necessary for the range to operate properly with correct combustion. Air openings are located at the rear of the cooktop, at the top and bottom of the oven door, and at the bottom of the range, under the storage drawer.
- Do not use a wok if the wok has a round metal ring that is placed over the burner grate to support the wok. This ring acts as a heat trap, which may damage the burner grate and burner head. Also, it may cause the burner to work improperly. This may cause a carbon monoxide level above that allowed by current standards, resulting in a health hazard.
- Foods for frying should be as dry as possible. Frost on frozen foods or moisture on fresh foods can cause hot fat to bubble up and over sides of pan.
- Use least possible amount of fat for effective shallow or deep-fat frying. Filling the pan too full of fat can cause spillovers when food is added.
- If a combination of oils or fats will be used in frying, stir together before heating or as fats melt slowly.
- Always heat fat slowly, and watch as it heats.
- Use a deep fat thermometer whenever possible to prevent overheating fat beyond the smoking point.
- Use proper pan size—Avoid pans that are unstable or easily tipped. Select cookware having flat bottoms large enough to properly contain food and avoid boilovers and spillovers and large enough to cover burner grate. This will both save cleaning time and prevent hazardous accumulations of food, since heavy spattering or spillovers left on range can ignite. Use pans with handles that can be easily grasped and remain cool.
- When using glass cookware, make sure it is designed for top-of-range cooking.
- Keep all plastics away from top burners.



- Do not leave plastic items on the **cooktop**— they may melt if left too close to the vent.

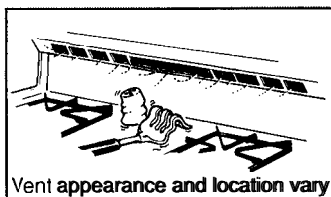

- Do not leave any items on the **cooktop**. The hot air from the vent may ignite flammable items and will increase pressure in closed containers, which may cause them to burst.
- To avoid the possibility of a burn, always be certain that the controls for all burners are at the OFF position and all grates are cool before attempting to remove them.
- When flaming foods are under the hood, turn the fan off. The fan, if operating, may spread the flames.
- If range is located near a window, do not hang long curtains that could blow over the top burners and create a fire hazard.
- If you smell gas, turn off the gas to the range and call a qualified service technician. Never use an open flame to locate a leak.

### Baking, Broiling and Roasting

- Do not use oven for a storage area. Items stored in the oven can ignite.
- Stand away from the range when opening the door of a hot oven. The hot air and steam that escape can cause burns to hands, face and eyes.
- Keep oven free from grease buildup.
- Place oven shelves in desired position while oven is cool.
- Pulling out shelf to the shelf-stop is a convenience in lifting heavy foods. It is also a precaution against burns from touching hot surfaces of the door or oven walls. The lowest position "R" is not designed to slide.
- Don't heat unopened food containers in the oven. Pressure could build up and the container could burst, causing an injury.
- Don't use aluminum foil anywhere in the oven except as described in this book. Misuse could result in a fire hazard or damage to the range.
- When using cooking or roasting bags in **oven**, follow the manufacturer's directions,

- Use only glass cookware that is recommended for use in gas ovens.
- Always remove broiler pan from oven as soon as you finish broiling. Grease left in the pan can catch fire if oven is used without removing the grease from the broiler pan.
- When broiling, if meat is too close to the **flame**, the fat may ignite. Trim excess fat to prevent excessive flare-ups.
- Make sure broiler pan is in place correctly to reduce the possibility of grease fires.
- If you should have a grease fire in the broiler pan, turn off oven, and keep oven door closed to contain fire until it bums out.

### Cleaning Your Range



- Clean only parts listed in this Use and Care Guide.
- **Keep range** clean and free of **accumulations** of grease or **spillovers**, which may ignite.

### Self-Cleaning Oven

- Do not clean door gasket. The door gasket is essential for a good seal. Care should be taken not to rub, damage or move the gasket.
- Do not use oven cleaners. No commercial oven cleaner or oven liner protective coating of any kind should be used in or around any part of the oven.
- Before self-cleaning the oven, remove broiler pan and other cookware.

### If You Need Service

- Read "The Problem Solver" in the back of this guide.
- Don't attempt to repair or replace any part of your range unless it is specifically recommended in this guide. All other servicing should be referred to a qualified technician.

**SAVE THESE  
INSTRUCTIONS**



# FEATURES OF YOUR RANGE

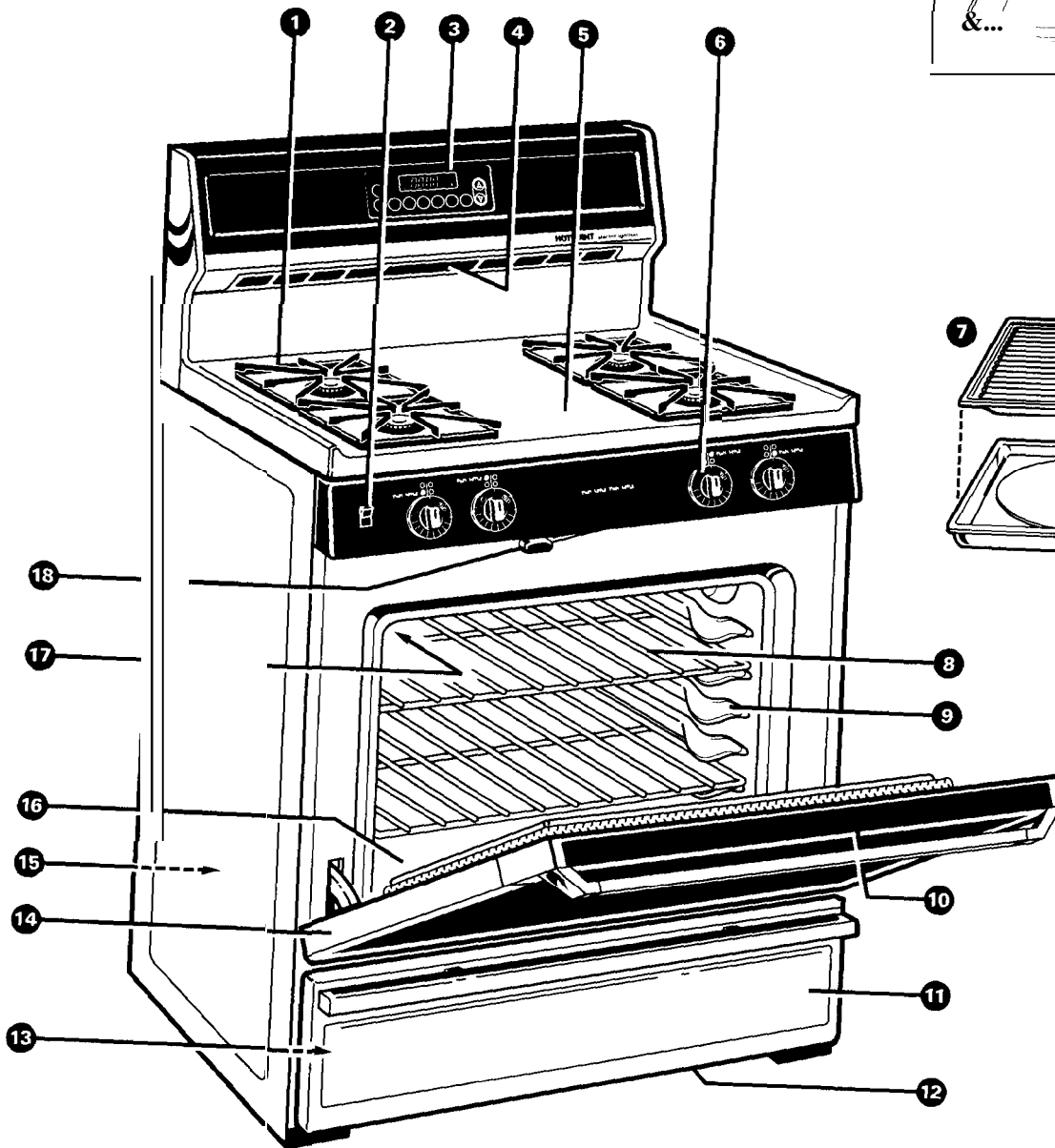
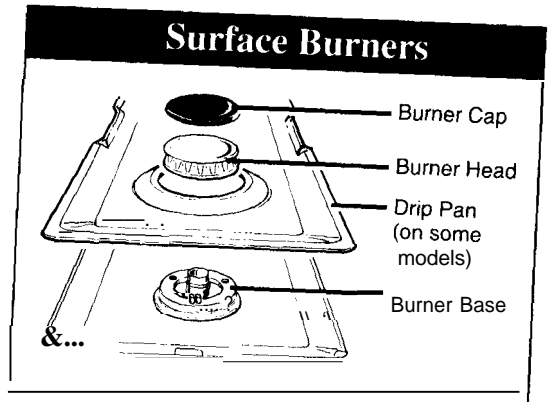



<b>Feature Index</b>	<b>See page</b>
1 Grates, Drip Pans (on models so equipped) and Surface Burners	25,26
2 Oven Lamp On/Off Switch	13
3 Oven Control, Clock and Timer	10, 11
4 Oven Vents	4,5, 13,30
5 Cooktop	27
6 Surface Burner Controls	8
7 Broiler Pan and Rack	18,20,26
8 Oven Shelves (Easily removed or repositioned on shelf supports.)	12, 16,22,27
9 Oven Shelf Supports	12
10 Air Vent in Oven Door (Top of Oven Door.)	4,30
11 Storage Drawer	29
12 Air Intake (Under Storage Drawer.)	<b>4,30</b>
13 Model and Serial Numbers (On front frame of range, behind storage drawer.)	2,6,34
14 Removable Oven Door (Easily removed for oven cleaning.)	28
15 Anti-Tip Device (Lower right rear corner on range back. See Installation Instructions.)	3,33,40
16 Oven Bottom	29,31,39
17 Oven Interior Light	13, 30
18 Oven Door Latch (Use for Self-Cleaning cycle only.)	14, 18,20, 22–24



# SURFACE COOKING

## Electric Ignition

Your surface burners are lighted by electric ignition, eliminating the need for standing pilot lights with constantly burning flames.

**In case of a power failure**, you can light the surface burners on your range with a match. Hold a lighted match to the burner, then turn the knob to the LITE position. **Use extreme caution when lighting burners this way.**

Surface burners in use when an electrical power failure occurs will continue to operate normally.

The electrode of the spark igniter is exposed. When one burner is turned to LITE, all the burners spark. Do not attempt to disassemble or clean around any burner while another burner is on. An electric shock may result, which could cause you to knock over hot cookware.

## Surface Burner Controls

Knobs that turn the surface burners on and off are marked as to which burners they control. The two knobs on the left control the left front and left rear burners. The two knobs on the right control the right front and right rear burners.

- The smaller burner (right rear position) will give the best simmer results.
- The right front burner is higher powered than the others and will bring liquids to a boil quicker (natural gas installations only).

## Before Lighting a Burner

- If drip pans are supplied with your range, they should be used at all times.
- Make sure the grates on the range are in place before using either burner.

## To Light a Surface Burner

**Push the control knob in and turn it to LITE.** You will hear a little “clicking” noise—the sound of the electric spark igniting the burner.

After the burner ignites, turn the knob to adjust the flame size.

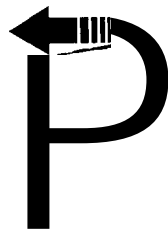

## After Lighting a Burner

- Check to be sure the burner you turned on is the one you want to use.
- Do not operate a burner for an extended period of time without cookware on the grate. The finish on the grate may chip without cookware to absorb the heat.
- Be sure the burners and grates are cool before you place your hand, a pot holder, cleaning cloths or other materials on them.



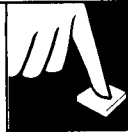

## How to Select Flame Size

Watch the flame, not the knob, as you reduce heat.

The flame size on a gas burner should match the cookware you are using.

FOR SAFE HANDLING OF COOKWARE NEVER LET THE FLAME EXTEND UP THE SIDES OF THE COOKWARE. Any flame larger than the bottom of the cookware is wasted and only serves to heat the handle.

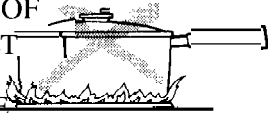

**When boiling,** adjust the flame so the circle it makes is about 1/2 inch smaller than the bottom of the cookware—no matter what the cookware is made of. Foods cook just as quickly at a gentle boil as they do at a furious, rolling boil. A high boil creates steam and cooks away moisture, flavor and nutrition. Avoid it except for the few cooking processes that need a vigorous boil.

**When frying or warming foods in stainless steel, cast iron or enamelware, keep the flame down lower—to about 1/2 the diameter of the pan.**

**When frying in glass or ceramic cookware, lower the flame even more.**

## Top-of-Range Cookware

**Aluminum:** Medium-weight cookware is recommended because it heats quickly and evenly. Most foods brown evenly in an aluminum skillet. Use saucepans with tight-fitting lids when cooking with minimum amounts of water.

**Cast-Iron:** If heated slowly, most skillets will give satisfactory results.

**Enamelware:** Under some conditions, the enamel of some cookware may melt. Follow cookware manufacturer's recommendations for cooking methods.

**Glass:** There are two types of glass cookware—those for oven use only and those for top-of-range cooking (saucepans, coffee and teapots). Glass conducts heat very slowly.

**Heatproof Glass Ceramic:** Can be used for either surface or oven cooking. It conducts heat very slowly and cools very slowly. Check cookware manufacturer's directions to be sure it can be used on gas ranges.

**Stainless Steel:** This metal alone has poor heating properties and is usually combined with copper, aluminum or other metals for improved heat distribution. Combination metal skillets usually work satisfactorily if they are used with medium heat as the manufacturer recommends.

## Wok Cooking

- We recommend that you use only a flat-bottomed wok. They are available at your local retail store.
- Do not use woks that have support rings. Use of these types of woks, with or without the ring in place, can be dangerous. Placing the ring over the burner grate may cause the burner to work improperly resulting in carbon monoxide levels above allowable current standards. This could be dangerous to your health. Do not try to use such woks without the ring. You could be seriously burned if the wok tipped over.

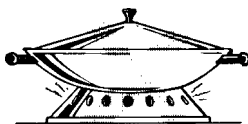

## Use of Stove Top Grills

Do not use stove top grills on your sealed gas burners. If you use the stove top grill on the sealed gas burner it will cause incomplete combustion and can result in exposure to carbon monoxide levels above allowable current standards. This can be hazardous to your health.

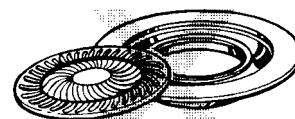



## FEATURES OF YOUR OVEN CONTROL

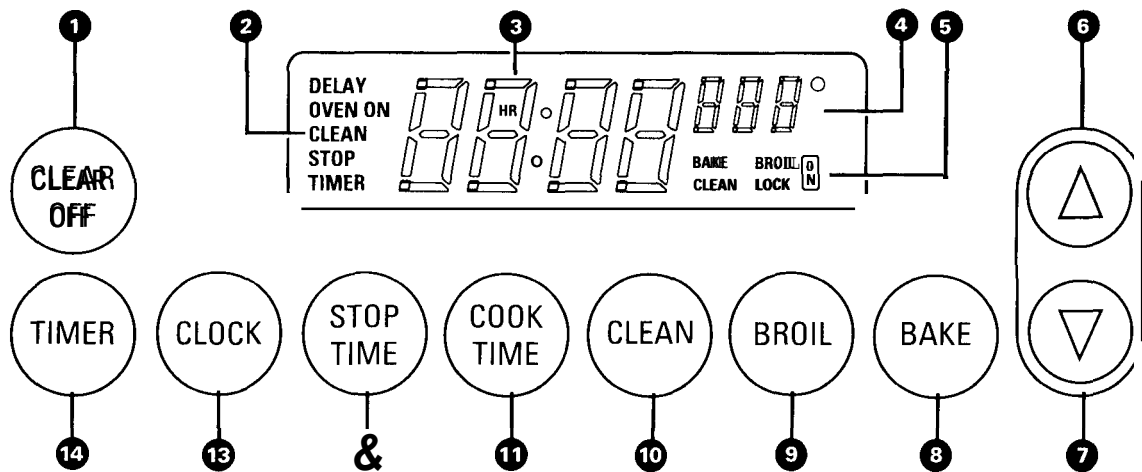

- 1. CLEAR/OFF.** Press this pad to cancel all oven operations except clock and timer.
- 2. PROGRAM STATUS.** Words light up in the display to indicate what is in time display.  
Programmed information can be displayed at any time by pressing the pad of the operation you want to see. For example, you can display the current time of day while the timer is counting down by pressing the CLOCK pad.
- 3. TIME DISPLAY.** Shows the time of day, the times set for the timer or automatic oven operation.
- 4. OVEN TEMPERATURE AND BROIL DISPLAY.** Shows the oven temperature or the broil setting selected.
- 5. FUNCTION INDICATORS.** Lights up to show whether oven is in bake, broil or self-clean mode.
- 6. INCREASE.** Short taps to this pad increase time or temperature by small amounts. Press and hold pad to increase time or temperature by larger amounts.
- 7. DECREASE.** Short taps to this pad decrease time or temperature by small amounts. Press and hold pad to decrease time or temperature by larger amounts.
- 8. BAKE.** Press this pad to select bake function.
- 9. BROIL.** Press this pad to select broil function.
- 10. CLEAN.** Press this pad to select self-cleaning function. See Self-Cleaning Instructions.
- 11. COOK TIME.** Press this pad for Time Bake operations.
- 12. STOP TIME.** Use this pad along with COOK TIME or CLEAN pad to set the oven to start automatically at a time you select.
- 13. CLOCK.** To set clock, first press CLOCK pad. Then press the INCREASE or DECREASE pad to change the time of day. Press the CLOCK pad to start.
- 14. TIMER.** Press this pad to select timer function. The timer does not control oven operations. The timer can time up to 9 hours and 55 minutes.  
To set timer, first press TIMER pad. Then press the INCREASE or DECREASE pad to change the time.

**If "F-" and a number flash on display and the control beeps, this indicates function error code.** If function error code appears during the self-cleaning cycle, check oven door latch. The latch handle may have been moved, even if only slightly, from the latched position. Make sure the latch is moved to the right as far as it will go. Press the CLEAR/OFF pad. Allow oven to cool for one hour. Put oven back into operation. If function error code repeats, disconnect power to the range and call for service.

# OVEN CONTROL, CLOCK AND TIMER



## Clock

The clock must be set for the **automatic oven timing functions** to work properly. The time of day **cannot be changed during a TIME BAKE or CLEAN cycle.**

### To Set the Clock



1. Press the **CLOCK** pad.

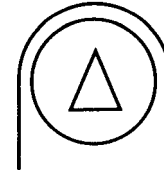

2. Press **INCREASE** or **DECREASE** pad to set the time of day.

3. Press the **CLOCK** pad to start.

## Timer

The timer is a minute timer; it does not control oven operations. The maximum setting on the timer is 9 hours and 55 minutes.

### To Set the Timer



1. Press the **TIMER** pad.

2. Press **INCREASE** or **DECREASE** pad to set the amount of time on timer.

The timer will start automatically within a few seconds of releasing the pad.

The timer, as you are setting it, will display seconds until 60 seconds is reached.

Then it will display minutes and seconds until 60 minutes is reached.

After 60 minutes, it will display hours ("HR" now appears in display) and minutes until the maximum time of 9 hours and 55 minutes is reached.

### To Reset Timer

Press **TIMER** pad and then press **INCREASE** or **DECREASE** pad until the time you want shows on the display.

### To Cancel Timer

Press **TIMER** pad until the word "TIMER" quits flashing on the display (about 4 seconds).

### Power Outage?

After a power outage, when power is restored, the display will flash and time shown will no longer be correct—for example, after a 5-minute power interruption the clock will be 5 minutes slow. The display flashes until the clock is reset. All other functions that were in operation when the power went out will have to be programmed again.

## End of Cycle Tones

The end of cycle tone is a series of three beeps followed by one beep every six seconds. If you would like to remove the signal that beeps every six seconds, press and hold the **CLEAR/OFF** pad for 10 seconds.

To return the signal that beeps every six seconds, press and hold the **CLEAR/OFF** pad for 10 seconds.

## Display Messages

If "**door**" appears on the display, the door latch handle is not moved all the way to the right. Move the latch handle and cleaning will start. If "**LOCK**" appears on the display, the oven door is in the locked position. **BAKE**, **BROIL** and **COOK TIME** cannot be set if the door is in the locked position.



# USING YOUR OVEN

## Before Using Your Oven

Be sure you understand how to set the controls properly. Practice removing and replacing the shelves while the oven is cool. Read the information and tips on the following pages. Keep this book handy where you can refer to it, especially during the first weeks of using your new range.

## Electric Ignition

**The oven burner and broil burner are lighted by electric ignition.**

**To light either burner**, press the pad for the desired function then press the INCREASE or DECREASE pad until the desired temperature is displayed. The burner should ignite within 30-90 seconds.

After the oven reaches the selected temperature, the oven burner cycles—off completely, then on with a full flame—to keep the oven temperature controlled.

## Power Outage

**CAUTION: DO NOT MAKE ANY ATTEMPT TO OPERATE THE ELECTRIC IGNITION OVEN DURING AN ELECTRICAL POWER FAILURE.**

The oven or broiler cannot be lit during a power failure. Gas will not flow unless the glow bar is hot.

If the oven is in use when a power failure occurs, the oven burner shuts off and cannot be re-lit until power is restored.

## Oven Shelves

The shelves are designed with stop-locks so when placed correctly on the shelf supports, they will stop before coming completely out of the oven and will not tilt when you are removing food from them or placing food on them.

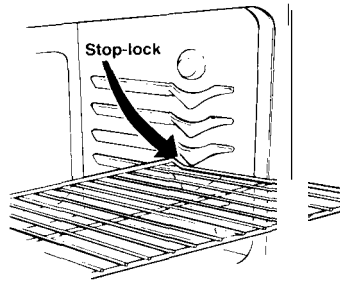

When placing cookware on a shelf, pull the shelf out to the “stop” position. Place the cookware on the shelf, then slide the shelf back into the oven. This will eliminate reaching into the hot oven.

**To remove a shelf** from the oven, pull it toward you, tilt front end upward and pull shelf out.

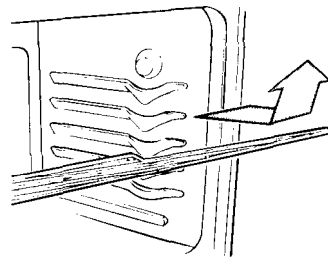

**To replace**, place shelf on shelf support with stop-locks (curved extension of shelf) facing up and toward rear of oven. Tilt up front and push shelf toward back of oven until it goes past “stop” on oven wall. Then lower front of shelf and push it all the way back.

## Shelf Positions

The oven has five shelf supports for normal baking and roasting identified in this illustration as A (bottom), B, C, D and E (top). It also has a special low shelf position (R) for roasting extra large items, such as a large turkey—the shelf is not designed to slide out at this position. Shelf positions for cooking are suggested on Baking and Roasting pages.

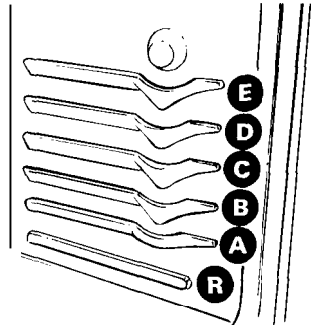

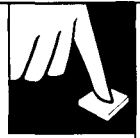

## Oven Moisture

As your oven heats up, the temperature change of the air in the oven may cause water droplets to form on the door glass. These droplets are harmless and will evaporate as the oven continues to heat up.

## Oven Vents

The oven is vented through duct openings at the rear of the cooktop. See Features section. Do not block these openings when cooking in the oven—it is important that the flow of hot air from the oven and fresh air to the oven burners be uninterrupted.

- **The vent openings and nearby surfaces may become hot. Do not touch them.**

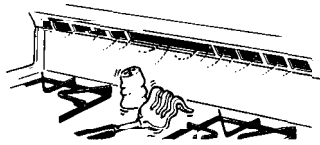

Vent appearance and location

- **Do not leave plastic items on the cooktop—they may melt if left too close to the vent.**

- **Handles of pots and pans on the cooktop may become hot if left too close to the vent.**
- **Metal items will become very hot if they are left on the cooktop and could cause burns.**
- **Do not leave any items on the cooktop.** The hot air from the vent may ignite flammable items and will increase pressure in closed containers, which may cause them to burst.

## Oven Light

The oven light comes on automatically when the door is opened. Use the switch on the lower control panel to turn the light on or off when the door is closed.

## Adjusting Oven Thermostat

When cooking a food for the first time in your new oven, use time given on recipes as a guide. Oven thermostats, over a period of years, may “drift” from the factory setting, and differences in timing between an old and a new oven of 5 to 10 minutes are not unusual. You may be inclined to think that the new oven is not performing correctly; however, your new oven has been set correctly at the factory and is more likely to be accurate than the oven it replaced.

If you think the oven should be hotter or cooler, you can adjust it yourself. To decide how much to change the thermostat, set the oven temperature 25°F. higher or lower than the temperature in your recipe, then bake. The results of this “test” should give you an idea of how much the thermostat should be changed.

### To adjust thermostat:

1. Press the BAKE pad.
2. Select an oven temperature between 500°F. and 550°F.
3. Immediately, before BAKE indicator stops flashing, press and hold the BAKE pad for about 4 seconds. The red display will change to the oven adjustment display.
4. The oven thermostat can be adjusted up to (+) 35°F. hotter or (–) 35°F. cooler. Use the INCREASE or DECREASE pads to select the desired change in the red display.
5. When you have made the adjustment, press the CLEAR/OFF pad to go back to the time of day display. Use your oven as you would normally.

**NOTE: This adjustment will not affect Broil or Clean temperatures. It will be remembered when power is removed.**



## BAKING

Your oven temperature is controlled very accurately using an oven control system. We recommend that you operate the range for a number of weeks to become familiar with your new oven's performance. If you think an adjustment is necessary, see the Using Your Oven section.

### How to Set Your Range for Baking

**Do not lock the oven door with the door latch during baking. This is used for self-cleaning only.**

**To avoid possible burns,** place the shelves in the correct position before you turn the oven on.



1. Press the BAKE pad.

2. Press the INCREASE or DECREASE pad until desired temperature is displayed.

When the oven starts to heat, the word "ON" and the changing temperature, starting at 100°F., will be displayed. When the oven reaches the temperature you set, a tone will sound.

To change oven temperature during BAKE cycle, press BAKE pad and then INCREASE or DECREASE pad to get new temperature.



3. Press the CLEAR/OFF pad when baking is finished.

## TIMED BAKING

The oven control allows you to turn the oven on or off automatically at specific times that you set. **NOTE: Before beginning make sure the oven clock shows the correct time of day.**

To set the clock, first press the CLOCK pad. "TIME" will flash in the display. Press INCREASE or DECREASE pad until correct time of day is displayed. Press the CLOCK pad to start.

**Do not lock the oven door with the door latch during time baking. This is used for self-cleaning only.**

### How to Set Immediate Start and Automatic Stop

The oven turns on right away, cooks for preset length of time, and turns off automatically at the selected Stop Time.

**To avoid possible burns,** place the shelves in the correct position before you turn the oven on.

1. Press COOK TIME pad.
2. Press INCREASE pad until the desired length of baking time appears in the display.
3. Press BAKE pad. Attention tone will occur if step 3 is not done.
4. Press INCREASE or DECREASE pad until desired temperature is displayed.

When the oven starts to heat, the word "ON" and the changing temperature, starting at 100°F., will be displayed. When the oven reaches the temperature you set, a tone will sound. The oven will continue to cook for the programmed amount of time, then shut off automatically.

5. Remove food from the oven. Remember, even though oven shuts off automatically, foods continue cooking after controls are off.

**NOTE:** Foods that spoil easily such as milk, eggs, fish, stuffings, poultry and pork should not be allowed to sit out for more than one hour before or after cooking. Room temperature promotes the growth of harmful bacteria. Be sure that the oven light is off because heat from the bulb will speed harmful bacteria growth.



## How to Set Delay Start and Stop

### Quick Reminder:

1. Press COOK TIME pad.
2. Press INCREASE/ DECREASE pad to set cooking time.
3. Press STOP TIME pad.
4. Press INCREASE/ DECREASE pad until desired Stop Time appears in display.
5. Press BAKE pad.
6. Press INCREASE/ DECREASE pad to select oven temperature.

Delay Start and Stop is setting the oven timer to turn the oven on and off automatically at a later time than the present time of day.

For example: Let's say it's 2:00 and dinner time is shortly after 7:00. The recipe suggests 3 hours baking time at 325°F. Here's how:

**To avoid possible burns,** place the shelves in the correct position before you set Delay Start.

1. Close the oven door.



2. Press COOK TIME pad.

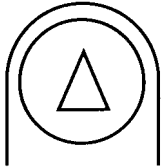

3. For 3 hours of cooking time, press INCREASE pad until "3:00" appears in the display.



4. Press STOP TIME pad.

"5:00" appears on the display and "STOP TIME" flashes. The control

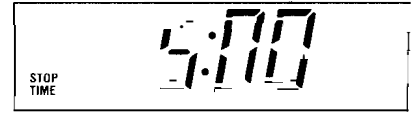

automatically sets Stop Time by adding the Cook Time to the time of day. In this example, the time of day is 2:00 and the Cook Time is 3 hours. Adding 3 hours to the time of day equals 5:00.

5. Change Stop Time from 5:00 to 7:00 by pressing INCREASE pad until "7:00" appears in the display.



6. Press BAKE pad.

7. Press INCREASE pad. The last oven set temperature appears in the display. Press INCREASE or DECREASE pad until "325°" is displayed.

At 4:00, the oven will turn on automatically. The word "ON" and the changing temperature, -starting at 100°F., will be displayed. When the oven reaches the temperature you set, a tone will sound. The oven will continue to cook for the programmed 3 hours and shut off automatically at 7:00.

8. Remove food from the oven. Remember, even though oven shuts off automatically, foods continue cooking after controls are off.

**NOTE:** When setting your oven for a Delay Start, never let foods that spoil easily such as milk, eggs, fish, stuffings, poultry and pork sit out for more than one hour before or after cooking. Room temperature promotes the growth of harmful bacteria. Be sure that the oven light is off because heat from the bulb will speed harmful bacteria growth.



# BAKING

(continued)

For best baking results, follow these suggestions:

## Oven Shelf

Arrange the oven shelf or shelves in the desired locations while the oven is cool. The correct shelf position depends on the kind of food and the browning desired. As a general rule, place most foods in the middle of the oven, on either the second or third shelf from the bottom. See the chart for suggested shelf positions

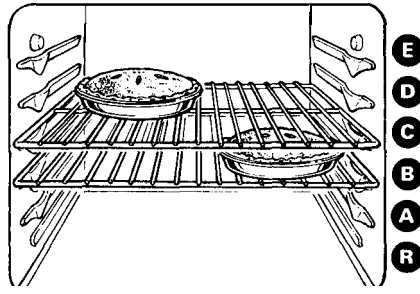

Type of Food	Shelf Position
Angel f-ood cake	A
Biscuits or muffins	B or C
Cookies or cupcakes	B or C
Brownies	B or C
Layer cakes	B or C
Bundt or pound cakes	A or B
Pies or pie shells	B or C
Frozen pies	A (on cookie sheet)
Casseroles	B or C
Roasting	A or B

## Preheating

Preheat the oven if the recipe calls for it. Preheat means bringing the oven up to the specified temperature before putting in the food. To preheat, set the oven at the correct temperature—selecting a higher temperature does not shorten preheat time.

Preheating is necessary for good results when baking cakes, cookies, pastry and breads. For most casseroles and roasts, preheating is not necessary. For ovens without a preheat indicator light or tone, preheat 10 minutes. After the oven is preheated place the food in the oven as quickly as possible to prevent heat from escaping.

## Baking Pans

Use the proper baking pan. The type of finish on the pan determines the amount of browning that will occur.

- Dark, rough or dull pans absorb heat resulting in a browner, crisper crust. Use this type for pies.
- Shiny, bright and smooth pans reflect heat, resulting in a lighter, more delicate browning. Cakes and cookies require this type of pan.
- Glass baking dishes also absorb heat. When baking in glass baking dishes, lower the temperature by 25°F. and use the recommended cooking time in the recipe. This is not necessary when baking pies or casseroles.

## Pan Placement

For even cooking and proper browning, there must be enough room t'or air circulation in the oven. Baking results will be better if baking pans are centered as much as possible rather than being placed to the front or to the back of the oven.

Pans should not touch each other or the walls of the oven. Allow 1 to 1½ inch space between pans as well as from the back of the oven, the door and the sides. If you use two shelves, stagger the pans so one is not directly above the other.





## Baking Guides

When using prepared baking mixes, follow package recipe or instructions for best baking results.

### Cookies

When baking cookies, flat cookie sheets (without sides) produce better-looking cookies. Cookies baked in a jelly roll pan (short sides all around) may have darker edges and pale or light browning may occur.

Do not use a cookie sheet so large that it touches the walls or the door of the oven.

For best results, use only one cookie sheet in the oven at a time.

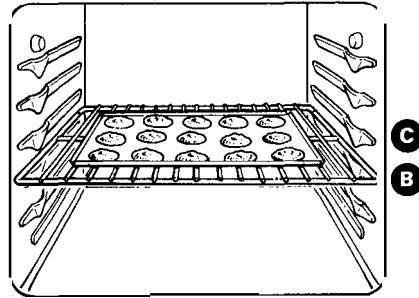

### Pies

For best results, bake pies in dark, rough or dull pans to produce a browner, crisper crust. Frozen pies in foil pans should be placed on an aluminum cookie sheet for baking since the shiny foil pan reflects heat away from the pie crust; the cookie sheet helps retain it.

### Cakes

When baking cakes, warped or bent pans will cause uneven baking results and poorly shaped products. A cake baked in a pan larger than the recipe recommends will usually be crisper, thinner and drier than it should be. If baked in a pan smaller than recommended, it may be undercooked and batter may overflow. Check the recipe to make sure the pan size used is the one recommended.

### Aluminum Foil

Never cover a shelf entirely with a large cookie sheet or aluminum foil. This will disturb the heat circulation and results in poor baking. A smaller sheet of foil may be used to catch a spillover by placing it on a lower shelf several inches below the food.

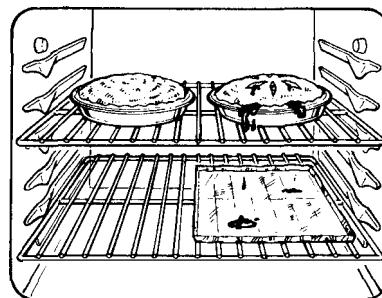

### Don't Peek

Set the timer for the estimated cooking time and do not open the door to look at your food. Most recipes provide minimum and maximum baking times such as "bake 30-40 minutes."

DO NOT open the door to check until the minimum time. Opening the oven door frequently during cooking allows heat to escape and makes baking times longer. Your baking results may also be affected.



# ROASTING

**Do not lock the oven door with the door latch during roasting. This is used for self-cleaning only.**

Roasting is cooking by dry heat. Tender meat or poultry can be roasted uncovered in your oven. Roasting temperatures, which should be low and steady, keep spattering to a minimum.

The oven has a special low shelf (R) position just above the oven bottom. Use it when extra cooking space is needed, for example, when roasting a large turkey. The shelf is not designed to slide out at this position.

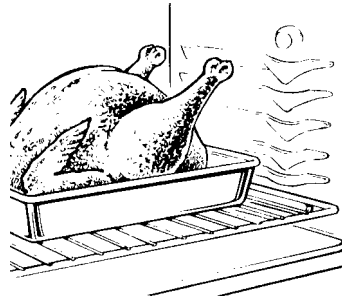

Roasting is really a baking procedure used for meats. Therefore, oven controls are set for **BAKE** or **TIME BAKE**. (You may hear a slight clicking sound, indicating the oven is working properly.) Roasting is easy; just follow these steps:

1. Place the shelf in A or B position for small size roasts (3 to 5 lbs.) and R position for larger roasts. No preheating is necessary.

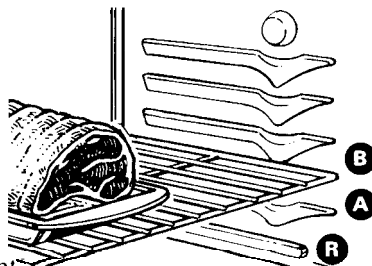

2. Check the weight of the meat. Place the meat fa-side-up, or poultry breast-side-up, on roasting rack in a shallow pan. The melting fat will baste the meat. Select a pan as close to the size of the meat as possible. (Broiler pan with rack is a good pan for this.) Line broiler pan with aluminum foil when using pan for marinating, cooking with fruits, cooking heavily cured meats, or basting food during cooking. Avoid spilling these materials inside the oven or inside the oven door.



3. Press the **BAKE** pad.

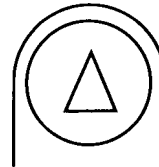

4. Press **INCREASE** or **DECREASE** pad until desired temperature is displayed.

When the oven starts to heat, the word "ON" and the changing temperature, starting at 100°F., will be displayed. When the oven reaches the temperature you set a tone will sound.

To change oven temperature during roasting, press the **BAKE** pad and then **INCREASE** or **DECREASE** pad to get new temperature.



5. Press the **CLEAR/OFF** pad when roasting is finished and then remove food from oven.

6. Most meats continue to cook slightly while standing, after being removed from the oven. Standing time recommended for roasts is 10 to 20 minutes. This allows roasts to firm up and makes them easier to carve. Internal temperature will rise about 5° to 10° F.; to compensate for temperature increase, if desired, remove the roast from oven sooner (at 5° to 10° F. less than temperature in the Roasting Guide).

**NOTE:** You may wish to **TIME BAKE**, as described in the Baking section of this book, to turn oven on and off automatically.

Remember that food will continue to cook in the hot oven and (here fore should be removed when the desired internal temperature has been reached.

## For Frozen Roasts

- Frozen roasts of beef, pork, lamb, etc., can be started without thawing, but allow 10 to 25 minutes per pound additional time (10 minutes per pound for roasts under 5 pounds, more time for larger roasts).
- Thaw most frozen poultry before roasting to ensure even doneness. Some commercial frozen poultry can be cooked successfully without thawing. Follow directions given on package label.

## Dual Shelf Cooking

This allows more than one food to be cooked at the same time. For example: While roasting a 20 lb. turkey on shelf (R) a second shelf may be added on position D so that scalloped potatoes can be cooked at the same time. Calculate the total cooking time to enable both dishes to complete cooking at the same time. Allow 15-20 minutes of additional cooking time for the potatoes."



## Questions and Answers

**Q. Is it necessary to check for doneness with a meat thermometer?**

**A.** Checking the finished internal temperature at the completion of cooking time is recommended. Temperatures are shown in Roasting Guide. For roasts over 8 lbs., check with thermometer at half-hour intervals after half the time has passed.

**Q. Why is my roast crumbling when I try to carve it?**

**A.** Roasts are easier to slice if allowed to cool 10 to 20 minutes after removing from oven. Be sure to cut across the grain of the meat.

**Q. Do I need to preheat my oven each time I cook a roast or poultry?**

**A.** It is unnecessary to preheat your oven.

**Q. When buying a roast, are there any special tips that would help me cook it more evenly?**

**A. Yes.** Buy a roast as even in thickness as possible, or buy rolled roasts.

**Q. Can I seal the sides of my foil "tent" when roasting a turkey?**

**A.** Sealing the foil will steam the meat. Leaving it unsealed allows the air to circulate and brown the meat.

## ROASTING GUIDE

Type	Oven Temperature	Doneness	Approximate Roasting Time in Minutes per Pound		Internal temperature °F.
<b>Meat</b> Tender cuts; rib, high quality sirloin tip, rump or top round†	325°	Rare: Medium: Well Done:	<b>3 to 5 lbs.</b> <b>24-35</b>	<b>6 to 8 lbs.</b> <b>18-25</b>	400-1 SO** 50°-1600
Lamb leg or bone-in shoulder+	325°	Rare: Medium: Well Done:	<b>21-25</b> <b>25-30</b>	<b>20-23</b> <b>24-28</b>	400-1500 50°-1600
Veal shoulder, leg or loin†	325°	Well Done:	30-35	28-33	700-1850
Pork loin, rib or shoulder†	325°	Well Done:	35-45	30-40	700-1800
Ham, precooked	325°	To Warm:	<b>18-23</b> minutes per pound (any weight)		700-1800 1150-125°
<b>Poultry</b> <b>Chicken</b> or Duck Chicken pieces	325° 350	Well Done: Well Done:	<b>3 to 5 lbs.</b> 35-40 35-40	<b>Over 5 lbs.</b> 30-35	185°-1900 185°-1900
Turkey	325°	Well Done:	<b>10 to 15 lbs.</b> <b>16-22</b>	<b>Over 15 lbs</b> 12-19	<b>In thigh:</b> <b>185°-1900</b>

†For boneless rolled roasts over 6 inches thick, add 5 to 10 minutes per pound to times given above.

\*The U.S. Department of Agriculture says "Rare beef is popular, but you should know that cooking it to only 140°F. means some food poisoning organisms may survive." (Source: Safe Food Book. Your Kitchen Guide. USDA Rev. June 1985. )



# BROILING

Broiling is cooking food by intense radiant heat from the upper unit in the oven. Most fish and tender cuts of meat can be broiled. Follow these steps to keep spattering and smoking to a minimum.

**The oven door should be closed during broiling. Do not lock the oven door with the door latch during broiling. This is used for self-cleaning only.**

1. If meat has fat or gristle near edge, cut vertical slashes through both about 2" apart. If desired, fat may be trimmed, leaving layer about 1/8" thick.
2. Place meat on broiler rack in broiler pan. Always use rack so fat drips into broiler pan; otherwise juices may become hot enough to catch fire.
3. Position shelf on recommended shelf position as suggested in Broiling Guide.
4. Close the oven door, but do not latch it. **If the door handle is moved to the right during a broil operation, the door may lock** and you may not be able to open it until the oven has cooled.
5. Press BROIL pad.

6. Select LO Broil (450°F.) by tapping INCREASE pad once. Select HI Broil (550°F.) by tapping INCREASE pad twice.

To change from HI Broil to LO Broil, press the BROIL pad then tap DECREASE pad once.

7. Turn food only once during cooking. Time foods for first side per Broiling Guide.

Turn food, then use times given for second side as a guide to preferred doneness. (Where two thicknesses and times are given together, use first times given for thinnest food.)

8. When broiling is completed press the CLEAR/OFF pad. Serve food immediately, and leave pan outside oven to cool during meal for easiest cleaning.

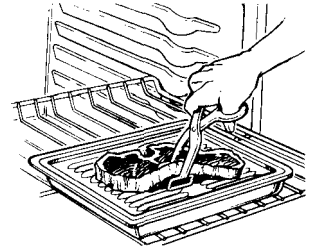

## Use of Aluminum Foil

You can use aluminum foil to line your broiler pan and broiler rack. However, you must mold the foil tightly to the rack and cut slits in it just like the rack.

Without the slits, the foil will prevent fat and meat juices from draining to the broiler pan. The juices could become hot enough to catch on fire. If you do not cut the slits, you are frying, not broiling.



## Questions & Answers

**Q. When broiling, is it necessary to always use a rack in the pan?**

**A. Yes.** Using the rack suspends the meat over the pan. As the meat cooks, the juices fall into the pan, thus keeping meat drier. Juices are protected by the rack and stay cooler, thus preventing excessive spatter and smoking.

**Q. Should I salt the meat before broiling?**

**A. No.** Salt draws out the juices and allows them to evaporate. Always salt after cooking. Turn meat with tongs; piercing meat with a fork also allows juices to escape. When broiling poultry or fish, brush each side often with butter.

**Q. Do I need to grease my broiler rack to prevent meat from sticking?**

**A. No.** The broiler rack is designed to reflect broiler heat, thus keeping the surface cool enough to prevent meat from sticking to the surface. However, spraying the broiler rack lightly with a vegetable cooking spray before cooking will make clean up easier.

**Q. Why are my meats not turning out as brown as they should?**

**A.** Check to see if you are using the recommended shelf position. Broil for longest period of time indicated in the broiling Guide. Turn food only once during broiling.



1. Always use broiler pan and rack that comes with your oven. It is designed to minimize smoking and spattering by trapping juices in the shielded lower part of the pan.
2. Broiling should always be done with the oven door closed.
3. For steaks and chops, slash fat evenly around outside edges of meat. To slash, cut crosswise through outer fat surface just to the edge of the meat. Use tongs to turn meat over to prevent piercing meat and losing juices.
4. If desired, marinate meats or chicken before broiling or brush with barbecue sauce last 5 to 10 minutes only.
5. When arranging food on pan, do not let fatty edges hang over sides, which could soil oven with fat dripping.
6. Broiler does not need to be preheated. However, for very thin foods, or to increase browning, preheat if desired.
7. Frozen steaks can be broiled by positioning the oven shelf at next lowest shelf position and increasing cooking time given in this guide 1 1/2 times per side.

## BROILING GUIDE

Food	Quantity and/or Thickness	Shelf Position	HI or 1.0 Broil	First Side Time, Minutes	Second Side Time, Minutes	Comments
<b>Bacon</b>	1/2 lb. (about 8 thin slices)	C	HI	3 1/2	3	Arrange in single layer.
<b>Ground Beef Well Done</b>	1 lb. (4 patties) 1/2 to 3/4 inch thick	C	HI	10-11	4-5	Space evenly. Up to 8 patties take about same time.
<b>Beef Steaks</b>						
Rare	1 inch thick	B	HI	9	7	Steaks less than 1 inch thick cook through before browning. Pan frying is recommended. Slash fat.
Medium	(1 10 1/2 lbs.)	B		12	5-6	
Well Done		B		13	8-9	
Rare	1 1/2 inch thick	B		10	6-7	
Medium	(2 to 2 1/2 lbs.)	B		12-15	10-12	
Well Done		B		25	16-18	
<b>Chicken</b>	1 whole (2 to 2 1/2 lbs.), split lengthwise	B	LO	30-35	25-30	Reduce time about 5 to 10 minutes per side for cut-up chicken. Brush each side with melted butter. Broil skin-side-down first and broil with door closed.
<b>Bakery Products</b>						
Bread (Toast) or Toaster Pastries	2 to 4 slices	C	HI	2-3	1/2-1	Space evenly. Place English muffins cut-side-up and brush with butter, if desired.
English Muffins	1 pkg. (2) 2 (split)	C		3-5		
<b>Lobster Tails</b>	2-4 (6 to 8 oz. each)	C	HI	13-16	Do not turn over	Cut through back of shell. Spread open. Brush with melted butter before and after half of broiling time.
<b>Fish</b>	1 -lb. fillets 1/4 to 1/2 inch thick	B	HI	5	5	Handle and turn very carefully. Brush with lemon butter before and during cooking if desired. Preheat broiler to increase browning.
<b>Ham Slices (precooked)</b>	1 inch thick	C	LO	X	8	Increase time 5 to 10 minutes per side for 1 1/2 inch thick or home cured ham.
<b>Pork Chops Well Done</b>	2 (1/2 inch thick) 2 (1 inch thick) about 1 lb.	B B	HI	10 13	4-5 9-12	Slash fat
<b>Lamb Chops</b>						
Medium Well Done	2 (1 inch thick) about 10 (10 12 oz.)	B B	HI	11 10	4-7 10	Slash fat.
Medium Well Done	2 (1 1/2 inch thick) about 1 lb.	B B		10 17	4-6 12-14	
<b>Wieners and similar precooked sausages, bratwurst</b>	1-lb. pkg. (10)	C	HI	6	1-2	



# OPERATING THE SELF-CLEANING OVEN

Normal Cleaning Time: 4 hours

## Before a Clean Cycle

### Quick Reminder:

1. Prepare the oven for cleaning.
2. Close and latch the oven door.
3. Press the CLEAN pad.
4. Press the INCREASE pad.

If you wish to change preset clean time of 4 hours, press the INCREASE or DECREASE pad until desired stop time appears in the display.

1. Remove the broiler pan, broiler rack, all cookware and any aluminum foil from the oven— they cannot withstand the high cleaning temperatures. (Oven shelves may be left in oven. NOTE: Shelves will discolor after the self-clean cycle.)
2. Wipe up heavy soil on the oven bottom.

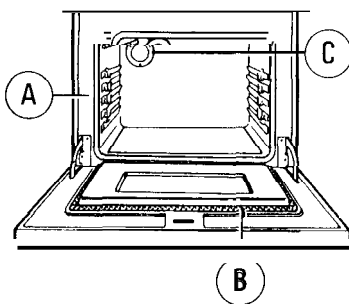

- A. oven Front Frame
- B. Oven Door Gasket
- C. Oven Light

3. Clean spatters or spills on the oven front frame (A) and only that area on the oven door that is outside the gasket (B). Do not clean the gasket. Use detergent and hot water with a soap-filled steel wool pad, then rinse well with a vinegar and water mixture. This will help prevent a brown residue from forming when the oven is heated. Buff these areas with a dry cloth. Never use a commercial oven cleaner in or around the self-cleaning oven.

- Clean top, sides and outside front of oven door with soap and water. Do not use abrasives or oven cleaners.
- Do not rub or clean the door gasket (B)—the fiberglass material of the gasket has an extremely low resistance to abrasion. An intact and well-fitting oven door gasket is essential for energy-efficient oven operation and good baking results. If you notice the gasket becoming worn, frayed or damaged in any way or if it has become displaced on the door, you should have it replaced.
- 4. Close and latch the door. Make sure the oven light (C) is off.

Oven shelves may be cleaned in the self-cleaning oven. However, they will darken, lose their luster and become hard to slide. Wipe the shelf supports with cooking oil after self-cleaning to make shelves slide more easily.

### Caution:

- Drip pans should never be cleaned in the self-cleaning oven.
- Do not use commercial oven cleaners or oven protectors in or near the self-cleaning oven. A combination of any of these products plus the high clean cycle temperatures may damage the porcelain finish of the oven.

### Important

- The oven door must be closed and latched and all controls must be set correctly for the clean cycle to work properly.

## How to Set Oven for Cleaning

1. Follow steps above to prepare the oven for cleaning.
2. Close the oven door and slide the latch handle to the right as far as it will go.

**Never force the door latch handle. Forcing the handle may damage the door lock mechanism.**



3. Press the CLEAN pad.
4. Press the INCREASE or DECREASE pad until desired Clean Time is displayed.

Clean Time is normally 4 hours. You can change the Clean Time to anywhere between 2 and 4 hours, depending on how dirty the oven is. The self-clean cycle will automatically begin within a few seconds after the word "CLEAN" is displayed and the word "ON" appears on the display. When the oven heats to a high temperature, the word "LOCK" will be displayed and, a short time later, the door latch handle will be locked in position. It will not be possible to open the oven door until the temperature drops below the lock temperature.

5. When the LOCK light is off, slide the latch handle to the left as far as it will go and open the door.



## After a Clean Cycle

When the clean cycle is finished, the word “CLEAN” will go out in the display and the oven will begin to cool. When the oven temperature has fallen below the locking temperature the word “LOCK” goes out and the door can be opened.

After a clean cycle, you may notice some white ash in the oven. Just wipe it up with a damp cloth. If white spots remain, remove them with a soap-tipped steel wool pad. Be sure to rinse thoroughly with a vinegar and water mixture. These deposits are usually a salt residue that cannot be removed by the clean cycle.

If the oven is not clean after one clean cycle, the cycle may be repeated.

## How to Delay Start of Cleaning

Delay Start is setting the oven timer to start the clean cycle automatically at a later time than the present time of day. **NOTE:** Before beginning, make sure the oven clock shows the correct time of day.

### Quick Reminder—Delay Start for Self-Clean:

1. Prepare the oven for cleaning.
2. Close and latch the oven door.
3. Press the CLEAN pad.
4. Press the INCREASE pad. If you wish to change preset clean time of 4 hours, touch the INCREASE/DECREASE pad until desired time appears.
5. Press the STOP TIME pad.

Time that appears is 4 hours later than the time of day. Press the INCREASE pad until the Stop Time you desire appears in the display. The self-clean cycle will automatically begin 4 hours before the Stop Time you select.

For example: Let's say it's 7:00 and you want the oven to begin self-cleaning at 9:00 after you're finished in the kitchen. The oven has been preset to clean for four hours.

1. Prepare the oven for cleaning.
2. Close the oven door and slide the latch handle to the right as far as it will go. Make sure the oven light is off.



3. Press the CLEAN pad.

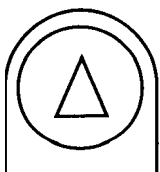

4. Press the INCREASE pad. The oven is set.

5. Clean Time is preset for 4 hours. You can change the clean time to anywhere between 2 and 4 hours, depending on how dirty the oven is. If a shorter Clean Time is desired, press the DECREASE pad until the desired Clean Time is displayed.



6. Press the STOP TIME pad. “11:00” appears on display and “STOP TIME” flashes. The control automatically sets Stop Time by adding the Clean Time to the time of day. In this example, the time of day is 7:00 and the Clean Time is 4 hours. Adding 4 hours to the time of day equals 11:00.

7. Change Stop Time from 11:00 to 1:00 by pressing the INCREASE pad until “1:00” appears in the display. The words “DELAY CLEAN” will also appear in the display.

The self-clean cycle will automatically begin at 9:00 and finish at 1:00. The word “ON” will appear on the display at 9:00.

When the oven locks, the word “LOCK” will be displayed and a short time later, the door latch handle will be locked in position. It will not be possible to open the oven door until the temperature drops below the lock temperature.

When the clean cycle is finished, the word “CLEAN” will go out in the display and the oven will begin to cool. When the oven temperature has fallen below the locking temperature the word “LOCK” goes out and the door can be opened.

8. When the LOCK light is off, slide the latch handle to the left as far as it will go and open the door.

**Never force the latch handle. Wait until the word “LOCK” goes out in the display. Forcing the latch handle may damage the door lock.**

*(continued next page)*



# OPERATING THE SELF-CLEANING OVEN

(continued)

## Questions and Answers

**Q. If my oven clock is not working, can I still self-clean my oven?**

**A.** If the clock is not working then the entire control is not working. If the clock is not set to the correct time of day you will not be able to set a delay clean to end at a specific time.

**Q. Can I use commercial oven cleaners on any part of my self-cleaning oven?**

**A.** No cleaners or coatings should be used around any part of this oven. If you do use them and do not thoroughly rinse the oven with water, wiping it absolutely clean afterwards, the residue can scar the oven surface and damage metal parts the next time the oven is automatically cleaned.

**Q. What should I do if excessive smoking occurs during cleaning?**

**A.** This is caused by excessive soil. Press the CLEAR/OFF pad. Open windows to rid room of smoke. Wait until the oven has cooled (about 20-30 minutes) and the word "LOCK" is off in the display. Wipe up the excess soil and reset the clean cycle.

**Q. Is the "crackling" sound I hear during cleaning normal?**

**A. Yes.** This is the sound of the metal heating and cooling during both the cooking and cleaning functions.

**Q. Should there be any odor during the cleaning?**

**A. Yes,** there may be a slight odor during the first few cleanings. Failure to wipe out excessive soil might also cause a strong odor when cleaning.

**Q. What causes the hair-like lines on the enameled surface of my oven?**

**A.** This is a normal condition, resulting from heating and cooling during cleaning. These lines do not affect how your oven performs.

**Q. Why do I have ash left in my oven after cleaning?**

**A.** Some types of soil will leave a deposit which is ash. It can be removed with a damp sponge or cloth.

**Q. My oven shelves do not slide easily. What is the matter?**

**A.** After many cleanings, oven shelves may become so clean they do not slide easily. To make shelves slide more easily, after each self-cleaning function dampen fingers with a small amount of cooking oil and rub lightly over sides of shelf where they contact shelf supports.

**Q. My oven shelves have become gray after the self-clean cycle. Is this normal?**

**A. Yes.** After the self-clean cycle, the shelves may lose some luster and change to a deep gray color.

**Q. The word "door" appeared on the display when I selected the Clean Cycle. What is wrong?**

**A.** The door latch handle must be moved all the way to the right. Move the latch handle and cleaning will start.



# CARE AND CLEANING



Proper care and cleaning are important so your range will give you efficient and satisfactory service. Follow these directions carefully in caring for it to help assure safe and proper maintenance.

**BE SURE ELECTRICAL POWER IS DISCONNECTED BEFORE CLEANING ANY PART OF YOUR RANGE.**

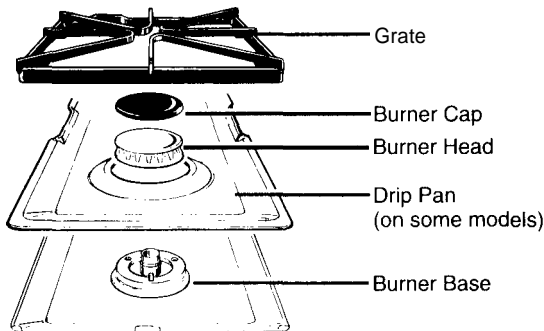

## Burner Assemblies

**CAUTION: DO NOT OPERATE THE BURNER WITHOUT ALL BURNER PARTS AND DRIP PANS (IF SO EQUIPPED) IN PLACE.**

The burner assemblies should be cleaned thoroughly after spillovers.

Turn all controls OFF before removing burner parts and drip pans (if so equipped).

The burner grates, caps, burner heads and drip pans (if so equipped) can be lifted off, making them easy to clean.

The electrode of the spark igniter is exposed. When one burner is turned to LITE, all the burners spark. Do not attempt to disassemble or clean around any burner while another burner is on. An electric shock may result, which could cause you to knock over hot cookware.

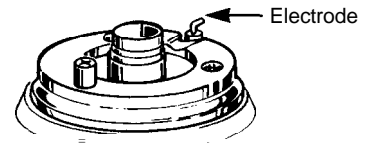

## Burner Caps

Lift off when cool. Wash burner caps in hot, soapy water and rinse with clean water. If desired, soak up to 30 minutes and scour with a plastic scouring pad to remove burned-on food particles. Dry them in a warm oven or with a cloth—don't reassemble them wet.

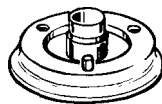

## Burner Base

The burner base (the part of the burner fastened to the cooktop) may be cleaned with a soft brush and a mild cleanser. Clean all food residues from around spark electrode. Do not use steel wool; small bits of steel wool will short out the electrode. Rinse well.

*(continued next page)*

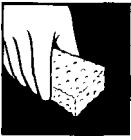

# CARE AND CLEANING

(continued)

## Burner Heads

The holes in the burners of your range and the spark electrodes, must be kept clean at all times for proper ignition and an even, unhampered flame.



You should clean the burner heads routinely, especially after bad spillovers, which could clog these holes. Wipe off burner heads. If heavy spillover occurs, remove burner heads from range.

Remove the burner grate and burner cap. Then lift the burner head straight up.

To remove burned-on food, soak the burner head upside-down in a solution of mild liquid detergent and hot water. Soak the burner head for 20 to 30 minutes. If the food doesn't rinse off completely, scrub it with soap and water and a soft brush or plastic scouring pad.

For more stubborn stains, use a cleanser like Soft Scrub® brand or Bon Ami® brand. Rinse well to remove any traces of the cleanser that might clog the burner openings. Do not use steel wool because it will clog the burner openings and scratch the burners. If the holes become clogged, clean them with a toothpick.

Do not clean the burner head in the self-cleaning oven.

Before putting the burner head back, shake out excess water and dry it thoroughly by setting it in a warm oven for 30 minutes. Then place it back in the range, making sure the pin in the burner base goes in the hole in the burner head, and that the burner heads are properly seated and level.

## Burner Grates

Lift out when cool.

Grates should be washed regularly and, of course,

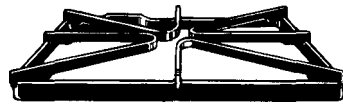

after spillovers. Wash them in hot, soapy water and rinse with clean water. After cleaning, dry them thoroughly by putting them in a warm oven for a few minutes. Don't put the grates back on the range while they are wet. When replacing the grates, be sure they're positioned securely over the burners.

To get rid of burned-on food, place the grates in a covered container (or plastic bag) with 1/4 cup ammonia to loosen the soil. Then scrub with a soap-filled scouring pad if necessary.

Although they're durable, the grates will gradually lose their shine, regardless of the best care you can give them. This is due to their continual exposure to high temperatures.

Do not operate a burner for an extended period of time without cookware on the grate. The finish on the grate may chip without cookware to absorb the heat.

## Drip Pans (on some models)

Remove the grates and lift out the drip pans. Drip pans can be cleaned in dishwasher or by hand. Place them in a covered container (or plastic bag) with 1/4 cup ammonia to loosen the soil. Then scrub with a soap-filled scouring pad if necessary.

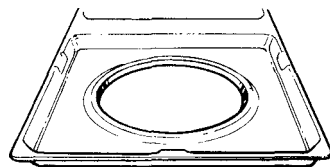

**Caution:** Drip pans CANNOT be self-cleaned.

## Broiler Pan and Rack

After broiling, remove the broiler pan and rack from the oven. Remove the rack from the pan. Carefully pour out the grease in the pan into a proper container.

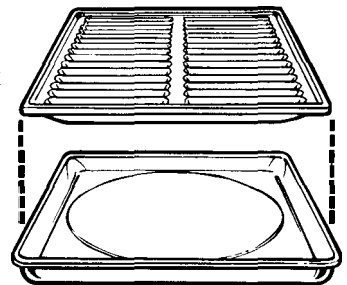

If food has burned on, sprinkle the rack with detergent while hot and cover with wet paper towels or a dishcloth. That way, burned-on foods will soak loose while the meal is being served.

Wash; scour if necessary. Rinse and dry. The broiler pan and rack may also be cleaned in a dishwasher. Do not store a soiled broiler pan and rack anywhere in the range. Do not clean in self-cleaning oven.

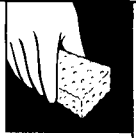

## Cooktop Surface

To avoid damaging the porcelain enamel surface of the cooktop and to prevent it from becoming dull, clean up spills right away. Foods with a lot of acid (tomatoes, sauerkraut, fruit juices, etc.) or foods with high sugar content could cause a dull spot if allowed to set.

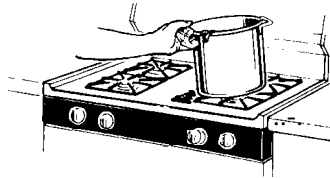

When the surface has cooled, wash and rinse. For other spills such as fat smatterings, etc., wash with soap and water once the surface has cooled. Then rinse and polish with a dry cloth.

**Do not store flammable materials in an oven or near the cooktop.** Do not store or use combustible materials, gasoline or other flammable vapors and liquids in the vicinity of this or any other appliance.

## Control Panel and Knobs

It's a good idea to wipe the control panel after each use of the oven. Clean with mild soap and water or vinegar and water, rinse with clean water and polish dry with a soft cloth.

Do not use abrasive cleansers, strong liquid cleaners, plastic scouring pads or oven cleaners on the control panel—they will damage the finish. A 50/50" solution of vinegar and hot water works well.

The control knobs may be removed for easier cleaning. To remove knob, pull it straight off the stem. If knob is difficult to remove, place a towel or dishcloth between the knob and control panel and pull gently. Wash the knobs in soap and water or a vinegar and hot water solution but do not soak.

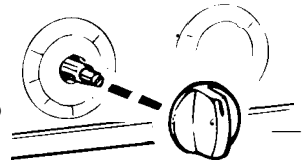

To clean outside glass finish, use a glass cleaner. Do not allow the water or cleaner to run down inside openings in the glass while cleaning.

Metal parts can be cleaned with soap and water. Do not use steel wool, abrasives, ammonia, acids or commercial oven cleaners. Dry with a soft cloth.

## Oven Shelves

Shelves can be cleaned by hand using soap and water or with an abrasive cleanser. After cleaning, rinse the shelves with clean water and dry. To remove heavy, burned-on soil, you may use scouring pads. After" scrubbing, wash with soapy water, rinse and dry.

Shelves may also be cleaned in self-cleaning oven, but will discolor and lose some luster. See the Self-Cleaning section.

*(continued next page)*

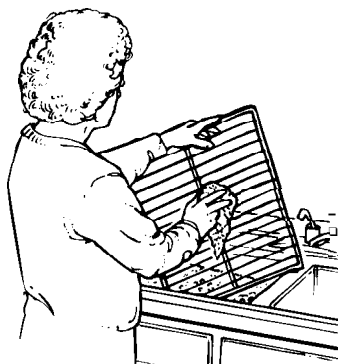

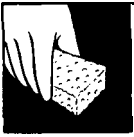

# CARE AND CLEANING

(continued)

## Lift-Off Oven Door

The oven door is removable but it is heavy. You may need help removing and replacing the door.

**To remove the door**, open it a few inches to the special “stop” position that will hold the door open. Grasp firmly on each side and lift the door straight up and off the hinges.

**NOTE:** Be careful not to place hands between the spring hinge and the oven frame as the spring hinge could snap back and pinch your fingers.

**To replace the door**, make sure the hinges are in the “out” position. Position the slots in the bottom of the door squarely over the hinges. Then lower the door slowly and evenly over both hinges at the same time.

### TO CLEAN THE DOOR:

(Do not immerse door in water.)

#### Inside of door:

- Because the area inside the gasket is cleaned during the self clean cycle, you do not need to clean this by hand. Any soap left on the liner causes additional stains when the oven is heated.
- The area outside the gasket can be cleaned with a scouring pad.
- Do not rub or clean the door gasket—the fiberglass material of the gasket has an extremely low resistance to abrasion. An intact and well-fitting oven door gasket is essential for energy-efficient oven operation and good baking results. If you notice the gasket becoming worn, frayed or damaged in any way or if it has become displaced on the door, you should have it replaced.

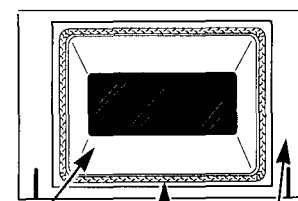
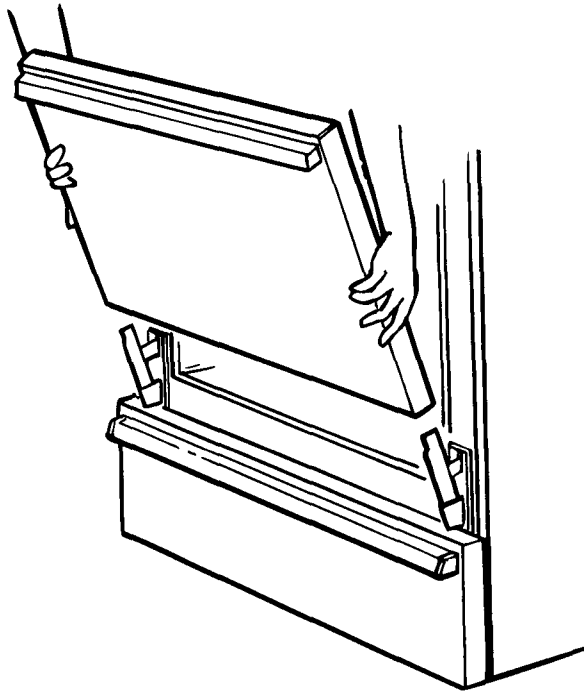

Inside Gasket      Gasket      Outside Gasket

#### Outside of door:

- Use soap and water to thoroughly clean the top, sides and front of the oven door. Rinse well. You may also use a glass cleaner to clean the glass on the outside of the door.
- Spillage of marinades, fruit juices, tomato sauces and basting materials containing acids may cause discoloration and should be wiped up immediately. When surface is cool, clean and rinse.
- **Do not use oven cleaners, cleansing powders or harsh abrasives on the outside of the door.**

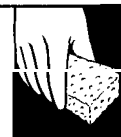

## Removable Storage Drawer

The storage drawer is a good place to store cookware and bakeware. Do not store plastics and flammable material in the drawer.

Do not overload the storage drawer. If the drawer is too heavy, it may slip off the track when opened.

The storage drawer may be removed for cleaning under the range. Clean the storage drawer with a damp cloth or sponge. Never use harsh abrasives or scouring pads.

### To remove storage drawer:

1. Pull drawer straight out until it stops.
2. Lift drawer until stops on drawer clear stops on range.
3. Again pull drawer out until it hits second set of stops.
4. Tilt front of drawer up and free of range.

### To replace storage drawer:

1. Set the stops on the back of the drawer over the stops in the range.
2. Slide drawer evenly and straight back, so that the rails in the range are engaged.
3. Push drawer back until second stops on drawer hit stops in the range. Tilt drawer up and over these.
4. Slide drawer the rest of the way in.

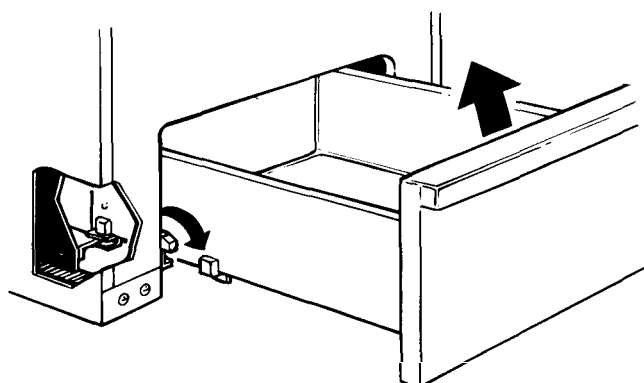

## Oven Bottom

**The oven bottom has a porcelain enamel finish.** To make cleaning easier, protect the oven bottom from excessive spillovers by placing a cookie sheet on the shelf below the shelf you are cooking on. You can use aluminum foil if you do not cover the whole shelf. This is particularly important when baking a fruit pie or other foods with a high acid content. Hot fruit fillings or other foods that are highly acidic (such as milk, tomatoes or sauerkraut, and sauces with vinegar or lemon juice) may cause pitting and damage to the porcelain enamel surface and should be wiped up immediately. Take care not to touch hot portion of oven.

If a spillover does occur on the oven bottom, allow the oven to cool first. You can then clean the oven bottom with soap and water, an abrasive cleanser or scouring pads.

- Rinse well to remove any soap before self-cleaning.

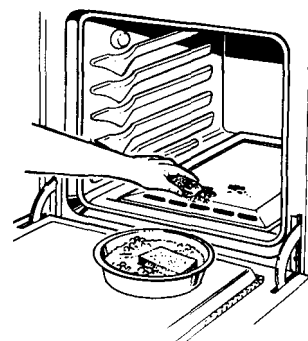

*(continued next page)*

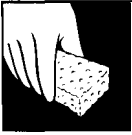

# CARE AND CLEANING

(continued)

## Oven Air Vents

**Never block the vents (air openings) of the range.** They provide the air inlet and outlet that are necessary for the range to operate properly with correct combustion. Air openings are located at the rear of the cooktop, at the top and bottom of the oven door, and at the bottom of the range, under the storage drawer.

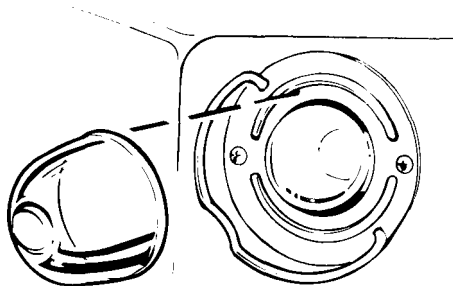
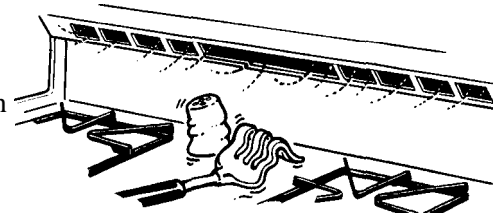

## Oven Lamp Replacement

**CAUTION:** Before replacing your oven bulb, disconnect electrical power to the range at the main fuse or circuit breaker panel. Be sure to let the lamp cover and bulb cool completely.

The oven lamp (bulb) is covered with a removable glass cover that is held in place with a bail-shaped wire. Remove oven door, if desired, to reach cover easily.

### To remove:

1. Hold hand under cover so it doesn't fall when released. With fingers of same hand, firmly push back wire bail until it clears cover. Lift off cover. **DO NOT REMOVE ANY SCREWS TO REMOVE COVER.**
2. Do not touch hot bulb with a wet cloth. Replace bulb with a 40-watt household appliance bulb.

### To replace cover:

1. Place it into groove of lamp receptacle. Pull wire bail forward to center of cover until it snaps into place. When in place, wire holds cover firmly. Be certain wire bail is in depression in center of cover.
2. Connect electrical power to the range.

## Metal Parts

Do not use steel wool, abrasives, ammonia or commercial oven cleaners. To safely clean surfaces; wash, rinse and then dry with soft cloth.

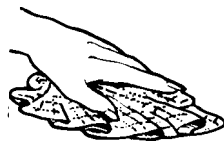

## Glass Surfaces

To clean the outside glass finish, use a glass cleaner. Rinse and polish with a dry cloth. Do not allow the water or cleaner to run down inside openings in the glass while cleaning.

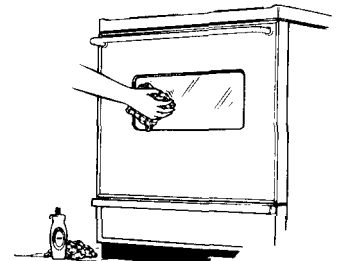

# MINOR ADJUSTMENTS YOU CAN MAKE



## Broil and Bottom Burner Air Adjustment Shutters

The combustion quality of burner flames needs to be determined visually. See the Installation Instructions and the Problem Solver sections in this book. Air adjustment shutters for the top (broil) and bottom (oven) burners regulate the flow of air to the flames.

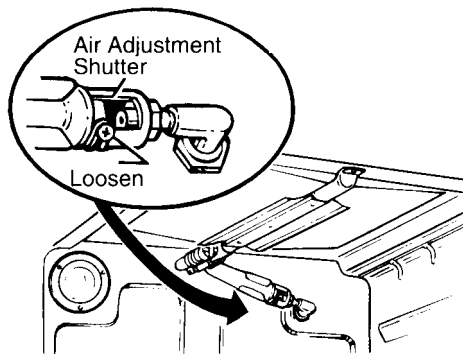

The air adjustment shutter for the top (broil) burner is in the center of the rear wall of the oven. (See Installation Instructions in this book.)

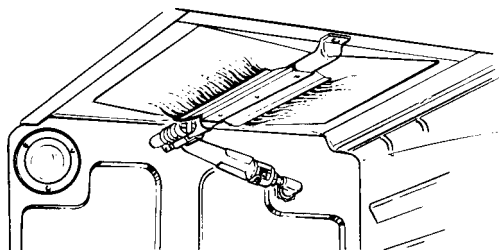

The flames for the top (broil) burner should burn steady with approximately 1" blue cones and should not extend out over the edges of the burner baffle.

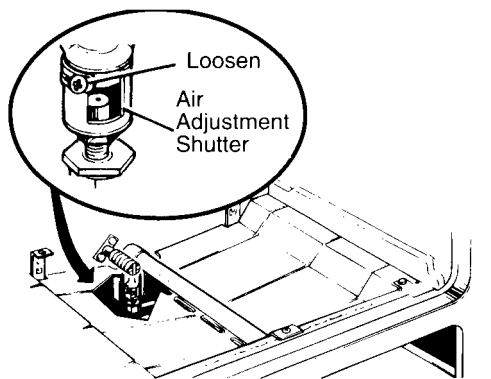

The shutter for the bottom (oven) burner is near the back wall behind the storage drawer, or kick panel.

To adjust the flow of air to either burner, loosen the Phillips head screw and rotate the shutter to allow more or less air into the burner tube as needed.

To determine if the bottom burner flames are proper, remove the oven bottom and the burner baffle.

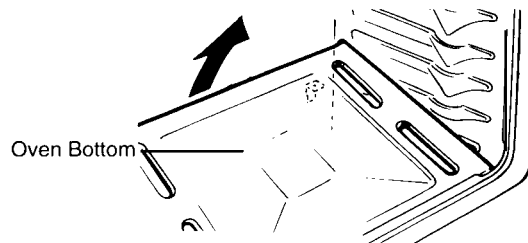

To remove the oven bottom:

1. Remove the knurled screws holding down rear of oven bottom.
2. Grasp the oven bottom at finger slots on each side.
3. Lift the rear of the oven bottom enough to clear the lip of the range frame, then pull out.

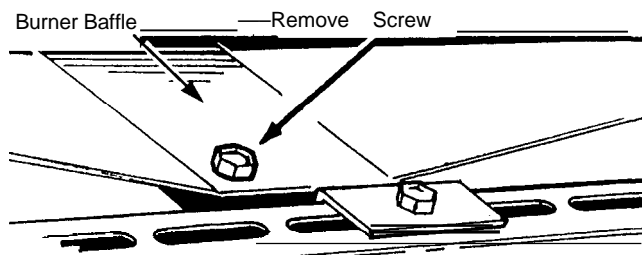

To remove the burner baffle, use a nut driver to remove the 1/4" hex head screw shown in the illustration above. Do not remove any other screws. Pull baffle straight out until it is free from the slot that holds it at rear of oven.

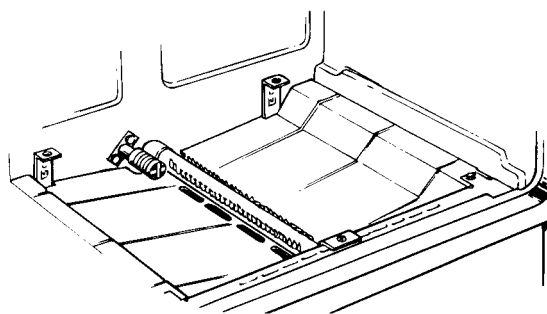

The flames should have 1/2" to 3/4" blue cone with no yellow tipping. When the baffle is back in place, the flames will resettle.



# INSTALLATION INSTRUCTIONS

## FOR YOUR SAFETY

If you smell gas:

1. Open windows.
2. **Don't** touch electrical switches.
3. Extinguish any open flame.
4. Immediately call your gas supplier.

## FOR YOUR SAFETY

Do not store or use combustible materials, gasoline or other flammable vapors and liquids in the vicinity of this or any other appliance.

## BEFORE YOU BEGIN

Read these instructions completely and carefully.

**IMPORTANT:** Save these instructions for the local electrical inspector's use.

**INSTALLER:** Leave these instructions with the appliance after installation is completed.

**CONSUMER:** Keep this Use and Care Guide and the Installation Instructions for **future** use.

This appliance must be properly grounded.

## WARNING

Improper installation, adjustment, alteration, service or maintenance can cause injury or property damage. Refer to this manual. For assistance or additional information, consult a qualified installer, service agency, manufacturer (dealer) or the gas supplier.

## CAUTION

Do not attempt to operate the oven of this range during a power failure.

## IMPORTANT

Remove all packing material and literature from oven before connecting gas and electrical supply to range.

## DIMENSIONS AND CLEARANCES

Provide adequate clearances between the range and adjacent combustible surfaces.

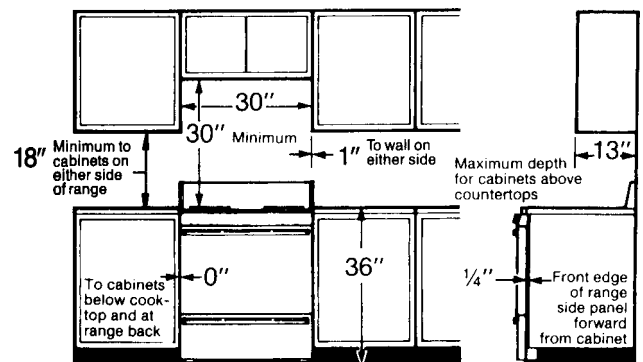
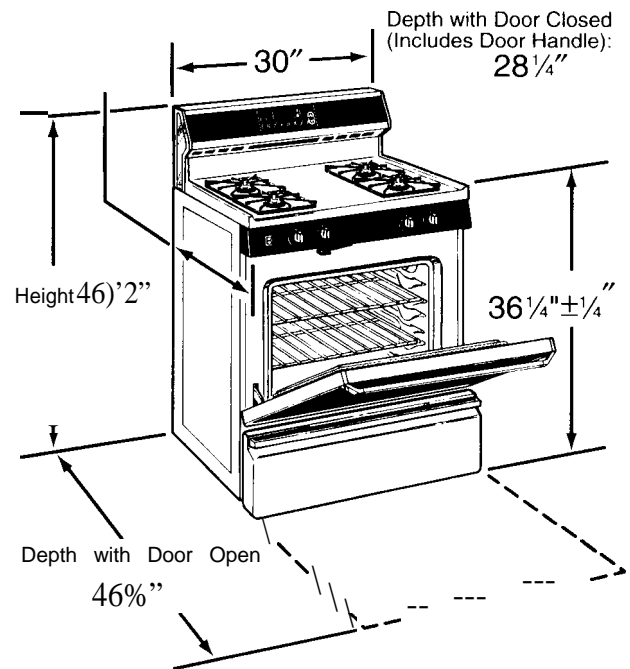





## IMPORTANT SAFETY INSTRUCTIONS

Installation of this range must conform with local codes, or in the absence of local codes, with the National Fuel Gas Code, ANSI Z223.1, latest edition. In Canada, installation must conform with the current Natural Gas Installation Code, CAN/CGA-B149.1 or the current Propane Installation Code, CAN/CGA-B149.2, and with local codes where applicable.

This range has been design-certified by the American Gas Association according to ANSI Z21.1, latest edition and Canadian Gas Association according to CAN/CGA-1.1 latest edition. As with any appliance using gas and generating heat, there are certain safety precautions you should follow. You will find these precautions in the Important Safety Instructions in the front of this book. Read them carefully.

- Have your range installed by a qualified installer or service technician.

- . Your range must be electrically grounded in accordance with local codes or, in the absence of local codes, in accordance with the National Electrical Code (ANSI/NFPA 70, latest edition). In Canada, electrical grounding must be in accordance with the current CSA C22.1 Canadian Electrical Code Part 1 and/or local codes. See Electrical Connections in this section.

- . Before installing your range on linoleum or any other synthetic floor covering, make sure the floor covering can withstand 180° I? without shrinking, warping or discoloring. Do not install the range over carpeting unless a sheet of 1/4" thick plywood or similar insulator is placed between the range and carpeting.

- Make sure the wall coverings around the range can withstand heat generated by the range up to 200° F.

- Avoid placing cabinets above the range. To reduce the hazard caused by reaching over the open flames of operating burners, install a ventilation hood over the range that projects forward at least 5" beyond the front of the cabinets.

- . The ventilating hood must be constructed of sheet metal not less than 0.0122" thick. Install above the cooktop with a clearance of not less than 1/4" between the hood and the underside of the combustible material or metal cabinet. The hood must be at least as wide as the appliance and centered over the appliance. Clearance between the cooking surface and the ventilation hood surface **MUST NEVER BE LESS THAN 24 INCHES.**

- If cabinets are placed above the range, allow a minimum clearance of 30" between the cooking surface and the bottom of unprotected cabinets.

- If a 30" clearance between cooking surface and overhead combustible material or metal cabinets cannot be maintained, protect the underside of the cabinets above the cooktop with not less than 1/4" insulating millboard covered with sheet metal not less than 0.0122" thick.

- Clearance between the cooking surface and protected cabinets **MUST NEVER BE LESS THAN 24 INCHES.** The vertical distance from the plane of the cooking surface to the bottom of adjacent overhead cabinets extending closer than 1" to the plane of the range sides must not be less than 18". (See Dimensions and Clearances illustration in this section.)

- **Caution:** Items of interest to children should not be stored in cabinets above a range or on the backsplash of a range-children climbing on the range to reach items could be seriously injured.



## WARNING

All ranges can tip and injury could result. To prevent accidental tipping of the range, attach an approved Anti-Tip device to the wall. (See Installing the Anti-Tip Device in this section.) To check if the device is installed and engaged properly, carefully tip the range forward. The

Anti-Tip device should engage and prevent the range from tipping over.

If you pull the range out from the wall for any reason, make sure the Anti-Tip device is engaged when you push the range back against the wall.

- For your safety, never use your range for warming or heating the room. Your oven and range top are not designed to heat your kitchen. Top burners should not be operated without cookware on the grate. Such abuse could result in fire and damage to your range and will void your warranty.

- Do not store or use combustible materials, gasoline or other flammable vapors and liquids in the vicinity of this or any other appliance. Explosions or fires could result.

- Do not use oven for a storage area. Items stored in the oven can ignite.

- Do not let cooking grease or other flammable materials accumulate in or near the range.

(continued next page)



# INSTALLATION INSTRUCTIONS

(continued)

## GENERAL

- See Dimensions and Clearances in this section for all rough-in and spacing dimensions. These dimensions must be met for safe use of your range. The location of the electrical outlet and pipe opening (see Gas Pipe and Electric Outlet Locations) may be adjusted to meet specific requirements.
- The range may be placed with 0" clearance (flush) at the back wall and side walls of the range.

## LOCATION

Do not locate the range where it may be subject to strong drafts. Any openings in the floor or wall behind the range should be sealed. Make sure the openings around the base of the range that supply fresh air for combustion and ventilation are not obstructed by carpeting or woodwork.

## PROTECT YOUR FLOOR

Your range, like many other household items, is heavy and can settle into soft floor coverings such as cushioned vinyl or carpeting. Use care when moving the range on this type of flooring. It is recommended that the following simple and inexpensive instructions be followed to protect your floor.

The range should be installed on a sheet of plywood (or similar material). *When the floor covering ends at the front of the range*, the area that the range will rest on should be built up with plywood to the same level or higher than the floor covering. This will allow the range to be moved for cleaning or servicing.

## MODEL AND SERIAL NUMBER LOCATION

Depending on your range, you'll find the model and serial numbers on a label on the front frame of the range, behind the storage drawer, kick panel or broiler drawer.

## TOOLS YOU WILL NEED

- Phillips and flat-blade screwdrivers
- Pencil and ruler
- Two pipe wrenches (one for backup)
- 1%'' open-end or adjustable wrench
- Nut drivers or wrenches: 3/16'' and 1/4''

## ADDITIONAL MATERIALS YOU **MAY** NEED

- Gas line shut-off valve
- Pipe joint sealant or UL-approved pipe thread tape with Teflon\* that resists action of natural and LP gases
- Flexible metal appliance connector (1/2'' I. D.) A 5-foot length is recommended for ease of installation but other lengths are acceptable. Never use an old connector when installing a new range.
- Flare union adapter for connection to gas supply line (3/4'' or 1/2'' NPT x 1/2'' I. D.)
- Flare union adapter for connection to pressure regulator on range (1/2'' NPT x 1/2'' I. D.)

\*Teflon: Registered trademark of DuPont

## PREPARATION

- Remove all tape and packaging. Lift up the cooktop (on models with dual burners) and remove any packing material under it. Make sure the dual burners are properly seated and level.
- Remove plastic film that covers some chrome parts (around oven door, side trim).
- Take the accessory pack out of the oven.
- Check to be sure that no range parts have come loose during shipping.



## 1 PROVIDE ADEQUATE GAS SUPPLY

Your range is designed to operate at a pressure of 4" of water column on natural gas or, if designed for LP gas (propane or butane), 10" of water column. Make sure you are supplying your range with the type of gas for which it is designed. This range is convertible for use on natural or propane gas, if you decide to use this range on a different type of gas, conversion adjustments must be made by a service technician or other qualified person before attempting to operate the range on that gas.

For proper operation, the pressure of natural gas supplied to the regulator must be between 4" and 13" of water column. For LP gas, the pressure supplied must be between 10" and 13" of water column. When checking for proper operation of the regulator, the inlet pressure must be at least 1" greater than the operating (manifold) pressure as given above. The pressure regulator located at the inlet of the range manifold must remain in the supply line regardless of whether natural or LP gas is being used. A flexible metal appliance connector used to connect the range to the gas supply line should have an I.D. of 1/2" and be 5 feet in length (shorter and longer lengths are acceptable) for ease of installation. In Canada, flexible connectors must be single wall metal connectors no longer than 6 feet in length.

## Gas Pipe and Electric Outlet Locations

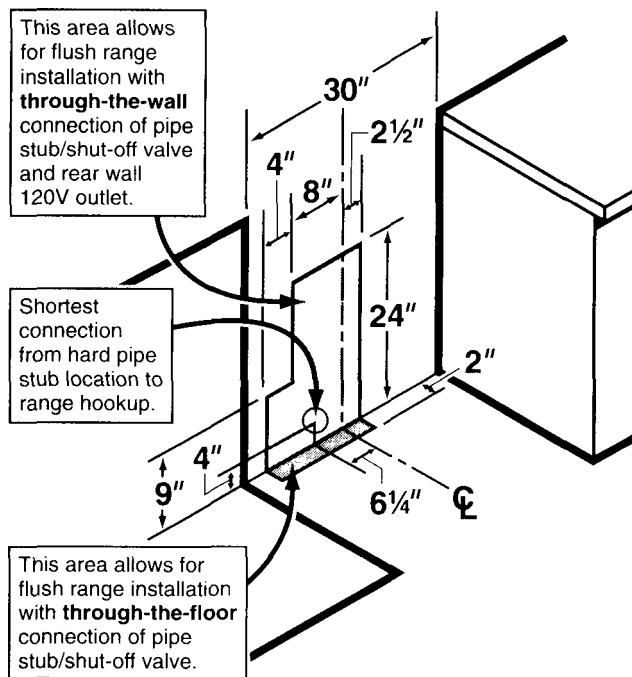

(continued next page)

## 2 CONNECT THE RANGE TO GAS

Shut off the main gas supply valve before disconnecting the old range and leave it off until new hook-up has been completed. Don't forget to relight the pilot on other gas appliances when you turn the gas back on.

Because hard piping restricts movement of the range, the use of an A. G.A.-certified flexible metal appliance connector is recommended unless local codes require a hard-piped connection. Never use an old connector when installing a new range. If the hard piping method is used, you must carefully align the pipe; the range cannot be moved after the connection is made.

To prevent gas leaks, put pipe joint compound on, or wrap pipe thread tape with Teflon\* around, all male (external) pipe threads.

Teflon: Registered trademark of DuPont



# INSTALLATION INSTRUCTIONS

(continued)

## CONNECT THE RANGE TO GAS

### Flexible Connector Hookup

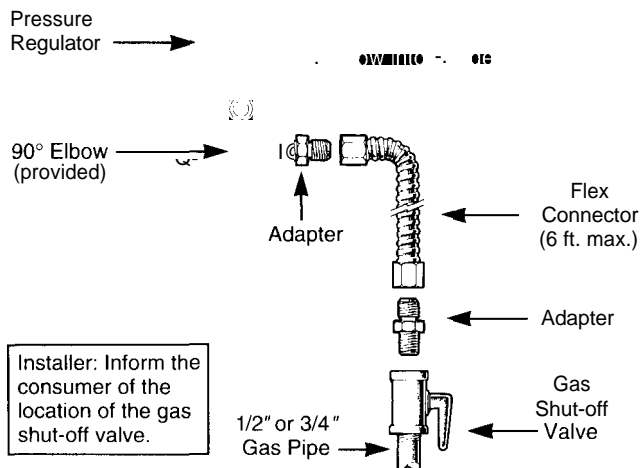

### Rigid Pipe Hookup

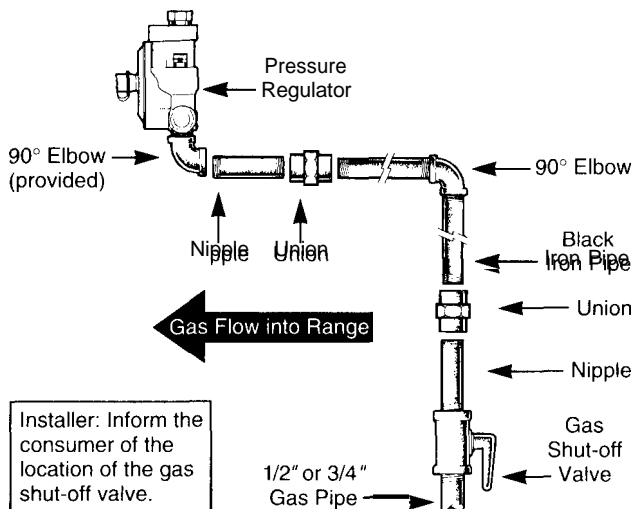

1. Install a manual gas line shut-off valve in the gas line in an easily accessed location outside of the range. Make sure everyone operating the range knows where and how to shut off the gas supply to the range.
2. Install male 1/2" flare union adapter to the 1/2" NPT internal thread elbow at inlet of regulator. Use a backup wrench on the regulator fitting to avoid damage.

When installing the range from the front, remove the 90° elbow for easier installation.

3. Install male 1/2" or 3/4" flare union adapter to the NPT internal thread of the manual shut-off valve, taking care to back-up the shut-off valve to keep it from turning.
4. Connect flexible metal appliance connector to the adapter on the range. Position range to permit connection at the shut-off valve.
5. When all connections have been made, make sure all range controls are in the off position and turn on the main gas supply valve. Use a liquid leak detector at all joints and connections to check for leaks in the system.

**CAUTION: DO NOT USE A FLAME TO CHECK FOR GAS LEAKS.**

When using test pressures greater than 1/2 psig to pressure test the gas supply system of the residence, disconnect the range and individual shut-off valve from the gas supply piping. When using test pressures of 1/2 psig or less to test the gas supply system, simply isolate the range from the gas supply system by closing the individual shut-off valve.



## **ELECTRICAL CONNECTIONS**

### **Electrical Requirements**

120-volt, 60 Hertz, properly grounded branch circuit protected by a 15-amp or 20-amp circuit breaker or time delay fuse.

### **Extension Cord Cautions**

Because of potential safety hazards associated with certain conditions, we strongly recommend against the use of an extension cord. However, if you still elect to use an extension cord, it is absolutely necessary that it be a UL-listed, 3-wire grounding-type appliance extension cord and that the current carrying rating of the cord in amperes be equivalent to, or greater than, the branch circuit rating.

### **Grounding**

#### **IMPORTANT-(Please read carefully)**

**FOR PERSONAL SAFETY, THIS APPLIANCE MUST BE PROPERLY GROUNDED.**

The power cord of this appliance is equipped with a three-prong (grounding) plug which mates with a standard three-prong grounding wall receptacle to minimize the possibility of electric shock hazard from this appliance.

#### **PREFERRED METHOD**

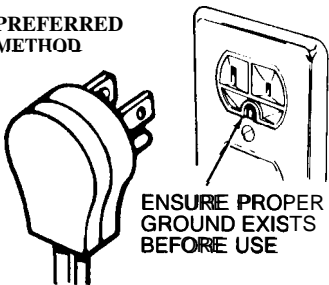

The customer should have the wall receptacle and circuit checked by a

qualified electrician to make sure the receptacle is properly grounded.

Where a standard two-prong wall receptacle is encountered, it is the personal responsibility and obligation of the customer to have it replaced with a properly grounded three-prong wall receptacle. **DO NOT, UNDER ANY CIRCUMSTANCES, CUT OR REMOVE THE THIRD (GROUND) PRONG FROM THE POWER CORD.**

## **Usage Situations where Appliance Power Cord will be Disconnected Infrequently.**

An adapter maybe used only on a 15-amp circuit. Do not use an adapter on a 20-amp circuit. Where local codes permit, a **TEMPORARY CONNECTION** may be made to a properly grounded two-prong wall receptacle by the use of a UL-listed adapter, available at most hardware stores. The larger slot in the adapter must be aligned with the larger slot in the wall receptacle to provide proper polarity in the connection of the power cord.

#### **TEMPORARY METHOD**

(ADAPTER PLUGS NOT PERMITTED IN CANADA)

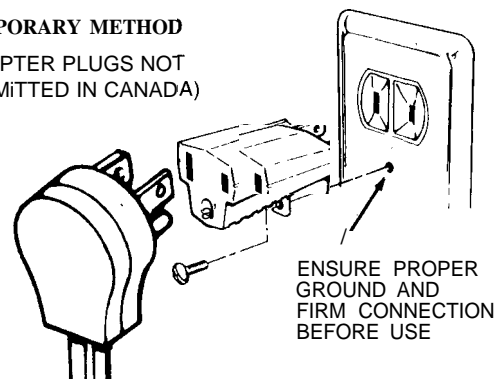

ALIGN LARGE PRONGS/SLOTS

**CAUTION:** Attaching the adapter ground terminal to the wall receptacle cover screw does not ground the appliance unless the cover screw is metal, and not insulated, and the wall receptacle is grounded through the house wiring. The customer should have the circuit checked by a qualified electrician to make sure the receptacle is properly grounded.

When disconnecting the power cord from the adapter, always hold the adapter with one hand. If this is not done, the adapter ground terminal is very likely to break with repeated use. Should this happen, **DO NOT USE** the appliance until a proper ground has again been established.

*(continued next page)*



# INSTALLATION INSTRUCTIONS

(continued)

## ELECTRICAL CONNECTIONS (continued)

### Usage Situations where Appliance Power Cord will be Disconnected Frequently.

Do not use an adapter plug in these situations because disconnecting of the power cord places undue strain on the adapter and leads to eventual failure of the adapter ground terminal. The customer should have the two-prong wall receptacle replaced with a three-prong (grounding) receptacle by a qualified electrician before using the appliance.

The installation of appliances designed for mobile home installation must conform with the Manufactured Home Construction and Safety Standard, Title 24 CFR, Part 3280 (formerly the Federal Standard for Mobile Home Construction and Safety, Title 24, HUD, Part 280) or, when such standard is not applicable, the Standard for Manufactured Home Installations, latest edition (Manufactured Home Sites, Communities and Set-Ups), ANSI A225.1, latest edition, or with local codes. In Canada, mobile home installation must be in accordance with the current CAN/CSA Z240/MH Mobile Home Installation Code.

### Electric Disconnect

1. Locate disconnect plug on the range back.
2. Pinch sides of connector and pull out of range back.

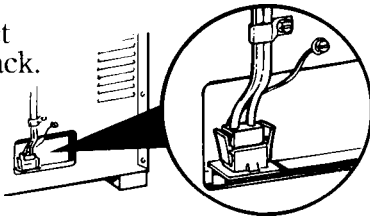

### SEAL THE OPENINGS

Seal any openings in the wall behind the range and in the floor under the range when hookups are completed.

### CHECK SURFACE BURNER IGNITION

Operation of all cooktop and oven burners should be checked after range and gas supply lines have been carefully checked for leaks.

Push in one of the surface burner controls and turn it to the LITE position. You will hear a snapping sound indicating proper operation of the spark module. Once the air has been purged from the supply lines, burner should light within 4 seconds. After burner lights, rotate knob out of the LITE position. Try each burner in succession until all burners have been checked.

## Quality of Flames

The combustion quality of burner flames needs to be determined visually.

If burner flames look like (A), call for service. Normal burner flames should look like (B) or (C), depending on the type of gas you use.

With LP gas, some yellow tipping on outer cones is normal.



**(A) Yellow flames—**  
Call for service

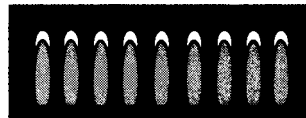

**(B) Yellow tips on outer cones—**  
Normal for LP gas

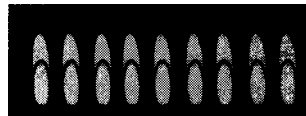

**(C) Soft blue flames—**  
Normal for natural gas

### CHECK IGNITION OF OVEN BURNER

The oven is designed to operate quietly and automatically. To operate the oven, press the BAKE pad and then press the INCREASE pad until "350" appears in the display. After 30-90 seconds, the oven burner will ignite and burn until the set temperature is reached. The oven burner will continue to cycle on and off as necessary to maintain the oven at the temperature indicated by the display.

To check ignition of the broil burner, press the BROIL pad and then the INCREASE or DECREASE pad. After 30-90 seconds, the broil burner will ignite. The oven requires electrical power to operate. In the case of a power outage, the oven burners on these models cannot be lit manually with a match. Gas will not flow unless the glow bar is hot.

If the oven is in use when a power outage occurs, the oven burner shuts off and cannot be re-lit until power is restored.



**ADJUST BROIL AND OVEN BURNER AIR ADJUSTMENT SHUTTERS IF NECESSARY**

Air adjustment shutters for the top and bottom burners regulate the flow of air to the flames.

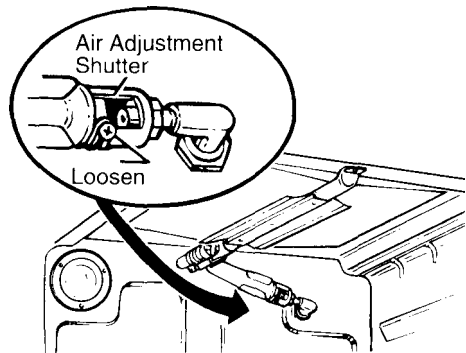

The air adjustment shutter for the top (broil) burner is in the center of the rear wall of the oven.

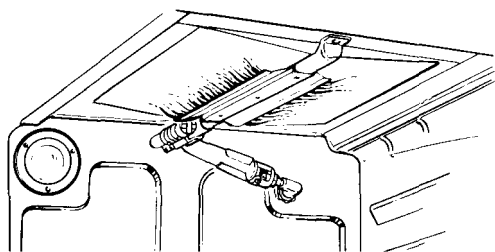

The flames for the top (broil) burner should be steady with approximately 1" blue cones and should not extend out over the edges of the burner baffle.

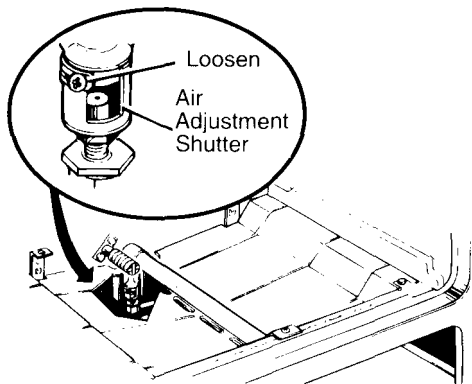

The shutter for the bottom (oven) burner is near the back wall behind the storage drawer or the kick panel (depending on the model). Remove the drawer or panel. (See Care and Cleaning section in this book.)

To adjust the flow of air to either burner, loosen the Phillips head screw and rotate the shutter toward open or closed position as needed.

To determine if the bottom burner flames are burning properly, remove the oven bottom and the burner baffle (see below).

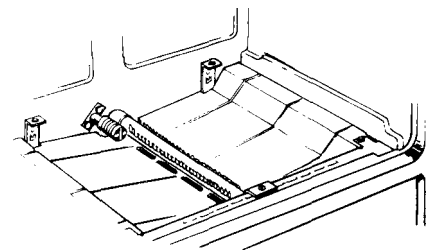

Flames should have approximately 1" blue cones and, if range is supplied with natural gas, should burn with no yellow tipping. (With most LP gas, small yellow tips at the end of outer cones are normal.) Flames should not lift off burner ports. If lifting is observed, gradually reduce air shutter opening until flames are stabilized. With the baffle in place, the flames should burn steady and should not extend past the edges of the burner baffle.

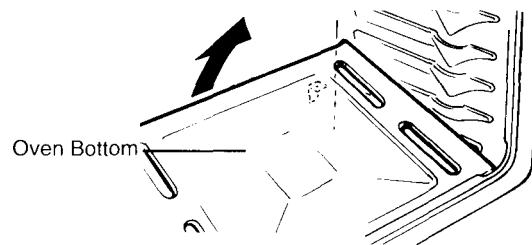

To remove the oven bottom:

1. Remove the knurled screws holding down rear of the oven bottom.
2. Grasp the oven bottom at finger slots on each side.
3. Lift the rear of the oven bottom enough to clear the lip of the range frame, then pull out.

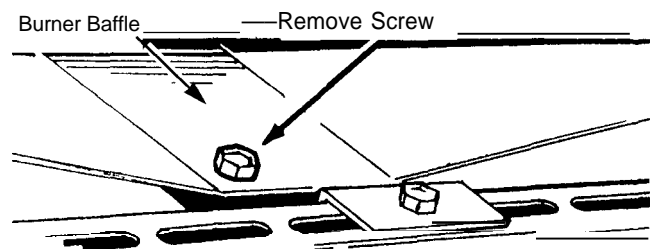

To remove the burner baffle (on some models):

1. Use a nut driver to remove the 1/4" **hex-head screw shown in the illustration above. Do not remove any other screws.**
2. Pull baffle straight out until it is free from the slot that holds it at rear of oven.

(continued next page)



# INSTALLATION INSTRUCTIONS

(continued)

## LEVELING THE RANGE

1. Remove the storage drawer, broiler drawer or kick panel.
2. Use a 3/16" open-end or socket wrench to back out both rear leveling legs approximately two turns.
3. Use a 1/2" open-end or adjustable wrench to back out the front leveling legs two turns.
4. Install the oven shelves in the oven and position the range where it will be installed.
5. Check for levelness by placing a spirit level or a cup, partially filled with water, on one of the oven racks. If using a spirit level, take two readings—with the level placed diagonally first in one direction and then the other.
6. Adjust the leveling legs until the range is level.
7. After the range is level, slide the range away from the wall so that the Anti-Tip device can be installed.

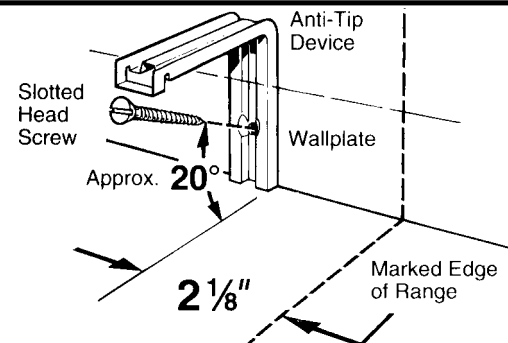
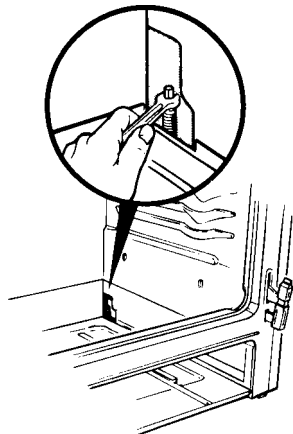

2. Locate the outside edge of the device 2 1/8" toward the center of the range from the marked edge of the range.
3. Using the device as a template, mark the position of the hole for the screw.
4. For wood construction, drill a pilot hole at an angle of 20 degrees from the horizontal. A nail or awl may be used if a drill is not available. Mount the Anti-Tip device with the screw provided. For cement or concrete construction, you will need a 1/4" x 1 1/2" lag bolt and a 1/2" O.D. sleeve anchor, which are not provided. Drill the recommended size hole for the hardware. Install the sleeve anchor into the drilled hole and then install the lag bolt through the device. The bolts must be properly tightened as recommended for the hardware.

## INSTALLING THE ANTI-TIP DEVICE

### WARNING:

- Range must be secured with an approved Anti-Tip device.
- Unless properly installed, the range could be tipped by you or a child standing, sitting or leaning on an open door.
- After installing the Anti-Tip device, verify that it is in place by carefully attempting to tilt the range forward.
- This range has been designed to meet all recognized industry tip standards for all normal conditions.
- The use of this device does not preclude tipping of the range when not properly installed.
- If the Anti-Tip device supplied with the range does not fit this application, use the universal Anti-Tip device WB02X7909.

1. Mark the wall where the RIGHT EDGE of the range is to be located. Be sure to allow for the countertop overhang if you intend to install the range next to cabinets.

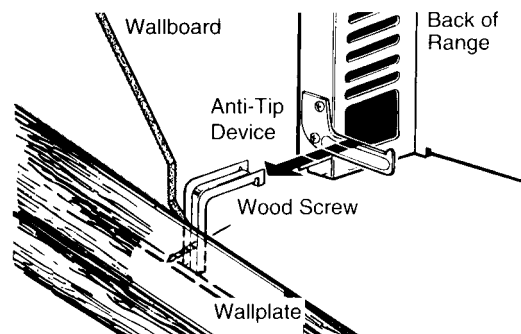

5. Slide the range against the wall, and check for proper installation by grasping the front edges of the rear surface unit openings and carefully attempting to tilt the range forward.

### WHEN ALL HOOKUPS ARE COMPLETED:

**MAKE SURE ALL CONTROLS ARE LEFT IN THE OFF POSITION.**

**MAKE SURE THE FLOW OF COMBUSTION AND VENTILATION AIR TO THE RANGE IS UNOBSTRUCTED.**





## HOW TO CONVERT THE RANGE FOR USE WITH 1P GAS OR NATURAL GAS

### TOOLS REQUIRED:

- T-10 Torxdriver (for sealed burners)
- 1/2" and 3/4" open-end wrench
- Flat blade screwdriver (small)
- Nut drivers or wrenches: 7mm or 5/16" (depending on the size of the spuds)

### PREPARE RANGE FOR CONVERSION

- Turn off gas supply at the wall.
- Turn off the electrical power to the range.

If range has not yet been connected to gas supply, or if flexible connection was made, range maybe pulled out from the wall to make conversion easier.

### 2 CONVERT THE PRESSURE REGULATOR

**WARNING:** Do not remove the pressure regulator from the range.

- For models equipped with sealed burners, remove the storage drawer, broiler drawer or kick panel and locate the pressure regulator at rear of the range.

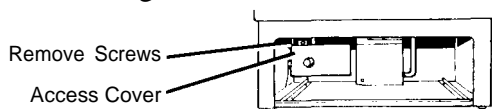

On some models, you may have to remove an access cover also.

For models equipped with dual burners, remove the cooktop and locate the pressure regulator at right rear of range.

- Follow the directions in **A** or **B** that match your regulator type.

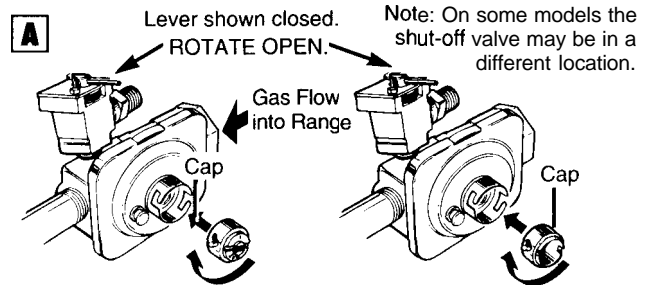

If it is this regulator:

- Use a coin to remove the cap from the pressure regulator.
- Turn the cap over and hook it into the slots. The type of gas to be used should now be visible on the top of the cap.

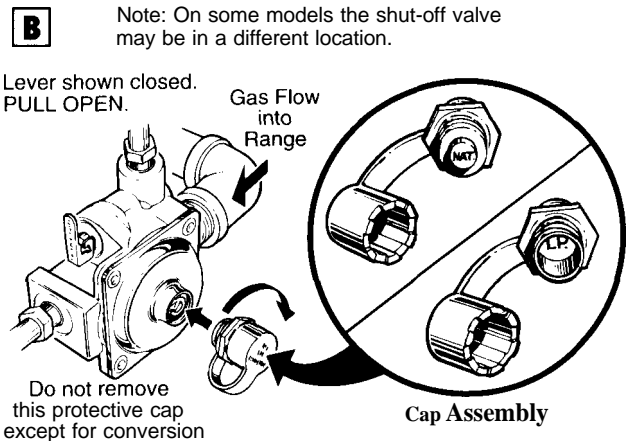

If it is this regulator:

- Unscrew the plastic-protected hex-nut cap from the regulator.
- Carefully pry the protective plastic cap off the threaded metal cap. Gently pull the plastic washer off the threads on the other side of the metal cap.
- Push the plastic cap onto the end of the metal cap displaying the type of gas you are converting to. Press the attached plastic washer onto the threads on the other side of the metal cap.
- Screw the hex-nut cap back into the regulator. Do not overtighten.

(continued next page)



# INSTALLATION INSTRUCTIONS

(continued)

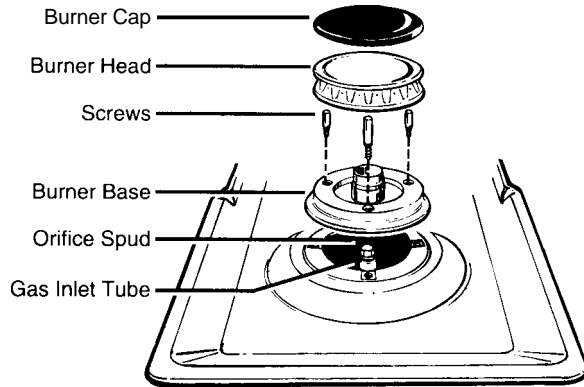

## HOW TO CONVERT THE RANGE FOR USE WITH 1P GAS OR NATURAL GAS (continued)

### CONVERTING SURFACE BURNERS



1. Remove grates, burner caps and burner heads.
2. Remove burner bases by unscrewing the 3 small screws in each base. Lift **burner straight out**.

**DO NOT** disconnect the wires from the burner bases unless the cooktop needs to be raised.

3. Remove the brass orifice spud under each burner base by unscrewing spud from fitting with a 7mm or 5/16" wrench (depending on the size of your spuds). Apply a 3/4" wrench to the hex on the gas inlet tube as a back-up when removing spud to prevent the aluminum tube from twisting.
4. Install orifice spuds according to one of the following diagrams (see  or ), for LP gas or natural gas, depending on which you are converting to.

### Orifice Spuds for **Converting to LP Gas:**

LP orifice spuds are in a small plastic bag packed with this Use and Care book. LP orifice spuds have a 2-digit number and the Letter "L" on one side. Each orifice spud will also have 1 or 2 grooves on one side, denoting the location on the range where it is to be installed.

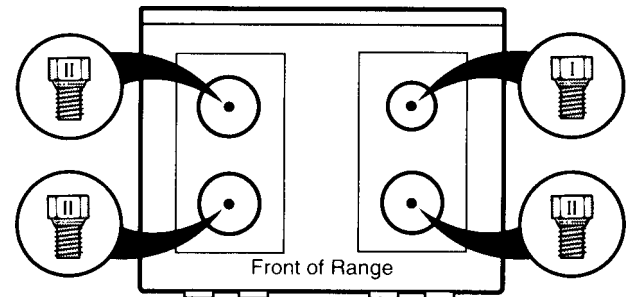

### Orifice Spuds for **Converting to Natural Gas:**

Natural gas orifice spuds have a 3-digit number on one side. Each orifice spud will also have 1, 2 or 3 grooves on one side, denoting the location on the range where it is to be installed.

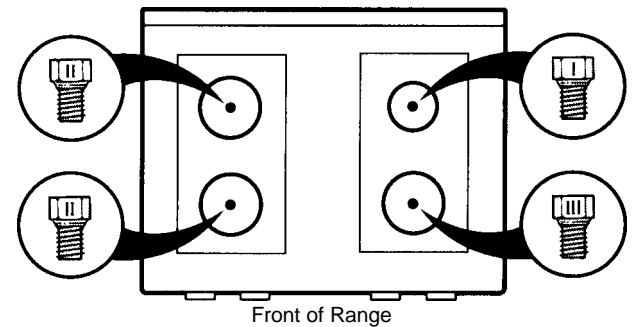



5. To prevent leakage, make sure the orifice spuds are securely screwed into the gas inlet tubes. Use a small wrench to hold the inlet tube hex to prevent it from twisting.

6. Put old orifice spuds back in the bag to save for possible future conversion.

Note: If an orifice spud is accidentally dropped, the cooktop can be raised by disengaging the 2 front clips with a large flat blade screwdriver.

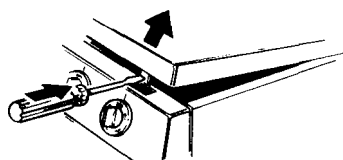

**DO NOT** attempt to raise the cooktop without removing all 4 burner bases.

If wires were disconnected to remove the cooktop, feed wires through the burner holes in the cooktop. Attach to each burner electrode terminal carefully, making sure not to bend the terminal. Then lower cooktop until it snaps over the clips.

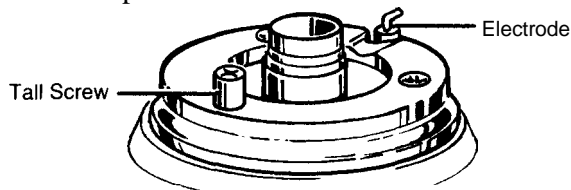

7. Carefully insert burner bases straight down with the tube over the orifice spud. Replace the screws, **making sure the tall screw is opposite the burner electrode in each burner base.**

## CONVERT THE OVEN BURNER ORIFICES

### Oven Burner

1. Remove oven door, storage drawer or broiler drawer, oven bottom and burner baffle. The lower burner orifice spud is located behind the storage drawer, broiler drawer or kick panel. (On some models, a metal shield must be removed to access the orifice.)

2. **To convert to LP gas,** use a 1/2" wrench to turn the lower burner orifice spud clockwise. Tighten the spud only until it is snug. To prevent damage, do not overtighten the spud.

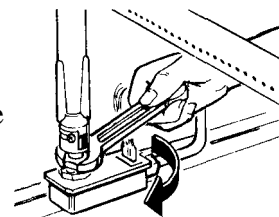

**To convert to natural gas,** loosen the spud about 2 turns.

### Broil Burner

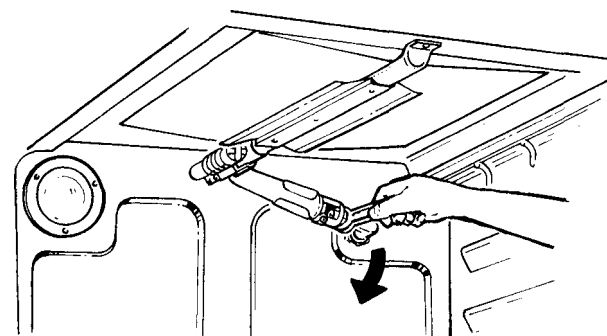

**To convert to LP gas,** use a 1/2" wrench to turn the upper burner orifice spud clockwise. Tighten spud only until it is snug with the base. To prevent damage, do not overtighten spud.

**To convert to natural gas,** loosen the spud about 2 turns.

(continued next page)



# INSTALLATION INSTRUCTIONS

(continued)

## HOW TO CONVERT THE RANGE FOR USE WITH 1P GAS OR NATURAL GAS (continued)

### □ CONVERT AIR ADJUSTMENT SHUTTER(S)

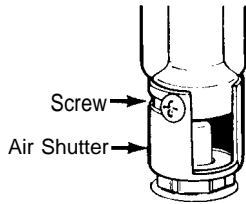

**For LP gas**, loosen the Phillips head screw and rotate the shutter to the full open position. With baffle in place, flames should have approximately 1-inch blue cones and should not extend beyond

the edges of the burner baffle. After 30 seconds of burner operation, check for flames lifting off burner ports. If lifting is observed, gradually reduce air shutter opening until flames are stabilized.

**For natural gas**, the shutter should be open 1/2" or about 3/4 of the way open.

### □ CHECK FOR LEAKS

When all connections have been made, make sure all range controls are in the off position and turn on the main gas supply valve. Use a liquid leak detector at all joints and connections to check for leaks in the system.

**CAUTION: DO NOT USE A FLAME TO CHECK FOR GAS LEAKS.**

When using test pressures greater than 1/2 psig to pressure test the gas supply system of the residence, disconnect the range and individual shut-off valve from the gas supply piping. When using test pressures of 1/2 psig or less to test the gas supply system, simply isolate the range from the gas supply system by closing the individual shut-off valve.

### □ CONVERT TOP BURNER VALVES

1. Turn all top burners to LOW.

2. Remove all four knobs.

3. With a small flat blade screwdriver, turn the valve set screws clockwise to decrease flame size, counterclockwise to increase flame size. Adjust until the flame is about the same height as the top of the burner.

4. Replace knobs.

5. Check for flame outage by opening and closing the oven door several times. If the flame goes out, increase the flame size.

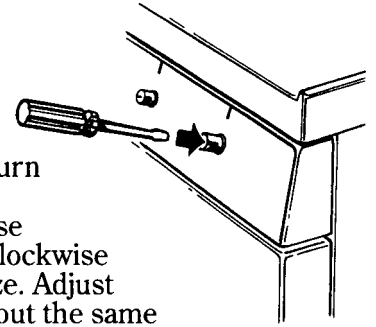

### □ CHECK QUALITY OF FLAMES

The combustion quality of burner flames needs to be determined visually.

If burner flames look like (A), call for service. Normal burner flames should look like (B) or (C), depending on the type of gas you use.

With LP gas, some yellow tipping on outer cones is normal.



**(A) Yellow flames—**  
Call for service

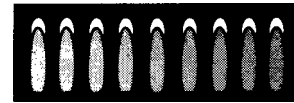



**(B) Yellow tips on outer cones—**  
Normal for LP gas



**(C) Soft blue flames—**  
Normal for natural gas

# QUESTIONS? USE THIS PROBLEM SOLVER



PROBLEM	POSSIBLE CAUSE
OVEN WILL NOT WORK	<ul style="list-style-type: none"> <li>• Plug on range is not completely inserted in the electrical outlet.</li> <li>• The circuit breaker in your house has been tripped, or a fuse has been blown.</li> <li>• Oven controls not properly set.</li> <li>• Door left in locked position after cleaning.</li> </ul>
TOP BURNERS DO NOT LIGHT OR DO NOT BURN EVENLY	<ul style="list-style-type: none"> <li>• Make sure electrical plug is plugged into a live power outlet.</li> <li>• Burner holes on the side or around the top of burner may be clogged. Remove burner heads or burner caps and clean them with a toothpick. Make sure you do not enlarge the holes. Check the electrode area for burned on food or grease.</li> </ul>
BURNERS HAVE YELLOW OR YELLOW-TIPPED FLAMES	<div style="display: flex; justify-content: space-around; align-items: center;"> <div style="text-align: center;">  <p><b>(A) Yellow flames—</b> Call for service</p> </div> <div style="text-align: center;">  <p><b>(B) Yellow tips on outer cones—</b>Normal for LP gas</p> </div> <div style="text-align: center;">  <p><b>(C) Soft blue flames—</b> Normal for natural gas</p> </div> </div> <ul style="list-style-type: none"> <li>• If burner flames look like (A), call for service. Normal burner flames should look like (B) or (C), depending on the type of gas you use.</li> <li>• With LP gas, some yellow tipping on outer cones is normal.</li> </ul>
BURNER FLAMES VERY LARGE OR YELLOW	<ul style="list-style-type: none"> <li>• If range is connected to LP gas, check all steps in the Installation Instructions.</li> </ul>
OVEN DOES NOT COOK PROPERLY	<ul style="list-style-type: none"> <li>• Make sure thermostat capillary bulb (located in upper portion of oven) is in correct position, not touching oven sides and not coated with anything.</li> <li>• Aluminum foil being used improperly in oven.</li> <li>• Incorrect cookware being used. Check each cooking section for cookware tips or recommendations.</li> <li>• Check common problems listed in Baking, Roasting and Broiling sections.</li> <li>• Oven bottom not securely seated in position.</li> </ul>
CLOCK AND MINUTE/SECOND TIMER DO NOT WORK	<ul style="list-style-type: none"> <li>• Range electrical plug must be securely seated in a live power outlet. Check for blown fuse or tripped circuit breaker.</li> <li>• Review instructions in Oven Control, Clock and Timer section.</li> </ul>
OVEN LIGHT DOES NOT COME ON	<ul style="list-style-type: none"> <li>• Bulb may be loose or burned out.</li> <li>• Electrical plug must be plugged into a live power outlet</li> </ul>

*(continued next page)*



## PROBLEM SOLVER

(continued)

PROBLEM	POSSIBLE CAUSE
STRONG ODOR	<ul style="list-style-type: none"><li>• Improper air/gas ratio in oven. Adjust oven burner air shutters.</li><li>• An odor from the insulation around the oven liner is normal for the first few times the oven is used. This is temporary.</li></ul>
OVEN WILL NOT SELF-CLEAN	<ul style="list-style-type: none"><li>• Oven temperature is too high to set self-cleaning operation. Allow the range to cool to room temperature and reset the controls.</li><li>• Door latch handle not moved all the way to the right.</li></ul>
OVEN DOOR WILL NOT UNLOCK	<ul style="list-style-type: none"><li>• Oven must cool below locking temperature (approximately 30 minutes after the clean cycle is complete). Do not lock door with door latch except when using self-clean feature or the oven may lock.</li></ul>
OVEN NOT CLEAN AFTER CLEAN CYCLE	<ul style="list-style-type: none"><li>• Oven controls not set properly. Review Operating the Self-Cleaning Oven section.</li><li>• Heavily soiled ovens require 3½ to 4 hour clean time.</li><li>• Heavy spillovers should be cleaned up before starting clean cycle.</li></ul>
“door” APPEARS ON DISPLAY	<ul style="list-style-type: none"><li>• Self-cleaning cycle has been selected but latch handle was not moved all the way to the right. Move the latch handle.</li><li>• Latch handle was moved to the right but a program other than self-cleaning was selected. Move the latch handle to the right only when setting self-cleaning cycle.</li></ul>
CONTROLBEEPSAFTER ENTERINGOVENTIME OR STOP TIME	<ul style="list-style-type: none"><li>• This is reminding you to enter a bake temperature (see Baking section).</li></ul>
“F” AND A NUMBER FLASH ON DISPLAY	<ul style="list-style-type: none"><li>• If the time display flashed “F-” and a number, you have a function error code. If function error code appears during the self-cleaning cycle, check oven door latch. The latch handle may have been moved, even if only slightly, from the latched position. Make sure the latch is moved to the right as far as it will go. Press the <b>CLEAR/OFF</b> pad. Allow oven to cool for one hour. Put oven back into operation. If the failure code repeats, disconnect all power to the range. Call for service.</li></ul>

**If you need more help... call, toll free:**

**GE Answer Center™**

**800.626.2000**

consumer information service

# We'll Be There

With the purchase of your new Hotpoint appliance, receive the assurance that if you ever need information or assistance, we'll be there. All you have to do is call-toll-free!



## In-Home Repair Service

800-GE-CARES  
(800-432-2737)

Our consumer service professionals will provide expert repair service on your Hotpoint appliance, scheduled at a time that's convenient for you. Many GE Consumer Service company-operated locations offer you service today or tomorrow; or at your convenience (7:00 a.m. to 7:00 p.m. weekdays, 9:00 a.m. to 2:00 p.m. Saturdays), our factory-trained technicians know your appliance inside and out—so most repairs can be handled in just one visit.



## Service Contracts

800-626-2224

You can have the secure feeling that GE Consumer Service will still be there after your Hotpoint product warranty expires. Purchase a GE contract while your warranty is still in effect and you'll receive a substantial discount. With a multiple-year contract, you're assured of future service at today's prices.

## Parts and Accessories

800-626-2002

Individuals qualified to service their own appliances can have needed parts or accessories sent directly to their home. Our parts system provides access to over 47,000 Genuine Renewal Parts...and all are fully warranted. VISA, MasterCard and Discover cards are accepted.

**User maintenance instructions contained in this booklet cover procedures intended to be performed by any user. Other servicing generally should be referred to qualified service personnel. Caution must be exercised, since improper servicing may cause unsafe operation.**



## GE Answer Center®

800.626.2070

Whatever your question about any Hotpoint major appliance, GE Answer Center® information service is available to help. Your call—and your question—will be answered promptly and courteously. And you can call any time. GE Answer Center® service is open 24 hours a day 7 days a week.

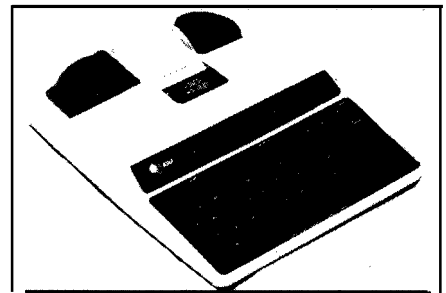

Telecommunication Device for the Deaf

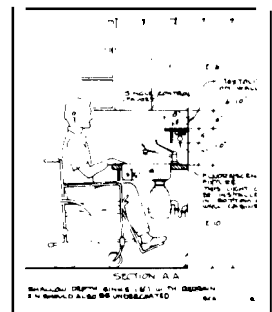
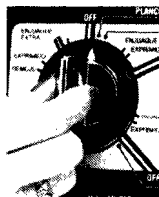

## For Customers With Special Needs...

800.626.2000

Upon request, we will provide Braille controls for a variety of Hotpoint appliances, and a brochure to assist in planning a barrier-free kitchen for persons with limited mobility. To obtain these items, free of charge, call 800.626.2000.

Consumers with impaired hearing or speech who have access to a TDD or a conventional teletypewriter may call 800-TDD-GEAC (800-833-4322) to request information or service.

# YOUR HOTPOINT GAS RANGE WARRANTY

Save proof of original purchase date such as your sales slip or cancelled check to establish warranty period.

## WHAT IS COVERED

### FULL ONE-YEAR WARRANTY

For one year from date of original purchase, we will provide, free of charge, parts and service labor in your home to repair or replace **any part of the range** that fails because of a manufacturing defect.

This warranty is extended to the original purchaser and any succeeding owner for products purchased for ordinary home use in the 48 mainland states, Hawaii and Washington, D.C. In Alaska the warranty is the same except that it is LIMITED because you must pay to ship the product to the service shop or for the service technician's travel costs to your home.

All warranty service will be provided by our Factory Service Centers or by our authorized Customer Care<sup>®</sup> servicers during normal working hours.

Should your appliance need service, during the warranty period or beyond, call 800-GE-CARES (800-432-2737).

## WHAT IS NOT COVERED

- Service trips to your home to teach you how to use the product.

### Read your Use and Care material.

If you then have any questions about operating the product, please contact your dealer or our Consumer Affairs office at the address below, or call, toll free: GE Answer Center<sup>®</sup>  
800.626.2000  
consumer information service

- Improper installation.

If you have an installation problem, contact your dealer or installer. You are responsible for providing

adequate electrical, gas, exhausting and other connecting facilities as described in the Installation Instructions provided with the product.

- Replacement of house fuses or resetting of circuit breakers.
- Failure of the product if it is used for other than its intended purpose or used commercially.
- Damage to product caused by accident, fire, floods or acts of God.

WARRANTOR IS NOT RESPONSIBLE FOR CONSEQUENTIAL DAMAGES.

Some states do not allow the exclusion or limitation of incidental or consequential damages, so the above limitation or exclusion may not apply to you. This warranty gives you specific legal rights, and you may also have other rights which vary from state to state. To know what your legal rights are in your state, consult your local or state consumer affairs office or your state's Attorney General.

**Warrantor: General Electric Company**

**If further help is needed concerning this warranty, write:  
Manager—Consumer Affairs, GE Appliances, Louisville, KY 40225**

*This book is printed on recycled paper*

Part No. 164D2764P01 5

Pub No. 39-4710

6-92 CG

# HOTPOINT

RGB747GE



## Free Manuals Download Website

<http://myh66.com>

<http://usermanuals.us>

<http://www.somanuals.com>

<http://www.4manuals.cc>

<http://www.manual-lib.com>

<http://www.404manual.com>

<http://www.luxmanual.com>

<http://aubethermostatmanual.com>

Golf course search by state

<http://golfingnear.com>

Email search by domain

<http://emailbydomain.com>

Auto manuals search

<http://auto.somanuals.com>

TV manuals search

<http://tv.somanuals.com>