

## Hotpoint Service and Spares

FOR SERVICE: If you have a problem with your appliance ring your local Service Office. FOR SPARES and ACCESSORIES: To purchase spares and accessories send your Accessories Order Form to your Spares Centre. If the accessory or spare part you want is not on the form, contact your Spares Centre for prices and availability.

Please address all correspondence to Hotpoint Spares Centre or Hotpoint Service Office as applicable.

Service Offices and Spares Centres are open between 8.00am-5.00pm Monday to Friday, except on Public Holidays. 8.30am-12.30pm on Saturdays.

**EAST**  
**ESSEX:**  
 Industrial Buildings, Beehive Lane, Chemsford, CM2 9TE.  
 Post Codes RM & IG. Tel: (0245) 492433  
 Remainder of Essex Tel: (0245) 269531  
 5 Crawley Road, LU1 1HK. Tel: (0562) 452211  
 Cella Road, PE2 9UB. Tel: (0733) 64741  
 Spares Administration Dept. Tel: (0733) 556520

**LONDON**  
**WEMBLEY:**  
 For Service  
 66 East Lane, HA9 7PQ. Tel: 081-904 4399  
 S. Herts and Middlesex  
 Post Codes N, NW, E, EC Tel: 081-908 4722  
 Post Codes W, WC, SE, SW Tel: 081-908 2511  
 Tel: 081-904 0201

**MIDLANDS**  
**BRIMMINGHAM:**  
 For Service  
 Westgate, Alrdidge, W Midlands, W59 8UX.  
 Post Codes B Tel: (0922) 743374  
 All other Post Codes Tel: (0922) 743376  
 Tel: (0922) 743377

**NOTTINGHAM:**  
 For Service  
 Ashling Street, NG2 3JB. For Spares Tel: (0602) 860387  
 Tel: (0602) 862431/864322. For Spares Tel: (0602) 860387  
 West Ave, Nelson Estate, Talke, S17 1TN. Tel: (0782) 774511

**NORTH EAST**  
**HULL:**  
 Custom House Building, Whitefriargate, HU1 2EU.  
 Tel: (0482) 224777  
 8 Bock House, Tower Road, Glover Est. District 11, NE37 2SH.  
 Tel: 091-417 3500/419 3535  
 Sandbeck Lane, LS22 4TW  
 Tel: (0937) 58126/581444 For Spares Tel: (0937) 581221

**NORTH WEST**  
**MANCHESTER:**  
 For Service  
 Muntford House, 26 Highgate, LA9 6SX. Tel: (0539) 724483  
 44/46 Station Road, Heaton Mersey, Stockport, SK4 3D1.  
 Manchester North Tel: 061-432 0513  
 Manchester South Tel: 061-442 8677  
 Tel: 061-432 0255

**PRESTON:**  
 For Spares  
 7 Bride Way, Merseyside. Tel: 051-525 2342/524 2339  
 24/25 Cannon Street, PR1 3NR. Tel: (0772) 824311

**SCOTLAND**  
**ABERDEEN:**  
 Holbeck House, 68 Caroen Place, AB1 1UL. Tel: (0224) 642283  
 35 West Bowling Green Street, Leith, EH6 5NX. Tel: 031-554 1431  
 West Lodge Road, Blythswood Estate, PA4 9EN  
 Tel: 041-886 6241 For Spares Tel: 041-886 5611

**SOUTH**  
**KENT:**  
 For Service  
 Larkfield Trading Est, New Hythe Lane, Larkfield, ME20 6SW.  
 CT, DA, ME & TN Kent Post Codes Tel: (0622) 716571  
 CR, KT, RH, SM Surrey & BR Kent Post Codes (0622) 790707  
 GU Post Codes in Surrey, Tel Southampton (0703) 667374  
 Tel: (0622) 716631



**SOUTHAMPTON:**  
 For Service  
 Unit B, S Hampshire Ind Park, Salisbury Rd, Tolton, S04 3SA.  
 Tel: (0703) 961981/667374. For Spares Tel: (0703) 967933  
 1 Kingswood, North St, Hailsham, BN27 1DO. Tel: (0523) 842733  
 69 Mulley Plain, PL4 6JH. Tel: (0752) 262651

**WALES**  
**NORTH:**  
 For Service  
 Conwy Rd, Llanudno Junction, LL31 9RE. Tel: (0492) 582826  
 18 Western Ave, Bridgend Ind. Estate, Bridgend, CF31 3SL.  
 Post Codes CF, SA & ST23-29 Tel: (0656) 66421  
 Post Codes BS, GL (incl 55), HR, SY15-18, LD1-8, NP. Tel: (0656) 655554  
 Tel: (0656) 766111

In accordance with its policy of progressive product design, the Company reserves the right to alter specifications.

Hotpoint Ltd, Peterborough, PE2 9UB, England  
 016/417217

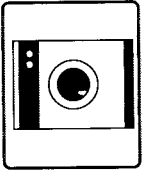
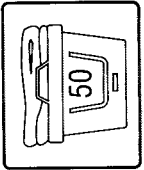
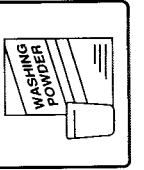
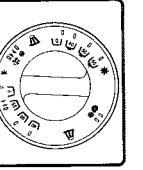
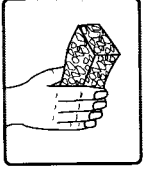
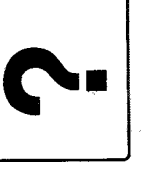
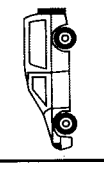
## Contents

	Before you operate your washing machine Know your machine	2 3	page
	How to do a wash or wash and dry How to do a dry only	4-5 6	
	Sorting your laundry/Programme guide Load your machine	7-8 9	
	Washing detergent Fabric conditioner	10 11	
	Selecting your wash programme Additional wash features Selecting your drying programme The machine at work	11-12 13 14-17 18	
	Caring for your machine	19	
	If you think you have a problem ... If it still won't work	20-22 23	
	Hotpoint Service Cover Hotpoint Service Offices and Spares Centres	24	back page

- Service Office and Spares Centre
- Service Office only

**IRELAND**  
**NORTHERN:**  
 256 Ormeau Road,  
 Belfast, BT7 2EZ.  
 Tel: (0232) 647111  
 49 Airways Ind. Estate,  
 Dublin 17.  
 Tel: Dublin 428088  
 Tel: Dublin 428836

**CHANNEL ISLANDS**—Service provided by Agents.  
 Normal Guarantees apply and all Service Schemes are available.  
**JERSEY:**  
 19 Don Street, St. Heller.  
 Tel: (0534) 21625  
 Clos D'Ormes, Poinac,  
 St. Clements. Tel: (0534) 54808

**GUERNSEY & SARK:**  
 Valpys Stores, Grande Rue, St. Martins,  
 Guernsey. Tel: (0481) 39422  
 Barras Lane, Vale  
 Tel: (0481) 51610  
 32 High Street,  
 Tel: (0481) 822686

**ISLE OF MAN**—Service provided by Agents.  
 Normal Guarantees apply and all Service Schemes are available  
 from  
 5 Drumgold St., Douglas.  
 Tel: (0624) 673233  
 or  
 Tromode Works,  
 Cronkbourne Village, Douglas,  
 Tel: (0624) 676066  
 or  
 17 Ridgeway Street, Douglas,  
 Tel: (0624) 258117/25848

**SHETLAND, ORKNEY & WESTERN ISLES**—  
 Service provided by Agents. Normal Guarantees apply, but  
 Service Schemes are NOT available.  
**SHETLAND:**  
 Fort Road, Lerwick  
 Tel: (0595) 2557

**ORKNEYS:**  
 Hatstone Ind. Estate, Kirkwall  
 Tel: (0856) 5457

**WESTERN ISLES:** 27 Bayhead Street  
 Stromway, Isle of Lewis  
 Tel: (0851) 3387

**OTHER ISLANDS:** Local Hydro Electric Shops.  
**EXCEPT ARRAN,  
 BUTE & SKYE**—  
 Which are covered by Hotpoint.





## Before you operate your Washing Machine

1. Make sure that your machine is correctly installed. Follow the Installation Instructions supplied with the machine. If the Installation Instructions are missing, please contact your nearest Hotpoint Spares Centre (see back page).
2. REMOVE THE TRANSIT BRACKET. **YOU MUST NOT OPERATE THE MACHINE WITH THIS BRACKET IN PLACE.**

Disconnect the machine from the electricity supply then follow the procedure as shown on the label on the back of the machine.

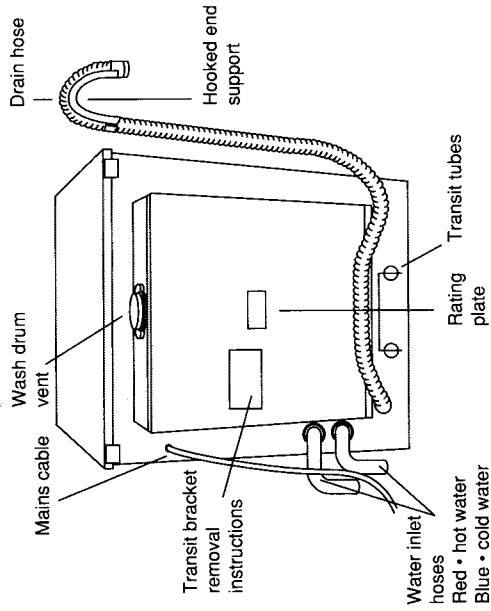

After the transit bracket and tubes have been removed it is normal for the door seal to appear creased. This will not impair the function of the machine.

3. Read these instructions **before** using your machine.  
**NOTE: Do not sit or stand on top of your washing machine; you could injure yourself or damage the machine by such abuse.**

**WARNING: CHILDREN SHOULD NOT BE ALLOWED TO PLAY WITH THE APPLIANCE OR TAMPER WITH THE CONTROLS.**

# Know your Machine



- 'Rinse Hold indicator light
- 'Rinse Hold button
- Gentle action button
- Super rinse button
- Energy Save button

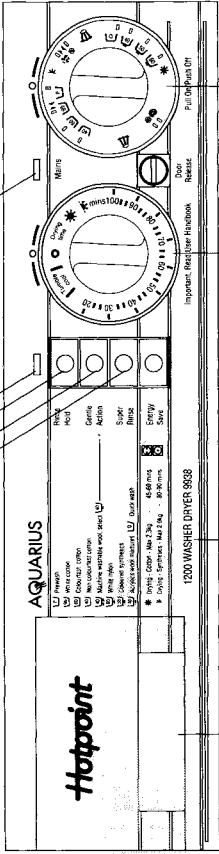

3 Compartment detergent dispenser and liquid detergent dispenser

Programme description

Drying time selector Wash programme selector

## How to Open the Door

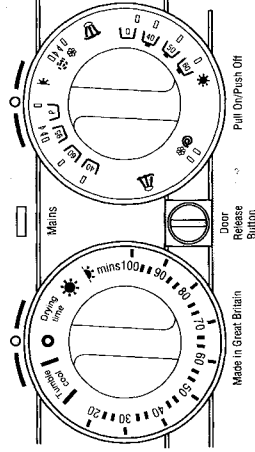

## Programme Selector

Dry

Wash

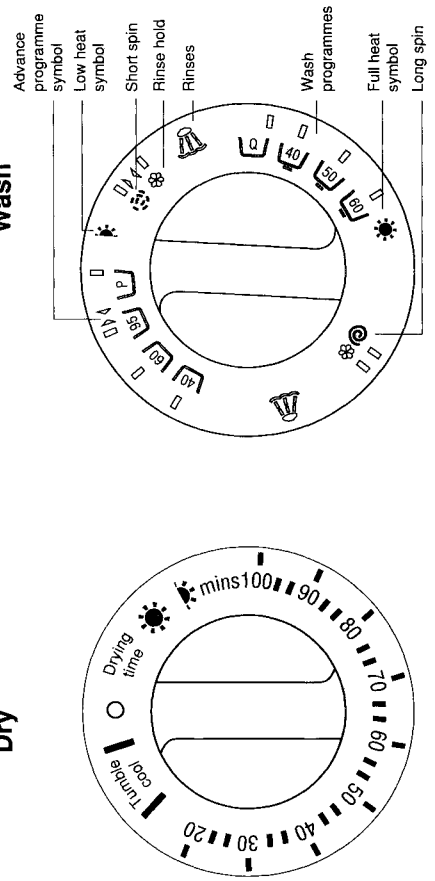



# How to do a wash or wash and dry

1. Turn on hot and cold water

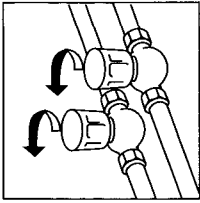

Hot water should ideally be at 60°C (140°F) and **MUST NOT** be above 70°C (160°F). See Installation Instructions

2. Plug in, switch on electricity

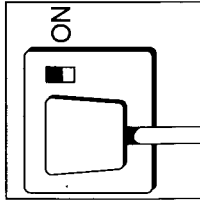

**WARNING: ENSURE HANDS ARE DRY.**

3. Sort your laundry

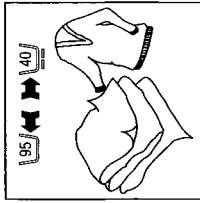

Make up a load of similar fabrics See page 7  
**NOTE: Do not tumble dry woolsens**

4. Load the machine

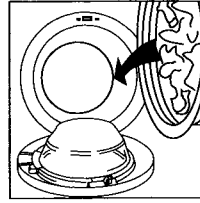

Open the door by pressing the Door Release button on the fascia.  
Don't put in too much  
See page 8

5. Put in washing detergent

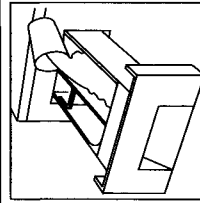

and conditioner if required  
See pages 10 and 11

6. Select programme

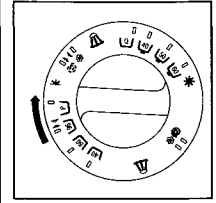

Select programme to suit your laundry  
See page 7



# Hotpoint Service Cover

## Satisfaction Guaranteed or Your Money Back

Hotpoint gives you a unique 'Satisfaction Guaranteed' promise - valid for ninety days after you have purchased your Hotpoint product. If there is a problem with your Hotpoint appliance just call your Hotpoint Service Office. If necessary we will arrange for an engineer to call. If the problem is not resolved by us under this Guarantee, Hotpoint will replace your appliance or, if you prefer, give you your money back. This Guarantee is additional and subject to the terms of Hotpoint's Five Year Parts Guarantee.

## Hotpoint's Free Five Year Guarantee

From the moment your appliance is delivered, Hotpoint guarantees it for **FIVE YEARS**.

- In the Five Years all replacement parts are **FREE** provided they are fitted by our own Service Engineer. During the first year our Engineer's time and labour is also free.
- After the first year we will charge for our Engineer's time and labour. We do, however, operate a range of Service Plans (see opposite) which for an annual payment enables you to cover any repair costs which may be necessary
- All of our service repairs are guaranteed for twelve months in respect of our labour and any parts fitted.
- The appliance must be used in the United Kingdom and must not be tampered with or taken apart by anyone other than our own Service Engineer.
- You may, however, buy parts which can be safely fitted without specialist knowledge or equipment. The correct fitting of such parts, provided they are genuine Hotpoint spares, will not affect your Guarantee. Parts are available from our main Hotpoint Spares Centres.
- Our Guarantee does not cover the cost of any repair which is needed because of power cuts, accidents or misuse. Nor does it cover the cost of any visit to advise you on the use of the appliance except for our Free Installation Check for Automatic Washing Machines and Dishwashers. Please read the instruction book thoroughly.
- If at any time during the Guarantee period we are unable to repair your appliance, we will refund any repair costs paid to us in the previous twelve months. We will also offer you a new appliance at a reduced charge instead of a repair.
- Our Guarantee is in addition to and does not affect your legal rights.
- Should you need independent advice on your consumer rights, help is available from your Consumer Advice Centre, Law Centre, Trading Standards Department and Citizens Advice Bureau.
- All Hotpoint servicing is done by our own Service Organisation located throughout the United Kingdom and Southern Ireland. It will be happy to deal with any problems.

## Hotpoint's Installation Check

If you ask at your local Service Office (see back page), Hotpoint will send one of its trained Engineers to make sure that the appliance has been properly unpacked and correctly connected to existing water and electrical supplies. If you wish, the Engineer will be happy to explain how to use your new appliance.

## Hotpoint's Service Care

Whether you have just one or a number of Hotpoint appliances in your kitchen, Hotpoint has a range of Service Schemes to give you complete peace of mind.

### Service Cover

A single payment covers you for all repairs during the period of cover, which can be from 1 to 4 years. There is also an option of Service Cover with Maintenance at an additional cost. This includes an annual Electrical and Safety check and replacement of any parts as necessary. For 1 year contracts this takes place towards the end of the contract period.

### Kitchen Cover

An annual payment covers you for all repairs for all your Hotpoint appliances which are less than 10 years old. It also covers the cost of loss of food up to £250 in our refrigeration and freezer products. There is also the option of Kitchen Cover with Maintenance at an additional cost. Any additional Hotpoint appliances purchased after you have joined Hotpoint Kitchen Cover will automatically be included during the annual period of cover without further charge.

### Appliance Registration

To ensure that you have the opportunity to benefit from any of the above Service Schemes you should complete and return immediately the Appliance Registration Form supplied with your appliance. Full details and costs of our Service Schemes together with an application form will be sent to you at the end of the first year of the guarantee.

### Annual Safety/Maintenance Checks

Hotpoint strongly recommends that all its appliances are regularly checked for electrical and mechanical safety whether or not they are covered by a Service Plan.

### Proof of Purchase

For future reference please attach your purchase receipt to this booklet and keep it in a safe place.

### Spares and Accessories

Spares and accessories can be ordered from your local Hotpoint Spares Centre (listed on the back page), using the order form enclosed.

**NOTE:** Our Engineer will use every effort to avoid damage to floor coverings and adjacent units when carrying out repairs/service work but in locations where the Engineer advises you that it will be impossible to move the appliance without risk of damage, he will only proceed with your approval that no liability is accepted.



## 7. Select optional wash features

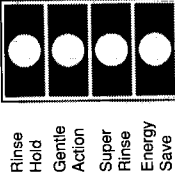

Stops the machine during the final rinse (progs 1.40, 1.50 and 1.50 only). **Do not use when washing machine washable wool.** Washes clothes with a gentle 'rock-a-bye' action (only use on programme 1.40 fabrics). See page 13  
Increases water level for deeper rinsing. Use with Heavily Soiled loads or if people have sensitive skins  
Gives lower wash temperatures

## 8a. Do not select drying timer

If you only want to do a wash. Ensure drying timer is set at '0'.

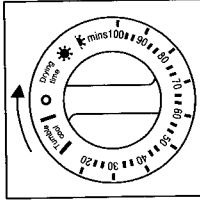

**8b. Select drying time required**  
If you want to do a wash and dry. Select the drying time required. See page 16.

## 9. Switch on machine

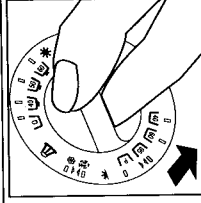

Pull out the Programme Selector. The machine will automatically carry out the programme selected

## during the wash

## 10. Rinse Hold

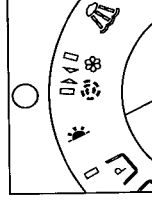

If selected with programmes 1.60, 1.50 or 1.40 the machine will stop at this symbol during the final rinse. **Do not use when washing machine washable wool.**  
To continue, release Rinse Hold button. See page 13

## 11. Switch off machine

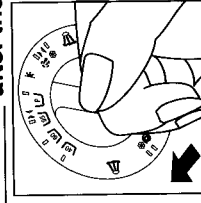

## after the wash or wash and dry

Push in Programme Selector when the wash programme or wash and dry programme has finished. Unlock the door release button (if applicable). Turn the lock in a 90° anti-clockwise direction.

## 12. Take out laundry

For safety reasons the door remains locked whilst the drum is rotating or contains water

## 13. Switch off electricity

**14. Turn off water**

**WARNING: WHEN SWITCHING ELECTRICITY OR MACHINE ON OR OFF, PLEASE ENSURE THAT YOUR HANDS ARE DRY.**

# How To Do a Wash or Wash and Dry



## How to do a dry only

- 1. Turn on cold water**  
(Yes, even for drying)

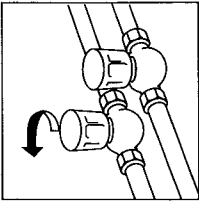

- 2. Plug in, switch on electricity**

**WARNING: ENSURE HANDS ARE DRY**

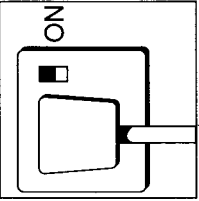

- 3. Sort your laundry**  
Make up a load of similar fabrics  
See page 15

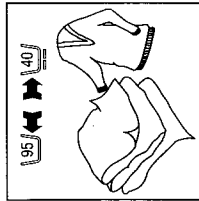

- 4. Load the machine**  
Check maximum load for type of fabric  
See page 15

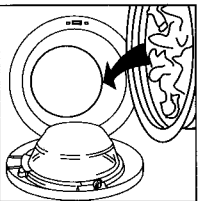

## How to do a Dry Only

- 5a. Select relevant rinse and spin programme**  
If required  
See page 16

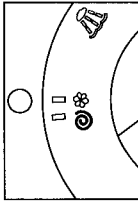

OR

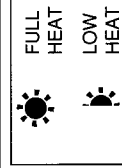

- 5b. Select heat setting**  
See page 16  
Automatically selected if rinse and spin programme chosen

- 6. Select drying time**  
See page 17

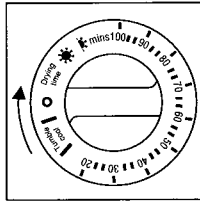

- 7. Switch on machine**  
Pull out the Programme Selector

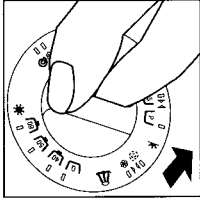

- 8. Switch off machine**  
Push in the Programme Selector when drying is complete  
Unlock the door release button

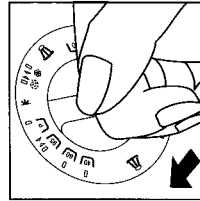

- 9. Take out laundry**  
For safety reasons the door remains locked whilst the drum is rotating

- 10. Switch off electricity**

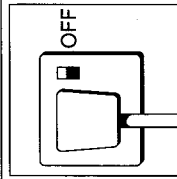

- 11. Turn off water**

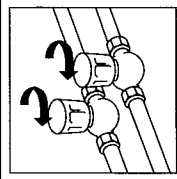

**WARNING: WHEN SWITCHING ELECTRICITY OR MACHINE ON OR OFF, PLEASE ENSURE THAT YOUR HANDS ARE DRY.**

## If it still won't work . . .



### Emergency door opening

If the machine is full of water with your clothes inside, you can open the door by following these instructions. You will need a bucket. First you have to empty some of the water, so that the safety latch will release the door.

1. Turn off the hot and cold taps, switch off the electricity and unplug the machine. Do not use machine again until the Service Engineer has called.
2. Pull out the machine so that you can get at the back of it.
3. Place the end of the Hose in a bucket to drain the water. Draw off about two bucketfuls.

**WARNING: BE CAREFUL, THE WATER MAY BE VERY HOT.**

4. When sufficient water has been removed you will be able to open the door.

### Contact your local Service Office

If something is still wrong with your machine after you've been through the check-lists:

1. Switch off and unplug machine from the mains.
2. Turn off hot and cold taps.
3. Call your nearest Hotpoint Service Office or local importer (outside the UK). The telephone number is shown on the back page. Note down the number here for convenience:

.....  
When you contact us we will want to know the following:

1. Your name, address and post code.
2. Your telephone number.
3. Clear and concise details of the fault.
4. The model number of your machine (9938 for this machine), the serial number (found on the inside of the door) and the colour.
5. The date of purchase. Enter the date here:

6. If you have taken out a Hotpoint Service Cover Plan.

Please make sure you have all these details ready when you call.

## Retention of this Instruction Book

This Instruction Book must be kept handy for reference as it contains important details on the safe and proper use of the appliance.

If you sell or pass the appliance to someone else, or move house and leave it behind, make sure this Book is also provided so the new owner can become familiar with the appliance and safety warnings.

If the Book is lost or damaged a copy may be obtained from Hotpoint Ltd, Celta Road, Peterborough, PE2 9JB.



The door won't open

Has the door lock been set, see page 13.

**Is the door locked?**

**Has the programme finished?**

**Could it be on Rinse Hold?**

**Is there water still in the machine?** Check your drain outlet and waste pipe connections. If your waste installation is wrong, water could be running back into the machine causing the door to lock! Spin out and try again. Emergency door opening procedure is explained on page 23.

The clothes are not dry enough after spinning

**Did you select the right programme for the type of fabric?**

Did the water pump out? (Check waste plumbing arrangements.)

Machine takes a long time

Have you selected a hot wash? See page 16. Hot programmes can take a long time, especially if the water has to be heated up from cold. Other things that can lengthen the programme are:

- Prewash
- Low water pressure
- Modifying your machine to cold fill only

The clothes are not clean

**Did you select the correct programme?**  
(Try a prewash next time and the correct wash programme.)

**Did you use the correct quantity of detergent?** (See page 10.)

**Did you use the Energy Save or Quick Wash?**

**Did you select the correct wash options?**

**Was the machine overloaded?** Good wash results are only obtainable with the recommended wash load.

**Have you used the dryer independently or tried to dry a fluffy load?**

After drying a particularly fluffy load or independent drying it is advisable to set your machine to rinse and spin to wash away any remaining fluff (see note page 16).

How do I clean out the fluff?

There is usually no fluff cleaning necessary on your Hotpoint Washer/Dryer, it is all pumped away down the drain. However you should refer to note 2 on page 16.

**IF YOU INSTALL YOUR MACHINE CORRECTLY AND FOLLOW THE USER INSTRUCTIONS SUPPLIED, YOU ARE UNLIKELY TO EXPERIENCE DIFFICULTIES.**

## Sorting Your Laundry/Programme Guide

The approximate drying times, also printed on the face of your machine, are a guide and should be modified by your own experience. It is advisable to separate light and dark colours. There are often other symbols on the garment label also. These are explained on page 8.

Main Wash				Washing Guide				Drying Guide				
ITCL Codes	New	Old	Turn Selector	Fabric	Maximum Washing Load	Energy Save Temp °C	Wash Temp °C	Maximum Drying Load	Heat Setting	Approx Drying Time (mins)*	Fully Dry	Iron Dry
95			1	White cotton and linen without special finishes	4.5kg	70	85	2.3kg	High	40	40	55
60			2	Colourfast cotton, linen or viscose without special finishes	4.5kg	50	60	2.3kg	High	40	40	55
60			3	White nylon, white polyester/cotton mixtures	2kg	50	60	2kg	Low	80	80	90
50			4	Coloured nylon, polyester/acrylic/cotton mixtures, cotton or viscose with special finishes (eg. drip dry), coloured polyester/cotton mixtures	2kg	40	50	2kg	Low	80	80	90
40			5	Non-colourfast cotton, linen and viscose	4.5kg	30	40	2.3kg	High	40	40	55
40			6	Acrylics, acetates and tri-acetates, blends of these fabrics with wool, polyester/wool blends	2kg	30	40	2kg	Low	80	80	90
40			7	Woolen blankets, wool mixtures with cotton or rayon	2.7kg	30	40	4.4lb				
				Shrink-resistant machine-washable and Superwash and Gentle Action	1.4kg	30	40	4.4lb				
				Woolmark garments	3lb	30	40	4.4lb				
				Do not Tumble Dry								

## Sorting your laundry/Programme guide

Wash codes appear on the labels on most washable items. You may have some items with the old wash code printed on the garment label. For easy reference, the new and old wash codes are shown below. The new codes are shown on your Programme Selector.

For Washing only - select a Programme + Optional Wash Features.

For Washing and Drying - select a Programme + Optional Wash Features and a Drying Time.

For Drying only - select a Heat Setting and a Drying Time.

The machine makes all of the other decisions for you. The following pages explain the settings in much more detail.

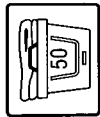

**WASHING:**

Articles labelled should be hand washed.

Hand wash only – eg. glass fibre curtains and washable pleated garments containing synthetics.

Do not machine or hand wash.

**Dry Cleaning:**

All of these are dry cleaning symbols. The letters are to instruct the cleaner what type of solvent should be used.

**A** **F** **P** **X**  
**Garments bearing these symbols should not be washed in your machine, unless the label says otherwise.**

Do not dry clean.

**Bleaching:**

Bleach may be used. In this case the letters 'CL' show that a chlorine household bleach such as 'Domestos' can be used. NB This applies to hand washing only. **Do not use bleach in your machine.**

Do not bleach.

**NOTE: Do not wash non-colour-fast items, woollens or really dirty clothes in a mixed load.**

**Woollens**

Machine-washable woollens may be washed on programme ( + Gentle Wash), but remember:

1. Limit the load to 1.4kg (3lb).
2. Do not use a Prewash (soaking may harm woollens).
3. Do not tumble dry.

**Do not** machine wash woollens which don't have a Washcare label or any label stating they are machine washable.

**NOTE: Some 'woollens' are not made of wool at all but acrylic, which should be washed on programme . Check the label to make sure.**

**Pre-treating dirt and stains**

Brush a little washing detergent dissolved in water onto stains like collars and cuffs to help shift the dirt.

**Treat stains Immediately**

Plunge the stained area into **cold** water, or sponge it down. This prevents the stain from setting. Wash as soon as possible afterwards.

**Nappies:** Scrape off any excess baby cream, such as Vaseline® from the nappies before washing. Use a Prewash programme (page 12) to prevent the cream being transferred to other items in the wash.

**Pockets and Zips**

**DO MAKE SURE ALL YOUR POCKETS ARE EMPTY.**

Tissues can disintegrate and cover all your washing.

Sharp objects like coins and keys can damage clothes and the machine.

Close all zips and tie belts and strings to prevent tangling.



*It's stopped in mid programme*

After the initial fill, the machine may sometimes pause while the heater comes into operation. It should continue after the selected temperature is reached.

**Has it stopped on RINSE HOLD?** If so, press the button to continue the programme.

**NOTE: The Rinse Hold light (if fitted) only operates when the Rinse Hold feature is reached in the programme.**

*Steam is coming out of the detergent dispenser drawer*  
 During HOT washes the machine is designed to vent steam from the dispenser drawer and this is quite normal.

*Water flowing into the machine and out of the drain hose at the same time*  
 Is the drain standpipe at least 500mm (20in) above floor level? See Installation Instructions booklet.  
 Has the drain hose been pushed down the standpipe more than 50mm (2in)? If so, then raise it.

*Suds are coming out from the detergent dispenser*  
 Did you use the right quantity of **LOW SUDS AUTOMATIC DETERGENT**?  
 Select a rinse programme and flush the machine through.

*It makes a noise or vibrates during spin*  
 Your Automatic will make some noises, especially while spinning. **If vibration is excessive, check that you have removed the transit packing. See Installation Instructions.**

Small loads of heavy or bulky items (towels, bath mats, jeans, etc) can cause out of balance conditions but the machine will usually sort itself out.

**Check also that your machine is resting firmly on the floor.** See Installation Instructions regarding levelling of the machine.

Note: Rattling and scraping noises are not normal and may need attention!

*It won't pump out*

**Has the drain hose been installed correctly? (See the Installation Instructions.) Is the hose kinked?** If you have connected to a sink waste spigot, **is the spigot blocked?**





## If you think you have a problem . . .

Look at this list, then check the adjacent suggestions. They may give you the answer to your problem, without having to telephone your Hotpoint Service Office. If you cannot solve the problem, follow the advice given on page 23.

Problem	Check these things first
<i>Powder dispenser drawer won't close properly</i>	Ensure flap is fitted correctly. See page 19. Is the drawer jammed with detergent?
<i>It won't start</i>	Have you selected the programme and pulled out the selector knob? Is the loading door closed firmly? Is it plugged in and switched on at the mains? Is the socket OK? (Try another appliance in it.) Has the fuse blown? (Try a new fuse of the correct rating.)
<i>It won't fill or take in the detergent</i>	<b>Are the taps turned on fully?</b> <b>Are the fill hoses kinked behind the machine?</b> Have you got the hoses connected correctly. See page 2. Have you selected the programme correctly and pulled out the selector knob to start the machine? If you are using a liquid detergent dispenser – did you put powder in the liquid detergent dispenser by mistake?
<i>The programme sticks at the end of the wash or during the rinses</i>	<b>Has the drain hose been installed correctly?</b> If not, syphoning could occur and this will halt the programme. Check the installation instructions. <b>It is important</b> that you do not remove hooked end support and push the hose too far down the waste standpipe.
<i>It's leaking</i>	<b>Are the fill hoses tightened correctly?</b> – Perhaps the washers are not sealed properly. <b>Is your standpipe blocked?</b> <b>Is your household drainage system blocked?</b> If you cannot clear the blockage yourself, you will need a plumber. <b>Removal of the hooked end support may cause a leakage.</b>

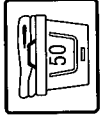

## Load your machine

**Don't overload** your machine. Clothes won't wash properly and damage may be caused to your machine and garments. See page 7 for maximum wash loads.

### Typical Weights

To help you wash the correct quantity of clothes, the chart below lists typical clothes weights.

Clothes	Weight
Blouse	Cotton 150g 5oz
	Other 100g 3½oz
Dress	Cotton 500g 1lb 2oz
	Other 350g 12oz
Jeans	700g 1lb 8oz
10 Nappies	1000g 2lb 3oz
Shirt	Cotton 300g 10½oz
	Other 200g 7oz
T-Shirt	125g 4½oz
<b>Household items</b>	
Duvet Cover (Double)	Cotton 1500g 3lb 5oz
	Other 1000g 2lb 3oz
Large Tablecloth	700g 1lb 8oz
Small Tablecloth	250g 9oz
Tea Towel	100g 3½oz
Bath Towel	700g 1lb 8oz
Hand Towel	350g 12oz
Double Sheet	500g 1lb 2oz
Single Sheet	350g 12oz

### Additional tips:

- Blankets, double bedspreads and other bulky articles should be washed one at a time.
- To load a blanket, hold it by the centre and allow the corners to drop down. Feed it into the machine centre first.
- Highly absorbent loads such as towels and nappies should be limited to 3kg (7lb) per load to ensure adequate rinsing.
- Place small items in a washbag.
- Check the wash symbol on items such as T-Shirts. They may require a cool wash eg. 



## Washing Detergent

### Which one to use?

Use any low suds automatic powder. Non-automatic powders reduce wash performance and can cause overfoaming.

Your machine has been specially developed to take advantage of biological powders. Hotpoint recommends Biological Persil Automatic.

### How much to use

It is important to use the correct quantity in soft or hard water areas; too little won't get the clothes clean, and too much is a waste.

In soft water you will not need to use the total quantity supplied in the trial sample packed in the drum.

Quantities indicated below apply to Persil Original Automatic Powder.

For other detergents refer to the packet.

Detergent	Cottons		Synthetics		Woolens	
	Hard water/ Soft water*	Hard water/ Soft water*	Hard water/ Soft water*	Hard water/ Soft water*	Hard water/ Soft water*	Hard water/ Soft water*
Prewash	75/50 grams	75/50 grams	75/50 grams	75/50 grams	-	-
Full load	200/150 grams	125/90 grams	125/90 grams	125/90 grams	125/90 grams	125/90 grams
Reduced load	125/90 grams	90/70 grams	90/70 grams	90/70 grams	90/70 grams	90/70 grams

These doses are for normally soiled loads  
1 cup = 265ml = approximately 160g.

\*If you are unsure, check with your local water company.

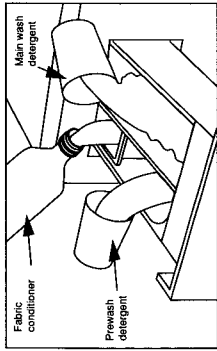

### Where to put it

Pull-out drawer on the left of the machine. Powders or liquids which cannot be dispensed through the drawer should be used in detergent dispensers as recommended by the detergent manufacturer, whose instructions on use and quantities of detergents should be followed.

### Concentrated detergents

Are now becoming more widely available. Follow the detergent manufacturer's guide regarding quantities to use.

### Liquid detergent

To dispense liquid detergents (which do not require their own dispenser) we recommend using the Hotpoint Liquid Detergent Dispenser (Part No. 9003) which is obtainable from your nearest Hotpoint Spares Centre (see back page) using the order form enclosed. Place the Liquid Detergent Dispenser in the right hand section of the dispenser drawer.

Remove any water remaining from the previous wash before adding liquid detergent and ensure that the syphon tube is firmly in position.

When using liquids in their own dispensers, follow manufacturer's instructions.

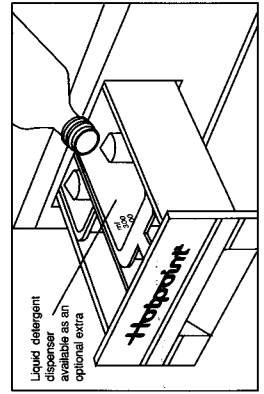

## Caring for your machine



To locate drawer into the machine, hold the top of the flap away from you until it locates under the top of the dispenser opening, then push the drawer back in firmly.

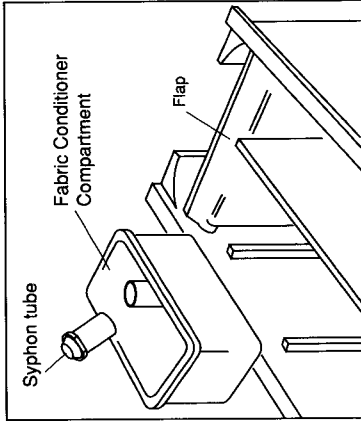

### As necessary

Clean exterior surfaces with a damp cloth or silicon polish only.

**Do not use** abrasive cleaners, scouring agents, acids, chlorine bleach or metal polish to clean any part of the machine. These could damage it.

**Yearly.** We recommend you take out a Hotpoint Service Cover Plan with annual safety/maintenance check which ensures the machine is professionally serviced every year. Details are given at the end of this book.

Hotpoint strongly recommends that all of its machines are regularly checked for electrical and mechanical safety whether or not they are covered by a Hotpoint Service Cover Plan. This is to avoid such things as worn door gaskets or hoses which may cause a leak on a machine which could become dangerous if neglected.

**When the programme has finished:**

- press in the Programme Selector
- cancel any additional wash feature buttons.

### After each wash:

- open door, remove clothes and rotate drum to check for small items left behind.
- remove dispenser drawer for cleaning.

### To clean dispenser:

1. Pull out the drawer until it reaches its stop, then lift slightly and give it a sharp tug to remove it completely (see diagram).

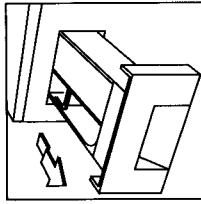

2. Remove fabric conditioner compartment.

3. Pull off syphon tube and clean conditioner compartment.

4. Push syphon tube **firmly** back into place in the conditioner compartment.

5. Clean the dispenser drawer and dry thoroughly.

6. Replace the conditioner compartment in the dispenser drawer, with the syphon tube towards the back.

7. Check that the flap at the back is in place and pivots correctly.



# The machine at work

## What's it doing?

During use you will be aware that your machine will be making some noise and will stop at various intervals during the programme. This is normal. During the wash the machine will:

- 1. Fill** with water, tumbling to mix the detergent.
- 2. Heat** to temperature, with the occasional tumble. This may take some time, so don't be worried if it appears to have stopped working.
- 3. Wash** the clothes, by tumbling, stopping and reverse tumbling.
- 4. Cool rinse.** On programmes , , and , the first rinse has a stepped 'cool down' feature by which cold water is added to the hot wash water to gradually reduce its temperature and prevent shock creasing of the washing.
- 5. Dispense fabric conditioner.** If added, this is dispensed on the final rinse.
- 6. Rinse Hold.** Machine stops on the final rinse on programmes , and , if you've pushed in the Rinse Hold button (see page 13). Push Rinse Hold button to restart programme.
- 7. Spin.** Follows each rinse at one of two different speeds.

**WARNING: IT IS POSSIBLE FOR CHILDREN AND ANIMALS TO CLIMB INTO WASHING MACHINES AND INJURE THEMSELVES.**

## How long can programmes take?

It depends on many things for example:

1. Water flow rate.
2. Temperature of incoming water.
3. Time taken for machine to heat up the water.
4. Features selected.
5. Type and weight of clothes load.

The approximate programme times are:

Programme	Approximate time
	100-110 mins
	75-85 mins
	65-70 mins
	60-65 mins
	75-80 mins
	45-50 mins
	45-50 mins
+ Gentle Action)	40-50 mins

Prewash adds 20-25 minutes.

Drying time Selected Time

Energy Save saves 5-15 minutes.

**WARNING: DO NOT TOUCH THE GLASS DOOR WHEN THE MACHINE IS IN OPERATION AS THIS AREA CAN BECOME HOT.**

# The Machine at Work

## Fabric Conditioner

Hotpoint recommends Comfort. It will soften your washing, eliminate static cling from synthetics and make ironing easier. Add conditioner when adding your detergent. Use the quantity recommended on the bottle. Don't exceed the quantity.

Remove the fabric conditioner compartment and tip out any water remaining in it before adding conditioner. Replace it as shown with the syphon tube towards the back. **Make sure the tube is firmly in place.**

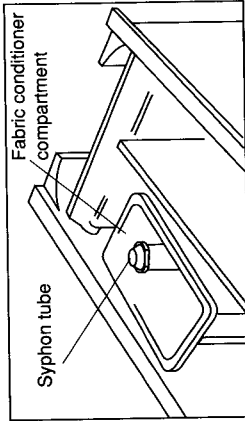

## A Lockable Dispenser Drawer

(Part No. 9002) is available, to prevent young children from opening the drawer whilst the machine is running, or from hiding objects in the drawer. This can be ordered from your local Hotpoint Spares Centre (see back page), using order form enclosed.

**WARNING: DO NOT PULL OUT THE DISPENSER DRAWER WHILE THE MACHINE IS OPERATING AS THERE MAY BE HOT WATER PASSING THROUGH.**



# Selecting your Wash Programme

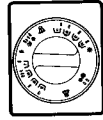

Turn the Programme Selector clockwise to the wash programme according to the clothes label code (see page 7). The symbol selected should be at the top, eg. .

**Do not turn** the Programme Selector **anti-clockwise** and do not turn it when it is pulled out. Push in to select another programme.

Select any additional features.

Pull Programme Selector OUT.

# Selecting Your Programme

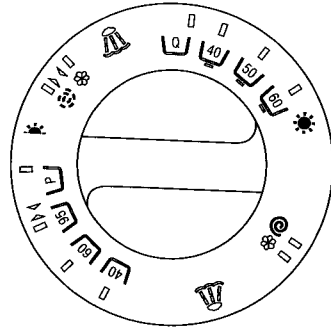

Programme Selector

**Do not attempt to open the door once the programme has started.**

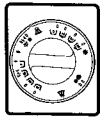

# Selecting your Programme

The following additional programmes may be selected.

## Prewash

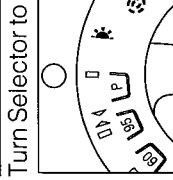

Turn Selector to  
Select Prewash for really dirty clothes, like football kit and nappies.  
Select Prewash before any programme except ( + + Gentle Action).  
When finished Programme Selector will stop at the symbol .  
Push Programme Selector in and turn to select the main wash you want.

## Quick Wash

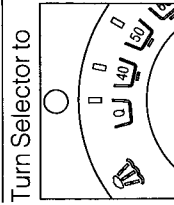

Turn Selector to  
A quick cool wash to freshen up lightly soiled items. Max load 0.9kg (2lb).  
Not recommended for woollen or machine washable wool.

## Spin Only

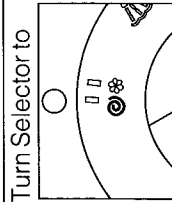

Turn Selector to  
**Long Fast Spin**  
Natural fabrics – wash programmes

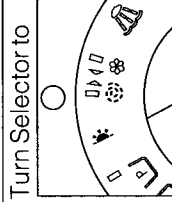

Turn Selector to  
**Short Slow Spin**  
Synthetic fabrics – wash programmes

NB: Do not fill more than half full with wet clothes (natural fabrics) or one-third full for synthetics.

## Rinse and Spin

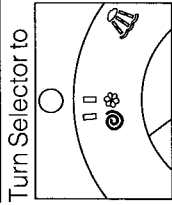

Turn Selector to  
Choose the rinse symbol on the Selector just before the type of spin you want (Long Fast) or (Short Slow) to suit the fabric.

## Rinse

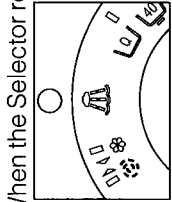

When the Selector reaches  
The machine has commenced the rinses part of the programme.

NB: Woollens and other Handwash only items should only be spin dried, but it is advisable to rinse and spin all other washable fabrics.

Should you wish to select just rinses and spin, turn the programme selector to the symbol and pull knob out.

## End of Programme

When the Selector reaches

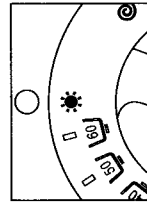

The machine has reached the end of the wash programme selected. If a drying time has been selected the machine will continue into the drying programme until the 'O' on the Drying Timer is in the 12 o'clock position.

## The Cool Tumble Phase:

At the end of the drying cycle there is a cooling down period of about 12 minutes. This is an important part of the drying cycle as it allows the fabrics to gently cool down and consequently minimises creasing. Try to avoid taking clothes out before the end of the programme.

## BE CAREFUL NOT TO OVERDRY

All fabrics contain a little natural moisture even when 'dry', and this natural moisture should not be lost if the clothes are to remain soft and fluffy. If the clothes are subjected to an overlong drying programme they tend to wrinkle, and consequently need more ironing than usual. It is also worth bearing in mind that clothes feel damper when they are still warm. You should allow for this when removing items before the 'Cool Tumble' phase has been completed.

## Items Requiring Special Attention:

- Single blankets and bedspreads can be dried in your machine. During the drying period remove the blanket or bedspread, shake and reload. This will ensure faster and more even drying.
- Starched articles should be dried together in the same load to avoid the distribution of starch onto non-starched items. Do not overdry or the starch will powder and leave the clothes limp.

## Items Not Suitable For Tumble Drying:

- Garments with the ITCL code DO NOT TUMBLE DRY.
- Woollens.
- Large bulky items, eg. continental quilts, sleeping bags, pillows, cushions, double blankets and large bedspreads. These expand when dry and would prevent air flowing through the machine, thus stopping any further drying.
- Items containing foam rubber or rubber like materials or plastic film eg. Pillows, Cushions and PVC rainwear, or any other articles which are inflammable or contain inflammable substances, eg. towels contaminated with hair lacquer.
- Fibreglass.
- Items which have been Dry Cleaned.

**WARNING: THE DRYER IS INTENDED FOR USE ONLY WHERE WATER IS USED FOR THE CLEANING PROCESS. BE CAREFUL NOT TO TOUCH THE DRUM AT THE TOP AS THIS AREA GETS HOT DURING DRYING. ON NO ACCOUNT SHOULD LIQUID FABRIC CONDITIONER BE ADDED DURING THE DRYING PROCESS. MISUSE OF THE DRYER MAY CREATE A FIRE HAZARD.**

When using the dryer do not worry if there is a delay of up to 90 seconds before the machine starts to tumble. This short delay is quite normal and is a result of the machine's timer resetting itself.

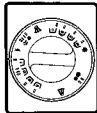

### 5. Set the Drying Time

After the heat setting is chosen set the Drying Timer so that the required drying time is in the 12 o'clock position. Finally pull out the Programme Selector to start the drying cycle. This table summarises the settings to be used when using your machine as an independent dryer including the

optional settings for rinsing and spinning.

The approximate drying times shown are a guide and should be modified by your own experience.

### Drying Only Guide

Fabric Type & Code	Load Dry Weight	Programme Selector Setting*		Drying Timer Setting
		Rinse	Spin	
Natural 195 160J 140J	2.3kg (5lb) max.			40-55
	1.1kg (2 1/2 lb)			30-45
Synthetic 160J 150J 140J 10J	2kg (4.4lb) max.			80-90
	0.9kg (2lb)			40-55

\*Note: Only one of these Programme Selector settings needs to be chosen. Do not Tumble Dry Woollens.

### Additional drying notes

#### 1. Opening the door during drying:

For your safety the door is locked whilst the drum is rotating. BEFORE opening the door always turn the drying timer to 'O' off.

#### 2. Removal of fluff. Your Washer Dryer does not require the cleaning of a fluff filter as the fluff is washed away down the drain. However, after you have dried a particularly 'fluffy' load or if you have used the machine as a dryer only, you MUST, after the dry load has been removed, set your machine to rinse and spin (see page 12). This ensures that any remaining fluff is washed away and is not redeposited on the next wash load.

## Additional wash features

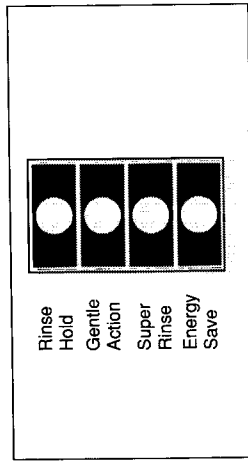

One or more of the option buttons can be pressed in to give you the versatility of wash programme you require.

Select your own wash option BEFORE pulling out the Programme Selector. Press button(s) again to cancel option

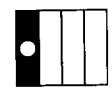

#### Rinse Hold

Minimises creasing of synthetic fabrics  
160J, 150J, 140J, 10J

Programme stops at final rinse with washing immersed in water until they are spun dry.

Press Rinse Hold button to complete programme. Do not select when washing 140J items.

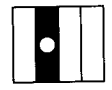

#### Gentle Action

For use with programme 140J to achieve the 140J machine washable wool programme.

When selected, the machine washes the clothes in high level water with a very gentle 'rock-a-bye' action. It provides the Wool Programme suitable for washable shrink resistant, machine washable and Superwash Woolmark garments (see page 7). Simply set the Programme Selector to 140J, press Gentle Action and your woollens will be in safe, gentle hands.

#### NOTE:

1. Remember woollens should not be tumble dried.

### 2. Always cancel the Gentle Action button after use, as it will give reduced performance on other programmes.

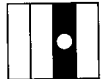

#### Super Rinse

Will increase water level in each rinse on all programmes. Do not press Super rinse button if Programme 140J is selected in conjunction with Gentle Action (see opposite column).



#### Energy Save

To reduce programme temperature.

By pressing the Energy Save button, you reduce the temperature of the wash, for example a 160J programme would wash at 150J thus saving electricity. You may find that normally or lightly soiled clothes can be washed at a lower temperature. It is recommended that when washing heavily soiled clothes, you do not press the Energy Save option.

### Door Safety Lock

If children are nearby, whilst the machine is in operation, it is recommended that the door is locked. To lock, turn the slot 90° clockwise. To unlock turn the slot 90° anti-clockwise.

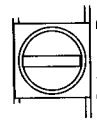

Door Release Button

**DON'T FORGET TO CANCEL BUTTONS AT THE END OF THE PROGRAMME.**

## Additional Wash Features





# Selecting your drying programme

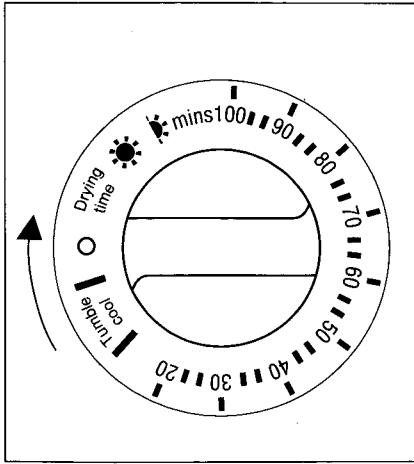

Set the drying time after selecting the wash programme but before pulling the Programme Selector out. Turn the Drying Timer clockwise until the time required is at the 12 o'clock position, then pull the Programme Selector and the machine does the rest. If you turn the Drying Timer too far, it may be turned anti-clockwise to the correct time. **Do not** turn the Timer anti-clockwise past the 'O' (off) position. The approximate times to reach ironing dry and fully dry for a maximum drying load are shown in the Programme Guide on page 7. Smaller loads will take less time to dry.

Your machine dries like any other tumble dryer, by blowing hot air over the wet clothes. It is slightly different in the way it removes the moisture. Normally the damp air is vented through a tube and out of a window, but in the Hotpoint Washer Dryer the moisture is condensed out of the air as it flows over cold water from the mains and is then pumped away down the drain.

**To enable the condensing action to work you must always remember to turn on the cold water tap (and hook the drain hose over the sink, if the machine is not permanently plumbed in).**

You can use your machine for drying in two ways:

1. Automatic drying after any wash, rinse or spin programme (except woollens, when programme 40J is selected with Gentle Action).
2. As an independent dryer.

### Automatic drying

This is simplicity itself. Once you have set the Programme Selector all you have to do is set the Drying Timer (the dial to the left of the Programme Selector) as follows:

### Independent drying

When using the machine as a dryer only, **you must remember to turn on the cold water** (and hook the drain hose over the sink if the machine is not permanently plumbed in). Once the machine is ready follow these simple steps:

#### 1. Sort the clothes before drying:

Sort them into Natural Fabrics (codes 95J, 60J and 40J) and Synthetic Fabrics (codes 60J, 50J, 40J and 30J). It is also a good idea to sort them into large and small items as this will prevent small items from becoming enveloped in sheets etc. and not drying properly.

#### NOTE: Do not tumble dry woollens, code 40J.

(Make sure that the Gentle Action button is cancelled after use.)

#### 2. Do not overload:

Remember that clothes are much more compact when wet so take care not to overload the machine. The maximum drying loads are:  
Natural Fabrics 2.3kg (5lb) dry weight  
Synthetic Fabrics 2 kg (4.4lb) dry weight

#### 3. Rinse and Spin after handwashing:

If you have hand washed your clothes we recommend that you select a rinse and spin programme before drying them. This removes all traces of detergent and extracts much more water than you can by wringing out clothes by hand. Hence drying times are reduced and you save energy and money.

Simply follow the procedure given on page 12 and set the Drying Timer as shown in the table opposite. Your machine will then automatically rinse, spin and dry at the correct speed and temperature.

#### 4. Select the Heat Setting

If you do not Rinse and Spin before drying you will need to select the correct heat setting. Two settings are available, one for natural fabrics and one for synthetics. These are selected using the Programme Selector and are identified as follows:

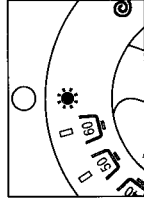

Full Heat – Natural Fabrics, ITCL codes 95J, 60J and 40J.

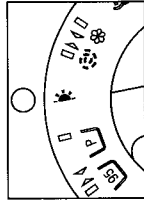

Low Heat – Synthetic Fabrics, ITCL codes 60J, 50J, 40J and 30J.

Choose the heat setting by turning the Selector clockwise until the correct heat symbol is at the 12 o'clock position. Remember that the Selector should be pushed in when you are turning it. Do not tumble dry woollens even though you have washed them on Programme 40J plus pressing the Gentle Action button.

## Free Manuals Download Website

<http://myh66.com>

<http://usermanuals.us>

<http://www.somanuals.com>

<http://www.4manuals.cc>

<http://www.manual-lib.com>

<http://www.404manual.com>

<http://www.luxmanual.com>

<http://aubethermostatmanual.com>

Golf course search by state

<http://golfingnear.com>

Email search by domain

<http://emailbydomain.com>

Auto manuals search

<http://auto.somanuals.com>

TV manuals search

<http://tv.somanuals.com>