



Installation and User Instructions for the First Edition Range



For everyone you'll ever be

WMA13

WMA12

WMA11

WMA10

WMA9

Congratulations on choosing First Edition!!



Please record the Model number and the Serial number of your machine on the Back Cover of the book for future reference.

The Model number can be found on the control panel.

The Serial number can be found on the inner door trim.

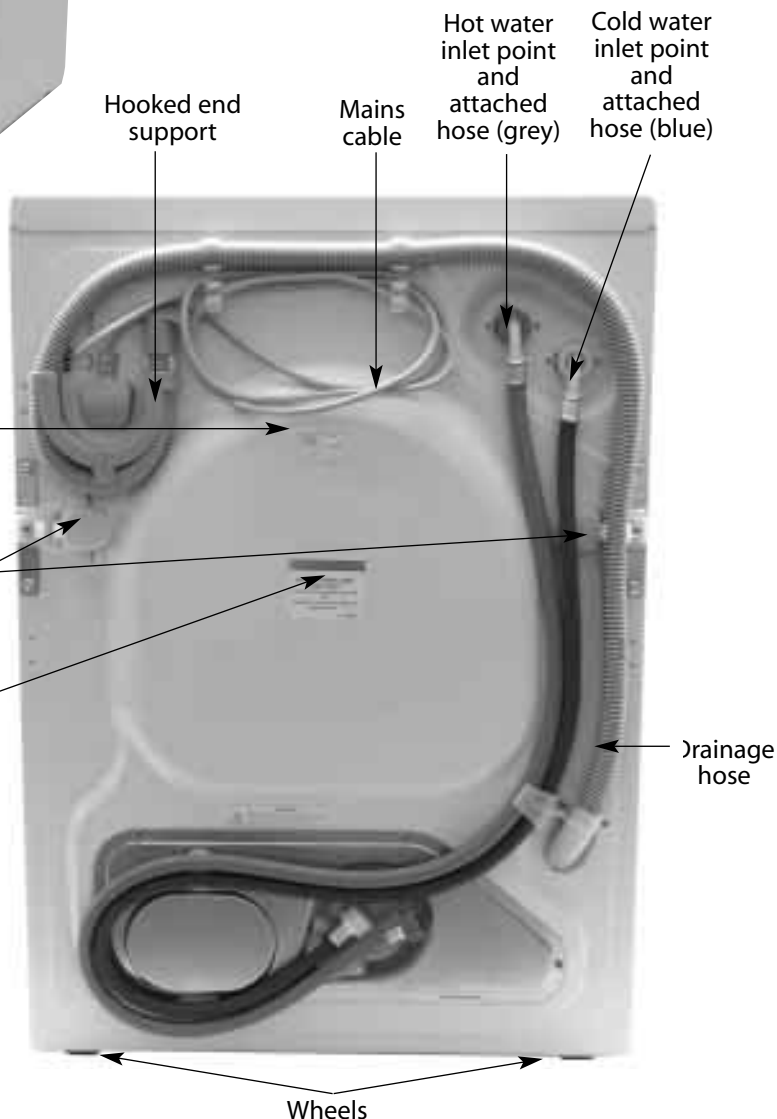
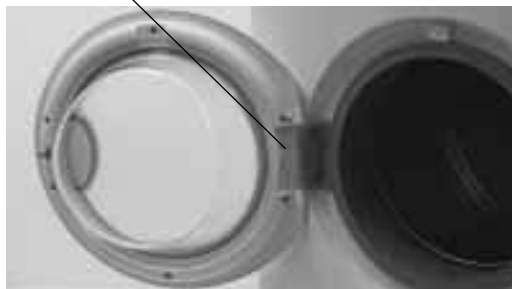

The following instructions and information will help you to get the most out of your new machine...

Safety first!

This instruction manual contains important details on using your machine safely. If you pass the machine onto someone else, make sure that you give them this manual.

Page 4

SAFETY

Installing your machine

Follow these steps for trouble free installation: location, transit bolt removal, electricity, water supplies and drainage. Moving the machine and adjusting the feet.

Pages 5-10

INSTALLING YOUR MACHINE

A typical wash programme

Washcare tips and a simple step by step guide to using your machine.

Pages 11-12

ATYPICAL WASH PROGRAMME

The dispenser

Guidance on getting the most out of your wash using powders, liquids, tablets and fabric conditioners.

Pages 13-14

THE DISPENSER

Programmes, options and other features

Select a programme for any wash including automatic functions, pre-washes and economy loads.

Pages 15-18

PROGRAMMES AND OPTIONS

Cleaning and maintenance

How to care for your machine by removing and cleaning the dispenser drawer and compartments, cleaning the door bowl and machine exterior plus the recommended Maintenance wash.

Page 19

CLEANING & MAINTENANCE

Troubleshooting

In the unlikely event that you have problems with your machine, the following guide may help you to get your machine working correctly straight away.

Pages 20-21

TROUBLE SHOOTING

After sales service and guarantee

We give you a unique 'satisfaction guaranteed' promise - valid for ninety days after you have purchased your machine.

Pages 22-23

SERVICE & GUARANTEE

Safety first

This instruction manual contains important details on using your machine safely. Please keep it safe for your future reference.

If you pass the machine onto someone else, please make sure that you give them this manual so that the new owner can read these safety warnings.



- **Dispose of packaging materials carefully and keep them well away from children.**
- **When disposing of your old machine, to minimise risk of injury to children, isolate from the electrical supply, remove the door, the plug and cut the mains cable off flush with the appliance. Dispose of them separately to make sure that the appliance can no longer be plugged into a mains socket.**
- **This washing machine is designed for domestic use only.**
- **Before using your machine remove the transit bolts and spacers from the back of the machine. Keep the parts you remove for future transportation.**
- **Any electrical work necessary to install this machine should be carried out by a qualified electrician.**



- **Do not plug your machine into a socket when your hands are wet.**
- **Do not connect the washing machine to a single outlet instantaneous water heater.**
- **Do not try to modify this machine in any way.**
- **Do not connect the washing machine directly to an artificial water softening unit. Use the recommended amount of detergent for the water hardness in your area.**
- **Do not let children play with the machine or its controls.**
- **Do not stand on the machine or in the door opening.**
- **Do not lean on the door or use the door to lift or move the machine.**
- **Do not wash garments that have previously been treated with solvents.**

Remove the polystyrene block...

After removing the packaging from the machine, make sure that the polystyrene block (figure 1) has come away from the underside of the machine, with the polystyrene base.

If it has not come away, carefully lower the machine on its side onto the polystyrene top cap and then remove the polystyrene block (see figure 2). You may need a second person to help you lower and raise the machine.

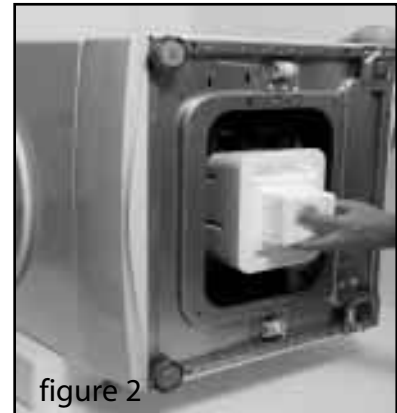
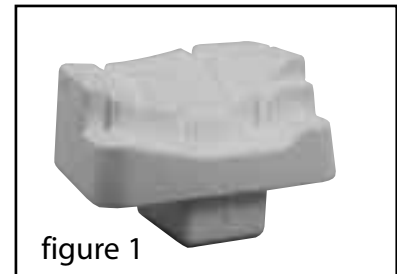

Installing your machine

Follow these steps for trouble free installation:

1. Choose a location...

Where you install the machine will affect its performance.

- For your safety and to comply with electrical regulations, seek professional advice if you want to install your machine in a bath or shower room.
- Make sure that the electrical socket and water taps are easily accessible. You should switch off the machine's electrical and water supplies when you are not using it.
- Make sure that you allow enough space for the machine. Select a space at least 600mm wide, 600mm deep and 850mm high. Also leave enough space to open the door fully so you can load and unload it easily.
- Where possible the machine should be positioned on a solid level floor to minimise vibration.
- Take care when you move the machine not to rip any floor coverings. There are wheels on the bottom rear of the machine, so tilting it backwards a little is the easiest way to move it. The weight of the machine may cause indentations in some floor coverings.

WARNINGS:

- **Do not plug the machine in and switch it on at the mains until the installation is completed.**
- **You may be charged for a service call if a problem with your machine is caused by incorrect installation or misuse.**



2. Remove the transit fixings...

There are **two** transit bolts fitted under plastic covers, one at either side of the rear of your machine. These bolts prevent damage to the machine while it is being transported. Remove both transit bolts complete with spacers, by following the instructions below.

Use a screwdriver to release the covers and a standard 13mm spanner to remove **both** bolts.

WARNINGS:

- Before you use the machine, remove the two transit bolts complete with spacers. If you do not do this, damage may occur to your machine. Keep the parts in case you need them for future transportation.
- If and when you replace the bolts complete with spacers make sure you do not overtighten them.

Firstly, unhook the grey drainage hose and proceed as follows, taking care not to loosen the hot and cold water fill hoses.



Using a screwdriver, remove the screw to release the plastic cover.

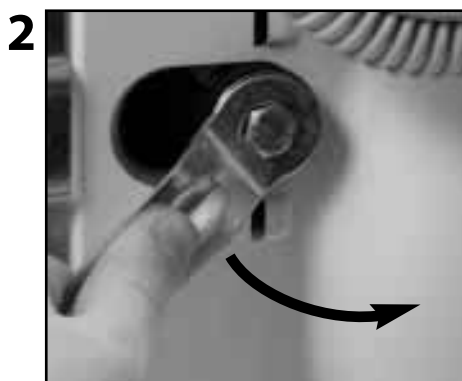

Use a standard 13mm spanner to undo the bolt until three threads can be seen on the bolt. (see below)

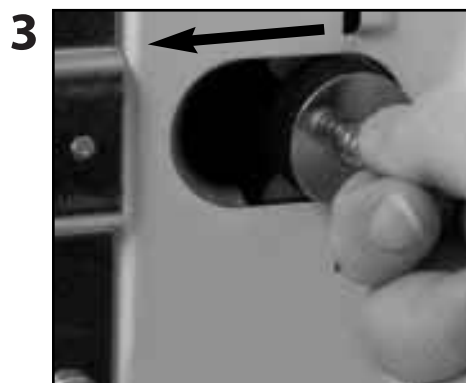

Hold the transit bolt and slide to the side and then pull out. The bolt and spacer should be removed intact. (see below)

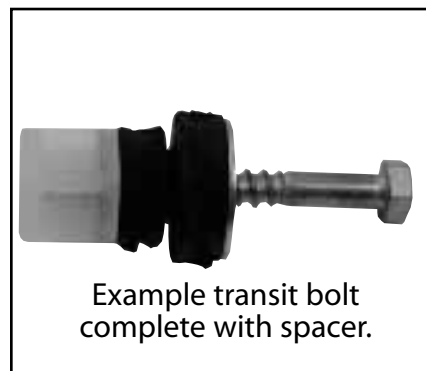

For **safety**, replace the plastic cover over the hole left by the transit bolt.

(Repeat steps 1 to 4 to remove the second transit bolt).

3. Connect your machine to the electricity supply

Make sure that the electrical socket is accessible. Take the mains lead from the back of the machine and plug it into the socket. We do not recommend wiring your machine directly into the mains supply.

Changing the mains lead

If you have damaged the existing lead and need a new one, contact Hotpoint Service UK on 08709 066066 or www.theservicecentre.co.uk (or in the Republic of Ireland on 1850 302 200). A charge will be made. We strongly advise that fitting the new lead is carried out by a qualified electrician.

Changing the plug

If you need to change your plug if it does not fit your socket; isolate the machine from the mains supply. Cut off the supplied plug and safely dispose of the discarded plug. Note: If you change the plug, the colour of wires in the mains lead may not match the colour of the markings which show the different terminals in the plug. You must wire it as shown below.

Green and yellow

(Earth) wire this to the terminal marked 'E', ⊕ symbol, or coloured green and yellow.

Blue (Neutral)

wire this to the terminal marked 'N' or coloured black.

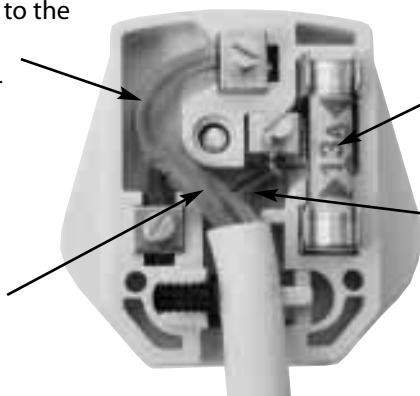

13A ASTA approved fuse to BS1362.

Brown (Live)

wire this to the terminal marked 'L' or coloured red.

Fuses

Your machine comes fitted with a plug and a 13 amp (13A) fuse. If you need to replace the fuse, use only those rated at 13 amp (13A) and ASTA approved to BS1362. To change the fuse, lift the holder to vertical position and lift the fuse out. To replace the fuse, insert the fuse and push the fuse holder down into the locked position. Correct replacement is identified by colour coding or the marking on the base of plug.

WARNING:

Do not use the plug unless the fuse holder is in the locked position and the top cover firmly replaced.

CE CE marking shows that this machine meets the following EEC directives.

Low Voltage Equipment - 72/23/EEC & 93/68/EEC

Electromagnetic Compatibility - 89/336/EEC, 92/31/EEC & 93/68/EEC.

WARNINGS:

- This machine must be earthed.
- Do not use the plug unless the fuse cover is fitted.
- To avoid a shock hazard, when changing a plug, always safely discard the cut off plug. Do not insert into any other socket.
- Seek professional advice if you need to use an extension lead.

4. Connect your machine to the water supply...

WARNINGS:

- The temperature of your hot water supply should ideally be 60°C and no higher than 70°C as this could cause damage to your laundry and the machine.
- Do not connect the machine to a single outlet instantaneous water heater.

- Your hot and cold water pressure should be between 3 and 150 psi (21 - 1034 kPa).
- The water supply taps should be accessible when the machine is installed.
- Before connecting the fill hoses, check that water is running from the water supply taps you will use for your machine.
- Connect the washing machine to the water supply using the fill hoses fitted to the machine. Do not use old hoses.

Hot and cold fill

- 1 Unclip the grey and blue fill hoses from the back of the machine.
- 2 Connect the free end of the grey fill hose to the HOT water supply (see figure 1). Connect the free end of the blue fill hose to the COLD water supply.
- 3 Turn on your water supply and check for leaks. If there is a leak, turn off the water supply, remove the connector and check that the sealing washer is in place. Refit the connector and tighten it. Turn on the water supply.
- 4 When moving the machine into its final position, make sure that the hoses are not trapped or kinked.

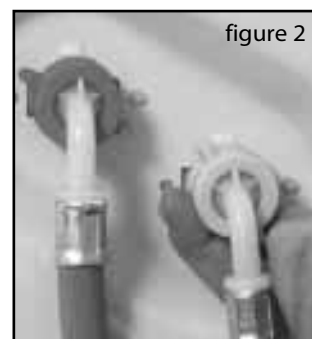

If the fill hoses are too short:

Longer fill hoses are available from our Genuine Parts and Accessories Mail Order Hotline UK on 08709 077 077 or www.theservicecentre.co.uk (or in the Republic of Ireland on (01) 842 6836).

Remove the existing fill hoses from the inlet valves on the back of the machine and fit the new longer fill hoses as shown above with the angled ends of the hoses connected to the machine (see figure 2).

If you have no hot water supply or your hot water pressure is low:

A cold fill adaptor (figure 3) and fitting instructions are available from your local Hotpoint authorised Service Centre or by calling the Genuine Parts and Accessories Mail Order Hotline UK on 08709 077 077 or www.theservicecentre.co.uk (or in the Republic of Ireland on (01) 842 6836).

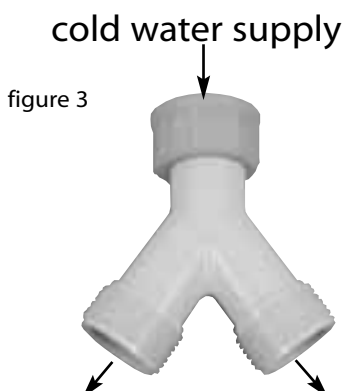

figure 3

5. Connect the machine to a drainage system...

- Take care when you remove the drain hose from the clips on the back of the machine. All machines are tested with water before they leave the factory so a small amount of water may still be in the hose.
- Do not remove the hooked end support from the GREY drainage hose when using any of the drainage methods detailed below. You may need to reposition it as required along the drainage hose.
- For drainage into a standard work top sink, ensure the outlet pipe has a minimum diameter of **32mm**. If your sink is inset, the front edge of the basin must be less than **75mm** from the front edge of your worktop, so that the drain hose will hook securely into the sink. Unclip the drainage hose from the back of the machine and hook over into the sink. Make sure that the sink is free of any obstructions and that the sink plug can not fall into the sink, preventing the water from draining away freely. Pumped out water may be very hot.



We recommend one of the following drainage methods:

Standpipe

- 1 Make sure that the standpipe has a minimum diameter of 38mm.
- 2 Remove the drainage hose from the clips on the back of the machine.
- 3 Make sure that the top of the standpipe is positioned at least **500mm** from the floor (see figure 1). Use the plumbing indicator line label on the back of the machine as a guide.
- 4 Place the drainage hose approximately 100mm into the standpipe.

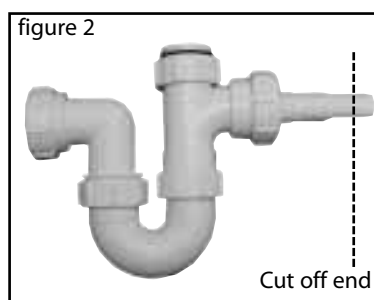

Under sink waste system

- 1 Cut out the membrane, bung or blanking plug (see figure 2).
- 2 Unclip the drainage hose from the back of the machine.
- 3 Move the hooked end support along the drainage hose as required.
- 4 Attach the drainage hose securely to the under sink drainage unit, using a hose clip (see figure 3).
- 5 Raise the hooked end support up to at least **800mm** to avoid water being drawn back into the machine.



If the GREY drainage hose is too short

A longer drainage hose is available from our Genuine Parts & Accessories Mail Order Hotline

UK on 08709 077 077 or www.theservicecentre.co.uk
(or in the Republic of Ireland on (01) 842 6836).

WARNINGS:

- Take care when using the sink drainage system. The discharge water may be very hot.
- Do not position the standpipe near an electrical socket.
- Flooding could occur if any part of the installation is not carried out correctly.

6. Move the machine into position...

WARNING:

- Do not drag or lift the machine by its door.

Your machine is heavy so care must be taken when moving it. To help you we have fitted wheels to the bottom rear of the machine.

- Please take care not to damage any floor coverings when moving the machine.
- When moving the machine, take care not to kink or damage the hoses at the back of machine.

7. Adjust the feet...

Once the machine is in place

Your machine may become noisy or move about if it is not level.

If necessary, to level the machine adjust the two front feet, as follows:

- 1 Remove the yellow labels from the feet.
- 2 Turn both the locking disc and foot together clockwise until the machine is standing firm and does not rock. To check this use a spirit level.
- 3 Turn only the locking disc anti-clockwise until it is in contact with the base of the machine.
- 4 Switch the machine on at plug socket.

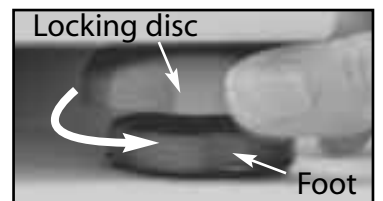

Now that you have successfully installed your new machine, we advise that you run it through a programme C wash without any laundry and without any detergent in it.

This will check your installation, connections and drainage, and will thoroughly clean the interior before you carry out an actual wash programme on your laundry.

NOTE: This will take approximately 2 hours 30 minutes to complete.

Continue reading this book to get to know the various features of the machine.

Using your machine

The rest of this instruction book will help you to make the most of your new washing machine. We have created the machine for the way you live, by listening to people just like you who use our products. You will find that your new machine has many useful features and is easy to use.

Washcare tips...

- Your machine can wash a maximum load of 5.5kg (cotton).
- Do not overload the machine (maximum load 5.5kg). In addition to reducing the quality of the wash, this may also damage your laundry and the machine.
- We strongly recommend that you do not wash **underwired bras** in this machine. Should the wires become detached it could cause damage to your clothes and the machine. If the washcare label states that the bra is machine washable, then we advise placing it in a sealed pillow case or a similar washbag.
- Do not use the machine if the item to be washed does not have a wash label.

Before washing laundry we recommend that you do the following:

- Pre-treat awkward stains with washable treatments. Do not wash any items that have previously been treated with solvents.
- Close zips, fasten belts, tie strings and close press studs to prevent tangling.
- Empty all objects from pockets as they may damage clothes and the machine.
- Limit the size of absorbent loads, for example towels to 3kg (7lb) to give good washing and rinsing results.
- Place small items in a wash bag.
- Always follow the care label on items when choosing a wash programme.
- Wash non-colourfast items or really dirty clothes separately as they may affect other items.

Weight of Wash Load

Two examples of maximum wash loads for different types of fabric.

COTTON

2 Bath Towels
5 Shirts
6 Blouses
1 pair of Pyjamas
4 items of Underwear

= 5.5kg

SYNTHETIC

2 Children's Dresses
4 Shirts
4 Blouses
1 pair of Pyjamas
4 items of Underwear

= 3kg

A typical wash programme

WARNINGS:

- Do not allow children to play with the machine or tamper with the controls.
- Do not overload the machine! It may damage laundry and reduce the quality of the wash.
- Do not try to open the door when the door indicator light is on.
- Do not open the dispenser drawer during any programme.

- 1 Sort your laundry into groups by washcare labels. Load the machine, making sure that clothes are not trapped in the door. Close the washing machine door by pushing it until it clicks.



- 2 Add detergent and fabric conditioner, if required, to the dispenser drawer. Refer to the detergent manufacturer's dosage instructions.



- 3 Turn the programme selector dial to the programme required. The '**Prog End**' light will illuminate, indicating that the machine has power.



- 4 Select any optional wash feature(s) that you may require by pressing the appropriate button(s), indicator lights will show what you have chosen.

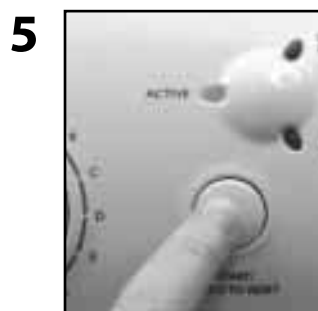

- 5 When all selections have been made press the '**START/Hold To Reset**' button. The '**Prog End**' light will go out and the '**Active**' light will illuminate to indicate the start of a programme. After a short time the '**Door Locked**' indicator light will illuminate. To cancel a programme once the machine has started, press and hold in the '**START/Hold To Reset**' button for two seconds, until the '**Prog End**' light flashes. You can then re-select the programme you want. Press the '**START/Hold To Reset**' button again to carry on.



- 6 During the wash programme the '**Active**' and '**Door Locked**' indicator lights will remain lit.

- 7 When the programme has finished the '**Prog End**' and '**Door Locked**' indicator lights will remain lit. After a short time the '**Door Locked**' indicator light will go out. You can then open the machine door.



- 8 To switch the machine off, return the programme selector dial to its '**OFF**' position. The '**Prog End**' light will go out. We also recommend that you switch off the electricity and water supply.

The dispenser

IMPORTANT INFORMATION. We have set the detergent retaining flap, in the main detergent compartment to dispense powder detergent only. If you want to dispense liquid detergent put the retaining flap in its 'down' position.

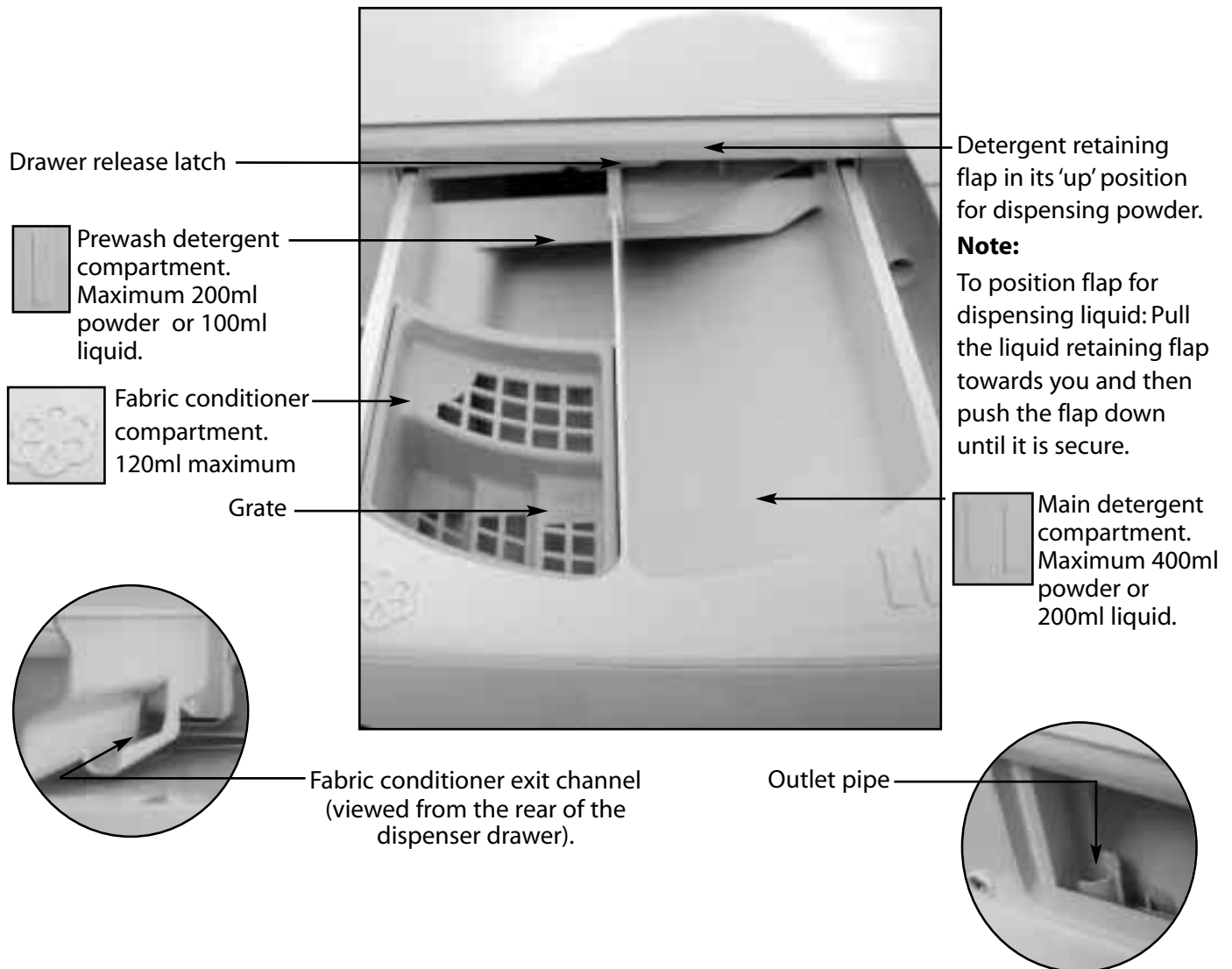

Choose a suitable detergent

- Follow the detergent manufacturer's recommendations to make sure you use the correct amount for your wash.
- To achieve the best wash results, the water hardness, degree of soiling and load size need to be considered and the recommended amount of detergent used.
- We recommend the Persil range of detergent products and Comfort fabric conditioner.
- Choose 'lowsuds' automatic powder, liquid or tablets, designed specifically for automatic washing machines. Do not use handwash detergent, even on the handwash programme as excessive suds will occur.
- Do not use too much detergent or exceed the maximum level indicators.
- Do not use too little detergent, you will not achieve a clean wash. Follow the detergent manufacturer's recommendations.

WARNING:

- Do not put any item(s) into the drawer other than detergents that are designed to be released from the drawer as they may cause damage or blockage.

Dispensing powder detergent

To achieve the best wash results the manufacturer's recommended amount of detergent should be measured and added to the dispenser drawer (max. 400ml).



Dispensing liquid detergent

The liquid retaining flap is preset for adding powder detergent. To add liquid detergent, change the position of the liquid retaining flap as follows.



1 Pull the liquid retaining flap towards you.



2 Push this flap down until it is secure.

The liquid detergent retaining flap indicates four lines which represent the amount of liquid you may need to use (see 2 above). Do not go above the maximum level of 200ml.

Note: It is normal when using liquid detergent, for a small amount of water to remain in this compartment, after the wash has finished. Lift the flap slightly and it will drain away.

Dispensing tablets

Most tablets are dispensed via the machine drum using a net, or similar device, which is placed on top of the washload towards the back of the drum. However, some tablets are designed to be placed in the dispenser drawer. Check the pack for details.

Using in-drum dosing

Dosing devices - balls, nets etc can be used. Place upright, on top of the wash load and towards the back of the machine.

Do not use with pre-wash programmes A and B.

Pre-wash

When you are using programmes 'A' or 'B' add detergent to the pre-wash compartment (I symbol).

Add the detergent for the main wash to the main wash compartment (II symbol).

Adding fabric conditioner

Pour the recommended dosage of fabric conditioner into the compartment (flower symbol). Do not exceed the maximum fill line.

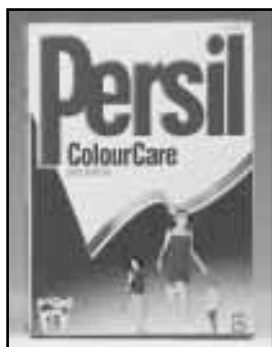

Wash programmes

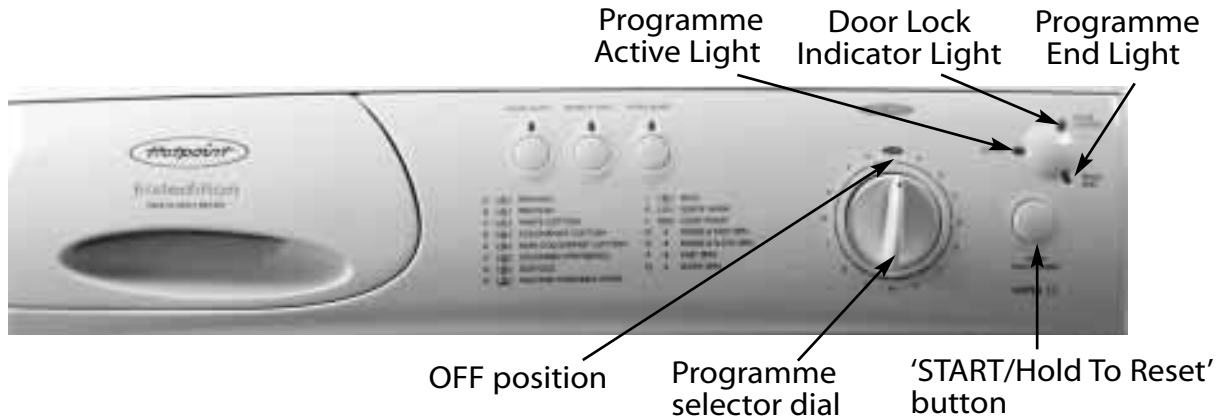

On-Off / Selecting a programme

The machine is switched on, by turning the programme selector dial away from the '**OFF**' position, to your selected programme. To start the programme press and release the '**START/Hold To Reset**' button.

When the programme has finished return the programme selector dial to the '**OFF**' position.

To pause a programme

To pause a programme hold the '**START/Hold To Reset**' button for two seconds until the '**Prog End**' indicator light flashes. To continue press the '**START/Hold To Reset**' button once more.

To change a programme

If you want to change a programme, hold the '**START/Hold To Reset**' button for two seconds until the '**Prog End**' indicator light flashes. You can then change the programme. Press the '**START/Hold To Reset**' button to continue.

If you turn the programme selector dial during a programme the '**Active**' indicator light will flash to show that the programme running is not that shown on the dial. Turn the dial to the original programme to stop the flashing. The flashing will stop automatically when the programme enters the rinse phase.

WARNINGS:

- **Do not allow children to play with the machine or tamper with the controls.**
- **If you cancel a programme part way through a wash or there is a power cut, take care when opening the door. The machine may contain hot water.**
- **In the unlikely event of something not working see the Trouble - shooting section.**

Wash programmes

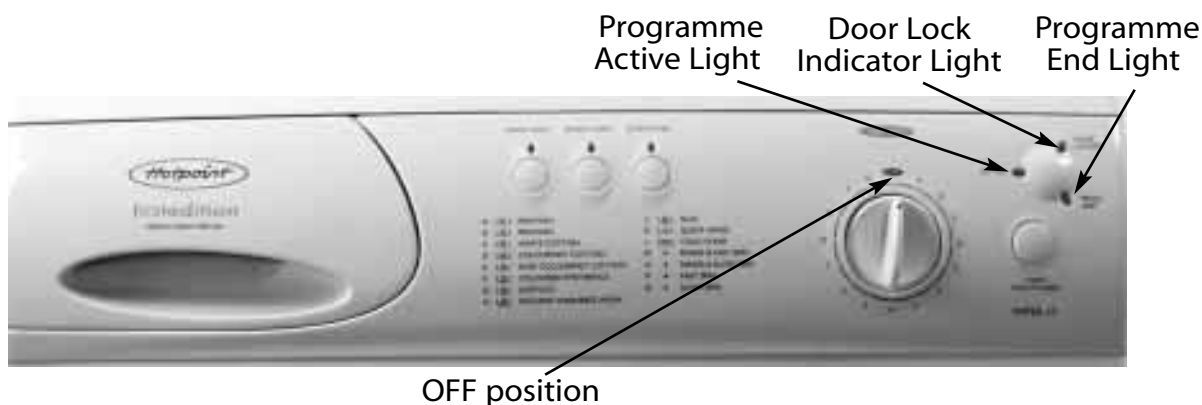

WARNINGS:

- Do not try to open the door while the 'Door Locked' indicator light is on.

The 'Active' Indicator light

As soon as the selected programme has started the 'Active' indicator light will glow. This light will remain lit throughout the programme and will go out when the programme has finished.

Door Locked Indicator light

The 'Door Locked' indicator light will come on two seconds after you press the 'START/Hold To Reset' button and will stay lit throughout the programme. A short time after the programme has finished the 'Door Locked' indicator light will go out and you can then open the door.

Door not closed











The programme will not start if the door is not closed properly, the 'Door Locked' indicator light will be flashing to show this. Please make sure that the door is properly closed by pushing it until you hear the catch click.

The 'Prog End' Indicator light

After the selected programme has finished the 'Prog End' indicator light will glow. It will remain lit until you return the programme selector dial to its 'OFF' position or start another programme.

Wash programme dial

Turn from 'OFF' to the programme you need.

Programme	Wash label	Fabric	Wash temp. °C	Maximum dry weight load	*Approx. programme time (mins)	Spin speed
Automatic Pre-wash and Wash Programmes						
A		White cotton Heavy soil	95	5.5kg	2 hours 30minutes - 2 hours 40minutes	Fast
B		Cotton heavy soil	40	5.5kg	1 hour 40minutes - 1 hour 50minutes	Fast
Wash Programmes						
C		White cotton and linen without special finishes	95	5.5kg	2 hours 20minutes - 2 hours 30minutes	Fast
D		Colourfast cotton linen or viscose without special finishes	60	5.5kg	2 hours 5minutes - 2 hours 15minutes	Fast
E		Non-colourfast cotton, linen or viscose	40	5.5kg	1 hour 40minutes - 1 hour 55minutes	Fast
F		Synthetics coloured nylon, polyester, acrylic and cotton mixtures, cotton or viscose with special finishes, coloured polyester and cotton mixtures.	50	3kg	1 hour 5minutes - 1 hour 15minutes	Slow
G		Acrylics acrylics and tri-acetate blends of these fabrics with wool, polyester and wool blends	40	3kg	40 - 50minutes	Slow
H		Wool shrink resistant machine- washable wool, woollen blankets.	40	1.5kg	1 hour 15minutes - 1 hour 25minutes	Fast
		Wool mixtures with cotton or rayon.	40	2.5kg	1 hour 15minutes - 1 hour 25minutes	Fast
J		Silk Printed acetate	30	3kg	55minutes - 1 hour 5minutes	Slow
K		Quick wash for freshening up lightly soiled items. Warning: not for woollen, silk or delicate items.	35	1kg	35 - 45minutes	Slow
L		Cold wash cold fill only, no heating action	25	3kg	55minutes - 1 hour 5minutes	Slow
Rinse and Spin programmes						
M	Rinse and fast spin	Cotton		5.5kg	30minutes	Fast
N	Rinse and slow spin	Delicates		3kg	30minutes	Slow
Spin only Programmes						
P	Fast spin	Cotton		5.5kg	15minutes	Fast
Q	Slow spin	Delicates		3kg	15minutes	Slow

*can vary, depending on the temperature of incoming water.

Options

Option Buttons



Choosing an option button

To choose an option, press the button and you will see a light come on above the button. Press again to cancel, and the light will go out. You cannot alter the options once the machine is running.

Rinse hold... use this option to...

- **Help reduce the creasing of delicate or synthetic fabrics by holding clothes in the final rinse water.**

The 'Rinse Hold' option light will flash to indicate that the programme is holding the clothes in the final rinse water. Complete the final spin by pressing the 'Rinse Hold' button when the light is flashing.

This option is not available with Wool or Spin only programmes.

Energy Save... use this option to...

- **Save money and time on lightly soiled loads.**

This option is not available with Quick Wash, Rinse and Spin or Spin only programmes.

Super rinse... use this option for...

- **Large wash loads and items for young children or people with sensitive skin.**

This option increases the water level of the first two rinses.

This is not available with the Cold Wash, Rinse and Spin or Spin only programmes.

Automatic Features

Auto half load

Auto half load saves you time and money when washing smaller loads. Water levels are automatically adjusted to cater for the different loads.

Unbalanced load warning

Your machine has an inbuilt feature to prevent it spinning with an unbalanced load. This will minimise excessive vibration and prolong the life of the machine.

Before each spin the machine 'senses' the load within the drum and if the machine considers the load to be unbalanced, it will not automatically spin. Instead the machine will try to redistribute the load to achieve balance by tumbling backwards and forwards. If it is unable to balance the load after the fifth attempt the machine will abort the spin process and the load will still be wet at the end of the programme.

If this safety feature is encountered you can spin the load after first opening the door, redistributing the load and reselecting a fast or slow spin programme. In the case of small loads or single items you may try adding some extra items of a comparable size to help balance the load.

Cleaning and maintenance

WARNINGS:

- Do not clean any part of your machine with abrasive cleaners, scouring agents, acids, chlorine based bleach or metal polish as they may cause damage.
- Do not try to clean any part of the dispenser drawer while the machine is working.

Removing and cleaning the dispenser drawer and compartments

Note: You should clean the dispenser drawer regularly.

- 1 Pull the dispenser drawer out until it reaches its stop.
- 2 Press the drawer release latch down to remove the dispenser drawer.
- 3 Clean and dry the dispenser drawer, syphons, grate and fabric conditioner exit channel. Regularly clean the outlet pipe area.

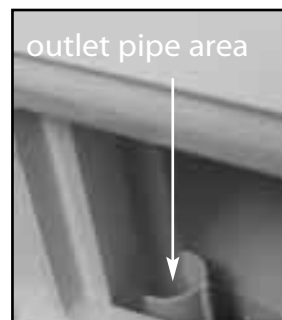
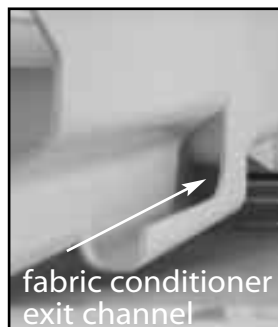

- 4 Replace the dispenser drawer in position and push it firmly back into place.



Cleaning the outside

Use a damp cloth to clean the outside surfaces of the machine.

Cleaning the door bowl

Clean the inside surface of the door bowl regularly with a soft cloth.



Harsh abrasive cleaners should not be used as they can scratch the surface. A build-up of soiling and water hardness residue may result in water leaking from the door.

Maintenance wash

Using too little detergent can cause a build up of grease, dirt and hard water salts, which, over time may damage your machine, your clothes and could cause the machine to smell. We recommend you carry out a maintenance wash two or three times a year to keep the machine and the outlet pipes clean and free from a build up of these deposits. Simply run programme 'C' without laundry, using the usual amount of biological detergent for normal soiling.

NOTE: This will take approximately 2 hours 30 minutes to complete.

Troubleshooting...

In the unlikely event that you have problems with your machine, the following guide may help you to get your machine working correctly straight away...

The machine will not start...

- Close the door. Check that the machine has power. Choose a programme and press the **'START/Hold To Reset'** button. If after two seconds the **'Door Locked'** indicator light is not lit, check to see:
 - i) If the machine is plugged in and switched 'ON'.
 - ii) If the socket is OK. Try another appliance in the socket to check.
 - iii) If the fuse in the machine plug is OK. If not, replace it, see 'Connect your machine to the electrical supply' (see section: INSTALLING YOUR MACHINE).

The 'Door Locked' indicator light is flashing...

- Shut the door firmly, until it clicks. The **'Door Locked'** indicator light should now stay on.

The 'Active' and 'Prog End' indicator lights are both flashing...

- This means that the machine cannot fill. Check that the water supply is turned on and that the inlet hoses are not kinked.

The 'Active' indicator light is flashing...

- The wash dial has been moved since the programme started. Move the wash dial to the original programme.

The machine is leaking...

- Check the fill hoses have been tightened at both ends? If not, tighten them.
- Are the fill hoses tightly fitted yet still leaking? If so, replace the rubber washers.
- Is the standpipe or household drain blocked? You will need to call a plumber if you cannot clear the blockage.

The door will not open...

- Has the programme finished? Is the **'Prog End'** indicator light lit? The door will not open until the **'Door Locked'** indicator light has gone out. The **'Door Locked'** indicator light will go out about two minutes after the programme has finished.
- There is still water in the machine. Go through all the points in the next section, 'The machine will not pump out water...'

The machine will not pump out the water...

- Make sure that there is no blockage in the drain hose and that it is not kinked.
- Is the drain hose installed correctly?
- If you have connected your machine to a sink waste system, make sure that you have cut out the membrane from the under sink drainage system. (see section: INSTALLING YOUR MACHINE).
- Ensure that the drainage system, standpipe or under sink connection is free from any blockage.
 - If any of the above are found to be the cause of your problem you will need to run the machine through a spin only programme.
- If you have chosen **'Rinse Hold'**, the light will flash until you press the **'Rinse Hold'** button to continue the programme.

The programme takes a long time...

- Some programmes do take a long time. Things which can lengthen the programme time include low temperature and low pressure of the incoming hot water supply, or low cold water pressure.

continued...

Troubleshooting...

The machine makes a noise or vibrates during a spin programme...

If the noise is very loud you should check whether:

- i) You have removed the transit bolts.
- ii) You have removed the polystyrene block.
- iii) You have correctly adjusted the feet to stabilize the machine.
- iv) You have removed loose items such as coins from pockets, as these can rattle about inside the machine drum and cause damage.

The laundry has not spun dry...

- This means that the machine did not spin due to the load being unbalanced during the spin.
See 'Automatic Features' in the PROGRAMMES & OPTIONS section.
- Did you use a short spin programme on a non-synthetic load? If so, try again using a faster spin programme.

The dispenser drawer will not close properly...

- Please check that the drawer is properly aligned.
- Is the drawer clogged with detergent? (see section: CLEANING & MAINTENANCE).

Steam is coming from the dispenser drawer...

- We have designed the machine to release steam from the dispenser drawer during hot washes, so don't worry.

Suds are coming from the dispenser drawer...

- Have you used the correct low suds automatic detergent? See 'The Dispenser' - Choose a suitable detergent.
- If you have used the wrong type of detergent, flush out your machine by choosing a rinse programme.

Not all of the detergent has been flushed away...

- Check that your water supply taps are turned on fully.
- Check the inlet hoses are not kinked.
- Is your hot water pressure low? If so you may need a cold fill adaptor to run your machine as cold fill only.
- Ensure the detergent flap is in its 'up' position when dispensing powder and 'down' when dispensing liquid.

Water collects in the detergent dispenser compartment...

- Is the retaining flap in the down position. Lift to allow the water to drain away.

The flap keeps falling down...

- As you push the flap to the up position you will feel some resistance, increase the pressure and the flap will move to its home position.

The clothes are hot at the end of the programme...

- Check that the hoses are fitted correctly: GREY to HOT
BLUE to COLD.

If the machine is still not working contact Hotpoint Service, see the back page.

Remember, you may be charged for a service call if a problem with your machine is caused by incorrect installation or misuse.



Hotpoint guarantee

“Satisfaction guaranteed or your money back”

We give you a unique ‘satisfaction guaranteed’ promise - **valid for 90 days** - after you have purchased your Hotpoint product. If there is a technical problem simply call Hotpoint Repair service or visit our web-site at www.theservicecentre.co.uk and where necessary, we will arrange for an engineer to call. If the technical problem is not resolved under this guarantee, **we will replace your machine or, if you prefer, give you your money back.**

All Hotpoint appliances carry a fully inclusive 12 month parts and labour guarantee as well as free replacement parts for the first 5 years (except microwaves, selected integrated appliances and cooker hoods, which have a one year guarantee) provided that they are fitted by a Hotpoint engineer.

Guarantee terms and conditions

Your guarantee is only applicable in the United Kingdom or Republic of Ireland and is subject to the following provisions that your appliance:

- Has been installed and used correctly in accordance with this instruction booklet.
- Has been used solely for domestic purposes and is located on domestic premises (ie. not for commercial or trade use).
- Has been properly connected to a suitable electrical supply voltage as stated on the appliance rating plate.
- Has not been subject to misuse, accident, modified or repaired by anyone other than one of our own service engineers.



For pre purchase information on any other Hotpoint product call: 08701 50 60 70
or visit: www.hotpoint.co.uk



Recycling & Disposal Information

As part of Hotpoint’s continued commitment to helping the environment, Hotpoint reserves the right to use quality recycled components to keep down customer costs and minimise material wastage.

Please dispose of packaging and old appliances carefully. To minimise risk of injury to children, remove the door, plug and cut mains cable off flush with the appliance. Dispose of these parts separately to ensure that the appliance can no longer be plugged into a mains socket.



After sales service

“No company is better positioned to offer an after sales service on a Hotpoint appliance than us - the manufacturer”

As part of our commitment to you, all Hotpoint appliances have the added benefit of a fully inclusive parts and labour guarantee for the first 12 months. In addition to this you also have the advantage of **free replacement parts for the first 5 years** when fitted by a Hotpoint engineer. When the 12 months parts and labour guarantee expires we offer the following after sales service options:

Repair Service and Information Help Desk

UK: 08709 066066

www.theservicecentre.co.uk

Republic of Ireland: 1850 302 200

Note: Our operators will require the Model number and the Serial number of your machine, see page 2 for the location of these numbers.

Available 364 days a year with a fast, effective and value for money service.

We have the largest white goods repair service in the UK with over 1200 of our own fully trained engineers. All repairs include a parts and labour guarantee for 12 months from the date of the repair.

If you require any information or have any questions about your appliance, our operators are on hand with help and advice.

All this ensures that you will receive the best available after sales service possible.

Extended Warranties

UK: 08709 088 088

www.theservicecentre.co.uk

Republic of Ireland: 1850 502 200

Whether you have just one or a number of Hotpoint appliances in your kitchen, we offer two service cover plans to give you total peace of mind.

- Repair Protection Plan - FREE service repairs for a single Hotpoint appliance during the period of cover.
- Kitchen Cover - FREE service repairs for all your Hotpoint appliances less than 8 years old.

Genuine Parts and Accessories

UK: 08709 077 077

www.theservicecentre.co.uk

Republic of Ireland: (01) 842 6836

A wide range of genuine parts and accessories are available from our hotline or through our web site.

Genuine parts and accessories, extended warranties and service repairs are all available on our web-site at:



SERVICE &
GUARANTEE



Key contacts After Sales Service

Over 1200 trained specialists, directly employed by us, ensure that you can have complete confidence in both the appliances and services we offer.



Repair Service and Information Help Desk

UK: 08709 066 066

(Open 8 to 8 Mon - Fri, 8 to 6 Sat, 10 to 4 Sun & Bank Holidays)

www.theservicecentre.co.uk

Republic of Ireland: 1850 302 200

Note: Our operators will require the following information:

Model number

Serial number

Extended Warranties

UK: 08709 088 088

(Open 8 to 8 Mon - Sun)

www.theservicecentre.co.uk

Republic of Ireland: 1850 502 200

Genuine Parts and Accessories

UK: 08709 077 077

(Open 8-30 to 5-30 Mon - Fri & 9 to 12 Sat)

www.theservicecentre.co.uk

Republic of Ireland: (01) 842 6836

Free Manuals Download Website

<http://myh66.com>

<http://usermanuals.us>

<http://www.somanuals.com>

<http://www.4manuals.cc>

<http://www.manual-lib.com>

<http://www.404manual.com>

<http://www.luxmanual.com>

<http://aubethermostatmanual.com>

Golf course search by state

<http://golfingnear.com>

Email search by domain

<http://emailbydomain.com>

Auto manuals search

<http://auto.somanuals.com>

TV manuals search

<http://tv.somanuals.com>