

HP 3852A Data Acquisition/Control Unit

**HP 44715A
5-Channel Counter Accessory**

Configuration and Programming Manual



©Copyright Hewlett-Packard Company 1987

Manual Part Number: 44715-90001
Microfiche Part Number: 44715-99001

Printed: MARCH 1987 Edition 1
Printed in U.S.A. E0387

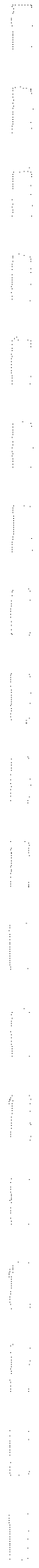

Printing History

New editions are complete revisions of the manual. Update packages, which are issued between editions, contain additional and replacement pages to be merged into the manual by the customer. The dates on the title page change only when a new edition or a new update is published. No information is incorporated into a reprinting unless it appears as a prior update; the edition does not change when an update is incorporated.

Many product updates and fixes do not require manual changes and, conversely, manual corrections may be done without accompanying product changes. Therefore, do not expect a one-to-one correspondence between product updates and manual updates.

Edition 1.....MARCH 1987

RESTRICTED RIGHTS LEGEND

Use, duplication, or disclosure by the Government is subject to restrictions as set forth in subdivision (b)(3)(ii) of the Rights in Technical Data and Computer Software clause at 52.227-7013.

Hewlett-Packard Company
3000 Hanover Street, Palo Alto, California 94304

Downloaded from www.somanuals.com



**HEWLETT
PACKARD**

Herstellerbescheinigung

Hiermit wird bescheinigt, daß das Gerät/System HP 3852A
in Übereinstimmung mit den Bestimmungen von Postverfügung 1046/84 funkentstört ist.

Der Deutschen Bundespost wurde das Inverkehrbringen dieses Gerätes/Systems angezeigt und die Berechtigung zur Überprüfung der Serie auf Einhaltung der Bestimmungen eingeräumt.

Zusatzinformation für Meß- und Testgeräte

Werden Meß- und Testgeräte mit ungeschirmten Kabeln und/oder in offenen Meßaufbauten verwendet, so ist vom Betreiber sicherzustellen, daß die Funk-Entstörbestimmungen unter Betriebsbedingungen an seiner Grundstücksgrenze eingehalten werden.

Manufacturer's declaration

This is to certify that the equipment HP 3852A
is in accordance with the Radio Interference Requirements of Directive FTZ 1046/84. The German Bundespost was notified that this equipment was put into circulation, the right to check the series for compliance with the requirements was granted.

Additional Information for Test- and Measurement Equipment

If Test- and Measurement Equipment is operated with unscreened cables and/or used for measurements on open set-ups, the user has to assure that under operating conditions the Radio Interference Limits are still met at the border of his premises.

NOTICE

The information contained in this document is subject to change without notice.

HEWLETT-PACKARD MAKES NO WARRANTY OF ANY KIND WITH REGARD TO THIS MATERIAL, INCLUDING, BUT NOT LIMITED TO, THE IMPLIED WARRANTIES OF MERCHANTABILITY AND FITNESS FOR A PARTICULAR PURPOSE. Hewlett-Packard shall not be liable for errors contained herein or for incidental or consequential damages in connection with the furnishing, performance or use of this material.

Hewlett-Packard assumes no responsibility for the use or reliability of its software on equipment that is not furnished by Hewlett-Packard.

This document contains proprietary information which is protected by copyright. All rights are reserved. No part of this document may be photocopied, reproduced or translated to another language without the prior written consent of Hewlett-Packard Company.

Copyright © 1985 by HEWLETT-PACKARD COMPANY



CERTIFICATION

Hewlett-Packard Company certifies that this product met its published specifications at the time of shipment from the factory. Hewlett-Packard further certifies that its calibration measurements are traceable to the United States National Bureau of Standards, to the extent allowed by the Bureau's calibration facility, and to the calibration facilities of other International Standards Organization members.

WARRANTY

This Hewlett-Packard instrument product is warranted against defects in materials and workmanship for a period of one year from date of shipment. During the warranty period, Hewlett-Packard Company will, at its option, either repair or replace products which prove to be defective.

For warranty service or repair, this product must be returned to a service facility designated by -hp-. Buyer shall prepay shipping charges to -hp- and -hp- shall pay shipping charges to return the product to Buyer. However, Buyer shall pay all shipping charges, duties, and taxes for products returned to -hp- from another country.

Duration and conditions of warranty for this instrument may be superseded when the instrument is integrated into (becomes a part of) other -hp- instrument products.

Hewlett-Packard warrants that its software and firmware designated by -hp- for use with an instrument will execute its programming instructions when properly installed on that instrument. Hewlett-Packard does not warrant that the operation of the instrument, or software, or firmware will be uninterrupted or error free.

LIMITATION OF WARRANTY

The foregoing warranty shall not apply to defects resulting from improper or inadequate maintenance by Buyer, Buyer-supplied software or interfacing, unauthorized modification or misuse, operation outside of the environmental specifications for the product, or improper site preparation or maintenance.

NO OTHER WARRANTY IS EXPRESSED OR IMPLIED. HEWLETT-PACKARD SPECIFICALLY DISCLAIMS THE IMPLIED WARRANTIES OF MERCHANTABILITY AND FITNESS FOR A PARTICULAR PURPOSE.

EXCLUSIVE REMEDIES

THE REMEDIES PROVIDED HEREIN ARE BUYER'S SOLE AND EXCLUSIVE REMEDIES. HEWLETT-PACKARD SHALL NOT BE LIABLE FOR ANY DIRECT, INDIRECT, SPECIAL, INCIDENTAL, OR CONSEQUENTIAL DAMAGES, WHETHER BASED ON CONTRACT, TORT, OR ANY OTHER LEGAL THEORY.

ASSISTANCE

Product maintenance agreements and other customer assistance agreements are available for Hewlett-Packard products.

For any assistance, contact your nearest Hewlett-Packard Sales and Service Office. Addresses are provided at the back of this manual.

SAFETY SUMMARY

The following general safety precautions must be observed during all phases of operation, service, and repair of this instrument. Failure to comply with these precautions or with specific warnings elsewhere in this manual violates safety standards of design, manufacture, and intended use of the instrument. Hewlett-Packard Company assumes no liability for the customer's failure to comply with these requirements.

GROUND THE INSTRUMENT

To minimize shock hazard, the instrument chassis and cabinet must be connected to an electrical ground.

DO NOT OPERATE IN AN EXPLOSIVE ATMOSPHERE

Do not operate the instrument in the presence of flammable gases or fumes. Operation of any electrical instrument in such an environment constitutes a definite safety hazard.

KEEP AWAY FROM LIVE CIRCUITS

Operating personnel must not remove instrument covers. Component replacement and internal adjustments must be made by qualified maintenance personnel. Under certain conditions, dangerous voltages may exist even with the instrument switched off. To avoid injuries, always disconnect input voltages and discharge circuits before touching them.

DO NOT SERVICE OR ADJUST ALONE

Do not attempt internal service or adjustment unless another person, capable of rendering first aid and resuscitation, is present.

DO NOT SUBSTITUTE PARTS OR MODIFY INSTRUMENT

Because of the danger of introducing additional hazards, do not install substitute parts or perform any unauthorized modification to the instrument. Return the instrument to a Hewlett-Packard Sales and Service Office for service and repair to ensure that safety features are maintained.



Operating and Safety Symbols

Symbols Used On Products And In Manuals

~ LINE AC line voltage input receptacle.



Instruction manual symbol affixed to product. Warns and cautions the user to refer to respective instruction manual procedures to avoid personal injury or possible damage to the product.



Indicates dangerous voltage – terminals connected to interior voltage exceeding 1000 volts.

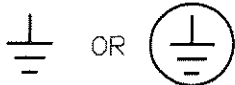

Protective conductor terminal. Indicates the field wiring terminal that must be connected to earth ground before operating equipment – protects against electrical shock in case of fault.



Clean ground (low-noise). Indicates terminal that must be connected to earth ground before operating equipment – for single common connections and protection against electrical shock in case of fault.

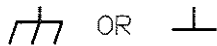

Frame or chassis ground. Indicates equipment chassis ground terminal – normally connects to equipment frame and all metal parts.



Affixed to product containing static sensitive devices – use anti-static handling procedures to prevent electrostatic discharge damage to components.

NOTE

NOTE

Calls attention to a procedure, practice, or condition that requires special attention by the reader.

CAUTION

CAUTION

Calls attention to a procedure, practice, or condition that could possibly cause damage to equipment or permanent loss of data.

WARNING

WARNING

Calls attention to a procedure, practice, or condition that could possibly cause bodily injury or death.

WARNING, CAUTION, and NOTE Symbols

Some labels on the HP 3852A, HP 3853A, and plug-in accessories include an international warning symbol (triangle with subscripted number) which refers the reader to the manuals for further information. This table shows the warning symbols used for the HP 3852A/3853A and plug-in accessories. Refer to the manual set for specific information on WARNINGS, CAUTIONS, or NOTES referenced with a warning symbol.

HP 3852A WARNING, CAUTION, and NOTE Symbols





Symbol	Meaning	Location
	Shock hazard originating outside the instrument (field wiring)	<ul style="list-style-type: none"> . Analog Extender Connector on Power Supply Modules . Terminal modules on plug-in accessories . Component module covers on plug-in accessories
	Treat all channels as "one circuit" for safety purposes.	<ul style="list-style-type: none"> . Inside terminal modules on plug-in accessories . Metal cover on component modules of plug-in accessories
	Maximum number of certain plug-in accessories to be installed into an HP 3852A or HP 3853A.	<ul style="list-style-type: none"> . HP 44701A, HP 44702A/B, HP 44727A/B/C plug-in accessories
	If High-Speed FET multiplexers are used with the HP 44702A/B, ribbon cable may be connected.	<ul style="list-style-type: none"> . HP 44711A, 44712A, 44713A (referenced on HP 44702A and HP 44702B)

TABLE OF CONTENTS

Chapter 1 - INTRODUCTION

Manual Contents.....	1-1
Counter Description.....	1-1
Getting Started.....	1-5

Chapter 2 - SELECTING COUNTER FUNCTIONS

Chapter Contents.....	2-1
Defining Your Measurement.....	2-1
Measurement Parameters.....	2-1
Data/Interrupt Requirements.....	2-3
Counter Functions.....	2-3
Function Overview.....	2-3
Counter Functions Summary.....	2-4
Counting Sequences.....	2-6
Counting Functions.....	2-7
Totalize Counts (TOTAL/TOTALM).....	2-7
Up/Down Counts (UDC/UDCM).....	2-9
Count With Direction Control (CD/CDM).....	2-12
Measurement Functions.....	2-16
Ratio Measurements (RAT).....	2-16
Period Measurements (PER/PERD).....	2-17
Frequency Measurements (FREQ).....	2-20

Chapter 3 - CONFIGURING THE COUNTER

Introduction.....	3-1
Chapter Contents.....	3-1
Warnings, Cautions, and Notes.....	3-1
Getting Started.....	3-3
Setting Counter Jumpers.....	3-4
Setting Card Configuration Jumper.....	3-4
Setting Quadrature Jumpers.....	3-5
Setting Counter Triggering.....	3-6
Trigger Sources.....	3-6
Connecting External Triggering.....	3-7
Configuring Isolated Channels.....	3-8
Setting Signal Level Jumpers.....	3-9
Adding Signal Conditioning Elements.....	3-9
Connecting Field Wiring.....	3-9
Configuring Non Isolated Channels.....	3-10
Setting AC/TTL Jumpers.....	3-13
Adding Signal Conditioning Elements.....	3-13
Connecting Field Wiring.....	3-13
Using Pullup Resistors.....	3-13
Typical Connections.....	3-14
Installation and Checkout.....	3-14

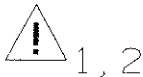

TABLE OF CONTENTS (Cont'd)

Chapter 4 - PROGRAMMING THE COUNTER

Introduction	4-1
Chapter Contents.....	4-1
Command Summary.....	4-1
Selecting Channel Parameters.....	4-3
Selecting Channel Function.....	4-4
Channel Function/Presets (CONF).....	4-4
Channel Function (FUNC).....	4-6
Selecting Channel Input.....	4-6
Input Terminals (TERM).....	4-6
Count/Gate Edges (EDGE).....	4-7
Trigger Source (TRIG).....	4-8
Selecting Counts/Timing.....	4-9
Counter Presets (CNTSET).....	4-10
Number or Period (NPER).....	4-11
Sample Period (SPER).....	4-12
Time Base (TBASE).....	4-12
Selecting Reads.....	4-15
Single Read (CHREAD).....	4-15
Read/Zero Results (CHREADZ).....	4-16
Multiple Reads (XRDGS).....	4-16
Selecting Interrupts.....	4-17
Enabling Interrupts (ENABLE INTR).....	4-17
Disabling Interrupts (DISABLE INTR).....	4-17
Programming Examples.....	4-18
Totalize Counts (TOTAL/TOTALM).....	4-19
Example: Count Switch Closures.....	4-19
Example: Count Switch Closures, Modulo 5.....	4-21
Up/Down Counts (UDC/UDCM).....	4-23
Example: Count Pulse Rates.....	4-23
Example: Count Pulse Rates, Modulo 5.....	4-24
Count With Direction Control (CD/CDM).....	4-25
Example: Determine Shaft Position.....	4-26
Example: Determine Shaft Position Using Quadrature.....	4-27
Ratio Measurements (RAT).....	4-29
Example: Measure Ratio.....	4-29
Period Measurements (PER/PERD).....	4-31
Example: Measure Average Period.....	4-32
Example: Measure Single Period.....	4-33
Frequency Measurements (FREQ).....	4-35
Example: Measure Flow Rate.....	4-35
INDEX	I-1

Chapter 1

Introduction

Contents

Manual Contents.....	1-1
Counter Description.....	1-1
Getting Started.....	1-5

Chapter 1

Introduction

Manual Contents

This manual shows how to configure and program the HP 44715A 5-Channel Counter/Totalizer (200 kHz) (counter). Refer to the HP 3852A Mainframe Configuration and Programming Manual for additional information on the counter. Manual chapters are:

- **Introduction** contains a manual overview, describes the counter, and shows suggested steps to get started.
- **Selecting Counter Functions** gives guidelines to define your measurement and to select the counter function required for the measurement.
- **Configuring the Counter** shows how to configure counter channels and how to install and initially check the accessory.
- **Programming the Counter** shows how to program the counter for counting and measurement functions and how to enable the counter for interrupts.

Counter Description

The HP 44715A 5-Channel Counter/Totalizer (200 kHz) (counter) consists of a counter component module and a terminal module. The counter has five channels which can be programmed for one of several functions. Each channel can be hardware configured to one of four operating modes.

Counter Functions

The counter can be programmed for counting or measurement functions, as shown in Table 1-1. (Quadrature Count also requires that jumper settings be changed on the component module.) The counting functions continuously repeat the count sequence, while the measurement functions perform a one-time measurement.

Inputs to the counter can be single input (A input) or double input (A input and B input). The B input is not used for single input functions. For double input functions, the A input is defined as the primary measurement input and the B input as an auxiliary input (usually a gate).

Some functions are defined as Modulo NPER, where the NPER value is set with the NPER *number* parameter and the range of NPER *number* = 1 to 65535. In Table 1-1, “transitions” refers to input state changes from low to high or high to low, as programmed.

Table 1-1. Counter Functions

Function	Description	Application
Totalize Counts		
Ungated Total Counts	Count number of A input transitions.	Total counts on single input.
Gated Total Counts	Count number of A input transitions, gate with B input.	Total counts on single input gated by second input.
Ungated Total Counts, Modulo NPER	Count number of A input transitions, modulo NPER.	Total counts on single input, modulo NPER.
Gated Total Counts, Modulo NPER	Count number of A input transitions, modulo NPER. Gate with B input.	Total counts on single input gated by second input, count modulo NPER.
Up/Down Counts		
Up/Down Counts	Count up on A input, count down on B input. Result is (A-B) counts.	Count difference between counts of two inputs.
Up/Down Counts, Modulo NPER	Count up on A input, count down on B input. Result is (A-B) counts, modulo NPER.	Count difference between counts of two inputs, Modulo NPER.
Count With Direction Control		
Count/Direction	Count A input up or down. B input controls direction.	Count relative number of up counts and down counts.
Count/Direction, Modulo NPER	Count A input up or down. B input controls direction. Count modulo NPER.	Count relative number of up counts and down counts, modulo NPER.
Quadrature Count	Count up on all A input transitions when B input leads A input. Count down on all A input transitions when A input leads B input.	Quadrature counts.
Quadrature Count, Modulo NPER	Same as Quadrature Count except count modulo NPER.	Quadrature counts, modulo NPER.
Ratio Measurements		
Ratio	Measure average number of A input counts per B input period.	Measure average number of counts per period of second input (A/B).
Period Measurements		
Period	Measure average of NPER periods of A input.	Measure average value of NPER periods of input.
Delayed Period	Measure NPERth gated period of A input, gate with B input.	Measure value of single period of input, delayed by NPER periods.
Frequency Measurements		
Frequency	Measure average frequency of A input.	Measure frequency of single input.

Input Signals

As shown in Figure 1-1, the counter consists of a component module and a terminal module. User signals are input to the terminal module to either Isolated (± 170 V to chassis maximum) or to Non Isolated (± 10 V to chassis maximum) channels. Each Isolated channel has a 5V/12V/24V signal level jumper which can be set as required. User-supplied passive (R, C) signal conditioning elements can also be added to each channel.

Non Isolated channels have AC/TTL jumpers for each channel. Use the AC jumper position to detect zero crossings or use the TTL position for TTL level signals. As required, user-supplied signal conditioning can be added to each Non Isolated channel. For otherwise floating inputs, such as relays or open collector outputs, the PULLUP resistor and SHIELD connections can be used.

The counter can also be used for quadrature measurements in 3 CH or 4 CH configuration when the quadrature jumpers on the component module are set to the Quadrature position.

Operating Modes

The counter must be hardware configured with the Card Configuration jumper on the terminal module to specify which function(s) shown in Table 1-1 can be performed on counter channels.

The Card Configuration jumper sets allowable counter measurement function(s) and defines the channels which can be used for the measurement. The jumper has four positions: TOTAL, FREQ, 4 CH, and 3 CH. See Figure 1-1 for counter functions and channel definitions for each position.

When the jumper is set for TOTAL, only Ungated Total Counts and Gated Total Counts, Modulo NPER can be performed on each channel. When the jumper is set for FREQ, only Frequency Measurements can be performed on each channel. For the 4 CH or 3 CH positions, any function except Frequency Measurements can be performed on any channel.

Triggering

For either Isolated or Non Isolated channels, the counter can be triggered externally with an input to the XTRG terminals. Inputs to the XTRG terminals can be from an external (user) source or from the PACER OUT BNC port. In addition, the counter can be triggered internally from the mainframe or from the counter component module.

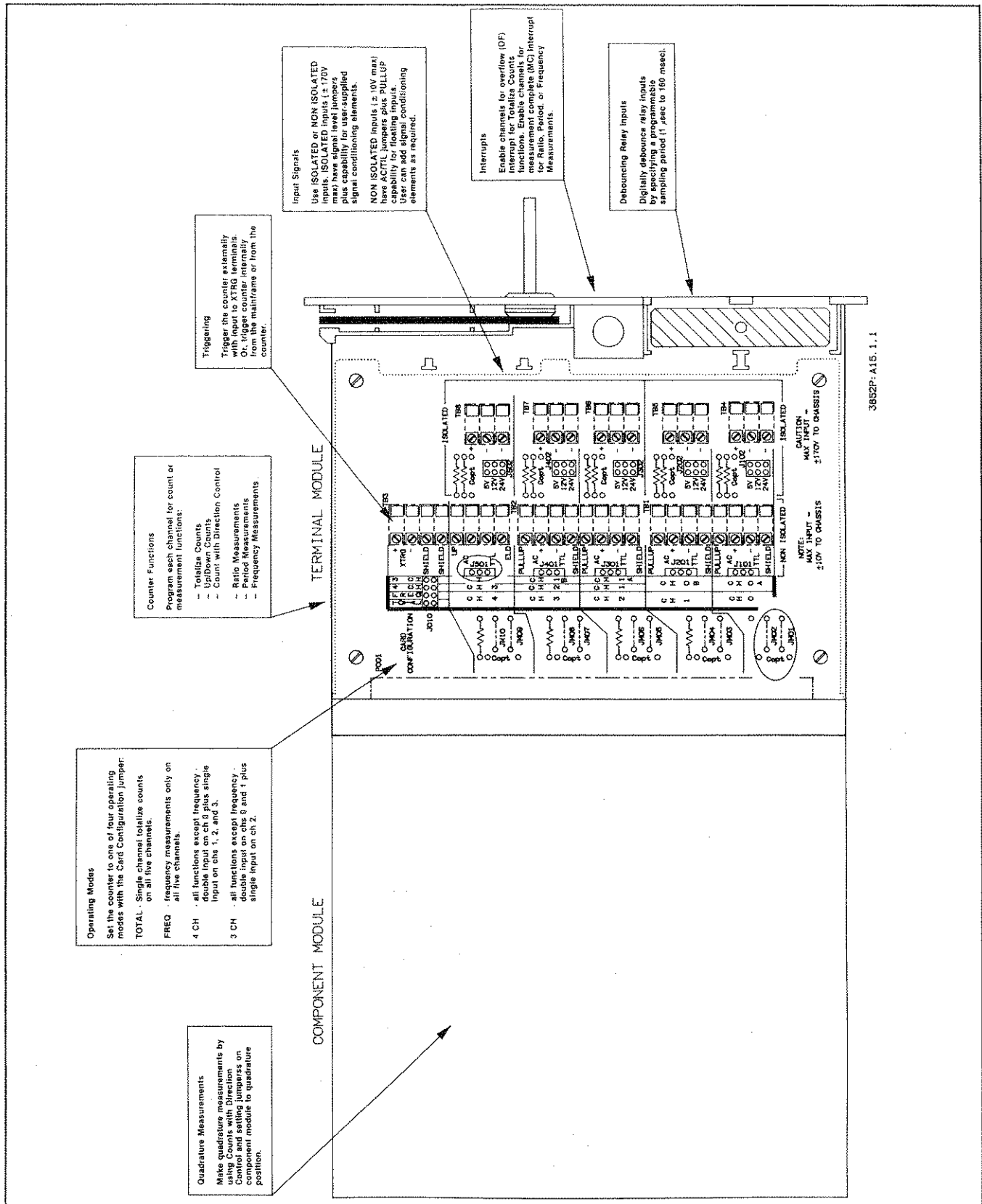

Figure 1-1. Counter Features

Interrupts

Each counter channel can be enabled for measurement complete (MC) or counter overflow (OVF) interrupts, depending on the function set on the channel. When the channel is enabled, Totalize Counts functions generate an OVF interrupt when the channel counter rolls over from -1 to 0.

Also, when the channel is enabled, the Ratio, Period, and Frequency Measurement functions generate a MC interrupt when the measurement is complete. The Up/Down Count and Count With Direction Control functions do not generate interrupts.

Debouncing Relay Inputs

Relay inputs can be digitally debounced by specifying a programmable sampling period from 1 μ sec (default) to 160 msec.

Getting Started

There are three main steps to configure and program the counter for your measurement:

- Define Your Measurement
- Configure the Counter
- Program the Counter

Define Your Measurement

The first step is to define your measurement requirements and to select the counter function required for the measurement. Refer to Chapter 2 - Selecting Counter Functions for guidelines to define your measurement and to select the required counter function.

Configure the Counter

The next step is to hardware configure counter channels for your measurement. Refer to Chapter 3 - Configuring the Counter to hardware configure counter channels. When selecting devices to be connected to the counter, refer to the Specification appendix in the HP 3852A Mainframe Configuration and Programming Manual for details on voltage, current, and frequency limitations.

Program the Counter

When you have configured the channels and selected the channel function(s), the last step is to program each channel for your application. Refer to Chapter 4 - Programming the Counter for guidelines to select channel parameters and some example programs for counter functions.

Chapter 2

Selecting Counter Functions

Contents

Chapter Contents.....	2-1
Defining Your Measurement.....	2-1
Measurement Parameters.....	2-1
Data/Interrupt Requirements.....	2-3
Counter Functions.....	2-3
Function Overview.....	2-3
Counter Functions Summary.....	2-4
Counting Sequences.....	2-6
Counting Functions.....	2-7
Totalize Counts (TOTAL/TOTALM).....	2-7
Up/Down Counts (UDC/UDCM).....	2-9
Count With Direction Control (CD/CDM).....	2-12
Measurement Functions.....	2-16
Ratio Measurements (RAT).....	2-16
Period Measurements (PER/PERD).....	2-17
Frequency Measurements (FREQ).....	2-20

Selecting Counter Functions

Chapter Contents

This chapter gives guidelines to define your measurement and to select counter functions required for the measurement. Chapter sections are:

- **Chapter Contents** summarizes chapter contents.
- **Defining Your Measurement** gives guidelines to characterize your measurement application, including measurement parameters and data/interrupt handling requirements.
- **Counter Functions** includes an overview of counter functions and defines counting and measurement functions.

When you have defined your measurement and selected the counter function, refer to Chapter 3 - Configuring the Counter to hardware configure the counter and then to Chapter 4 - Programming the Counter to program the counter for your measurement.

Defining Your Measurement

Guidelines to help you characterize your measurement follow. The guidelines include a discussion of measurement parameters and data/interrupt requirements. You should also refer to the Specifications appendix in the HP 3852A Mainframe Configuration and Programming Manual for complete specifications when characterizing your measurement.

Measurement Parameters

Guidelines to select these measurement parameters follow.

- Type of Measurement
- Input Signal Frequency
- Input Signal Level
- Measurement Accuracy
- Number of Measurements
- Modulo (Range) Requirements
- Measurement Resolution

Type of Measurement

The first step is to select the type of measurement to be made. Table 1-1 in Chapter 1 summarizes the types of measurements which can be made with the counter.

Input Signal Frequency

The counter can measure inputs up to 200 kHz (minimum period of 5 μ sec). Determine the frequency of the input signal for each channel to be used.

Input Signal Level

Next, determine the input signal level. If the signal level is >10 V, the Isolated input terminals must be used. For lower level signals, the Non Isolated terminals (TTL for TTL inputs or AC for zero crossing detection) can be used.

Measurement Accuracy

In general, measurement accuracy for the counter is ± 1 or 2 counts or $\pm 1/NPER$ counts for all functions except Period, Delayed Period, and Frequency. For these functions, accuracy is $\pm 0.01\%$ of reading ± 1 count of resolution + trigger error where trigger error = maximum time for the input voltage to change from low to high or high to low.

Therefore, for Period, Delayed Period, or Frequency measurements determine the trigger error to ensure that resulting measurement accuracy will be acceptable.

Number of Measurements

The number of measurements required will determine other factors, such as resolution and measurement time. Determine the number of measurements required for your application.

Modulo (Range) Requirements

Normal counter range is from 2^{-31} to $2^{31} - 1$ (32 bits, 2s complement). However, for modulo NPER functions, the counter can be set to count modulo NPER where the range of NPER is from 1 to 65535 counts. Select the count range required for your measurement.

Measurement Resolution

For Period and Delayed Period Measurements, the resolution depends on the time base of the counter and the number of periods required to be measured. For Frequency Measurements, the range and resolution depend on the gate time. Determine required signal resolution for the function(s) selected.

Data/ Interrupt Requirements

When you have defined your measurement parameters, determine the data and interrupt requirements for the measurement. Two considerations are data transfer mode and interrupt handling.

Data Transfer Mode

When data is available, it can be transferred to the mainframe memory or to the output buffer and/or display with a CHREAD or XRDGS command. Select the data transfer mode required for your measurement. Refer to Chapter 6 in the HP 3852A Mainframe Configuration and Programming Manual for details on data transfer methods.

Interrupt Requirements

For the Totalize Counts functions, the counter can be enabled to interrupt on counter rollover (OVF interrupt). For Ratio, Period, or Frequency Measurements, the counter can be enabled to interrupt on measurement complete (MC interrupt). When enabled, interrupts can be handled in the mainframe or in the controller. Select the interrupt mode required for your application. Refer to Chapter 8 in the HP 3852A Mainframe Configuration and Programming Manual for guidelines on handling interrupts.

Counter Functions

When you have characterized your measurement, the next step is to select the counter function required for each channel to be used. This section describes the counter functions and shows counter operation for each function.

Function Overview

This subsection summarizes counter functions and describes the count sequence for the counting functions (Totalize Counts, Up/Down Counts, and Count With Direction Control).

Counter Functions Summary Table 2-1 summarizes counter functions, shows the purpose of the A input and B input, and shows the conditions to generate interrupts on an enabled channel. Since channel functions are programmed with the CONF or FUNC command, the “function” column lists the CONF or FUNC *function* parameter which sets the channel to the function (FUNC does not apply to Frequency Measurements).

As noted, counter functions are defined for single input or double input channels. A single input channel has one user input (the A input), while a double input channel has two user inputs (the A input and the B input). Generally, the A input is the primary input to be measured and the B input is the auxiliary input - usually a gate.

In Table 2-1, an S in the “Ch” column = a single input channel and D = a double input channel. The Period (PER) function is an exception to the rule. Although the Period function is defined for a double input channel, the B “input” comes from the counter and the physical B input is not used.

Several functions count or measure “Modulo NPER”, where NPER refers to the number of counts or periods used and the value is selected with the NPER *function* parameter. Some functions generate interrupts when the channel is enabled. In Table 2-1, OVF = a counter overflow interrupt when the counter rolls over from -1 to 0 and MC = a measurement complete interrupt when the measurement is complete. Refer to the next section “Counting Sequences” for a description of the counter sequences.

Table 2-1. Counter Function Summary

Function	function	Ch	Description	Inputs		Interrupts	
				A	B	Type	When
Totalize Counts							
Ungated Total Counts	TOTAL	S	Count number of A input transitions.	Count	N/A	OVF	Rollover (-1 to 0)
Gated Total Counts	TOTAL	D	Count number of A input transitions, gate with B input.	Count	Gate	OVF	Rollover (-1 to 0)
Ungated Total Counts, Modulo NPER	TOTALM	S	Count number of A input transitions, modulo NPER.	Count	N/A	OVF	Rollover (NPER-1 to 0)
Gated Total Counts, Modulo NPER	TOTALM	D	Count number of A input transitions, modulo NPER. Gate with B input.	Count	Gate	OVF	Rollover (NPER-1 to 0)
Up/Down Counts							
Up/Down Counts	UDC	D	Count up on A input, count down on B input. Result is (A-B) counts.	Up Count	Down Count	---	None
Up/Down Counts, Mod NPER	UDCM	D	Count up on A input, count down on B input. Result is (A-B) counts, modulo NPER.	Up Count	Down Count	---	None
Count With Direction Control							
Count/Direction	CD	D	Count A input up or down. B input controls direction.	Count	Dir	---	None
Count/Direction, Mod NPER	CDM	D	Count A input up or down. B input controls direction. Count modulo NPER.	Count	Dir	---	None
Quadrature Count	CD	D	Count up on all A input transitions when B leads A. Count down on all A input transitions when A leads B.	Count	Dir	---	None
Quadrature Count, Modulo NPER	CDM	D	Same as Quadrature Count, except count modulo NPER.	Count	Dir	---	None
Ratio Measurements							
Ratio	RAT	D	Measure average number of A input counts per B input period.	Count	Count	MC	After NPER B Periods
Period Measurements							
Period	PER	D	Measure average of NPER periods of A input	Count	Not Used	MC	After NPERth Period of A
Delayed Period	PERD	D	Measure NPERth gated period of A input, gate with B input.	Count	Gate	MC	After NPERth Gated Period of A
Frequency Measurements							
Frequency	FREQ**	S	Measure average frequency of A input.	Count	N/A	MC	After Gate Time

Notes:

* = Although B input is not used, function must be programmed on a double input channel.

** = FREQ parameter does not apply to FUNC command.

Counting Sequences

As noted, the counter has two types of functions: counting and measuring. The counting functions (Totalize Counts, Up/Down Counts, and Count With Direction Control) continuously repeat the count sequence, while the measurement functions perform a one-time measurement. Figure 2-1 summarizes the count sequence for the counting functions.

Example: Ungated Total Counts (TOTAL/TOTALM) Count Sequences

For example, with Ungated Total Counts (TOTAL), the counter sequence is from 0 (or from a preset value) to 2147483647 to -2147483648 to -1 and back to 0. When the counter rolls over from -1 to 0, if the channel is enabled the counter generates an overflow (OVF) interrupt.

With Ungated Total Counts, Modulo NPER (TOTALM), the count sequence is from 0 (presets do not apply) to NPER-1, where $NPER = 2$ to 65535 is selected with the NPER command. If the channel is enabled, the channel generates an overflow interrupt when the counter rolls over from NPER-1 to 0.

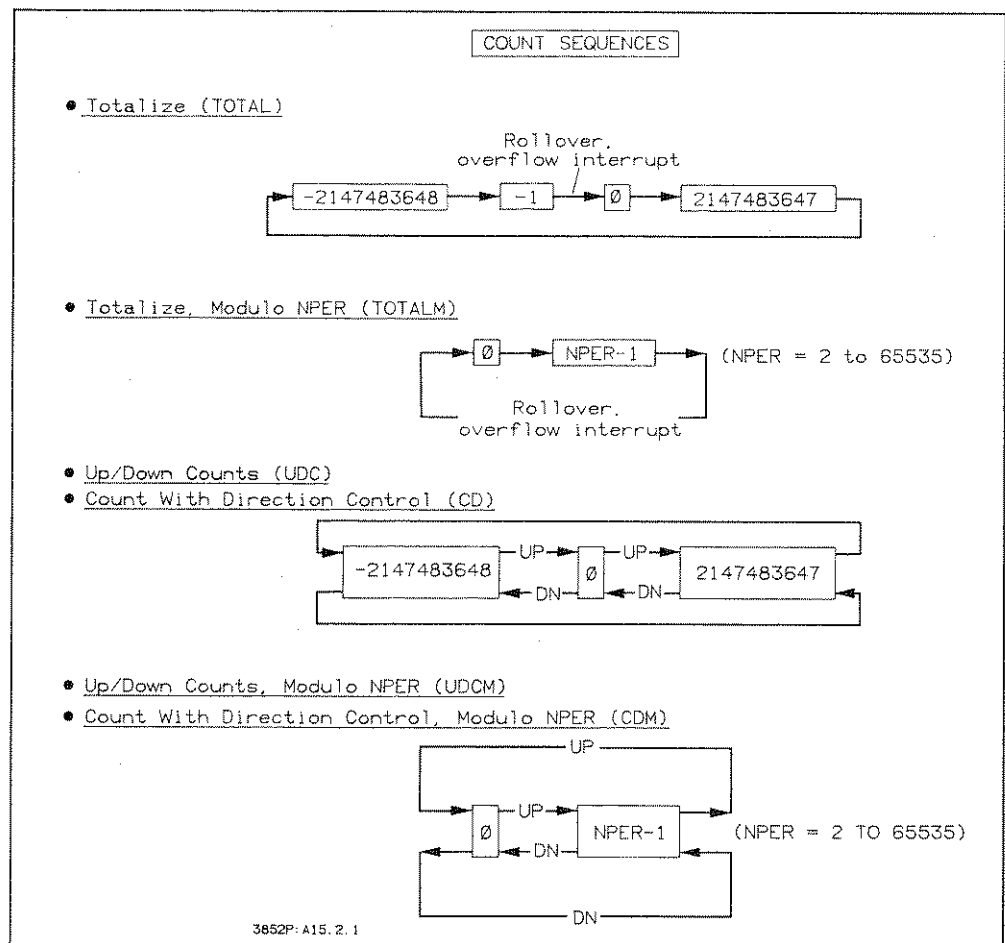

Figure 2-1. Counting Sequences

Counting Functions

This section describes the counting functions shown. For convenience, the *CONF function* parameter which sets the function is listed with each function. Refer to Table 2-1 for a summary of counting functions.

- Totalize Counts (TOTAL/TOTALM)
- Up/Down Counts (UDC/UDCM)
- Count With Direction Control (CD/CDM)

Totalize Counts (TOTAL/TOTALM)

There are four types of Totalize Counts functions:

- Ungated Total Counts (TOTAL)
- Gated Total Counts (TOTAL)
- Ungated Total Counts, Modulo NPER (TOTALM)
- Gated Total Counts, Modulo NPER (TOTALM)

Ungated Total Counts (TOTAL)

Ungated Total Counts (TOTAL) can be used to count and totalize single inputs, such as switch closures and, as desired, generate an overflow interrupt after a specified number of counts. For Ungated Total Counts only, the counter can be preset to any number between -2147483648 and $+2147483647$ with CNTSET. The preset number is used only once and the count then resumes the normal counting sequence. Measurement accuracy is ± 1 count.

For example, with CNTSET 1000000000, the count sequence is from 1000000000 to 2147483647 to -2147483648 and back to 0 (not to the preset). If enabled, the channel generates an overflow interrupt when the counter overflows from -1 to 0. Figure 2-2 shows an example sequence for Ungated Total Counts for LH transitions. Since this is a single input function, the B input is not used.

Gated Total Counts (TOTAL)

Use Gated Total Counts (TOTAL) to totalize an input when a second input (the gate) is high or low, as desired. For example, use this function to totalize switch closures when a second switch is open or closed, as required.

Gated Total Counts is similar to Ungated Total Counts except that the B input gates the A input count. You can set the B input so that A input transitions (LH or HL as programmed) are counted only when the B input is high or low (as programmed). The count sequence, presets, accuracy, and interrupt conditions are the same as for Ungated Total Counts. Figure 2-3 shows an example counter operation to count LH transitions of the A input when the B input is low.

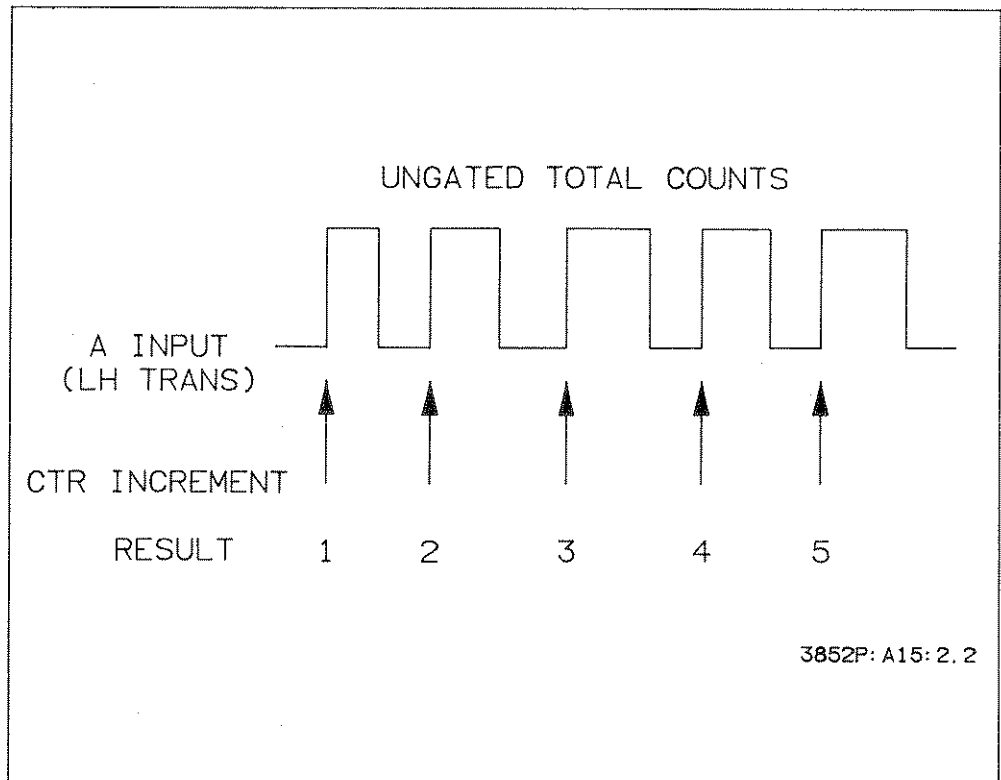

Figure 2-2. Example: Ungated Total Counts (TOTAL)

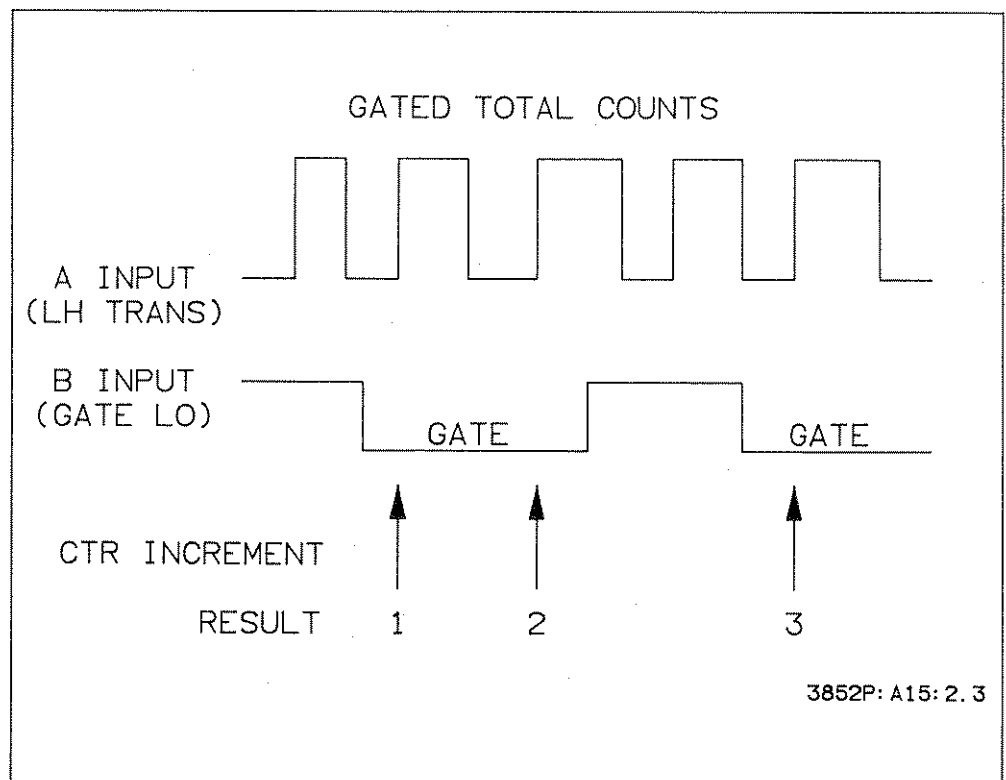

Figure 2-3. Example: Gated Total Counts (TOTAL)

Ungated Total Counts, Modulo NPER (TOTALM)

Use Ungated Total Counts, Modulo NPER (TOTALM) to totalize counts and restart the count after a desired number of counts. With this function, you can set a channel to count up from 0 to a value from 2 to 65534, roll over to 0, and begin counting up again.

For this function, the channel counts the A input LH or HL transitions (as programmed) starting at 0 up to NPER-1 where NPER = 2 to 65535 is set with the NPER command. (There is no preset value other than 0.) Since this is a single input function, the B input is not used. Accuracy is ± 1 count.

The count sequence continuously repeats as long as the channel is programmed for the TOTALM function. Each channel can be enabled for an overflow interrupt when the counter rolls over from NPER-1 to 0. Figure 2-4 shows an example count sequence for A input LH transitions and NPER 4.

Gated Total Counts, Modulo NPER (TOTALM)

Use Gated Total Counts, Modulo NPER (TOTALM) to totalize counts on one input (modulo NPER) as gated by a second input. An example would be to count the number of stepper motor steps when a control switch is open and reset the counter to zero with each complete revolution of the motor.

With this function, the counter counts programmed A input transitions (LH or HL) starting at 0 up to NPER-1 (NPER = 2 to 65535) as gated by the B input. (There is no preset value other than 0.) The count sequence, accuracy, and interrupt conditions are the same as for Ungated Total Counts, Modulo NPER. Figure 2-5 shows an example sequence to count A input LH transitions when the B input is low. For this example, NPER 4 is set.

Up/Down Counts (UDC/UDCM)

Up/Down Counts includes two types of functions:

- Up/Down Counts (UDC)
- Up/Down Counts, Modulo NPER (UDCM)

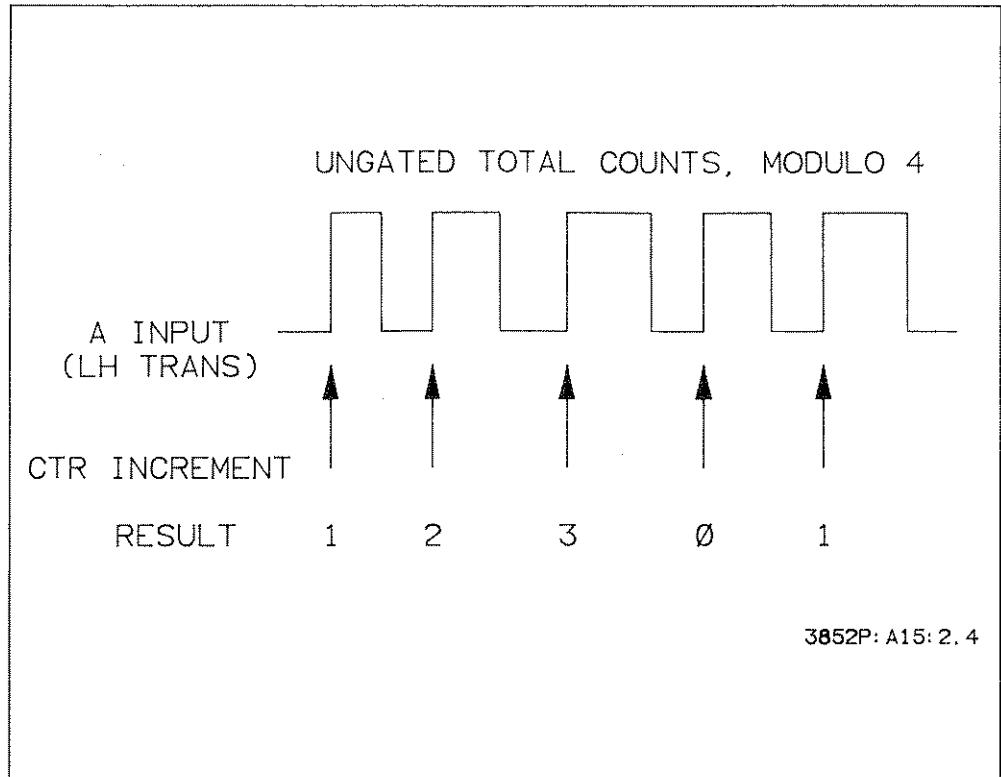

Figure 2-4. Example: Ungated Total Counts, Modulo NPER (TOTALM)

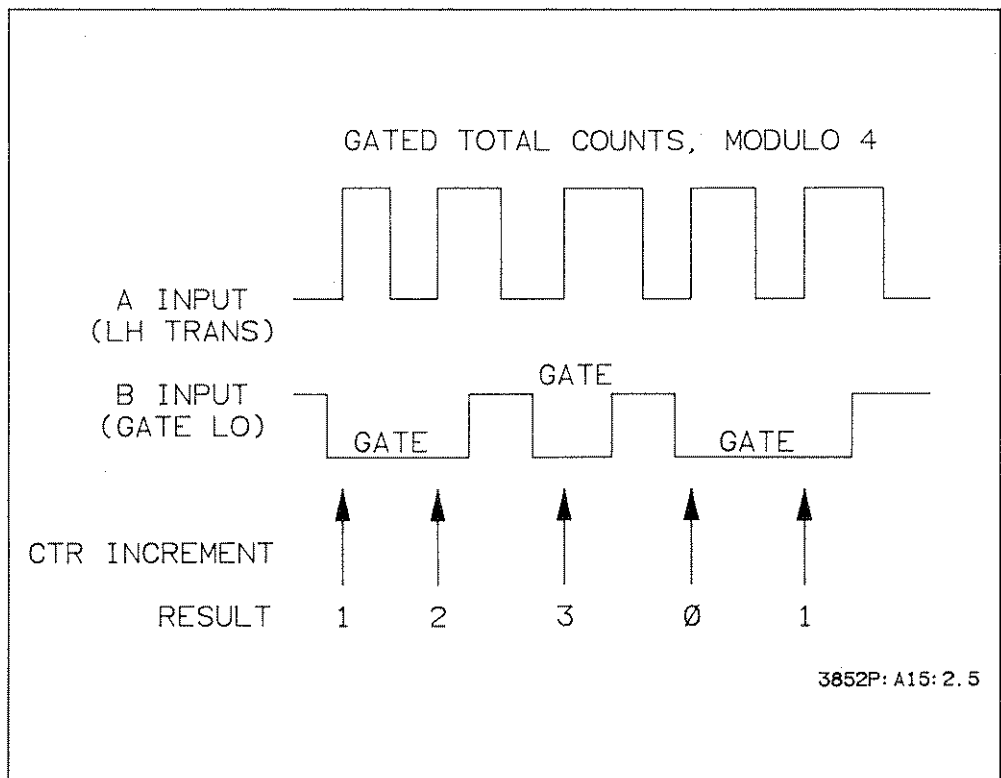

Figure 2-5. Example: Gated Total Counts, Modulo NPER (TOTALM)

Up/Down Counts (UDC)

Use Up/Down Counts (UDC) to measure the difference in counts between two inputs. With this function, programmed A input transitions (LH or HL) increase the count and programmed B input transitions (LH or HL) decrease the count. At any time, the count in the counter is the difference (A-B) between the two input counts. The counter counts up on programmed A input transitions (LH or HL) starting from 0. The counter counts down on programmed B input transitions (LH or HL) starting at 0.

For up counts (A input), the count sequence is from 0 to 2147483647 to -2147483648 and back to 0. For down counts (B input), the count sequence is from 0 to -2147483648 to 2147483647 and back to 0. No interrupts are generated for Up/Down Counts. Measurement accuracy is ± 2 counts. Figure 2-6 shows an example sequence with LH transitions for both the A and B inputs.

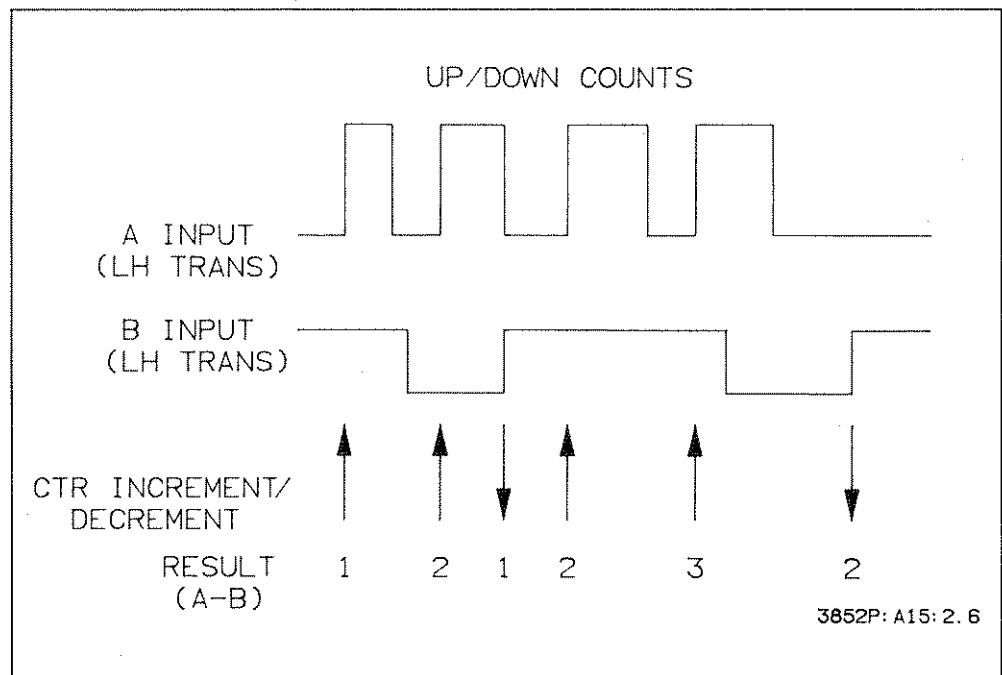

Figure 2-6. Example: Up/Down Counts (UDC)

Up/Down Counts, Modulo NPER (UDCM)

Use Up/Down Counts, Modulo NPER (UDCM) to measure the difference (A-B) between two inputs to a channel, modulo NPER. For this function, the counter counts up on programmed A input transitions (LH or HL) from 0 up to NPER-1, where NPER = 2 to 65535. The counter counts down from NPER-1 to 0 on programmed transitions (LH or HL) of the B input.

No interrupts are generated and measurement accuracy is ± 2 counts. Figure 2-7 shows an example sequence for NPER 3 with LH transitions for the A input and HL transitions for the B input.

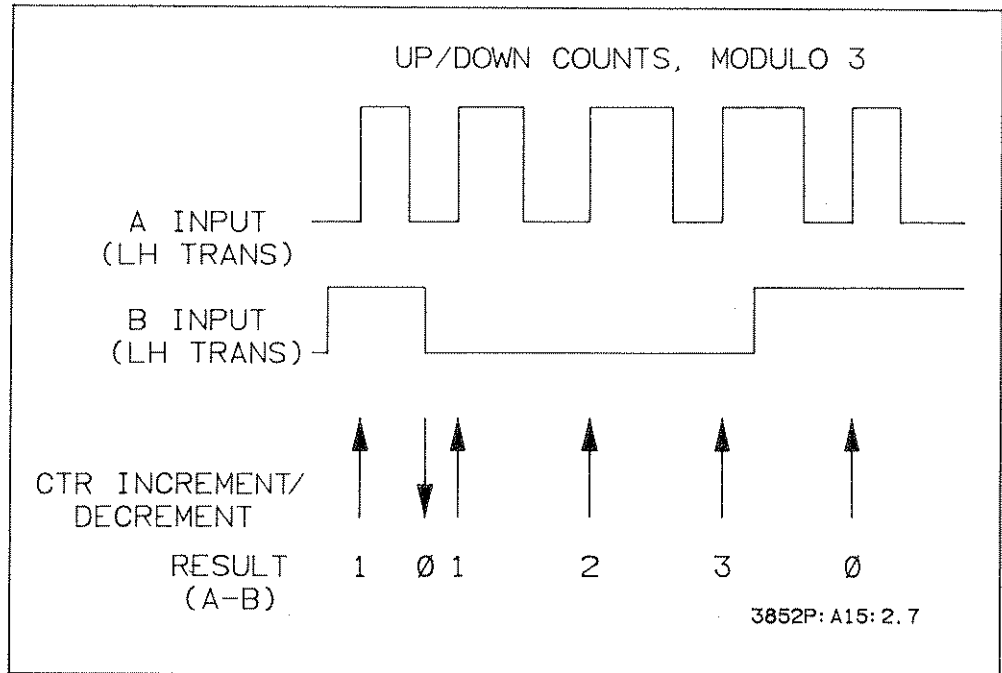

Figure 2-7. Example: Up/Down Counts, Modulo NPER (UDCM)

Count With Direction Control (CD/CDM)

Count With Direction Control includes four functions:

- Count/Direction (CD)
- Count/Direction, Modulo NPER (CDM)
- Quadrature Count (CD)
- Quadrature Count, Modulo NPER (CDM)

Count/Direction (CD)

Use the Count/Direction (CD) function to measure the net number of counts (up counts minus down counts) for an input as controlled by a second input. With this function, the counter counts A input programmed transitions (LH or HL) up or down, depending on the programmed B input gate level (LO or HI).

With the B input gate level set to HI, the counter counts up on programmed A input transitions when the B input is high and counts down when the B input is low. With the B input gate level set to LO, the counter counts up on programmed A input transitions when the B input is low and counts down when the B input is high.

The count sequence for Count/Direction is the same as for the Up/Down Counts (UDC). No interrupts are generated and measurement accuracy is $\pm 1 \text{ count} + \# \text{reversals} / 2$. Figure 2-8 shows an example sequence in which LH transitions of the A input are up counts when the B input is low and down counts when the B input is high (B input gate level is set for LO).

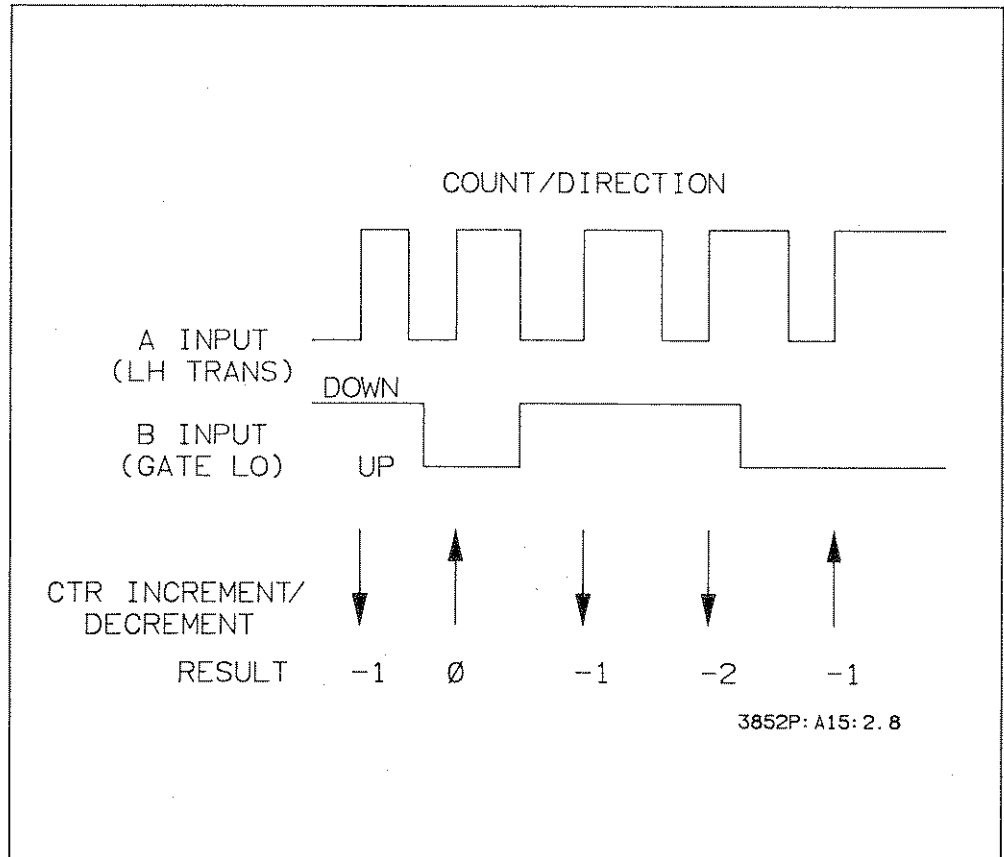

Figure 2-8. Example: Count/Direction (CD)

Count/Direction, Modulo NPER (CDM)

Use Count/Direction, Modulo NPER (CDM) to measure the difference between up counts and down counts, modulo NPER. As with the Count/Direction function, the counter counts programmed A input transitions (LH or HL) up or down, depending on the level of the B input.

The count sequence starts at 0. For up counts, the count sequence is from 0 to NPER-1 and back to 0. For down counts, the count sequence is from 0 to NPER-1 to 0 and back up to NPER-1 (see Figure 2-1). Measurement accuracy is ± 1 count + #reversals/2. Figure 2-9 shows an example sequence with NPER 3 in which LH transitions of the A input are up counts when the B input is high and down counts when the B input is low (B input level is set for HI).

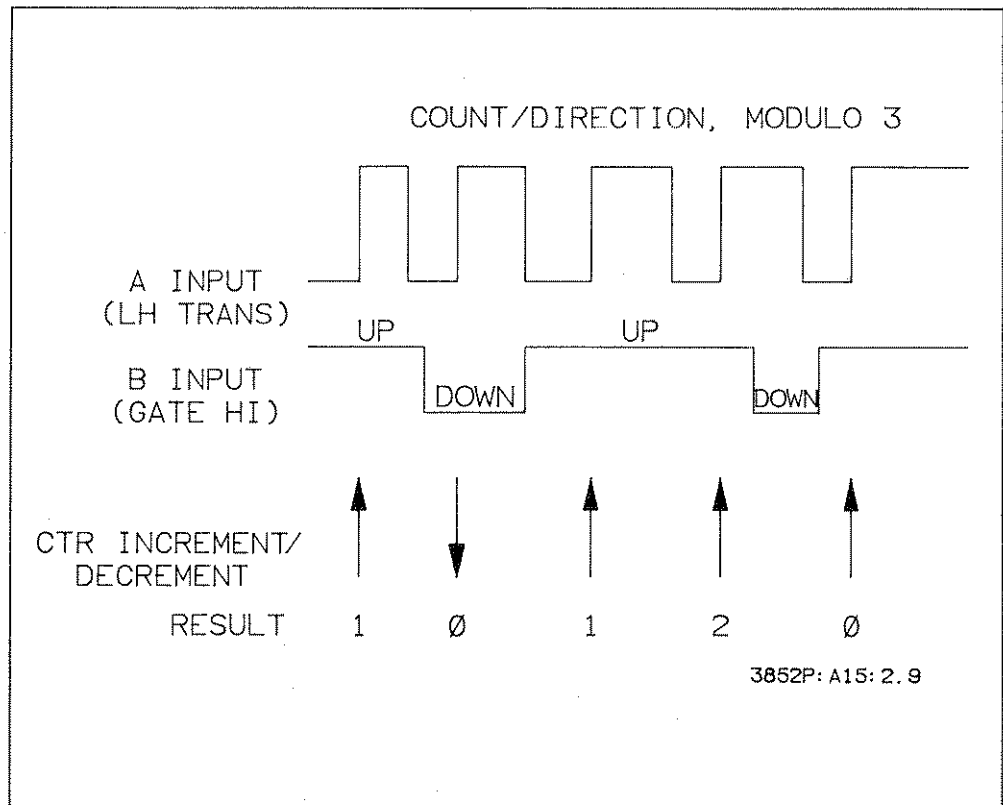

Figure 2-9. Example: Count/Direction, Modulo NPER (CDM)

Quadrature Count (CD)

Quadrature Count (CD) is similar to Count/Direction (CD) except that every transition (LH and HL) of the A input is counted. This function can be used for applications such as measuring the position of a shaft using the A input and determining the direction of motion (CW or CCW) using the B input.

However, a problem can occur if the shaft vibrates just enough to change the A input without changing the B input. If this happens, the count may increment but not decrement (or vice-versa) giving a false count. To overcome this, you can set jumpers on the counter component module so that all transitions of the A input are counted.

Note that Count/Direction (CD) counts programmed A input edges (LH or HL) up or down according to the programmed B input level (LO or HI). However, with Quadrature Count all edges of the A input are counted. The count is ALWAYS up when the B input signal leads the A input signal and ALWAYS down when the A input signal leads the B input signal (two signals 90° out of phase are assumed).

When configured for Quadrature Count, the counter counts double the number of counts for Count/Direction. Table 2-2 summarizes the differences between Count/Direction and Quadrature Count functions.

Table 2-2. Count/Direction vs. Quadrature Count

	Count/Direction	Quadrature Count
Jumpers:	A: "Normal" (pins 2&3) B: "Normal" (pins 2&3)	A: "Quad" (pins 1&2) B: "Quad" (pins 1&2)
Application:	Non direction changing shaft or low accuracy	Direction changing shaft/high accuracy
Error in Count/Dir:	± 1 count plus #reversals/2	± 1 count
Result:	1 count/A input period	2 counts/A input period
EDGE cmd effect:	EDGE sets A input edge to count and sets B input gate level.	EDGE has no effect with Quadrature Count
Other functions	No effect	Will not work

* = Setting the A jumpers to "Quad" and the B jumpers to "Normal" causes the TOTAL, TOTALM, PER, and PERD functions to count double the normal counts and the B input to be ignored and is not recommended.

Figure 2-10 shows an example of Quadrature Count in which the A and B signals are 90° out of phase. When A leads B, each A input edge (LH and HL transitions) is a down count. When B leads A, each A input edge is an up count. The result is twice the number of (up - down) counts which would be returned with the Count/Direction (CD) function.

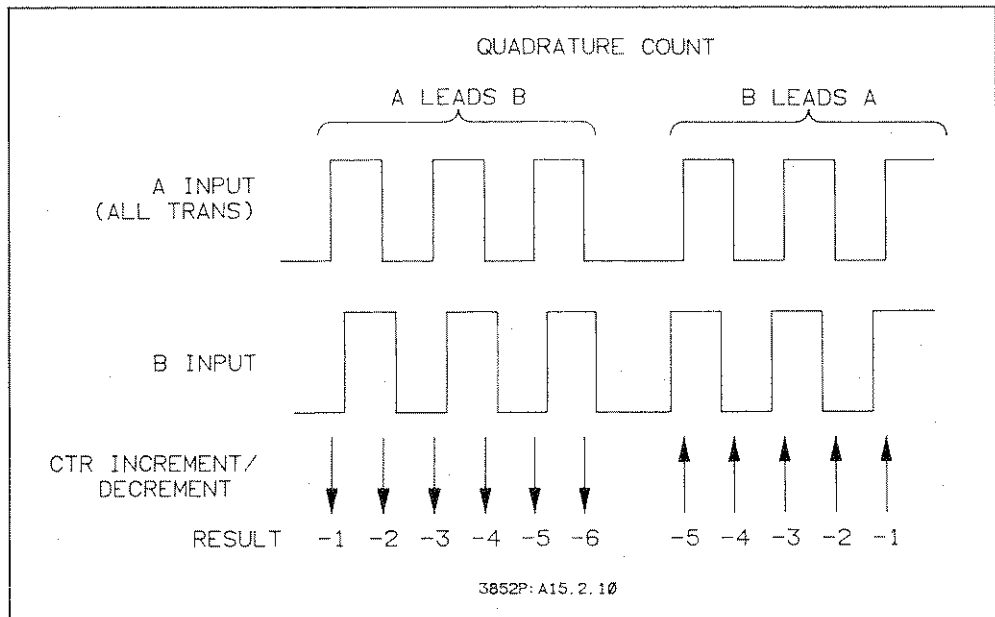

Figure 2-10. Example: Quadrature Count (CD)

Quadrature Count, Modulo NPER (CDM)

Quadrature Count, Modulo NPER (CDM) is similar to Quadrature Count (CD) except that the count sequence is from 0 to NPER-1 (NPER = 2 to 65535) and back to 0 (see Figure 2-1). Figure 2-11 shows an example of Quadrature Count, Modulo NPER with NPER 4.

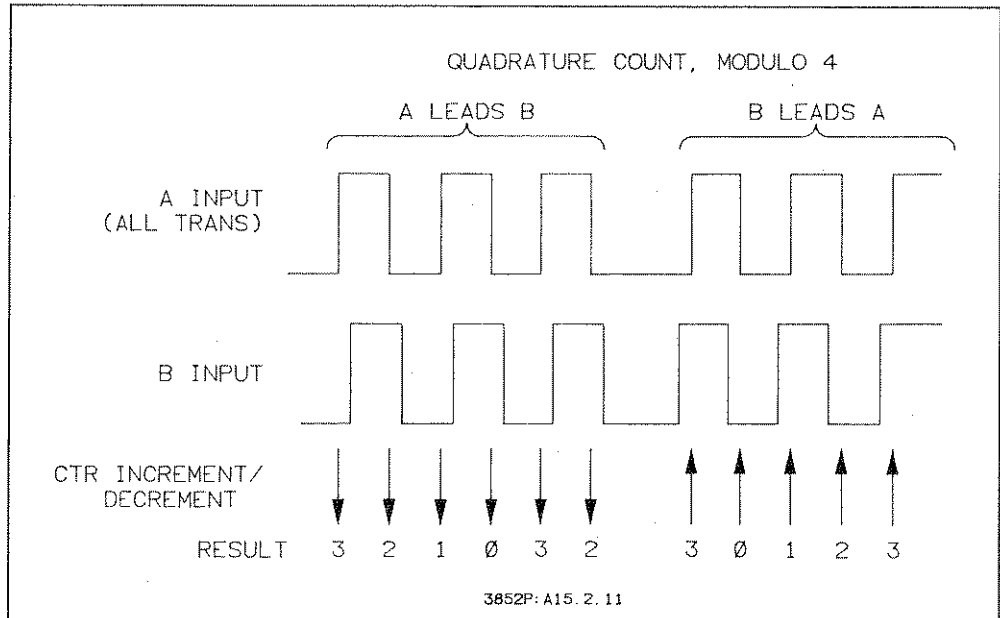

Figure 2-11. Example: Quadrature Count, Modulo NPER (CDM)

Measurement Functions

There are three types of measurement functions, as shown. In contrast to the counting functions in which the count sequence continuously repeats, measurement functions make a one time measurement and halt the sequence. Descriptions of the measurement functions follow. Refer to Table 2-1 for a summary of the measurement functions.

- Ratio Measurements (RAT)
- Period Measurements (PER/PERD)
- Frequency Measurements (FREQ)

Ratio Measurements (RAT)

Use Ratio Measurements (RAT) to count the number of programmed A input transitions (LH or HL) during NPER periods of the B input (NPER = 1 to 65535). The A input count is divided by NPER to get the average number of A input counts per B input period. The maximum number of counts on the A or B inputs is 65535 and measurement accuracy is $\pm 1/\text{NPER}$ counts.

The channel can be enabled to generate a measurement complete interrupt after NPER B periods. Figure 2-12 shows an example ratio measurement in which A input LH transitions are counted during 3 periods of the B input (NPER = 3). For this example, LH transitions also mark the B input period start and stop. The A/B ratio (average number of A input transitions per B period) = 5/3.

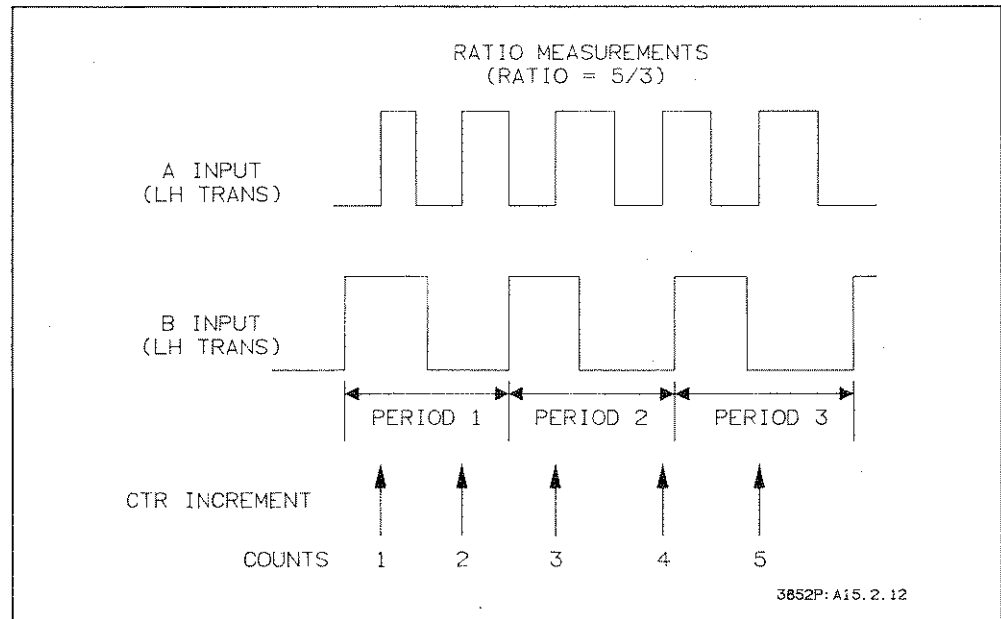

Figure 2-12. Example: Ratio Measurements (RAT)

Period Measurements (PER/PERD) Period Measurements include the Period (PER) and Delayed Period (PERD) Measurements. Period Measurements measures the average of NPER periods of the A input while Delayed Period Measurements measures the NPERth gated period of the A input.

Period Measurements (PER)

With the Period Measurement (PER) function, the counter averages NPER periods of the A input, where NPER = 1 to 65535. This is a double input function even though the B input is not used directly. Minimum period for the A input is 5 μ sec (maximum period is 655.35 seconds).

Data returned is the average value of NPER periods of the A input. If enabled, the channel generates a measurement complete interrupt after NPER periods of the A input have been received. Figure 2-13 shows an example measurement to average three periods of the A input with LH transitions marking the start of each period.

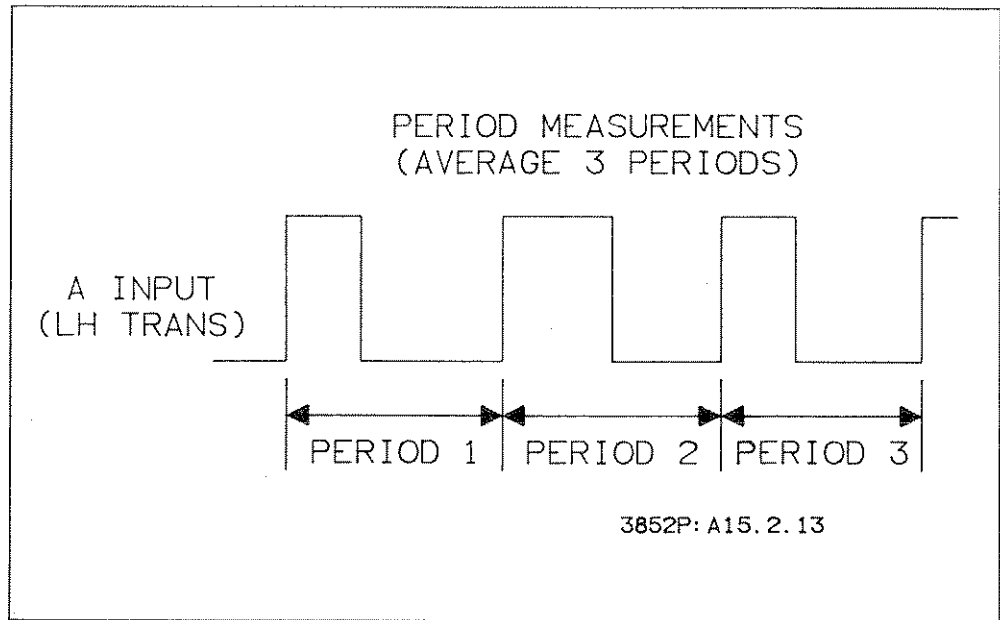

Figure 2-13. Example: Period Measurements (PER)

For this function, the counter uses a reciprocal counter technique. That is, a counter clock is used which has a time base faster than the period to be measured. With this technique, measurement accuracy is $\pm 0.01\%$ to reading ± 1 count of resolution + trigger error where trigger error is the maximum time for the input voltage to change from low to high or high to low.

Measurement resolution can be increased by increasing NPER, as shown in Table 2-3. Refer to Chapter 4 - Programming the Counter for details.

Table 2-3. Period Measurements (PER) Resolution

Time Base	Resolution
1 μsec	1/NPER μsec
10 μsec	10/NPER μsec
100 μsec	100/NPER μsec
1 msec	1/NPER msec
10 msec	10/NPER msec

Delayed Period Measurements (PERD)

Use Delayed Period Measurements (PERD) to measure a single period of the A input as gated by the B input. With this function, the channel measures the NPERth gated period of the A input, where $\text{NPER} = 1$ to 65534. In contrast to the Period Measurement (PER) function, the B input is used as a gate.

The B input gate level can be set for LO or HI. When the gate level is set for HI, A input periods are counted when the B input is high. When the gate level is set for LO, A input periods are counted when the B input is low. If enabled, the channel generates a measurement complete interrupt after the NPERth gated period of the A input has been measured.

For this function (as with Period Measurements (PER)), measurement accuracy is $\pm 0.01\%$ of reading ± 1 count of resolution + trigger error where trigger error is the maximum time for the input voltage to change from low to high or high to low. Table 2-4 shows resolution for the PERD function. For PERD, note that resolution = the Time Base used.

Table 2-4. Delayed Period Measurements (PERD) Resolution

Time Base	Resolution
1 μ sec	1 μ sec
10 μ sec	10 μ sec
100 μ sec	100 μ sec
1 msec	1 msec
10 msec	10 msec

Figure 2-14 shows an example measurement with the B input gate set for HI, A input LH transitions marking the start and end of periods, and NPER = 3. Note that the measurement starts at the beginning of the NPERth period.

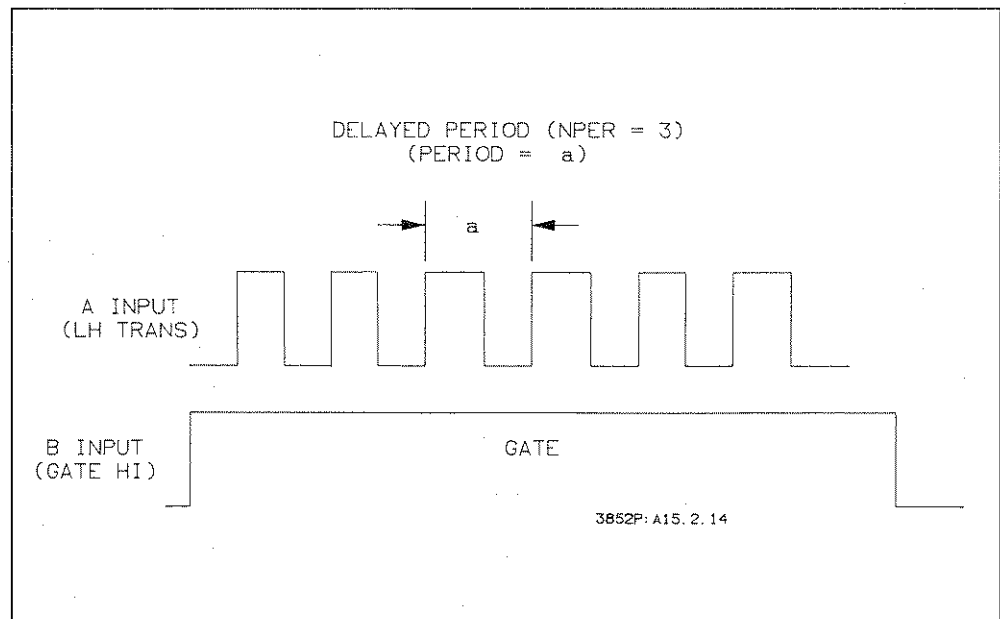

Figure 2-14. Example: Delayed Period Measurements (PERD)

Frequency Measurements (FREQ) Use Frequency Measurements (FREQ) to measure the average frequency of inputs from >1 Hz up to 200 kHz. With this function all five channels simultaneously perform Frequency Measurements only (the Card Configuration jumper must be set to the FREQ position). If enabled, each channel generates a measurement complete interrupt when the frequency measurement is complete.

Frequency is measured by counting the number of programmed A input transitions (LH or HL) over a selected time base (10 msec to 1 sec). The time base is the same for all channels.

NOTE

You can also make Frequency Measurements by setting a channel to Period Measurements (PER) and taking the reciprocal of the period measured. Since the resolution is better for Period Measurements, this method offers a more accurate means to measure frequency than Frequency Measurements.

However, PER measurements require two channels while FREQ uses only a single channel. Also, FREQ takes the measurement for a fixed period of time while PER takes the measurement for a fixed number of periods.

Measurement accuracy for Frequency Measurements is $\pm 0.01\%$ of reading ± 1 count of resolution + trigger error, where trigger error is the maximum time for the input voltage to change from low to high or high to low. Table 2-5 shows ranges and resolution for the three gate times. Refer to Chapter 4 - Programming the Counter for details.

Table 2-5. Frequency Measurements (FREQ) Ranges/Resolution

Gate Time	Range	Resolution
1 sec	1 Hz to 65.535 kHz	1 Hz
100 msec	10 Hz to 200 kHz	10 Hz
10 msec	100 Hz to 200 kHz	100 Hz

Figure 2-15 shows an example measurement with gate time (time base) of 1 sec and LH transitions of the A input used for counting. Since 5 transitions occurred during the 1 sec gate time, average frequency = $5/1 = 5$ Hz.

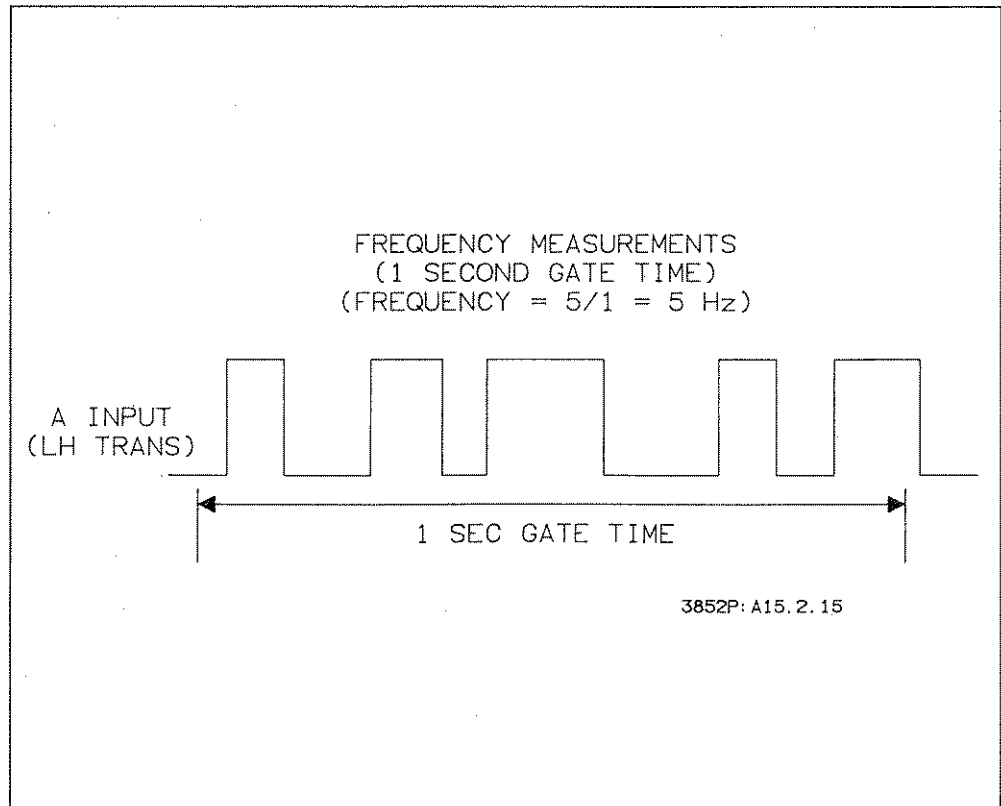



Figure 2-15. Example: Frequency Measurements (FREQ)

F
R
E
E
D
O
M
I
N
F
O
R
M
A
T
I
O
N
A
C
T
S

Chapter 3

Configuring The Counter

Contents

 1, 2	Introduction.....	3-1
	Chapter Contents.....	3-1
	Warnings, Cautions, and Notes.....	3-1
	Getting Started.....	3-3
	Setting Counter Jumpers.....	3-4
	Setting Card Configuration Jumper.....	3-4
	Setting Quadrature Jumpers.....	3-5
	Setting Counter Triggering.....	3-6
	Trigger Sources.....	3-6
	Connecting External Triggering.....	3-7
	Configuring Isolated Channels.....	3-8
	Setting Signal Level Jumpers.....	3-9
	Adding Signal Conditioning Elements.....	3-9
	Connecting Field Wiring.....	3-9
	Configuring Non Isolated Channels.....	3-10
	Setting AC/TTL Jumpers.....	3-13
	Adding Signal Conditioning Elements.....	3-13
	Connecting Field Wiring.....	3-13
	Using Pullup Resistors.....	3-13
	Typical Connections.....	3-14
	Installation and Checkout.....	3-14

Configuring the Counter

Introduction

This chapter shows how to hardware configure counter channels and how to check the counter ID.

Chapter Contents

Chapter sections are:

- **Introduction** summarizes chapter contents, lists WARNINGS, CAUTIONS, and NOTES which apply to the counter, and shows a suggested sequence to configure the counter channels.
- **Setting Counter Jumpers** shows how to set the Card Configuration jumper and the Quadrature jumpers (resetting required only for Quadrature Count).
- **Setting Counter Triggering** summarizes counter triggering sources and shows how to use the XTRG terminals for external trigger inputs.
- **Configuring Isolated Channels** shows how to configure Isolated input channels. It shows how to set the signal level jumpers, install user-supplied signal conditioning elements, and how to connect field wiring.
- **Configuring Non Isolated Channels** shows how to configure Non Isolated input channels. It includes setting AC/TTL jumpers, installing optional user supplied signal conditioning elements, using pullup resistors, and connecting field wiring.

Warnings, Cautions, and Notes

This section summarizes WARNINGS, CAUTIONS, and NOTES which apply to the counter. You should review the WARNINGS and CAUTIONS before handling or configuring any accessory.

WARNING

SHOCK HAZARD. Only qualified, service-trained personnel who are aware of the hazards involved should install, remove, or configure any accessory. Before touching any installed accessory, turn off all power to the mainframe, extenders, and to all external devices connected to the mainframe, extenders, or accessories.

WARNING

POSSIBLE OPERATOR INJURY. For safety, consider all accessory channels to be at the highest potential applied to any channel.

CAUTION

MAXIMUM INPUT VOLTAGE. Maximum input voltage to Isolated channels is ± 170 V between any two terminals or between any terminal and chassis. Maximum input voltage to Non Isolated channels is ± 10 V between any two terminals or between any terminal and chassis.

CAUTION

STATIC SENSITIVE. Use clean-handling techniques when handling the accessory. Do not install an accessory without the metal covers attached.

NOTE

HP-IB ADDRESS. The example programs in this manual use "709" as the HP-IB address for the HP 3852A. Specific slot and channel numbers are also used. Program syntax and data return formats apply to HP Series 200/300 controllers. Modify slot and channel numbers and program syntax as required.

Getting Started

To begin hardware configuration of counter channels, remove the terminal module cover. If the counter is installed in the mainframe or in an extender, refer to the HP 3852A Mainframe Configuration and Programming Manual to remove the terminal module.

There are three steps to configure the counter channel(s) to be used for your measurement:

- Set Counter Jumpers
- Select Counter Trigger Source
- Configure Counter Channels

Figure 3-1 shows the counter terminal module and summarizes steps to configure counter channels. To configure Isolated channels, refer to "Setting Counter Jumpers", then to "Setting Counter Triggering", then to "Configuring Isolated Channels". To configure Non Isolated channels, refer to "Setting Counter Jumpers", then to "Setting Counter Triggering", and then to "Configuring Non Isolated Channels".

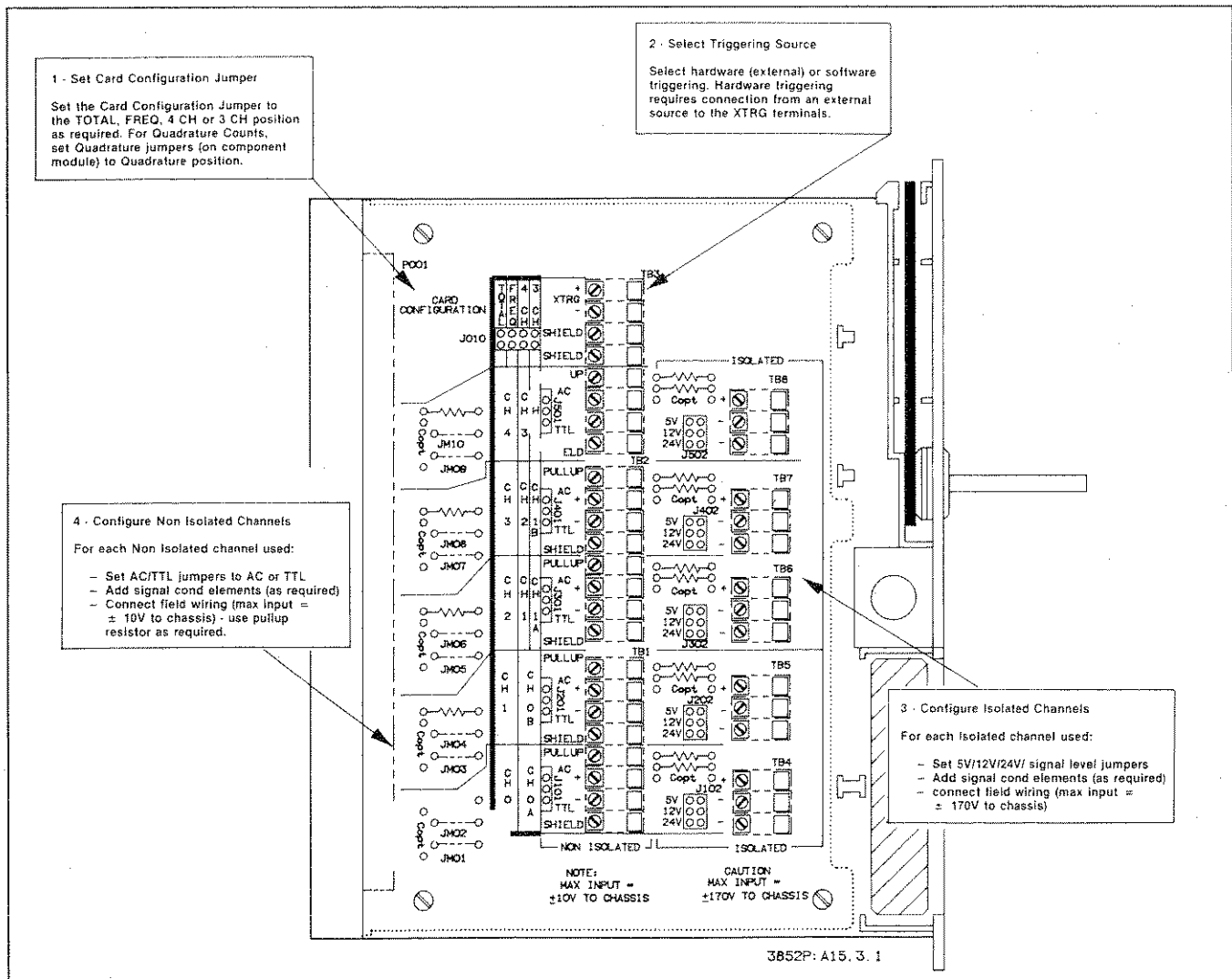

Figure 3-1. Terminal Module Configuration.

Setting Counter Jumpers

When you have selected the counter function(s) required (refer to Chapter 2 - Selecting Counter Functions), the first step to configure the channels is to set the Card Configuration jumper. Also, for Quadrature Count or Modulo NPER, the Quadrature jumpers on the component module must be set to the Quadrature position (refer to "Setting Quadrature Jumpers").

Setting Card Configuration Jumper

Use the Card Configuration jumper (see Figure 3-1) to set each channel of the counter to one of four operating modes: TOTAL, FREQ, 4 CH, or 3 CH. Table 3-1 summarizes the four hardware settings and shows channel numbers and counter functions for each setting.

Channel numbers for each jumper setting are printed on the terminal module in the column under each setting. For example, with the 4 CH setting, the hardware channel numbers are CH0A, CH0B, CH1, CH2, and CH3.

Note that hardware channel numbers are not necessarily the same as the channel numbers used for programming. For example, with the FREQ or TOTAL setting, both hardware and software (programming) channel numbers are 0, 1, 2, 3, and 4. However, for the 4 CH setting, programming channel numbers are 0, 1, 2, and 3, but hardware channel numbers are 0A, 0B, 1, 2, and 3.

NOTE

The input path (Isolated or Non Isolated) is selected with the TERM command. Refer to Chapter 4 - Programming the Counter for a description of the TERM command.

Table 3-1. Card Configuration Jumper Settings

Setting	Description	Channel Numbers	
		Hardware	Programming
TOTAL	Single input Totalize Counts (TOTAL/TOTALM) only.	0,1,2,3,4	0,1,2,3,4
FREQ	Frequency Measurements (FREQ) only.	0,1,2,3,4	0,1,2,3,4
4 CH	All functions except Frequency on ch 0 plus TOTAL/TOTALM functions on chs 1, 2, and 3.	0A,0B,1,2,3	0,1,2,3
3 CH	All functions except Frequency on ch 0 and ch 1 plus TOTAL/TOTALM functions on ch 2.	0A,0B,1A,1B,2	0,1,2

To set counter channels for your measurement, first determine the function to be used for each channel and the type of channel (single input or double input) required. To set all five channels for Frequency Measurements, set the Card Configuration jumper to the FREQ position. To set Ungated Total Counts (TOTAL) or Ungated Total Counts, Modulo NPER (TOTALM) on each channel, set the jumper to the TOTAL position. For other requirements set the jumper to the 4 CH or 3 CH position, as required.

Example: Setting Card Configuration Jumper

You want to make a Ratio Measurement (RAT), an Ungated Total Counts (TOTAL) measurement, and an Up/Down Counts (UDC) measurement on a counter. Since Ratio and Up/Down Counts each require a double input channel while Ungated Total Counts requires a single input channel, set the Card Configuration jumper to the 3 CH position.

Then, typical connections might be to connect the Ratio Measurement input to channels 0A and 0B (or 1A and 1B), connect the Up/Down Counts input to channels 1A and 1B (or 0A and 0B), and connect the Ungated Total Counts input to channel 2.

Setting Quadrature Jumpers

For Quadrature Count (CD or CDM), you will need to change the settings of the Quadrature jumpers on the counter component module and set the Card Configuration jumper to the 3 CH or 4 CH position.

When the Card Configuration jumper is set for 4 CH, only channel 0 (inputs 0A and 0B) can be used for Quadrature Count. For 4 CH configuration, set jumpers J602 and J603 to pins 1 and 2 which configures channel 0 for Quadrature Count.

When the Card Configuration jumper is set for 3 CH, both channels 0 and 1 can be used for Quadrature Count. For 3 CH configuration, set J602 and J603 to pins 1 and 2 to configure channel 0 and set J600 and J601 to pins 1 and 2 to configure channel 1. See Figure 3-2 for quadrature jumper locations and settings.

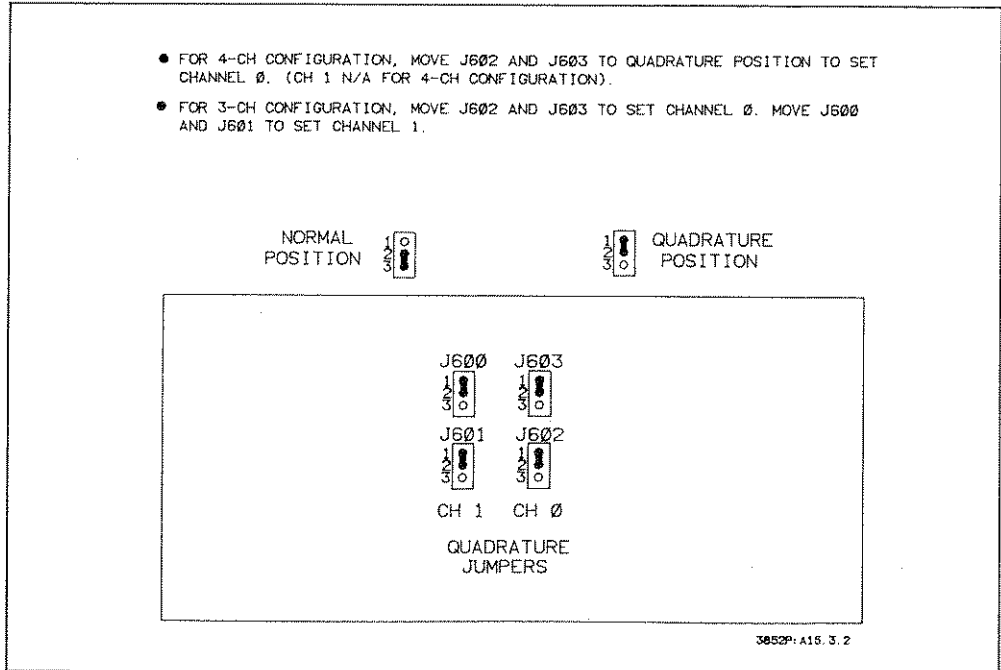

Figure 3-2. Setting Quadrature Jumpers

Setting Counter Triggering

This section shows counter triggering sources and gives guidelines to connect external trigger sources to the XTRG terminals on the terminal module.

Trigger Sources

The counter trigger source or mode is set with the TRIG *source* [USE *ch*] command. Trigger sources are AUTO, EXT, SGL, or SYS plus TRIG HOLD which disables the trigger. Figure 3-3 summarizes the trigger sources. Note that all sources except EXT are software triggers. Refer to Chapter 4 - Programming the Counter for a description of the TRIG command.

If you need to use an external trigger source, refer to the next section “Connecting External Triggering”. If not, go to “Configuring Isolated Channels” or to “Configuring Non Isolated Channels” as required.

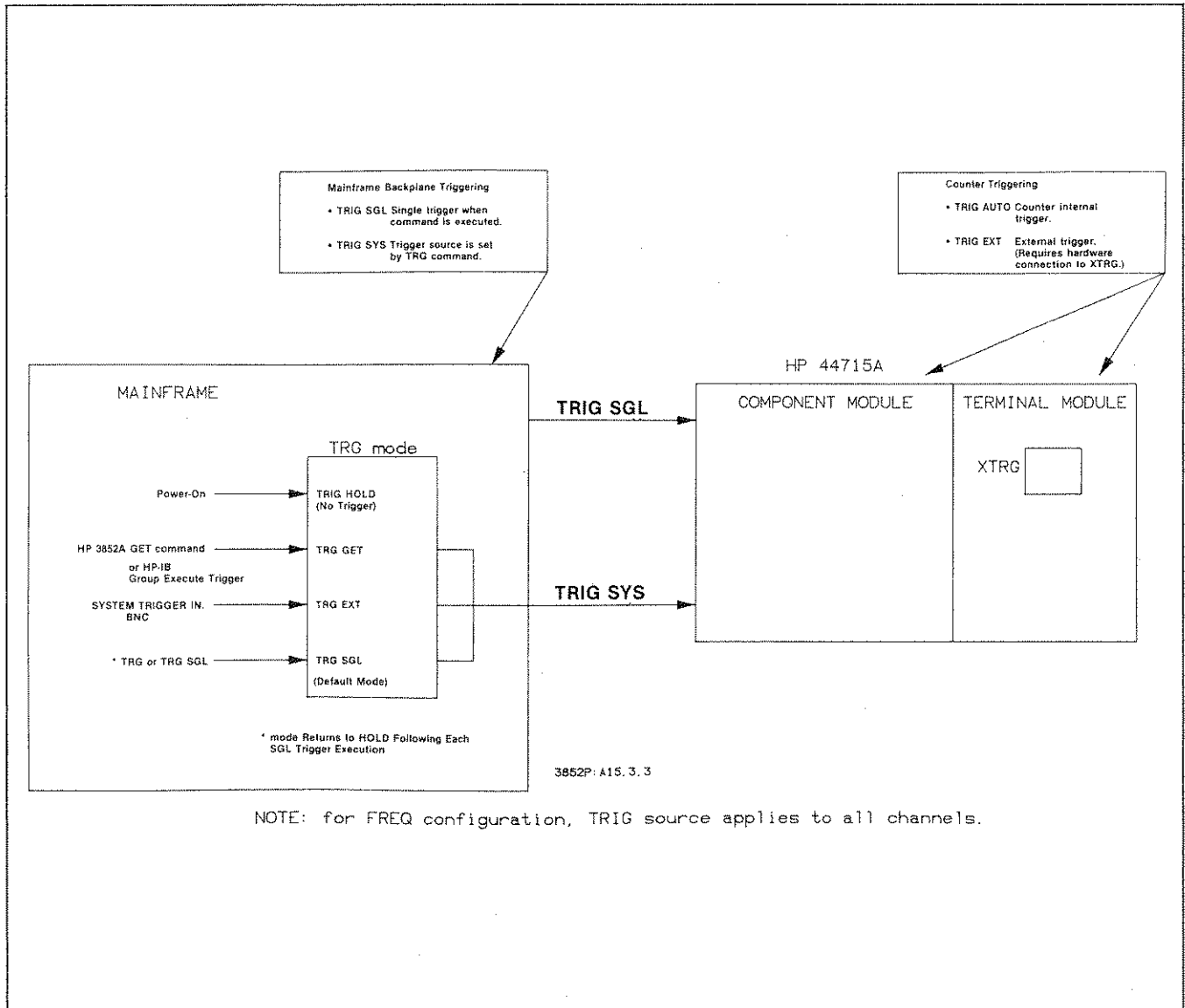

Figure 3-3. Counter Triggering Sources

Connecting External Triggering

To externally trigger the counter, connect a cable from an external (user) triggering source to the XTRG + and - terminals on the terminal module. If the cable has a shield, connect the shield to one of the SHIELD terminals. (The additional SHIELD terminal is provided for redundancy). Both SHIELD terminals are at chassis potential.

You can also provide external triggering by connecting a BNC connector from the PACER OUT BNC terminal on the mainframe to the XTRG +, XTRG -, and SHIELD terminals. Triggering is on the high-to-low transition and inputs must have high >4.0 volts and low <0.9 volts. Refer to the HP 3852A Mainframe Configuration and Programming Manual for details on the PACER OUT BNC terminal.

Configuring Isolated Channels

There are three steps to configure an Isolated input channel, as shown. Figure 3-4 shows the jumper and signal conditioning element locations for Isolated input channels.

- Set signal level jumpers.
- Install signal conditioning (as required).
- Connect field wiring.

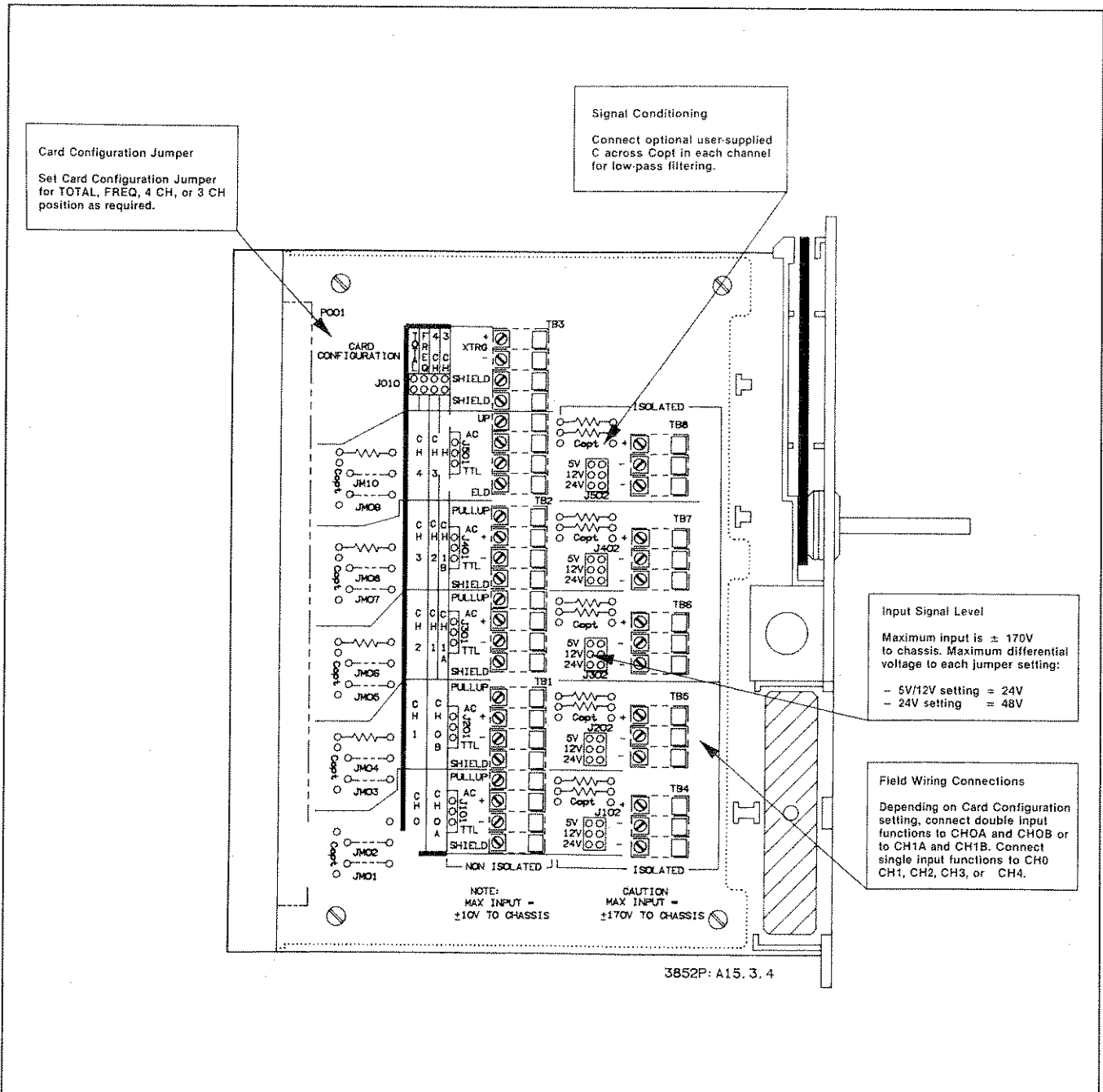

Figure 3-4. Isolated Channel Features

Setting Signal Level Jumpers

As shown in Figure 3-4, each Isolated input channel has a separate jumper which sets the channel input voltage level to 5V, 12V, or 24V, where the level refers to the voltage differential between Vhigh and Vlow. Maximum differential voltage for the 5V and 12V settings is 24 volts, while maximum differential voltage for the 24V setting is 42 volts. Set each jumper for the required input level.

Adding Signal Conditioning Elements

As required, you can install a user supplied capacitor in each Isolated input channel Copt connector to act as a low pass filter (see Figure 3-4 for Copt location).

When a capacitor is placed across Copt, input signal attenuation for the channel is as shown in the following equation, where C = capacitance (in Farads) to be placed across Copt, R (in Ω) depends on the range set by the 5V/12V/24V Signal Level Jumper, and f = frequency of the desired 3 dB point.

$$\text{Attenuation} = \frac{(1100 + R)}{(1100 + R) + 1100 (2\pi f * R * C)}$$

where:

$$R = R_{\text{source}} \quad (5V \text{ range})$$

$$R = R_{\text{source}} + 2700 \Omega \quad (12V \text{ range})$$

$$R = R_{\text{source}} + 6600 \Omega \quad (24V \text{ range})$$

$$C = \text{Copt value (Farads)}$$

$$f = \text{Frequency of 3 dB point}$$

To determine the value of Copt for a specific frequency, let $(1100 + R) = 1100[(2\pi f)(R)(Copt)]$. Then, use the following equation to find Copt for a specified 3 dB point:

$$\text{Copt} = \frac{1100 + R}{6911.5 (R)(f)} \quad (\text{Copt in Farads})$$

As required, determine the capacitance values needed for Copt and install the capacitors in the channels to be used.

Connecting Field Wiring

When the signal level jumpers have been set and signal conditioning elements installed (as required), connect field wiring from your devices to the + and - terminals on TB4, TB5, TB6, TB7, or TB8. When connecting the wiring, route the wires under the strain relief clamp and tighten the clamp screw to reduce the chance of the wires being pulled out of the terminals. (The additional - terminal is for redundancy).

Recall that hardware channel numbering depends on the setting of the Card Configuration jumper. When connecting field wiring, be sure the inputs match the desired channel numbers. For example, inputs connected to TB7 can be CH3, CH2, or CH1B inputs, depending on the Card Configuration jumper setting.

There are two types of functions for the counter: single input and double input. Single input functions require only one input (the A input), while double input functions require two inputs (A input and B input). Ungated Total Counts (TOTAL), Ungated Total Counts, Modulo NPER (TOTALM), and Frequency (FREQ) are the only single input functions. All other functions are double input.

NOTE

The Period Measurements (PER) function is a double input function. However, the B "input" comes from the counter and is NOT a user input. For Period Measurements, the A input must be connected to channel 0A or 1A and the Card Configuration jumper must be set for 4 CH or 3 CH.

Example: Field Wiring - Isolated Channels

Figure 3-5 shows example field wiring connections to Isolated input channels 0 and 1 and the Card Configuration jumper set to 4 CH. For this configuration, a double input function can be connected to channel 0A (TB4) and channel 0B (TB5). Also, a single input function (TOTAL or TOTALM) can be connected to channel 1 (TB6). For all inputs, maximum differential voltage is 24 V.

Configuring Non Isolated Channels

There are three steps to hardware configure Non Isolated input channels, as shown. Figure 3-6 summarizes Non Isolated input channel features and shows jumper locations.

- Set AC/TTL jumpers.
- Install signal conditioning (as required).
- Connect field wiring.

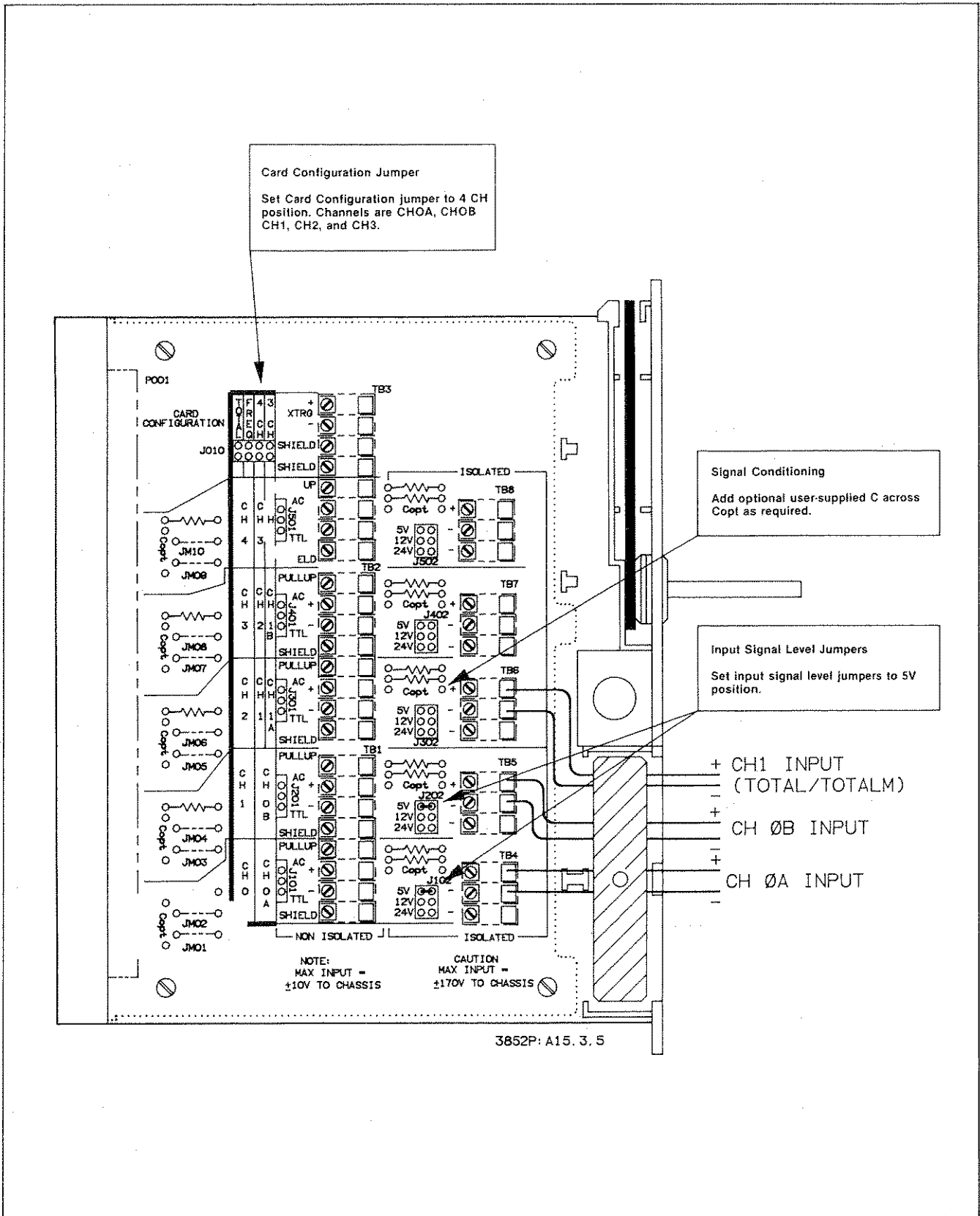

Figure 3-5. Example: Isolated Channels - Field Wiring

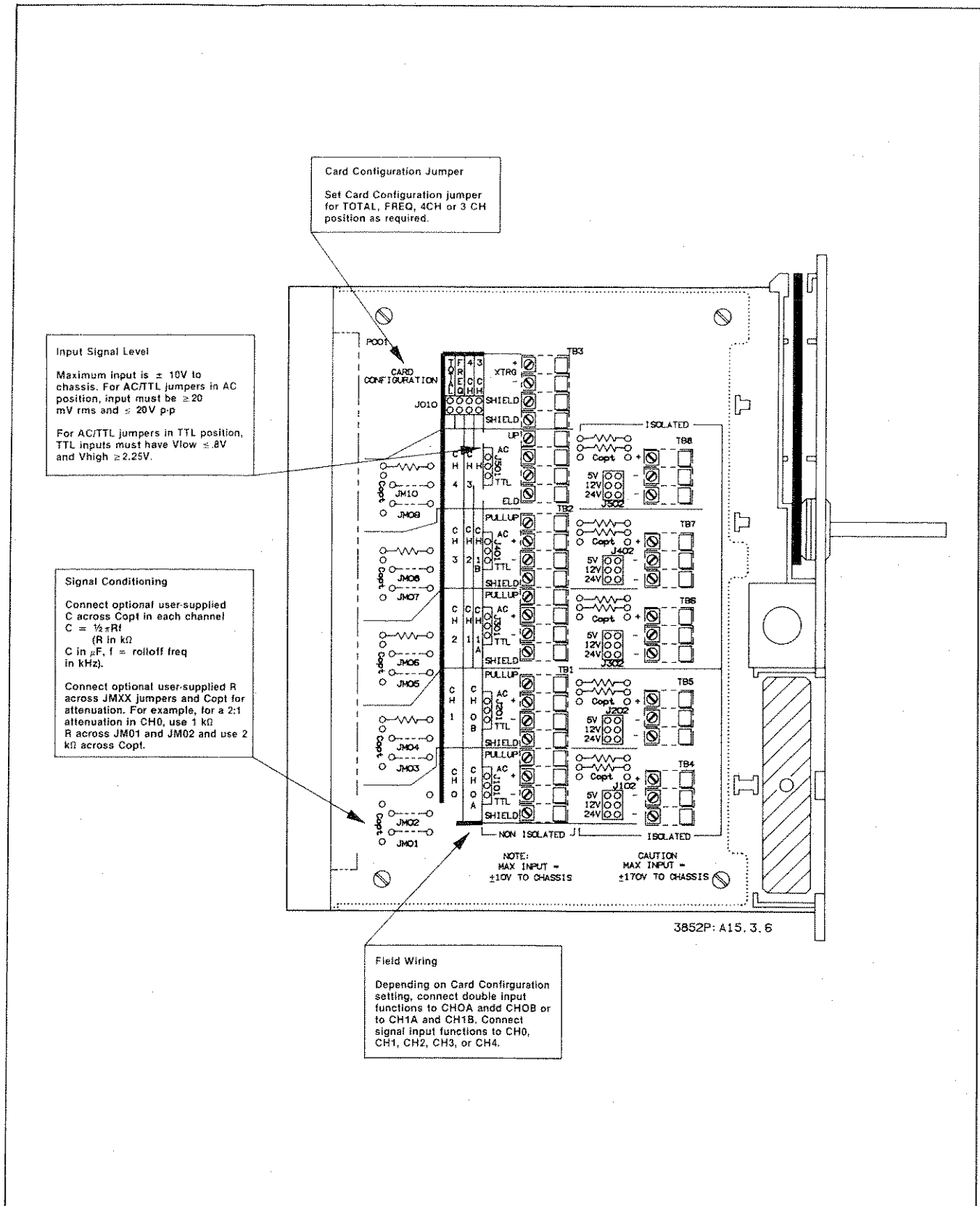

Figure 3-6. Non Isolated Channel Features

Setting AC/TTL Jumpers

As shown in Figure 3-6, each Non Isolated input channel has a separate jumper which sets the channel input voltage level to AC or TTL. AC inputs must be $\leq \pm 10$ VAC peak to chassis (20 VAC peak to peak input signal) and ≥ 25 mV rms. TTL inputs must have $V_{low} \leq 0.8$ volts and $V_{high} \geq 2.25$ volts. Set each jumper to AC or TTL as required for your inputs.

Adding Signal Conditioning Elements

Each Non Isolated input channel has connections (JMXX) for optional, user-supplied resistors and a connector (Copt) for an optional, user-supplied capacitor. The JM jumpers can be replaced with resistors and Copt can be replaced with a resistor or a capacitor for DC attenuation or for a low-pass filter.

For 2:1 DC attenuation on a channel, place 1 k Ω resistors across each of the JM jumpers and a 2 k Ω resistor across Copt. For a low-pass filter, compute the capacitance value from $C_{opt} = 1/(2\pi f * R)$, where R = resistor value in k Ω to be placed across each of the JM jumpers, f = desired rolloff frequency in kHz, and Copt = capacitor value in μ F. Note that these elements attenuate only normal mode signals and will not help common mode noise rejection.

For example, for filter rolloff frequency = 1 kHz in channel 0, use R = 1 k Ω across JM01 and across JM02 and use Copt = 0.08 μ F. For filter rolloff frequency = 10 kHz on this channel, use R = 1 k Ω across JM01 and across JM02, and use Copt = 0.008 μ F.

Connecting Field Wiring

When the AC/TTL jumpers have been set and signal conditioning elements have been installed (as required), connect field wiring from your devices to terminals TB1, TB2, or TB3. When connecting the wiring, route the wires under the strain relief clamp and tighten the clamp screw to reduce the chance of the wires being pulled out of the terminals.

Using Pullup Resistors

A 3 k Ω pullup resistor to +5V is provided on each Non Isolated input channel. For inputs such as relays or open collector outputs, you can connect field wiring to the PULLUP, +, -, and SHIELD terminals. Connect PULLUP to +, SHIELD to -, and set the AC/TTL jumper to the TTL position. With these connections, relay closure causes a low input and relay opening causes a high input.

Figure 3-7 shows typical connections using the pullup resistor. The two wire connection (method A) is acceptable. However, the four wire connection (method B) provides better noise margin on logic low (when the switch is closed).

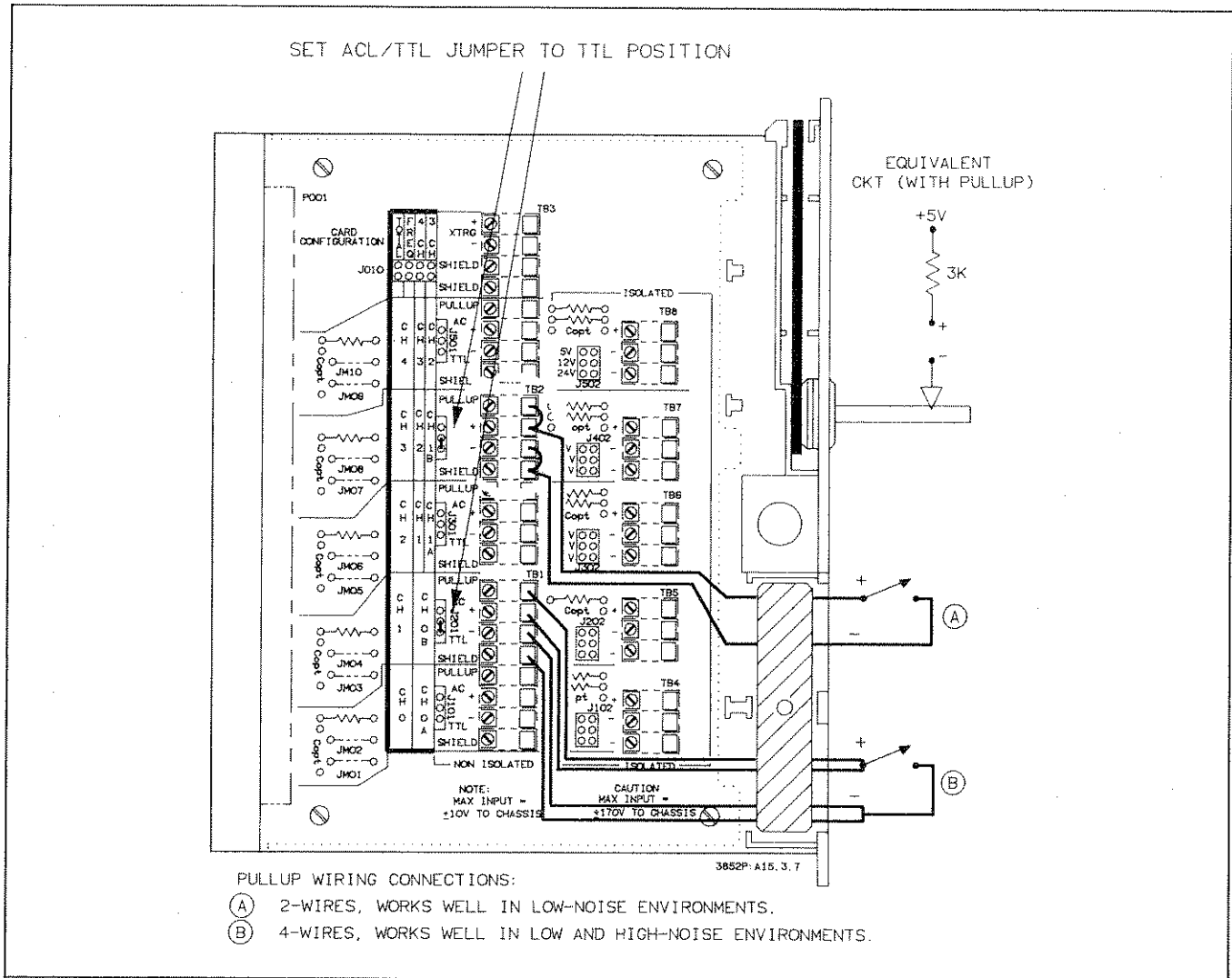

Figure 3-7. Example: Using Pullup Resistors

Typical Connections

Figure 3-8 shows example field wiring connections to channel 0 (CH0A and CH0B) and to channel 1. The Card Configuration jumper is set to the 4 CH position and the AC/TTL jumpers are set to AC for both channels. With this configuration, a double input function (any function except TOTAL, TOTALM, or FREQ) can be input to channel 0 and a TOTAL or TOTALM function can be input to channel 1.

Installation and Checkout

When required channels have been configured and field wiring connected, replace the terminal module cover, connect the terminal module to the component module, and install the counter in a desired slot. Refer to the HP 3852A Mainframe Configuration and Programming Manual to install the accessory.

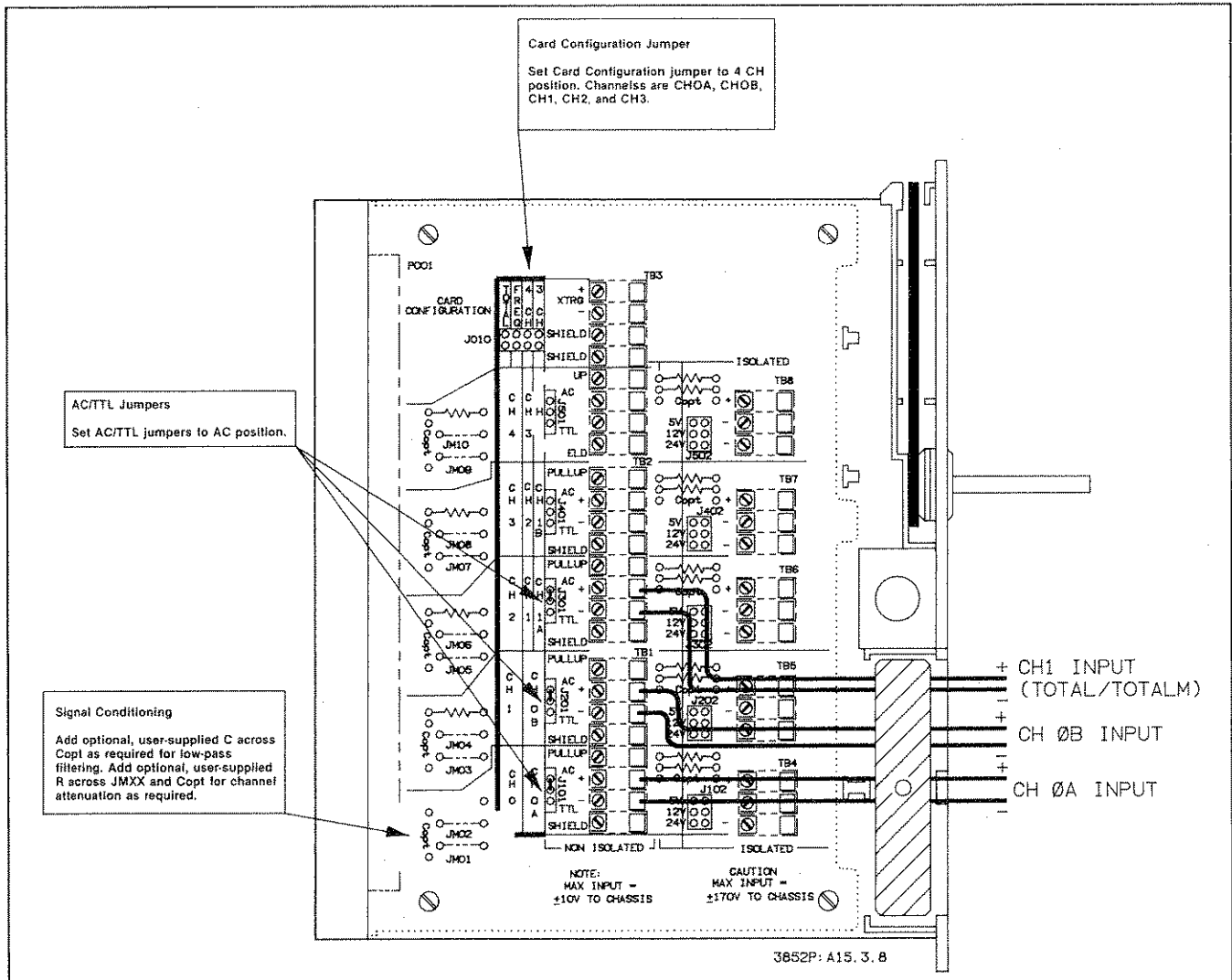

Figure 3-8. Example: Non Isolated Channels - Field Wiring

When the counter is installed, enter the `ID? slot` command from the front panel to check the counter identity. At power-on, a counter returns 44715A, while a counter component module only (no terminal module attached) returns 447XXX. Note that if the terminal module is removed after power-on, the `ID?` command returns 44715A.

If the counter does not return 44715A, be sure you have addressed the correct slot and the terminal module is installed. If these are correct but 44715A is not returned, refer to the HP 3852A Assembly Level Service Manual for service procedures.

This completes hardware configuration for the counter. Refer to Chapter 4 - Programming the Counter to program counter channels for your application.

C
F
R
E
E
D
O
M
O
F
I
N
F
O
R
M
A
T
I
O
N
A
C
T
1
9
7
6

Chapter 4

Programming The Counter

Contents

Introduction	4-1
Chapter Contents	4-1
Command Summary	4-1
Selecting Channel Parameters	4-3
Selecting Channel Function	4-4
Channel Function/Presets (CONF)	4-4
Channel Function (FUNC)	4-6
Selecting Channel Input	4-6
Input Terminals (TERM)	4-6
Count/Gate Edges (EDGE)	4-7
Trigger Source (TRIG)	4-8
Selecting Counts/Timing	4-9
Counter Presets (CNTSET)	4-10
Number or Period (NPER)	4-11
Sample Period (SPER)	4-12
Time Base (TBASE)	4-12
Selecting Reads	4-15
Single Read (CHREAD)	4-15
Read/Zero Results (CHREADZ)	4-16
Multiple Reads (XRDGS)	4-16
Selecting Interrupts	4-17
Enabling Interrupts (ENABLE INTR)	4-17
Disabling Interrupts (DISABLE INTR)	4-17
Programming Examples	4-18
Totalize Counts (TOTAL/TOTALM)	4-19
Example: Count Switch Closures	4-19
Example: Count Switch Closures, Modulo 5	4-21
Up/Down Counts (UDC/UDCM)	4-23
Example: Count Pulse Rates	4-23
Example: Count Pulse Rates, Modulo 5	4-24
Count With Direction Control (CD/CDM)	4-25
Example: Determine Shaft Position	4-26
Example: Determine Shaft Position Using Quadrature	4-27
Ratio Measurements (RAT)	4-29
Example: Measure Ratio	4-29
Period Measurements (PER/PERD)	4-31
Example: Measure Average Period	4-32
Example: Measure Single Period	4-33
Frequency Measurements (FREQ)	4-35
Example: Measure Flow Rate	4-35

Programming the Counter

Introduction

This chapter shows how to select channel parameters for your measurement and shows some example programs for counting and measurement functions.

Chapter Contents

Chapter sections are:

- **Introduction** summarizes chapter contents and includes an alphabetical summary of commands which apply to the counter.
- **Selecting Channel Parameters** gives guidelines to select channel parameters for your measurement. It includes guidelines to select the channel function, channel input, counts/timing, reads, and interrupts.
- **Programming Examples** contains example programs to program the counter for counting and measurement functions.

Command Summary

Table 4-1 is an alphabetical summary of commands which apply to the counter. Refer to the HP 3852A Command Reference Manual for a complete description of these commands.

Table 4-1. Counter Commands

CHREAD *ch* [**INTO** *name*] or [*fmt*]

For the channel specified by *ch*, reads the counts, the period, or the frequency of the input to the channel.

CHREADZ *ch* [**INTO** *name*] or [*fmt*]

For the channel specified by *ch*, reads and zeroes the count or the period of the input to the channel. CHREADZ does not apply to Frequency Measurements (FREQ).

CNTSET [*number*] [**USE** *ch*]

Using the channel specified by the **USE** *ch* command or parameter, sets the channel counter to the number specified by *number*. CNTSET is valid only when the TOTAL function is programmed.

CONF *function* [**USE** *ch*]

Configure the channel specified by the **USE** *ch* command or parameter to a counting (TOTAL, TOTALM, UDC, UDCM, CD, or CDM) or to a measurement (RAT, PER, PERD, or FREQ) function. In addition, CONF presets the channel to a known state and disables and clears all interrupts on the channel.

DISABLE INTR [**USE** *ch*]

Prevents the counter channel specified by the **USE** *ch* command or parameter from generating an interrupt on counter overflow or measurement complete.

EDGE *trans* [*trans*] [**USE** *ch*]

Sets edges to be detected on the channel specified by the **USE** *ch* command or parameter. The first *trans* parameter sets the A input edges to be detected while the second *trans* parameter sets the B input edges to be detected.

The second *trans* parameter is not valid for single input channels. If the second *trans* parameter is not specified for a double input channel, the value for the first *trans* parameter is used for both.

ENABLE INTR [**USE** *ch*]

Enables the channel specified by the **USE** *ch* command or parameter to interrupt. Depending on the function set, the channel will interrupt on counter overflow (for TOTAL or TOTALM) or on measurement complete (RAT, PER, PERD, or FREQ). The command does not generate interrupts for the UDC, UDCM, CD, or CDM functions.

FUNC *function* [*tbase*] [**USE** *ch*]

Sets the counter to one of nine functions: TOTAL, TOTALM, UDC, UDCM, CD, CDM, RAT, PER, or PERD (FUNC does not apply to Frequency Measurements). The FUNC *tbase* parameter is valid only for PER and PERD functions. Default for *tbase* is AUTO.

NPER *number* [**USE** *ch*]

Use on the channel specified by **USE** *ch* command or parameter. For the TOTALM, UDCM, or CDM functions, the counter overflows at the next count after NPER-1 counts. For the RAT function, NPER periods occur on the B input during the measurement.

For the PER function, NPER periods of the A input are averaged. For the PERD function, NPER-1 gated periods will occur on the A input before the measurement begins and the B input gates the A input count. NPER is not valid for the TOTAL, UDC, CD, or FREQ functions.

SPER *number* [**USE** *ch*]

Samples all inputs to the counter at a rate specified by *number*, where *number* = sample period in seconds.

TBASE [*tbase*] [**USE** *ch*]

For the channel specified by the **USE** *ch* command or parameter, *tbase* sets the time base (in seconds) for use with PER, PERD, or FREQ functions. Default is AUTO selection of time base.

Table 4-1. Counter Commands (Cont'd)

TERM *terminal* [*terminal*] [USE *ch*]

For the channel specified by the USE *ch* command or parameter, the first *terminal* parameter sets the terminal for the A input, while the second *terminal* parameter sets the terminal for the B input (for double input channels only).

The second *terminal* parameter does not apply to single input channels. If the second *terminal* parameter is not used for double input channel functions, the value of first *terminal* is used for both parameters.

TRIG [*source*] [USE *ch*]

For the channel specified by the USE *ch* command or parameter, *source* sets the trigger mode/source to one of five modes: AUTO, EXT, HOLD, SGL, or SYS.

When the counter is set to the FREQ function, the trigger mode/source applies to all five channels.

USE *ch*

Use the channel specified by the *ch* command or parameter in commands to follow, where *ch* is the address of the channel. When USE *ch* is executed, the address remains active until another USE statement or system reset.

XRDGS *ch* [*number*] [INTO *name*] or [*fmt*]

For the channel specified by *ch*, transfers the number of readings specified by *number* from the counter to the mainframe. If a reading is not available, the command waits until the readings are available and then transfers the readings. Default *number* = 1.

Selecting Channel Parameters

The first step to program the counter is to select the channel parameters required for your measurement. Table 4-2 shows suggested steps to select channel parameters. The associated command to set the parameter is shown in parentheses. A discussion of each parameter area follows. When you have selected the channel parameters required, refer to "Programming Examples" for some example programs.

Table 4-2. Selecting Channel Parameters

• Select Channel Function	
- Counter Function/Presets	(CONF)
- Counter Function	(FUNC)
• Select Channel Input	
- Input Terminals	(TERM)
- Count/Gate Edges	(EDGE)
- Trigger Source	(TRIG)
• Select Counts/Timing	
- Counter Presets	(CNTSET)
- Number or Period	(NPER)
- Sample Period	(SPER)
- Time Base	(TBASE)
Select Reads	
- Single Read	(CHREAD)
- Read/Zero Results	(CHREADZ)
- Multiple Reads	(XRDGS)
• Select Interrupts	
- Enabling Interrupts	(ENABLE INTR)
- Disabling Interrupts	(DISABLE INTR)

Selecting Channel Function

Channel Function/ Presets (CONF)

The first channel parameter to select is the function to be set on each channel used. The channel function can be set with either the CONF or the FUNC command.

The easiest way to set a channel function is with the CONF *function* [USE *ch*] command. CONF sets the channel function, presets the channel specified by the USE *ch* command or parameter to a known state, and clears and disables any interrupts on the channel.

CONF *function* Parameters

For convenience, Table 4-3 repeats the functions set with the CONF *function* parameter shown in Table 2-1. Refer to Chapter 2 - Selecting Counter Functions for a definition of each function.

NOTE

1. Double input functions (all except Ungated Total Counts [TOTAL], Gated Total Counts, Modulo NPER [TOTALM], and Frequency Measurements [FREQ]) can only be programmed on channels configured for double input.
2. When the Card Configuration jumper is set to FREQ, only the FREQ parameter can be set. For other settings of the Card Configuration jumper, power-on and CONF function setting is TOTAL for all channels.

Table 4-3. CONF *function* Parameters

Function	function	Ch	Description	Inputs		Interrupts	
				A	B	Type	When
Totalize Counts							
Ungated Total Counts	TOTAL	S	Count number of A input transitions.	Count	N/A	OVF	Rollover (-1 to 0)
Gated Total Counts	TOTAL	D	Count number of A input transitions, gate with B input.	Count	Gate	OVF	Rollover (-1 to 0)
Ungated Total Counts, Modulo NPER	TOTALM	S	Count number of A input transitions, modulo NPER.	Count	N/A	OVF	Rollover (NPER-1 to 0)
Gated Total Counts, Modulo NPER	TOTALM	D	Count number of A input transitions, modulo NPER. Gate with B input.	Count	Gate	OVF	rollover (NPER-1 to 0)

Table 4-3. CONF function Parameters (Cont')

Up/Down Counts							
Up/Down Counts	UDC	D	Count up on A input, count down on B input. Result is (A-B) counts.	Up Count	Down Count	---	None
Up/Down Counts, Mod NPER	UDCM	D	Count up on A input, count down on B input. Result is (A-B) counts, modulo NPER.	Up Count	Down Count	---	None
Count With Direction Control							
Count/Direction	CD	D	Count A input up or down. B input controls direction.	Count	Dir	---	None
Count/Direction, Mod NPER	CDM	D	Count A input up or down. B input controls direction. Count modulo NPER.	Count	Dir	---	None
Quadrature Count	CD	D	Count up on all A input transitions when B leads A. Count down on all A input transitions when A leads B.	Count	Dir	---	None
Quadrature Count, Modulo NPER	CDM	D	Same as Quadrature Count except count modulo NPER.	Count	Dir	---	None
Ratio Measurements							
Ratio	RAT	D	Measure average number of A input counts per B input period.	Count	Count	MC	After NPER B Periods
Period Measurements							
Period	PER	D	Measure average of NPERth periods of A input.	Count	Not Used	MC	After NPERth Period of A
Delayed Period	PERD	D	Measure NPERth gated period of A input, gate with B input.	Count	Gate	MC	After NPERth Gated Period of A
Frequency Measurements							
Frequency	FREQ**	S	Measure average frequency of A input.	Count	N/A	MC	After Gate Time

Notes:

* = Although B input is not used, PER function must be programmed on a double input channel.

** = FUNC command does not apply to FREQ parameter.

CONF Command Preset Values

As noted, CONF also presets the counter to a known state. That is, executing CONF is equivalent to executing the commands in Table 4-4 in the order shown. You can then use low level commands as required to modify the CONF settings.

Table 4-4. CONF Preset Values

All Functions Except FREQ			
Command	Description	Preset Value	Note
TRIG	Trigger mode	HOLD	
FUNC	Counter function	Set by CONF	[a]
TERM	Input terminals	ISO,ISO	[b]
EDGE	Counted/gated edge	HL,HL	[c]
NPER	Measurement period/reset	10	
CNTSET	Start count/rollover	0	[d]
DISABLE INTR	Disable interrupt	Disabled	
SPER	Sample period	1 μ sec	

[a] = TBASE AUTO is also set. TBASE is specified for PER and PERD only.
 [b] = TERM ISO for single input functions.
 [c] = EDGE HL for single input functions.
 [d] = CNTSET applies to TOTAL functions only.

FREQ Function			
Command	Description	Preset Value	Note
TRIG	Trigger mode	HOLD	
TBASE	Time base	AUTO	
TERM	Input terminals	ISO	
EDGE	Counted/gated edge	HL	
DISABLE INTR	Disable interrupt	Disabled	
SPER	Sample period	1 μ sec	

Channel Function (FUNC) You can also use the *FUNC function [tbase] [USE ch]* command to select any of the functions shown for the CONF command (refer to Table 4-3) except FREQ. However, in contrast to the CONF command, FUNC does not preset the channel to a known state.

For FUNC, *tbase* is valid only for *function* = PER or PERD. The *tbase* parameter is the period of the counter internal clock which is counted during NPER periods of the input. *tbase* values are 1 μ sec, 10 μ sec, 100 μ sec, 1 msec, and 10 msec with default value = AUTO. Refer to "Time Base (TBASE)" for details on the *tbase* parameter.

Selecting Channel Input

Three commands are used to set input channel parameters. TERM sets the input path (Isolated or Non Isolated channels), EDGE sets the input edges to be counted or sets the gate level, and TRIG sets the counter trigger source.

Input Terminals (TERM)

The input signal path (Isolated or Non Isolated) is set by the *TERM terminal [terminal] [USE ch]* command. The first *terminal* parameter sets the A input terminals and the second *terminal* parameter sets the B input terminals (for double input functions only).

TERM ISO sets Isolated Input terminals and TERM NON sets Non Isolated Input terminals. Power-on, default and CONF settings are TERM ISO for single input functions and TERM ISO,ISO for double input functions.

Example: Specifying Input Terminals (TERM)

For example, if the Card Configuration jumper is set for 4 CH configuration, TERM NON,NON,USE 200 sets the terminal inputs for channels 0A and 0B of a counter in slot 2 of the mainframe to Non Isolated input. Or, if the jumper is set for 3 CH configuration, TERM ISO,ISO,USE 201 sets channels 1A and 1B of a counter in slot 2 of the mainframe to Isolated input.

Count/Gate Edges (EDGE) Use the EDGE command to select the input edge (transition) to be counted or to set the gate level. The EDGE *trans* [*trans*] [USE *ch*] command has four values for the *trans* parameter: LH, HL, HI, and LO.

For single input functions, the second *trans* parameter is not allowed. For double input functions, the first *trans* parameter applies to the A input and the second *trans* parameter to the B input. Power-on setting is EDGE LH (EDGE LH, LH for double input functions). Note, however, that CONF sets EDGE HL (HL,HL for double input functions).

NOTE

- 1. Although the PER function can be used only on a double input channel, the second EDGE trans parameter need not be specified since the B "input" is internally generated by the counter.*
 - 2. The EDGE command has no effect on Quadrature Count. That is, for any EDGE setting, all A input edges are counted up when B leads A and counted down when A leads B.*
-

Table 4-5. EDGE *trans* [*trans*] Parameters

Gated Total Counts (TOTAL/TOTALM)	
LH,HI*	Count A input LH edges when the B input is high.
LH,LO*	Count A input LH edges when the B input is low.
HL,HI	Count A input HL edges when the B input is high.
HL,LO	Count A input HL edges when the B input is low.
Up/Down Counts (UDC/UDCM)	
LH,LH	Count up on A input LH edges. Count down on B input LH edges.
LH,HL	Count up on A input LH edges. Count down on B input HL edges.
HL,LH	Count up on A input HL edges. Count down on B input LH edges.
HL,HL	Count up on A input HL edges. Count down on B input HL edges.
Count With Direction Control (CD/CDM)	
LH,HI	Count up on A input LH edges when the B input is high. Count down on A input LH edges when the B input is low.
LH,LO	Count up on A input LH edges when the B input is low. Count down on A input LH edges when the B input is high.
HL,HI	Count up on A input HL edges when the B input is high. Count down on A input HL edges when the B input is low.
HL,LO	Count up on A input HL edges when the B input is low. Count down on A input HL edges when the B input is high.
Quadrature Count (CD/CDM)	
N/A**	Count up on all A input edges when B leads A. Count down on all A input edges when A leads B.
Ratio Measurements (RAT)	
LH,LH	LH edges mark A and B input periods.
LH,HL	LH edges mark A input periods. HL edges mark B input periods.
HL,LH	HL edges mark A input periods. LH edges mark B input periods.
HL,HL	HL edges mark A input and B input periods.
Delayed Period Measurements (PERD)	
LH,HI	Count A input LH edges when B input is high.
LH,LO	Count A input LH edges when B input is low.
HL,HI	Count A input HL edges when B input is high.
HL,LO	Count A input HL edges when B input is low.

* = HI is equivalent to LH and LO is equivalent to HL.

** = Same action for any setting of EDGE.

Trigger Source (TRIG) When the input terminals and count/gate edges have been selected, the next step is to select the counter trigger source with the TRIG [*source*] [USE *ch*] command. Table 4-6 describes the TRIG *source* parameters and shows the previous TRIG *source* state(s) cancelled.

Power-on and CONF *source* = HOLD and default *source* = SGL. Note that TRIG EXT requires a hardware connection from the external trigger source to the XTRG terminals (see Figure 3-3).

Table 4-6. TRIG *source* Parameters

source	Description	Cancels Previous source(s)
AUTO	Counter internal triggering (continuous triggering)	TRIG EXT TRIG SYS
EXT	External trigger source (requires hardware connection from source to XTRG terminals).	TRIG AUTO TRIG SYS
HOLD	Aborts ongoing measurement, discards existing count, and disables any trigger source for the channel(s).	TRIG AUTO TRIG EXT TRIG SGL TRIG SYS
SGL	Immediate single trigger when TRIG SGL is executed.	TRIG AUTO TRIG EXT TRIG SYS
SYS	System Triggering (used with TRG command - see Figure 3-3).	TRIG AUTO TRIG EXT

The TRIG command should follow all commands which affect counter setup (CONF, TBASE, NPER, SPER, EDGE, TERM, or CNTSET), since TRIG (and these commands) aborts any ongoing measurement and destroys existing data. Also, if CONF is not used, TRIG HOLD should be set before configuring the counter since other TRIG *sources* may send a trigger to the channel before the channel is properly configured.

TRIG *source* does not change when a channel is reprogrammed to another function. When the Card Configuration jumper is set to the FREQ position, TRIG *source* applies to all five channels. Although multiple channels can be triggered with TRIG EXT or TRIG SYS sources, each channel can be assigned to only one source.

Selecting Counts/ Timing

Four commands can be used to set channel counts/timing parameters (CNTSET, NPER, SPER, and TBASE) although not each parameter applies to every function. Table 4-7 summarizes these four commands and shows the CONF (or FUNC) *function* for which the command is valid.

Table 4-7. Channel Counts/Timing Commands

Command	Description	function(s)
CNTSET	Presets counter to begin counting from a specified number of counts OR to rollover after a specified number of counts.	TOTAL
NPER	Sets the number of periods over which an input is measured OR sets the value minus 1 at which the counting sequence resets to zero.	TOTALM/UDCM/ CDM/RAT/PER/ PERD
SPER	Sets the period over which the input signal is sampled. Inputs which do not remain at the required level during the sample period are ignored.	All
TBASE	Sets the time base to be used with Period, Delayed Period, and Frequency Measurements.	PER/PERD/FREQ*

* = FUNC does not apply to FREQ parameter.

Counter Presets (CNTSET) For Ungated and Gated Total Counts (TOTAL) functions ONLY, you can use CNTSET [number] [USE ch] to preset the A input channel to a number from -2147483648 to 2147483647, as specified by *number*.

The *number* parameter specifies the number of counts to preset the counter or sets the number of counts required to cause the counter to rollover (refer to Table 4-8). Default value and value set by the CONF command is 0.

As shown in Chapter 2 (see Figure 2-1), without a preset value the count sequence is from 0 to 2147483647 counts to -2147483648 to -1 and back to 0. When the counter rolls over (from -1 to 0), if enabled the channel generates a counter overflow (OVF) interrupt.

Therefore, without a preset, 4294967296 counts are needed to generate a counter interrupt. Note that the count range is from 0 to 4294967296, while the CNTSET [number] range is from -2147483648 to 2147483647.

The value to use for CNTSET [number] depends on the number of counts specified, as shown in Table 4-8. For example, if counts = 1000 is desired, *number* = 1000 presets the counter to start counting at 1000 counts, while *number* = -1000 causes the counter to rollover after 1000 counts.

Or, if counts = 3,000,000,000 is desired, *number* = -1294967296 (counts - 4294967296) presets the counter to start counting at 3,000,000,000 counts while *number* = 1294967296 (4294967296 - counts) causes the counter to rollover after 3,000,000,000 counts.

Table 4-8. CNTSET *number* vs. Counts

Preset Counter:		
number = counts		(counts <2147483648)
number = counts - 4294967296		(counts ≥2147483648)
Rollover After Counts:		
number = -counts		(counts <2147483648)
number = 4294967296 - counts		(counts ≥2147483648)

Number or Period (NPER) For the TOTALM, UDCM, CDM, RAT, PER, and PERD functions, counting or measurement is done Modulo NPER, where the value is specified by NPER *number* [USE *ch*]. Modulo NPER mode is useful when you want to count up to a certain value and then generate an interrupt.

For example, with Ungated Total Counts (TOTAL) unless the counter is preset with CNTSET the channel must count 4294967296 counts before the counter rolls over. However, with Ungated (or Gated) Total Counts, Modulo NPER, the counter counts from 0 to NPER-1 and rolls over to 0 with the next count (see Figure 2-1 for counting sequences).

Depending on the function programmed, the NPER command defines either the number of counts or the number of periods to be used for the channel, as shown in Table 4-9. Power-on *number* or the value set by CONF is 10.

Table 4-9. NPER *number* vs. Counter Functions

function(s)	NPER Description	NPER Range
TOTALM, UDCM, CDM	Counting sequence resets to 0 at the next count after the NPER-1 value.	2 to 65535
RAT	Sets number of B input periods to count A input transitions. The A input count is divided by NPER to get the average number of A input counts per B input period.	1 to 65535
PER	Sets the number of A input periods to be measured. The PER function returns the average value of NPER periods of the A input.	1 to 65535
PERD	A single period measurement is taken on the NPERth gated period of the A input.	1 to 65534

Sample Period (SPER) You can use the SPER *number* [USE *ch*] command to set the sample period for ALL channels of the counter, where *number* = sample period (in seconds) at which the inputs are sampled. This command is useful to digitally filter noisy, slow inputs for applications such as debouncing switch closures. Input signals which do not remain at the required level during the sample period are ignored.

The SPER command sets the sample period for ALL channels of the counter, even though USE *ch* is specified for a single channel. For example, with a counter in slot 4 of the mainframe set for TOTAL function, SPER .000001,USE 402 sets a 1 μ sec sample period for channels 0, 1, 2, 3, and 4.

The minimum input pulse width is affected by the SPER command, since minimum pulse width = [(number*2) + 0.5] μ sec. For example, if *number* = 20 μ sec, minimum input pulse width = 40.5 μ sec.

The power on and CONF value for SPER *number* = 1 μ sec. The range of *number* = 1 μ sec to 0.16 seconds in incremental steps, as shown in Table 4-10. The actual sampling period used is rounded up to a valid number closest to the *number* specified.

Table 4-10. SPER *number* Range/Increments

SPER number range	Increments
1 μ sec to 16 μ sec	1 μ sec
20 μ sec to 160 μ sec	10 μ sec
200 μ sec to 1.6 msec	100 μ sec
2 msec to 16 msec	1 msec
20 msec to 160 msec	10 msec

Time Base (TBASE) For power-on, default, and CONF settings, the counter automatically selects the appropriate time base for Period Measurements (PER and PERD) or the gate time for Frequency Measurements (FREQ). However, as required, you can select the time base for Period Measurements or the gate time for Frequency Measurements with the TBASE [*tbase*] [USE *ch*] command. When *tbase* = AUTO or 0, (power-on, default, and CONF setting) the counter automatically selects the best time base or gate time.

NOTE

If tbase is not set to one of the values shown in Table 4-11 for the PER function or in Table 4-12 for the PERD function, the value is rounded down to the next lower valid time base. If tbase is not set to one of the values shown in Table 4-13 for the FREQ function, the value is rounded up to the next higher valid gate time.

Setting TBASE *tbase* for Period Measurements (PER)

As shown in Chapter 2 (see Figure 2-13), the PER function measures the average of NPER periods of the A input (5 μ sec minimum period and 655.35 second maximum period). The resolution of the reading can be increased by increasing NPER (range = 1 to 65535), as shown in Table 4-11.

In Table 4-11, the sample period set by SPER *number* = 1 μ sec, and NPER = the number of periods to be averaged (1 to 65535) as set with the NPER command. Note, however, that the SPER, NPER, TBASE, and CONF (or FUNC) commands interact to determine minimum and maximum pulse widths and periods of the input signal which can be measured.

To compute maximum and minimum periods which can be measured and the resolution for a given *tbase* setting, divide the values shown in the Resolution column of Table 4-11 by the value of NPER. For example, if SPER = 1 μ sec, NPER = 100, and TBASE *tbase* = 10 μ sec the period range is from 5 μ sec (minimum period for any *tbase* setting) to 6.5535 msec with 0.1 μ sec resolution.

With SPER = 1 μ sec, minimum pulse width for the input = $(1*2 + 0.5) \mu$ sec = 2.5 μ sec. However, if SPER is changed to 10 μ sec, minimum pulse width = $(10*2 + 0.5) \mu$ sec = 20.5 μ sec, so the minimum period increases from 5 μ sec to 41 μ sec.

Table 4-11. TBASE *tbase* Resolution - PER Function

tbase	Period Range		Resolution
	Minimum	Maximum	
1 μ sec	5 μ sec	65.535/NPER msec	1/NPER μ sec
10 μ sec	5 μ sec	655.35/NPER msec	10/NPER μ sec
100 μ sec	5 μ sec	6.5535/NPER sec	100/NPER μ sec
1 msec	5 μ sec	65.535/NPER sec	1/NPER msec
10 msec	5 μ sec	655.35/NPER sec	10/NPER msec

Setting TBASE *tbase* for Delayed Period Measurements (PERD)

As shown in Chapter 2 (see Figure 2-14) the PERD function measures the period of the NPERth gated period of the A input. Thus, the considerations to set TBASE *tbase* for PERD are the same as for the PER function, except that the NPER range = 1 to 65534 for the PERD function and the resolution does not depend on the NPER value. Table 4-12 shows the TBASE *tbase* resolution for the PERD function.

Table 4-12. TBASE *tbase* Resolution · PERD Function

tbase	Period Range		Resolution
	Minimum	Maximum	
1 μ sec	5 μ sec	65.535 msec	1 μ sec
10 μ sec	5 μ sec	655.35 msec	10 μ sec
100 μ sec	5 μ sec	6.5535 sec	100 μ sec
1 msec	5 μ sec	65.535 sec	1 msec
10 msec	5 μ sec	655.35 sec	10 msec

Setting TBASE *tbase* for Frequency Measurements (FREQ)

As shown in Chapter 2 (see Figure 2-15), the FREQ function provides the average frequency of the input as measured over an adjustable time base (gate time). When the Card Configuration jumper is set to the FREQ position, you can set the gate time for Frequency Measurements with the TBASE [*tbase*] parameter.

For the FREQ function, the TBASE *tbase* setting applies to ALL five channels. Power-on, default, and CONF setting for *tbase* is AUTO. Table 4-13 shows the frequency range and resolution for each of the three *tbase* settings with SPER = 1 μ sec.

Table 4-13. TBASE *tbase* Settings · FREQ Function

tbase	Gate Time	Frequency Range	Resolution*
1 sec	1 sec	1 Hz to 65.535 kHz	1 Hz
100 msec	100 msec	10 Hz to 200 kHz	10 Hz
10 msec	10 msec	100 Hz to 200 kHz	100 Hz

* = SPER = 1 μ sec.

When the Card Configuration jumper is set to the FREQ position, SPER and TBASE interact to determine frequency range and resolution. For example, with SPER = 1 μ sec and TBASE *tbase* = 100 msec, the frequency range is from 10 Hz to 200 kHz with 10 Hz resolution.

For SPER = 1 μ sec, the minimum pulse width for the input = $(1 \times 2 + 0.5) \mu$ sec = 2.5 μ sec. However, if SPER is changed to 10 μ sec, the minimum pulse width = $(10 \times 2 + 0.5) \mu$ sec = 20.5 μ sec, so minimum period = 41 μ sec and maximum frequency decreases from 200 kHz to about 24.4 kHz.

Selecting Reads

There are three commands to read the results of channel measurements: CHREAD, CHREADZ, and XRDGS. Counting functions (TOTAL, TOTALM, UDC, UDCM, CD, and CDM) can be read at any time without disturbing the counting sequence. Measurement functions (RAT, PER, PERD, and FREQ) can be read only when the measurement is complete.

Single Read (CHREAD)

Use CHREAD to read the results of channel measurements. CHREAD returns the current count for the TOTAL, TOTALM, UDC, UDCM, CD, and CDM functions. CHREAD returns the most recently completed measurement (ratio, period, or frequency) for the RAT, PER, PERD, and FREQ functions. The channel addressed must have been triggered and data must be available before CHREAD will return a reading.

For measurements which can be read at any time (TOTAL, TOTALM, UDC, UDCM, CD, and CDM), CHREAD does not affect interrupts enabled for the channel. For measurements which can be read only when the measurement is complete (RAT, PER, PERD, and FREQ), CHREAD clears the measurement complete interrupt. Refer to Table 4-14 for the type of data returned by CHREAD for each counter function.

NOTE

Note that the TOTAL, UDC, and CD functions return a number between -2147483648 to +2147483647. Since the counter counts from +2147483647 to -2147483648, any number ≥ 2147483648 but < 4294967296 is returned as a negative number.

Thus, for these functions if a negative number is returned, use 4294967296 minus the absolute value of the number returned. For example, for a channel set to the TOTAL function if -1000000000 is returned, the actual number of counts on the channel = $4294967296 - 1000000000 = 3294967296$.

Table 4-14. Data Returns vs. Counter Functions

function	Data Returned	Range
TOTAL	Total counts on A input.	- 2147483648 to 2147483647
TOTALM	Total counts on A input, modulo NPER.	0 to 65534
UDC	Difference between A input and B input counts (A-B).	- 2147483648 to 2147483647
UDCM	Difference between A input and B input counts (A-B), modulo NPER.	0 to 65534
CD	Net counts on A input.	- 2147483648 to 2147483647
CDM	Net counts on A input, modulo NPER.	0 to 65534
RAT	Average counts on A input per B input period.	0 to 65535/NPER
PER	Average of NPER periods of the A input.	5 μ sec to 655.35/NPER sec
PERD	Value of NPERth gated period of the A input.	5 μ sec to 655.35 sec
FREQ*	Average frequency of the A input.	1+ Hz to 200 kHz

* = CHREADZ cannot be used for the FREQ function.

Read/Zero Results (CHREADZ) Use the CHREADZ command to read and zero the count on a channel. For measurements which can be read at any time, CHREADZ performs the same functions as CHREAD, except that the channel counter is reset to zero. For measurements which can be read only when the measurement is complete, CHREADZ performs the same functions as the CHREAD command, except that CHREADZ does not apply to the FREQ function. Refer to Table 4-14 for the data returned by CHREADZ.

Multiple Reads (XRDGS) To read multiple results, use the XRDGS *ch* [*number*] command, where *number* specifies the number of readings to be returned on the channel specified by *ch*. To use XRDGS, the channel addressed must have been triggered and a reading must be available. The range of *number* = 1 to 2147483647 with default = 1.

For the TOTAL, TOTALM, UDC, UDCM, CD, and CDM functions, only one trigger is required. For the RAT, PER, PERD, and FREQ functions, the number of valid triggers must be the same as the number of readings transferred. Also, RAT, PER, and PERD functions require NPER input periods per measurement.

When XRDGS is executed, the number of readings specified by *number* are transferred as each becomes available. In effect, XRDGS acts like several CHREADS. XRDGS clears any measurement complete interrupt previously generated by a RAT, PER, PERD, or FREQ measurement. Refer to Table 4-14 for data returned by XRDGS.

Selecting Interrupts

Each channel can be enabled to interrupt with the ENABLE INTR [USE *ch*] command. When enabled, a channel interrupts on counter overflow or on measurement complete, depending on the function set for the channel. Also, each channel can be prevented from interrupting with the DISABLE INTR [USE *ch*] command.

Enabling Interrupts (ENABLE INTR)

Interrupts can be independently enabled for each channel with the ENABLE INTR command. Depending on the function set, counter overflow (OVF) or measurement complete (MC) interrupts can be enabled, as shown in Table 4-15. If more than one channel generates an interrupt, the mainframe services the lowest-numbered channel first, then the next-lowest, etc. The counter keeps track of the interrupts which have not been serviced.

OVF interrupts are automatically disabled and cleared when serviced. MC interrupts are automatically disabled when serviced and cleared when the reading is taken from the channel. The RST or RST *slot* (reset) command disables all channels from interrupting on counter overflow or measurement complete.

Table 4-15. Interrupts vs. Counter Functions

function	Type	When Generated	NPER range
TOTAL	OVF	Count goes from -1 to 0	N/A
TOTALM	OVF	Count goes from NPER-1 to 0	2 to 65535
RAT	MC	After NPER B input periods	1 to 65535
PER	MC	After NPER A input periods	1 to 65535
PERD	MC	After NPERth gated A input period	1 to 65534
FREQ	MC	After gate time	N/A

Disabling Interrupts (DISABLE INTR)

Each counter channel can be independently disabled from generating an OVF or MC interrupt with the DISABLE INTR [USE *ch*] command. The DISABLE INTR command disables OVF or MC interrupts (as applicable) interrupts for the channel specified by the USE *ch* command or parameter.

For a channel set to TOTAL, TOTALM, UDC, UDCM, CD, or CDM function, DISABLE INTR disables and clears the channel interrupt. Then, a subsequent ENABLE INTR will not prematurely generate an interrupt.

For the RAT, PER, PERD, and FREQ functions, DISABLE INTR clears but does not disable a pending interrupt so a subsequent ENABLE INTR could generate an interrupt. The interrupt is cleared when the measurement is read.

NOTE

1. If a parameter (edge, term, etc.) is changed on a disabled channel, the channel remains disabled but any pending interrupts are cleared. (CONF clears and disables interrupts).
 2. Even if DISABLE INTR is not used, an OVF interrupt is automatically disabled and cleared when the interrupt is serviced. An MC interrupt is automatically disabled when it is serviced and is cleared when the reading has been taken on the channel.
-

Programming Examples

This section shows example programs for several counter functions. Refer to Table 4-16 for titles of the example programs. Also, refer to Chapter 2 - Selecting Counter Functions for a description of counter functions.

The procedure for each example will be to use the CONF command to set the counter to a known state (refer to Table 4-4) and then modify the conditions as required with low-level commands (EDGE, etc.). For all functions except **FREQ**, you can use **FUNC** rather than **CONF** to set the counter function. However, since **FUNC** does not preset the counter for other conditions, low-level commands must be used to set the conditions otherwise set by **CONF**.

Table 4-16. Example Program Titles

Function	Title	Description
Totalize Counts (TOTAL/TOTALM)		
Ungated Total Counts (TOTAL)	Count Switch Closures	Count number of switch closures and generate an OVF interrupt after 10 closures.
Gated Total Counts, Mod NPER (TOTALM)	Count Switch Closures, Modulo 5	Count number of switch closures only when a control switch is open. Count closures modulo 5.
Up/Down Counts (UDC/UDCM)		
Up/Down Counts (UDC)	Count Pulse Rates	Measure difference in number of pulses output from two pulse generators.
Up/Down Counts, Mod NPER (UDCM)	Count Pulse Rates, Modulo 5	Measure difference in number of pulses output from two pulse generators, count modulo 5.

Table 4-16. Example Program Titles (Cont'd)

Function	Title	Description
Count With Direction Control (CD/CDM)		
Count/ Direction (CD)	Determine Shaft Position	Determine shaft position using a shaft encoder and Count/ Direction.
Quadrature Count (CD)	Determine Shaft Position Using Quadrature	Determine shaft position using a shaft encoder and Quadrature Count.
Ratio Measurements (RAT)		
Ratio (RAT)	Measure Ratio	Determine number of pulses output from test generator for 1000 pulses output from reference generator.
Period Measurements (PER/PERD)		
Period (PER)	Measure Average Period	Measure average period of an input.
Delayed Period (PERD)	Measure Single Period	Measure the 100th gated period of an input.
Frequency Measurements (FREQ)		
Frequency (FREQ)	Measure Flow Rate	Measure paddlewheel flow meter flow rate by measuring pickup input frequency.

Totalize Counts (TOTAL/ TOTALM)

Totalize Counts functions include Ungated Total Counts (TOTAL), Gated Total Counts (TOTAL), Ungated Total Counts, Modulo NPER (TOTALM), and Gated Total Counts, Modulo NPER (TOTALM).

Two examples follow which use the TOTAL or TOTALM function. The first example "Count Switch Closures" uses Ungated Total Counts (TOTAL) to totalize switch closures and generate an OVF interrupt after 10 closures. The second example "Count Switch Closures, Modulo 5" uses Gated Total Counts, Modulo NPER (TOTALM) to count switch closures (count modulo 5) only when a control switch is open.

Example: This program totalizes the number of times a switch (S3) closes and generates an OVF interrupt when the switch closes 10 times. See Figure 4-1 for typical connections and counter configuration for channel 503 of a counter in slot 5 of the mainframe.

When the OVF interrupt occurs (counter rolls over from -1 to 0), the program returns the time of the interrupt and the message "S503 - 10 Closures".

The STA? command reads the Status Register and clears the FPS, LCL, INTR, LMT, and ALRM bits and CLROUT clears the output buffer. SPOLL (709) clears the Status Register service request bit (SRQ bit).

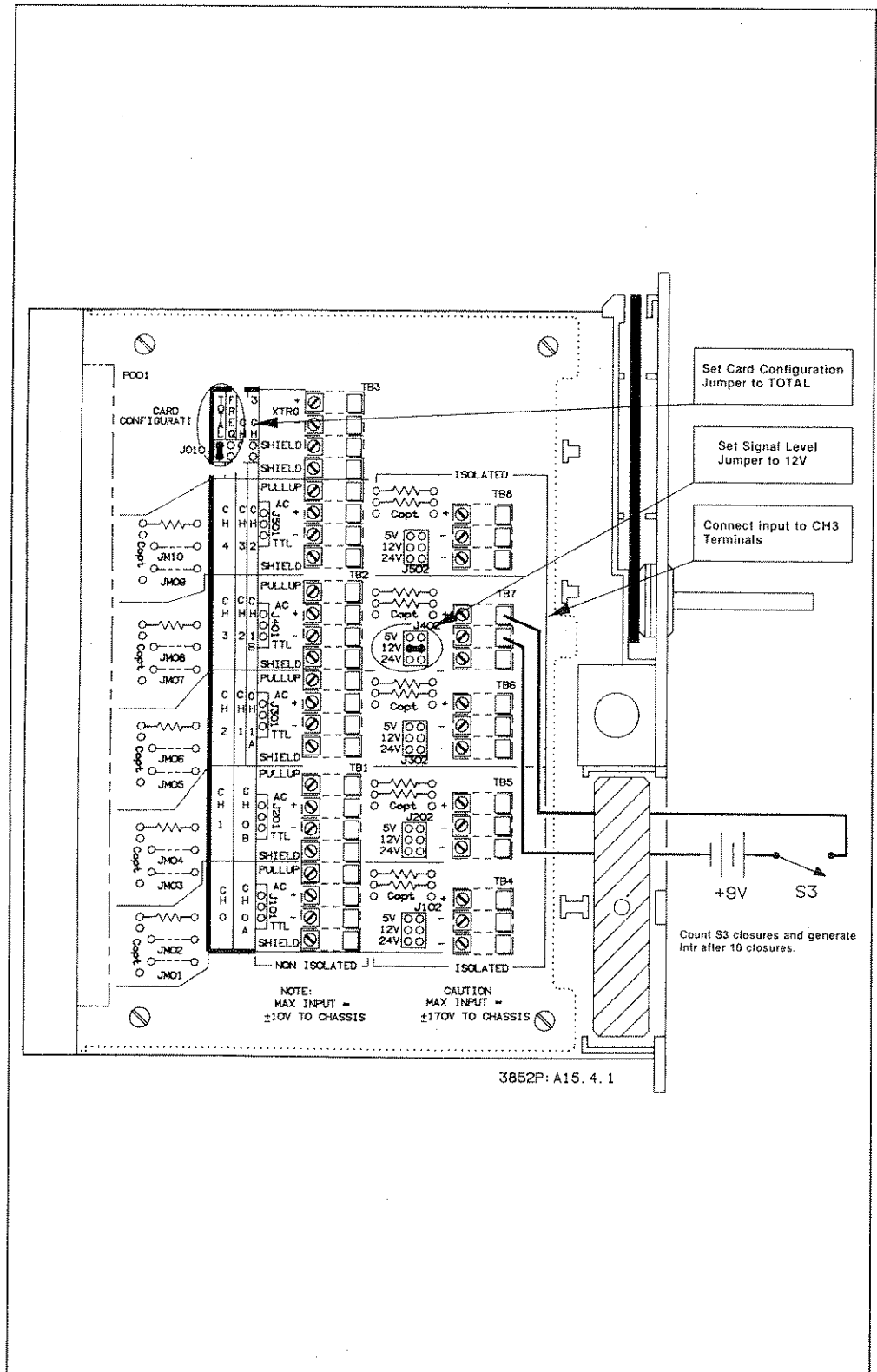

Figure 4-1. Example: Count Switch Closures

10 ON INTR 7 GOSUB Results	!Call sub Results on interrupt
20 ENABLE INTR 7;2	!Enable controller intr on SRQ
30 OUTPUT 709;"RST 500"	!Reset the counter
40 OUTPUT 709;"USE 503"	!Use channel 503
50 OUTPUT 709;"RQS INTR"	!Enable RQS Mask Reg INTR bit
60 OUTPUT 709;"RQS ON"	!Set RQS mode ON
70 OUTPUT 709;"CONF TOTAL"	!Set TOTAL function
80 OUTPUT 709;"ENABLE INTR SYS"	!Enable mainframe intr capability
90 OUTPUT 709;"ENABLE INTR"	!Enable counter intr capability
100 OUTPUT 709;"STA?"	!Clear FPS,LCL,INTR,LMT,ALRM bits
110 OUTPUT 709;"CLROUT"	!Clear output buffer
120 OUTPUT 709;"EDGE LH"	!Count LH transitions
130 OUTPUT 709;"CNTSET -10"	!Rollover after 10 counts
140 OUTPUT 709;"TRIG SGL"	!Trigger the counter
150 GOTO 150	!Loop until interrupt occurs
160 Results: !	!Start controller subroutine
170 OUTPUT 709;"TIME"	!Query time of day
180 ENTER 709;T	!Enter time of day
190 PRINT "Ch 503 Intr @ ";TIME\$(T)	!Print interrupt time/message
200 PRINT "S503 - 10 Closures"	!Display message
210 A=SPOLL (709)	!Read /clear SRQ bit
220 STOP	!End controller subroutine
230 END	

After 10 switch closures, an OVF interrupt is generated and a typical return is:

```
Ch 503 Intr @ 02:12:16
S503 - 10 Closures
```

Example: Count Switch Closures, Modulo 5

This example is similar to the previous example except that switch S1 closures are counted only when a control switch (S2) is open, the count is modulo 5, and an OVF interrupt is not generated. See Figure 4-2 for typical connections and counter configuration for channel 500 of a counter in slot 5 of the mainframe.

The example program counts the number of gated S1 closures which occur during a one-minute interval and returns the number modulo 5. S1 closures (A input LH transitions) are counted only when S2 is open (B input low).

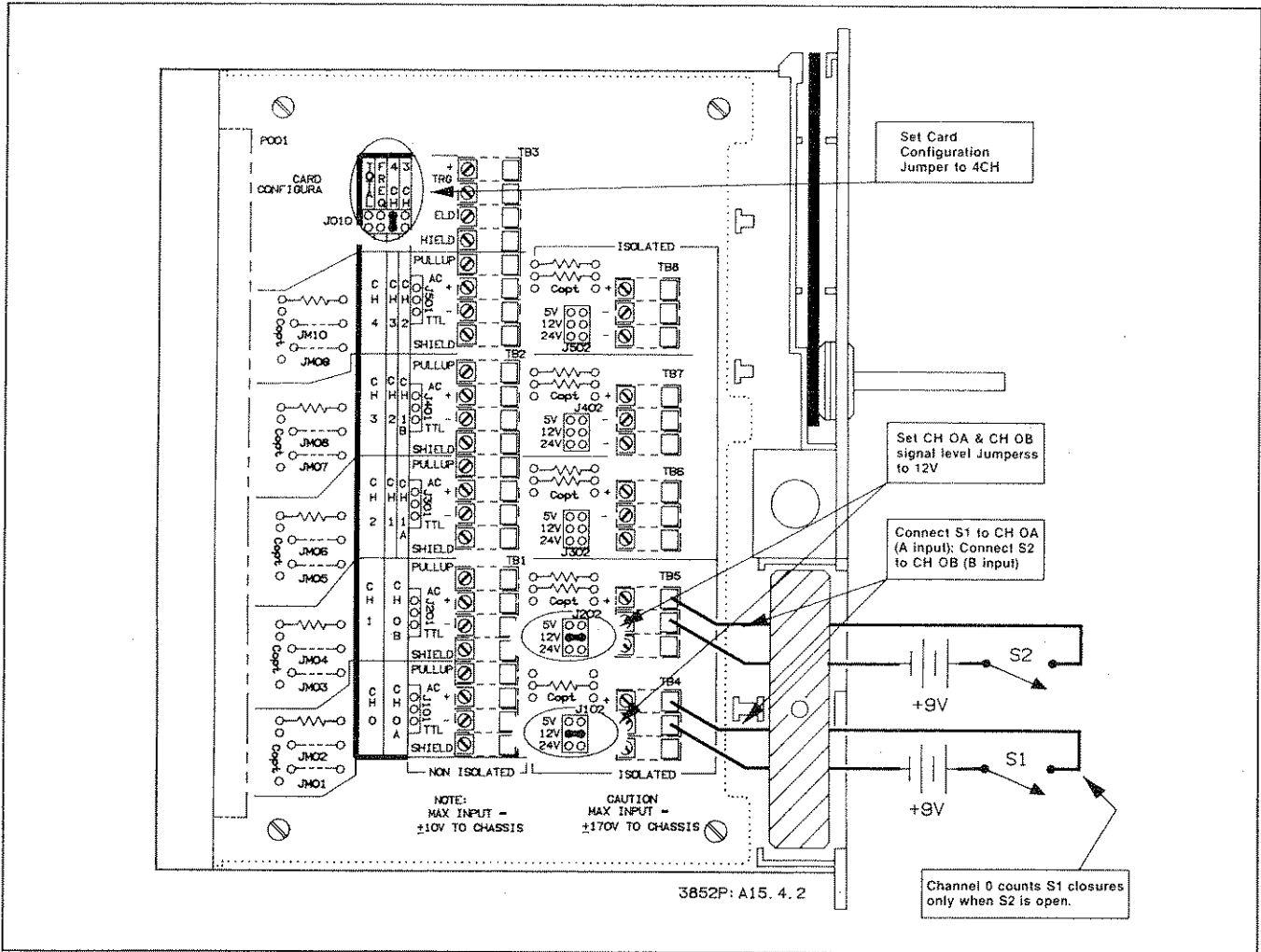

Figure 4-2. Example: Count Switch Closures, Modulo 5

10 OUTPUT 709;"RST 500"	!Reset the counter
20 OUTPUT 709;"USE 500"	!Use channel 500
30 OUTPUT 709;"CONF TOTALM"	!Set TOTALM function
40 OUTPUT 709;"EDGE LH,LO"	!Count S1 LH edges only when S2 open
50 OUTPUT 709;"NPER 5"	!Set modulo 5 count
60 OUTPUT 709;"TRIG SGL"	!Trigger the counter
70 WAIT 60	!Wait one minute
80 OUTPUT 709;"CHREAD 500"	!Read S1 gated closures, modulo 5
90 ENTER 709;A	!Enter S1 closures
100 PRINT "S501 Closures = ";A	!Display S1 closures
110 END	

For example, assume seven S1 closures occurred with S2 open during the one-minute interval. Then, since the count sequence for modulo 5 is 1, 2, 3, 4, 0, 1, 2, ..., the modulo 5 count is 2 and a typical return is:

S501 Closures = 2

Up/Down Counts (UDC/UDCM)

The Up/Down Counts functions include Up/Down Counts (UDC) and Up/Down Counts, Modulo NPER (UDCM). Use the Up/Down Counts functions to measure the difference in counts between two inputs.

With Up/Down Counts, the A input always increases the count, the B input always decreases the count, and the count returned is the difference (A-B) of the the two input counts. Up/Down Counts, Modulo NPER is identical, except that the count resets to zero at the next count after NPER-1 counts, where NPER = 2 to 65535 is set with the NPER command.

Two examples using the Up/Down Counts functions follow. The first example "Count Pulse Rates" counts the difference between the number of counts output from two pulse generators over a 1 minute time interval. The second example "Count Pulse Rates, Modulo 5" does the same thing except that the result is returned modulo 5.

Example: Count Pulse Rates

This program counts the difference between the number of pulses output from pulse generators A and B over a one-minute period. See Figure 4-3 for typical connections and counter configuration for channel 500 of a counter in slot 5 of the mainframe.

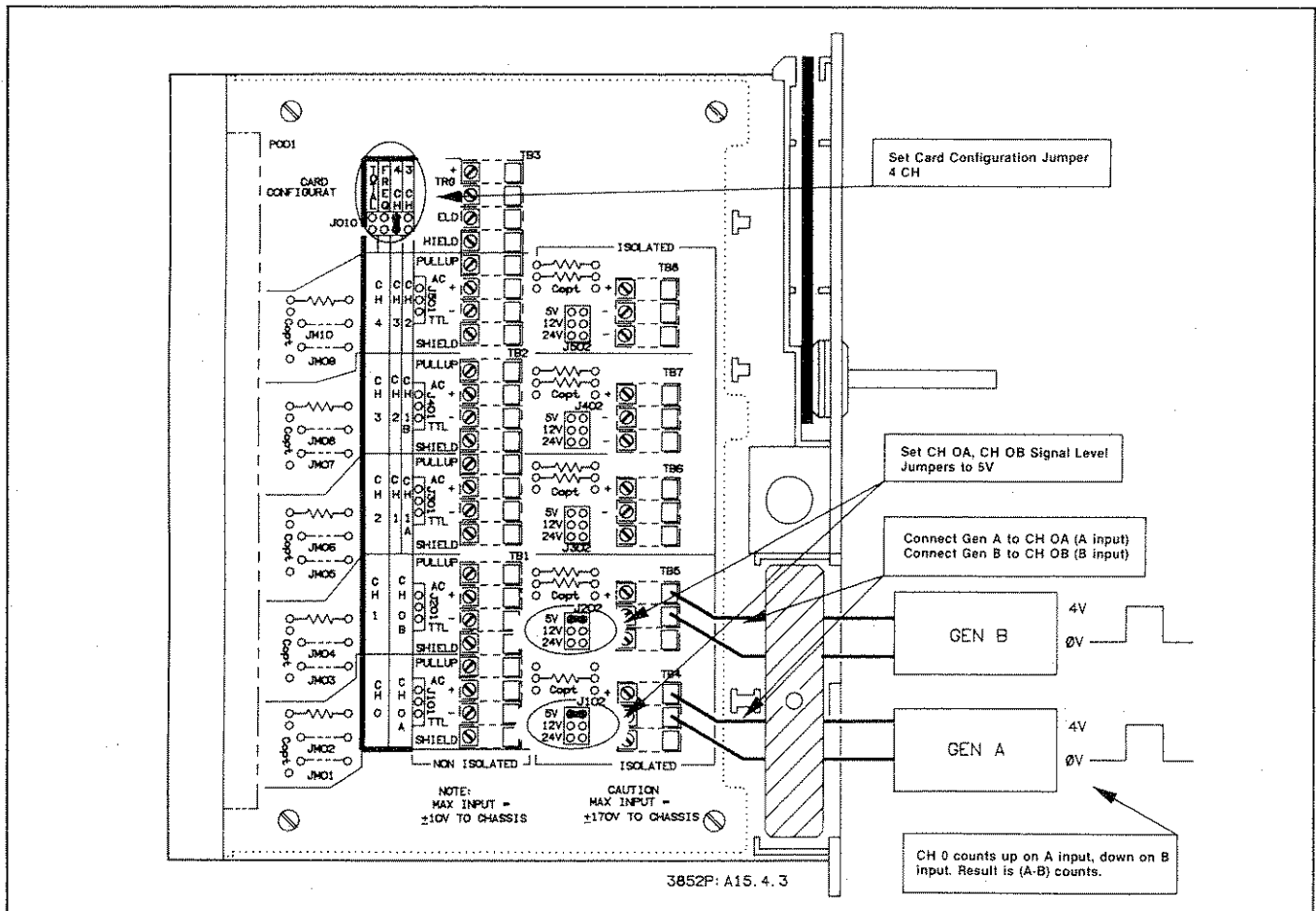

Figure 4-3. Example: Count Pulse Rates

The program sets channel 500 to count up on generator A input LH pulses and to count down on generator B LH input pulses. The program returns the difference (A-B) in the two counts.

```

10 OUTPUT 709;"RST 500"           !Reset counter
20 OUTPUT 709;"USE 500"           !Use channel 500
30 OUTPUT 709;"CONF UDC"         !Set UDC function
40 OUTPUT 709;"EDGE LH,LH"       !Set LH transitions on A and B
50 OUTPUT 709;"TRIG SGL"        !Trigger the counter
60 WAIT 60                        !Wait one minute
70 OUTPUT 709;"CHREAD 500"       !Read ch 500 (A-B) count
80 ENTER 709;A                    !Enter count
90 PRINT "Ch 500 (A-B) Count = ";A !Display count
100 END

```

If, during the one-minute interval, generator A outputs 500 pulses and generator B outputs 700 pulses, a typical return is:

Ch 500 (A-B) Count = -200

**Example: Count
Pulse Rates,
Modulo 5**

This program is the same as the previous program except that the count result is returned modulo 5. As with the previous example, the program counts the difference between the number of pulses output from pulse generators A and B over a one-minute period.

The program counts up on generator A input LH pulses, counts down on generator B input LH pulses, and returns the (A-B) difference, modulo 5. See Figure 4-4 for typical connections and counter configuration to channel 500 of a counter in slot 5 of the mainframe.

```

10 OUTPUT 709;"RST 500"           !Reset counter
20 OUTPUT 709;"USE 500"           !Use channel 500
30 OUTPUT 709;"CONF UDCM"        !Set UDCM function
40 OUTPUT 709;"EDGE LH,LH"       !Set LH transitions on A and B
50 OUTPUT 709;"NPER 5"           !Set modulo 5
60 OUTPUT 709;"TRIG SGL"        !Trigger the counter
70 WAIT 60                        !Wait one minute
80 OUTPUT 709;"CHREAD 500"       !Read ch 500 (A-B) count
90 ENTER 709;A                    !Enter count
100 PRINT "Ch 500 (A-B) Count = ";A !Display count
110 END

```

If, during the one-minute interval, generator A outputs 5 pulses and generator B outputs 12 pulses, the (A-B) difference is -7 counts. However, since the down count sequence for modulo 5 is 4, 3, 2, 1, 0, 4, 3, ..., the modulo 5 difference is 3 and a typical return is:

Ch 500 (A-B) Count = 3

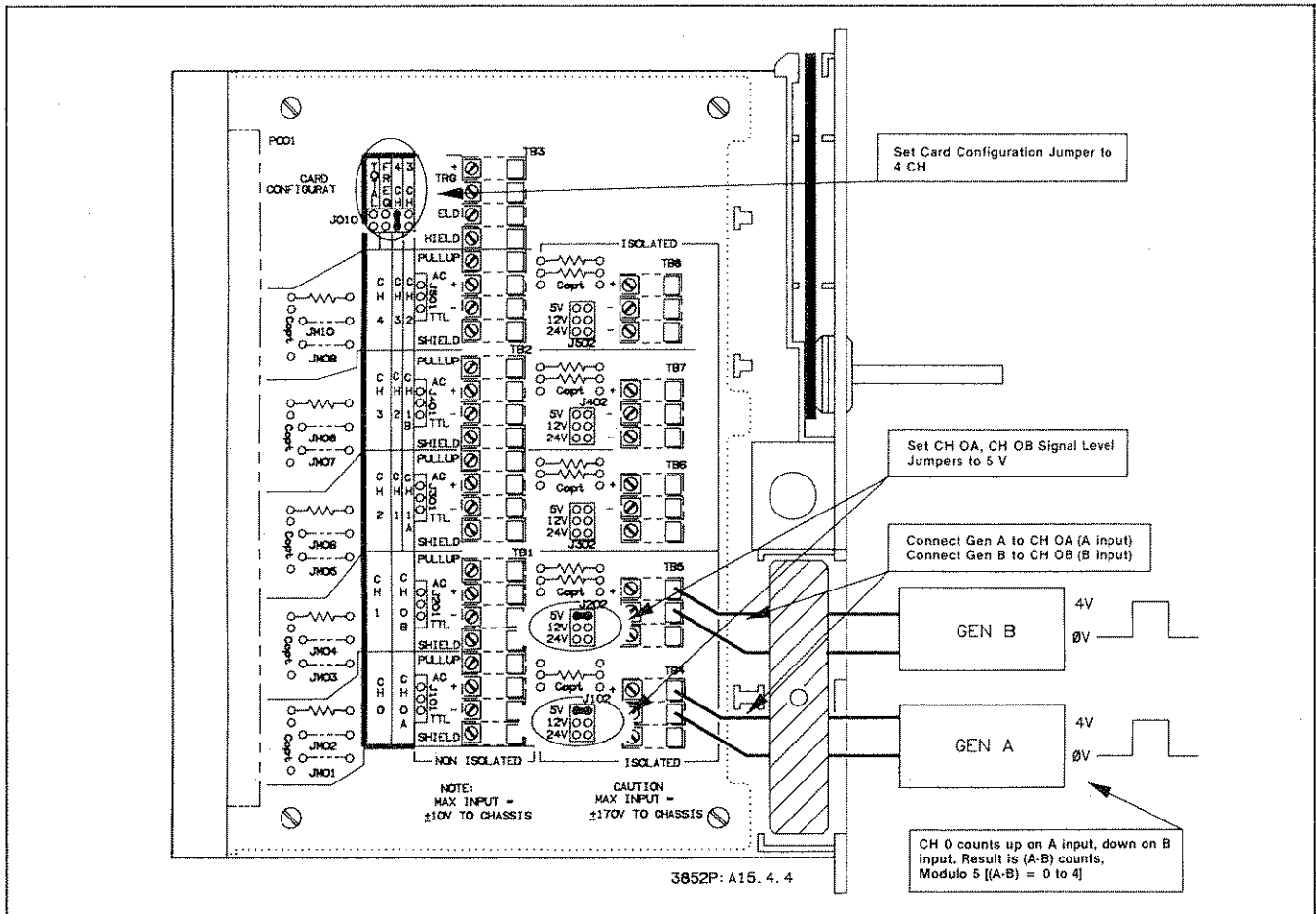

Figure 4-4. Example: Count Pulse Rates, Modulo 5

Count With Direction Control (CD/CDM)

Count With Direction Control functions include Count/Direction (CD), Count/Direction, Modulo NPER (CDM), Quadrature Count (CD), and Quadrature Count, Modulo NPER (CDM).

Use the Count/Direction (CD) function to determine the net number of counts (up counts minus down counts) for an input as controlled by a second input. Use the Count/Direction, Modulo NPER to determine the net number of counts, modulo NPER, where NPER = 2 to 65535 is set with the NPER command. For these functions, the A input is counted up or down, depending on the level of the B input (the gate level).

Quadrature Count (CD) is similar to Count/Direction (CD) except that every transition of the A input is counted and twice the number of counts are returned. Quadrature Count Modulo NPER (CDM) is similar to Count/Direction, Modulo NPER (CDM) except that every transition of the A input is counted and twice the number of counts are returned. For Quadrature Count, the A input is always counted up when the B input leads the A input and is always counted down when A leads B.

Two examples follow which use the CD function to determine a stepper motor shaft position. The first example "Determine Shaft Position" uses Count/Direction to determine the shaft position (CW or CCW) from a reference point. The second example "Determine Shaft Position Using Quadrature" uses Quadrature Count (CD) to more accurately measure the shaft position.

Example: This example uses Count/Direction (CD) to measure the relative number of
Determine CW and CCW rotations of a shaft during a one-minute interval. See Figure
Shaft 4-5 for typical connections and counter configuration for channel 500 of a
Position counter in slot 5 of the mainframe.

We will assume the shaft encoder generates two square wave signals (A and B) which are 90° out of phase with each other. The shaft encoder A signal is used as the A input (count) and the B signal as the B input (direction). Assume that CW rotations of the shaft cause the B input to lead the A input while CCW rotations cause the A input to lead the B input.

Since EDGE LH,HI is set, each step of CW rotation causes an up count (on the A input LH transition) while each CCW step causes a down count (on the A input LH transition). The result is the number of (CW - CCW) steps of shaft rotation.

```
10 OUTPUT 709;"RST 500"           !Reset counter
20 OUTPUT 709;"USE 500"           !Use channel 500
30 OUTPUT 709;"CONF CD"          !Set CD function
40 OUTPUT 709;"EDGE LH,HI"       !Count up for B high, down for B low
50 OUTPUT 709;"TRIG SGL"         !Trigger the counter
60 WAIT 60                        !Wait one minute
70 OUTPUT 709;"CHREAD 500"       !Read ch 500 (up - down) count
80 ENTER 709;A                    !Enter count
90 PRINT "M500 Position = ";A;"Deg" !Display count/message
100 END
```

For example, assume the shaft starting position is 0 degrees and each step represents one degree of rotation. Then, if the shaft makes 10 CW steps and 20 CCW steps, the number of (CW - CCW) steps = -10 and a typical return is:

M500 Position = -10 Deg

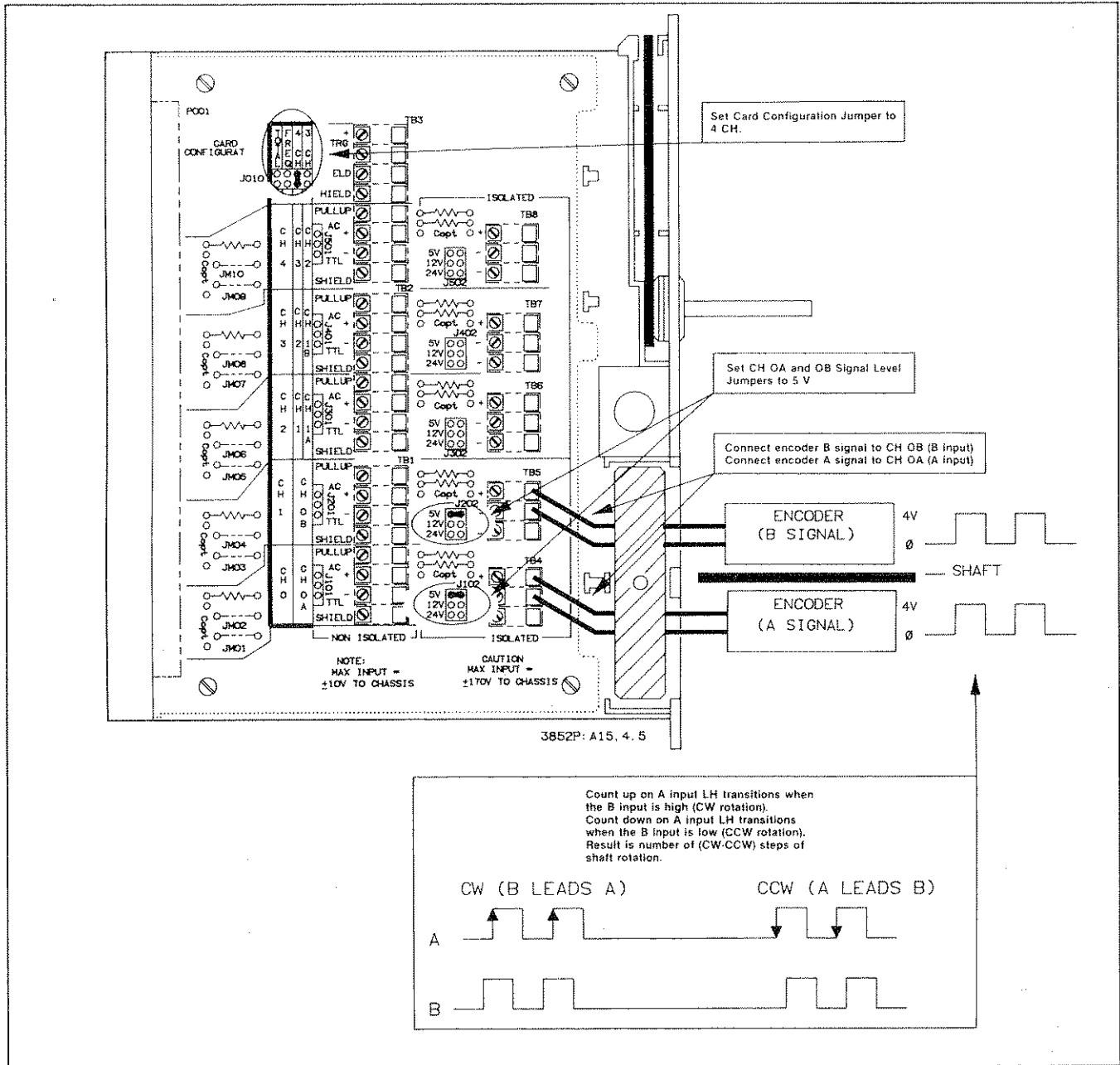

Figure 4-5. Example: Determine Shaft Position

Example: Determine Shaft Position Using Quadrature

In the previous example, we assumed that the shaft had no vibration. However, a problem can occur if the shaft vibrates just enough to change the A signal level without changing the B signal level. With Count/Direction, since only the LH (or HL as programmed) transition of the A input can generate a count, the count may increment without decrementing (or vice-versa) thus giving a false count.

To correct this problem, we will use Quadrature Count to count every transition of the A signal. Then, if the shaft vibrates enough to change the A signal without changing the B signal, the counter will not acknowledge the count and false counts will be eliminated.

This program uses Quadrature Count (CD) to measure shaft position, as in the previous example. Recall that for Quadrature Count, each edge of the A input is counted (up counts when B leads A and down counts when A leads B). Thus, the result must be divided by two to get the actual number of (CW - CCW) shaft rotations.

See Figure 4-6 for typical connections and counter configuration for channel 500 of a counter in slot 5 of the mainframe. Note that the Quadrature jumpers on the component module (J602 and J603 for 4 CH configuration) MUST be set to the Quadrature position. Since the EDGE command has no effect for Quadrature Count, the CONF preset value for EDGE (EDGE HL,HL) is used.

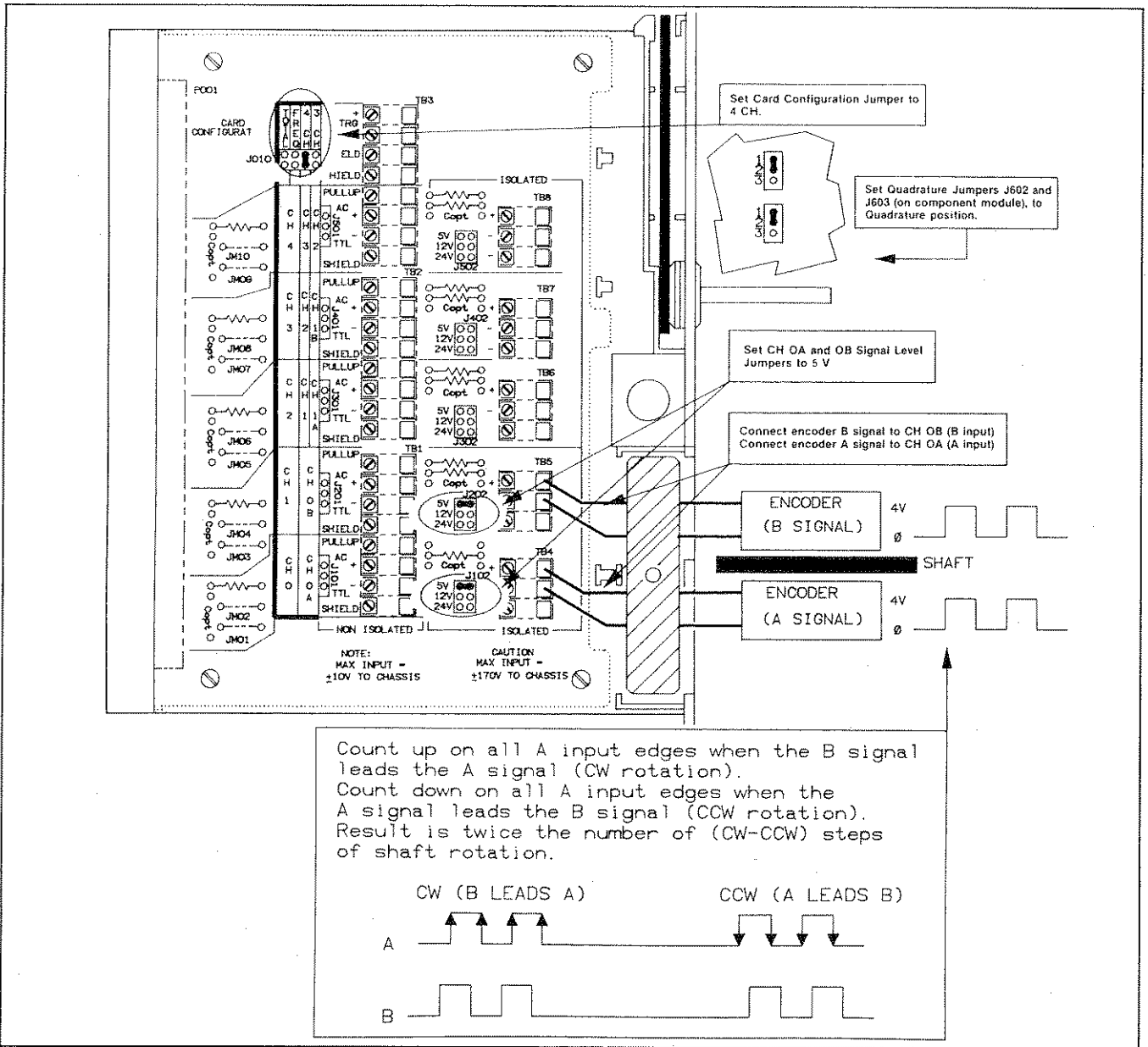

Figure 4-6. Example: Determine Shaft Position Using Quadrature

```

10 OUTPUT 709;"RST 500"           !Reset counter
20 OUTPUT 709;"USE 500"           !Use channel 500
30 OUTPUT 709;"CONF CD"           !Set CD function
40 OUTPUT 709;"TRIG SGL"          !Trigger the counter
50 WAIT 60                         !Wait one minute
60 OUTPUT 709;"CHREAD 500"        !Read ch 500 net count
70 ENTER 709;A                     !Enter count
80 PRINT "M500 Position = ";A/2;"Deg" !Display count/message
90 END

```

For example, assume the shaft starting position is 0 degrees and each step represents one degree of rotation. Then, if the shaft makes 10 CW steps (20 counts on Quadrature Count) and 20 CCW steps (40 counts), a typical return is:

M500 Position = -10 Deg

Ratio Measurements (RAT)

Use Ratio Measurements (RAT) to count the number of periods of the A input for a fixed number of periods of the B input. The result is the ratio of the two inputs (A/B). (That is, the average number of A input periods per B input period.)

Example: Measure Ratio This example program measures the ratio of the number of pulses output from a test pulse generator (A) to 1000 pulses output from a reference pulse generator (B). When the measurement is complete, a MC interrupt is generated and the interrupt time and ratio (A/B) are returned. See Figure 4-7 for typical connections and counter configuration for channel 500 of a counter in slot 5 of the mainframe.

The STA? command reads the Status Register and clears the FPS, LCL, INTR, LMT, and ALRM bits and CLROUT clears the output buffer. SPOLL (709) clears the Status Register service request bit (SRQ bit).

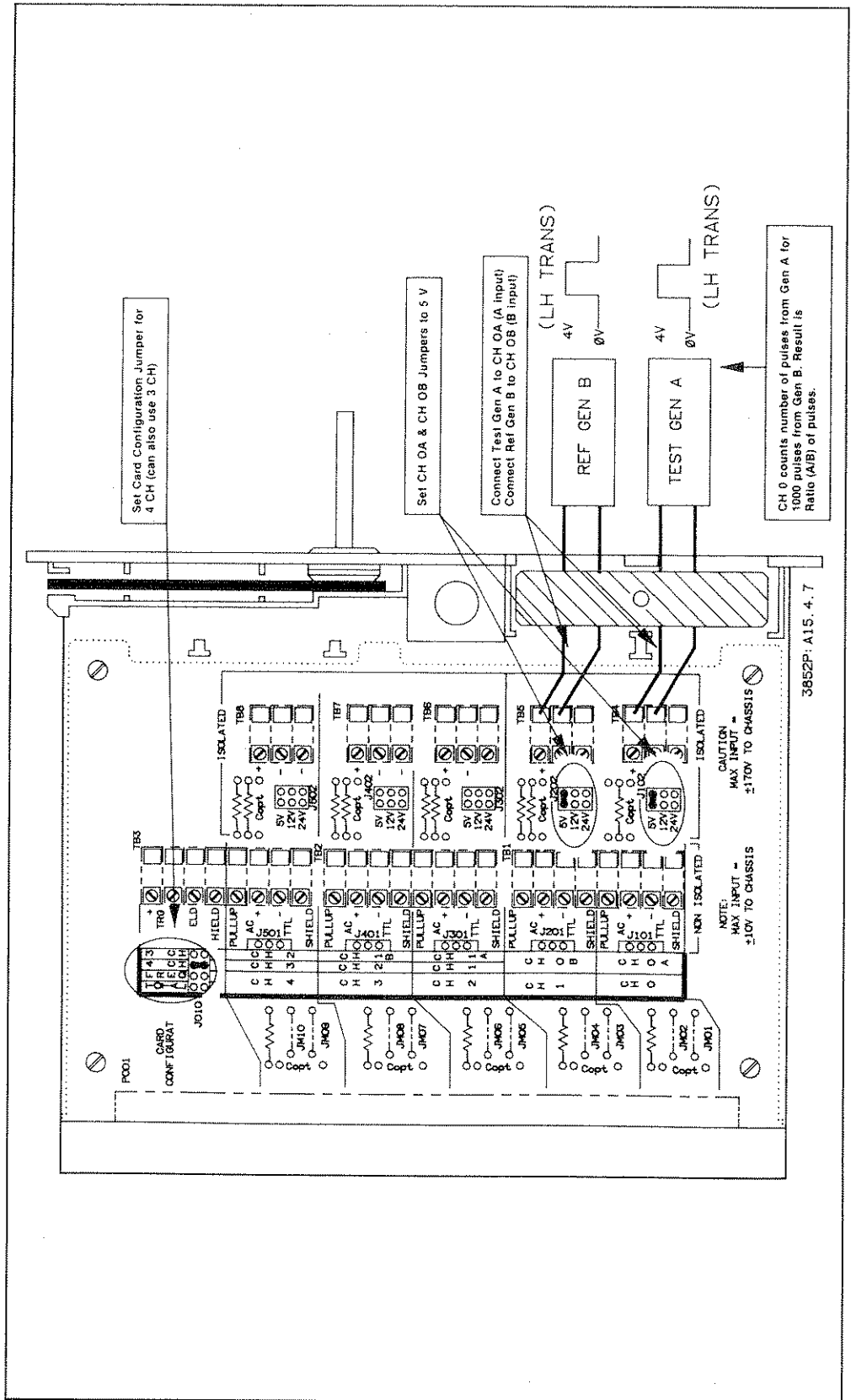

Figure 4-7. Example: Measure Ratio

10 ON INTR 7 GOSUB Results	!Call sub Results on interrupt
20 ENABLE INTR 7;2	!Enable controller intr on SRQ
30 OUTPUT 709;"RST 500"	!Reset the counter
40 OUTPUT 709;"USE 500"	!Use channel 503
50 OUTPUT 709;"RQS INTR"	!Enable RQS Mask Reg INTR bit
60 OUTPUT 709;"RQS ON"	!Set RQS mode ON
70 OUTPUT 709;"CONF RAT"	!Set RAT function
80 OUTPUT 709;"ENABLE INTR SYS"	!Enable mainframe intr capability
90 OUTPUT 709;"ENABLE INTR"	!Enable counter intr capability
100 OUTPUT 709;"STA?"	!Clear FPS,LCL,INTR,LMT,ALRM bits
110 OUTPUT 709;"CLROUT"	!Clear output buffer
120 OUTPUT 709;"EDGE LH,LH"	!Count LH trans on A and B input
130 OUTPUT 709;"NPER 1000"	!End meas after 1000 B periods
140 OUTPUT 709;"TRIG SGL"	!Trigger the counter
150 GOTO 150	!Loop until interrupt occurs
160 Results: !	!Start controller subroutine
170 OUTPUT 709;"TIME"	!Query time of day
180 ENTER 709;T	!Enter time of day
190 PRINT "Ch 500 MC @ ";TIME\$(T)	!Print interrupt time/message
200 OUTPUT 709;"CHREAD 500"	!Read ratio (A/B)
210 ENTER 709;A	!Enter ratio
220 PRINT "Ratio = ";A	!Display ratio
230 A=SPOLL (709)	!Read /clear SRQ bit
240 STOP	!End controller subroutine
250 END	

When the measurement is complete, a typical return for 1500 pulses output from the test generator is:

```
Ch 500 MC @ 02:12:16
Ratio = 1.5
```

Period Measurements (PER/PERD)

Period Measurements functions include Period (PER) and Delayed Period (PERD). Use the Period (PER) function to measure the average period of an input. The result is the average of NPER periods, where NPER = 1 to 65535 is set with the NPER command. Use the Delayed Period (PERD) function to measure the period of the NPERth gated period of an input, where NPER = 1 to 65534.

Two examples using Period Measurement functions follow. The first example "Measure Average Period" uses the PER function to measure the average of 100 periods of the input. The second example "Measure Single Period" uses the PERD function to measure the period of the 100th gated period of the input.

Example: Measure Average Period

This program averages 100 periods of the input. We will assume the signal has maximum period = 1 msec. See Figure 4-8 for typical connections and counter configuration for channel 500 of a counter in slot 5 of the mainframe. Note that the B input is not used, even though Period is a double input function.

In this program, $NPER = 100$ is used to average 100 periods of the input. Also, we will require at least $1 \mu\text{sec}$ of resolution and will set $TBASE \text{ tbase} = 10 \mu\text{sec}$. Then (refer to Table 4-11), $\text{resolution} = (10/NPER) \mu\text{sec} = (10/100) \mu\text{sec} = 0.1 \mu\text{sec}$ and maximum period which can be measured = $(655.35/100) \text{ msec} = 6.5535 \text{ msec}$.

The average frequency can also be calculated by using the reciprocal of the average period measured. This provides a way to compute average frequency which is typically more accurate than using the Frequency Measurement (FREQ) function. Therefore, this program also calculates the average frequency of the input.

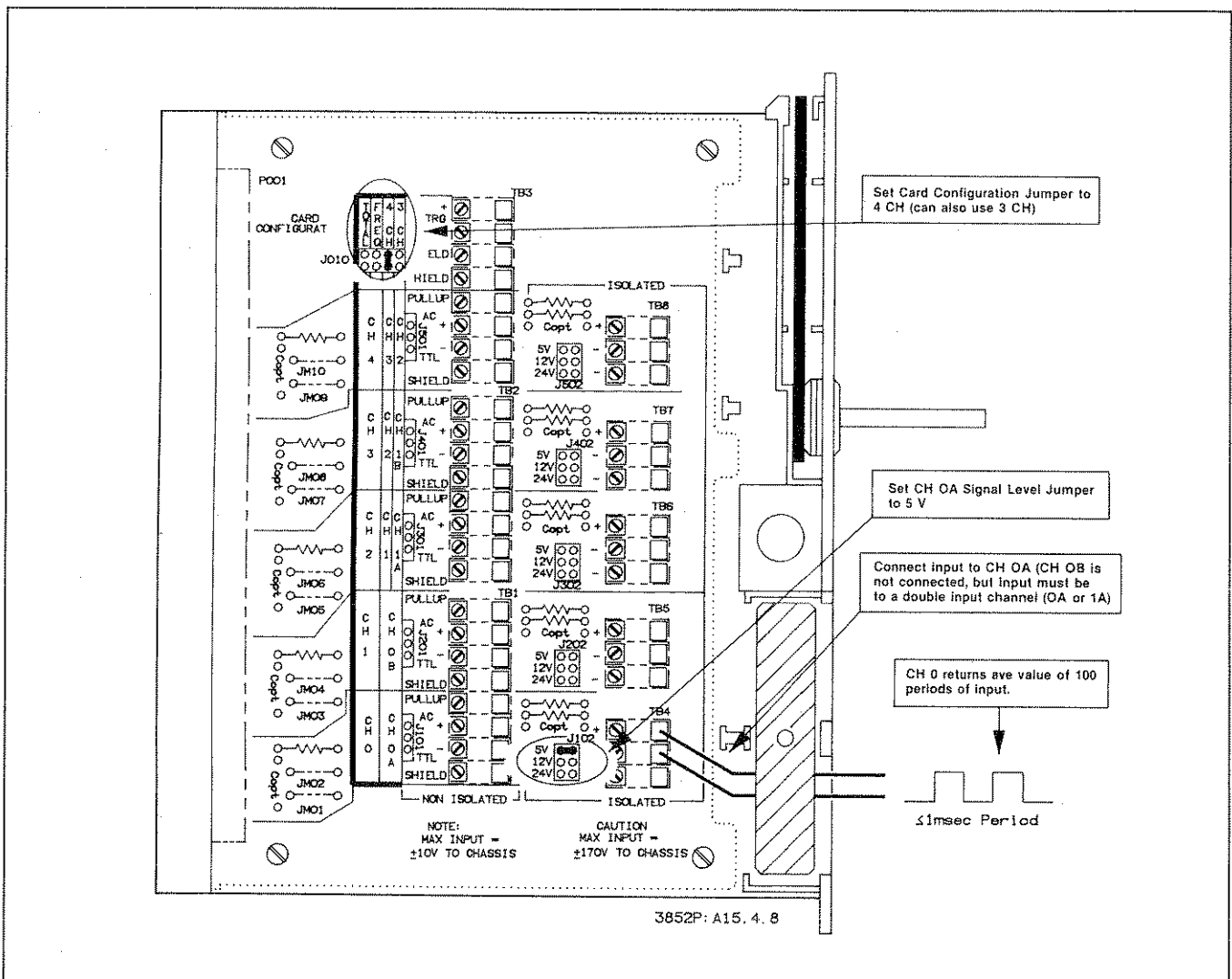

Figure 4-8. Example: Measure Average Period

```

10 OUTPUT 709;"RST 500"           !Reset counter
20 OUTPUT 709;"USE 500"           !Use channel 500
30 OUTPUT 709;"CONF PER"         !Set PER function
40 OUTPUT 709;"EDGE LH"          !Set LH transitions on A input
50 OUTPUT 709;"NPER 100"         !Average 100 periods of input
60 OUTPUT 709;"TBASE .00001"     !Set 10  $\mu$ sec time base
70 OUTPUT 709;"TRIG SGL"         !Trigger the counter
80 OUTPUT 709;"CHREAD 500"       !Read ch 500 avg period
90 ENTER 709;A                    !Enter avg period
100 PRINT "Avg Period = ";A;"sec"  !Display avg period
110 PRINT "Avg Freq = ";1/A;"Hz"   !Display avg frequency
120 END

```

If the average period of the input is 0.995 msec, the average frequency of the input is 1005.02512563 Hz and a typical return (when the measurement completes) is:

```

Avg Period = .000995 sec
Avg Freq = 1005.02512563 Hz

```

Example: Measure Single Period

This program measures the period of an input with maximum period = 10 msec, after 100 gated periods have occurred. See Figure 4-9 for typical connections and counter configuration for channel 500 of a counter in slot 5 of the mainframe.

This program counts A input LH transitions when the B input (gate) is low and measures the period of the 100th gated period of the A input. We will require at least 1 μ sec of resolution and will set TBASE *tbase* = 1 μ sec. Then, resolution = 0.01 μ sec and maximum period which can be measured = 65.535 msec (refer to Table 4-12).

```

10 OUTPUT 709;"RST 500"           !Reset counter
20 OUTPUT 709;"USE 500"           !Use channel 500
30 OUTPUT 709;"CONF PERD"        !Set PERD function
40 OUTPUT 709;"EDGE LH,LO"       !Count LH A input when B input is low
50 OUTPUT 709;"NPER 100"         !Meas 100th gated period of A input
60 OUTPUT 709;"TBASE .000001"    !Set 1  $\mu$ sec time base
70 OUTPUT 709;"TRIG SGL"         !Trigger the counter
80 OUTPUT 709;"CHREAD 500"       !Read 100th gated period value
90 ENTER 709;A                    !Enter period
100 PRINT "Ch 500 Period = ";A;"sec" !Display period
110 END

```

If the value of the 100th gated input period is 9.951 msec, a typical return (when the measurement completes) is:

```

Ch 500 Period = .009951 sec

```

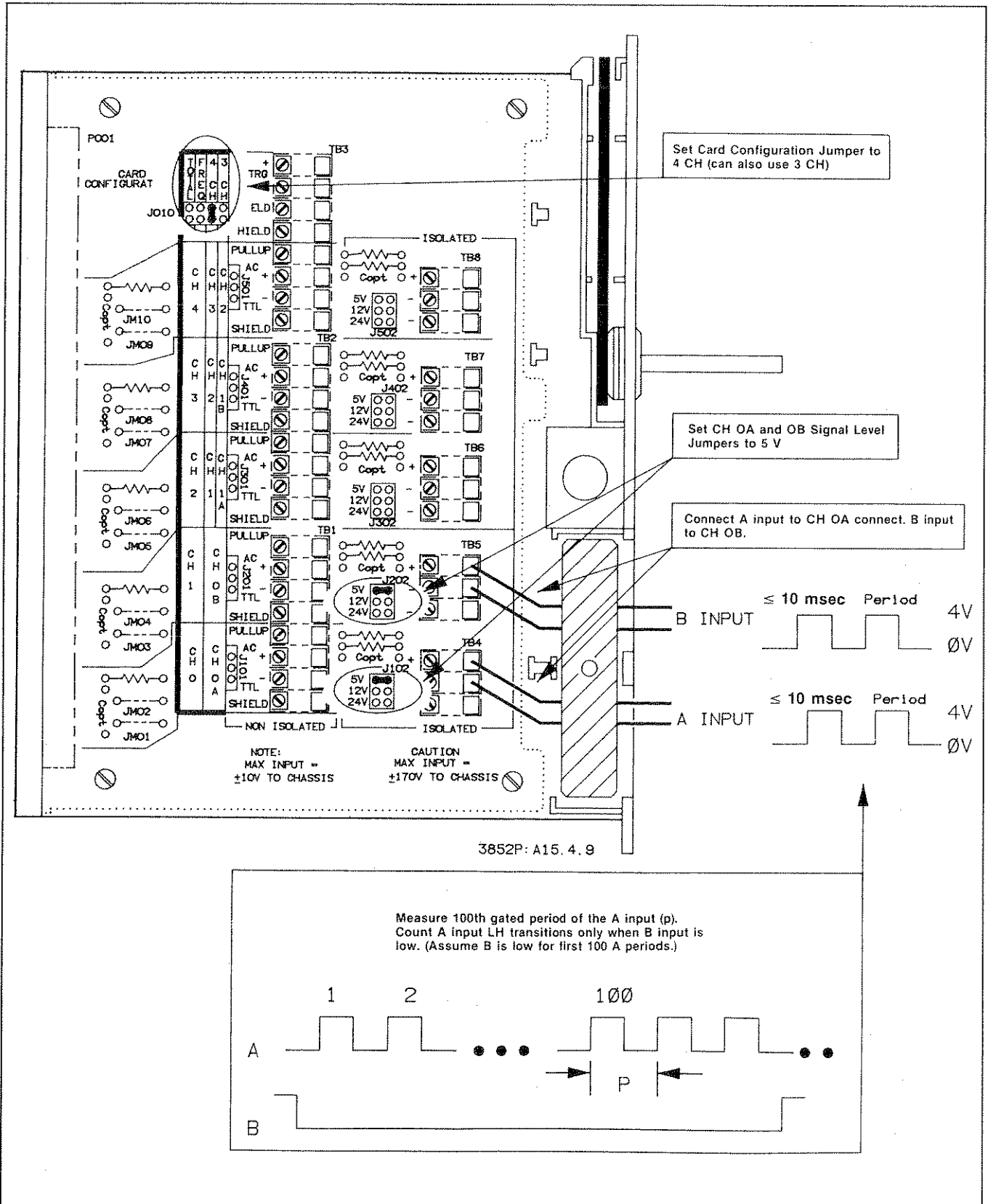

Figure 4-9. Example: Measure Single Period

Frequency Measurements (FREQ)

Use the Frequency Measurements (FREQ) function to measure the average frequency of inputs from >1 Hz up to 200 kHz. An example using the FREQ function follows.

NOTE

The PER function has more resolution and thus is more accurate than the FREQ function for measuring frequency. Refer to "Period Measurements (PER/PERD)" for an example program.

Example: Measure Flow Rate

This program measures the flow rate of a paddlewheel flow meter using magnetic pickup. See Figure 4-10 for typical connections to channel 500 of a counter in slot 5 of the mainframe. Note that the Card Configuration jumper must be set to the FREQ position. With this setting, all five channels measure frequency and no other function can be programmed on any channel. Also note that the input is to the Non Isolated terminals and that the AC/TTL jumper is set to the AC position.

The flow rate can be determined from $\text{rate} = K * f$, where f = the frequency of the magnetic pickup (AC) input and K (in cm) is a constant. For this program we will assume $K = 3.0$ cm and an approximate 100 Hz AC input.

We will require at least 50 Hz resolution, so we will set $TBASE$ $tbase = 100$ msec which will allow the counter to measure a signal from 10 Hz to 200 kHz with 10 Hz resolution (refer to Table 4-13).

```
10 OUTPUT 709;"RST 500"           !Reset counter
20 OUTPUT 709;"USE 500"           !Use channel 500
30 OUTPUT 709;"CONF FREQ"        !Set FREQ function
40 OUTPUT 709;"EDGE LH"          !Count LH A input transitions
50 OUTPUT 709;"TERM NON"         !Set Non Isolated input terminals
60 OUTPUT 709;"TBASE .1"         !Set 100 msec time base
70 OUTPUT 709;"TRIG SGL"         !Trigger the counter
80 OUTPUT 709;"CHREAD 500"       !Read average frequency
90 ENTER 709;A                    !Enter frequency
100 PRINT "Flow Rate (cm/sec) = ";3.0*A !Display flow rate
110 END
```

If the average frequency is 100 Hz, since $K = 3.0$ cm is assumed, a typical return (when the measurement completes) is:

$$\text{Flow Rate (cm/sec)} = 300$$

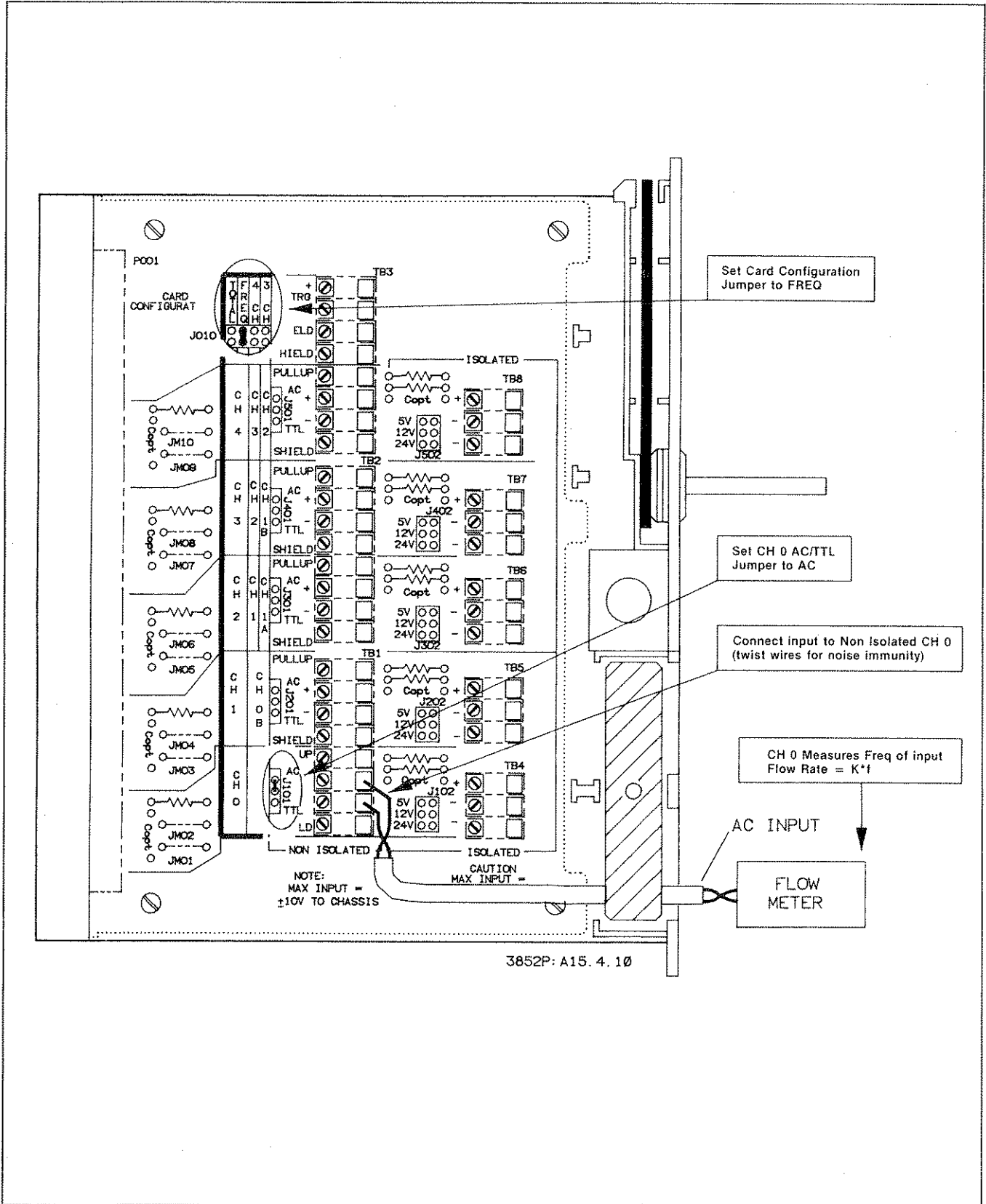

Figure 4-10. Example: Measure Flow Rate

Index

Contents

Index	I-1
-------------	-----

- A**
- AC/TTL jumpers, setting, 3-13
- C**
- Card configuration jumper, setting, 3-4
 - CHREAD, 4-15
 - CHREADZ, 4-16
 - CNTSET, 4-10
 - Command summary, 4-1
 - CONF, 4-4
 - Count/direction (CD), 2-12, 4-25
 - Count/direction, mod NPER, (CDM) 2-13
 - Count sequences, 2-6
 - Counter configuration, 3-3
 - Counter functions,
 - count/direction (CD), 2-12, 4-25
 - count/direction, mod NPER (CDM), 2-13
 - delayed period measurements (PERD), 2-17, 4-31
 - frequency measurements (FREQ), 2-20, 4-35
 - gated total counts (TOTAL), 2-7
 - gated total counts, mod NPER (TOTALM), 2-9
 - period measurements (PER), 2-17, 4-31
 - quadrature count (CD), 2-13, 4-25
 - quadrature count, mod NPER (CDM), 2-16
 - ratio measurements (RAT), 2-16, 4-29
 - ungated total counts (TOTAL), 2-7, 4-19
 - ungated total counts, mod NPER (TOTALM), 2-9, 4-19
 - up/down counts (UDC), 2-11, 4-23
 - up/down counts, mod NPER, (UDCM) 2-11, 4-23
- D**
- Debouncing inputs, 4-12
 - Delayed period (PERD), 2-17, 4-31
 - Description, 1-1
 - DISABLE INTR, 4-17
 - Disabling interrupts, 4-17
- E**
- EDGE, 4-7
 - ENABLE INTR, 4-17
 - Enabling interrupts, 4-17
 - External triggering, connecting, 3-7
- F**
- Field wiring,
 - isolated channels, 3-9
 - non isolated channels, 3-10
 - Frequency measurements (FREQ), 2-20, 4-35
 - FUNC, 4-6
- G**
- Gated total counts (TOTAL), 2-7
 - Gated total counts, mod NPER (TOTALM), 2-9
 - Getting Started, 1-5
- H**
- Hardware triggering, setting, 3-7
- I**
- Input terminals, 3-4, 4-6
 - Installation and checkout, 3-14
 - Interrupts,
 - counter overflow (OVF), 4-17
 - measurement complete (MC), 4-17
 - Introduction, 1-1
 - Isolated channels, configuring,
 - connecting field wiring, 3-9
 - signal conditioning, 3-9
 - signal level jumpers, 3-9
- M**
- Measurement parameters, defining, 2-1
- N**
- Non isolated channels, configuring,
 - AC/TTL jumpers, setting, 3-13
 - signal conditioning, 3-13
 - connecting field wiring, 3-13
 - pullup resistors, using, 3-13
 - NPER, 4-11
 - Number/period, 4-11
- O**
- Operating Modes, 1-3, 3-4
- P**
- Period Measurements (PER), 2-17, 4-31
 - Presets, 4-4, 4-10
 - Programming the counter, 4-1
 - Pullup resistors, using, 3-13
- Q**
- Quadrature count (CD), 2-14, 4-25
 - Quadrature count, mod NPER (CDM), 2-13
 - Quadrature jumpers, setting, 3-5
- R**
- Ranges/resolution, 4-12
 - Ratio measurements (RAT), 2-16, 4-29
- S**
- Sample period, 4-12
 - SPER, 4-12
- T**
- TBASE, 4-12
 - TERM, 4-6
 - Terminal module, 3-3
 - Time base, 4-12
 - TRIG, 4-8
 - Trigger sources, 3-6
- U**
- Ungated total counts (TOTAL), 2-7, 4-19
 - Ungated total counts, mod NPER (TOTALM), 2-9, 4-19
 - Up/down counts (UDC), 2-11, 4-23
 - Up/down counts, mod NPER (UDCM), 2-11, 4-23
- W**
- Warnings, Cautions, and Notes, 3-1
- X**
- XRDGS, 4-16
 - XTRG terminals, using, 3-7

1
2
3
4
5
6
7
8
9
10
11
12
13
14
15
16
17
18
19
20
21
22
23
24
25
26
27
28
29
30
31
32
33
34
35
36
37
38
39
40
41
42
43
44
45
46
47
48
49
50
51
52
53
54
55
56
57
58
59
60
61
62
63
64
65
66
67
68
69
70
71
72
73
74
75
76
77
78
79
80
81
82
83
84
85
86
87
88
89
90
91
92
93
94
95
96
97
98
99
100

44715-90001



Free Manuals Download Website

<http://myh66.com>

<http://usermanuals.us>

<http://www.somanuals.com>

<http://www.4manuals.cc>

<http://www.manual-lib.com>

<http://www.404manual.com>

<http://www.luxmanual.com>

<http://aubethermostatmanual.com>

Golf course search by state

<http://golfingnear.com>

Email search by domain

<http://emailbydomain.com>

Auto manuals search

<http://auto.somanuals.com>

TV manuals search

<http://tv.somanuals.com>