User's Guide

HP 8133A 3 GHz Pulse Generator



HP Part No. 08133-91012
Printed in Germany October 1994

Edition 1.2
E1094

Notice

Copyright

©1993 Hewlett-Packard GmbH.
Herrenberger Str. 130
71034 Böblingen
Federal Republic of Germany

All Rights Reserved.

Reproduction, adaptation or translation without prior written permission is prohibited, except as allowed under the copyright laws.

Warranty

The information contained in this document is subject to change without notice.

Hewlett-Packard makes no warranty of any kind with regard to this material, including, but not limited to, the implied warranties or merchantability and fitness for a particular purpose.

Hewlett-Packard shall not be liable for errors contained herein or for incidental or consequential damages in connection with the furnishing, performance, or use of this material.

Complete product warranty information is given in the User Guide.

Safety

This is a Safety Class 1 instrument (provided with terminal for protective earthing). Before applying power, verify that the correct safety precautions are taken (see the following warnings). In addition, note the external markings on the instrument that are described under **Safety Symbols**.

Warning

Before turning on the instrument, you must connect the protective earth terminal of the instrument to the protective earth conductor of the (mains) power cord. The mains plug must only be inserted in a socket outlet with a protective earth contact. Do not negate the protective action by using an extension power cord without a protective grounding conductor. Grounding one conductor of a two-conductor outlet is not sufficient protection.

Service instructions are for trained service personnel. To avoid dangerous electric shock, do not perform any service unless qualified to do so. Do not attempt internal service or adjustment unless another person, capable of rendering first aid and resuscitation, is present.

If you energize this instrument using an auto-transformer (for voltage reduction) make sure that the common terminal is connected to the earth terminal of the power source.

Whenever it is likely that the ground protection is impaired, you must make the instrument inoperative and secure it against any unintended operation.

Do not operate the instrument in the presence of flammable gases or fumes. Operation of any electrical instrument in such an environment constitutes a definite safety hazard.

Do not install substitute parts or perform any unauthorized modification to the instrument.

Capacitors inside the instrument may retain a charge even if the instrument is disconnected from its source of supply.

Safety Symbols



Instruction Manual symbol: The instrument is marked with this symbol when it is necessary for you to refer to the instruction manual in order to protect against damage to the instrument.



Hazardous voltage symbol.



Earth terminal symbol: used to indicate a circuit common connected to grounded chassis.



Protected conductor symbol

WARNING

The Warning symbol calls attention to a procedure, practice, or the like, which, if not correctly performed or adhered to, could result in personal injury or loss of life. Do not proceed beyond a Warning symbol until the indicated conditions are fully understood and met.

CAUTION

The Caution symbol calls attention to a procedure, practice, or the like, which, if not correctly performed or adhered to, could result in damage to or destruction of part or all of the equipment. Do not proceed beyond a Caution symbol until the indicated conditions are fully understood and met.

Notice

Warranty

This Hewlett-Packard product has a warranty against defects in material and workmanship for a period of one year from date of shipment. During the warranty period, Hewlett-Packard Company will, at its option, either repair or replace products that prove to be defective.

For warranty service or repair, this product must be returned to a service facility designated by Hewlett-Packard. The Buyer shall pay Hewlett-Packard's round-trip travel expenses.

For products returned to Hewlett-Packard for warranty service, the Buyer shall prepay shipping charges to Hewlett-Packard and Hewlett-Packard shall pay shipping charges to return the product to the Buyer. However, the Buyer shall pay all shipping charges, duties and taxes for products returned to Hewlett-Packard from another country.

Hewlett-Packard warrants that its software and firmware designated by Hewlett-Packard for use with an instrument will execute its programming instructions when properly installed on that instrument. Hewlett-Packard does not warrant that the operation of the instrument software, or firmware, will be uninterrupted or error free.

Limitation of Warranty

The foregoing warranty shall not apply to defects resulting from improper or inadequate maintenance by the Buyer, Buyer-supplied software or interfacing, unauthorized modification or misuse, operation outside of the environmental specifications for the product, or improper site preparation or maintenance.

No other warranty is expressed or implied. Hewlett-Packard specifically disclaims the implied warranties of merchantability and fitness for a particular purpose.

Exclusive Remedies

The remedies supplied are the Buyer's sole and exclusive remedies. Hewlett-Packard shall not be liable for any direct, indirect, special, incidental, or consequential damages, whether based on contract, tort or any other legal theory.

Assistance

Product maintenance agreements and other customer assistance agreements are available for Hewlett-Packard products. For any assistance, contact your nearest Hewlett-Packard Sales Office.

Certification

Hewlett-Packard Company certifies that this product met its published specifications at the time of shipment. Hewlett-Packard further certifies that its calibration measurements are traceable to the United States Institute of Standards and Technology, to the extent allowed by the Institute's calibrating facility, and to the calibration facilities of other International Standards Organization members.

About this edition

HP Part Number
08133-91012

Printed in Germany

Edition 1.2 E1094
October 1994

About this book

This book is a guide to operating and programming the HP 8133A 3 GHz Pulse Generator. If you want a tutorial introduction to the instrument refer to the Quick Start Guide.

Installing

Line voltage, fuse and other installation information.

Introducing the HP 8133A

A summary of the instrument options, frontpanel, interchannel timing relationships.

HP 8133A Operating Reference

A reference to all the HP 8133A controls and connectors, grouped as on the instrument.

Using the HP 8133A

How to carry out some common set-up tasks on the HP 8133A. For more detailed tutorial examples, refer to the Quick Start Guide.

HP 8133A Programming Reference

A reference to the HP 8133A Status Model and all supported programming commands.

Testing the HP 8133A

Performance and Verification tests for testing the instrument.

HP 8133A Specifications

The HP 8133A's warranted specifications and other characteristics.

HP 8133A Quick Reference

A summary of the controls and corresponding HP-IB commands, and an overview of the channel features.

Contents

1. Installing the HP 8133A	
Initial Inspection	1-1
Power Requirements and Line Voltage Selection	1-2
Power Requirements	1-2
Selecting the Line Voltage and Replacing the Fuse	1-3
Power Cable	1-4
Ventilation Requirements	1-5
2. Introducing the HP 8133A	
Summary of HP 8133A Models	2-1
HP 8133A	2-1
HP 8133A Option 001	2-1
HP 8133A Option 002	2-1
HP 8133A Option 003	2-1
Frontpanel Overview	2-2
①	2-2
②	2-2
③	2-2
④	2-2
⑤	2-2
⑥	2-2
⑦	2-3
⑧	2-3
⑨	2-3
Active Parameter	2-3
Mode keys	2-3
Parameter keys	2-3
Control keys	2-3
Interchannel Timing relationships	2-4
Using the VERNIER keys	2-5

Summary	2-5
Example - Adjusting the Frequency	2-6

3. HP 8133A Operating Reference

Introduction	3-1
Frontpanel Overview	3-2
①	3-2
②	3-2
③	3-2
④	3-2
⑤	3-2
⑥	3-2
⑦	3-3
⑧	3-3
⑨	3-3
Active Parameter	3-3
Mode keys	3-3
Parameter keys	3-3
Control keys	3-3
MEMOR	3-4
Parameter Keys	3-4
SETTING	3-4
Control Keys	3-5
SAVE	3-5
RECALL	3-5
TIMEBASE	3-6
Mode Keys	3-6
INT/EXT	3-6
Parameter Keys	3-6
EXT DIVIDE	3-6
FREQ/PERIOD	3-7
With Internal Clock	3-7
With External Clock	3-7
External Input	3-7
TRIGGER	3-8
Mode/Parameter Keys	3-8
DIVIDE/BIT 0	3-8
Option 002	3-8
Parameter Keys	3-9
AMPL/HIGH	3-9
Amplitude	3-9

High-level	3-9
OFFS/LOW	3-10
Offset	3-10
Low-level	3-10
Control Keys	3-11
DISABLE	3-11
OUTPUT	3-11
PULSE	3-12
Mode Keys	3-12
PULSE/SQUAR	3-12
Pulse Mode	3-12
Squarewave Mode	3-12
Parameter Keys	3-13
DELAY/PHASE	3-13
Delay	3-13
Phase	3-13
Skew	3-13
WIDTH/DCYC	3-14
Width	3-14
Duty-cycle	3-14
AMPL/HIGH	3-15
Amplitude	3-15
High-level	3-15
OFFS/LOW	3-16
Offset	3-16
Low-level	3-16
Control Keys	3-16
DISABLE	3-16
COMP	3-17
LIMIT	3-17
OUTPUT and OUTPUT	3-17
PULSE/DATA Channel 2 (Option 002)	3-18
Mode/Parameter Keys	3-18
DATA/SQUAR	3-18
Data Mode	3-18
Squarewave Mode	3-18
32 BIT/PRBS	3-19
32 Bit	3-19
PRBS	3-19
Mode Keys	3-19
RZ/NRZ	3-19

Parameter Keys	3-20
<input type="checkbox"/> AMPL/HIGH	3-20
Amplitude	3-20
High-level	3-20
<input type="checkbox"/> OFFS/LOW	3-21
Offset	3-21
Low-level	3-21
Output Mode Keys	3-22
<input type="checkbox"/> DISABLE	3-22
<input type="checkbox"/> DATA	3-22
<input type="checkbox"/> LIMIT	3-22
OUTPUT and $\overline{\text{OUTPUT}}$	3-23
<u>VERNIER</u>	3-24
<u>DATA EDIT</u> (Option 002)	3-25
<input type="checkbox"/> ←ROTATE	3-25
<input type="checkbox"/> ROTATE→	3-25
<input type="checkbox"/> ←CURSOR	3-25
<input type="checkbox"/> CURSOR→	3-25
<input type="checkbox"/> REPEAT	3-25
<input type="checkbox"/> FILL	3-25
<input type="checkbox"/> 0↔1	3-26
<input type="checkbox"/> ⇒1	3-26
<input type="checkbox"/> ⇒0	3-26
HP-IB	3-27
<input type="radio"/> RMT	3-27
<input type="radio"/> ADS	3-27
<input type="radio"/> SRQ	3-27
<input type="checkbox"/> LCL	3-27
In Local mode:	3-27
In Remote mode:	3-27
Special Functions	3-28
Accessing Special Functions	3-28
Temperature Compensation	3-28
ON	3-28
HOLD	3-29
OFF	3-29
Smooth Factor	3-29
Cable Compensation	3-29
Rearpanel	3-30
<input type="checkbox"/> 	3-30

Channel 1 Input & Output	3-30
Channel 2 Input & Output	3-30
Start/Stop PULSE/DATA Input	3-31



Stop	3-32
Start	3-32



.	3-32
Frontpanel Messages	3-33
Invalid Key-press Messages	3-33
Mode Change Messages	3-35
Examples	3-35
Parameter Conflict Messages	3-36
Solving Parameter Conflicts	3-36
Example - Period/Width Conflict	3-36
Example - Output Level Conflict	3-37
Parameter Limit Messages	3-38
Examples	3-38

4. Using the HP 8133A

Introduction	4-1
Adjusting Parameters	4-2
Activating a parameter	4-2
Saving and Recalling Instrument Settings	4-3
Saving the Current Instrument Setting	4-3
Recalling an Instrument Setting	4-3
Recalling the Standard Setting	4-4
Solving Parameter Conflicts	4-6
Example - Period/Width Conflict	4-6
Example - Output Level Conflict	4-6
Setting the Frequency/Period	4-7
Using the Internal Clock	4-7
Using an External Clock	4-8
Setting the Output Levels	4-8
Using Amplitude and Offset	4-9
Using High- and Low-level	4-9
Generating Squarewaves	4-10
Using the TRIGGER Channel	4-10
Synchronized to TIMEBASE	4-10

Synchronized to 32 Bit Data (Option 002)	4-10
Using a PULSE Channel	4-11
Using a PULSE/DATA Channel	4-11
SQUAR mode	4-11
DATA mode	4-12
Generating Non-squarewave Pulses	4-13
Absolute Width	4-13
Fixed Dutycycle	4-14
Varying the Inter-channel Timing	4-15
Absolute Delay	4-15
Fixed Phase	4-16
Skew	4-16
Generating Pseudo-Random Bit Sequences (Option 002)	4-17
Generating Repetitive Pulse Patterns	4-18
Generating a Burst of Pulse Patterns	4-19
Generating a Repetitive Burst of Pulse Patterns	4-20

5. HP 8133A Programming Reference

Common Command Summary IEEE 488.2	5-1
SCPI Command Summary	5-2
Status Model	5-6
Overview	5-6
Condition Register	5-7
Transition Filters	5-7
Event Register	5-7
Enable register	5-8
Status Byte	5-8
Standard Event Status Group	5-9
OPERation Status Group	5-10
QUESTionable Status Groups	5-11
Command Dictionary	5-12
Form	5-12
Parameter	5-12
Parameter Suffix	5-12
Functional Coupling	5-12
Value Coupling	5-12
Range Coupling	5-12
*RST value	5-12
Specified Limits	5-12

Absolute Limits	5-13
Example	5-13
:DIAG:CHANnel[1 2]:CABLEcomp	5-14
:DIAG:CHANnel[1 2]:SMOothshape	5-15
:DIAG:TEmpCAL	5-16
:DIGital[2][:STIMulus]:PATtern[:DATA]	5-17
:DIGital[2][:STIMulus]:SIGNal:FORMat	5-18
:DIGital[2][:STIMulus]:SIGNal:POLarity	5-19
:DISPlay[:WINDow][:STATE]	5-20
:DISPlay[:WINDow]:TEXT[:DATA]	5-21
:MEASure:FREQuency?	5-22
:MEASure:PERiod?	5-23
:MEASure:TEmperature?	5-24
:OUTPut[0 2]:DIVider	5-25
:OUTPut[0]:SOURce	5-27
:OUTPut[0 1 2][:STATE]	5-28
:OUTPut[1 2][:STATE]:NEG	5-29
:OUTPut[1 2][:STATE]:POS	5-30
[:SOURce]:FUNctIon[1 2][:SHApe]	5-31
[:SOURce]:FREQuency[:CW]:FIXed]	5-33
[:SOURce]:PHASe[1 2]	5-34
[:SOURce][:PULSe]:DCYCLe[1 2]	5-35
[:SOURce][:PULSe]:DELay[1 2]	5-36
[:SOURce][:PULSe]:DESKew[1 2]	5-38
[:SOURce][:PULSe]:DHOLD[1 2]	5-39
[:SOURce][:PULSe]:HOLD[1 2]	5-40
[:SOURce][:PULSe]:PERiod	5-41
[:SOURce][:PULSe]:POLarity[1 2]	5-42
[:SOURce][:PULSe]:WIDTh[1 2]	5-43
[:SOURce]:VOLTage[0 1 2][:LEVel][:IMM][:AMPL]	5-44
[:SOURce]:VOLTage[0 1 2][:LEVel][:IMM]:OFFS	5-45
[:SOURce]:VOLTage[0 1 2][:LEVel][:IMM]:HIGH	5-46
[:SOURce]:VOLTage[0 1 2][:LEVel][:IMM]:LOW	5-47
[:SOURce]:VOLTage[1 2]:LIMit[:AMPLitude]?	5-48
[:SOURce]:VOLTage[1 2]:LIMit:OFFSet?	5-49
[:SOURce]:VOLTage[1 2]:LIMit:HIGH?	5-50
[:SOURce]:VOLTage[1 2]:LIMit:LOW?	5-51
[:SOURce]:VOLTage[1 2]:LIMit:STATE	5-52
:STATus:OPERation	5-53

:STATus:PRESet	5-54
:STATus:QUEStionable	5-55
:STATus:QUEStionable:VOLTage	5-57
:STATus:QUEStionable:FREQuency	5-59
:STATus:QUEStionable:MONotony	5-61
:SYSTem:ERRor?	5-64
:SYSTem:KEY	5-65
:SYSTem:PRESet	5-67
:SYSTem:SET	5-68
:SYSTem:VERSIon?	5-69
:TRIGger:ECOUNT	5-70
:TRIGger:SOURce	5-71
:TRIGger[:START]	5-72
:TRIGger:STOP	5-73
SCPI Error Messages	5-74



6. Testing the HP 8133A

Recommended Test Equipment and Accessories	6-2
TIMEBASE	6-3
Tests	6-3
Equipment	6-3
Internal Clock—Low Frequency Performance	6-3
TRIGGER Divider Verification	6-4
External Frequency Counter Performance Low Frequency	6-5
External Divider Verification	6-6
External Frequency Counter Performance High Frequency	6-6
Internal Clock—High Frequency Performance	6-7
TRIGGER	6-9
Tests	6-9
Set-up	6-9
Equipment	6-9
Transition Time Performance	6-9
Risetime	6-10
Falltime	6-12
Dutycycle Verification	6-12
Level Verification	6-12

Outputs	6-13
Tests	6-13
Equipment	6-13
Delay Performance	6-14
Extended Delay Performance	6-17
Inter-Channel Delay Performance (Options 002 & 003 only)	6-19
Width Performance	6-22
Dutycycle Verification	6-25
Level Performance	6-26
Minimum Amplitude	6-26
Maximum Amplitude	6-27
Level Window Performance	6-28
Maximum High-level	6-28
Minimum Low-level	6-28
Overshoot and Ringing Performance	6-29
Transition Time Performance	6-31
Risetime 10-90%	6-31
Risetime 20-80%	6-32
Falltime 20-80%	6-33
Falltime 10-90%	6-33
Jitter Performance	6-34
Data Performance	6-37
32 BIT RZ	6-37
32 BIT NRZ	6-40

7. HP 8133A Specifications

TIMEBASE	7-1
Internal Clock	7-1
External Clock	7-2
External Input	7-2
External Frequency Counter	7-2
External Divide	7-2
TRIGGER	7-3
Timing	7-3
Output Levels	7-3
PULSE and PULSE/DATA	7-4
PULSE Timing (Channel 1 and Option 003 Channel 2)	7-4
PULSE/DATA Timing (Option 002 Channel 2)	7-5

Output Levels	7-6
	7-6
Output Modes	7-6
HP-IB Capabilities	7-7
Additional Features	7-7
Non-volatile Memory	7-7
Rearpanel Connectors	7-8
Channel 1 Input & Output	7-8
	7-8
Channel 2 Input & Output	7-8
Start/Stop Input	7-8
	7-8
General Information	7-9
Operating Environment	7-9
Power Requirements	7-9
Weight	7-9
Dimensions (H x W x D)	7-9
Ventilation Requirements	7-10
Acoustic Noise Emission	7-10
Geräuschemissionswerte	7-10
Recalibration Period	7-10
Declaration of Conformity	7-11
Supplementary Information	7-11

8. HP 8133A Quick Reference

Index

Figures

1-1. Line Voltage Switch Assembly	1-3
1-2. Power Cables - Plug Identification	1-4
2-1. HP 8133A Frontpanel overview	2-2
2-2. HP 8133A Interchannel Timing Diagram	2-4
3-1. HP 8133A Frontpanel overview	3-2
3-2. MEMORY controls	3-4
3-3. TIMEBASE controls	3-6
3-4. TRIGGER controls	3-8
3-5. TRIGGER Output-level limits into 50 Ω	3-9
3-6. PULSE Channel Frontpanel	3-12
3-7. PULSE Output-level limits into 50 Ω	3-15
3-8. PULSE/DATA Channel Frontpanel	3-18
3-9. PULSE/DATA Output-level limits into 50 Ω	3-20
3-10. VERNIER/DATA EDIT keys	3-24
3-11. HP-IB Status Indicators and LCL key.	3-27
3-12. Rearpanel signal-connectors	3-30
3-13. Data Start/Stop Control	3-31
4-1. Output Levels: Amplitude, Offset, High- and Low-levels.	4-9
5-1. HP 8133A Status Groups	5-6
5-2. Component registers in a Status Group	5-7
6-1. Internal Clock Low Frequency Test Set-up	6-3
6-2. External Frequency Counter Low Frequency Test Set-up	6-5
6-3. External Frequency Counter High Frequency Test Set-up	6-6
6-4. Internal Clock High Frequency Test Set-up	6-7
6-5. TRIGGER Transition Time Test Set-up	6-9
6-6. TRIGGER Risettime - 100 ps/div	6-11

6-7. PULSE Channel Delay Test Set-up (Channel 1)	6-14
6-8. Δt_0 : 5.00 ns/div, DELAY = 25.0000 ns	6-16
6-9. Δt_{+5} : 5.00 ns/div, DELAY = 25.0000 ns	6-16
6-10. Δt_{-5} : 5.00 ns/div, DELAY = 25.0000 ns	6-18
6-11. Inter-Channel Delay Test Set-up	6-19
6-12. Δt_{ic} : 1.00 ns/div DELAY = 16.0000 ns	6-20
6-13. Δt_{ic-3} : 1.00 ns/div Delay = 16.0000 ns	6-21
6-14. Δt_{ic+5} : 1.00 ns/div	6-22
6-15. PULSE Channel Width Test Set-up	6-22
6-16. $Width_{max}$: 2.00 ns/div	6-24
6-17. Maximum Amplitude : 500 mV/div	6-27
6-18. Positive Edge Overshoot and Ringing	6-30
6-19. Risetime 10-90%	6-32
6-20. Jitter Histogram	6-36
6-21. PULSE/DATA Channel Data Test Set-up	6-37

Tables

1-1. Line Voltage Ranges	1-2
1-2. Line Voltage and Fuse Selection	1-2
3-1. TIMEBASE Frequency/Period Ranges	3-7
3-2. PULSE Channel Delay Limits	3-13
3-3. HP 8133A Special Functions	3-28
4-1. HP 8133A Standard Settings (Memory 0)	4-5
5-1. HP 8133A IEEE 488.2 Common Command Summary	5-1
5-2. HP 8133A SCPI Command Summary	5-2
5-3. HP 8133A Status Groups - Registers Used	5-8
5-4. Status Byte bits	5-9
5-5. Standard Event Status Group bits	5-9
5-6. OPERATION Status Group bits	5-10
5-7. QUESTIONABLE Status Group bits	5-11
5-8. :SYSTEM:KEY parameter reference	5-66
6-1. Recommended Test Equipment	6-2
6-2. Recommended Accessories	6-2
6-3. Output Test Summary	6-13
8-1. HP 8133A Quick Reference	8-1
8-2. HP 8133A Channel Feature Reference	8-3

Installing the HP 8133A

Initial Inspection

Inspect the shipping container for damage. If the container or cushioning material is damaged, keep it until the contents of the shipment have been checked for completeness and the instrument has been verified both mechanically and electrically.

Warning



To avoid the hazard of electric shock, do not perform electrical tests when there are signs of shipping damage to any part of the instrument's outer covers or panels.

If the contents are incomplete, or there is mechanical damage, or if the instrument does not pass the Performance Tests in Chapter 6, notify the nearest Hewlett-Packard office. Keep the shipping materials for inspection by the carrier. The HP office will arrange for repair or replacement without awaiting settlement.

Power Requirements and Line Voltage Selection

Power Requirements



Caution



BEFORE APPLYING AC LINE POWER TO THE HP 8133A, ensure that the instrument is set to the local line voltage and the correct line fuse is installed in the fuse holder.

The HP 8133A can operate from any single-phase AC power source supplying 100 V, 120 V, 220 V or 240 V in the frequency range from 50 to 60 Hz (see Table 1-1). The maximum power consumption is 250 VA with all options installed.

Table 1-1. Line Voltage Ranges

Selector Voltage	AC Voltage Range
100	90 - 110 V
120	108 - 132 V
220	198 - 242 V
240	216 - 264 V

The line voltage selector is set at the factory to correspond to the most commonly used line voltage of the country of destination. The switch is combined with the power line voltage receptacle on the rear panel. Refer to Table 1-1 for the line voltage ranges and Table 1-2 to set the line voltage and select the appropriate fuse.

Table 1-2. Line Voltage and Fuse Selection

Line Voltage	Fuse Type	HP Part Number
100 V / 120 V	T 3A, 250 V	2110-0029
220 V / 240 V	T 1.5A, 250 V	2110-0304

1-2 Installing the HP 8133A

Selecting the Line Voltage and Replacing the Fuse

1. Remove the power cord.
2. Insert a screwdriver into the recess at the side of the assembly.
3. To change the voltage setting, the selector must be removed and then replaced with the new setting value displayed.
4. If necessary, change the fuse in accordance with the new voltage setting.

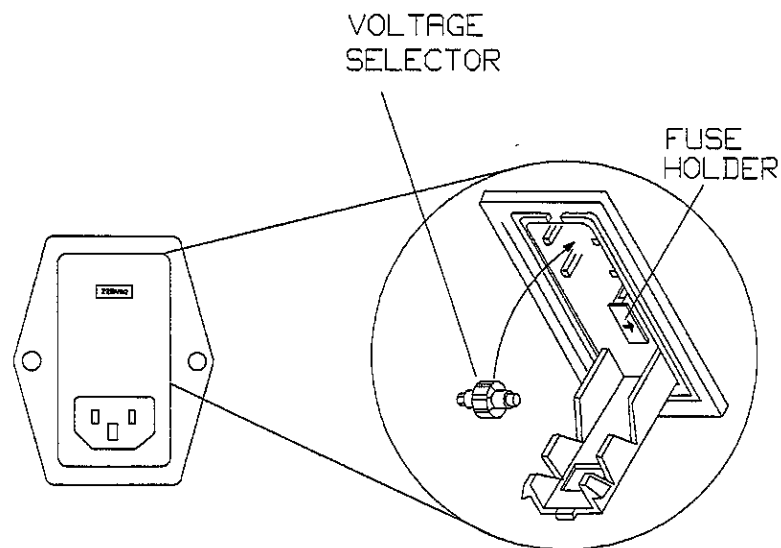

Figure 1-1. Line Voltage Switch Assembly

Power Cable

In accordance with international safety standards, this instrument is equipped with a three-wire power cable. When connected to an appropriate AC power receptacle, this cable grounds the instrument cabinet. The type of power cable shipped with each instrument depends on the country of destination. Refer to Figure 1-2 for the part numbers of the power cables available.

Warning



To avoid the possibility of injury or death, the precautionary Warnings given on the inside front-cover of the manual must be followed before the instrument is switched on.

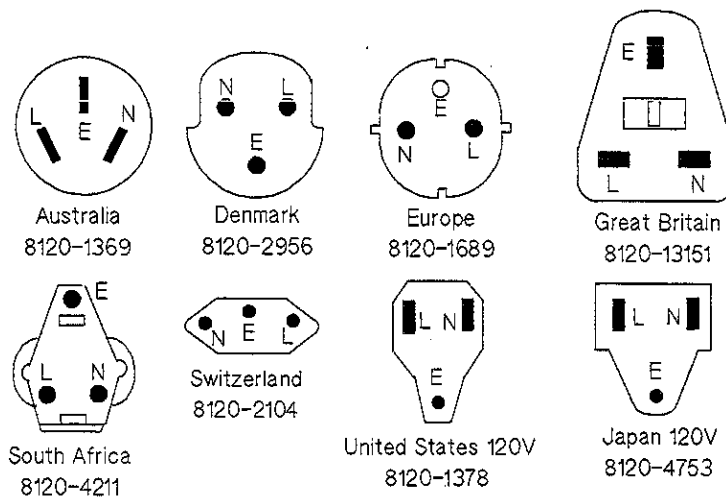

Figure 1-2. Power Cables - Plug Identification

The following work should be carried out by a qualified electrician - all local electrical codes being strictly observed. If the plug on the cable does not fit the power outlet, or the cable is to be attached to a terminal block, cut the cable at the plug end and re-wire it.

The color coding used in the cable will depend on the cable supplied. If a new plug is to be connected, it must

meet local safety requirements and include the following features:

- Adequate load-carrying capacity (see table of specifications).
- Ground connection.
- Cable clamp.

Ventilation Requirements

The HP 8133A is fitted with two cooling fans. Make sure that there is adequate clearance of 3 inches (75 mm) at the rear and 1 inch (25 mm) at the sides to ensure adequate airflow. If the airflow is restricted the internal operating temperature will be higher, reducing the instrument's reliability.

Mounting Hardware

Table 1-3. Mounting Hardware

Item	Part Number
Front Handle Kit	5062-3989
Rack Mount Flange Kit	5062-3977
Front Handle & Flange Kit	5062-3983

Introducing the HP 8133A

Summary of HP 8133A Models

HP 8133A Single-channel 3 GHz Pulse Generator.
Selectable variable delay OR pulse-width.

HP 8133A Option 001

Single-channel 3 GHz Pulse Generator.
Simultaneously variable delay AND pulse-width.

HP 8133A Option 002

Dual-channel 3 GHz Pulse Generator.
Channel 1 same as HP 8133A Option 001
Channel 2 PULSE/DATA Channel:
Selectable: Divided Squarewave
OR 32-Bit programmable data
OR PRBS $2^{23}-1$

HP 8133A Option 003

Dual-Channel 3 GHz Pulse Generator.
Channel 1 same as HP 8133A Option 001
Channel 2 PULSE/DATA Channel:
Selectable: Divided Pulse or Squarewave

Frontpanel Overview

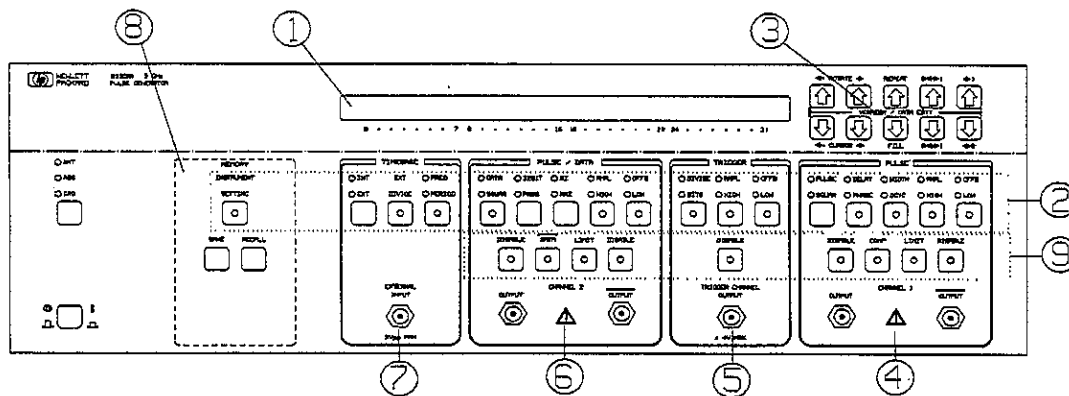

Figure 2-1. HP 8133A Frontpanel overview

- ① The *Display* shows the **active parameter** and one other parameter.
- ② Choose the **active parameter** using the **Mode/Parameter Keys**
- ③ Edit the **active parameter** using the **VERNIER** Keys. The 32 BIT DATA editing functions are indicated in blue (Option 002 only).
- ④ **PULSE** Channel 1 controls and output connectors.
- ⑤ **TRIGGER** Channel controls and output connector.
- ⑥ Optional Channel 2 controls and output connectors. (Option 002 **PULSE/DATA**, Option 003 **PULSE**).

- ⑦ Use the **TIMEBASE** keys to control the instrument frequency.
- ⑧ Use the **MEMORY** keys to save and recall instrument settings.
- ⑨ Use the **Control keys** to control the output modes.

Active Parameter

The active parameter is the parameter which can be adjusted using the **VERNIER** keys. It is the *bright* parameter on the display, and the LED in the **parameter key** is lit.

Mode keys

Mode keys toggle between different operating modes. They are located in the upper row of keys, see Figure 3-1. The LEDs above the key indicate which mode is selected.

Parameter keys

Parameter keys activate a parameter on the display. They are located in the upper row of keys, see Figure 3-1. Press once to activate the selected parameter indicated by the LEDs above the key. Press again to select and activate the alternative parameter. The LED in the key indicates that the parameter is active in the display.

Control keys

Control keys toggle an output mode on or off. They are located in the lower row of keys, see Figure 3-1. The LED in the key is lit when the mode is on.



The maximum external voltage you can apply to the output connectors is $\pm 3V$

Interchannel Timing relationships

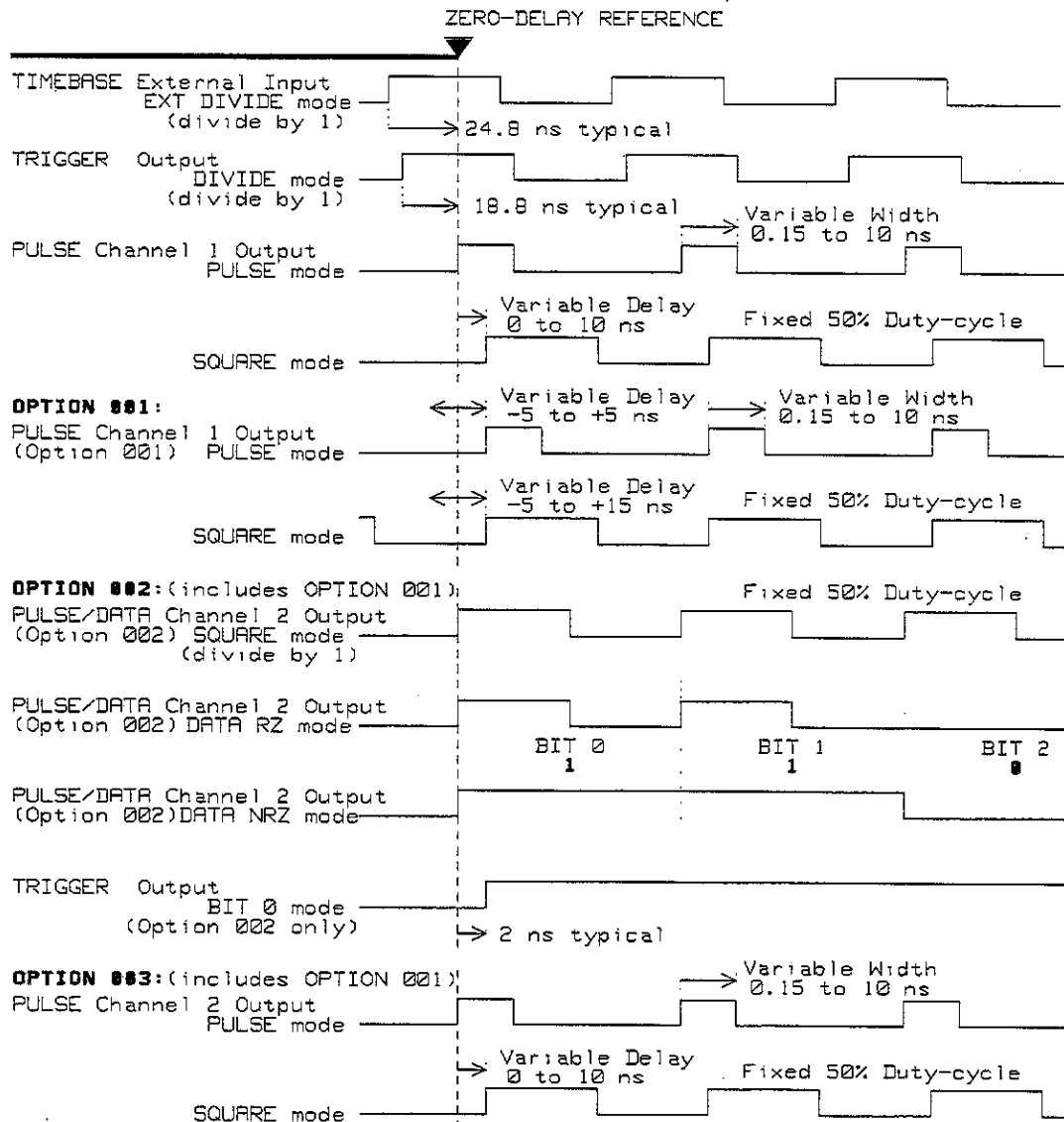
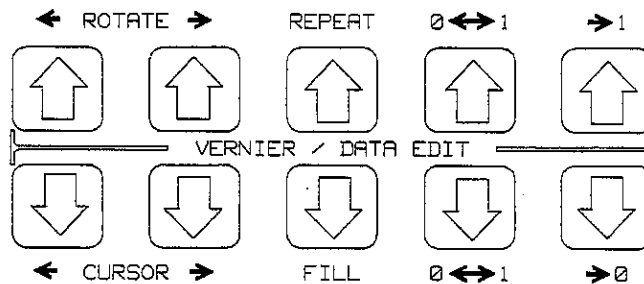

Figure 2-2. HP 8133A Interchannel Timing Diagram

Using the **VERNIER** keys

2



Summary

Use the **VERNIER** keys to adjust the value of the active parameter. Only one parameter can be active at a time, although two may be visible on the display. The active parameter is

- the *bright* parameter on the display.
- indicated by LEDs in and above a **mode/parameter key** (See Figure 2-1).

Each pair of keys controls the corresponding digit of the parameter:

- ⬆ Press once to increment digit by 1
- ⬇ Press once to decrement digit by 1

Hold a key down to auto-repeat and smoothly change a parameter. If you hold two neighbouring keys down, the auto-increment (or decrement) steps at a rate of three times the lower digit.

A decimal-carry operates when you change a digit from 9 to 0 or from 0 to 9. Leading zeroes are not displayed, but the vernier keys can still be used to increase/decrease the "digit". If you try to adjust a parameter outside its valid range, you will see an error message telling you the parameter limit.

2 Example - Adjusting the Frequency

After "Recalling the Standard Setting" in Chapter 4, the display shows the standard Period and Channel 1 Width settings. The Period is the active parameter and appears brighter:

Per 30.303 ns 1:Wid 150 ps

1. Press **TIMEBASE** **FREQ/PERIOD** to activate the Frequency parameter.

The PERIOD LED switches off and the FREQ LED switches on. The LED in the key remains on, indicating that this is still the active parameter. The display now shows the timebase Frequency:

Freq 33.0 MHz 1:Wid 150 ps

2. Use the **VERNIER** keys to increase the timebase Frequency to 1.0000 GHz:

a.

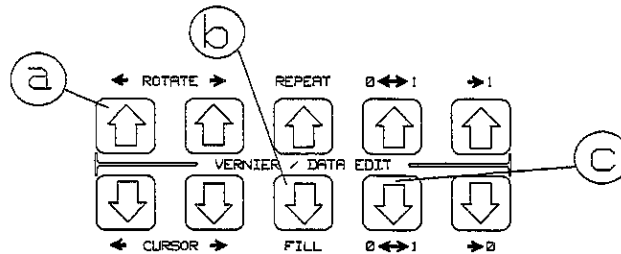

- b. Press the **↑ ↑ ↑ ↑ ↑** key once:
Freq 1.0330 GHz
- c. Press the **↓ ↓ ↓ ↓ ↓** key three times:
Freq 1.0030 GHz
- d. Press the **↓ ↓ ↓ ↓ ↓** key three times:
Freq 1.0000 GHz

HP 8133A Operating Reference

3

Introduction

This chapter is a reference guide to all the HP 8133A controls and connectors. The information is grouped in the following sections:

- Frontpanel Overview
- MEMORY
- TIMEBASE
- TRIGGER
- PULSE
- PULSE/DATA
- VERNIER/DATA EDIT
- HP-IB
- Special Functions
- Rearpanel
- Frontpanel Messages

Frontpanel Overview

Frontpanel Overview

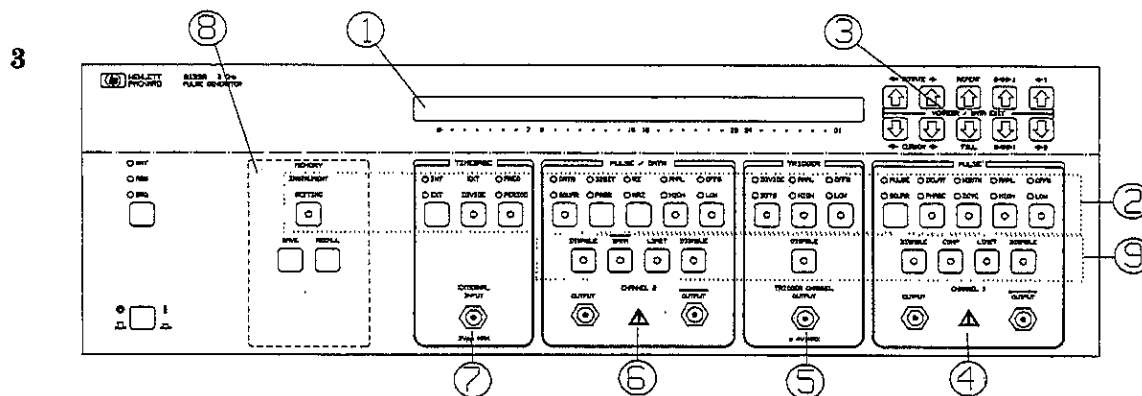

Figure 3-1. HP 8133A Frontpanel overview

- ① The *Display* shows the **active parameter** and one other parameter.
- ② Choose the **active parameter** using the **Mode/Parameter Keys**
- ③ Edit the **active parameter** using the **VERNIER** Keys. The 32 BIT DATA editing functions are indicated in blue (Option 002 only).
- ④ **PULSE** Channel 1 controls and output connectors.
- ⑤ **TRIGGER** Channel controls and output connector.
- ⑥ Optional Channel 2 controls and output connectors. (Option 002 **PULSE/DATA**, Option 003 **PULSE**).

3-2 HP 8133A Operating Reference

Frontpanel Overview

- ⑦ Use the **TIMEBASE** keys to control the instrument frequency.
- ⑧ Use the **MEMORY** keys to save and recall instrument settings.
- ⑨ Use the **Control keys** to control the output modes.

3

Active Parameter The active parameter is the parameter which can be adjusted using the **VERNIER** keys. It is the *bright* parameter on the display, and the LED in the **parameter key** is lit.

Mode keys Mode keys toggle between different operating modes. They are located in the upper row of keys, see Figure 3-1. The LEDs above the key indicate which mode is selected.

Parameter keys Parameter keys activate a parameter on the display. They are located in the upper row of keys, see Figure 3-1. Press once to activate the selected parameter indicated by the LEDs above the key. Press again to select and activate the alternative parameter. The LED in the key indicates that the parameter is active in the display.

Control keys Control keys toggle an output mode on or off. They are located in the lower row of keys, see Figure 3-1. The LED in the key is lit when the mode is on.



The maximum external voltage you can apply to the output connectors is $\pm 3V$

MEMORY

MEMORY

3

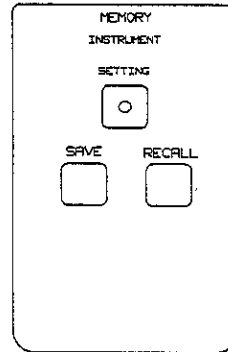

Figure 3-2. MEMORY controls

Parameter Keys

SETTING

Activates the Instrument Setting Memory on the display:

Memory No. 1

Use the **VERNIER** keys to choose the Memory number you want to use. You have access to 20 memories numbered from 1 to 20. In addition, memory number 0 (zero) contains the instrument's Standard Setting (See Table 4-1).

The **SETTING** key also allows you to access some *special functions*. Refer to "Special Functions".

Control Keys

SAVE

Saves the current instrument settings in the chosen memory. You cannot overwrite the Standard Setting (Memory 0).

HP-IB Command:

*SAV <memory>

3

RECALL

Recalls the instrument settings from the chosen memory.

Pressing **RECALL** while the instrument is displaying an error message caused by conflicting or invalid settings, recalls the last valid setting of the instrument.

HP-IB Command:

*RCL <memory>

TIMEBASE

TIMEBASE

3

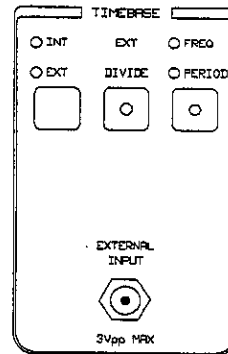

Figure 3-3. TIMEBASE controls

Mode Keys

INT/EXT

Toggles between Internal and External clock signals. The LEDs indicate the selected source.

HP-IB Command:

:TRIGger:SOURCE IMMEDIATE|EXTERNAL

Parameter Keys

EXT DIVIDE

Activates the Divide parameter for the External clock signal. Use the **VERNIER** keys to adjust the divider. The divider can be set to 1, 2, 4, 8, 16, 32, or 64.

HP-IB Command:

:TRIGger:ECOUNT <divider>|MIN|MAX

TIMEBASE**FREQ/PERIOD**

With Internal Clock. Activates the Frequency or Period parameter for the Internal clock. Use the **VERTICAL** keys to adjust the value of the active parameter.

Table 3-1.
TIMEBASE Frequency/Period Ranges

3

	Available	Specified
Frequency:	31.3 MHz to 3.5 GHz	33 MHz to 3 GHz
Period:	286 ps to 31.949 ns	333 ps to 30.303 ns

HP-IB Command:
[:SOURce]:FREQuency[:CW|:FIXed]
<frequency>|MIN|MAX
[:SOURce][:PULSe]:PERiod <period>|MIN|MAX

With External Clock. Displays the measured frequency or period of the External clock signal.

HP-IB Command:
:MEASure:FREQuency?
:MEASure:PERiod?

External Input

You can apply an external clock signal to the External Input:

Frequency Range:	33 MHz to 3 GHz
Input Coupling:	ac-coupled
Impedance:	50 Ω nominal
Minimum Swing:	300 mV, rise-time < 3 ns 0 dBm sinewave
Maximum Amplitude:	3V _{pp} , ± 20 V _{dc}

TRIGGER

TRIGGER

3

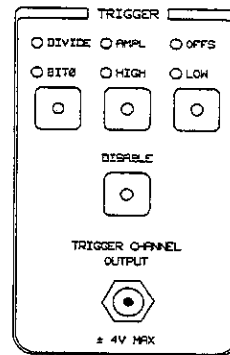

Figure 3-4. TRIGGER controls

Mode/Parameter Keys

DIVIDE/BIT 0

Activates the Trigger Output Divider parameter. Use the **VERNER** keys to adjust the divider. The divider can be set to 1, 2, 4, 8, 16, 32 or 64.

HP-IB Command:

:OUTPut0:DIVider <divider>|MIN|MAX

Option 002. Toggles between Divided trigger mode and Bit 0 trigger mode when Option 002 is fitted (**PULSE/DATA** Channel 2). In Bit 0 mode the trigger signal is a divided-by-32 signal with the rising-edge synchronised to Bit 0 of the 32-bit programmable data on Channel 2. The rising-edge lags Bit 0 by approximately 2 ns, see Figure 2-2.

HP-IB Command:

:OUTPut[0]:SOURce PERiodic|BITstream

Parameter Keys

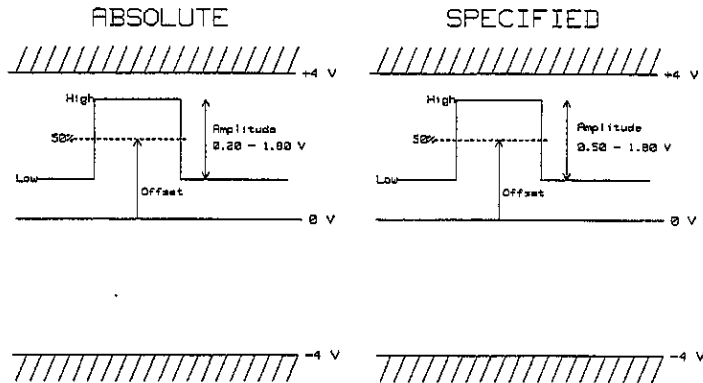

3

Figure 3-5. TRIGGER Output-level limits into 50Ω

AMPL/HIGH

Activates either the Amplitude or High-level parameter. Selecting Amplitude automatically selects Offset on the neighbouring OFFS/LOW key and vice-versa. Selecting High-level automatically selects Low-level on the neighbouring OFFS/LOW key and vice-versa. Use the VERNIER keys to adjust the value of the active parameter.

Amplitude. The available Amplitude range is always limited by the actual Offset setting and the Output-level window of ±4 V. Refer to Figure 3-5. Note that the absolute Amplitude limits are greater than the specified limits.

$$\text{Amplitude} = \text{High} - \text{Low}$$

HP-IB Command:

[[:SOURce]:VOLTage0[:LEVel]][:IMMediate]][:AMPLitude] <amplitude>|MIN|MAX

High-level. The available High-level range at any time is limited by the actual Low-level setting, the Amplitude limits and the Output-level window of ±4 V. Refer to

TRIGGER

Control Keys

DISABLE

Disables the signal by disconnecting the output-connector using an internal relay. The LED in the key indicates whether Disable is on or off.

HP-IB Command:

:OUTPut0[:STATE] ON|OFF|1|0

3

OUTPUT

Programmed output levels assume a 50 Ω load, the Offset voltage doubles into open circuits.

PULSE

PULSE

3

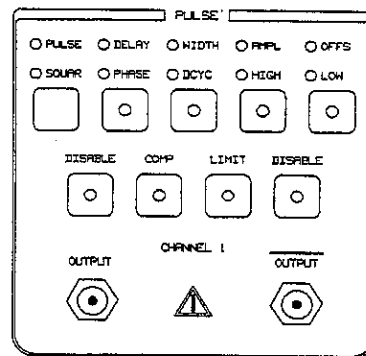

Figure 3-6. PULSE Channel Frontpanel

Mode Keys

PULSE/SQUAR

Toggles the Channel between Squarewave mode and Pulse mode. The LEDs indicate the selected mode.

HP-IB Command:

`[[:SOURCE]:FUNCTION[1|2] [:SHAPe] PULSE|SQUare`

Pulse Mode.

- Variable pulse Width
(150 ps - (Period - 150 ps), max 10 ns).
- Variable Channel 1 Delay (-5 - +5 ns) for Option 001, 002 or 003 instruments.
- Variable Output-levels

Squarewave Mode.

- Fixed pulse Width (50% Duty-cycle nominal).
- Variable Delay (0 - 10 ns) for Channel 1 or Option 003 Channel 2.
- Increased Channel 1 Delay (-5 - +15 ns) for Option 001, 002 or 003 instruments.
- Variable Output-levels

Parameter Keys

DELAY/PHASE

Activates the absolute Delay parameter or relative Phase parameter or absolute Skew parameter. Use the **VERNIER** keys to adjust the value of the active parameter.

Delay. You can vary the absolute Delay parameter for a **PULSE** channel within the following ranges, depending on Channel mode and installed options:

3

Table 3-2. **PULSE** Channel Delay Limits

	PULSE mode		SQUARe mode	
	Available	Specified	Available	Specified
Channel 1	x	x	0.000 - 10.000 ns	0.000 - 10.000 ns
Channel 1 Opt 001 Opt 002 or Opt 003	-5.200 - +5.200 ns	-5.000 - +5.000 ns	-5.200 - +15.000 ns	-5.000 - +15.000 ns
Channel 2 Opt 003	x	x	0.000 - 10.000 ns	0.000 - 10.000 ns

Use Delay if you want to maintain a constant Delay independent of Frequency/Period.

HP-IB Command:

[:SOURce] [:PULSe] :DELay [1 | 2] <delay> | MIN | MAX

Phase. You can also delay the **PULSE** channel signal using the relative Phase parameter. The Phase parameter has an arbitrary limit of 3600° but the actual range available depends on both the Delay ranges and the Period parameter. Use Phase if you want to maintain a constant Phase delay while varying the Frequency/Period.

HP-IB Command:

[:SOURce] :PHASe [1 | 2] <phase> | MIN | MAX

Skew. The available delay range can be divided between the Skew parameter and Delay/Phase parameter. Use the Skew parameter to move the zero-point of the Delay/Phase parameters. This allows you, for example, to move the zero-delay reference to account for different signal-path lengths to your device-under-test.

PULSE

3

HP-IB Command:

[:SOURce] [:PULSE] :DESKew [1 | 2] <deskeW> | MIN | MAX

WIDTH/DCYC

Activates the absolute Width parameter or relative Duty-cycle parameter. Use the **VERTICAL** keys to adjust the value of the active parameter. Width and Duty-cycle cannot be varied in SQUAREwave mode.

Width. You can vary the pulse Width parameter for a **PULSE** channel within the range 150 ps to (Period - 150 ps), up to a maximum limit of 10.000 ns. Use Width if you want to maintain a constant pulse Width independent of frequency.

HP-IB Command:

[:SOURce] [:PULSe] :WIDTh [1 | 2] <widTh> | MIN | MAX

Duty-cycle. You can vary the Duty-cycle within the arbitrary range 0 – 100%. 0% and 100% set dc-levels at the output. The actual Duty-cycle range is dependent on the Width range and the Frequency/Period parameter. Use Duty-cycle if you want to maintain a constant duty-cycle while varying the Frequency/Period.

HP-IB Command:

[:SOURce] [:PULSe] :DCYClE [1 | 2] <duTy-cycle> | MIN | MAX

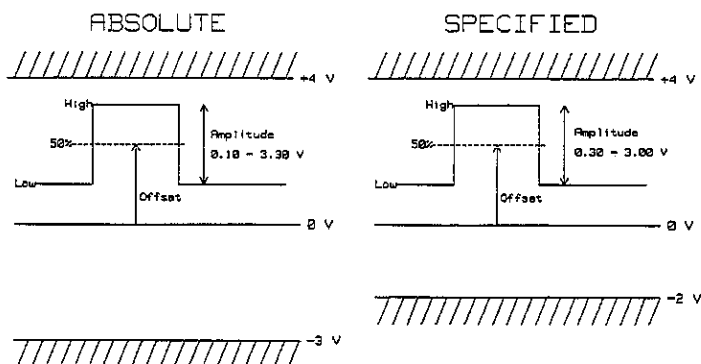

3

Figure 3-7. PULSE Output-level limits into 50 Ω

AMPL/HIGH

Activates either the Amplitude or High-level parameter. Selecting Amplitude automatically selects Offset on the neighbouring **OFFS/LOW** key and vice-versa. Selecting High-level automatically selects Low-level on the neighbouring **OFFS/LOW** key and vice-versa. Use the **VERNIER** keys to adjust the value of the active parameter.

Amplitude. The available Amplitude range is limited by the actual Offset setting, the Amplitude limits and the Output-level window. Refer to Figure 3-7. Note that the absolute Amplitude and window limits are greater than the specified limits.

$$\text{Amplitude} = \text{High} - \text{Low}$$

HP-IB Command:

`[[:SOURCE]:VOLTage[1|2][[:LEVEL][[:IMMEDIATE][[:AMPLitude] <amplitude>|MIN|MAX`

High-level. The available High-level range is limited by the actual Low-level setting, the Amplitude limits and the Output-level window. Refer to Figure 3-7. Note that the absolute Amplitude and window limits are greater than the specified limits.

PULSE

HP-IB Command:

[[:SOURCE]:VOLTage[1|2][:LEVEL][:IMMEDIATE]:HIGH <high-level>|MIN|MAX

OFFS/LOW

3

Activates either the Offset or Low-level parameter. Selecting Offset automatically selects Amplitude on the neighbouring **AMPL/HIGH** key and vice-versa. Selecting Low-level automatically selects High-level on the neighbouring **AMPL/HIGH** key and vice-versa. Use the **VERNIER** keys to adjust the value of the active parameter.

Offset. The available Offset range is limited by the actual Amplitude setting and the Output-level window. Refer to Figure 3-7. Note that the absolute Amplitude and window limits are greater than the specified limits.

$$\text{Offset} = \frac{\text{High} - \text{Low}}{2}$$

HP-IB Command:

[[:SOURCE]:VOLTage[1|2][:LEVEL][:IMMEDIATE]:OFFset <offset>|MIN|MAX

Low-level. The available Low-level range is limited by the actual High-level setting, the Amplitude limits and the Output-level window. Refer to Figure 3-7. Note that the absolute Amplitude and window limits are greater than the specified limits.

HP-IB Command:

[[:SOURCE]:VOLTage[1|2][:LEVEL][:IMMEDIATE]:LOW <low-level>|MIN|MAX

Control Keys

DISABLE

Disables the signal by disconnecting the output-connector using an internal relay. The LED in the key indicates whether Disable is on or off. Each **DISABLE** key controls the connector directly below itself.

PULSE

HP-IB Command:
:OUTPut[1|2][:STATE] ON|OFF|1|0

COMP

Complements the output signal. The LED in the key indicates whether Complement mode is on or off.

3

HP-IB Command:
[:SOURCE][:PULSe]:POLarity[1|2] NORMAl|COMPliment

LIMIT

Limits the output-level voltage window. When you switch on the Limit mode the current High- and Low-level parameters are taken as limit values. You cannot move the output-levels beyond these temporary limits, until you switch off limited-output mode by pressing **LIMIT** again. The limits apply whether you set High/Low levels or Amplitude/Offset levels.

HP-IB Command:
[:SOURCE]:VOLTage[1|2]:LIMit:STATe ON|OFF|1|0

OUTPUT and OUTPUT

50 Ω (nominal) differential SMA outputs with typically < 20 ps inter-output skew.



Maximum external voltage ± 3 V.

Note



Programmed output-levels assume a 50 Ω load.
Output-levels double into open circuits.

PULSE/DATA Channel 2 (Option 002)

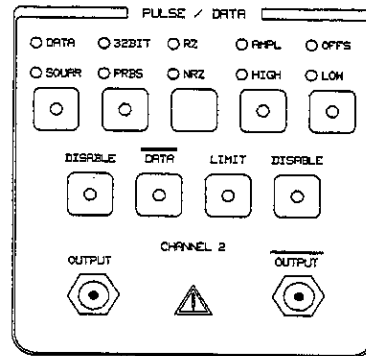

Figure 3-8. PULSE/DATA Channel Frontpanel

Mode/Parameter Keys

DATA/SQUAR

Toggles the Channel between Data mode and Squarewave mode. The LEDs indicate the selected mode. In Squarewave mode the Divider parameter is activated.

HP-IB Command:

```
[[:SOURCE]:FUNCTION2[:SHAPE] SQUARE|DATA|PRBS|BURSt,<number>|RBURst,<number1>,<number2>
```

Data Mode.

- Selectable:
 - 32 BIT programmable data
 - PRBS sequence $2^{23}-1$
 - RZ/NRZ data format
- Variable Output-levels
- Burst modes programmable via HP-IB

Squarewave Mode.

- Fixed pulse Width (50% Duty-cycle nominal).
- Variable Frequency Divider (1,2,4,8,16,32)
- Variable Output-levels

32 BIT/PRBS

In Data mode, toggles between 32 Bit programmable data and Psuedo-Random-Bit-Sequence ($2^{23}-1$). The LEDs indicate the selected mode. If Data mode is selected and both Leds are off, this indicates that BURST or RBURST mode has been selected via the HP-IB.

HP-IB Command:

```
[ :SOURCE ] :FUNCTION2 [ :SHAPE ] SQUARE | DATA | PRBS | BURSt, <number> | RBURst, <number1>, <number2>
```

32 Bit. Use the **DATA EDIT** keys to edit the 32 Bit data sequence. The **VERNIER** keys perform **DATA EDIT** functions only when 32 Bit Data mode is selected and the 32 Bit data is the active parameter on the display. Refer to "**DATA EDIT** (Option 002)".

PRBS. When PRBS Data mode is selected, the Channel generates a Psuedo-Random-Bit-Sequence $2^{23}-1$ conforming to CCITT 0.151 Norm. There is no adjustable parameter associated with PRBS.

Note

To ensure conformance to CCITT 0.151 make sure that you select NRZ format and that **DATA** mode is off.

Mode Keys**RZ/NRZ**

In Data modes, toggles between NRZ and RZ data formats. The LEDs indicate the actual format.

HP-IB Command:

```
:DIGital12 [ :STIMulus ] :SIGnal :FORMat RZ | NRZ
```

PULSE/DATA

Parameter Keys

3

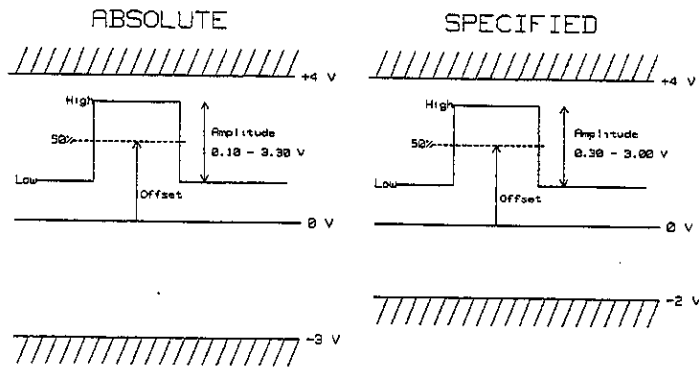

Figure 3-9. PULSE/DATA Output-level limits into 50 Ω

AMPL/HIGH

Activates either the Amplitude or High-level parameter. Selecting Amplitude automatically selects Offset on the neighbouring (OFFS/LOW) key and vice-versa. Selecting High-level automatically selects Low-level on the neighbouring (OFFS/LOW) key and vice-versa. Use the VERNIER keys to adjust the value of the active parameter.

Amplitude. The available Amplitude range is limited by the actual Offset setting, the Amplitude limits and the Output-level window. Refer to Figure 3-9. Note that the absolute Amplitude and window limits are greater than the specified limits.

$$\text{Amplitude} = \text{High} - \text{Low}$$

HP-IB Command:

```
[[:SOURce]:VOLTage2[:LEVel][:IMMediate][:AMPLitude] <amplitude>|MIN|MAX
```

High-level. The available High-level range is limited by the actual Low-level setting, the Amplitude limits and the Output-level window. Refer to Figure 3-9. Note that the

absolute Amplitude and window limits are greater than the specified limits.

HP-IB Command:

[[:SOURCE]:VOLTage2[:LEVEL][:IMMEDIATE]:HIGH <high-level>|MIN|MAX

OFFS/LOW

3

Activates either the Offset or Low-level parameter. Selecting Offset automatically selects Amplitude on the neighbouring **AMPL/HIGH** key and vice-versa. Selecting Low-level automatically selects High-level on the neighbouring **AMPL/HIGH** key and vice-versa. Use the **VERNIER** keys to adjust the value of the active parameter.

Offset. The available offset range is limited by the actual Amplitude setting and the Output-level window. Refer to Figure 3-9. Note that the absolute Amplitude and window limits are greater than the specified limits.

$$\text{Offset} = \frac{\text{High} - \text{Low}}{2}$$

HP-IB Command:

[[:SOURCE]:VOLTage2[:LEVEL][:IMMEDIATE]:OFFSET <offset>|MIN|MAX

Low-level. The available Low-level range is limited by the actual High-level setting, the Amplitude limits and the Output-level window of. Refer to Figure 3-9. Note that the absolute Amplitude and window limits are greater than the specified limits.

HP-IB Command:

[[:SOURCE]:VOLTage2[:LEVEL][:IMMEDIATE]:LOW <low-level>|MIN|MAX

OUTPUT and OUTPUT

50 Ω (nominal) differential SMA outputs with typically
< 20 ps inter-output skew.



Maximum external voltage ± 3 V.

Note

Programmed output-levels assume a 50 Ω load.
Output-levels double into open circuits.

3

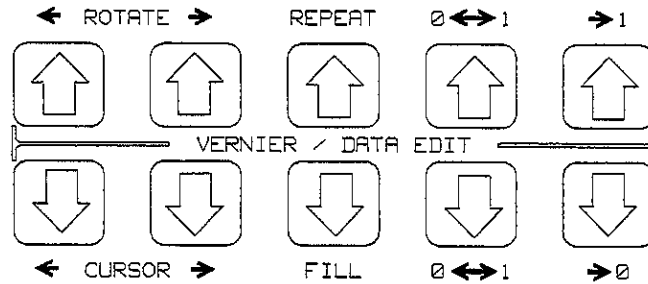

Figure 3-10. VERNIER/DATA EDIT keys

Use the **VERNIER** keys to adjust the value of the active parameter. Only one parameter can be active at a time, although two may be visible on the display. The active parameter is

- the *bright* parameter on the display.
- indicated by LEDs in and above a **mode/parameter key** (See Figure 3-1).

Each pair of keys controls the corresponding digit of the parameter:

- ⬆️ Press once to increment digit by 1
- ⬇️ Press once to decrement digit by 1

Hold a key down to auto-repeat and smoothly change a parameter. If you hold two neighbouring keys down, the auto-increment (or decrement) steps at a rate of one-third of the higher digit.

A decimal-carry operates when you change a digit from 9 to 0 or from 0 to 9. Leading zeroes are not displayed, but the vernier keys can still be used to increase/decrease the "digit". If you try to adjust a parameter outside its valid range, you will see an error message telling you the parameter limit.

DATA EDIT (Option 002)

Use the **DATA EDIT** keys to edit the 32 Bit programmable data available with Option 002 (**PULSE/DATA** Channel 2).

The **DATA EDIT** functions are indicated in *blue* above the **VERNIER** keys. Refer to Figure 3-10. The **DATA EDIT** functions are only available when the 32 Bit Data is on the display, that is:

- 32 Bit Data mode is selected on **PULSE/DATA** Channel 2 (The DATA and 32 BIT LEDs are both lit) AND the 32 Bit Data is the active parameter (The LED in the **32 BIT/PRBS** key is lit and the data is on the display).
- OR you have programmed BURST or RBURST mode via the HP-IB.

←ROTATE

Rotates the 32 Bit Data left 1 bit. (Bit 0 moves to Bit 31).

ROTATE→

Rotates the 32 Bit Data right 1 bit. (Bit 31 moves to Bit 0).

←CURSOR

Moves the cursor left 1 bit. The cursor flashes to indicate its position. The cursor wraps around from Bit 0 to Bit 31.

CURSOR→

Moves the cursor right 1 bit. The cursor wraps around from Bit 31 to Bit 0.

REPEAT

Repeats all the data *before* the cursor from the cursor up to Bit 31. If no other key has been pressed, you can undo a REPEAT by pressing the key a second time.

FILL

Fills all the data *after* the cursor up to Bit 31 with the data-value at the cursor. If no other key has been pressed, you can undo a FILL by pressing the key a second time.

DATA EDIT

0⇌1

Toggles the data-bit at the cursor between 0 and 1. The cursor doesn't move.

⇒1

Sets the data-bit at the cursor to 1 and moves the cursor right to the next bit. The cursor wraps around from Bit 31 to Bit 0.

⇒0

Sets the data-bit at the cursor to 0 and moves the cursor right to the next bit. The cursor wraps around from Bit 31 to Bit 0.

HP-IB Command:

```
:DIGital[:STIMulus]:PATTern[:DATA] <block_data>
```

HP-IB

○ RMT

○ ADS

○ SRQ



3

Figure 3-11. HP-IB Status Indicators and **LCL** key.

- **RMT** The RMT LED is on when the HP 8133A is in Remote mode and off in Local mode.
- **ADS** The ADS LED lights when the HP 8133A is addressed on the HP-IB.
- **SRQ** The SRQ LED is on when the HP 8133A is generating a Service ReQuest on the HP-IB.



In Local mode:

Activates the HP-IB address on the display. Use the **VERNIER** keys to change the HP-IB address.

In Remote mode:

Returns the HP 8133A to Local mode, UNLESS Local Lockout has been enabled via the HP-IB. If Local Lockout is active, it is not possible to return to Local mode using the **LCL** key.

Note



In Remote mode, you can still display different parameters using the frontpanel keys. You cannot change modes or adjust parameters without returning to Local mode.

Special Functions

Special Functions

The HP 8133A offers some special functions which you will not normally need to change:

Table 3-3. HP 8133A Special Functions

3

Function	Default	Range	Access Key
Temperature Compensation:	ON	ON OFF HOLD	TRIGGER (DIVIDE)
Smooth Factor: ¹	1	1 to 5	PULSE or PULSE/DATA (AMPL/HIGH)
Cable Compensation: ¹	1	1 to 5	PULSE or PULSE/DATA (OFFS/LOW)

1 per Channel

Note



The instrument's warranted specifications only apply if these special functions are at their default values.

The special functions are stored along with other instrument settings when you save the instrument setting. The special functions are reset to their default values if you switch the instrument off.

Accessing Special Functions

1. Press MEMORY (SETTING)
2. Press the Access Key given in Table 3-3
3. Use the VERNIER keys to adjust the function

Temperature Compensation

ON

The HP 8133A monitors its internal temperature in order to maintain all specifications across the specified temperature range. If the temperature changes significantly, the instrument adjusts the temperature coefficients that it uses to correct the internal-calibration data. This can cause minor changes in the output signal(s) with no corresponding change

Special Functions

in the programmed parameter values. Similarly the switching-point between internal ranges for a particular parameter occurs at different programmed values, depending on the temperature.

HOLD

The instrument stops monitoring the temperature but continues to use the current temperature coefficients to adjust the internal calibration data. Remember that if significant temperature changes occur while the compensation is on HOLD, the instrument can drift out of specification.

3

OFF

The instrument stops monitoring the temperature and uses the raw internal calibration data. This setting is normally only useful when calibrating the instrument.

Smooth Factor

Increase the Smooth Factor to produce a rounder output pulse, with slower edges and less overshoot thus reducing reflections at the DUT. The influence of the Smooth Factor is not specified and invalidates the instrument's specifications for any value other than 1.

Cable Compensation

Increase the Cable Compensation to produce a sharper output pulse with more overshoot and ringing, thus compensating for signal degradation through long cable-lengths to the DUT. The influence of the Cable Correction is not specified and invalidates the instrument's specifications for any value other than 1. You can think of the compensation value as roughly the cable length in meters.

Rearpanel

Rearpanel

3

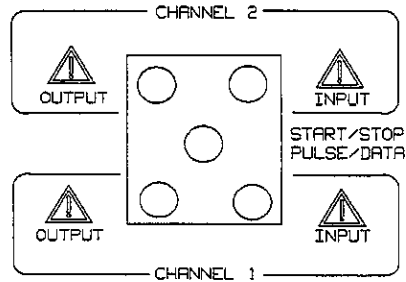

Figure 3-12. Rearpanel signal-connectors



Output Amplitude:	2 V _{pp} , ac-coupled
Input Amplitude:	Max. 2.5 V _{pp} , ac-coupled Min. 1.0 V _{pp} , ac-coupled

Channel 1 Input & Output

For normal operation the input and output must be connected with the rigid coaxial link supplied with the instrument.

For multi-channel timing applications (more than one HP 8133A synchronized), delay-lines from the HP 15436A multi-channel delay-line set are substituted for the standard links.

Channel 2 Input & Output

These are only fitted to an Option 002 or 003 instrument.

For normal operation the input and output must be connected with the rigid coaxial link supplied with the instrument.

For multi-channel timing applications (more than one HP 8133A synchronized), delay-lines from the HP 15436A

Rearpanel

multi-channel delay-line set are substituted for the standard links.

Start/Stop PULSE/DATA Input

The Start/Stop input is part of the Option 002 PULSE/DATA Channel.

3



Interface:	dc-coupled
Impedance:	50 Ω nominal
Transitions: ¹	< 1 ns
Start Level:	0 V (default)
Stop Level:	-0.4 V
Max.Levels:	-0.8 - +0.4 V

¹ You should use a clean signal, for example from a pulse generator. Noisy transitions, for example switch bounce, can confuse the Data circuits.

The Start/Stop input controls the Data & PRBS Generator. The 32 Bit data is generated internally as 8 groups of 4 bits which are multiplexed to the output.

Rearpanel

3

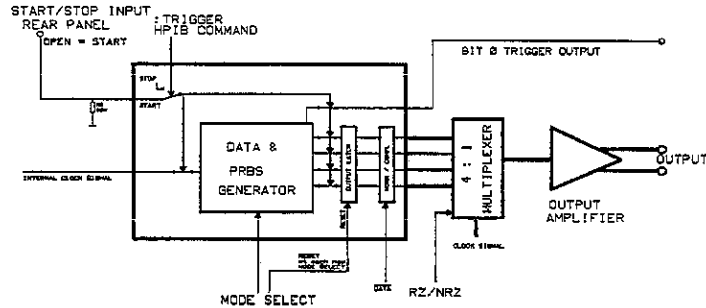

Figure 3-13. Data Start/Stop Control

Stop

When a Stop level occurs, the Generator stops and the 4 bits of data which are currently in the Output Latch, are repeated continuously.

Selecting a mode (PRBS, DATA, BURST, RBURST) using the frontpanel or HP-IB commands resets the Output Latch to zero data so that the next data starts from a known state. Note that $\overline{\text{DATA}}$ and RZ/NRZ affect the output format of the zero data! The Data Generator is also rearmed so that the next data will start from Bit 7 of the 32 Bit data word.

Start

If you have rearmed the data generator by selecting a data mode while the data generator was stopped, the data restarts from Bit 7 when a Start signal is received.

Otherwise the data continues, depending on the current mode.



Warning



This instrument contains a lithium battery. The battery is not user-replaceable and replacement should only be carried out by qualified service personnel.

3

There is a danger of explosion if the battery is incorrectly replaced.

The battery must be replaced with the same or equivalent type (HP Part No. 1420-0273). Discard used batteries according to local regulations.

Frontpanel Messages

Frontpanel Messages

The frontpanel gives you immediate feedback while you are using it. The feedback messages are intended to:

- Explain invalid key-presses.
- Give visual confirmation of mode changes.
- Inform you of parameter conflicts, and help you solve them.
- Inform you of individual parameter limits.

Invalid Key-press Messages

Not all frontpanel keys are always valid. If you press a key which is not currently valid, one of the following messages is displayed for a short time (To display the message for longer, keep the key pressed):

can't SAVE: unresolved conflicts

If there is a parameter conflict, you can't save the instrument settings.

can't overwrite standard setting

You can't save the instrument settings to the Standard Setting memory.

Complement not available for ÷1

In SQUARE mode on a **PULSE/DATA** channel you cannot complement the signal (**DATA**) while the Divider is 1, or adjust the Divider to 1 if the signal is currently complemented.

Delay not avail. in PULSE mode

The Delay/Phase parameter of a **PULSE** channel is only available in SQUARE mode. If you have Option 001, 002, or 003, the Delay/Width parameter is also available in PULSE mode on Channel 1.

Frontpanel Messages

Instrument in LOCAL LOCKOUT

Instrument in REMOTE

Key presses which would change modes or adjust parameter values are invalid while the instrument is in Remote mode/Local Lockout mode.

Key not allowed in SQUARE mode

3

The **RZ/NRZ** and **32 BIT/PRBS** keys cannot be used if the **PULSE/DATA** Channel 2 is currently in SQUARE mode. These keys are only used in DATA mode.

Level LIMIT exceeded

Any **VERNIER** key-press which would adjust a level parameter outside the LIMIT mode limits is invalid.

max Delay in PULSE mode = 5.2 ns

With **PULSE** Channel 1 Option 001, 002 or 003, you can't select PULSE mode from SQUARE mode if the (Delay+Skew) parameter is currently > 5.2 ns. Reduce the Delay first, before changing mode.

No modifiable parameter

After selecting External **TIMEBASE** mode, or PRBS mode on the **PULSE/DATA** Channel, there is no modifiable parameter for the **VERNIER** keys to adjust.

Press MEM key to select memory #

The **SAVE** and **RECALL** keys are only valid if the memory number is currently the active parameter on the display. You press **MEMORY** **SETTING** to activate the memory number.

Width not avail. in SQUARE mode

The Width/Dutycycle parameter of a **PULSE** channel is not available in SQUARE mode.

Frontpanel Messages

Fix Error first:

If there is a parameter conflict, you can activate and adjust only the parameters which are in conflict. All other parameter/mode keys are temporarily invalid.

3 Mode Change Messages

Mode changes and actions which do not change the active parameter on display, are confirmed by temporary messages (To display the message for longer, keep the key pressed). The following examples explain the format of these messages. This is not a complete list of all such messages.

Examples

Ch1: PULSE mode

You have selected PULSE mode on Channel 1.

Ch2: NRZ mode

You have changed the data format to NRZ on PULSE/DATA Channel 2.

Ch1: Pulse complement

You have switched on Channel 1 Complement output mode.

Ch1: Pulse normal

You have switched off Channel 1 Complement output mode.

EXTernal mode

You have selected EXTernal TIMEBASE mode.

Ch1: DISABLE output

You have disabled the Channel 1 OUTPUT.

Ch2: LIMIT mode on

You have switched on Limited output mode on Channel 2.

Frontpanel Messages

Errors fixed

The last valid setting has been recalled. (Pressing **RECALL** while there is a parameter conflict recalls the last valid setting).

Parameter Conflict Messages

3

A parameter conflict occurs when the available range of a parameter is constrained by the current setting of another parameter. When a parameter conflict occurs:

- An error message is displayed explaining the conflict.
- The parameter LEDs of the conflicting parameters flash.
- A flashing arrow appears next to the active parameter indicating whether you should adjust it upwards or downwards to solve the conflict. (A flashing * indicates that the conflict cannot be solved using the active parameter; you must activate one of the flashing parameters.)
- You can only activate one of the two conflicting parameters until the conflict is solved.
- You can press **RECALL** to recall the last valid setting.

Solving Parameter Conflicts

Example - Period/Width Conflict

If the current **TIMEBASE** Period is 300 ps and you try to adjust the Width on **PULSE** Channel 1 to 350 ps, the following message is displayed:

```
1:Width > Period
```

To solve the conflict do *one* of the following:

- Adjust the width back to a value < 300 ps.
- Press **TIMEBASE** **FREQ/PERIOD** to activate the Period, and adjust the period until it is greater than the width.
- Press **MEMORY** **RECALL** to recall the last valid setting.

Frontpanel Messages

Example - Output Level Conflict

After "Recalling the Standard Setting" in Chapter 4 the High- and Low-level parameters for **PULSE** Channel 1 are:

```
1:High 0.05 V 1:Low -0.05 V
```

If you now adjust the Low-level to 0 V, the following message is displayed:

```
Ampl < 0.1 V 1:Low↓ 0.00 V
```

Although 0 V is a valid Low-level setting, because of the current High-level setting there is a conflict with the minimum Amplitude.

To solve the conflict do *one* of the following:

- Reduce the Low-level, as indicated by the arrow.
- Press **AMPL/HIGH** to activate the High-level:

```
1:High↑ 0.05 V Ampl < 0.1 V
```

and increase the High-level, as indicated by the arrow.
- Press **AMPL/HIGH** twice to activate the Amplitude:

```
1:Ampl↑ 0.05 V Ampl < 0.1 V
```

and increase the Amplitude, as indicated by the arrow, until it is > 0.1 V.
- Press **MEMORY** **RECALL** to recall the last valid setting.

Note



If you activate the Offset using **OFFS/LOW**:

```
Ampl < 0.1 V 1:Offs* 0.03 V
```

the * indicates that it is *NOT* possible to solve the Amplitude conflict using the Offset parameter.

Parameter Limit Messages

If you try and adjust a parameter beyond its limits, a temporary message telling you the limit is displayed (To display the message longer, keep the key pressed). The following list of limit messages is not complete.

3

Examples

max Amplitude = 3.3 V

The Amplitude cannot be set to value > 3.3 V.

max Low Level = 3.9 V

The Low-level cannot be set to a value > 3.9 V.
(Minimum Amplitude is 0.1 V, Maximum output level = 4 V)

max Delay+Skew = 5.2 ns

You cannot increase the Delay, or Skew, any further because the combined value cannot be > 5.2 ns.
Note that the Delay+Skew limit depends on Channel number, options fitted and the actual mode selected.

Using the HP 8133A

Introduction

This chapter shows you how to carry out some common set-up tasks with the HP 8133A:

- Adjusting Parameters
- Saving and Recalling Instrument Settings
- Solving Parameter Conflicts
- Setting the Frequency/Period
- Setting the Output Levels
- Generating Squarewaves
- Generating Non-squarewave Pulses
- Varying the Inter-channel Timing
- Generating Pseudo-Random Binary Sequences (Option 002)
- Generating Repetitive Pulse Patterns
- Generating a Burst of Pulse Patterns
- Generating a Repetitive Burst of Pulse Patterns

4

Adjusting Parameters

To adjust any of the instruments parameters:

1. Activate the parameter on the display.
2. Use the **VERNIER** keys to vary the value.

Activating a parameter

4

The LEDs next to the two parameter names above a parameter key indicate which of the two parameters will be activated when you press the key. Press the key again to swap to the other parameter, that is:

- If the LED next to the parameter name is already on, press the parameter key below the parameter name *once* to activate the parameter.

The LED in the key lights, and the parameter is shown brightly in the display, indicating that this is the active parameter controlled by the **VERNIER** keys.

- If the LED next to the parameter name you want to adjust is off:
 1. Press the parameter key below the parameter name *once* to activate the alternative parameter on the key.

The key in the LED lights, and the alternative parameter is shown brightly in the display, indicating that it is the active parameter controlled by the **VERNIER** keys.

2. Press the parameter key again to toggle between parameters.

The LED in the key remains on, the LEDs above the key swap, and the other parameter is shown brightly in the display, indicating that it is the active parameter controlled by the **VERNIER** keys.

Saving and Recalling Settings

Note that the **DELAY/PHASE** key has a third parameter (SKEW), therefore you have to press the key four times to move through all the parameters.

Saving and Recalling Instrument Settings

You can save up to 20 complete instrument settings in battery backed-up RAM. An instrument setting includes the values of all timing and level parameters, the output modes and the display for all channels.

4

Saving the Current Instrument Setting

1. Activate the Memory Number parameter by pressing **MEMORY** **SETTING**.
2. Use the **VERNIER** keys to choose the Memory Number you want to use.
3. Press **MEMORY** **SAVE** to save the instrument setting in the memory.

Recalling an Instrument Setting

Caution



An instrument setting includes the status of the Disable Control keys. If the instrument setting which you recall has the instrument's outputs enabled, you could damage your device-under-test. If you are not sure about the instrument setting which you want to recall, disconnect your device before recalling the setting.

-
1. Activate the Memory Number parameter by pressing **MEMORY** **SETTING**.
 2. Use the **VERNIER** keys to choose the Memory Number you want to use.
 3. Press **MEMORY** **RECALL** to recall the instrument setting from the memory.

Saving and Recalling Settings

Recalling the Standard Setting

The Standard Settings are stored in Memory 0 (zero).

1. Activate the Memory Number parameter by pressing **MEMORY** **SETTING**.
2. Use the **VERNIER** keys to choose Memory Number 0 (zero). The display shows:
Standard Setting
3. Press **MEMORY** **RECALL** to recall the standard instrument setting from memory.

4

Saving and Recalling Settings

Table 4-1. HP 8133A Standard Settings (Memory 0)

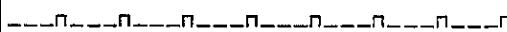
	Mode/Parameter	Standard Setting
TIMEBASE	INT/EXT	INTernal
	EXT DIVIDE	Divide ÷ 1
	FREQ/PERIOD	PERIOD 30.303 ns
TRIGGER	DIVIDE/BIT 0	Divide ÷ 1
	AMPL/HIGH	AMPLitude 0.20 V ¹
	OFFS/LOW	OFFSet 0.00 V
	DISABLE	Disabled
PULSE	PULSE/SQUAR	PULSE mode ²
	DELAY/PHASE	DELAY 0 ps
	WIDTH/DCYC	WIDTH 150 ps
	AMPL/HIGH	AMPLitude 0.10 V ¹
	OFFS/LOW	OFFSet 0.00 V
	DISABLE	Disabled
	COMP	Off
	LIMIT	Off
PULSE/DATA ³	DATA/SQUAR	SQUARewave ÷ 1
	32 BIT/PRBS	PRBS mode 
	32 Bit data	
	RZ/NRZ	NRZ mode
	AMPL/HIGH	AMPLitude 0.10 V ¹
	OFFS/LOW	OFFSet 0.00 V
	DISABLE	On (disabled)
	DATA	Off
	LIMIT	Off
Special Functions	Cable Compensation	1
	Smooth Factor	1
	Temperature Compensation	ON

4

1 The Standard amplitude settings are minimum values which are less than the specified minimum values. The corresponding Questionable Voltage bits in the Status Model (See Figure 5-1) are therefore set after recalling the Standard Settings or *RST.

2 ÷ 1 for Option 003

3 Option 002

Solving Parameter Conflicts

Solving Parameter Conflicts

A parameter conflict occurs when the available range of a parameter is constrained by the current setting of another parameter. When a parameter conflict occurs:

- An error message is displayed explaining the conflict.
- The parameter LEDs of the conflicting parameters flash.
- A flashing arrow appears next to the active parameter indicating whether you should adjust it upwards or downwards to solve the conflict.
- You can only activate one of the two conflicting parameters until the conflict is solved.
- You can press **RECALL** to recall the last valid setting.

4

Example - Period/Width Conflict

If the current **TIMEBASE** Period is 300 ps and you try to adjust the Width on **PULSE** Channel 1 to 350 ps, the following message is displayed:

```
1:Width > Period
```

To solve the conflict do *one* of the following:

- Adjust the width back to a value < 300 ps.
- Press **TIMEBASE** **FREQ/PERIOD** to activate the Period, and adjust the period until it is greater than the width.
- Press **MEMORY** **RECALL** to recall the last valid setting.

Example - Output Level Conflict

After "Recalling the Standard Setting" the High- and Low-level parameters for **PULSE** Channel 1 are:

```
1:High 0.05 V 1:Low -0.05 V
```

If you now adjust the Low-level to 0 V, the following message is displayed:

Solving Parameter Conflicts

Ampl < 0.1 V 1:Low↓ 0.00 V

Although 0 V is a valid Low-level setting, because of the current High-level setting there is a conflict with the minimum Amplitude.

To solve the conflict do *one* of the following:

- Reduce the Low-level, as indicated by the arrow.

- Press **AMPL/HIGH** to activate the High-level:

1:High↑ 0.05 V Ampl < 0.1 V

and increase the High-level, as indicated by the arrow.

- Press **AMPL/HIGH** twice to activate the Amplitude:

1:Ampl↑ 0.05 V Ampl < 0.1 V

and increase the Amplitude, as indicated by the arrow, until it is > 0.1 V.

- Press **MEMORY** **RECALL** to recall the last valid setting.

Note



If you activate the Offset using **OFFS/LOW**:

Ampl < 0.1 V 1:Offs* 0.00 V

the * indicates that it is *NOT* possible to solve the Amplitude conflict using the Offset parameter.

Setting the Frequency/Period

Using the Internal Clock

1. If necessary, select the INTernal clock source by pressing **TIMEBASE** **INT/EXT** until the INTernal LED lights.
2. Press **TIMEBASE** **FREQ/PERIOD** until the parameter you want is shown in the display.

Setting the Frequency/Period

3. Use the **VERNIER** keys to adjust the value. Refer to Table 3-1 if you need information on the parameter ranges.

Using an External Clock

1. Connect the external clock signal to the **TIMEBASE** External Input. Refer to "External Input" in Chapter 3 for the signal requirements.
2. If you want to display the measured Frequency or Period of the external signal, press **TIMEBASE** **FREQ/PERIOD** until the parameter you want is displayed.
3. If you want to divide-down the external signal, press **TIMEBASE** **EXT DIVIDE** to activate the Divider parameter and use the **VERNIER** keys to adjust it.

4

Note



The divided frequency must be ≥ 33 MHz, and the displayed Frequency/Period is always that of the undivided external signal.

Setting the Output Levels

You can set the output levels of all channels, including the **TRIGGER** output, either in terms of Amplitude and Offset or as High- and Low-levels. The level specifications and voltage-windows are given in Chapter 7. The HP 8133A will also tell you what the voltage limits are if you reach them while adjusting a parameter.

Setting the Output Levels

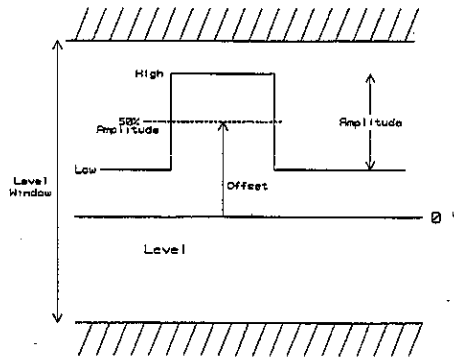

4

Figure 4-1.
Output Levels: Amplitude, Offset, High- and Low-levels.

Using Amplitude and Offset

1. Press **AMPL/HIGH** until the Amplitude parameter is active in the display.
2. Use the **VERNIER** keys to adjust the value.
3. Press **OFFS/LOW** to activate the Offset parameter in the display.
4. Use the **VERNIER** keys to adjust the value.

Using High- and Low-level

1. Press **AMPL/HIGH** until the High parameter is active in the display.
2. Use the **VERNIER** keys to adjust the value.
3. Press **OFFS/LOW** to activate the Low parameter in the display.
4. Use the **VERNIER** keys to adjust the value.

Generating Squarewaves

Generating Squarewaves

You can generate a squarewave output signal with variable output-levels using any of the HP 8133A output channels (**TRIGGER**, **PULSE** or **PULSE/DATA**).

The **TRIGGER** Channel has slightly slower edges, lower amplitude capability (but a larger voltage window) than the **PULSE** or **PULSE/DATA** Channels. Refer to Chapter 7 for the different Channel capabilities.

4

Channel	Frequency Divider	Variable Delay
TRIGGER	✓	×
PULSE	×	✓
PULSE/DATA	✓	× ¹

¹ Using 32 BIT DATA you can generate a squarewave which can be delayed in steps of 1 bit-period.

Using the **TRIGGER** Channel

Synchronized to **TIMEBASE**

1. Press **(DIVIDE/BIT 0)** until **DIVIDE** is selected.
2. If you want a squarewave at a lower frequency than the **TIMEBASE**, use the **VERNIER** keys to adjust the Divider parameter (or change the **TIMEBASE** frequency!).
3. Set the output levels using **(AMPL/HIGH)** and **(OFFS/LOW)**. See "Setting the Output Levels".
4. Press **(DISABLE)** to switch off the output Disable.

Synchronized to 32 Bit Data (Option 002)

1. Press **(DIVIDE/BIT 0)** until **BIT 0** is selected.

Generating Squarewaves

The output signal frequency is fixed at the **TIMEBASE** Frequency $\div 32$ so that 1 trigger per 32 Bit data is generated. The rising edge of the trigger signal is synchronized to Bit 0 of the data, lagging it by approximately 2 ns, see Figure 2-2.

2. Set the output levels using **AMPL/HIGH** and **OFFS/LOW**. See "Setting the Output Levels".
3. Press **DISABLE** to switch off the output Disable.

Using a **PULSE** Channel

4

1. Press **PULSE/SQUAR** until SQUAR is selected.

The frequency is fixed at the **TIMEBASE** Frequency.

2. Set the output levels using **AMPL/HIGH** and **OFFS/LOW**. See "Setting the Output Levels".
3. If you want to limit the output levels to their current levels, press **LIMIT** to switch on Limited output mode.
4. Press **DISABLE** to switch off the **OUTPUT/OUTPUT** Disables as necessary.
5. Use **DELAY/PHASE** if you want to vary the Delay timing of the output signal.
6. Use **COMP** if you want to complement the output signal.

Using a **PULSE/DATA** Channel

SQUAR mode

1. Press **DATA/SQUAR** until SQUAR is selected.
2. If you want a squarewave at a lower frequency than the **TIMEBASE**, use the **VERNIER** keys to adjust the Divider parameter.
3. Set the output levels using **AMPL/HIGH** and **OFFS/LOW**. See "Setting the Output Levels".

Generating Squarewaves

4. If you want to limit the output levels to their current levels, press **(LIMIT)** to switch on Limited output mode.
5. Press **(DISABLE)** to switch off the OUTPUT/OUTPUT Disables as necessary.
6. Use **(DATA)** if you want to invert the data.

DATA mode

1. Press **(DATA/SQUAR)** until DATA is selected.
2. Press **(32 BIT/PRBS)** until 32 BIT is selected.
3. If you want a squarewave at less than the **TIMEBASE** frequency:
 - a. Press **(RZ/NRZ)** until NRZ data format is selected.
 - b. Use the **DATA EDIT** keys to create a squarewave data pattern, refer to "**DATA EDIT** (Option 002)" in Chapter 3 if necessary.
4. If you want a squarewave at the **TIMEBASE** frequency:
 - a. Press **(RZ/NRZ)** until RZ data format is selected.
 - b. Use the **DATA EDIT** keys to set all bits to 1, refer to "**DATA EDIT** (Option 002)" in Chapter 3 if necessary.
5. Set the output levels using **(AMPL/HIGH)** and **(OFFS/LOW)**. See "Setting the Output Levels".
6. If you want to limit the output levels to their current levels, press **(LIMIT)** to switch on Limited output mode.
7. Press **(DISABLE)** to switch off the OUTPUT/OUTPUT Disables as necessary.
8. Use **(DATA)** if you want to invert the data.
9. Use the **DATA EDIT** **(ROTATE)** keys to vary the timing of the output signal in steps of 1 bit-period. (The 32 BIT DATA must be the active parameter on the display to use the **DATA EDIT** keys.)

4

Generating Non-squarewave Pulses

Using a **PULSE** Channel in PULSE mode you can set the pulse width in steps of 1 ps from 150 ps to (Period - 150 ps) or 10 ns, whichever is the smaller. (To achieve wider pulses you have to use SQUAR mode which fixes the Duty cycle at 50%, or program the 32 Bit data on the Option 002 **PULSE/DATA** Channel in NRZ mode which fixes the width-steps at 1 bit-period.)

Absolute Width

To generate pulses with an absolute width, independent of frequency:

4

1. Press **(PULSE/SQUAR)** until PULSE is selected.

The pulse frequency/period is fixed by the **TIMEBASE**.

2. Press **(WIDTH/DCYC)** until WIDTH is selected.
3. Use the **VERNIER** keys to set the pulse width.

You can adjust the pulse width up to a maximum of 10 ns or the current Period, whichever is the smaller. With WIDTH selected the pulse width remains fixed when you vary the **TIMEBASE** frequency.

4. Set the output levels using **(AMPL/HIGH)** and **(OFFS/LOW)**. See "Setting the Output Levels".
5. If you want to limit the output levels to their current levels, press **(LIMIT)** to switch on Limited output mode.
6. Press **(DISABLE)** to switch off the **OUTPUT/OUTPUT** Disables as necessary.
7. Use **(COMP)** if you want to complement the output signal.

Generating Non-squarewave Pulses

- Use **DELAY/PHASE** if you want to vary the Delay timing of the output signal, but this is only possible on Channel 1 with Option 001, 002 or 003:

PULSE	Variable Delay in PULSE mode
Channel 1	x
Channel 1 Opt 001,002 and 003	✓
Channel 2 Opt 003	x

4

Fixed Dutycycle

To generate pulses with a fixed dutycycle, independent of frequency:

- Press **PULSE/SQUAR** until PULSE is selected.

The pulse frequency/period is fixed by the **TIMEBASE**.

- Press **WIDTH/DCYC** until DCYC is selected.
- Use the **▼/▲** keys to set the pulse dutycycle

The pulse width is limited to a maximum of 10 ns or (Period - 150 ps), whichever is the smaller, 0% and 100% set dc levels at the output. With DCYC selected the pulse width is varied to maintain the Dutycycle when you vary the **TIMEBASE** frequency.

- Set the output levels using **AMPL/HIGH** and **OFFS/LOW**. See "Setting the Output Levels".
- If you want to limit the output levels to their current levels, press **LIMIT** to switch on Limited output mode.
- Press **DISABLE** to switch off the **OUTPUT/OUTPUT** Disables as necessary.
- Use **COMP** if you want to complement the output signal.
- Use **DELAY/PHASE** if you want to vary the Delay timing of the output signal, but this is only possible on Channel 1 with Option 001, 002 or 003.

Varying the Inter-channel Timing

You can vary the the delay/phase of the output signal from a **PULSE** channel. The range available depends on the Channel number, installed options and the current mode:

PULSE	Variable Delay	
	SQUAR mode	PULSE mode
Channel 1	0 - 10 ns	×
Channel 1 Opt 001,002 and 003	-5 - +15 ns	-5 - +5 ns
Channel 2 Opt 003	0 - 10 ns	×

4

Refer to Figure 2-2 which summarizes the inter-channel timing for all channels and options.

Absolute Delay

To set an absolute channel-delay, independant of frequency:

1. Press **DELAY/PHASE** until DELAY is selected.

Note that the associated SKEW parameter is always displayed when DELAY or PHASE is activated (See "Skew"). The SKEW parameter is always activated on the next key-press, and the DELAY/PHASE toggles on the following key-press.

If you have a standard instrument, DELAY is only available in SQUAR mode.

2. Use the **VERTICAL** keys to set the channel delay.

When DELAY is selected, the channel delay remains fixed if you vary the frequency.

Varying the Inter-channel Timing

Fixed Phase To set a phase delay:

1. Press **DELAY/PHASE** until PHASE is selected. Note that the associated SKEW parameter is always displayed when DELAY or PHASE is activated (See "Skew").

If you have a standard instrument, PHASE is only available in SQUAR mode.

2. Use the **VERNIER** keys to set the channel phase.

The phase range is limited to the delay range or $\pm 3600^\circ$, whichever is the smaller.

When PHASE is selected, the channel phase remains fixed if you vary the frequency.

Skew The available delay range can be divided between two parameters, either SKEW and DELAY, or SKEW and PHASE. The SKEW parameter therefore allows you to move the zero-point of the DELAY (or PHASE) parameter. To adjust the skew parameter:

1. Press **DELAY/PHASE** until the SKEW parameter is active on the display (displayed brightly).

The SKEW parameter is always activated before the mode toggles between DELAY and PHASE.

2. Use the **VERNIER** keys to adjust the value.

You can adjust the SKEW in the range ± 5 ns, but the available range can be more limited since SKEW + DELAY must always be within the specified DELAY ranges.

3. Press **DELAY/PHASE** again until the DELAY, or PHASE, parameter is active again.

Note



The SKEW delay is absolute. Like the DELAY parameter it does not vary with the frequency of the **TIMEBASE**.

Generating Pseudo-Random Bit Sequences (Option 002)

You can use the **PULSE/DATA** Channel to generate a $2^{23}-1$ PRBS conforming to CCITT 0.151:

1. Press **DATA/SQUAR** until DATA mode is selected.
2. Press **32 BIT/PRBS** until PRBS mode is selected.
3. To ensure conformity to CCITT 0.151:
 - a. Select NRZ data mode.
 - b. Switch off **DATA** mode.

This is not done automatically when you select PRBS mode.

4

Generating Repetitive Pulse Patterns

You can use the Option 002 **PULSE/DATA** Channel in 32 BIT DATA mode to program a 32 Bit data word, which is repeated continuously. Using the HP-IB you can also generate bursts or repeated bursts of the 32 Bit word (Refer to “Generating a Burst of Pulse Patterns” and “Generating a Repetitive Burst of Pulse Patterns”).

1. Press **DATA/SQUAR** until DATA mode is selected.
2. Press **32 BIT/PRBS** until 32 BIT mode is selected.

The display shows the data word including the current RZ/NRZ format and **DATA** setting.

3. Choose the data format you need using the **RZ/NRZ** key.
4. Check that **DATA** mode is switched on or off, depending on whether you want to work with inverted or normal data.
5. Use the **DATA EDIT** keys to edit the 32 Bit data pattern. Refer to “**DATA EDIT** (Option 002)” in Chapter 3 if necessary.
6. Set the output levels using **AMPL/HIGH** and **OFFS/LOW**. See “Setting the Output Levels”.
7. If you want to limit the output levels to their current levels, press **LIMIT** to switch on Limited output mode.
8. Press **DISABLE** to switch off the **OUTPUT/OUTPUT** Disables if necessary.

Generating a Burst of Pulse Patterns

The Option 002 ~~PULSE/DATA~~ Channel supports a burst mode via the HP-IB:

:FUNC2 BURS,n

This command sets up a burst consisting of the 32 Bit word repeated n times, followed by continuous zero data.

Note



- In burst mode each data word starts with Bit 7 and finishes with Bit 6.
- The zero data following the burst is affected by the DATA setting and the RZ/NRZ data format.
- The burst starts after the command is received, unless the data generator is currently stopped via the Start/Stop input or :TRIG:STOP command.

4

To generate a burst of 32 Bit words, starting from zero data and finishing with zero data:

1. Stop the data using the Start/Stop input or :TRIG:STOP command.

At this point the 4 bits of the current 32 Bit data which are in the Data Output Latch will be output continuously.(See Figure 3-13).

2. Program burst mode with the required number of bursts :FUNC2 BURS,n.

Selecting a mode, while the data is stopped, resets the Data Output Latch so that zero data is output continuously. The Data Generator is also rearmed so that it will start from Bit 7.

3. Edit or program the required 32 Bit data pattern. Note that the burst starts from Bit 7 of the data, not Bit 0, and finishes after Bit 6.

Generating a Burst of Pulse Patterns

4. Start the burst using the Start/Stop input or :TRIG command.

The 32 Bit data from Bit 7 through to Bit 6 is output *n* times in succession, followed by continuous zero data.

5. To repeat the burst after it is complete, using the same data:
 - a. Stop the data.
 - b. Program burst mode again with the required number of bursts :FUNC2 BURS ,*n*, to rearm the burst.
 - c. Start the data.

Note



If a synchronous start is not important, send the burst command without stopping/starting the data. The burst will be started immediately after the command is interpreted if the data is not currently stopped.

Generating a Repetitive Burst of Pulse Patterns

The Option 002 PULSE/DATA Channel supports a repeated burst mode via the HP-IB:

:FUNC2 RBURS ,*n*,*p*

This command selects a repeated burst consisting of the 32 Bit word repeated *n* times followed by a pause of *p* 32 Bit words of zero data before the data is repeated.

Note



- In repeated burst mode each data word starts with Bit 7 and finishes with Bit 6.
 - The zero data is affected by the DATA setting and the RZ/NRZ data format.
 - The data starts after the command is received, unless the data generator is currently stopped via the Start/Stop input or :TRIG:STOP command.
-

To generate a repeated burst of 32 Bit patterns, starting from zero data:

1. Stop the data using the Start/Stop input or :TRIG:STOP command.

At this point the 4 bits of the current 32 Bit data which are in the Data Output Latch will be output continuously.(See Figure 3-13).

2. Program burst mode with the required number of bursts and pauses:

:FUNC2 RBURS,n,p.

4

Selecting a mode, while the data is stopped, resets the Data Output Latch so that zero data is output continuously. The Data Generator is also rearmed so that it will start from Bit 7.

3. Edit or program the required 32 Bit data pattern. Note that the burst starts from Bit 7 of the data, not Bit 0, and finishes after Bit 6.
4. Start the burst using the Start/Stop input or :TRIG command.

The 32 Bit data from Bit 7 through to Bit 6 is output n times in succession, followed by $p \times 32$ bits of zero data and then the sequence repeats.

HP 8133A Programming Reference

Common Command Summary IEEE 488.2

Table 5-1.
HP 8133A IEEE 488.2 Common Command
Summary

Command	Parameter	Description
*CLS	—	Clear the status structure
*ESE	<0-255>	Set the Event Status Register Mask
*ESR?	—	Read the Event Status Register
*IDN?	—	Read the Instrument's Identification string
*LRN?	—	Read the complete Instrument Setting
*OPC	—	Set the Operation Complete bit when all pending actions are complete
*OPT?	—	Read the installed options
*RCL	<0-20>	Recall a complete Instrument Setting from memory
*RST	—	Reset the instrument to standard settings
*SAV	<1-20>	Save the complete Instrument Setting to memory
*SRE	<0-255>	Set the Service Request Enable Mask
*STB?	—	Read the Status Byte
*TST?	—	Execute instrument's self-test
*WAI	—	Wait until all pending actions are complete

SCPI Command Summary

SCPI Command Summary

Table 5-2. HP 8133A SCPI Command Summary

Command	Parameter	Description
:DIAG :CHANnel[1 2] :CABLEcomp[?] :SMOothshape[?] :TEMPCAL[?]	Integer Integer ON OFF HOLD	Set/read channel cable compensation Set/read channel smooth factor Set/read temperature calibration mode
:DIGital[2] [:STIMulus] :PATtern [:DATA][?] :SIGNal :FORMat[?] :POLarity[?]	<data> RZ NRZ NORMAL COMplement INVerted	Set/read 32 Bit data for Opt 002 Set/read data format for Opt 002 Set/read data sense for Opt 002
:DISPlay [:WINDow] [:STATE][?] :TEXT [:DATA]	ON OFF 1 0 <string> [-1]	Set/read frontpanel display state Display & <string> (-1 - Flashing)
:MEASure :FREQuency? :PERiod? :TEMPerature?		Read timebase frequency Read timebase period Read instrument temperature
:OUTPut [0 2]:DIVider[?] [0]:SOURce[?] [0 1 2][:STATE][?] :NEG[?] :POS[?]	Numeric MIN MAX PERiodic BITStream ON OFF 1 0 ON OFF 1 0 ON OFF 1 0	Set/read channel frequency divider Set/read trigger source mode Set/read channel outputs on and off Set/read channel <u>OUTPUT</u> on and off Set/read channel <u>OUTPUT</u> on and off

5

SCPI Command Summary

Table 5-2. HP 8133A SCPI Command Summary (continued)

Command	Parameter	Description
[:SOURce]		
:FUNction{1 2}		
[:SHApe]{?}	PULSe SQUARe DATA BURSt RBURSt	Set/read channel mode
:FREquency		
[:CW]:FIXed{?}	Numeric MIN MAX	Set/read internal clock frequency
:PHASe{1 2}{?}	Numeric MIN MAX	Set/read channel phase
[:PULSe]		
:DCYCLe{1 2}{?}	Numeric MIN MAX	Set/read channel dutycycle
:DELay{1 2}{?}	Numeric MIN MAX	Set/read channel delay
:DESKew{1 2}{?}	Numeric MIN MAX	Set/read channel deskew
:DHOLd{1 2}{?}	DELay PHASe	Hold Delay Phase fixed with varying frequency
:HOLd{1 2}{?}	WIDTh DCYCLe	Hold Width Dutycycle fixed with varying frequency
:PERiod{?}	Numeric MIN MAX	Set/read internal clock period
:POLarity{1 2}{?}	NORMal COMPLement INVerted	Set/read channel polarity
:WIDTh{1 2}{?}	Numeric MIN MAX	Set/read channel width
:VOLTage		
{0 1 2}{[:LEVel]}		
[:IMMediate]		
[:AMPLitude]{?}	Numeric MIN MAX	Set/read channel amplitude
:OFFSet{?}	Numeric MIN MAX	Set/read channel offset
:HIGH{?}	Numeric MIN MAX	Set/read channel high-level
:LOW{?}	Numeric MIN MAX	Set/read channel low-level
{1 2}:LIMit		
[:AMPLitude]?		Read amplitude limit
:OFFSet?		Read offset limit
:HIGH?		Read high-level limit
:LOW?		Read low-level limit
:STATe{?}	ON OFF 1 0	Set/read limited output mode on and off

5

SCPI Command Summary

Table 5-2.
HP 8133A SCPI Command Summary (continued)

Command	Parameter	Description
:STATus		
:OPERation		
[:EVENT]?		Read Operation event register
:CONDition?		Read Operation condition register
:ENABle[?]	Numeric	Set/Read Operation enable register
:NTRansition[?]	Numeric	Set/Read Operation negative-transition register
:PTRansition[?]	Numeric	Set/Read Operation positive-transition register
:PRESet		Clear and preset status groups
:QUEStionable		
[:EVENT]?		Read Questionable event register
:CONDition?		Read Questionable condition register
:ENABle[?]	Numeric	Set/Read Questionable enable register
:NTRansition[?]	Numeric	Set/Read Questionable negative-transition register
:PTRansition[?]	Numeric	Set/Read Questionable positive-transition register
:VOLtage		
[:EVENT]?		Read Questionable Voltage event register
:CONDition?		Read Questionable Voltage condition register
:ENABle[?]	Numeric	Set/Read Questionable Voltage enable register
:NTRansition[?]	Numeric	Set/Read Questionable Voltage negative-transition register
:PTRansition[?]	Numeric	Set/Read Questionable Voltage positive-transition register
:FREQuency		
[:EVENT]?		Read Questionable Frequency event register
:CONDition?		Read Questionable Frequency condition register
:ENABle[?]	Numeric	Set/Read Questionable Frequency enable register
:NTRansition[?]	Numeric	Set/Read Questionable Frequency negative-transition register
:PTRansition[?]	Numeric	Set/Read Questionable Frequency positive-transition register
:MONotony		
[:EVENT]?		Read Questionable Monotony event register
:CONDition?		Read Questionable Monotony condition register
:ENABle[?]	Numeric	Set/Read Questionable Monotony enable register
:NTRansition[?]	Numeric	Set/Read Questionable Monotony negative-transition register
:PTRansition[?]	Numeric	Set/Read Questionable Monotony positive-transition register

5

5-4 HP 8133A Programming Reference

Table 5-2.
HP 8133A SCPI Command Summary
(continued)

Command	Parameter	Description
:SYSTem		
:ERRor?		Read error queue
:KEY[?]	Numeric	Simulate key press or read key queue
:PRESet		*RST without changing display state
:SET[?]	Block data	Set/read complete instrument setting
:VERSion?		Read SCPI compliance version
:TRIGger		
:ECOut[?]	Numeric MIN MAX	Set/read the External Input Divider
:SOURce[?]	IMMediate EXTernal	Set/read Timebase mode internal or external
[:START]		Enable Start/Stop input
:STOP		Disable Start/Stop input

Status Model

Status Model

Overview

5

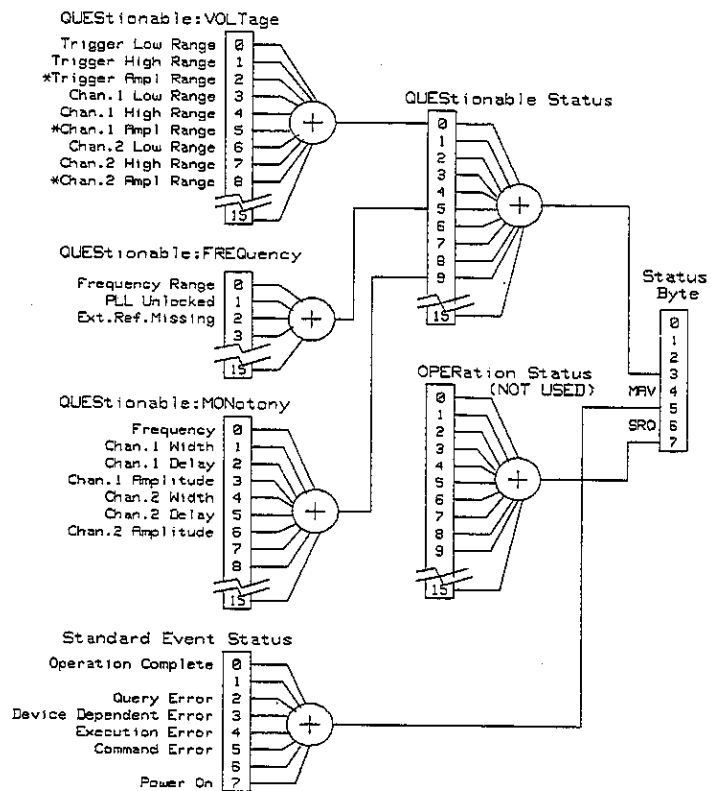

Figure 5-1. HP 8133A Status Groups

Status Model

The HP 8133A has a status reporting system conforming to IEEE 488.2 and SCPI. Figure 5-1 shows the status groups available in the HP 8133A. Each status group is made up of component registers, as shown in Figure 5-2.

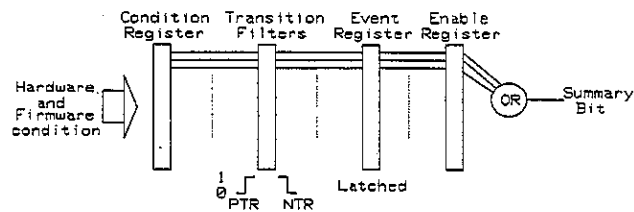

Figure 5-2. Component registers in a Status Group

Condition Register

A condition register contains the current status of the hardware and firmware. It is continuously updated and is not latched or buffered. You can only read condition registers. If there is no command to read the condition register of a particular status group, then it is simply invisible to you.

Transition Filters

Transition filters are used to detect changes of state in the condition register and set the corresponding bit in the event register. You can set transition filter bits to detect positive transitions (PTR), negative transitions (NTR) or both. Transition filters are therefore read-write registers. They are unaffected by *CLS.

Event Register

An event register latches transition events from the condition register as specified by the transition filters or records status events. Querying (reading) the event register clears it, as does the *CLS command. There is no buffering, so while a bit is set, subsequent transition events are not recorded. Event registers are read-only.

Status Model

Enable register

The enable register defines which bits in an event register are included in the logical OR into the summary bit. The enable register is logically ANDed with the event register and the resulting bits ORed into the summary bit. Enable registers are read-write, and are not affected by *CLS or querying.

Although all status groups have all of these registers, not all status groups actually use all of the registers. Table 5-3 summarizes the registers used in the HP 8133A status groups.

Table 5-3.
HP 8133A Status Groups - Registers Used

Status Group	Registers in Group				
	CONDition	NTR	PTR	EVENT	ENABle
QUESTIONable:VOLTage	√	√	√	√	√
QUESTIONable:FREQuency	√	√	√	√	√
QUESTIONable:MONotony	x	x	x	√	√
QUESTIONable	x	x	x	√	√
OPERation	x	x	x	x	x
Standard Event Status	x	x	x	√ ¹	√ ²
Status Byte	x	x	x	√ ³	√ ⁴

1 Use *ESR? to query.

2 Use *ESE to set, *ESE? to query

3 Use *STB? to query

4 Use *SRE to set, *SRE? to query

Status Byte

The status byte summarizes the information from all other status groups. The summary bit for the status byte actually appears in bit 6 (RQS) of the status byte. When RQS is set it generates an SRQ interrupt to the controller indicating that at least one instrument on the bus requires attention. You can read the status byte using a serial poll or *STB?.

Status Model

Table 5-4. Status Byte bits

Bit	Description
0	Unused, always 0
1	Unused, always 0
2	Unused, always 0
3	QUESTionable Status Summary Bit
4	MAV - Message AVailable in output buffer
5	Standard Event Status summary bit
6	RQS - ReQuest Service
7	OPERation Status summary Bit, unused

Standard Event Status Group

**Table 5-5.
Standard Event Status Group bits**

Bit	Description
0	Operation Complete, set by *OPC
1	Unused, always 0
2	Query Error
3	Device Dependant Error
4	Execution Error
5	Command Error
6	Unused, always 0
7	Power On

5

Status Model

OPERation Status Group

This Status Group is not used in the HP 8133A.

Table 5-6. OPERation Status Group bits

Bit	Description
0	Unused, always 0
1	Unused, always 0
2	Unused, always 0
3	Unused, always 0
4	Unused, always 0
5	Unused, always 0
6	Unused, always 0
7	Unused, always 0
8	Unused, always 0
9	Unused, always 0
10	Unused, always 0
11	Unused, always 0
12	Unused, always 0
13	Unused, always 0
14	Unused, always 0
15	Always 0

QUESTIONable Status Groups

Table 5-7. QUESTIONable Status Group bits

Bit	QUESTIONable	VOLTage	FREQuency	MONOtony
0	VOLTage Summary Bit	Trigger Low	Frequency Range	Frequency
1	Unused, always 0	Trigger High	PLL Unlocked	Chan 1 Width
2	Unused, always 0	Trigger Amplitude	Ext.Ref Missing	Chan 1 Delay
3	Unused, always 0	Chan 1 Low	Unused, always 0	Chan 1 Amplitude
4	Unused, always 0	Chan 1 High	Unused, always 0	Chan 2 Width
5	FREQuency Summary Bit	Chan 1 Amplitude	Unused, always 0	Chan 2 Delay
6	Unused, always 0	Chan 2 Low	Unused, always 0	Chan 2 Amplitude
7	Unused, always 0	Chan 2 High	Unused, always 0	Unused, always 0
8	Unused, always 0	Chan 2 Amplitude	Unused, always 0	Unused, always 0
9	MONOtony Summary Bit	Unused, always 0	Unused, always 0	Unused, always 0
10	Unused, always 0	Unused, always 0	Unused, always 0	Unused, always 0
11	Unused, always 0	Unused, always 0	Unused, always 0	Unused, always 0
12	Unused, always 0	Unused, always 0	Unused, always 0	Unused, always 0
13	Unused, always 0	Unused, always 0	Unused, always 0	Unused, always 0
14	Unused, always 0	Unused, always 0	Unused, always 0	Unused, always 0
15	Always 0	Always 0	Always 0	Always 0

5

Command Dictionary

The following reference sections list the HP 8133A commands in alphabetical order. In addition to a command description, the attributes of each command are described under the following headings. Not all of these attributes are applicable to all commands.

	Form	Set	The command can be used to program the instrument
		Query	The command can be used to interrogate the instrument. Add a ? to the command if necessary.
		Event	The command performs a one-off action.
5	Parameter		The type of parameter, if any, accepted by the command.
	Parameter Suffix		The suffixes which may follow the parameter.
	Functional Coupling		Any other commands which are implicitly executed by the command.
	Value Coupling		Any other parameter which is also changed by the command.
	Range Coupling		Any other parameters whose valid ranges may be changed by the command.
	*RST value		The value/state following a *RST command.
	Specified Limits		The specified limits of a parameter. These are used when MIN and MAX are programmed, unless the current valid range is limited by other coupled parameters.

Status Model

Absolute Limits Some parameters can be programmed beyond their specified limits.

Example Example programming statements which assume:

- HP BASIC 5.0/5.1/6.1
- HP-IB Interface Select Code = 7
- HP 8133A HP-IB Address = 13

:DIAG:CHANnel[1|2]:CABLEcomp

Form Set & Query

Parameter Integer

***RST value** 1

Limits 1 - 5

Description This command programs the channel Cable Compensation Factor (see "Special Functions" in Chapter 3). The factor is stored and recalled as part of the instrument setting, but is always reset to 1 when the instrument is switched off and on.

Note that any value other than 1 invalidates the instrument's specifications.

Example

OUTPUT 713;":DIAG:CHAN1:CABL 1" *Set the Cable Compensation for Channel 1 to 1.*

:DIAG:CHANnel[1|2]:SMOothshape

Form	Set & Query
Parameter	Integer
*RST value	1
Limits	1 - 5
Description	<p>This command programs the channel Smooth Factor (see "Special Functions" in Chapter 3). The factor is stored and recalled as part of the instrument setting, but is always reset to 1 when the instrument is switched off and on.</p> <p>Note that any value other than 1 invalidates the instrument's specifications.</p>

5

Example

OUTPUT 713;":DIAG:CHAN1:SMD 1" *Set the Smooth Factor for Channel 1 to 1.*

:DIAG:TEMPCAL

Form Set & Query

Parameter ON|OFF|HOLD

***RST value** ON

Description This command programs the temperature calibration mode. This mode is stored or recalled with instrument settings, but is always reset to ON when the instrument is switched off and on.

With temperature calibration ON, the instrument monitors its temperature and uses temperature coefficient stored in the calibration data to adjust the parameters and maintain them within specification across the instrument's specified temperature range.

With temperature calibration in HOLD, the instrument uses the current temperature coefficients and stops monitoring the temperature. Use HOLD if you want to prevent the instrument changing parameters due to temperature changes. Note that the instrument's specifications cannot be guaranteed while temperature calibration is on HOLD. If there is a significant change in temperature, parameters can drift out of specification.

With temperature calibration OFF, the instrument assumes all temperature coefficients are zero. This is normally only useful when calibrating the instrument.

See also "Special Functions" in Chapter 3

Example

OUTPUT 713;":DIAG:TEMPCAL HOLD" *Set the Temperature Calibration mode to Hold.*

:DIGital[2][:STIMulus]:PATtern[:DATA]

Form Set & Query

Parameter An arbitrary block of program data (IEEE 488.2 7.7.6.2) consisting of either 4 or 32 bytes:

4 byte format

#14<char1><char2><char3><char4>

32 byte format

#232<char0><char1><char2>....<char31>

***RST value** 4 bytes with the binary value 00010001

Description This command is used to program the 32 Bit Data for the optional **PULSE/DATA** Channel 2 (Option 002).

Using the **4 byte format** parameter the ASCII values of the 4 characters are used to fill the 32 Bit data. The MSB of <char1> becomes Bit 0 of the data, and the LSB of <char4> becomes Bit 31 of the data.

Using the **32 byte format** parameter the LSB of each character's ASCII code is used to fill the 32 Bit data. In this format, you can use the ASCII characters '0' and '1' to set the data.

Example All the following commands set the 32 Bit data to 01000001010000010100000101000001

OUTPUT 713;":DIG:PATT #14AAAA"

OUTPUT 713;":DIG:PATT #23201000001010000010100000101000001"

OUTPUT 713;":DIG:PATT #14"&CHR\$(65)&CHR\$(65)&CHR\$(65)&CHR\$(65)

:DIGital[2][:STIMulus]:SIGNal:FORMat

Format Set & Query

Parameter RZ|NRZ

Range Coupling Period, Frequency

***RST value** NRZ

Description This command is used to program the data format for the optional **PULSE/DATA** Channel 2 (Option 002).

5

RZ Return to Zero. A pulse of 50% dutycycle is generated for each '1' in the data.

NRZ Non Return to Zero. A pulse of 100% dutycycle is generated for each '1' in the data.

Example

OUTPUT 713;":DIG:SIGN:FORM NRZ" *Set Data format to NRZ*

:DIGital[2][:STIMulus]:SIGNal:POLarity

:DIGital[2][:STIMulus]:SIGNal:POLarity

Form Set & Query

Parameter NORMal|COMPLement|INVerted

***RST value** NORMal

Description This command is used to program the data polarity for the optional PULSE/DATA Channel 2 (Option 002). The 32 Bit Data pattern is logically inverted, that is, 1s are replaced with 0s and vice versa.

Note  This is not the same as the [:SOURce] [:PULSe]:POLarity[1|2] command, which physically inverts the signal by swapping the OUTPUT and $\overline{\text{OUTPUT}}$ signals.

5 -

Example

OUTPUT 713;":DIG:SIGN:POL INV" *Logically invert the 32 Bit data*

:DISPlay[:WINDow][:STATe]

Form Set & Query

Parameter ON|OFF|1|0

***RST value** ON

Description This command is used to turn the frontpanel display on and off. Switching off the display improves the programming speed of the instrument.

Note  *RST switches the display back on. Use :SYSTem:PRESet to perform an *RST without switching the display back on.

5

Example

OUTPUT 713;":DISP OFF" *Switch off the frontpanel display*

:DISPlay[:WINDow]:TEXT[:DATA]

:DISPlay[:WINDow]:TEXT[:DATA]

Form Set

Parameter "String"[,Attribute]

Description This comand is used to display a message on the frontpanel display. If the :DISPlay[:WINDow][:STATe] is OFF, the message remains on the display until it is overwritten by a new message or the display is switched on. If the display is switched on, the message is overwritten by the active parameter as soon as the next HP-IB command is sent, or a parameter key is pressed.

If the optional Attribute parameter is set to -1, the message blinks on the display.

5

Example

OUTPUT 713;":DISP:TEXT";CHR\$(34);"Measure rise-time on scope"CHR\$(34);", -1"
Flash message on frontpanel display

:MEASure:FREQuency?

Form Query

***RST value** Not applicable.

Description This command is used to measure the operating frequency of the instrument. In internal mode (:TRIGger:SOURce IMMEDIATE) the frequency returned is the *measured* internal clock frequency (not the programmed value). In external mode (:TRIGger:SOURce EXTERNAL) the frequency returned is that *measured* at the Trigger External Input. If an invalid signal, or no signal, is present at the External Input, a value of zero is returned.

5

The query does not return a value immediately, but waits for the internal frequency counter to complete its next measurement cycle. This can take from 0.3 to 0.6 seconds.

Example

```
OUTPUT 713;":MEAS:FREQ?"  
ENTER 713;F$
```

:MEASure:PERiod?

Form Query

***RST value** Not applicable.

Description This command is used to read the operating period of the instrument. In internal mode (:TRIGger:SOURce IMMEDIATE) the period returned is the internal clock period. In external mode (:TRIGger:SOURce EXTERNAL) the period returned is that measured at the Trigger External Input. If an invalid signal, or no signal, is present at the External Input, a value of zero is returned.

The query does not return a value immediately, as it waits for the internal frequency counter to complete its next measurement cycle. This can take from 0.3 to 0.6 seconds.

5

Example

```
OUTPUT 713;":MEAS:PER?"  
ENTER 713;P$
```

:MEASure:TEMPerature?

Form Query

***RST value** Not applicable.

Description This command is used to read the temperature within the instrument. The temperature is measured using a temperature-sensing diode on the Timing Board. The value returned is in °C.

The query does not return a value immediately, as it waits until the next measurement cycle is completed. This can take from 0.5 to 1 second.

5

Example

```
OUTPUT 713;":MEAS:TEMP?"  
ENTER 713;T$
```

:OUTPut[0|2]:DIVider**Form** Set & Query**Parameter** Numeric|MIN|MAX**Parameter Suffix** No suffix allowed***RST value** 1**Specified Limits**

Channel	Command	Valid dividers
TRIGGER Channel	:OUTPut0:DIVider	1,2,4,8,16,32,64
PULSE/DATA Channel 2 ¹	:OUTPut2:DIVider	1,2,4,8,16,32
PULSE Channel 1	Not Available	Not Available
PULSE Channel 2 ²	:OUTPut2:DIVider	1,2,4,8,16,32,64

1 Option 002 only

2 Option 003 only

Description This command is used to program the frequency divider parameter of the trigger and output channels. The TRIGGER channel is always referenced by Channel number 0.

The Trigger Channel Output frequency is divided when the Trigger Channel is in Divided mode only (:OUTPut0:SOURce PERiodic). You can program the divider in BIT 0 mode (:OUTPut0:SOURce BITstream) but it will have no effect until you select Divided trigger mode.

The PULSE/DATA channel frequency is divided in Squarewave mode only ([:SOURce]:FUNCTion2[:SHAPE] SQUare). You can program the Channel 2 divider in Data mode

:OUTPut[0|2]:DIVider

([:SOURCE]:FUNCTION2[:SHAPE] DATA) but it will have no effect until you select Squarewave mode.

Example

OUTPUT 713;":OUTPO:DIV 8" *Set Trigger Output Divider to*
8

:OUTPut[0]:SOURce

Form	Set & Query
Parameter	PERiodic BITStream
*RST value	PERiodic
Description	This command programs the Trigger Channel source mode.
PERiodic	This corresponds to DIVIDE mode on the frontpanel. The Trigger Source is the internal clock, and a trigger pulse is generated every clock period, unless the Divider parameter has been programmed to value other than 1. The trigger signal always has 50% nominal dutycycle.
BITStream	This corresponds to BIT 0 mode on the frontpanel. The Trigger Source is the 32 Bit Data stream on <u>PULSE/DATA</u> Channel 2 (Option 002 only). A trigger pulse is generated once every 32 clock periods, and is synchronized to Bit 0 of the 32 Bit data (The trigger lags Bit 0 by a fixed delay). This is not the same as a PERiodic divided-by 32 trigger, which is not synchronized to a particular Bit in the 32 Bit data.

5

Example

OUTPUT 713;":OUTP:SOUR BITS" *Synchronize the Trigger Output signal to the 32 Bit data*

:OUTPut[0|1|2]:[:STATE]

Form Set & Query

Parameter ON|OFF|1|0

***RST value** OFF

Description This command switches the channel output on or off. Channel 0 is the **TRIGGER** channel. For output channels 1 & 2, both **OUTPUT** and **OUTPUT** are switched simultaneously. In query form, OFF is returned only if both **OUTPUT** and **OUTPUT** are off (They can be controlled seperately from the frontpanel, or by adding :POS or :NEG to the command. refer to the next sections).

5

Example

OUTPUT 713;":OUTP1 ON" *Switch on Channel 1 outputs*

:OUTPut[1|2]:[:STATe]:NEG

:OUTPut[1|2]:[:STATe]:NEG

Form Set & Query

Parameter ON|OFF|1|0

***RST value** OFF

Description This command switches the channel 1 or 2 $\overline{\text{OUTPUT}}$ on or off.

Example

OUTPUT 713;":OUTP1:NEG OFF" *Switch off Channel 1 $\overline{\text{OUTPUT}}$*

5

:OUTPut[1|2]:[:STAtE]:POS

Form Set & Query

Parameter ON|OFF|1|0

***RST value** OFF

Description This command switches the channel 1 or 2 OUTPUT on or off.

Example

OUTPUT 713;":OUTP1:POS OFF" *Switch off Channel 1 OUTPUT*

-- 5

[:SOURce]:FUNCTion[1|2][:SHAPE]

Form Set & Query**Parameter** PULSe|SQUare|PRBS|DATa|BURSt, <num1>|RBURSt,
<num1>, <num2>***RST value** PULSe Channels PULSe
PULSE/DATA Channel SQUare**Description** This command programs the output channel mode. The modes available depend on the channel type:

Channel	Output Modes (Functions)
PULSe Channel 1	PULSe,SQUare
PULSe Channel 2 ¹	PULSe,SQUare
PULSE/DATA Channel 2 ²	SQUare,DATa,BURSt,RBURSt

1 Option 003 only

2 Option 002 only

PULSe Pulse mode on a PULSe channel.

SQUare Squarewave mode on a PULSe or PULSE/DATA channel.

PRBS PRBS Data mode on a PULSE/DATA channel.

DATa 32 Bit Data mode on a PULSE/DATA channel.

BURSt Burst mode on a PULSE/DATA channel.
This mode is not selectable from the frontpanel. The parameter <num1> sets the burst count. The 32 Bit data is output <num1> times, see "Generating a Burst of Pulse Patterns" in Chapter 4.

[[:SOURce]:FUNCTion[1|2][[:SHAPE]

RBURst

Repeated Burst mode on a **PULSE/DATA** channel. *This mode is not selectable from the frontpanel.* The parameter <num1> sets the burst count, <num2> sets the pause count. The 32 Bit data is output <num1> times followed by <num2> × 32 bits of zero data. The burst then repeats. Refer to “Generating a Repetitive Burst of Pulse Patterns” in Chapter 4.

Example

OUTPUT 713;":FUNC2 DATA" *Switch **PULSE/DATA** Channel 2 to 32 Bit Data mode*

[:SOURce]:FREQuency[:CW|:FIXed]

Form	Set & Query
Parameter	Numeric MIN MAX
Parameter Suffix	Hz with engineering prefixes, or MHZ for Megahertz.
Functional coupling	Programming the signal frequency, or period, also executes :TRIGger:SOURce IMMEDIATE to select the internal clock.
Value coupling	$Period = \frac{1}{Frequency}$
Range coupling	Width, Dutycycle, Phase and Pulse/Data mode selection
*RST value	33.0E6 Hz
Specified limits	33E6 - 3E9 Hz
Absolute limits	31.3E6 - 3.5E9 Hz
Description	This command programs the internal clock frequency, and also selects the internal clock as TIMEBASE if it is not already selected.

5

Example

OUTPUT 713;":FREQ 1.2GHz" *Select Internal clock with frequency 1.2 GHz*

[[:SOURce]:PHASe[1|2]

Form Set & Query

Parameter Numeric|MIN|MAX

Parameter suffix DEG or RAD. A parameter without a suffix is interpreted as degrees.

Functional coupling Programming the pulse phase also executes [[:SOURce] [:PULSe] :HOLD PHASe so that the pulse phase is held constant when the signal frequency is changed.

Value coupling $Delay = \frac{Phase}{360} \times Period$

Range coupling Skew

***RST value** 0.0

Specified limits $\pm 3600^\circ$, constrained by delay and period limits.

Absolute limits $\pm 3600^\circ$, constrained by delay and period limits.

Description This command programs the pulse phase on a PULSE channel.

Example

OUTPUT 713; "PHAS1 -180" *Set Channel 1 phase delay to -180°*

[:SOURce][:PULSe]:DCYCLe[1|2]

Form	Set & Query	
Parameter	Numeric MIN MAX	
Functional coupling	Programming the pulse duty cycle also executes [:SOURce] [:PULSe] :HOLD DCYCLe so that the pulse duty cycle is held constant when the signal frequency is changed.	
Value coupling	$Width = \frac{Duty cycle}{100} \times Period$	
Range coupling	Frequency, Period	5
*RST value	0.5 (derived from Width and Period)	
Specified limits	0 - 100%, constrained by Width & Period limits.	--
Absolute limits	0 - 100%, constrained by Width & Period limits.	
Description	This command programs the pulse duty cycle on a PULSE channel.	
Example	OUTPUT 713;":DCYC1 66" <i>Set Channel 1 Duty cycle to 66%</i>	

[:SOURce][:PULSe]:DELay[1|2]

Form Set & Query

Parameter Numeric|MIN|MAX

Parameter suffix S with engineering prefixes

Functional coupling Programming the pulse delay also executes [:SOURce] [:PULSe] :DHOLD DELay so that the pulse delay is held constant when the signal frequency is changed.

Value coupling $Phase = \frac{Delay}{Period} \times 360$

5

Range coupling Skew

***RST value** 0.0

Specified limits The following limits apply for Skew=0 (See [:SOURce] [:PULSe] :DESKew[1|2]).

PULSE Channel	Pulse mode	SQUARe mode
1 or 2 (Opt 003)	No Delay	0E-9 - 10E-9 S
1 (Opt 001,002 or 003)	-5E-9 - 5E-9 S	-5E-9 - 15E-9 S

Absolute limits The following limits apply for Skew=0 (See [:SOURce] [:PULSe] :DESKew[1|2]).

PULSE Channel	Pulse mode	SQUARe mode
1 or 2 (Opt 003)	No Delay	0E-9 - 10E-9 S
1 (Opt 001,002 or 003)	-5.2E-9 - 5.2E-9 S	-5.2E-9 - 15E-9 S

[[:SOURce][:PULSe]:DELay[1|2]

Description This command programs the pulse delay on a **PULSE** channel.

Example

OUTPUT 713;":DEL1 500PS" *Set Channel 1 Delay to 500 ps*

[[:SOURce]][:PULSe]:DESKew[1|2]

Form Set & Query

Parameter Numeric|MIN|MAX

Parameter suffix S with engineering prefixes

Range coupling Delay, Phase

***RST value** 0.0

Specified limits -5E-9 – 5E-9, but Skew+Delay must be within the Delay limits.

Description This command programs the skew parameter on a **PULSE** channel. The skew parameter allows you to move the zero-point of the delay (and phase) parameter ± 5 ns. The final delay at the output is Delay+Skew.

Example

OUTPUT 713;":DESK -155PS" *Set Channel 1 Deskew to -155 ps*

[:SOURce][:PULSe]:DHOLd[1|2]

Form Set & Query

Parameter DELay|PHASe

Functional coupling If you program the pulse delay, or pulse phase, the corresponding DHOLd command is also executed, to make sure that the last programmed parameter is held fixed when the frequency is changed.

***RST value** DELay

Description This command defines whether the pulse delay or the pulse phase of a **PULSE** channel is held constant when the signal frequency is changed.

5

Example

OUTPUT 713;":DHOL1 DEL" *Hold Channel 1 Delay fixed when frequency varies*

[:SOURce][:PULSe]:HOLD[1|2]

Form Set & Query

Parameter WIDTH|DCYCLE

Functional coupling If you program the pulse width, or pulse duty cycle, the corresponding HOLD command is also executed, to make sure that the last programmed parameter is held fixed when the frequency is changed.

***RST value** WIDTH

5 **Description** This command defines whether the pulse width or the pulse duty cycle of a PULSE channel is held constant when the signal frequency is changed.

Example

OUTPUT 713;":HOLD1 DCYC" *Hold Channel 1 Duty cycle fixed when frequency varies*

[:SOURce][:PULSe]:PERiod

Form	Set & Query
Parameter	Numeric MIN MAX
Parameter Suffix	S with engineering prefixes.
Functional coupling	Programming the signal period, or frequency, also executes :TRIGger:SOURce IMMEDIATE to select the internal clock.
Value coupling	$Frequency = \frac{1}{Period}$
Range coupling	Width, DutyCycle, Phase and Pulse/Data mode selection
*RST value	30.303 ns
Specified limits	333E-12 - 30.303E-9 S
Absolute limits	286E-12 - 31.949E-9 S
Description	This command programs the internal clock period, and also selects the internal clock as TIMEBASE if it is not already selected.
Example	OUTPUT 713;":PER 750PS" <i>Select Internal clock with period 750 ps</i>

5

[[:SOURce][:PULSe]:POLarity[1|2]

Form Set & Query

Parameter NORMal|COMPLement|INVerted

***RST value** NORMal

Description This command programs the output polarity of a **PULSE** channel. **COMPLement** and **INVerted** are synonyms.

Note  This is not the same as the **:DIGital[2] [:STIMulus]:SIGnal:POLarity** command, which logically inverts the 32 Bit data on **PULSE/DATA** Channel 2 by swapping 1s with 0s and vice-versa.

5

Example

OUTPUT 713;":POL1 INV" *Invert the Channel 1 outputs*

[:SOURce][:PULSe]:WIDTh[1|2]

Form	Set & Query
Parameter	Numeric MIN MAX
Parameter suffix	S with engineering prefixes
Functional coupling	Programming the pulse width also executes [:SOURce] [:PULSe] :HOLD WIDTh so that the pulse width is held constant when the signal frequency is changed.
Value coupling	$Dutycycle = \frac{Width}{Period} \times 100$
Range coupling	Frequency, Period
*RST value	150E-12
Specified limits	150E-12 – 10.5E-9 S or (Period – 150E-12) S
Absolute limits	0E-12 – 10.5E-9 S or Period S
Description	This command programs the pulse width on a PULSE channel.

5

Example

OUTPUT 713;":WIDT1 1NS" *Set Channel 1 pulse-width to 1 ns*

[[:SOURce]:VOLTage[0|1|2][[:LEVel][[:IMMediate][[:AMPLitude]

Form	Set & Query	
Parameter	Numeric MIN MAX	
Parameter suffix	V with engineering prefixes.	
Value coupling	$High = Offset + \frac{Amplitude}{2}$ $Low = Offset - \frac{Amplitude}{2}$	
5 Range coupling	Offset	
*RST value	TRIGGER Channel (0) PULSE Channel (1 2) PULSE\DATA Channel (2)	0.2 0.1 0.1
Specified limits	TRIGGER Channel (0) PULSE Channel (1 2) PULSE\DATA Channel (2)	0.5 – 1.8 V 0.3 – 3.0 V 0.3 – 3.0 V
Absolute limits	TRIGGER Channel (0) PULSE Channel (1 2) PULSE\DATA Channel (2)	0.2 – 1.8 V 0.1 – 3.3 V 0.1 – 3.3 V
Description	This command programs the amplitude of the output signal.	
Example	<pre>OUTPUT 713;":VOLTO 1V" <i>Set Trigger Output amplitude to 1 V</i></pre>	

[[:SOURce]:VOLTage[0|1|2][:LEVel][:IMMediate]:OFFSet

[[:SOURce]:VOLTage[0|1|2][:LEVel][:IMMediate]:OFFSet

Form	Set & Query	
Parameter	Numeric MIN MAX	
Parameter suffix	V with engineering prefixes.	
Value coupling	$High = Offset + \frac{Amplitude}{2}$ $Low = Offset - \frac{Amplitude}{2}$	
Range coupling	Amplitude	5
*RST value	0.0	
Specified limits	TRIGGER Channel (0) PULSE Channel (1 2) PULSE\DATA Channel (2)	-3.75 - 3.75 V -1.85 - 3.85 V -1.85 - 3.85 V
Absolute limits	TRIGGER Channel (0) PULSE Channel (1 2) PULSE\DATA Channel (2)	-3.9 - 3.9 V -2.95 - 3.95 V -2.95 - 3.95 V
Description	This command programs the offset of the output signal.	

Example

OUTPUT 713;":VOLT0:OFFS -100MV" *Set Trigger Output offset to -100 mV*

[[:SOURce]:VOLTage[0|1|2][:LEVel][:IMMediate]:HIGH

Form	Set & Query	
Parameter	Numeric MIN MAX	
Parameter suffix	V with engineering prefixes.	
Value coupling	<i>Amplitude = High - Low</i> <i>Offset = $\frac{High - Low}{2}$</i>	
Range coupling	Low-level	
*RST value	TRIGGER Channel (0)	0.1 V
	PULSE Channel (1 2)	0.05 V
	PULSE\DATA Channel (2)	0.05 V
Specified limits	TRIGGER Channel (0)	-3.5 - 4.0 V
	PULSE Channel (1 2)	-2.9 - 4.0 V
	PULSE\DATA Channel (2)	-2.9 - 4.0 V
Absolute limits	TRIGGER Channel (0)	-3.8 - 4.0 V
	PULSE Channel (1 2)	-2.9 - 4.0 V
	PULSE\DATA Channel (2)	-2.9 - 4.0 V
Description	This command programs the high-level of the output signal.	

Example

OUTPUT 713;":VOLT1:HIGH -200MV" *Set Channel 1 High-level to -200 mV*

[[:SOURce]:VOLTage[0|1|2][[:LEVel][[:IMMediate]:LOW

[[:SOURce]:VOLTage[0|1|2][[:LEVel][[:IMMediate]:LOW

Form Set & Query

Parameter Numeric|MIN|MAX

Parameter suffix V with engineering prefixes.

Value coupling $Amplitude = High - Low$
 $Offset = \frac{High - Low}{2}$

Range coupling High-level

***RST value**

TRIGGER Channel (0)	-0.1 V
PULSE Channel (1 2)	-0.05 V
PULSE\DATA Channel (2)	-0.05 V

Specified limits

TRIGGER Channel (0)	-4.0 - 3.5 V
PULSE Channel (1 2)	-2.0 - 3.9 V
PULSE\DATA Channel (2)	-2.0 - 3.9 V

Absolute limits

TRIGGER Channel (0)	-4.0 - 3.8 V
PULSE Channel (1 2)	-3.0 - 3.9 V
PULSE\DATA Channel (2)	-3.0 - 3.9 V

Description This command programs the low-level of the output signal.

Example

OUTPUT 713;":VOLT1:LOW -1V" *Set Channel 1 Low-level to -1 V*

5

[[:SOURce]:VOLTage[1|2]:LIMit[:AMPLitude]?

Form Query

***RST value** 3.3 V

Description This command reads the current setting of the amplitude limit. The result is only meaningful if Limited output mode is currently on ([[:SOURce]:VOLTage[1|2]:LIMit:STATe ON]).

[[:SOURce]:VOLTage[1|2]:LIMit:OFFSet?

[[:SOURce]:VOLTage[1|2]:LIMit:OFFSet?

Form	Query
*RST value	3.95 V
Description	This command reads the current setting of the offset limit. The result is only meaningful if Limited output mode is currently on ([[:SOURce]:VOLTage[1 2]:LIMit:STATe ON).

[:SOURce]:VOLTage[1|2]:LIMit:HIGH?

Form Query

***RST value** 4.0 V

Description This command reads the current setting of the high-level limit. The result is only meaningful if Limited output mode is currently on ([:SOURce]:VOLTage[1|2]:LIMit:STATe ON).

[:SOURce]:VOLTage[1|2]:LIMit:LOW?

[:SOURce]:VOLTage[1|2]:LIMit:LOW?

Form	Query
*RST value	-3.0 V
Description	This command reads the current setting of the low-level limit. The result is only meaningful if Limited output mode is currently on ([:SOURce]:VOLTage[1 2]:LIMit:STATe ON).

[[:SOURce]:VOLTage[1|2]:LIMit:STATe

Form Set & Query

Parameter ON|OFF|1|0

***RST value** OFF

Description This command switches Limited output mode on or off. When you switch on Limited output mode the current High- and Low-level parameters are taken as limit values restricting the available ranges of all the output-level parameters. You cannot program the output-levels beyond these temporary limits, until you switch off Limited output mode. The limits apply whether you program High/Low levels or Amplitude/Offset levels.

5

Example

OUTPUT 713;":VOLT1:LIM:STAT ON" *Switch on Channel 1 Limited output mode*

:STATus:OPERation

:STATus:OPERation

This command tree accesses the OPERation status group.
*The OPERation status group is not used by the HP 8133A,
therefore this command tree is redundant.*

:STATus:OPERation[:EVENT]?

:STATus:OPERation:CONDition?

:STATus:OPERation:ENABle

:STATus:OPERation:NTRansition

:STATus:OPERation:PTRansition

5

:STATus:PRESet

Form Event

***RST value** Not Applicable

Description This command

- Clears all status group event-registers
- Clears the error queue
- Presets the status group enable-, PTR-, and NTR-registers as follows:

Status Group	Register	Preset value
OPERation	ENABle	0000000000000000
	PTR	0111111111111111
	NTR	0000000000000000
QUESTionable	ENABle	0000000000000000
	PTR	0111111111111111
	NTR	0000000000000000
QUESTionable:VOLTage	ENABle	0111111111111111
	PTR	0111111111111111
	NTR	0000000000000000
QUESTionable:FREQuency	ENABle	0111111111111111
	PTR	0111111111111111
	NTR	0000000000000000
QUESTionable:MONotony	ENABle	0111111111111111
	PTR	0111111111111111
	NTR	0000000000000000

5

:STATus:QUESTionable

This command tree accesses the QUESTionable status group. The QUESTionable status group contains the summary bits from the QUESTionable:VOLTage, :FREQuency and :MONotony status groups, as shown in Figure 5-1.

The following commands are used to access the registers within the status group:

:STATus:QUESTionable[:EVENT]?

Form	Query	
*RST value	Not Applicable	
Description	This command reads the event register in the QUESTionable status group.	5

:STATus:QUESTionable:CONDition?

Form	Query	
*RST value	Not Applicable	
Description	This command reads the condition register in the QUESTionable status group. <i>The HP 8133A does not use the condition register of the QUESTionable status group, see Table 5-3, therefore this command is redundant.</i>	

:STATus:QUESTionable:ENABle

Form	Set & Query	
Parameter	Numeric	
*RST value	Not affected by *RST	
Specified limits	0 - 32767	

:STATus:QUEStionable

Description	This command sets or queries the enable register in the QUEStionable status group.
--------------------	--

:STATus:QUEStionable:NTRansition

Form	Set & Query
-------------	-------------

Parameter	Numeric
------------------	---------

*RST value	Not Applicable
-------------------	----------------

Specified limits	0-32767
-------------------------	---------

Description	This command sets or queries the negative-transition register in the QUEStionable status group. <i>The HP 8133A does not use the transition registers of the QUEStionable status group, see Table 5-3, therefore this command is redundant.</i>
--------------------	---

5

:STATus:QUEStionable:PTRansition

Form	Set & Query
-------------	-------------

Parameter	Numeric
------------------	---------

*RST value	Not Applicable
-------------------	----------------

Specified limits	0-32767
-------------------------	---------

Description	This command sets or queries the positive-transition register in the QUEStionable status group. <i>The HP 8133A does not use the transition registers of the QUEStionable status group, see Table 5-3, therefore this command is redundant.</i>
--------------------	---

:STATus:QUEStionable:VOLTage

This command tree accesses the QUEStionable:VOLTage status group. The QUEStionable:VOLTage status group monitors the currently programmed output voltage levels against their specified ranges.

The following commands are used to access the registers within the status group:

:STATus:QUEStionable:VOLTage[:EVENT]?

Form	Query
*RST value	Not Applicable
Description	This command reads the event register in the QUEStionable:VOLTage status group.

5

:STATus:QUEStionable:VOLTage:CONDition?

Form	Query
*RST value	Not Applicable
Description	This command reads the condition register in the QUEStionable:VOLTage status group.

:STATus:QUEStionable:VOLTage:ENABle

Form	Set & Query
Parameter	Numeric
*RST value	Not Applicable
Specified limits	0 - 32767
Description	This command sets or queries the enable register in the QUEStionable:VOLTage status group.

:STATus:QUEStionable:VOLTage

:STATus:QUEStionable:VOLTage:NTRansition

Form	Set & Query
Parameter	Numeric
*RST value	Not Applicable
Specified limits	0-32767
Description	This command sets or queries the negative-transition register in the QUEStionable:VOLTage status group.

:STATus:QUEStionable:VOLTage:PTRansition

Form	Set & Query
Parameter	Numeric
*RST value	Not Applicable
Specified limits	0-32767
Description	This command sets or queries the positive-transition register in the QUEStionable:VOLTage status group.

5

:STATus:QUEStionable:FREQuency

This command tree accesses the QUEStionable:FREQuency status group. The QUEStionable:FREQuency status group monitors the currently programmed frequency against the specified range, detects if the PLL is unlocked and indicates if there is a valid signal at the **TIMEBASE** External Input.

The following commands are used to access the registers within the status group:

:STATus:QUEStionable:FREQuency[:EVENT]?

Form	Query	
*RST value	Not Applicable	
Description	This command reads the event register in the QUEStionable:FREQuency status group.	5

:STATus:QUEStionable:FREQuency:CONDition?

Form	Query
*RST value	Not Applicable
Description	This command reads the condition register in the QUEStionable:FREQuency status group.

:STATus:QUEStionable:FREQuency:ENABle

Form	Set & Query
Parameter	Numeric
*RST value	Not Applicable
Specified limits	0 - 32767

:STATus:QUESTionable:FREQuency

Description	This command sets or queries the enable register in the QUESTionable:FREQuency status group.
--------------------	--

:STATus:QUESTionable:FREQuency:NTRansition

Form	Set & Query
Parameter	Numeric
*RST value	Not Applicable
Specified limits	0-32767
Description	This command sets or queries the negative-transition register in the QUESTionable:FREQuency status group.

5

:STATus:QUESTionable:FREQuency:PTRansition

Form	Set & Query
Parameter	Numeric
*RST value	Not Applicable
Specified limits	0-32767
Description	This command sets or queries the positive-transition register in the QUESTionable:FREQuency status group.

:STATus:QUEStionable:MONotony

This command tree accesses the QUEStionable:MONotony status group. The QUEStionable:MONotony status group monitors the frequency, width, delay and amplitude parameters. The range of these parameters is made up of several internal ranges and when the parameter moves from one internal range to the next a discontinuity can occur. For example, increasing the frequency at a range boundary could cause the actual output frequency to decrease slightly. The range boundaries also vary with temperature, and a significant temperature change could cause the instrument to move to the next range in order to maintain the current parameter within specification.

When a parameter range-change occurs, the corresponding bit in the QUEStionable:MONotony status event register is set to indicate that the output signal may not vary monotonically with the programmed parameter value.

5

The following commands are used to access the registers within the status group:

:STATus:QUEStionable:MONotony[:EVENT]?

Form	Query
*RST value	Not Applicable
Description	This command reads the event register in the QUEStionable:MONotony status group.

:STATus:QUEStionable:MONotony:CONDition?

Form	Query
*RST value	Not Applicable
Description	This command reads the condition register in the QUEStionable:MONotony status

:STATus:QUEStionable:MONotony

group. *The HP 8133A does not use the condition register of the QUEStionable:MONotony status group, see Table 5-3, therefore this command is redundant.*

:STATus:QUEStionable:MONotony:ENABLE

Form	Set & Query
Parameter	Numeric
*RST value	Not Applicable
Specified limits	0 - 32767
Description	This command sets or queries the enable register in the QUEStionable:MONotony status group.

5

:STATus:QUEStionable:MONotony:NTRansition

Form	Set & Query
Parameter	Numeric
*RST value	Not Applicable
Specified limits	0-32767
Description	This command sets or queries the negative-transition register in the QUEStionable:MONotony status group. <i>The HP 8133A does not use the transition registers of the QUEStionable:MONotony status group, see Table 5-3, therefore this command is redundant.</i>

:STATus:QUEStionable:MONotony

:STATus:QUEStionable:MONotony:PTRansition

Form	Set & Query
Parameter	Numeric
*RST value	Not Applicable
Specified limits	0-32767
Description	This command sets or queries the positive-transition register in the QUEStionable:MONotony status group. <i>The HP 8133A does not use the transition registers of the QUEStionable:MONotony status group, see Table 5-3, therefore this command is redundant.</i>

5

:SYSTem:ERRor?

Form Query

***RST value** Not Applicable

Description This command is used to read the HP 8133A error queue. The HP 8133A error queue can store up to 32 error codes on a first-in-first-out basis. When you read the error queue, the error number and associated message are put into the instrument's output buffer.

If the queue is empty, the value 0 is returned, meaning No Error. If the queue overflows at any time, the last error code is discarded and replaced with -350 meaning Queue overflow.

Refer to "SCPI Error Messages" at the end of the chapter for a list of error messages.

5

:SYSTem:KEY

Form	Set & Query
Parameter	Numeric
Parameter suffix	No suffix allowed
*RST value	-1
Specified limits	See Table 5-8
Description	<p>In query form, this command reads the last key pressed. The key queue is functions independantly from the instrument's Local/Remote state. The queue is emptied by *RST and returns the value -1 when empty. 5</p> <p>In set form, the command simulates a frontpanel key-press which is handled as if the key had been pressed in Local mode. Simulated key-presses are not put into the key queue.</p>

:SYSTem:KEY

Table 5-8. :SYSTem:KEY parameter reference

No.	Key Description	No.	Key Description
-1	No key pressed (Query only)	21	Trigger AMPL/HIGH
0	LCL	22	Trigger DIVIDE/BIT 0 ¹
2	FREQ/PERIOD	23	Channel 2 DISABLE OUTPUT
3	EXT DIVIDE	24	Vernier 5 (left-hand end), ↓
4	INT/EXT	25	Vernier 5 (left-hand end), ↑
5	RECALL	26	Channel 1 DISABLE OUTPUT
6	SAVE	27	Channel 1 LIMT
7	SETTING	28	Channel 1 COMP
8	Channel 2 LIMT	29	Channel 1 DISABLE OUTPUT
9	Channel 2 DATA ¹ or COMP ²	30	Channel 1 OFFS/LOW
10	Channel 2 DISABLE OUTPUT	31	Channel 2 AMPL/HIGH
11	Channel 2 OFFS/LOW	40	Vernier 1 (right-hand end), ↓
12	Channel 2 AMPL/HIGH	41	Vernier 1 (right-hand end), ↑
13	Channel 2 RZ/NRZ ¹ or WIDTH/DCYC ²	42	Vernier 2 ↓
14	Channel 2 PRBS/32 BIT ¹ or DELAY/PHASE ²	43	Vernier 2 ↑
15	Channel 2 DATA/SQUAR ¹ or PULSE/SQUAR ²	44	Vernier 3 ↓
16	Channel 1 WIDTH/DCYC	45	Vernier 3 ↑
17	Channel 1 DELAY/PHASE	46	Vernier 4 ↓
18	Channel 1 PULSE/SQUAR	47	Vernier 4 ↑
19	Trigger DISABLE		
20	Trigger OFFS/LOW		

51

1 Option 002

2 Option 003

:SYSTem:PRESet

Form	Event
*RST value	Not applicable
Description	This command is equivalent to *RST, except that there is no change to the :DISPLAY[:WINDOW] [:STATE]. Use this command instead of *RST if you want the display to remain switched off during program execution.

:SYSTEM:SET

Form Set & Query

Parameter Block data

***RST value** See Table 4-1

Description In query form, the command reads a block of data containing the instrument's complete set-up. The set-up information includes all parameter and mode settings, but does not include the contents of the instrument setting memories, the status group registers or the :DISPlay[:WINDow][:STATe] The data is in a binary format, not ASCII, and cannot be edited.

In set form, the block data must be a complete instrument set-up read using the query form of the command.

5

:SYSTem:VERsion?

:SYSTem:VERsion?

Form	Query
*RST value	"1992.0"
Description	This command reads the SCPI revision to which the instrument complies.

:TRIGger:ECOunt

Form	Set & Query
Parameter	Numeric MIN MAX
Parameter suffix	None
*RST value	1
Specified limits	1,2,4,8,16,32,64

Description This command programs the External Input Divider parameter used to divide the external signal applied to the External Input. In Internal timebase mode (:TRIGger:SOURce IMMEDIATE) you can still use this command, but the divider will have no effect until you select External timebase mode (:TRIGger:SOURce EXTERNAL).

Example

OUTPUT 713;":TRIG:ECO 4" *Set the Timebase External Divider to 4*

:TRIGger:SOURce

Form Set & Query

Parameter IMMEDIATE|EXTERNAL

Functional coupling If you program the instrument frequency using [:SOURCE]:FREQUENCY (or the period using [:SOURCE]:PULSE:PERIOD) then the :TRIGger:SOURce is set to IMMEDIATE.

***RST value** IMMEDIATE

Description This command is used to switch the timebase mode between Internal (IMMEDIATE) and External (EXTERNAL). 5
With :TRIGger:SOURce IMMEDIATE (internal timebase) the frequency (or period) is controlled using the [:SOURCE]:FREQUENCY (or [:SOURCE]:PULSE:PERIOD) command.
With :TRIGger:SOURce EXTERNAL, the frequency (or period) is controlled by the external signal applied to the External Input, divided by the External Divider parameter (see :TRIGger:ECOUNT).

Example

OUTPUT 713;":TRIG:SOUR EXT" *Select External Timebase mode*

:TRIGger[:START]

Form Event

***RST value** Not applicable

Description This command enables the Start/Stop Input on the rear panel. If the Input is unconnected, or grounded, this command starts the data gate-array on the Option 002 **PULSE/DATA** channel. See "Start/Stop **PULSE/DATA** Input" in Chapter 3.

:TRIGger:STOP

:TRIGger:STOP

Form	Event
*RST value	Not applicable
Description	This command disables the external Start/Stop input on the rear panel and stops the data gate-array on the Option 002 <u>PULSE/DATA</u> channel. See "Start/Stop <u>PULSE/DATA</u> Input" in Chapter 3.

5

SCPI Error Messages

- 108** Parameter not allowed; Too many parameters
Triggered by: :FUNCTION:SHAPE command. Too many parameters for this command.
- 109** Missing Parameter; Too few parameters
Triggered by: :FUNCTION:SHAPE command. Too few parameters for this command.
- 113** Undefined header
Triggered by commands with a numeric suffix which is out of range.
- 114** Header suffix out of range; Channel number must be 1 or 2
Triggered by commands that need a channel number and the given number is not 1 or 2.
- 114** Header suffix out of range; Channel number not allowed
Triggered by commands that need a channel number. This error indicates that the given channel number is not allowed for this command and/or argument.
- 114** Header suffix out of range; Not a pulse channel
Triggered by commands that need a channel number and the given channel is not a pulse channel.
- 114** Header suffix out of range; Not a data channel
Triggered by commands that need a channel number and the given channel is not a data channel.

SCPI Error Messages

- 148** Character data not allowed;
Triggered by: :DIGital:SEquence:SElect and :OUTPut0:SCURce commands. Illegal Parameter.
- 200** Execution error; Cannot program hardware to the desired value
Triggered by various hardware drivers in case they can not program the hardware to the desired value. This error should not occur once the hardware boards are calibrated.
- 200** Execution error; Ambiguous MIN/MAX setting
Triggered by :VOLTage:.... . MIN|MAX commands. Cannot set several parameters to MIN/MAX at the same time. (for example HIGH MIN, LOW MAX)
- 221** Settings conflict; Period less than Width
- 222** Data out of range
A given parameter is out of range.
- 222** Data out of range; Frequency value out of range
Triggered by: :SOURce:FREQuency command. Value for frequency out of range
- 222** Data out of range; Period value out of range
Triggered by: :SOURce:PULS:PERIOD command. Value for period out of range
- 222** Data out of range; Delay value out of range
Triggered by: :SOURce[:PULSe]:DELay or :SOURce[:PULSe]:SKEW command. Value for delay or skew out of range.

5

SCPI Error Messages

- 222** Data out of range; Phase value out of range
Triggered by: :SOURce[:PULSe]:PHASe command.
Value for phase out of range.
- 222** Data out of range; Width value out of range
Triggered by: :SOURce[:PULSe]:WIDTH command.
Value for width out of range.
- 222** Data out of range; Duty cycle value out of range
Triggered by: :SOURce[:PULSe]:DCYCLe command.
Value for duty cycle out of range.
- 222** Data out of range; Amplitude value out of range
Triggered by: :SOURce:VOLTage:AMPL command.
Amplitude value is out of range.
- 222** Data out of range; Offset value out of range
Triggered by: :SOURce:VOLTage:OFFSet command.
Offset value is out of range.
- 222** Data out of range; Low level out of range
Triggered by: :SOURce:VOLTage:LOW command. Low
level value is out of range.
- 222** Data out of range; Amplitude too low
- 222** Data out of range; High level out of range
Triggered by: :SOURce:VOLTage:HIGH command.
High level value is out of range.
- 222** Data out of range; Amplitude too high

SCPI Error Messages

- 222** Data out of range; External divider value out of range
Triggered by: :TRIGger:ECOUNT command. Value for prescaler out of range.
- 222** Data out of range; Trigger prescaler value out of range
Triggered by: :OUTPut0:DIVider command. Value for prescaler out of range.
- 222** Data out of range; Burstcount out of range
Triggered by: :FUNction:SHAPE BURSt|RBURSt command. Number of bursts is out of range (1 ... 16383)
- 222** Data out of range; Input Frequency is out of range
Triggered by PLL interrupt routine. The PLL can not be locked in external timebase mode. 5
- 222** Data out of range; SAV/RCL index is out of range
Triggered by: *SAV or *RCL commands. The argument must be in the range 1- 20.
- 222** Data out of range; Size out of range
Triggered by: :SYSTem:SET command. Size of argument is out of range.
- 222** Data out of range; Invalid format ID
Triggered by: :SYSTem:SET command. Format ID is invalid. The data can not be used with this firmware release.
- 222** Data out of range; Invalid signature
Triggered by: :SYSTem:SET command. The signature of the data block is invalid. The data block does not represent a valid setting.

SCPI Error Messages

- 224** Illegal parameter value; Data complement not available
In square mode divide by one data complement is not available.
- 224** Illegal parameter value
Triggered by: :TRIGger:ECOUNT and :OUTPut0:DIVide commands if the parameter is not a power of 2.
- 240** Hardware error; Can't read temperature sense on timing board
Triggered by the temperature measurement loop if it can not read the temperature ADC after 10 tries. This error usually indicates a hardware failure.
- 240** Hardware error; Timeout waiting for measurement
Triggered by :MEAS:FREQ and :MEAS:TEMP commands. The desired ADC value can not be read because the ADC is either busy or indicates an invalid value (0 or 255).
- 240** Hardware error; Cannot lock PLL of databoard
Triggered by the PLL interrupt routine. The PLL can not be locked in internal timebase mode. This error may be caused by missing semirigid cables on the rear panel of the instrument.
- 240** Hardware error; Instrument state lost
Triggered by power on. This error Occurs if the non-volatile RAM is corrupted. All parameters are set to their *RST values.
- 240** Hardware error; SAV/RCL registers corrupted
One or more of the SAV/RCL registers are destroyed. They are set to the *RST settings.

5

SCPI Error Messages

- 240** Hardware error; Non-volatile memory is corrupted
The content of the non-volatile memory is destroyed.
Instrument is reset to *RST conditions.
- 240** Hardware error; Hardware driver failure
This message is generated if a hardware driver reports an error with a value that it previously accepted. This error should not occur unless the instrument is not properly calibrated.
- 240** Hardware missing; Command not allowed in this configuration
Triggered by commands for a **PULSE/DATA** Channel when this Option (002) is not installed.
- 313** Calibration memory lost; No caldata found on timingboard
Triggered by: power on. Tried to read caldata from EEPROM. The instrument is not calibrated when this error message occurs.
- 313** Calibration memory lost; No caldata found on databoard
Triggered by: power on. Tried to read caldata from EEPROM. The instrument is not calibrated when this error message occurs.
- 313** Calibration memory lost; No caldata found on widthboard
1
Triggered by: power on. Tried to read caldata from EEPROM. The instrument is not calibrated when this error message occurs.

5

-313 Calibration memory lost; No caldata found on widthboard
2

Triggered by: power on. Tried to read caldata from EEPROM. The instrument is not calibrated when this error message occurs.

-313 Calibration memory lost; No calibration data found

Triggered by: :SOURce and :OUTPUT commands.
Indicates that necessary calibration data is missing.
This error should not occur in a calibrated instrument.

Testing the HP 8133A

Use the tests in this chapter if you want to check that the HP 8133A is working correctly. Before starting any testing:

- Recall the HP 8133A Standard Settings from Memory 0.
- Let the HP 8133A and all other test equipment warm up for at least 30 minutes.

The tests are divided into the following sections:

TIMEBASE	Applies to all instruments.
TRIGGER	Applies to all instruments
Outputs	Applies to each Output Channel. The tests in this section need to be repeated for both channels in a dual channel instrument. Not all the tests apply to both PULSE and PULSE/DATA Channels, see Table 6-3.

6

Within each section carry out the tests in the order given.

All tests which test the instrument against its warranted specifications are called **Performance** tests, and the results can be recorded on the Performance Test Record at the end of the chapter.

The **Verification** tests verify the instrument's non-warranted characteristics.

Recommended Test Equipment and Accessories

The following tables list the recommended test equipment you need to carry out all the tests in this chapter. You can use alternative instruments as long as they meet the critical specifications given. The test set-ups and procedures assume you are using the recommended equipment.

Table 6-1. Recommended Test Equipment

Type	Model	Critical Specifications
Oscilloscope	HP 54120 Series with 2.5 GHz Trigger Recommended: HP 54121T or HP 54124T	Timing Accuracy: ≤ 10 ps $\pm 0.1\%$ of reading Bandwidth: ≥ 20 GHz Risettime: ≤ 17.5 ps DC Accuracy: $\pm 0.4\%$ of fullscale ± 2 mV Jitter: ≤ 2.5 ps + $5 \times 10^{-5} \times$ delay setting Input Impedance: 50 Ω nominal
Counter	HP 5334B Opt 030 HP 8133A	Range: To 1900 MHz, 9 digit mantissa Range: To 3.33 GHz (333 ps to 30.3 ns) Accuracy: $\pm 0.1\%$
Pulse Generator	HP 8133A	3 GHz pulses (333 ps period) 33 MHz pulses (30.303 ns period) Accuracy: $\pm 0.5\%$

6

Table 6-2. Recommended Accessories

Type	Model	Critical Specifications
Attenuator	33340C #020	20 dB, dc-26.5 GHz, APC -3.5
Cables	8120-4948	50 Ω SMA (m-m)
Adapters	1250-1200 1250-2015 1250-1700 1250-1159	SMA (m) to BNC (f) SMA (f) to BNC (m) SMA (f) to BNC (m) SMA (m-m)
Power Splitter	11667B	50 Ω , dc-26.5 GHz, APC -3.5
Torque Wrench	8710-1582	5/16 in, 5 lb-in (56 Ncm)

6-2 Testing the HP 8133A

TIMEBASE

Tests Carry out the following tests in order:

1. Internal Clock— Low Frequency Performance
2. **TRIGGER** Divider Verification
3. External Frequency Counter Performance
4. External Divider Verification
5. Internal Clock—High Frequency Performance

Equipment

- Low Frequency Counter to 100 MHz (HP 5334B)
- High Frequency Counter to 3.33 GHz (HP 8133A)
- 2 × Cable (SMA m-m)
- Adapter (SMA (f) to BNC (m))

Internal Clock—Low Frequency Performance

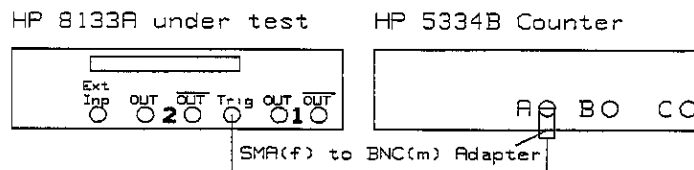

Figure 6-1. Internal Clock Low Frequency Test Set-up

1. Connect the HP 8133A **TRIGGER** Output to the HP 5334B Counter Input A as shown in Figure 6-1
2. Set up the Counter as follows:
 - PER A
 - AUTO TRIG OFF
 - LEVEL 0.0 V
 - GATE TIME 1 ms
 - 100 Gate Averages

3. Set up the HP 8133A under test as follows:

TIMEBASE	INT/EXT	INTernal
	FREQ/PERIOD	PERIOD 30.000 ns
TRIGGER	AMPL/HIGH	HIGH +0.5 V
	OFFS/LOW	LOW -0.5 V
	DIVIDE/BT0	DIVIDE ÷1
	DISABLE	Off (Output enabled)

4. Check that the measured period is 30.00 ns \pm 0.15 ns, and record the measured period on the Test Record.
5. Adjust the HP 8133A period to 10.000 ns.
6. Check that the measured period is 10.00 ns \pm 0.05 ns, and record the measured period on the Test Record.

TRIGGER Divider Verification

6

7. Disable the Counter's 100 Gate Averages mode.
8. Adjust the HP 8133A under test period until the *measured* period is 10.00xx ns (that is, to an accuracy of 2 decimal places).
9. Adjust the TRIGGER Divider through its possible values and verify that the measured period varies accordingly:

Divider	Measured Period
÷2	20.00xx ns
÷4	40.00xx ns
÷8	80.00xx ns
÷16	160.0xx ns
÷32	320.0xx ns
÷64	640.0xx ns

10. Adjust the TRIGGER Divider back to 1.

External Frequency Counter Performance

Low Frequency

- Set up a *second* HP 8133A as an External Clock source. Recall the Standard Setting, and then set up the following:

TIMEBASE	INT/EXT	INTernal
	FREQ/PERIOD	PERIOD 10.000 ns
TRIGGER	AMPL/HIGH	HIGH +0.5 V
	OFFS/LOW	LOW -0.5 V
	DIVIDE/BIT0	DIVIDE ÷1
	DISABLE	Off (Output enabled)

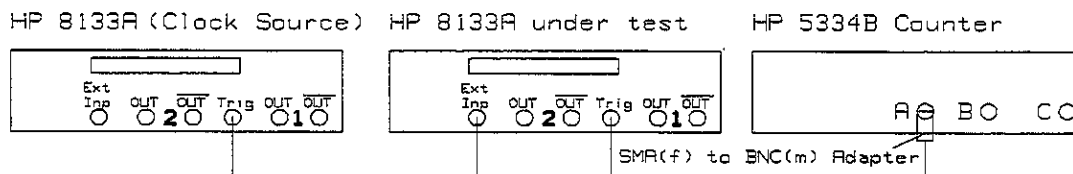

6

Figure 6-2. External Frequency Counter Low Frequency Test Set-up

- Connect the *second* HP 8133A Trigger Channel Output to the External Input of the HP 8133A under test.
- Set up the HP 8133A under test as follows:

TIMEBASE	INT/EXT	EXTernal
	FREQ/PERIOD	PERIOD
	EXT DIVIDE	÷1

- Adjust the *second* HP 8133A period (clock source) until the *measured* period on the Counter is 10.00xx ns.

- Check that the measured period on the HP 8133A under test is 10.00 ns \pm 0.01 ns, and record the result on the Test Record.

External Divider Verification

- Adjust the **TIMEBASE** External Divider on the HP 8133A under test through its possible values and verify that the measured period on the Counter varies accordingly:

Ext Divider	Measured Period
$\div 2$	20.00xx ns
$\div 4$	40.00xx ns
$\div 8$	80.00xx ns
$\div 16$	160.0xx ns
$\div 32$	320.0xx ns
$\div 64$	640.0xx ns

- Adjust the **TIMEBASE** External Divider back to 1.

6 External Frequency Counter Performance

High Frequency

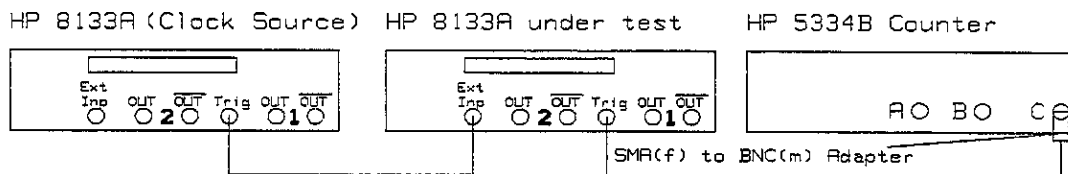

Figure 6-3. External Frequency Counter High Frequency Test Set-up

- Reconnect the HP 8133A **TRIGGER** output to the high frequency Input C of the HP 5334B Counter.
- Set the Counter to measure the frequency of Input C.

6-6 Testing the HP 8133A

20. Set up the HP 8133A under test as follows:



21. Set up up the *second* (Clock Source) HP 8133A as follows:



22. Adjust the frequency of the *second* HP 8133A until the *measured* frequency on the Counter is $1.000X \text{ GHz} \pm 0.0002 \text{ GHz}$.
23. Check that the measured frequency on the HP 8133A under test is $1.000 \text{ GHz} \pm 0.001 \text{ GHz}$, and record the result on the Test Record.

Internal Clock—High Frequency Performance

6

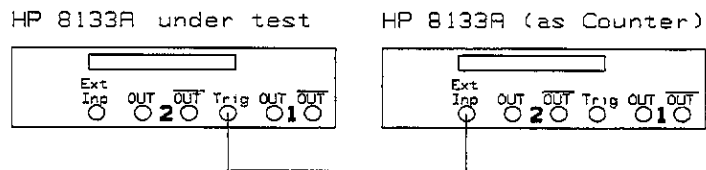

Figure 6-4. Internal Clock High Frequency Test Set-up

24. Disconnect the *second* HP 8133A from the External Input.
25. Disconnect the HP 8133A Trigger Channel Output from the Counter and connect it to the External

Testing the HP 8133A 6-7

Input of the *second* HP 8133A which will now be used as a High Frequency Counter.

26. Set up the HP 8133A under test as follows:

TIMEBASE	INT/EXT	INTernal
	FREQ/PERIOD	FREQUENCY 3.0000 GHz

27. Set up the *second* HP 8133A to be used as a High Frequency Counter:

TIMEBASE	INT/EXT	EXternal
	FREQ/PERIOD	FREQ

28. Check that the measured frequency is 3.000 GHz ± 0.015 GHz, and record the measured frequency on the Test Record.
29. Disconnect the Trigger Channel Output from the *second* HP 8133A.

TRIGGER

Tests Carry out the following tests in order:

1. Transition Time Performance
2. Dutycycle Verification
3. Level Verification

Set-up

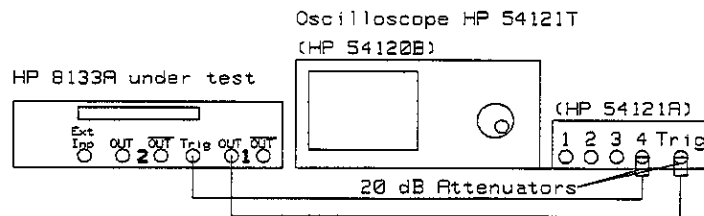

Figure 6-5. TRIGGER Transition Time Test Set-up

- Equipment**
- Oscilloscope (HP 54121T)
 - 2 × Cable (SMA m-m)
 - 2 × 20 dB Attenuator (33340C)

6

Transition Time Performance

1. Connect the HP 8133A to the oscilloscope as shown in Figure 6-5.
 - a. Connect the **TRIGGER** Output to the Channel 4 input on the 'scope.
 - b. Connect the **PULSE** Output under test to the Trigger Input on the 'scope.

2. Set up the HP 8133A as follows:

TIMEBASE	INT/EXT	INternal
	FREQ/PERIOD	PERIOD 30.000 ns
TRIGGER	AMPL/HIGH	HIGH +1.8 V
	OFFS/LOW	LOW 0.0 V
	DIVIDE/BITS	DIVIDE ÷1
	DISABLE	Off (Output enabled)
PULSE 1	PULSE/SQUAR	SQUAR
	AMPL/HIGH	HIGH +0.5 V
	OFFS/LOW	LOW -0.5 V
	DISABLE	Off (OUTPUT enabled)

Risetime

3. On the oscilloscope:

- a. Press **AUTOSCALE**.
- b. Select the Timebase menu and adjust the TIME/DIV and DELAY until one pulse is centered on the display.
- c. Select the Display menu and set the Display Mode to Averaged and the NUMBER OF AVERAGES to 64.
- d. Set the Bandwidth to 20 GHz
- e. Select the Channel menu and set the Attenuation Factor for Channel 4 to 10 to account for the 20 dB attenuator.
- f. Select the Delta V menu and turn the V Markers on.

6

- g. Set the Preset Levels to 20–80% and press Auto Level Set:

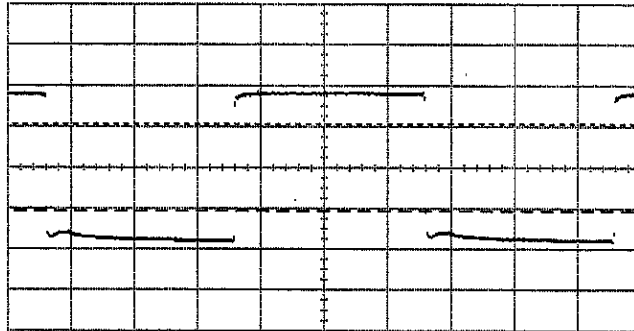

- h. Select the Timebase menu and adjust the Time/Div to 100 ps/div.
i. Adjust the Delay until the positive edge of the pulse is centered.
j. Select the Delta t menu and turn the T Markers on.
k. Set the START ON POS EDGE 1 and STOP ON POS EDGE 1 and press the Precise Edge Find key:

6

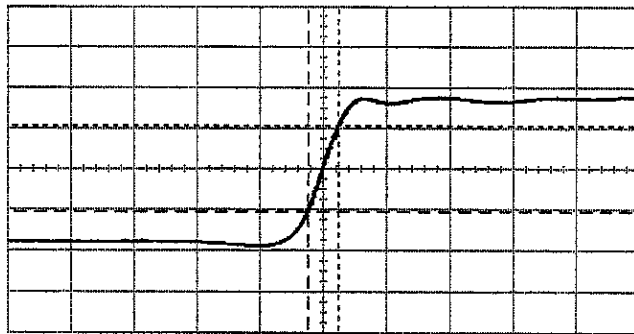

Figure 6-6. ~~TRIGGER~~ Risetime – 100 ps/div

4. Check that the measured risetime (Δt) < 100 ps, and record the measured risetime on the Test Record.

Falltime

5. On the oscilloscope:
 - a. Select the Timebase menu and adjust the DELAY until the negative edge of the pulse is centered.
 - b. Select the Delta t menu.
 - c. Set the START ON NEG EDGE 1 and STOP ON NEG EDGE 1 and press the Precise Edge Find key.
6. Check that the measured falltime (Δt) < 100 ps, and record the measured falltime on the Test Record.

Dutycycle Verification

7. On the oscilloscope:
 - a. Select the Timebase menu and adjust the Time/Div to 5 ns/div.
 - b. Set the Delay to 16 ns.
 - c. Press More on the bottom row of keys, and select the Measure menu.
 - d. Press More on the right-hand row of keys and select Duty Cycle to measure the Duty Cycle.
 - e. Check that the Dutycycle is 50% nominal.

6

Level Verification

8. On the oscilloscope:
 - a. Press More on the bottom row of keys.
 - b. Select the Delta V menu and set the Preset Levels to 0-100%.
 - c. Press Auto Level Set.
 - d. Check that the Low Level V(1) is 0 V nominal.
 - e. Check that the High Level V(2) is 1.8 V nominal.

Outputs

Tests Depending on the options fitted, carry out the indicated tests in order for Channel 1.

If you have a dual channel instrument, then carry out the indicated tests for Channel 2.

Table 6-3. Output Test Summary

	Channel 1			Channel 2	
	Single Channel		Dual Channel		
	Standard	Option 001	Option 002/003	Option 003 PULSE	Option 002 PULSE/DATA
1 Delay Performance	✓	✓	✓	✓	×
2 Extended Delay Performance	×	✓	✓	×	×
3 Inter-Channel Delay Performance	×	×	✓	x ¹	x ¹
4 Width Performance	✓	✓	✓	✓	×
5 Duty-cycle Verification	✓	✓	✓	✓	×
6 Level Performance	✓	✓	✓	✓	✓
7 Level Window Performance	✓	✓	✓	✓	✓
8 Overshoot & Ringing Performance	✓	✓	✓	✓	✓
9 Transition Time Performance	✓	✓	✓	✓	✓
10 Jitter Performance	✓	✓	✓	✓	✓
11 Data Performance	×	×	×	×	✓

6

1 Test carried out as part of Channel 1 tests

- Equipment**
- Oscilloscope (HP 54121T)
 - 3 × Cable (SMA m-m)
 - 3 × 20 dB Attenuator (33340C)
 - Adapter (SMA m-m)
 - Power Splitter (11667B)

Delay Performance

The Delay Performance test applies only to **PULSE** channels.

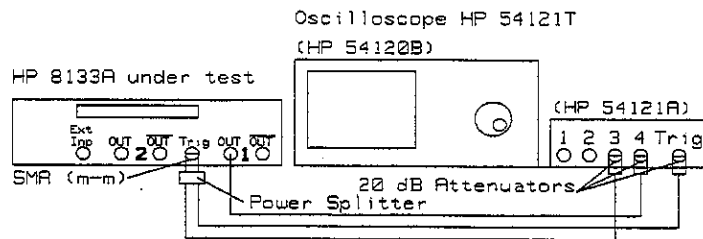

Figure 6-7.

PULSE Channel Delay Test Set-up (Channel 1)

1. Connect the HP 8133A to the oscilloscope as shown in Figure 6-7.
 - a. Connect the Output of the Channel under test to the Channel 4 Input on the 'scope.
 - b. Connect the **TRIGGER** Output via the Power Splitter to the Trigger Input and Channel 3 Input on the 'scope.

6

2. Set up the HP 8133A as follows:

TIMEBASE	INT/EXT	INTernal
	FREQ/PERIOD	PERIOD 30.000 ns
TRIGGER	AMPL/HIGH	HIGH +0.5 V
	OFFS/LOW	LOW -0.5 V
	DIVIDE/BT0	DIVIDE ÷1
	DISABLE	Off (Output enabled)
PULSE 1	PULSE/SQUAR	SQUAR
	AMPL/HIGH	HIGH +0.5 V
	OFFS/LOW	LOW -0.5 V
	DELAY/PHASE	DELAY 0 ps
	DELAY/PHASE	SKEW 0 ps
	DISABLE	Off (OUTPUT enabled)

3. On the oscilloscope:

- a. Press **AUTOSCALE**.
- b. Select the Timebase menu and adjust the Time/Div to 5 ns/div.
- c. Adjust the Delay to 25 ns.
- d. Select the Display menu and set the number of averages to 16.
- e. Select the Delta V menu and switch the Voltage Markers on.
- f. Assign Marker 1 to Channel 3 and Marker 2 to Channel 4.
- g. Set the Preset Levels to 50-50% and press Auto Level Set.
- h. Select the Delta t menu and switch the T Markers on.
- i. Assign START ON POS EDGE 1 and STOP ON POS EDGE 1.
- j. Press the Precise Edge Find key.

6

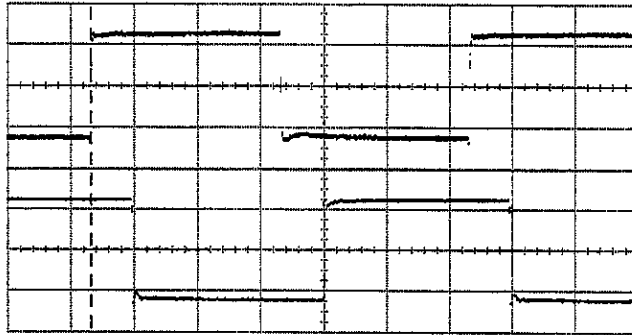

Figure 6-8. Δt_0 : 5.00 ns/div, DELAY = 25.0000 ns

4. Record the measured Δt on the Test Record as the Fixed Delay Δt_0 for the Channel under test.
5. Set the HP 8133A Channel Delay to +5 ns.
6. On the oscilloscope press **Clear Display** and then the Precise Edge Find key.

6

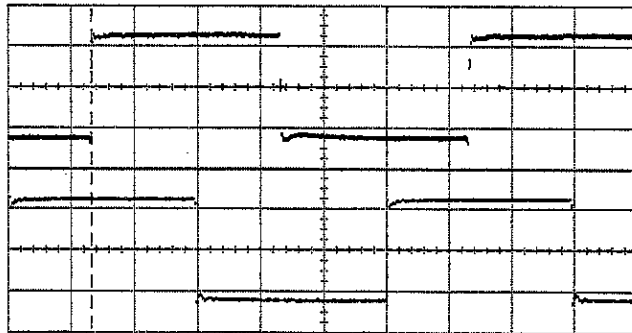

Figure 6-9. Δt_{+5} : 5.00 ns/div, DELAY = 25.0000 ns

7. Subtract the Fixed Delay Δt_0 from the measured Δt and record the result on the Test Record as Δt_{+5} for the Channel under test. The result should be 5 ns \pm 0.05 ns.
8. Set the HP 8133A Channel Delay to +10 ns.

9. On the oscilloscope:
 - a. Assign STOP ON POS EDGE 2
 - b. Press **Clear Display** and then the Precise Edge Find key.
10. Subtract the Fixed Delay Δt_0 from the measured Δt and record the result on the Test Record as Δt_{+10} for the Channel under test. The result should be $10 \text{ ns} \pm 0.05 \text{ ns}$.
11. *The following Extended Delay test applies only to Channel 1, with Option 001, 002 or 003 instruments. If you are testing a Standard HP 8133A without Options, go straight to "Width Performance".*

Extended Delay Performance

12. Set the HP 8133A Channel 1 Delay to +15 ns.
13. On the oscilloscope press **Clear Display** and then the Precise Edge Find key.
14. Subtract the Fixed Delay Δt_0 from the measured Δt and record the result on the Test Record as Δt_{+15} for Channel 1. The result should be $15 \text{ ns} \pm 0.05 \text{ ns}$.
15. Set the HP 8133A Channel 1 Delay to -5 ns.

6

16. On the oscilloscope:
 - a. Assign STOP ON POS EDGE 1
 - b. Press **Clear Display** and then the Precise Edge Find key:

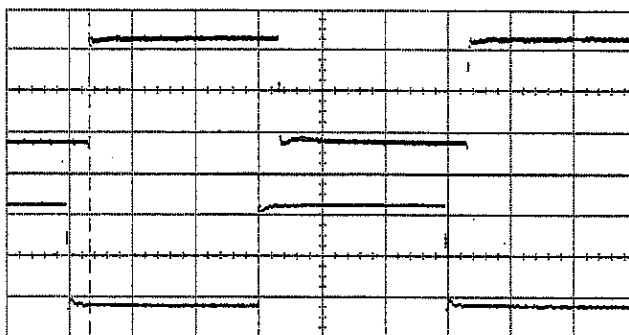

Figure 6-10. Δt_s : 5.00 ns/div, DELAY = 25.0000 ns

17. Subtract the Fixed Delay Δt_0 from the measured Δt and record the result on the Test Record as Δt_s for Channel 1. The result should be -5 ns \pm 0.05 ns.
18. Set up the HP 8133A as follows:

6

PULSE 1	PULSE/SQUAR	PULSE
	WIDTH/DCYC	WIDTH 5 ns
	DELAY/PHASE	DELAY 0 ps

19. On the oscilloscope press **Clear Display** and then the Precise Edge Find key.
20. Record the measured Δt on the Test Record as the PULSE mode Fixed Delay Δt_{p0} for Channel 1.
21. Set the HP 8133A Channel 1 Delay to -5 ns.
22. On the oscilloscope press **Clear Display** and then the Precise Edge Find key.
23. Subtract the PULSE mode Fixed Delay Δt_{p0} from the measured Δt and record the result on the Test

Record as $\Delta t_{p_{-5}}$ for Channel 1. The result should be $-5 \text{ ns} \pm 0.05 \text{ ns}$.

24. Set the HP 8133A Channel 1 Delay to $+5 \text{ ns}$.
25. On the oscilloscope press **Clear Display** and then the Precise Edge Find key.
26. Subtract the PULSE mode Fixed Delay Δt_{p_0} from the measured Δt and record the result as $\Delta t_{p_{+5}}$ on the Test Record. The result should be $+5 \text{ ns} \pm 0.05 \text{ ns}$.
27. *The Inter-Channel Delay test only applies to dual channel instruments. If you are testing a single-channel HP 8133A, or have already carried out the Inter-Channel Delay test while testing Channel 1, go straight to "Width Performance".*

Inter-Channel Delay Performance (Options 002 & 003 only)

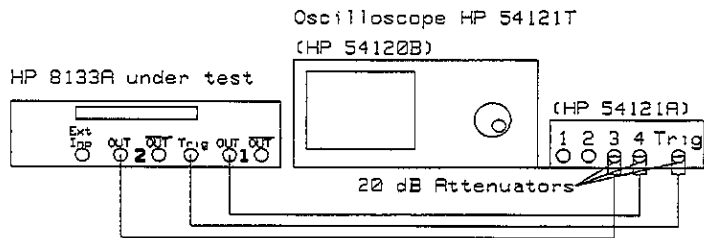

6

Figure 6-11. Inter-Channel Delay Test Set-up

28. Connect the HP 8133A to the 'scope as shown in Figure 6-11.

29. Set up the HP 8133A as follows:

PULSE 1	DELAY/PHASE	DELAY 0 ps
	WIDTH/DCYC	WIDTH 1 ns
PULSE/DATA 2 ¹	DATA/SQUAR	SQUAR
PULSE 2 ²	PULSE/SQUAR	SQUAR
	DELAY/PHASE ²	DELAY 0 ps
	AMPL/HIGH	HIGH +0.5 V
	OFFS/LOW	LOW -0.5 V
	DISABLE	Off (OUTPUT enabled)

1 Option 002 only

2 Option 008 only

30. On the oscilloscope:

- Select the Channels menu and set the Attenuation Factor for Channel 3 to 10.
- Set the VOLTS/DIV for Channel 3 to 400 mV/div.
- Select the Timebase menu and adjust the TIME/DIV to 1 ns/div and the DELAY to 16 ns.
- Select the Delta t menu and press the Precise Edge Find key.

- 6

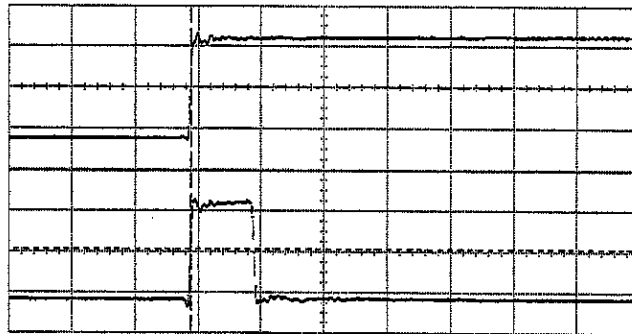

Figure 6-12. Δt_{ic} : 1.00 ns/div DELAY = 16.0000 ns

31. Record the measured Δt as Δt_{ic} . The result should be 0 ns \pm 0.15 ns.

32. Set the HP 8133A Channel 1 Delay to -3 ns.
33. On the oscilloscope press **Clear Display**
34. If necessary, select the Timebase menu and adjust the DELAY to get both pulses on the display. Then reselect the Delta t menu.

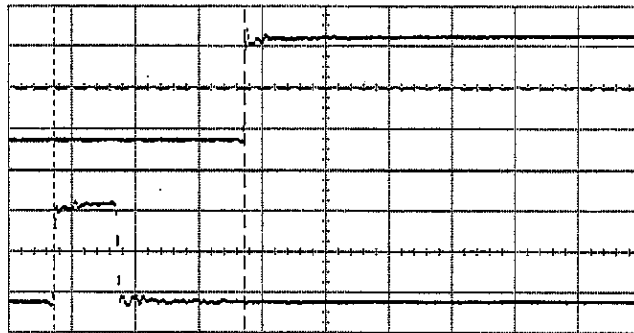

Figure 6-13. Δt_{ic-3} : 1.00 ns/div Delay = 16.0000 ns

35. Press the Precise Edge Find key.
36. Subtract the fixed delay Δt_{ic} from the measured Δt and record the result as Δt_{ic-3} . The result should be $-3 \text{ ns} \pm 0.05 \text{ ns}$. **6**
37. Set the HP 8133A Channel 1 Delay to +5 ns.
38. On the oscilloscope press **Clear Display**.

39. If necessary, select the Timebase menu and adjust the DELAY to get both pulses on the display. Then reselect the Delta t menu:

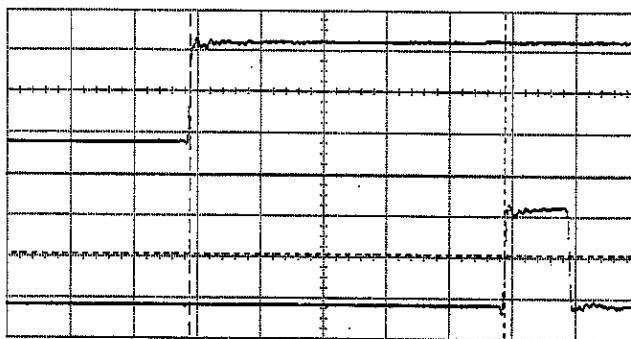

Figure 6-14. $\Delta t_{ic+5} : 1.00 \text{ ns/div}$

40. Press the Precise Edge Find key.
41. Subtract the fixed delay Δt_{ic} from the measured Δt and record the result as Δt_{ic+5} . The result should be $+5 \text{ ns} \pm 0.05 \text{ ns}$.

6

Width Performance

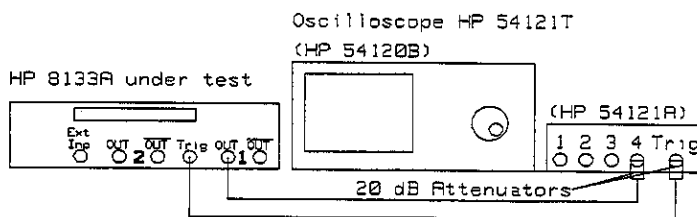

Figure 6-15. **PULSE** Channel Width Test Set-up

42. Connect the HP 8133A to the oscilloscope as shown in Figure 6-15.

6-22 Testing the HP 8133A

43. Set up the HP 8133A as follows:

TIMEBASE	INT/EXT	INTernal
	FREQ/PERIOD	PERIOD 30.000 ns
TRIGGER	AMPL/HIGH	HIGH +0.5 V
	OFFS/LOW	LOW -0.5 V
	DIVIDE/BITS	DIVIDE ÷1
	DISABLE	Off (Output enabled)
PULSE	PULSE/SQUAR	SQUAR
	AMPL/HIGH	HIGH +0.5 V
	OFFS/LOW	LOW -0.5 V
	DELAY/PHASE	DELAY 0 ps
	DELAY/PHASE	SKEW 0 ps
	DISABLE	Off (OUTPUT enabled)

44. On the oscilloscope:

- a. Press **AUTOSCALE**.
- b. Select the Display menu and set the number of averages to 16.
- c. Select the Timebase menu and set the Time/Div to 5 ns/div.
- d. Select the Delta V menu and switch the V Markers on.
- e. Set the Preset Levels to 50-50% and press Auto Level Set.

6 -

45. Set up the HP 8133A as follows:

PULSE	PULSE/SQUAR	PULSE
	WIDTH/DCYCLE	WIDTH 10 ns

46. On the oscilloscope:

- a. Press **Clear Display**.
- b. Select the Timebase menu and set the Time/Div to 2 ns/div.
- c. Adjust the Delay until one pulse is centered in the display

- d. Select the Delta t menu and switch the T Markers on.
- e. Assign START ON POS EDGE 1 and STOP ON NEG EDGE 1.
- f. Press the Precise Edge Find key.

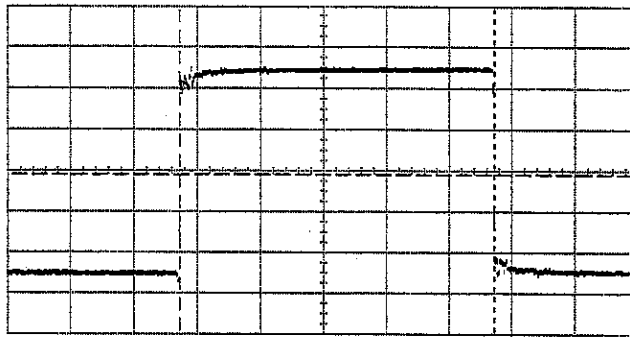

Figure 6-16. Width_{max} : 2.00 ns/div

47. Record the measured pulse-width (Δt) for the Channel under test on the Test Record as Width_{max}, it should be 10 ns \pm 0.1 ns.
48. Set up the HP 8133A as follows:

PULSE	WIDTH/DCYCLE	WIDTH 150 ps
-------	--------------	--------------

49. On the oscilloscope:
 - a. Select the Timebase menu and set the Time/Div to 100 ps/div.
 - b. Adjust the Delay until one pulse is centered in the display
 - c. Select the Delta t menu and press Precise Edge Find.
50. Record the measured pulse-width (Δt) for the Channel under test on the Test Record as Width_{min}, it should be 150 ps \pm 100 ps.

Dutycycle Verification

51. Set up the HP 8133A as follows:

TIMEBASE	FREQ/PERIOD	PERIOD 20.000 ns
PELSE	WIDTH/DCYCLE	DCYCLE 50.0%

52. On the oscilloscope:

- a. Press **AUTOSCALE**
- b. Select the Display menu and set the number of averages to 16.
- c. Select More on the bottom row of keys and select the Measure menu.
- d. Select More on the right-hand row of keys and measure the Duty Cycle.

53. Check that the measured Duty Cycle is 50% nominal.

54. Set the Duty Cycle to 10%.

Level Performance

55. Disable the HP 8133A outputs.
56. Keep the equipment as shown in Figure 6-15, but remove the 20 dB attenuator on Channel 4 of the oscilloscope.

Minimum Amplitude

57. Set up the HP 8133A as follows:

TIMEBASE	INT/EXT	Internal
	FREQ/PERIOD	PERIOD 80.000 ns
TRIGGER	AMPL/HIGH	HIGH +0.5 V
	OFFS/LOW	LOW -0.5 V
	DIVIDE/BITS	DIVIDE ÷1
	DISABLE	Off (Output enabled)
PULSE	PULSE/SQUAR	SQUAR
	AMPL/HIGH	HIGH +0.15 V
	OFFS/LOW	LOW -0.15 V
	DELAY/PHASE	DELAY 0 ps
	DELAY/PHASE	SKEW 0 ps
	DISABLE	Off (OUTPUT enabled)

6

58. On the oscilloscope:
 - a. Press **AUTOSCALE**
 - b. Select the Display menu and set the number of averages to 64.
 - c. Select Channels and set the attenuation factor for Channel 4 to 1.
 - d. Select the Delta V menu and switch on the V Markers.
 - e. Set the Preset Levels to 0-100% and press Auto Level Set.
59. Check the Low-level voltage V(1) is $-150 \text{ mV} \pm 29 \text{ mV}$ and record the measured value on the Test Record for the Channel under test.

60. Check the High-level voltage V(2) is $150 \text{ mV} \pm 29 \text{ mV}$ and record the measured value on the Test Record for the Channel under test.

Maximum Amplitude

61. Disable the HP 8133A outputs.
62. Add a 20 dB Attenuator to the Channel 4 input of the oscilloscope.
63. Re-enable the HP 8133A outputs.
64. Set up the HP 8133A as follows:

PULSE	AMPL/HIGH	AMPL 3.0 V
	OFFS/LOW	OFFS 0.0 V

65. On the oscilloscope:
 - a. Press **AUTOSCALE**
 - b. Select Channels and set the attenuation factor for Channel 4 to 10.
 - c. Select the Delta V menu and switch on the V Markers.
 - d. Set Preset Levels to 0-100% and press Auto Level Set.

6

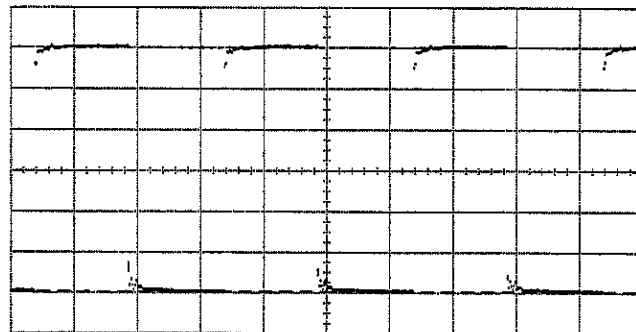

Figure 6-17. Maximum Amplitude : 500 mV/div

66. Check the Low-level voltage V(1) is $-1.5 \text{ V} \pm 0.11 \text{ V}$ and record the measured value on the Test Record for the Channel under test.

67. Check the High-level voltage V(2) is $1.5 \text{ V} \pm 0.11 \text{ V}$ and record the measured value on the Test Record for the Channel under test.

Level Window Performance

Maximum High-level

68. Set up the HP 8133A as follows:

PULSE	AMPL/HIGH	HIGH 4.00 V
	OFFS/LOW	LOW 3.70 V

69. On the oscilloscope:

- Select the Channels menu and set the OFFSET for Channel 4 to +3.8 V and the VOLTS/DIV to 100 mV/div.
- Select the Delta V menu and press Auto Level Set.

70. Check the High-level voltage V(2) is $4 \text{ V} \pm 0.106 \text{ V}$ and record the measured value on the Test Record for the Channel under test.

Minimum Low-level

71. Set up the HP 8133A as follows:

PULSE	AMPL/HIGH	HIGH -1.70 V
	OFFS/LOW	LOW -2.00 V

72. On the oscilloscope:

- Select the Channels menu and set the OFFSET for Channel 4 to -1.85 V.
- Select the Delta V menu and press Auto Level Set.

73. Check the Low-level voltage V(1) is $-2.00\text{ V} \pm 0.066\text{ V}$ and record the measured value on the Test Record for the Channel under test.

Overshoot and Ringing Performance

74. Set up the HP 8133A as follows:

PULSE	PULSE/SQUAR	SQUAR
	AMPL/HIGH	HIGH +1.5 V
	OFFS/LOW	LOW -1.5 V
	DELAY/PHASE	DELAY 0 ps
	DELAY/PHASE	SKEW 0 ps
	DISABLE	Off (OUTPUT enabled)

75. On the oscilloscope:
- a. Press **AUTOSCALE**
 - b. Select the Display menu and set the Number of Averages to 64.
 - c. Select the Timebase menu and set the Sweep Time to 5 ns/div.
 - d. Select the Delta V menu and switch on the V Markers.
 - e. Set the Preset Levels to Variable Levels and set the Variable Levels to 85% and 115%.
 - f. Press Auto Level Set.
 - g. Select the Timebase menu and set the Sweep Time to 500 ps/div.
 - h. Adjust the Delay to center the positive edge.
 - i. Select the Channels menu and set the Channel 4 Offset to 1.45 V.
 - j. Set the VOLTS/DIV to 200 mV/div.

6

76. Check that the Overshoot of the Positive edge is within the $\pm 15\%$ of amplitude limits, and record the result on the Test Record for the Channel under test.

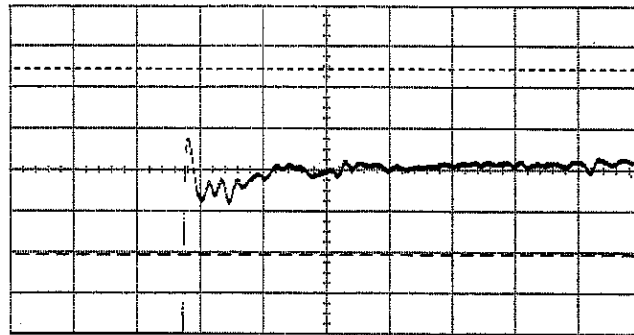

Figure 6-18. Positive Edge Overshoot and Ringing

77. On the oscilloscope:
- Select the Channels menu and set the Channel 4 Offset to 0 V and Sensitivity to 500 mV/div.
 - Select the Timebase menu and set the Sweep Time to 5 ns/div.
 - Select the Delta V menu and set the Variable Levels to -15% and +15%.
 - Press Auto Level Set.
 - Select the Timebase menu and set the Sweep Time to 500 ps/div.
 - Adjust the Delay to center the negative edge.
 - Select the Channels menu and set the Channel 4 Offset to -1.45 V.
 - Set the VOLTS/DIV to 200 mV/div.
78. Check that the Overshoot of the Negative edge is within the $\pm 15\%$ of amplitude limits, and record the result on the Test Record for the Channel under test.

Note



The maximum specified Overshoot is actually $\pm 15\% \pm 20$ mV which is ± 470 mV for an amplitude of 3 V.

If the Overshoot is not within the $\pm 15\%$ of amplitude limits, make a precise measurement against the specification of ± 470 mV.

Transition Time Performance

Risetime 10–90%

79. On the oscilloscope:

- a. Press **AUTOSCALE**
- b. Select the Display menu and set the Bandwidth to 20 GHz.
- c. Select the Delta V menu and switch on the V Markers.
- d. Set the Preset Levels to 10–90% and press Auto Level Set.
- e. Select the Timebase menu and set the TIME/DIV to 20 ps/div.
- f. Adjust the Delay until a positive edge is centered.
- g. Select the Delta t menu and switch on the T Markers.
- h. Select START ON POS EDGE 1 and STOP ON POS EDGE 1.

6

- i. Press Precise Edge Find.

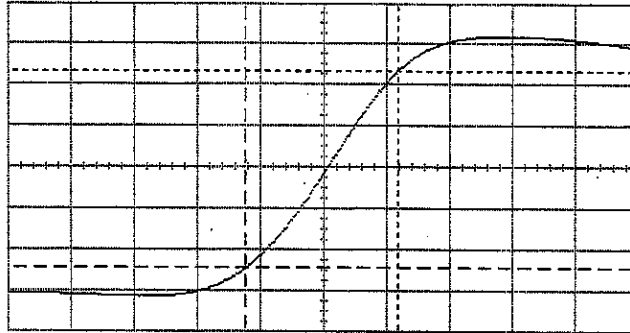

Figure 6-19. Risetime 10-90%

80. Check that the measured rise-time (Δt) is < 100 ps, and record the measured value on the Test Record for the Channel under test.

Risetime 20-80%

6

81. On the oscilloscope:
 - a. Select the Timebase menu and set TIME/DIV to 5 ns/div.
 - b. Select the Delta V menu and set the Preset Levels to 20-80%.
 - c. Press Auto Level Set.
 - d. Select the Timebase menu and set TIME/DIV to 20 ps/div.
 - e. Select the Delta t menu and press Precise Edge Find.
82. Check that the measured rise-time (Δt) is < 60 ps, and record the measured value on the Test Record for the Channel under test.

Falltime 20–80 %

83. On the oscilloscope:
 - a. Select the Timebase menu and adjust the Delay until a negative edge is centered on the display.
 - b. Select the Delta t menu and set START ON NEG EDGE 1 and STOP ON NEG EDGE 1.
 - c. Press Precise Edge Find.
84. Check that the measured fall-time (Δt) is < 60 ps, and record the measured value on the Test Record for the Channel under test.

Falltime 10–90 %

85. On the oscilloscope:
 - a. Select the Timebase menu and set the TIME/DIV to 5 ns/div.
 - b. Select the Delta V menu and change the Preset Levels to 10–90%.
 - c. Press Auto Level Set.
 - d. Select the Timebase and set the Sweep Time to 20 ps/div.
 - e. Select the Delta t menu and press Precise Edge Find. 6
86. Check that the measured fall-time (Δt) is < 100 ps, and record the measured value on the Test Record for the Channel under test.

Jitter Performance

87. Set up the HP 8133A as follows:

	STD	#001	#002	#003
PULSE/SQUAR	PULSE	PULSE	SQUARE	PULSE
AMPL/HIGH	HIGH +1.5V	HIGH +1.5V	HIGH +1.5V	HIGH +1.5V
OFFS/LOW	LOW -1.5V	LOW -1.5V	LOW -1.5V	LOW -1.5V
WIDTH/DCYCLE	WIDTH 10ns	WIDTH 10ns		WIDTH 10ns
DELAY/PHASE		DELAY +5ns	DELAY +5ns	
DELAY/PHASE		SKEW 0 ps	SKEW 0ps	
DISABLE	OFF	OFF	OFF	OFF
STD	Ch.1			
#001		Ch.1		
#002		Ch.1	Ch.2	
#003		Ch.1		Ch.2

88. On the oscilloscope:

- a. Press **AUTOSCALE**.
- b. Select the display menu and set Average mode with Number of Averages 64.
- c. Set the Bandwidth to 20 GHz.
- d. Select the Trigger menu and switch HF Sens on.
- e. Select the Delta V menu and switch on the V Markers.
- f. Set the Preset Levels to 50-50% and press Auto Level Set.
- g. Select the Delta t menu and switch on the T Markers.
- h. Set START ON POS EDGE 1 and STOP ON NEG EDGE 2.

6

i. Press Precise Edge Find:

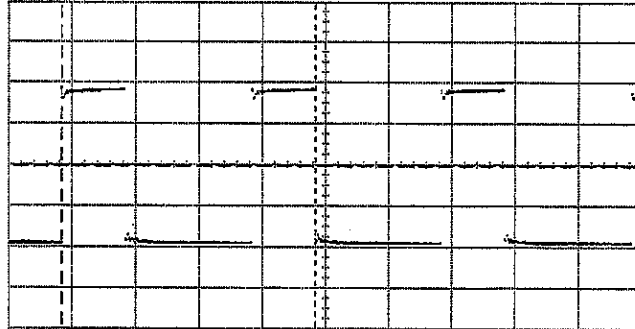

- j. Select the Timebase menu and set the TIME/DIV to 20 ps/div.
- k. Adjust the Delay until the 2nd negative edge is centered (approximately 60 ns).
- l. Select the Channels menu and set the Channel 4 VOLTS/DIV to 20 mV/div.
- m. Set the OFFSET to 0 V.
- n. Select More and then the Histogram menu.
- o. Select Time Histogram.
- p. Select Source is Chan 4.
- q. Set the Window Marker 1 to +15 mV.
- r. Set the Window Marker 2 to -15 mV. The window is now 1 % of the signal amplitude around 0 V.
- s. Select Acquire and set the Number of Samples to 1000
- t. Press Start Acquiring.

6

- u. After 1000 samples are completed, select Results and press Sigma:

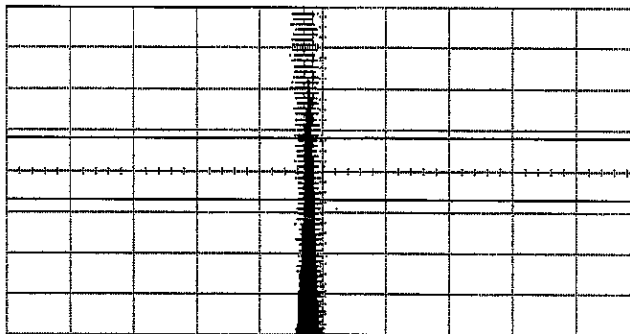

Figure 6-20. Jitter Histogram

89. Record the Sigma value on Test Record as the RMS Jitter for the Channel under test, which should be < 5 ps.

Note



Sigma is not actually the true RMS Jitter value.

The Sigma value includes the effect of the falltime of the ± 15 mV window, and the oscilloscope's trigger/timebase jitter.

If the Sigma value is not within specification, make a precise calculation of the true RMS Jitter:

- a. Measure and eliminate the falltime error:

$$X = \frac{(6 \times \text{Sigma}) - (\text{Window Falltime})}{6}$$

- b. Eliminate the oscilloscope's Jitter:

$$\text{RMSJitter} = \sqrt{X^2 - \text{TimebaseJitter}^2 - \text{TriggerJitter}^2}$$

Refer to Product Note 54120-2 for information on how to measure the Timebase and Trigger Jitter of the oscilloscope.

- c. Indicate on the Test Record that you have corrected the measured Sigma to the true RMS Jitter value.

Data Performance

The Data Performance test applies only to **PULSE/DATA** Channel 2 (Option 002).

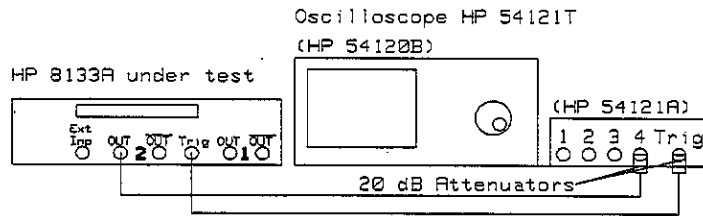

Figure 6-21. PULSE/DATA Channel Data Test Set-up
32 BIT RZ

1. Set up the HP 8133A as follows:

PULSE	PULSE/SQUAR	SQUAR
TIMEBASE	INT/EXT	INTernal
	FREQ/PERIOD	FREQ 3.000 GHz
TRIGGER	AMPL/HIGH	HIGH +0.5 V
	OFFS/LOW	LOW -0.5 V
	DIVIDE/BIT0	BIT 0
	DISABLE	Off (Output enabled)
PULSE/DATA	DATA/SQUAR	DATA
	AMPL/HIGH	HIGH +0.5 V
	OFFS/LOW	LOW -0.5 V
	RZ/NRZ	RZ
	32 BIT/PRBS	32 BIT
	DISABLE	Off (OUTPUT enabled)

6

2. Set Bits 0 to 30 of the 32 Bit data to '1' and Bit 31 to 0:



3. On the oscilloscope:
 - a. Press **AUTOSCALE**.
 - b. Select the Timebase menu and set the TIME/DIV to 500 ps/div and the DELAY to 16 ns.
 - c. Select the Delta V menu and switch on the V Markers.
 - d. Set the Preset Levels to 50–50% and press Auto Level Set.
 - e. Select the Delta t menu and switch on the T Markers.
 - f. Adjust the START ON POS EDGE number until the start marker is on the first positive edge after the 0 in the bitstream (Bit 0):

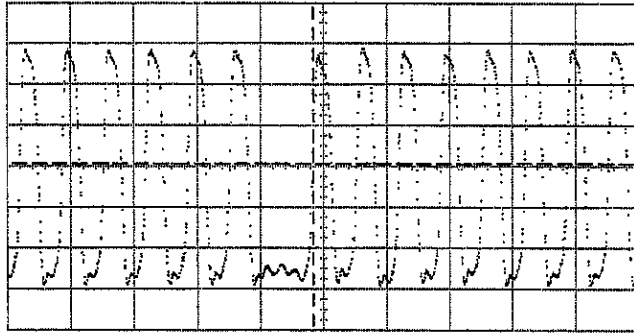

Bit 0

- g. Select the Timebase menu and set the TIME/DIV to 2 ns.
- h. Select the Delta t menu and set the STOP ON POS EDGE number to (START number + 30).
- i. Select the Timebase menu and set the TIME/DIV to 500 ps/div and the DELAY to 27 ns.
- j. Select the Delta t menu

4. Check that the STOP marker is on the rising edge of the last pulse before the 0 in the bitstream (Bit 30), and record the result on the Test Record:

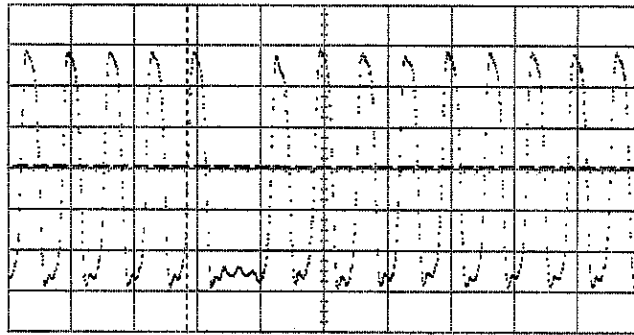

Bit 30

5. Change Bit 31 of the data to '1'.
6. Press **Clear Display** on the 'scope and check that the '1' pulse appears in the bitstream on the 'scope, and record the result on the Test Record:

6

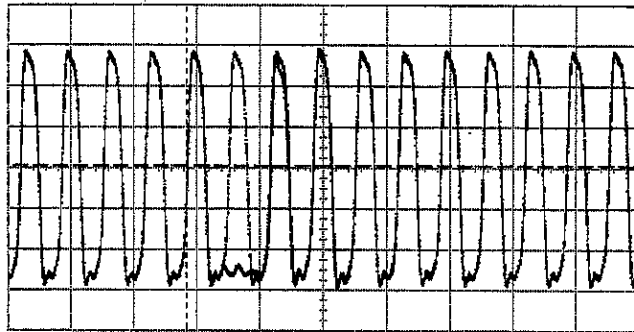

Bit 31

- c. Select the Timebase menu and adjust the DELAY until this edge is the *first* edge on the screen:

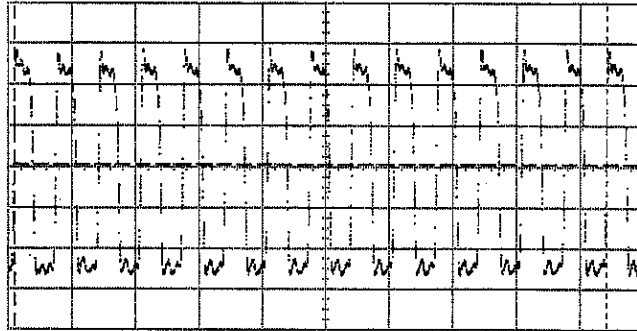

Bit 0 to Bit 28

- d. Select the Delta t menu and select START ON POS EDGE 1 and STOP ON POS EDGE 15 (Bit 28).
e. Select the Timebase menu and adjust the DELAY until the gap following the stop marker is shown (Bits 29,30,31).

9. On the HP 8133A under test move the DATA EDIT cursor to Bit 30 and toggle Bit 30 from '0' to '1':

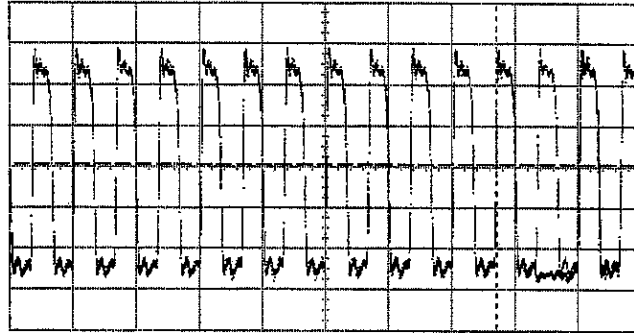

Bit 30

10. Check on the 'scope that a '1' pulse appears in the gap between the Bit 28 '1' and the Bit 0 '1'. Record the result on the Test Record.

HP 8133A Performance Test Record

Test Facility:

_____	Report No.	_____
_____	Date	_____
_____	Customer	_____
_____	Tested By	_____

Model HP 8133A 3 GHz Pulse Generator

Serial No.	_____	Ambient temperature	_____ °C
Options	_____	Relative humidity	_____ %
Firmware Rev.	_____	Line frequency	_____ Hz

6

Special Notes:

HP 8133A Performance Test Record

Test Equipment Used:

Description	Model No.	Trace No.	Cal. Due Date
1. Oscilloscope	HP 54121T	_____	_____
2. Counter	HP 5334B	_____	_____
3. Pulse Generator	HP 8133A	_____	_____
4. _____	_____	_____	_____
5. _____	_____	_____	_____
6. _____	_____	_____	_____
7. _____	_____	_____	_____
8. _____	_____	_____	_____
9. _____	_____	_____	_____
10. _____	_____	_____	_____
11. _____	_____	_____	_____
12. _____	_____	_____	_____
13. _____	_____	_____	_____
14. _____	_____	_____	_____
15. _____	_____	_____	_____
16. _____	_____	_____	_____
17. _____	_____	_____	_____
18. _____	_____	_____	_____

6

HP 8133A Performance Test Record

	HP 8133A 3 GHz Pulse Generator	No. _____	Date _____		
Test Section	Test Description	Minimum Spec.	Result	Maximum Spec.	Measurement Uncertainty
PERIOD	Internal Clock—Low Frequency		ns		
	measured at PERIOD 30 ns				
	Output Period	29.85 ns		30.15 ns	
	measured at PERIOD 10 ns				
	Output Period	9.95 ns		10.05 ns	
	External Frequency Counter		GHz		
	measured at External PERIOD 10.00 ns				
	Displayed Period	9.99 ns		10.01 ns	
	measured at External FREQUENCY 1.000 GHz				
	Displayed Frequency	0.999 GHz		1.001 GHz	
	Internal Clock—High Frequency		GHz		
	measured at FREQUENCY 3.0000 GHz				
	Output Frequency	2.985 GHz		3.015 GHz	
TRIGGER	Transition Time		ps		
	Risetime	-		100 ps	
	Falltime	-		100 ps	

6

HP 8133A Performance Test Record

HP 8133A 3 GHz Pulse Generator No. _____ Date _____

Test Section	Test Description	Minimum Spec.	Result		Maximum Spec.	Measurement Uncertainty	
			Channel 1	Channel 2			
6	Outputs Delay		ns	ns			
	Δt_0	-		1	-		
	Δt_{+5}	4.95 ns		1	5.05 ns		
	Δt_{+10}	9.95 ns		1	10.05 ns		
	Extended Delay (Option 001)		ns	ns			
	Δt_{+15}	14.95 ns		-	15.05 ns		
	Δt_{-5}	-5.05 ns		-	-4.95 ns		
	Δt_{p0}	-		1	-		
	Δt_{p+5}	4.95 ns		1	5.05 ns		
	Δt_{p+10}	9.95 ns		1	10.05 ns		
	Inter-channel Delay (Option 002/003)			ns			
	Δt_{ic}	-0.15 ns				+0.15 ns	
	Δt_{ic-3}	-3.05 ns				-2.95 ns	
	Δt_{ic+5}	4.95 ns				5.05 ns	
	Width			ns	ns		
	$Width_{max}$	9.9 ns			1	10.1 ns	
	$Width_{min}$	50 ps		ps	ps	1	250 ps
	Level						
	measured at Minimum Amplitude:			mV	mV		
	Low-level V(1)	-179 mV				-121 mV	
	High-level V(2)	121 mV				179 mV	
	measured at Maximum Amplitude:			V	V		
	Low-level V(1)	-1.61 V				-1.39 V	
	High-level V(2)	1.39 V				1.61 V	

1 Option 003 ~~PULSE~~ only .

HP 8133A Performance Test Record

HP 8133A 3 GHz Pulse Generator		No. _____	Date _____				
Test Section	Test Description	Minimum Spec.	Result		Maximum Spec.	Measurement Uncertainty	
			Channel 1	Channel 2			
Outputs	Level Window						
	measured at Maximum High-level:		V	V			
	High-level V(2)	3.894 V			4.106 V	_____	
	measured at Minimum Low-level:		V	V			
	Low-level V(1)	-2.066 V			-1.944 V	_____	
	Overshoot and Ringing						
	Positive Edge	-	PASS/FAIL	PASS/FAIL	-	-	
	Measured Overshoot ¹	-470 mV			470 mV	_____	
	Negative Edge	-	PASS/FAIL	PASS/FAIL	-	-	
	Measured Overshoot ¹	-470 mV			470 mV	_____	
	Transition Time²			ps	ps		
	Risetime 10-90%	-				100 ps	_____
	Risetime 20-80%	-				60 ps	_____
	Falltime 20-80%	-				60 ps	_____
	Falltime 10-90%	-				100 ps	_____
	Jitter²			ps	ps		
	RMS Jitter (Sigma)	-				5 ps	_____
	Corrected true RMS Jitter:	-	YES/NO	YES/NO	-	-	
	Data²						
	32 BIT RZ						
Bit 30	-	-	PASS/FAIL	-	-		
Bit 31 '1'	-	-	PASS/FAIL	-	-		
32 BIT NRZ							
Bit 30 '1'	-	-	PASS/FAIL	-	-		

6

1 An overshoot measurement is only necessary if the PASS/FAIL test fails.

2 Measured using HP 54120 Series oscilloscope.

HP 8133A Specifications

Specifications describe the instruments warranted performance after a 30 minute warm-up period, with ambient temperature in the range 0 to 55°C, and 50 Ω load resistance at all outputs.

Non-warranted characteristics are described as 'typical' or 'nominal'.

All timing parameters are measured at 50% of amplitude.

TIMEBASE

Internal Clock

You can set the internal clock in terms of frequency or period:

	FREQUENCY	PERIOD
Range:	33.0 MHz to 3.0000 GHz	333 ps to 30.303 ns
Resolution:	3.5 digits, best case 100 kHz	3.5 digits, best case 1 ps
Accuracy:	±0.5% (±0.1% typical)	
Repeatability:	4 times better than accuracy	

7

External Clock

External Input

You can apply an external clock signal to the External Input:

Frequency Range:	33 MHz to 3 GHz
Input Coupling:	ac-coupled
Impedance:	50 Ω nominal
Minimum Swing:	300 mV, rise-time < 3 ns 0 dBm sinewave
Maximum Amplitude:	3V _{pp} , ± 20 V _{dc}

External Frequency Counter

You can measure and display the frequency of the external clock signal:

	FREQUENCY	PERIOD
Range:	33 MHz to 3.00 GHz (2 MHz to 3.50 GHz typical)	333 ps to 30.3 ns (296 ps to 500 ns typical)
Resolution:	10 kHz	1 ps
Accuracy:	$\pm 0.1\%$	

External Divide

You can divide the external clock signal by:

(1), 2, 4, 8, 16, 32, 64

as long as the internally available (divided) signal frequency > 33 MHz. (The instrument will continue to function down to 3 MHz, except for Option 002 PULSE/DATA Channel 2.)

7

TRIGGER

All specifications apply for Trigger Output frequency > 33 MHz.

Timing

	DIVIDEd mode	BIT 0 mode (Option 002 only)
Signal Format:	fixed Duty-cycle 50% nominal	
Transition Times (20% - 80%):	< 100 ps (typically < 60 ps)	
RMS Jitter:	< 5 ps (< 2 ps typical)	
Frequency:	Timebase Frequency divided by: (1), 2, 4, 8, 16, 32 or 64 (Minimum: 3 MHz typical)	Timebase Frequency divided by 32
Propagation Delay:	6 ns typical, External Input to Trigger Channel Output, with Trigger and External Dividers = 1	-2.0 ns typical, Start of Bit 0 on Channel 2 to Trigger Channel Output

Output Levels

You can set the Trigger Output levels in terms of either Amplitude/Offset or High-/Low-level. Levels apply for a 50 Ω load, offset level doubles into open circuits:

Voltage Window:	-4.00 V to +4.00 V
Amplitude Range:	0.50 V to 1.80 V
Resolution:	10 mV
Maximum External Voltage:	± 4 V

7

PULSE and PULSE/DATA

PULSE Timing (Channel 1 and Option 003 Channel 2)

		CHANNEL 1 or CHANNEL 2 (OPT 003)		CHANNEL 1 with OPT 001,002 or 003	
		PULSE mode	SQUARe mode	PULSE mode	SQUARe mode
Delay ¹	Range:	Not Applicable	0.000 ns to 10.000 ns	-5.000 ns to +5.000 ns	-5.000 ns to +15.000 ns
	Resolution:	Not Applicable	1 ps		
	Accuracy:	Not Applicable	±50 ps ²		
Phase ¹	Range:	Not Applicable	0° to 3600°	-3600° to +3600°	
	Resolution:	Not Applicable	0.1°		
Width ³	Range:	150 ps to Period-150 ps (Max. 10.000 ns)	Not Applicable	150 ps to Period-150 ps (Max. 10.000 ns)	Not Applicable
	Resolution:	1 ps	Not Applicable	1 ps	Not Applicable
	Accuracy:	±100 ps (±30 ps typical)	Not Applicable	±100 ps (±30 ps typical)	Not Applicable
Duty-cycle ³	Range:	0% to 100%	Not Applicable	0% to 100%	Not Applicable
	Resolution:	0.1%, best case 1 ps	Not Applicable	0.1%, best case 1 ps	Not Applicable
Skew ⁴	Max.Range:	Not Applicable	-5.000 ns to +5.000 ns		
Transition Times	10% - 90%:	< 100 ps (< 60 ps typical)			
	20% - 80%:	< 60 ps (< 40 ps typical)			
RMS Jitter:	< 5 ps (< 1 ps typical)				
Propagation Delay:	18.8 ns typical, Trigger Output to Channel Output, Trigger ÷ 1				

- 7 1 The Delay and Phase parameters are mutually exclusive. Phase settings are also subject to Delay, Skew and Period specifications and settings.
- 2 Delay variation only, if other parameters vary ±150 ps (±30 ps typical).
- 3 Width and Duty-cycle parameters are mutually exclusive. The Duty-cycle setting is also subject to the Width specification and setting.
- 4 Skew + Delay (or Phase) must be within the limits given under Delay above. The Delay specifications assume Skew = 0.

7-4 HP 8133A Specifications

PULSE Frequency (Option 003 Divided Mode only)

		CHANNEL 2	
		PULSE mode	SQUARe mode
Frequency:	Timebase frequency divided by: ¹		
	(1), 2, 4, 8, 16, 32, 64		
	(Minimum typically 3 MHz)		

¹ The TRIGGER frequency must also be divided by the same (or higher) divisor

PULSE/DATA Timing (Option 002 Channel 2)

	CHANNEL 2 (OPT 002)		
	SQUARe mode	DATA mode	
		32 BIT	PRBS
Propagation Delay:	18.8 ns typical, Trigger Output to Channel Output, Trigger ÷ 1 or -2.0 ns typical, Trigger Output to Channel Output, Trigger on Bit 0		
Frequency: ¹	Timebase Frequency divided by: (1), 2, 4, 8, 16, 32	Timebase Frequency	
Signal Format:	fixed Duty-cycle 50% nominal	32 bits programmable data RZ/NRZ selectable	PRBS 2 ²³ - 1, CCITT 0.151 Norm
RMS Jitter:	< 5 ps (< 2 ps typical)		< 10 ps typical ²
Transition Times (10% - 90%)	< 100 ps (< 60 ps typical)		
Transition Times (20% - 80%)	< 60 ps (< 40 ps typical)		

¹ Timebase Frequency \geq 33 MHz for all specifications.

² < 5 ps typical for Frequency < 2 GHz

7

Output Levels

Each channel has 50 Ω (nominal) differential outputs ($\overline{\text{OUTPUT}}$ and OUTPUT) at SMA connectors on the frontpanel. You can set the Output levels in terms of either Amplitude/Offset or High-/Low-level (Levels double when driving into open circuits):



Voltage Window:	-2.00 V to +4.00 V
Amplitude Range:	0.30 V to 3.00 V
Settling Time:	1 ns
Resolution:	10 mV
Level Accuracy:	$\pm 2\%$ $\pm 2\%$ of Amplitude ± 20 mV
Overshoot, Ringing:	< 15% of Amplitude ± 20 mV
Maximum External Voltage:	± 3 V
Inter-output Skew:	< 20 ps typical ($\overline{\text{OUTPUT}}/\text{OUTPUT}$)
Short-circuit Current:	$-80 \text{ mA} \leq I_{sc} \leq 160 \text{ mA}$ typical

Output Modes

LIMIT

You can limit the maximum High- and Low-levels (into 50 Ω) to protect the device-under-test. When you first switch on LIMIT mode, the current levels are declared as level-limits which cannot be exceeded until you switch off LIMIT mode.

COMPLEMENT

On a PULSE channel, you can complement the output signal by switching on COMPLEMENT mode.

DISABLE

You can disable the output signal by switching on DISABLE mode. The signal is disconnected from the output connectors using internal relays.

$\overline{\text{DATA}}$

On a PULSE\ $\overline{\text{DATA}}$ channel (Option 002 only), you can logically complement the the data by switching on $\overline{\text{DATA}}$ mode.

7

HP-IB Capabilities

- All modes and parameters are programmable.
- Operates according to IEEE 488.1 and 488.2, 1987.
- Conforms, where appropriate, to the Standard Commands for Programmable Instruments (SCPI) 1991.0.

Additional Features

Non-volatile Memory

- Current settings are saved on power-down.
- Additionally, 20 complete settings can be saved and recalled.

Rearpanel Connectors

Channel 1 Input & Output

For normal operation the Input and Output have to be connected using the rigid coaxial link supplied.

For multi-channel timing applications delay-lines from the HP 15436A multi-channel delay-line set are substituted for the standard links.



Output Amplitude:	2 V _{pp} , ac-coupled
Input Amplitude:	Max. 2.5 V _{pp} , ac-coupled Min. 1.0 V _{pp} , ac-coupled

Channel 2 Input & Output

These are only fitted to an Option 002 or 003 instrument. The specifications are the same as for Channel 1.

Start/Stop Input

The Start/Stop Input is part of the PULSE/DATA Channel 2 (Option 002). It can be used to stop the data-stream in order to set up a data pattern and start data generation from Bit 7.

7



Interface:	dc-coupled
Impedance:	50 Ω nominal
Transitions:¹	< 1 ns
Start Level:	0 V (default)
Stop Level:	-0.4 V
Max.Levels:	-0.8 - +0.4 V

¹ You should use a clean signal, for example from a pulse generator. Noisy transitions, for example switch bounce, can confuse the Data circuits.

General Information

Operating Environment

Storage Temperature:	-40°C to +70°C
Operating Temperature:	0°C to 55°C
Humidity:	95% R.H. (0°C to 40°C)

Warning



- The HP 8133A is not designed for outdoor use. Do not expose the HP 8133A to rain or other excessive moisture. Protect the HP 8133A from humidity and temperature changes which could cause condensation within the instrument.
- Do not operate the HP 8133A in the presence of flammable gases, fumes or powders. Operation of any electrical instrument in such an environment constitutes a definite safety hazard.

Power Requirements

110-120/220-240 V_{rms} ±10%
250 VA max.
47-63 Hz

Weight

Net: 21.5 kg (48 lb)
Shipping: 29 kg (65 lb)

7

Dimensions (H×W×D)

145 mm × 426 mm × 525 mm
(5.7 in × 16.75 in × 20.65 in)

Ventilation Requirements

The HP 8133A is fitted with two cooling fans. Make sure that there is adequate clearance of 3 inches (75 mm) at the rear and 1 inch (25 mm) at the sides to ensure adequate airflow. If the airflow is restricted the internal operating temperature will be higher, reducing the instrument's reliability.

Acoustic Noise Emission

For ambient temperature up to 30°C, under normal operation and at the typical operator position:

LpA = 41 dB

Measured in accordance with ISO 6081.

Geräuschemissionswerte

Bei einer Umgebungstemperatur bis 30°C

LpA = 41 dB

am Arbeitsplatz, normaler Betrieb.

Angabe ist das Ergebnis einer Typprüfung nach DIN 45635 Teil 19.

Recalibration Period 1 year recommended

Declaration of Conformity

Manufacturer: Hewlett-Packard GmbH
Böblingen Instruments Division
Herrenberger Str. 130
D-7030 Böblingen Germany

We declare that the product **HP 8133A 3 GHz Pulse Generator** conforms to the following standards:

Safety: IEC 1010-1 (1990)

EMC: EN 55011 (1991) / CISPR 11 Group 1, Class B
EN 50082-1 (1991)

IEC 801-2 ESD: 4kV cd, 8kV ad

IEC 801-3 Radiated Immunity: 3V/m

IEC 801-4 Fast Transients: 0.5kV, 1kV

Supplementary Information

During the measurements against EN 55011, the I/O ports were terminated with their normal impedance, the HP-IB connector was terminated with the cable HP 10833B. When the product is connected to other devices, the user must ensure that the connecting cables and the other devices are adequately shielded to prevent radiation.

Böblingen, 29th January 1992

Robert Hofgärtner
Quality Assurance Manager

7

HP 8133A Quick Reference

Table 8-1. HP 8133A Quick Reference

Frontpanel	HP-IB	Description
LCL	:SYST:KEY 0	Return to Local mode Select HP-IB address
MEMORY	SETTING + SAVE + RECALL RECALL	*SAV <mem no.> Save current settings *RCL <mem no.> Recall settings :SYST:KEY 4 Recall last valid settings
TIMEBASE	INT/EXT EXT DIVIDE FREQ/PERIOD	:TRIG:SOUR IMM EXT Select Internal/External Timebase mode. :TRIG:ECO <value> MIN MAX Select External Input divider :FREQ <value> Select internal frequency :PER <value> Select internal period
TRIGGER	DIVIDE/BIT 0 AMPL/HIGH OFFS/LOW DISABLE	:OUTP:SOUR PER BITS Select Divided/Bit 0 Trigger mode :OUTPO:DIV <value> MIN MAX Select Trigger divider :VOLTO <value> Select Trigger amplitude :VOLTO:HIG <value> Select Trigger high-level :VOLTO:OFFS <value> Select Trigger offset :VOLTO:LOW <value> Select Trigger low-level :OUTPO ON OFF Select Trigger output state
VERNIER	↑↑↑↑↑ ↓↓↓↓↓ ↑↑↑↑↑ ↓↓↓↓↓ ↑↑↑↑↑ ↓↓↓↓↓ ↑↑↑↑↑ ↓↓↓↓↓ ↑↑↑↑↑ ↓↓↓↓↓ ↑↑↑↑↑ ↓↓↓↓↓	:SYST:KEY 25 Increment 5th digit :SYST:KEY 24 Decrement 5th digit :SYST:KEY 47 Increment 4th digit :SYST:KEY 46 Decrement 4th digit :SYST:KEY 45 Increment 3rd digit :SYST:KEY 44 Decrement 3rd digit :SYST:KEY 43 Increment 2nd digit :SYST:KEY 43 Decrement 2nd digit :SYST:KEY 42 Increment 1st digit :SYST:KEY 41 Decrement 1st digit

8

Table 8-1. HP 8133A Quick Reference (continued)

	Frontpanel	HP-IB	Description	
Channel 1	PULSE/SQUAR	:FUNC[1 2] PULS SQU	Select Pulse/Square mode	
	DELAY/PHASE	:DELT1 <value>	Select Channel delay	
		:PHAS1 <value>	Select Channel phase	
		:DESK1 <value>	Select Channel deskew	
	WIDTH/DCYC	:WIDT1 <value>	Select pulse width	
		:DCYC1 <value>	Select pulse dutycycle	
	AMPL/HIGH	:VOLT1 <value>	Select Channel amplitude	
		:VOLT1:HIGH <value>	Select Channel high-level	
	OFFS/LOW	:VOLT1:OFFS <value>	Select Channel offset	
		:VOLT1:LOW <value>	Select Channel low-level	
	DISABLE	:OUTP1 ON OFF	Select Channel output state	
		:OUTP1:NEG ON OFF	Select <u>OUTPUT</u> state	
		:OUTP1:POS ON OFF	Select OUTPUT state	
	COMP	:POL1 NORM COMP	Select Channel polarity	
	LIMIT	:VOLT1:LIM:STAT ON OFF	Select Limited output mode	
Channel 2	PULSE/DATA¹	:FUNC2 DAT SQU	Select Data/Square mode	
	DATA/SQUAR	:FUNC2 DAT PRBS	Select 32 Bit/PRBS mode	
	32 BIT/PRBS	:DIG:PAIT #4 <4 chars>	Set 32 Bit data pattern	
		:DIG:PAIT #232 <32 chars>	Set 32 Bit data pattern	
		:FUNC2 BURS, <num>	Select Burst mode ²	
		:FUNC2 RBURS, <num>, <num>	Select Repeated Burst mode ²	
		RZ/NRZ	:DIG:SIGN:FORM RZ NRZ	Select data format
	AMPL/HIGH	:VOLT2 <value>	Select Channel amplitude	
		:VOLT2:HIGH <value>	Select Channel high-level	
	OFFS/LOW	:VOLT2:OFFS <value>	Select Channel offset	
		:VOLT2:LOW <value>	Select Channel low-level	
	DISABLE	:OUTP2 ON OFF	Select Channel output state	
		:OUTP2:NEG ON OFF	Select <u>OUTPUT</u> state	
	:OUTP2:POS ON OFF	Select OUTPUT state		
	DATA	:DIG:SIGN:POL NORM COMP	Select data polarity	
	LIMIT	:VOLT:LIM:STAT ON OFF	Select Limited output mode	

1 Option 002

2 HP-IB only

Table 8-1. HP 8133A Quick Reference (continued)

	Frontpanel	HP-IB	Description
DATA/EDIT ¹	← ROTATE	:FUNC2 DAT::SYST:KEY 25	Rotate 32 Bit data 1 bit left
	← CURSOR	:FUNC2 DAT::SYST:KEY 24	Move cursor 1 bit left
	ROTATE →	:FUNC2 DAT::SYST:KEY 47	Rotate 32 Bit data 1 bit right
	CURSOR →	:FUNC2 DAT::SYST:KEY 46	Move cursor 1 bit right
	REPEAT	:FUNC2 DAT::SYST:KEY 45	Repeat data before cursor to end
	FILL	:FUNC2 DAT::SYST:KEY 44	Fill data at cursor to end
	0 ↔ 1	:FUNC2 DAT::SYST:KEY 43/42	Toggle bit at cursor
	⇒ 1	:FUNC2 DAT::SYST:KEY 41	Set bit to 1 and cursor right
⇒ 0	:FUNC2 DAT::SYST:KEY 40	Set bit to 0 and cursor right	
PULSE Channel 2 ²	Same keys as Channel 1	Same commands as Channel 1, but replace 1 with 2.	
Special Functions	MEMORY SETTING + AMPL/HIGH + OFFS/LOW + TRIGGER DIVIDE	:DIAG:CHAN[1 2]:SMO <value> :DIAG:CHAN[1 2]:CABL <value> :DIAG:TEMPCAL ON HOLD OFF	Select Channel smoothness factor Select Channel cable compensation factor Select Temperature calibration mode

1 Option 002, only when 32 Bit Data is active.

2 Option 003

Table 8-2. HP 8133A Channel Feature Reference

Channel	Frequency Range	Frequency Divider		Variable Delay		Variable Width		PRBS /Data	Level Window	Amplitude Limits	Edges (20-80%)
TRIGGER	33 MHz to 3 GHz	DIVIDE	BIT 0	DIVIDE	BIT 0	DIVIDE	BIT 0	x	-4--+4 V	0.5-1.8 V	< 100ps
		1 - 64	32	x	x	x	x				
PULSE		PULSE	SQUAR	PULSE	SQUAR	PULSE	SQUAR				
Channel 1 + Options		x	x	x	0-10ns	0-10ns	x				
Channel 2		1 - 64	1 - 64	x	0-10ns	0-10ns	x	x			
PULSE DATA		DATA	SQUAR	DATA	SQUAR	DATA	SQUAR				
Channel 2		x	1-32	x	x	x	x	✓			

8

Index

- 0** **0⇌1**, 3-26

- 3** **32 BIT/PRES**, 3-19
32 Bit Word, 5-17

- A** AC line voltage, 1-2
Activating a parameter, 4-2
Active Parameter, 2-3, 3-3, 3-24, 4-2
Adjusting parameters, 4-2
ADS, 3-27
AMPL/HIGH, 3-9, 3-15, 3-20
Amplitude, 4-9
 - PULSE, 3-15, 5-44
 - PULSE/DATA, 3-20, 5-44
 - TRIGGER, 3-9, 5-44Auto-repeat, 2-5, 3-24

- B** **⇓**, 3-24
←CURSOR, 3-25
←ROTATE, 3-25
⇒0, 3-26
⇒1, 3-26
⇑, 3-24
Bit 0 Trigger, 3-8
Burst Mode, 4-19, 5-31

Index

- C**
 - Cable Compensation, 3-29, 5-14
 - Clear Error Queue, 5-54
 - Clear Status, 5-54
 - Command Summary, 5-2
 - Common Commands, 5-1
 - COMP**, 3-17, 5-42
 - Condition Register, 5-7
 - Conflicting Parameters, 3-37, 4-6
 - Conformance to Standards, 7-11
 - Control keys, 2-3, 3-3
 - CURSOR, 3-25
 - CURSOR⇒**, 3-25

- D**
 - DATA**, 3-22, 5-19
 - DATA EDIT, 3-25, 5-17
 - Data Mode
 - PULSE/DATA, 3-18
 - DATA/SQUAR**, 3-18
 - Declaration of Conformity, 7-11
 - Default Settings, 4-4
 - Delay
 - PULSE, 3-13, 4-15, 5-36
 - DELAY/PHASE**, 3-13
 - Deskew: *See* Skew
 - Dimensions, 7-9
 - DISABLE**, 3-11, 3-16, 3-22, 5-28
 - DISABLE OUTPUT**, 5-29
 - DISABLE OUTPUT**, 5-30
 - Display
 - ON/OFF, 5-20
 - Text, 5-21
 - Display Messages, 3-34
 - DIVIDE/BIT 0**, 3-8, 5-27
 - Divider
 - PULSE/DATA, 3-18, 5-25
 - TRIGGER, 3-8, 5-25
 - Duty-cycle
 - PULSE, 3-14, 5-35

- E** Enable Register, 5-8
- Error Messages, 3-34
- Error Queue, 5-64
- Event Register, 5-7
- EXT DIVIDE**, 3-6, 5-70
- External Clock, 3-6, 4-8, 5-71
- External Divider, 5-70, 7-2
- External Frequency Counter
 - Specifications, 7-2
- External Input
 - Specifications, 3-7, 7-2
- External voltage, 2-3

- F** FILL, 3-25
- FILL**, 3-25
- FREQ/PERIOD**, 3-7
- Frequency, 3-7, 4-7, 5-22, 5-33
- Frontpanel, 3-1
- Functional Coupling, 5-12

- H** High-level, 4-9
 - PULSE, 3-15, 5-46
 - PULSE/DATA, 3-20, 5-46
 - TRIGGER, 3-9, 5-46
- HP-IB
 - Address, 3-27
 - Local, 3-27
 - Remote, 3-27

- I** Inspection, 1-1
- Instrument Setting, 3-4, 5-68
- Internal Clock, 3-6, 4-7, 5-71
- INT/EXT**, 3-6, 5-71
- Invalid Keys, 3-34
- Inver Data, 5-19
- Invert Data, 3-22

Index

- K** Key-code Reference, 5-65
Key Queue, 5-65

- L** LCL, 3-27
LCL, 3-27
LIMIT, 3-17, 3-22, 5-52
Local mode, 3-27
Low-level, 4-9
 - PULSE, 3-16, 5-47
 - PULSE/DATA, 3-21, 5-47
 - TRIGGER, 3-10, 5-47

- M** Maximum external voltage, 2-3
Memory, 3-4, 4-3
Mode keys, 2-3, 3-3

- N** Noise Emission, 7-10
NRZ/RZ, 3-19, 5-18

- O** Offset, 4-9
 - PULSE, 3-16, 5-45
 - PULSE/DATA, 3-21, 5-45
 - TRIGGER, 3-10, 5-45
 - OFFS/LOW, 3-10, 3-16, 3-21Operating Environment, 7-9
Operation Status, 5-10
OUTPUT, 3-17, 3-23, 5-29
OUTPUT, 3-17, 3-23, 5-30

- P** Parameter Conflicts, 3-37, 4-6
Parameter keys, 2-3, 3-3, 4-2
Performance Test Record, 6-43
Performance Tests, 6-1
Period, 3-7, 4-7, 5-23, 5-41
Phase
 - PULSE, 3-13, 4-16, 5-34Power
 - cable, 1-4
 - requirements, 1-2

Power Requirements, 7-9
PRBS, 4-17
PULSE, 3-12
 Amplitude, 3-15, 5-44
 Complement, 3-17, 5-42
 Delay, 3-13, 4-15, 5-36
 Deskew. *See* PULSE, Skew
 Disable, 3-16
 Duty-cycle, 3-14, 5-35
 High-level, 3-15, 5-46
 Levels, 3-15
 Limit, 3-17
 Low-level, 3-16, 5-47
 Mode, 3-12, 5-31
 Offset, 3-16, 5-45
 Phase, 3-13, 4-16, 5-34
 Pulse Mode, 3-12
 Skew, 3-13, 4-16, 5-38
 Specifications, 7-4
 Squarewave Mode, 3-12
 Width, 3-14, 5-43
PULSE/DATA, 3-18
 32 BIT, 3-19
 Amplitude, 3-20, 5-44
 DATA, 3-22, 5-19
 Data Mode, 3-18
 Disable, 3-22
 Divider, 3-18, 5-25
 High-level, 3-20, 5-46
 Levels, 3-20
 Low-level, 3-21, 5-47
 Mode, 3-18, 5-31
 Offset, 3-21, 5-45
 PRBS, 3-19
 RZ/NRZ, 3-19, 5-18
 Specifications, 7-5
 Squarewave Mode, 3-18
 Start/Stop, 5-72
Pulse mode
 PULSE, 3-12
PULSE/SQUAR, 3-12

Index

- Q** Questionable Status, 5-11
Questionable Status Group, 5-55

- R** Range Coupling, 5-12
Reading the Keyboard, 5-65
Rearpanel, 3-30
Rearpanel Input, 3-30
Rearpanel Output, 3-30
Recalibration, 7-10
Recall, 3-4
 RECALL, 3-5
Recalling Instrument Settings, 4-3
Recalling the Standard Settings, 4-4
Recall last valid setting, 3-5
Recommended Test Equipment, 6-2
Registers, 5-8
Remote mode, 3-27
Repeat, 2-5, 3-24
 REPEAT, 3-25
 REPEAT, 3-25
Repeated Burst Mode, 4-20, 5-31
Reset, 5-67
RMT, 3-27
 ROTATE, 3-25
 ROTATE⇒, 3-25
RZ/NRZ, 3-19, 5-18

- S** Save, 3-4
 SAVE, 3-5
Saving the Instrument Settings, 4-3
SCPI
 Command Dictionary, 5-12
 Command Summary, 5-2
 Error Messages, 5-74
 Version, 5-69, 7-7
 SETTING, 3-4
Setting Frequency/Period, 4-7
Setting Output Levels, 4-8
Simulating Key-presses, 5-65
Skew, 4-16

Index

- PULSE, 3-13, 4-16, 5-38
- Smooth Factor, 3-29, 5-15
- Solving Conflicts, 3-37, 3-38, 4-6, 4-7
- Special Functions, 3-28
- Specifications, 7-1
 - External Divider, 7-2
 - External Frequency Counter, 7-2
 - External Input, 7-2
 - Frequency, 7-1
 - Period, 7-1
 - PULSE Channel, 7-4
 - PULSE/DATA Channel, 7-5
 - Rearpanel, 7-8
 - Trigger Output, 7-3
- Squarewave Mode
 - PULSE, 3-12
 - PULSE/DATA, 3-18
- Squarewaves, 4-10
- SRQ, 3-27
- Standard Event Status, 5-9
- Standard Settings, 4-4
- Start/Stop input, 3-31
- Start/Stop Input, 5-72
- Status Byte, 5-8
- Status Group
 - Questionable, 5-55
 - Questionable Frequency, 5-59
 - Questionable Monotony, 5-61
 - Questionable Voltage, 5-57
- Status Groups, 5-6
- Status Model, 5-6
- Status Model Preset, 5-54
- Store, 3-4
- System Preset, 5-67

Index

- T** Temperature, 5-24
- Temperature Compensation, 3-28, 5-16
- Testing, 6-1
 - DATA, 6-37
 - External Frequency Counter, 6-5
 - Inter-channel Delay, 6-19
 - Output Jitter, 6-34
 - Output Levels, 6-26, 6-28
 - Output Overshoot, 6-29
 - Output Ringing, 6-29
 - Output Transition Time, 6-31
 - PULSE Delay, 6-14
 - PULSE Delay Option 001, 6-17
 - PULSE Duty Cycle, 6-25
 - PULSE Width, 6-22
 - TIMEBASE, 6-3
 - TRIGGER, 6-9
 - TRIGGER Divider, 6-4
- TIMEBASE, 3-6
 - Frequency, 3-7, 5-22, 5-33
 - Mode, 5-71
 - Period, 3-7, 5-23, 5-41
 - Testing, 6-3
- Transition Filters, 5-7
- TRIGGER, 3-8
 - Amplitude, 3-9, 5-44
 - BIT 0, 3-8
 - Disable, 3-11
 - Divider, 3-8, 5-25
 - High-level, 3-9, 5-46
 - Low-level, 3-10, 5-47
 - Mode, 3-8, 5-27
 - Offset, 3-10, 5-45
 - Specifications, 7-3
- Trigger Output, 3-8
- Trigger synchronized to Bit 0, 3-8

Index

V Value Coupling, 5-12
Ventilation Requirements, 7-10
Verification Tests, 6-1
VERNIER, 3-24

W Weight, 7-9
Width
 PULSE, 3-14, 5-43
 (WIDTH/DCYC), 3-14

Free Manuals Download Website

<http://myh66.com>

<http://usermanuals.us>

<http://www.somanuals.com>

<http://www.4manuals.cc>

<http://www.manual-lib.com>

<http://www.404manual.com>

<http://www.luxmanual.com>

<http://aubethermostatmanual.com>

Golf course search by state

<http://golfingnear.com>

Email search by domain

<http://emailbydomain.com>

Auto manuals search

<http://auto.somanuals.com>

TV manuals search

<http://tv.somanuals.com>