

8447A AMPLIFIER/ DUAL AMPLIFIER

.1—400MHz

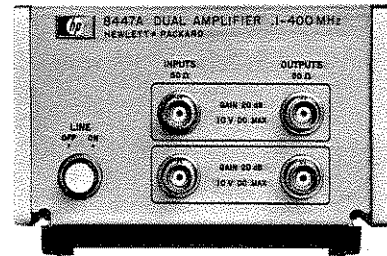

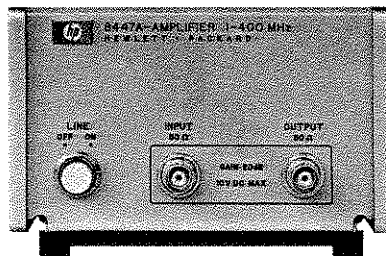

OPERATING AND SERVICE MANUAL

8447A
**AMPLIFIER/
DUAL AMPLIFIER**
1—400 MHz

SERIAL PREFIX: 955

This manual applies directly to HP Model 8447A Amplifier and Model 8447A-001 Dual Amplifier having serial prefix number 955.

SERIAL PREFIXES NOT LISTED

For serial prefixes above 955, a "Manual Changes" sheet is included with this manual.

©HEWLETT-PACKARD COMPANY 1970
1400 FOUNTAIN GROVE PARKWAY, SANTA ROSA, CALIFORNIA, 95404, U.S.A.

MANUAL PART NUMBER 08447-90003

Printed: APRIL 1970

MANUAL CHANGES

MANUAL IDENTIFICATION

Model Number: 8447A
 Date Printed: APRIL 1976
 Part Number: 08447-90003

This supplement contains important information for correcting manual errors and for adapting the manual to instruments containing improvements made after the printing of the manual.

To use this supplement:

Make all ERRATA corrections

Make all appropriate serial number related changes indicated in the tables below.

Serial Prefix or Number	Make Manual Changes	Serial Prefix or Number	Make Manual Changes
1145A00356A thru -01517, -01566, and -01571	1		
1145A01518 thru -01565, -01567 thru -01570, -01572 thru -01575, and 1529A prefix	1, 2		
1616A	1, 2, 3		
1644A	1, 2, 3, 4		
1937A	1, 2, 3, 4, 5		
2123A	1, 2, 3, 4, 5, 6		
2123A06657 and 2439A	1, 2, 3, 4, 5, 6, 7		

► NEW ITEM

NOTE

Manual change supplements are revised as often as necessary to keep manuals as current and accurate as possible. Hewlett-Packard recommends that you periodically request the latest edition of this supplement. Free copies are available from all HP offices. When requesting copies quote the manual identification information from your supplement, or the model number and print date from the title page of the manual.

10 FEBRUARY 1986



Printed in U.S.A.

ERRATA

Add to front of manual SAFETY CONSIDERATIONS supplied in this Manual Changes supplement.

Page 1-1, Table 1-1:

Add Reverse Isolation: >30 dB.

Page 3-1, Paragraph 3-7:

Add the following caution before the first sentence in step c:

CAUTION

The input to the HP 8447A amplifier is very susceptible to damage from electrostatic discharge. Before connecting any coaxial cable to the input jack of the amplifier, make certain that static electricity buildup in the cable is completely discharged.

Page 4-1, Paragraph 4-5:

Add the following caution:

CAUTION

The input to the HP 8447A amplifier is very susceptible to damage from electrostatic discharge. Before connecting any coaxial cable to the input jack of the amplifier, make certain that static electricity buildup in the cable is completely discharged.

Page 4-2, Paragraph 4-6:

Add 10 dB attenuator (2 required) ... HP 8491 Opt. 010 to the equipment list. Change specification for "Output Level (Compression)" to >+7 dBm at 1-dB compression point.

Page 4-3, Paragraph 4-6:

Change step 6 to read as follows:

To check flatness, set the signal level at Channel A to -30 dBm. Connect a 10 dB attenuator to each tee, between the tee and the adapter. Note the level difference between Channel A and Channel B as the generator frequency is tuned from 10 MHz to 400 MHz. Keep the input level to the amplifier (CHANNEL A) constant and note the variation in Channel B. Channel B should change >1 dB (± 0.5 dB).

Page 4-5, Paragraph 4-7:

Under SPECIFICATION, change "parts" to "ports".

Page 4-10, PERFORMANCE TESTS:

Add performance test 4-10, Reverse Isolation, supplied in this Manual Changes supplement.

Page 4-11, Table 4-1:

Add Reverse Isolation information to Performance Test Record, supplied in this Manual Changes supplement.

Page 5-2, Paragraph 5-8:

Change "Figure 4-1" to "Figure 5-1" in step 1.

Page 6-2, Table 6-2:

Change C2 to HP Part Number 0160-2049, Check Digit 1, CAPACITOR-FDTHRU 5000PF +80 -20% 500V.

Change A1CR1-4 to HP Part Number 1901-0743, Check Digit 1, DIODE:PWR RECT IN4004 400VIA DO-41.

Page 6-3, Table 6-2:

Change U1 and U2 to HP Part Number 5086-7032, Check Digit 9.
Change HP Part Number 1200-0043 to HP Part Number 0340-0664, Check Digit 4,
INSULATOR-XSTR TO-3.

Page 6-4, Table 6-2:

Change Reference Designation 8 to HP Part Number 08447-00054, Check Digit 3,
PANEL:FRONT STANDARD.
Add Reference Designation 3, HP Part Number 08447-00055, Check Digit 6, PANEL:FRONT
OPTION 001.

Page 6-5, Table 6-3:

Change HP Part Number 1820-0169 to HP Part Number 5086-7032, Check Digit 9.
Change HP Part Number 1901-0159 to HP Part Number 1901-0743, Check Digit 1,
DIODE:PWR RECT IN4004 400VIA D-41.
Change HP Part Number 08447-00001 to HP Part Number 08447-00054, Check Digit 5,
PANEL:FRONT STANDARD.
Add HP Part Number 08447-00055, Check Digit 6, PANEL:FRONT OPTION 001.
Change HP Part Number 1200-0043 to HP Part Number 0340-0664, Check Digit 4,
INSULATOR-XSTR TO-3.

►Page 8-9, Figure 8-3:

Replace Figure 8-3 with the new Figure 8-3 included in this Manual Changes
supplement.

Page 8-9, Figure 8-4:

Change wire colors of T1 power transformer primary windings as follows: 90 (top
winding) to 902, 904 to 905, and 905 to 904.
Delete line connecting CR8 and C4.

CHANGE 1

Page 6-4, Table 6-2:

Change Cabinet Parts Lists to read as supplied in this Manual Changes supplement.

CHANGE 2

Page 1-1, Table 1-1:

Change the following specifications:
Output Level: >+6 dBm at 1-dB compression point.
Distortion: Harmonics at least 32 dB down at output levels up to 0 dBm.

Page 4-2, Paragraph 4-6:

Change specification for "Output Level (Compression)" to >+6 dBm at 1-dB compression
point.

Page 4-3, Paragraph 4-6, Step 5:

Change "+7 dBm" to "+6 dBm" in first line.

Page 4-8, Paragraph 4-8:

Change specification to read:
Harmonics at least 32 dB down at output levels up to 0 dBm.
In step 3, change 35 dB to 32 dB (two places).

Page 4-11, Paragraph 4-8:

Change limit under "Min." to -32.

CHANGE 3

Page 6-2, Table 6-2:

Change A1CR9 to HP Part Number 1884-0073, Check Digit 2, THYRISTOR-SCR TO-5
VRRM=100.

Add A1R13, HP Part Number 0757-0401, Check Digit 0, R:FXD MET FLM 100 OHM 1% 1/8W.

Page 8-9, Figure 8-4:

Add R13, 100 ohms, from junction of CR8 anode/CR9 gate to ground.

CHANGE 4

Page 6-3, Table 6-2:

Change S1 to HP Part Number 3101-2195, Check Digit 7, SWITCH:PUSHBUTTON DPST (recommended replacement).

Change XF1 to HP Part Number 2110-0470, Check Digit 5, FUSEHOLDER BODY.

Add the following HP Part Numbers and description:

2110-0465, Check Digit 8, FUSEHOLDER CAP.

2110-0467, Check Digit 0, FUSEHOLDER NUT: HEX.

1400-0090, Check Digit 9, WASHER:FLAT NEOPRENE.

Delete HP Part Number 2950-0038.

Page 6-4, Figure 6-1:

Change Reference Designation 6 to HP Part Number 08447-00050, Check Digit 1.

Page 8-9, Figure 8-4:

Change S1 ON/OFF switch as shown in the partial schematic supplied in this Manual Changes supplement.

CHANGE 5

Page 6-3, Table 6-2:

Change XF1 HP Part Number to 2110-0564, Check Digit 8.

Change FUSEHOLDER CAP HP Part Number to 2110-0565, Check Digit 9.

Change FUSEHOLDER NUT HP Part Number to 2110-0569, Check Digit 3.

Delete FUSEHOLDER WASHER entry.

CHANGE 6

Page 6-3, Table 6-2:

Change U1 and U2 to HP Part Number 5086-7356, Check Digit 0.

Change W2 to HP Part Number 08447-20006, Check Digit 9, CABLE ASSEMBLY: IN BNC.

Change W3 to HP Part Number 08447-20007, Check Digit 0, CABLE ASSEMBLY: OUT BNC.

Change W4 to HP Part Number 08447-20008, Check Digit 1, CABLE ASSEMBLY: IN BNC.

Change W5 to HP Part Number 08447-20009, Check Digit 2, CABLE ASSEMBLY: OUT BNC.

Add HP Part Number 08447-00028, Check Digit 3, BRACKET: SUPPORT AMPLIFIER (OPTION 001).

Page 6-5, Table 6-3:

Change HP Part Number 1820-0169 (or 5086-7032, see errata) to HP Part Number 5086-7356, Check Digit 0.

Page 6-6, Table 6-3:

Delete HP Part Number 08447-60003.

Add W2, HP Part Number 08447-20006, Check Digit 9, CABLE ASSEMBLY: IN BNC.

Add W3, HP Part Number 08447-20007, Check Digit 0, CABLE ASSEMBLY: OUT BNC.

Add W4, HP Part Number 08447-20008, Check Digit 1, CABLE ASSEMBLY: IN BNC.

Add W5, HP Part Number 08447-20009, Check Digit 2, CABLE ASSEMBLY: OUT BNC.

Add HP Part Number 08447-00028, Check Digit 3, BRACKET: SUPPORT AMPLIFIER (OPTION 001).

CHANGE 7

Page 1-1, Table 1-1:

Change the Gain specification for the instrument from 20 dB \pm 0.5 dB to 20 dB \pm 1.0 dB.

Page 4-2, Paragraph 4-6:

At the top of page 4-2, change the specification for the Gain from 20 dB ± 0.5 dB to 20 dB ± 0.1 dB.

Page 4-3, Paragraph 4-6:

Page 4-11/4-12, Table 4-1:

In step 4, paragraph 4-6, change the tolerance for recording the data from:

+19.5 _____ +20.5 dB

to:

+19.0 _____ +21.0 dB

SAFETY CONSIDERATIONS

GENERAL — This is a Safety Class I instrument (provided with terminal for protective earthing).

OPERATION — BEFORE APPLYING POWER verify that the power transformer primary is matched to the available line voltage, the correct fuse is installed, and Safety Precautions are taken (see the following warnings). In addition, note the instrument's external markings which are described under "Safety Symbols."

WARNINGS

Servicing instructions are for use by service-trained personnel only. To avoid dangerous electric shock, do not perform any servicing unless qualified to do so.

BEFORE SWITCHING ON THE INSTRUMENT, the protective earth terminal of the instrument must be connected to the protective conductor of the (mains) power cord. The mains plug shall only be inserted in a socket outlet provided with a protective earth contact. The protective action must not be negated by the use of an extension cord (power cable) without a protective conductor (grounding). Grounding one conductor of a two conductor outlet provides no protection.

If this instrument is to be energized via an auto-transformer (for voltage reduction) make sure the common terminal is connected to the neutral terminal of the power source.

Any interruption of the protective (grounding) conductor (inside or outside the instrument) or disconnecting the protective earth terminal will cause a potential shock hazard that could result in personal injury.

Whenever it is likely that the protection has been impaired, the instrument must be made inoperative and be secured against any unintended operation.

Only fuses with the required rated current, voltage, and specified type (normal blow, time delay, etc.) should be used. Do not use repaired fuses or short circuited fuseholders. To do so could cause a shock or fire hazard.

Do not operate the instrument in the presence of flammable gases or fumes. Operation of any electrical instrument in such an environment constitutes a definite safety hazard.

Do not install substitute parts or perform any unauthorized modification to the instrument.

Adjustments described in the manual are performed with power supplied to the instrument while protective covers are removed. Energy available at many points may, if contacted, result in personal injury.

Any adjustment, maintenance, and repair of the opened instrument under voltage should be avoided as much as possible, and when inevitable, should be carried out only by a skilled person who is aware of the hazard involved.

Capacitors inside the instrument may still be charged even if the instrument has been disconnected from its source of supply.

SAFETY SYMBOLS



Instruction manual symbol: the product will be marked with this symbol when it is necessary for the user to refer to the instruction manual in order to protect against damage to the product.



Indicates hazardous voltages.



Earth terminal (sometimes used in manual to indicate circuit common connected to grounded chassis).

WARNING

The WARNING sign denotes a hazard. It calls attention to a procedure, practice, or the like, which, if not correctly performed or adhered to, could result in personal injury. Do not proceed beyond a WARNING sign until the indicated conditions are fully understood and met.

CAUTION

The CAUTION sign denotes a hazard. It calls attention to an operating procedure, practice, or the like, which, if not correctly performed or adhered to, could result in damage to or destruction of part or all of the product. Do not proceed beyond a CAUTION sign until the indicated conditions are fully understood and met.



Figure 1-1. HP Model 8447A Amplifier



Figure 1-2. HP Model 8447A-001 Dual Amplifier

SECTION I

GENERAL INFORMATION

1-1. INTRODUCTION.

1-2. This manual contains all information required to install, operate, test, adjust, and service the Hewlett-Packard Model 8447A Amplifier (see Figure 1-1). This section contains instrument identification, description, options, accessories, specifications, and other basic information.

1-3. The various sections in this manual provide information as follows:

SECTION II, INSTALLATION, provides information relative to incoming inspection, power requirements, mounting, packing and shipping, etc.

SECTION III, OPERATION, provides information relative to operating the instrument.

SECTION IV, PERFORMANCE TEST, provides information required to verify that the instrument is performing in accordance with published specifications.

SECTION V, ADJUSTMENTS, provides information required to properly adjust and align the instrument after repairs are made.

SECTION VI, PARTS LIST, provides ordering information for all replaceable parts and assemblies.

SECTION VII, MANUAL CHANGES, normally will contain no relevant information in the original issue of a manual. This section is reserved to provide back dated and up dated information in manual revision or reprints.

SECTION VIII, SERVICE, includes information necessary to efficiently service the instrument.

1-4. INSTRUMENT COVERED BY MANUAL.

1-5. Hewlett-Packard instruments carry an 8-digit serial number prefix (see Figure 1-3) on the back of the panel. When the serial number prefix on the instrument serial number plate of your instrument is the same as one of the serial prefix numbers on the inside title page of this manual, the manual applies directly to the instrument. When the instrument serial number prefix is not listed on

the inside title page, manual changes sheets and manual updating information is provided. Later editions or revisions to the manual contain the required change information in Section VII.

1-6. DESCRIPTION.

1-7. HP Model 8447A Amplifier is a general purpose, low-noise, wideband amplifier (see Figure 1-1). The 8447A provides 20 dB gain to signals in 50 ohm systems from .1 to 400 MHz.

1-8. The Model 8447A amplifier can be used to make up resistive probe losses or improve sensitivity when used as a preamplifier to a spectrum analyzer or oscilloscope.

1-9. OPTIONS.

1-10. The Model 8447A -001 Dual Amplifier (see Figure 1-2) is a two-amplifier configuration which can be operated separately. Each amplifier provides 20 dB gain or the amplifiers can be cascaded by a front panel patch cable to provide a total gain of 40 dB.

Table 1-1. Specifications

Frequency Range: 0.1 to 400 MHz.
Gain: 20 dB \pm 0.5 dB*.
Gain Flatness: \pm 0.5 dB.
Noise Figure: <5 dB, 1 to 400 MHz.
Output Level: >+7 dBm at 1-dB compression point.
Distortion: Harmonics at least 35 dB down at output levels up to 0 dBm.
Impedance: 50 Ω both ports, $ \rho < 0.26$ (VSWR <1.7).
Power Requirements: 115 or 230 Vac \pm 10%, 50 to 400 Hz, 15 Watts, 27 VA max.
Weight: Net, 3 lbs, 7 oz. (1,56 kg), shipping: 5 lbs, 1 oz. (2,30 kg)
Dimensions: 8-1/2 inches (216 mm) by 5-1/8 inch (130 mm) by 3-3/8 inches (85,8 mm).

*Measured at 10 MHz.

1-11. EQUIPMENT SUPPLIED.

1-12. The only equipment supplied with the Model 8447A Amplifier or the 8447A -001 Dual Amplifier is a 7.5 ft. (2290 mm) power cable.

1-13. EQUIPMENT AVAILABLE.

1-14. Table 1-2 and Table 1-3 list the test equipment and test equipment accessories necessary to test, align, and service the Model 8447A Amplifier.

1-15. WARRANTY.

1-16. Certification and warranty information for the Model 8447A Amplifier and Model 8447A-001 Dual Amplifier appears on the inside front cover of this manual.

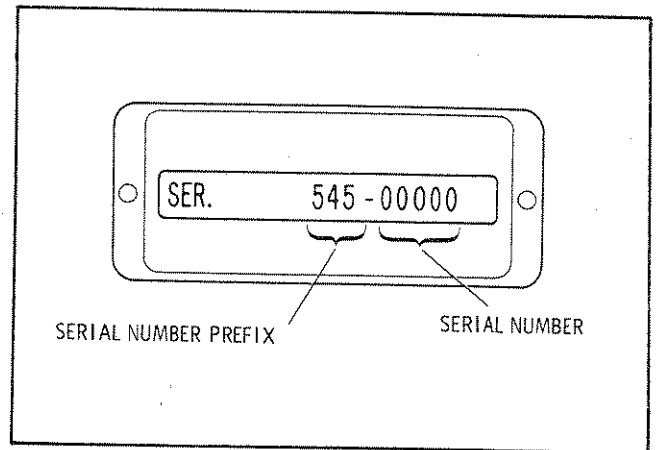

Figure 1-3. Instrument Identification

Table 1-2. Recommended Test Equipment and Accessories

Instrument Type	Critical Specifications	Recommended Model	Use (Note 1)
Signal Generator	Frequency Range: 10 MHz to 400 MHz. Output Level: -10 dBm min.	HP 608E/F	P
Test Oscillator	Frequency Range: 100 kHz to 10 MHz Output Flatness: ±2% Output: 30 mV	HP 651B	P
Vector Voltmeter	Frequency Range: 10 MHz to 400 MHz. Bandwidth: 1 kHz. Sensitivity: 10 mV to 1 Vrms. Input Impedance: ≥0.1 megohm.	HP 8405A	P
AC Voltmeter	Voltage Range: 30 mV Accuracy: ±1%	HP 400E	P, A, T
Dual Directional Coupler	Frequency Range: 100 MHz to 400 MHz. Coupling Attenuation: 20 dB nominal. Directivity: Inc port: 32 dB. Refl port: 30 dB.	HP 778D	P
Vector Impedance Meter	Frequency Range: 500 kHz to 100 MHz. Accuracy: ±2%.	HP 4815A	P
Digital Voltmeter	Range: 50 V Accuracy: ±1%.	HP 3440A/3443A	A, T
Ohmmeter	Resistance Range: 1 ohm to 100 megohm. Accuracy: ±10%.	HP 412A	T
Cable Assembly	BNC Male to BNC Male 4' long.	HP 10503A	P
Cable Assembly	Type N	HP 11500A	P
Tee	BNC	UG-274B/U	P

Table 1-2. Recommended Test Equipment and Accessories (contd)

Instrument Type	Critical Specifications	Recommended Model	Use (Note 1)
Tee(2)	50 ohms. Type N connectors.	HP 11536A	P
Adapter	BNC male to Type N Female	UG-349A/U	P
Termination	50 ohm	HP 11593A	P
Load	50 ohm	HP 908A	P
Low Pass Filter	Cutoff Frequency: 300 MHz.	Telonics TLP Series	P
Spectrum Analyzer	Frequency Range: 0.5 - 400 MHz Absolute Amplitude Calibration Dynamic Range: 50 dB	HP 140A Display Sec- tion, Model 8554L Spectrum Analyzer RF Section, Model 8552A Spectrum Analyzer IF Section.	P
Noise Figure Meter	Frequency Range: 200 MHz Noise Figure Range: 0 to 15 dB Accuracy: ± 0.5 dB	HP 342A	P
VHF Noise Source	Frequency Range: 400 MHz Excess Noise Ratio: 6.3 dB ± 0.5 dB Noise Generator: Temperature-Limited Diode	HP 343A	P
VHF Signal Generator	Frequency Range: 600 MHz Output Level: -10 dBm	HP 612A	P
Double Balanced Mixer	Frequency Input/Output: "L" "R" ports: 600 MHz, "X" port: 200 MHz Noise Performance: 9 dB max.	HP 10514A	P
Cable Assembly (2)	BNC Male to BNC Male 9" long.	HP 10502A	P
Adapter	BNC to BNC	UG-491/U	P
Adapter	BNC Female to Type N Male	UG-201A/U	P

NOTES

1. P = Performance Test; A = Adjustments; T = Troubleshooting

SECTION II

INSTALLATION

2-1. INITIAL INSPECTION.

2-2. Mechanical Check.

2-3. If damage to the shipping carton is evident, ask the carrier's agent to be present when the instrument is unpacked. Inspect the instrument for mechanical damage. Also check the cushioning material for signs of severe stress.

2-4. Performance Check.

2-5. The electrical performance of the Model 8447A or Model 8447A -001 should be verified upon receipt. Repeat each test on each amplifier in the Model 8447A -001 Dual Amplifier instrument. Performance checks suitable for incoming inspection are given in Sections IV, Performance Tests.

2-6. Claims for Damage.

2-7. If the instrument is mechanically damaged in transit, notify the carrier and the nearest Hewlett-Packard field office immediately. A list of field offices is contained in the back of this manual. Retain the shipping carton and padding material for the carrier's inspection. The field office will arrange for replacement or repair of your instrument without delay for claim settlements against the carrier. Before shipment, this instrument was inspected and found free of mechanical and electrical defects. If there is any deficiency, or, if electrical performance is not within specifications, notify your nearest Hewlett-Packard sales and service office.

2-8. PREPARATION FOR USE.

2-9. Power Requirements.

2-10. The Model 8447A or Model 8447A -001 operates from 115 or 230 volts ac line voltage at any line frequency between 50 and 400 Hz. A slide switch on the rear panel is set to the correct position for the line voltage available. A 0.5 ampere line fuse is required for either 115 or 230 volt operation.

2-11. Power Cable.

2-12. To protect operating personnel, the Nation Electrical Manufacturers Association (NEMA) recommends that the instrument panel and cabinet be grounded. All Hewlett-Packard instruments are equipped with a three-conductor po-

wer cable which, when plugged into the appropriate receptical, grounds the instrument. The offset pin on the power cables three-prong connector is the ground wire.

2-13. To preserve the protection feature when operating the instrument from a 2-conductor outlet, use a three-prong to two-prong adapter and connector the green pigtail on the adapter to ground.

2-14. The power cord or power input connector meet the specifications established by the International Electrotechnical Commission (IEC).

2-15. Operating Environment.

2-16. The operating range of the Model 8447A or Model 8447 -001 is from 0°C to +55°C. The amplifier can be stored in a temperature range of -40°C to +75°C.

2-17. Bench Mounting.

2-18. The Model 8447A is equipped with plastic feet and tilt stand in place, ready for use as a bench instrument.

2-19. Rack Mounting.

2-20. The Model 8447A may be rack mounted by using an adapter frame. The adapter frame is a rack frame that accepts any combination of sub-modular units (see Figure 2-1). For additional information, address inquires to your nearest HP sales and service office.

2-21. STORAGE AND SHIPMENT.

2-22. Packaging.

2-23. The following paragraphs contains a general guide to repackaging of the instrument for shipment. Refer to paragraph 2-25 if the original container is to be used; refer to paragraph 2-27 if it is not.

2-24. If the instrument is to be shipped to Hewlett-Packard for service or repair, attach a tag to the instrument identifying the owner and indicating the service or repair required; include the model number and full serial number of the instrument.

2-25. Original Packaging.

2-26. If original container is to be used, proceed as follows:

a. Place instrument in original container. If it is not available a suitable container can be purchased from your nearest HP sales and service office.

b. Be sure the container is well sealed with strong tape or metal band.

2-27. Other Packing Material.

2-28. If original container is not used, proceed as follows:

a. Wrap instrument in heavy paper or plastic before placing in inner container.

b. Place packing material around all sides of the instrument and protect panel face with cardboard strips.

c. Place instrument in a heavy carton or wooden box and seal with strong tape or metal band. See Table 2-1 for the required shipping carton test strengths.

d. Mark shipping container: DELICATE INSTRUMENT, FRAGILE, etc.

Table 2-1. Shipping Carton Test Strength

Gross Weight (lbs)	Carton Test Strength (lbs)
up to 10	200
10 to 30	275
30 to 120	350
120 to 140	500
140 to 160	600

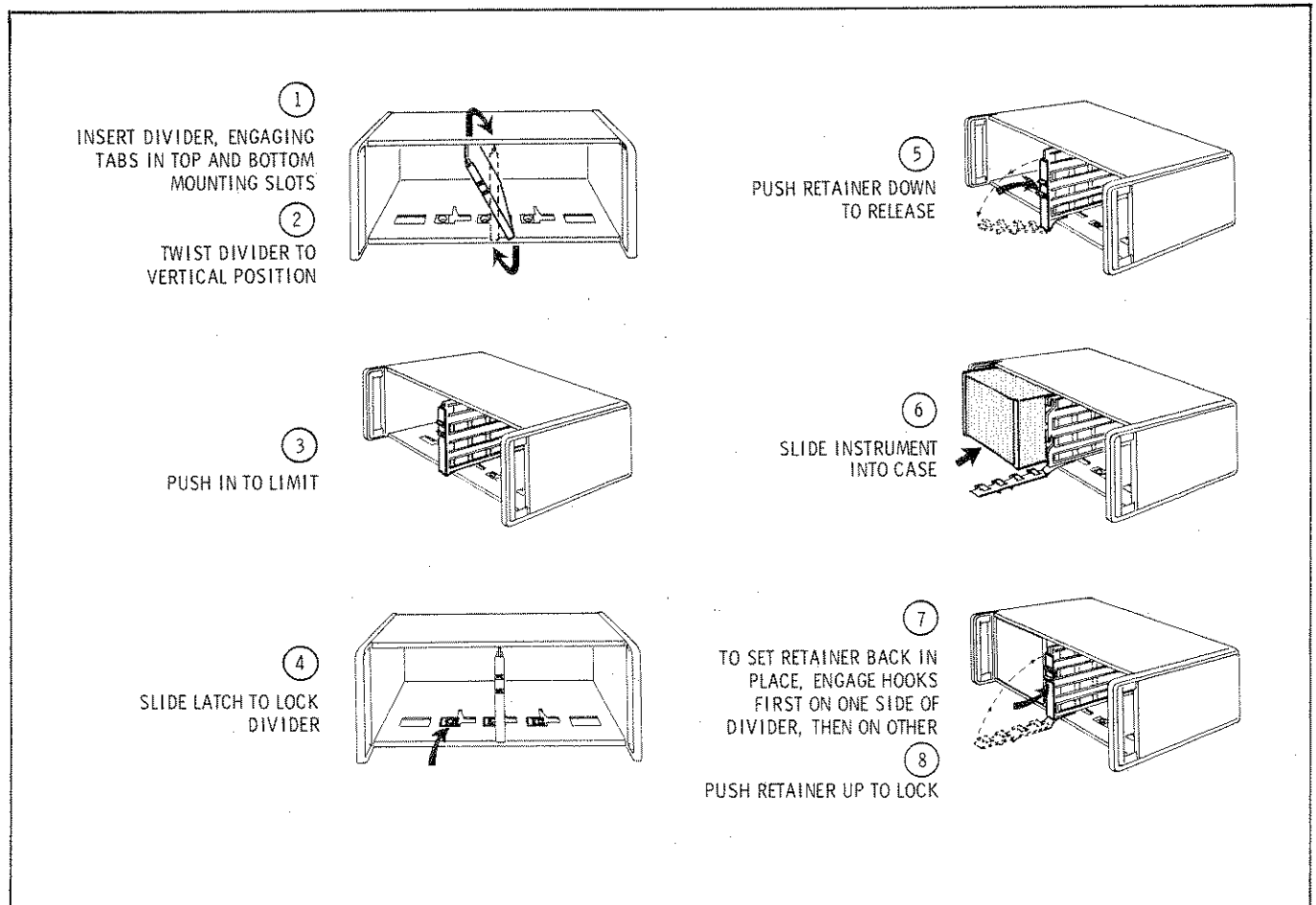

Figure 2-1. HP Model 1051A Combining Case Instrument Installation

SECTION III OPERATION

3-1. INTRODUCTION.

3-2. This section contains the basic information required to operate the Model 8447A Amplifier or the Model 8447A -001 Dual Amplifier.

3-3. The Model 8447A and the Model 8447A -001 provide 20 or 40 dB gain (cascaded amplifiers) respectively. The amplifier can be used in 50 ohm systems to increase sensitivity, make up for probe losses, and general amplification of signals from 0.1 to 400 MHz. The amplifier can also provide some amplification of signals up to 700 MHz.

3-4. PANEL FEATURES.

3-5. The Model 8447A and Model 8447 -001 front and rear panel controls and connectors are explained in Figure 3-1. The descriptions are keyed to the corresponding items which are indicated on the figures. Further information regarding the various uses of the amplifiers are included in Figures 3-2, 3-3 and 3-4.

3-6. OPERATOR CHECKS.

3-7. Five steps should be taken by the operator to determine the operational condition of either the Model 8447A Amplifier or the Model 8447A -001 Dual Amplifier.

a. Turn instrument on, check to see if the front panel LINE light is on. If the light is on proceed to step c. If light is off proceed to step b.

b. If the light is off, remove the fuse from the rear panel. Check to see if the fuse is good. If the fuse is good proceed to step c. If the fuse is bad replace the fuse and turn the instrument on. If the fuse opens again, see Section VIII, Maintenance, for repair.

c. If the line fuse is good and the power switch is depressed, connect a known signal (0.1 to 400 MHz) to front panel INPUT. Monitor the OUTPUT jack to see that the Model 8447A provides approximately 20 dB gain to the input signal. If there is no gain, go to step d.

d. If the rear panel fuse is OK, turn the instrument top side down and remove the bottom cover. Check to see that the fuse on the A1 Power Supply board is good. If the fuse is bad, replace the

fuse and turn the instrument back on. If the fuse blows again, see Section VIII, Maintenance, for repair.

e. If the Model 8447A provides the proper gain and the front panel light is out, replace the lamp (see paragraph 3-10, Operator Maintenance).

NOTE

Be sure to provide 50Ω source and load impedances.

3-8. OPERATING INSTRUCTIONS.

3-9. Figure 3-2 thru 3-4 contain general application information for the Model 8447A and the Model 8447 -001 Dual Amplifiers.

3-10. OPERATOR MAINTENANCE.

3-11. Operator maintenance is limited to replacement of the front panel LINE switch light, the A1 power supply fuse, and the rear panel fuse. For any internal maintenance on the amplifiers, see Section VII, Maintenance.

3-12. FUSES.

3-13. To replace the rear panel fuse (F1), remove the rear panel fuse knob and replace the fuse with 0.5 amp 250 V fuse.

3-14. To replace the A1 Power Supply (A1F1) fuse, turn the instrument on its top. Lift tilt stand and remove the bottom cover. Replace the fuse on the A1 Power Supply board with 0.5 amp 250 V fuse.

3-15. LAMP REPLACEMENT.

3-16. To replace the front panel line switch lamp (DS1), proceed as follows:

a. Disconnect cord from rear panel receptacle.

b. Pull the white cover portion of this switch from the instrument and then remove the lamp from inside the cover.

c. Replace old lamp with a new lamp (see Section VI for part number of DS1).

d. Place white cover into switch receptacle.

e. Align tab on white cover with socket and push in.

FRONT AND REAR PANELS

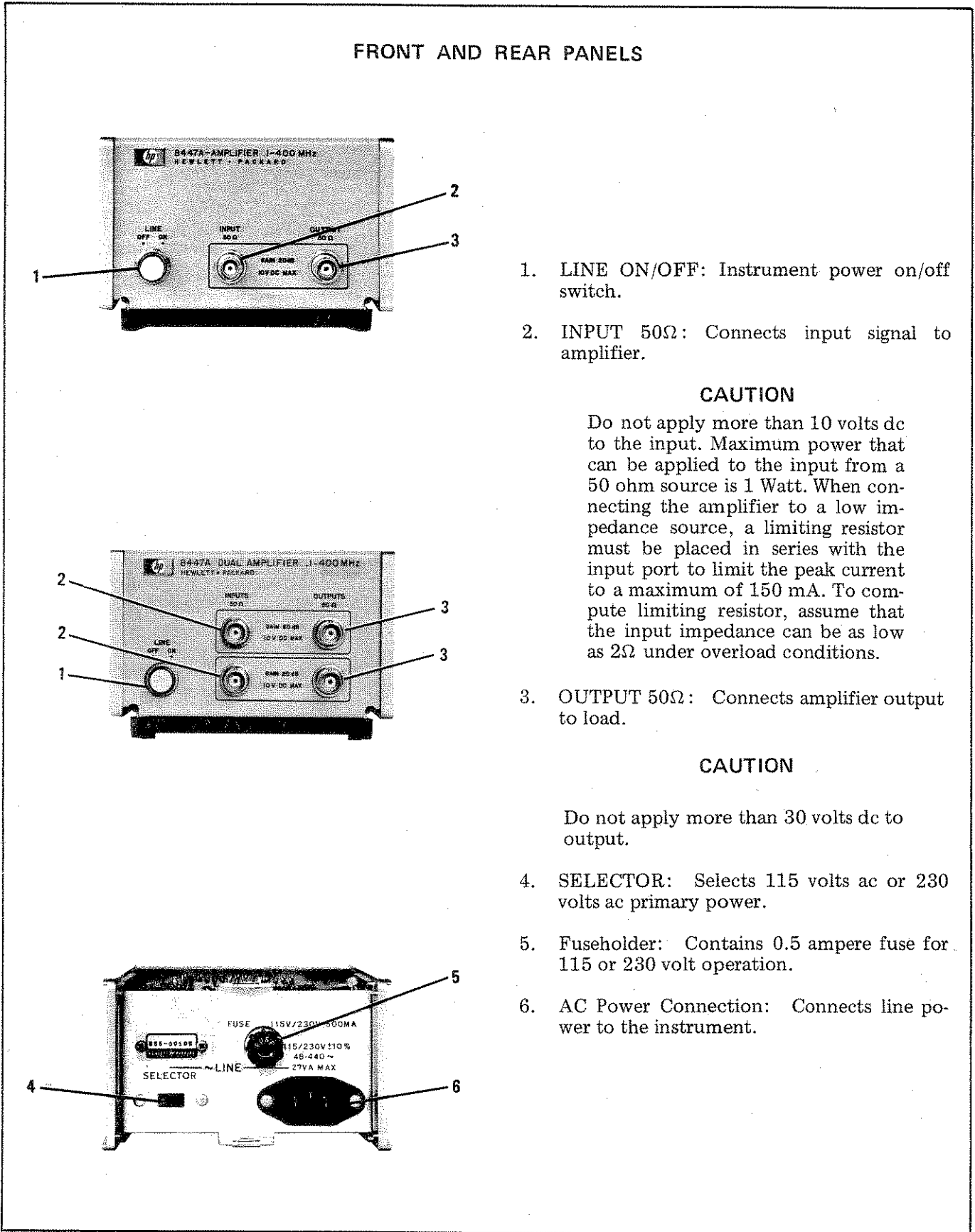

1. LINE ON/OFF: Instrument power on/off switch.
2. INPUT 50Ω: Connects input signal to amplifier.

CAUTION

Do not apply more than 10 volts dc to the input. Maximum power that can be applied to the input from a 50 ohm source is 1 Watt. When connecting the amplifier to a low impedance source, a limiting resistor must be placed in series with the input port to limit the peak current to a maximum of 150 mA. To compute limiting resistor, assume that the input impedance can be as low as 2Ω under overload conditions.

3. OUTPUT 50Ω: Connects amplifier output to load.

CAUTION

Do not apply more than 30 volts dc to output.

4. SELECTOR: Selects 115 volts ac or 230 volts ac primary power.
5. Fuseholder: Contains 0.5 ampere fuse for 115 or 230 volt operation.
6. AC Power Connection: Connects line power to the instrument.

Figure 3-1. Front and Rear Panel Controls and Connectors

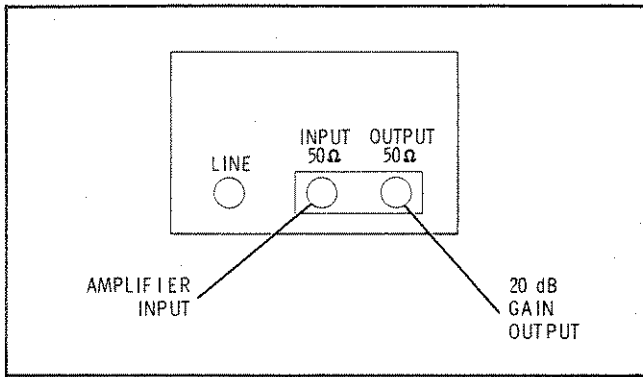

Figure 3-2. General Application of 8447A Amplifier

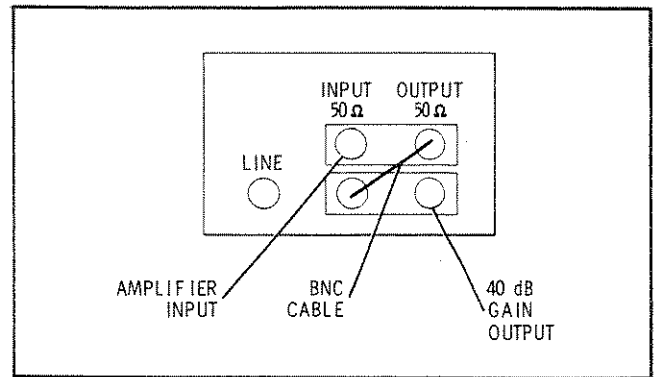

Figure 3-3. Cascade Operation of 8447A-001 Dual Amplifier

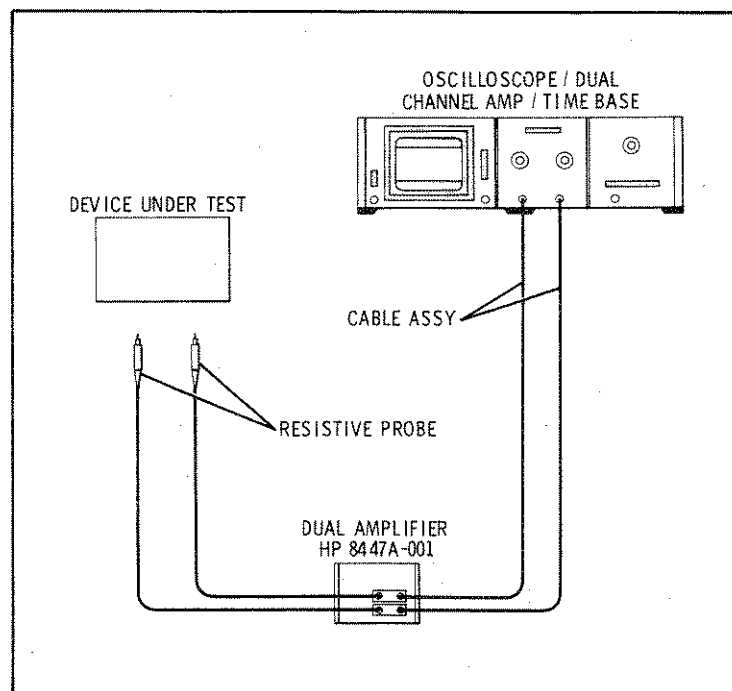

Figure 3-4. Single Amplifier Operation of 8447A-001 Dual Amplifier

Free Manuals Download Website

<http://myh66.com>

<http://usermanuals.us>

<http://www.somanuals.com>

<http://www.4manuals.cc>

<http://www.manual-lib.com>

<http://www.404manual.com>

<http://www.luxmanual.com>

<http://aubethermostatmanual.com>

Golf course search by state

<http://golfingnear.com>

Email search by domain

<http://emailbydomain.com>

Auto manuals search

<http://auto.somanuals.com>

TV manuals search

<http://tv.somanuals.com>