

# HP Ultrium tape drives

## Technical reference manual

### Generation 3 drives

#### Volume 3—the SCSI interface

Part Number: Q1530-90901 Volume 3  
Edition 6, December 2004



## Legal and notice information

© Copyright 2000–2004—Hewlett-Packard Development Company, L.P.

The information contained in this document is subject to change without notice.

Hewlett-Packard makes no warranty of any kind with regard to this material, including, but not limited to, the implied warranties of merchantability and fitness for a particular purpose. Hewlett-Packard shall not be liable for errors contained herein or direct, indirect, special, incidental or consequential damages in connection with the furnishing, performance, or use of this document.

This document contains proprietary information which is protected by copyright. All rights reserved. No part of this document may be photocopied, reproduced or translated to another language without the prior written consent of Hewlett-Packard.

## Revision history

Version	Date	Changes
Edition 1	Nov. 2000	All
Edition 2	Mar. 2001	Addition of Read and Write attribute commands and Drive Error Codes
Edition 3	May 2002	Inclusion of the Request Block Address command and the Control mode page, together with numerous small changes
Edition 5	July 2003	Many small changes
Edition 6	December 2004	Generation 3 version

This document is frequently revised and updated. To find out if there is a later version, please ask your HP OEM Representative.

# Contents

Related documents . . . . .	7
Documents specific to HP Ultrium drives . . . . .	7
Documentation map . . . . .	7
General documents and standardization . . . . .	10
<b>1 Interface Implementation</b>	
The SCSI interface . . . . .	11
Supported messages . . . . .	11
Supported commands . . . . .	12
SCSI features . . . . .	13
Design approach . . . . .	13
Power-on . . . . .	13
Reset strategy . . . . .	13
Abort handling . . . . .	14
LUN identification ( <i>parallel SCSI only</i> ) . . . . .	15
Bus parity or CRC errors . . . . .	15
Disconnect strategy . . . . .	16
Multi-initiator support . . . . .	17
Fibre Channel operation . . . . .	18
Fibre Channel addressing . . . . .	18
Field replaceable units . . . . .	20
CD-ROM emulation . . . . .	21
<b>2 Messages</b>	
Message Out support . . . . .	23
Message In support . . . . .	24
Extended Message support . . . . .	25
Status . . . . .	26
<b>3 Commands—introduction</b>	
Summary . . . . .	29
Command details . . . . .	29
Pre-execution checks . . . . .	30
Bad LUN check . . . . .	30
Deferred Error check . . . . .	30
Diagnostic Status check . . . . .	31
Fixed Bit check . . . . .	31
Flag Link check . . . . .	31

Illegal Command check . . . . .	31
Illegal Field/Request check . . . . .	31
Media Access check . . . . .	32
Media Information check . . . . .	33
Media Write check . . . . .	33
Parameter List check . . . . .	34
Reservation check . . . . .	34
Unit Attention check . . . . .	34
Command descriptor block . . . . .	35

## 4 Commands

ERASE . . . . .	19h	38
INQUIRY . . . . .	12h	39
INQUIRY data pages . . . . .		40
Vital Product Data pages . . . . .		44
Supported Vital Product Data Pages page . . . . .		44
Unit Serial Number page 45		
Device Identification page . . . . .		45
Defined identifiers . . . . .		46
Extended INQUIRY Data VPD page . . . . .		48
Sequential Access Device Capabilities page . . . . .		48
Drive Component Revision Levels pages . . . . .		49
LOAD/UNLOAD . . . . .	1Bh	50
LOCATE . . . . .	2Bh	53
LOG SELECT . . . . .	4Ch	55
LOG SENSE . . . . .	4Dh	57
Log page format . . . . .		58
Supported Log Pages page . . . . .		59
Write Error Counters log page . . . . .		60
Read Error Counters log page . . . . .		60
Sequential Access Device log page . . . . .		61
Temperature log page . . . . .		62
DTD Status log page . . . . .		62
Very High Frequency Data (VHF) . . . . .		63
Very High Frequency Polling Delay . . . . .		64
DTD Primary Port Status . . . . .		64
TapeAlert log page . . . . .		65
Tape Usage log page . . . . .		67
Tape Capacity log page . . . . .		68
Data Compression log page . . . . .		68
Performance Data log page . . . . .		69
Device Status log page . . . . .		70
MODE SELECT . . . . .	15h/55h	71
Mode parameter pages . . . . .		72
Mode page representation . . . . .		73
Mode data format . . . . .		73
Mode block descriptor . . . . .		76

Read-Write Error Recovery mode page . . . . .	76
Disconnect-Reconnect page . . . . .	78
SCSI drives . . . . .	78
Control mode page . . . . .	79
Data Compression Characteristics page . . . . .	79
Device Configuration page . . . . .	81
Medium Partitions mode page . . . . .	83
Fibre Channel Logical Unit Control mode page . . . . .	84
SCSI LUN Control mode page . . . . .	84
Fibre Channel Port Control mode page . . . . .	85
SCSI Port Control Mode page . . . . .	87
Normal page . . . . .	87
Sub-pages . . . . .	87
Information Exceptions mode page . . . . .	91
Device Time mode page . . . . .	92
CD-ROM Emulation/Disaster Recovery mode page . . . . .	94
MODE SENSE . . . . .	1Ah/5Ah 96
PERSISTENT RESERVE IN . . . . .	5Eh 98
PERSISTENT RESERVE OUT . . . . .	5Fh 101
Additional parameter data . . . . .	103
PREVENT/ALLOW MEDIUM REMOVAL . . . . .	1Eh 105
READ . . . . .	08h 106
READ 6 ( <i>CD-ROM mode</i> ) . . . . .	08h 109
READ 10 ( <i>CD-ROM mode</i> ) . . . . .	28h 110
READ ATTRIBUTE . . . . .	8Ch 111
MAM attribute data . . . . .	115
Attribute ID values 116	
Standard device type attributes . . . . .	116
Standard medium type attributes . . . . .	118
Standard host type attributes . . . . .	118
READ BLOCK LIMITS . . . . .	05h 120
READ BUFFER . . . . .	3Ch 121
READ CAPACITY ( <i>CD-ROM mode</i> ) . . . . .	25h 124
Read Capacity data . . . . .	124
READ MEDIA SERIAL NUMBER . . . . .	ABh 125
READ POSITION . . . . .	34h 127
READ TOC ( <i>CD-ROM mode</i> ) . . . . .	43h 131
Read TOC data 132	
RECEIVE DIAGNOSTICS RESULTS . . . . .	1Ch 133
RELEASE UNIT . . . . .	17h/57h 135
REPORT DENSITY SUPPORT . . . . .	44h 137
REPORT DEVICE IDENTIFIER . . . . .	A3h 140
REPORT LUNS . . . . .	A0h 141
REPORT SUPPORTED OPCODES . . . . .	A0h 143
REPORT SUPPORTED TASK MANAGEMENT FUNCTIONS . . . . .	A3h 145
REQUEST SENSE . . . . .	03h 147
Request Sense data . . . . .	148

Fixed format . . . . .	148
Descriptor format	152
Sense data management . . . . .	154
Current sense . . . . .	154
UNIT ATTENTION sense . . . . .	155
DEFERRED ERROR sense . . . . .	156
Sense keys . . . . .	157
Additional Sense codes . . . . .	159
Error codes . . . . .	163
RESERVE UNIT . . . . .	16h/56h 164
REWIND . . . . .	.01h 166
SEEK ( <i>CD-ROM mode</i> ) . . . . .	2Bh 167
SEND DIAGNOSTIC . . . . .	.1Dh 168
Standard self-test . . . . .	169
SET CAPACITY . . . . .	0Bh 170
SET DEVICE IDENTIFIER . . . . .	A4h 171
SPACE . . . . .	.11h 172
START/STOP ( <i>CD-ROM mode</i> ) . . . . .	1Bh 175
TEST UNIT READY . . . . .	.00h 176
VERIFY . . . . .	.13h 177
WRITE . . . . .	.0Ah 178
WRITE ATTRIBUTE . . . . .	8Dh 180
WRITE BUFFER . . . . .	.3Bh 183
WRITE FILEMARKS . . . . .	.10h 186
Glossary . . . . .	187
Index . . . . .	191

# Related documents

This is one of six volumes that document HP Ultrium drives. This volume provides background information for driver and application developers. The following documents provide additional information:

## Documents specific to HP Ultrium drives

- Hardware Integration Guide, volume 1 of the HP Ultrium Technical Reference Manual
- Software Integration Guide, volume 2 of the HP Ultrium Technical Reference Manual
- Specifications, volume 4 of the HP Ultrium Technical Reference Manual
- HP Ultrium Configuration Guide, volume 5 of the HP Ultrium Technical Reference Manual
- Background to Ultrium Drives, volume 6 of the HP Ultrium Technical Reference Manual
- HP Ultrium Technology White Paper, which describes the features and benefits of HP Ultrium drives

Please contact your HP supplier for copies.

## Documentation map

The following will help you locate information in the 6-volume Technical Reference Manual:

### Drives—general

	SCSI Drives	FC Drives
Connectors	1 HW Integration: <i>ch. 7</i>	1 HW Integration: <i>ch. 4</i>
Controller architecture	6 Background: <i>ch. 4</i>	
Front Panel LEDs	1 HW Integration: <i>ch. 6</i>	1 HW Integration: <i>ch. 3</i>
Mechanism and hardware	6 Background: <i>ch. 3</i>	
Specifications	4 Specs	

### Installation and configuration

	SCSI Drives	FC Drives
Connectors	1 HW Integration: <i>ch. 7</i>	1 HW Integration: <i>ch. 4</i>
Determining the configuration	2 SW Integration: <i>ch. 2</i>	2 SW Integration: <i>ch. 2</i>
External drives ( <i>SCSI only</i> )	1 HW Integration: <i>ch. 5</i>	n/a
In Libraries	1 HW Integration: <i>ch. 1</i>	
In Servers ( <i>SCSI only</i> )	1 HW Integration: <i>ch. 4</i>	n/a
In Tape Arrays ( <i>SCSI only</i> )	1 HW Integration: <i>ch. 3</i>	n/a
Modes of Usage ( <i>SCSI only</i> )	1 HW Integration: <i>ch. 8</i>	n/a

	SCSI Drives	FC Drives
Optimizing performance ( <i>SCSI only</i> )	1 HW Integration: <i>ch. 8</i> 2 SW Integration: <i>ch. 4</i>	n/a
UNIX configuration	5 UNIX Config	

## Operation

	SCSI Drives	FC Drives
External drives ( <i>SCSI only</i> )	1 HW Integration: <i>ch. 5</i>	n/a
In Libraries	1 HW Integration: <i>ch. 1</i>	
In Servers ( <i>SCSI only</i> )	1 HW Integration: <i>ch. 4</i>	n/a
In Tape Arrays ( <i>SCSI only</i> )	1 HW Integration: <i>ch. 3</i>	n/a

## Cartridges

	SCSI Drives	FC Drives
Cartridge Memory (LTO-CM)	2 SW Integration: <i>ch. 5</i> 6 HW Integration: <i>ch. 5</i>	
Cartridges	1 HW Integration: <i>ch. 9</i>	1 HW Integration: <i>ch. 5</i>
Features	6 HW Integration: <i>ch. 5</i>	
Managing the use of cartridges	2 SW Integration: <i>ch. 1</i>	
Use of cartridges	2 SW Integration: <i>ch. 3</i>	

## Interface

	SCSI Drives	FC Drives
SCSI Guide	3 SCSI	
Commands	3 SCSI: <i>ch. 4</i>	
Error codes	1 HW Integration: <i>ch. 10</i>	1 HW Integration: <i>ch. 6</i>
Implementation	3 SCSI: <i>ch. 1</i>	
Interpreting sense data	2 SW Integration: <i>ch. 3</i>	
Messages	3 SCSI: <i>ch. 2</i>	
Mode pages —see the MODE SENSE command	3 SCSI: <i>ch. 4</i>	
Pre-execution checks	3 SCSI: <i>ch. 3</i>	
Responding to Sense Keys and ASC/Q	2 SW Integration: <i>ch. 6</i>	
Sense Keys and ASC/Q —see REQUEST SENSE command	3 SCSI: <i>ch. 4</i>	



## Maintenance and troubleshooting

	SCSI Drives	FC Drives
Cleaning	2 SW Integration: <i>ch. 5</i> 2 SW Integration: <i>ch. 7</i>	
External drives ( <i>SCSI only</i> )	1 HW Integration: <i>ch. 5</i>	n/a
In Libraries	1 HW Integration: <i>ch. 1</i>	
In Servers ( <i>SCSI only</i> )	1 HW Integration: <i>ch. 4</i>	n/a
In Tape Arrays ( <i>SCSI only</i> )	1 HW Integration: <i>ch. 3</i>	n/a
Monitoring drive and tape condition	2 SW Integration: <i>ch. 7</i>	
Software troubleshooting techniques	2 SW Integration: <i>ch. 1</i>	

## Dealing with errors

	SCSI Drives	FC Drives
Error Codes	1 HW Integration: <i>ch. 10</i>	1 HW Integration: <i>ch. 6</i>
Handling errors	2 SW Integration: <i>ch. 5</i>	
How error correction works	6 Background: <i>ch. 4</i>	
Logs—see the LOG SENSE command	3 SCSI: <i>ch. 4</i>	
Recovering from write and read errors	2 SW Integration: <i>ch. 7</i>	
Software response to error correction	2 SW Integration: <i>ch. 3</i>	
Software response to logs	2 SW Integration: <i>ch. 3</i>	
TapeAlert log	2 SW Integration: <i>ch. 7</i>	

## Ultrium features

	SCSI Drives	FC Drives
Adaptive Tape Speed (ATS)	6 Background: <i>ch. 1</i>	
Autoload	1 HW Integration: <i>ch. 2</i>	
Automation Control Interface (ACI)	1 HW Integration: <i>ch. 2</i> 6 Background: <i>ch. 1</i>	
Cartridge Memory (LTO-CM)	1 HW Integration: <i>ch. 2</i> 2 SW Integration: <i>ch. 5</i> 6 HW Integration: <i>ch. 5</i>	
Data Compression, how it works	6 Background: <i>ch. 5</i>	
Data Compression, managing	2 SW Integration: <i>ch. 5</i>	
Design principles	6 Background: <i>ch. 1</i>	
OBDR and CD-ROM emulation	6 Background: <i>ch. 1</i> 2 SW Integration: <i>ch. 7</i>	
Performance optimization	1 HW Integration: <i>ch. 8</i>	n/a
	2 SW Integration: <i>ch. 1</i>	
Performance, factors affecting	2 SW Integration: <i>ch. 4</i>	

	SCSI Drives	FC Drives
Software design	2 SW Integration: <i>ch. 1</i>	
Supporting Ultrium features	2 SW Integration: <i>ch. 5</i>	
Ultrium Format	6 Background: <i>ch. 2</i>	

## General documents and standardization

- Enhanced Small Computer System Interface (SCSI-2), ANSI X3T9.2-1993 Rev. 10L, available through ANSI
- See [http://www.t10.org/t10\\_main.htm](http://www.t10.org/t10_main.htm) for ANSI SCSI-3 and other specifications

Copies of documents of other standards bodies can be obtained from:

*ANSI* 11 West 42nd Street  
New York,  
NY 10036-8002  
USA

*ISO* CP 56  
CH-1211 Geneva 20  
Switzerland

*ECMA* 114 Rue du Rhône  
CH-1204 Geneva  
Switzerland

*Tel:* +41 22 849 6000

*Web URL:* <http://www.ecma.ch>

*Global Engineering Documents* 2805 McGaw  
Irvine, CA 92714  
USA

*Tel:* 800 854 7179 or 714 261 1455

# 1 Interface Implementation

HP Ultrium drives use SCSI-3 as the interface to connect to the host system.

This chapter gives an overview of how the interface operates.

Full details of the messages are given in Chapter 2 and of commands in Chapter 3 and Chapter 4.

## The SCSI interface

The Small Computer System Interface (SCSI) is an industry standard, approved by the American National Standards Institute (ANSI). You are recommended to read the ANSI standard document in conjunction with this manual. The ANSI specification defines the interface in general while this document describes the HP Ultrium implementation.

The SCSI implementation provides a drive with a standard set of features and functions. These include the following:

- Synchronous data transfers
- Asynchronous data transfers
- Implementation of all mandatory and most optional commands of the Sequential Access command set
- LVD (Low-Voltage differential) SCSI connection
- Ultra-320 wide SCSI
- Conformance to the following SCSI standards:
  - SAM-2 ANSI INCITS.366:2003
  - SPI-4 ANSI INCITS.362:2002
  - SPC3
  - SSC-2 ANSI INCITS.380:2003

## Supported messages

The following messages are supported by the drives:

- ABORT
- BUS DEVICE RESET
- COMMAND COMPLETE

- DISCONNECT
- IDENTIFY
- IGNORE WIDE RESIDUE
- INITIATOR DETECTED ERROR
- MESSAGE PARITY ERROR
- MESSAGE REJECT
- NO-OP (*no operation*)
- PARALLEL PROTOCOL REQUEST (PPR)
- RESTORE POINTERS
- SAVE DATA POINTER
- SYNCHRONOUS DATA TRANSFER REQUEST
- WIDE DATA TRANSFER REQUEST

For implementation details on these messages, see Chapter 2, “Messages”

## Supported commands

The following commands are supported by the drives. They include all Mandatory and Extended commands and most Optional commands.

19h	ERASE	03h	REQUEST SENSE
12h	INQUIRY	44h	REPORT DENSITY SUPPORT
1Bh	LOAD/UNLOAD	A3h (05h)	REPORT DEVICE IDENTIFIER
2Bh	LOCATE	A0h	REPORT LUNS
4Ch	LOG SELECT	A3h (0Ch)	REPORT SUPPORTED OP CODES
4Dh	LOG SENSE	A3h (0Dh)	REPORT SUPPORTED TASK MNGMNT FUNCTNS
15h/55h	MODE SELECT	56h/16h	RESERVE UNIT
1Ah/5Ah	MODE SENSE	01h	REWIND
5Eh	PERSISTENT RESERVE IN	1Dh	SEND DIAGNOSTIC
5Fh	PERSISTENT RESERVE OUT	0Bh	SET CAPACITY
1Eh	PREVENT/ALLOW MEDIUM REMOVAL	A4h (06h)	SET DEVICE IDENTIFIER
08h	READ	11h	SPACE
8Ch	READ ATTRIBUTE	00h	TEST UNIT READY
05h	READ BLOCK LIMITS	13h	VERIFY
3Ch	READ BUFFER	0Ah	WRITE
ABh (01h)	READ MEDIA SERIAL NUMBER	8Dh	WRITE ATTRIBUTE
34h	READ POSITION	3Bh	WRITE BUFFER
1Ch	RECEIVE DIAGNOSTIC RESULTS	10h	WRITE FILEMARKS
57h/17h	RELEASE UNIT		

The following additional commands are supported for CD-ROM mode:

08h	READ 6	43h	READ TOC
28h	READ 10	2Bh	SEEK
25h	READ CAPACITY	1Bh	START/STOP UNIT

For implementation details on these commands, see Chapter 3, “Commands—introduction” and Chapter 4, “Commands”.

---

## SCSI features

### Design approach

The features supported by the drive are based on standards, both official and de facto. The drive is fully compliant with the current SCSI standards: SPC3, SSC2, SAM2, and the relevant transport protocol (e.g. SPI4 for the parallel SCSI drive). All mandatory commands and features are supported, as well as some that are optional. In addition, some features from older standards are still supported for backwards compatibility.

### Power-on

The drive will respond to INQUIRY, TEST UNIT READY, REPORT LUNS and REQUEST SENSE commands within 250 ms of power on. The first command received from an initiator (other than INQUIRY and REQUEST SENSE) will result in CHECK CONDITION status, with UNIT ATTENTION sense data reported for the power on. Once the drive has completed its self-test and set-up procedures, it will attempt to reload any tape that is already present in the drive. It may take some time to recover the tape, especially if it was positioned near EOM when power was cycled. During tape recovery, medium access commands will result in a sense key of NOT READY, with additional sense of 0401h (drive in process of becoming ready).

### Reset strategy

The drive supports reset as follows:

- The current I/O process is aborted
- Any queued I/O processes from other initiators are removed
- All negotiated settings are cleared (*parallel SCSI drives only*)
- Mode parameters are cleared to their default values
- Any reservations are cleared (but not persistent reservations)
- Any buffered writes are flushed to tape
- The logical position becomes undefined, unless Rewind-On-Reset has been configured in which case the drive will rewind to BOM

- A UNIT ATTENTION condition is set, based on the type of reset

The drive will respond to INQUIRY, TEST UNIT READY, REPORT LUNS and REQUEST SENSE within 250 ms of the reset line being released. The first command from any initiator (other than INQUIRY, REQUEST SENSE and REPORT LUNS) will result in CHECK CONDITION status with UNIT ATTENTION sense data for the reset. Note that all commands will receive BUSY status until the drive has completed its internal reset.

The Reset button on the front panel and the ACI\_RESET\_L line on the Automation Controller Interface are both connected to the Power-Up Reset interrupt on the processor. The effect is equivalent to power-cycling the drive. The contents of the tape and cartridge memory may not be consistent after the action and any data in the drive buffer will be lost.

## Abort handling

If an abort condition is detected before a command phase completes, the bus is set to bus free and the command is not executed.

If an abort condition is detected between the end of the command phase and the start of the status phase, the bus is set to bus free and the processing below is carried out.

If an abort condition is detected during status phase, the bus is set to bus free.

If a command (other than INQUIRY for standard data or REQUEST SENSE) is received after the abort but before the drive is ready to process the command, the behavior depends on whether Disconnects are allowed.

- If disconnects are allowed, the drive will disconnect and wait until the abort processing has completed before executing the command.
- If disconnects are not allowed, a BUSY response will be returned.

Command	Abort Processing
ERASE	Long erase is aborted as quickly as possible without corrupting the tape format. Short erase completes.
INQUIRY	None
LOAD/UNLOAD	Load completes and logically positions the tape at BOT. Unload is aborted leaving the logical position at BOT unless the operation is past the "point of no return" in which case the tape is ejected.
LOCATE	The logical position is set back to that at the start of the operation.
LOG SELECT	If data transfer is complete, the command is completed, otherwise no action is taken
LOG SENSE	None
MODE SELECT	If data transfer is complete, the command is completed, otherwise no action is taken.
MODE SENSE	None

Command	Abort Processing
PREVENT/ALLOW MEDIUM REMOVAL	The command completes.
READ	The logical position is set to that at the start of the operation.
READ BLOCK LIMITS	None
READ BUFFER	None
READ POSITION	None
RECEIVE DIAGNOSTICS RESULTS	None
RELEASE UNIT	The command completes.
REQUEST SENSE	Sense data is discarded.
RESERVE UNIT	The command completes.
REWIND	The command completes.
SEND DIAGNOSTIC	If data transfer is complete, the command is completed, otherwise no action is taken
SPACE	The logical position is set back to that at the start of the operation.
TEST UNIT READY	None
WRITE	The logical position is set back to that at the start of the operation.
WRITE BUFFER	If data transfer is complete, the command is completed, otherwise no action is taken.
WRITE FILEMARKS	The logical position is set back to that at the start of the operation
VERIFY	The logical position is set back to that at the start of the operation

## LUN identification *(parallel SCSI only)*

Identify messages are used to identify the LUN being addressed by the initiator, and to identify which LUN is reselecting the initiator. The old LUN field in the CDB from the SCSI-2 standards is obsolete and should not be used (set to 0).

## Bus parity or CRC errors

If the drive detects a bus parity error in a message out or command phase, it will still accept the command, which will then return CHECK CONDITION. Additional sense is 4700h (SCSI parity error). Detection of a parity error during the data out phase also causes the drive to return CHECK CONDITION. Additional sense is set to 4701h (data phase CRC error detected) if the bus is in DT mode or 4700h if not.

If Information Units is enabled (parallel SCSI only), the drive will drop the bus on detecting a CRC error during a LQ\_IU. If the CRC error occurs during the Information Units command phase or data out phase, the drive will return CHECK CONDITION with a CRC error. Additional sense is set to 4703h (Information Unit CRC error detected).

On detecting an Initiator Detected error, the drive will return CHECK CONDITION with additional sense of 4800h (initiator detected error message received). The exception is when Information Units mode is enabled (parallel SCSI only), when one of the following occurs:

- If an IDE message is received during a LQ\_IU, the drive drops the bus and retries the LQ\_IU pair.
- If the message is received during Status IU, the drive retries the LQ\_Status pair.
- If the message is received during Data IU, the drive sends a LQ\_Status with CHECK CONDITION and additional sense of 4800h.

## Disconnect strategy

The disconnect strategy used by the drive is based on maximizing the use of the bus for large sequential data transfers from a large data buffer. The drive will disconnect whenever it believes that it will provide better bus use. This may be between command and data phases, between bursts of data or before sending status. However, the drive will guarantee that it sends the configured maximum burst size or the remaining data in the transfer in any single data phase burst if the maximum burst size has been set to a value other than zero.

The following diagram gives an overview of the drive's disconnect strategy:



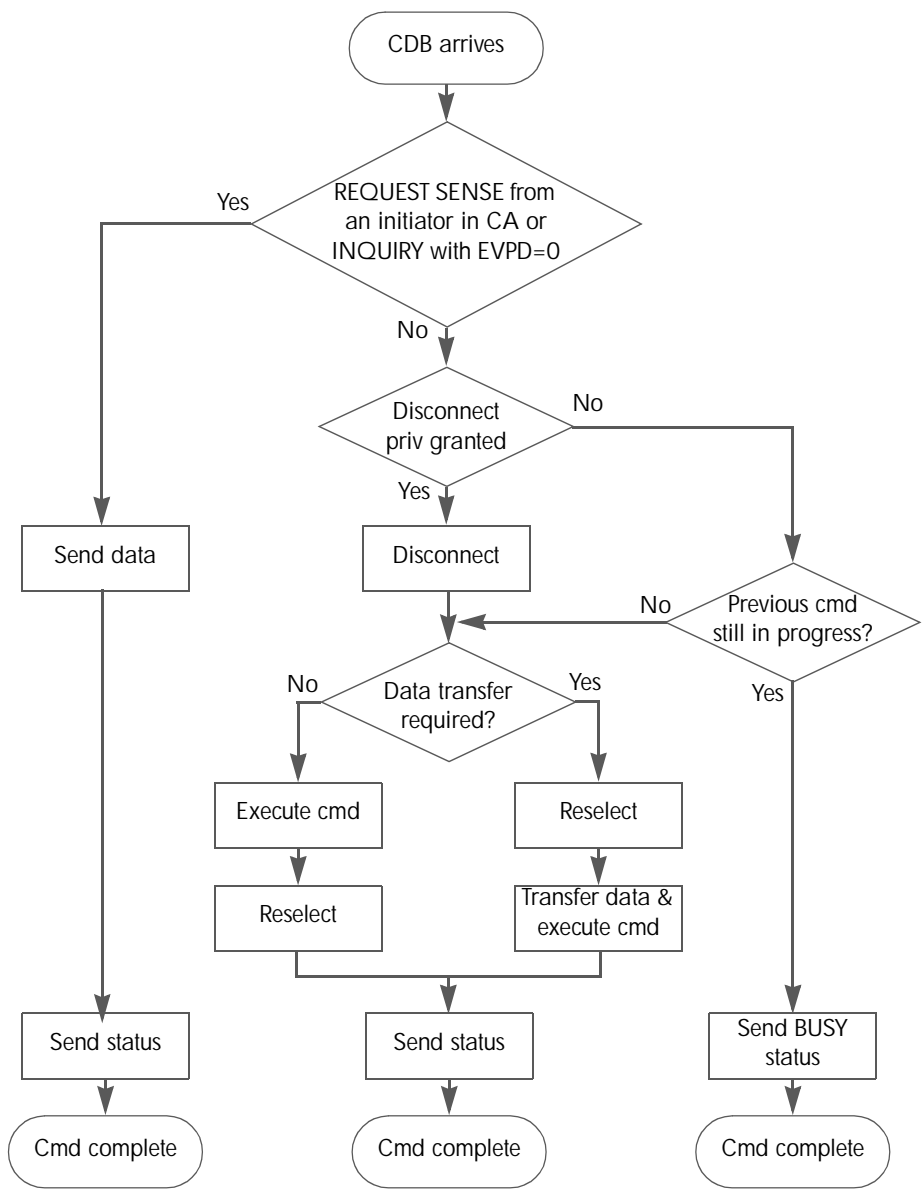

## Multi-initiator support

All drives are design to operate within a multi-initiator environment. The maximum number of concurrently connected initiators is as follows:

- *Parallel SCSI drives*: up to 15 initiators
- *Fibre Channel drives*: up to 32 initiators shared across both ports

Sense Data, Unit Attention and Deferred Errors are maintained for each initiator. Mode Parameters are common to all initiators.

The untagged queuing model implemented by the drives guarantees that all commands are executed in strict order of receipt. Certain non-media access type commands, such as TEST UNIT READY, INQUIRY, REQUEST SENSE and REPORT LUNS, are implicitly allowed to queue-jump other media access type commands, such as REWIND.

The parallel SCSI drive supports the full command queuing model with a queue depth of 1 (necessary for connectivity purposes). The FC drive supports the basic queuing model with a queue depth of 4. See "Standard Inquiry Data format (LUN0)" on page 40 for details of the BQue and CmdQue bits which define this support.

---

## Fibre Channel operation

---

NOTE: This applies only to Fibre Channel drives.

---

The following sections have information specific to Fibre Channel operation:

- "Fibre Channel Logical Unit Control mode page" on page 84
- "Fibre Channel Port Control mode page" on page 85
- "Vital Product Data pages" on page 44

## Fibre Channel addressing

Before describing HP's implementation of Fibre Channel addressing, the concepts of Names and Addresses need to be clarified.

### Names

Names are 64-bit identifiers assigned permanently to the tape drive during manufacture. They are commonly referred to as World Wide Names since they must be guaranteed unique. The names are typically used for identifying the device to operating systems, since addresses are assigned dynamically. There are at least eight different name formats distinguished by the Network Address Authority (NAA). Only one is used on HP Ultrium drives. This is the IEEE Registered Name (NNA=5) and has the following format:

	31	byte 0	24	23	byte 1	16	15	byte 2	8	7	byte 3	0	
word 1	NAA=5				IEEE Company ID (24 bits)				VSID				
word 2					Vendor Specified ID (36 bits)								

This name is made up of three fields:

- NAA Identifier (4 bits). "5" indicates a IEEE Registered Name.

- IEEE Company ID (24 bits). Assigned by IEEE to the company.
- Vendor Specified ID (36 bits). Assigned by the company.

## Addresses

Each Fibre Channel port also has a Port Address which is assigned during loop initialization and/or Fabric Login. This is a 24-bit value in the following format:



The AL\_PA is the Arbitrated Loop Physical Address. This is normally assigned dynamically during loop initialization.

If the loop is not attached to a fabric (in other words, when it is private,) the top two bytes will be zero. If the loop is attached to a fabric, the tape drive is assigned the top two bytes when it logs into the fabric.

Together, the three bytes provide a unique address on the Fibre Channel fabric that is used for frame addressing. It forms the equivalent of the Target ID or Initiator ID in SCSI.

## HP's implementation of names and addresses

The HP implementation uses three adjacent IEEE Registered Names:

- The first (last bits = 00) is used as the *Port A World Wide Name*.
- The second (last bits = 01) is used as the *Port B World Wide Name*.
- The third name (last bits = 10) is used for the *Device World Wide Name*.

(These are assigned during manufacture from HP's pool of names, although only the first will actually be stored in the drive NV-RAM).

The port addresses will be assigned using the 'standard' AL\_PA initialization mechanisms. The 'Fibre Channel Port Control mode page' controls this. The drive has the ability to support hard addresses as part of this scheme.

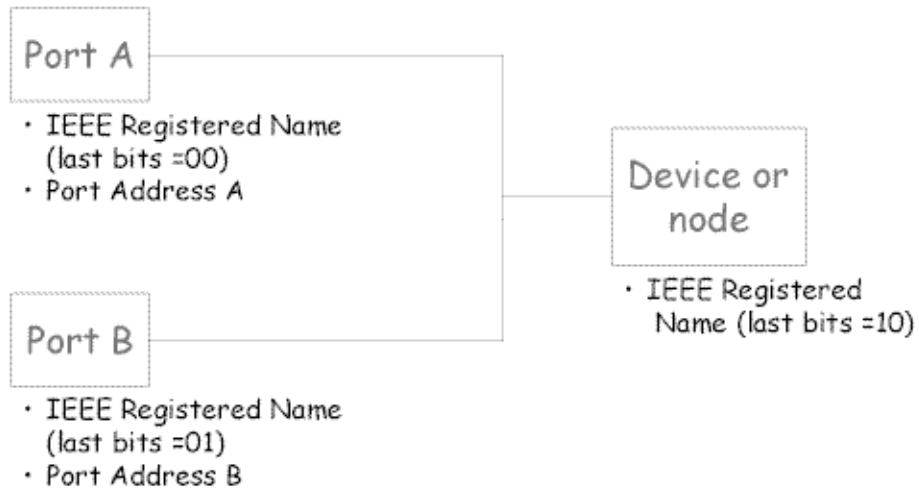

The values of the names can be obtained using the Device Identification Vital Product Information Page (part of the INQUIRY command).

### Implications for libraries

- Normally a standalone drive will operate using its own 'hard' names.
- The drive knows it is in a library or other 'managed' environment since one of the signal lines on the ACI (Automation Control Interface) will be tied down.

In this case, the drive will not go on the FC loop until it is told to. The library can optionally download a new, soft base name (Port A/Device Name) into the drive at this point. The drive will then use this as the origin of its names. The library manufacturer would be responsible for obtaining this IEEE Registered Name. It would be a property of the library, *not* the drive.

- If the library wants to 'warm swap' drives, it can. It just 'turns off' the drive with the soft name using the ACI and then turns on the spare drive, downloading the same name to it.
- If a drive is removed from the library, it will not have the ACI signal tied low and so will revert to its original hard name. It should forget the soft name in this case.
- If the library controller breaks, the drive will time out the ACI interface in ~10 seconds. The drive still knows it is in a library since the ACI signal is still tied low, so in this case it will use the soft name last downloaded. This will allow drive access without confusing the host.

---

## Field replaceable units

An FRU code identifies which part of the hardware is considered to have failed. These codes turn up in sense data byte 14 and as the sense code qualifier for sense codes 4400h (internal target failure) and 40XX (diagnostic failure).

Although there are no actual *Field Replaceable Units* on HP Ultrium drives, the following sub-assemblies can be replaced at Repair Centres:

- Drive PCA
- Mechanism
- Head Assembly
- Front Panel

---

## CD-ROM emulation

The One Button Disaster Recovery (OBDR) functionality in HP Ultrium drives enables them to emulate CD-ROM devices in specific circumstances (also known as being in “Disaster Recovery” mode). The drive can then act as a boot device for PCs that support booting off CD-ROM.

A CD-ROM capable drive can be switched into CD-ROM mode by powering on with the eject button held down. The drive then alters its behavior as follows:

- The front panel lights flash a “warbling” sequence.
- CD-ROM commands are executed (as opposed to tape drive mode when they would be rejected). Commands specific to CD-ROM mode are READ 10, READ TOC and READ CAPACITY. In the case of SCSI commands 08h (READ), 1Bh (LOAD/UNLOAD) and 2Bh (LOCATE), these are interpreted as CD-ROM commands 08h (READ 6), 1Bh (START/STOP) and 2Bh (SEEK) respectively.
- Writing is disabled.
- Normal INQUIRY data is modified to add a field indicating that the drive supports CD emulation and to switch the peripheral device type field to indicate a CD-ROM drive.
- The mode header and mode block descriptor are modified.
- A CD-Emulation mode page is added.
- Mode data changes to reflect CD-ROM medium type and block size.
- Status reporting by the media access check is altered.
- The drive’s sense data when the media is not ready for access always indicates “loading”.

If a tape is inserted while the drive is in CD-ROM mode, the drive assumes that it will contain an image of a CD offset 20 blocks into the tape. It reads the first 250 kilobytes of this image into buffer space reserved for CD-caching. It then looks for a special message (“EL TORITO SPECIFICATION”) at the 8th byte of the 18th record of the image. If the drive fails to find this message, it ejects the tape and waits in CD-ROM mode for a properly-written CD-image tape to be inserted.

The drive will remain in CD-emulation mode until one of the following occurs:

- A MODE SELECT command switches it back to tape drive mode using the CD-emulation mode page.

- A SCSI bus reset occurs following the reading of at least 100 blocks of CD-ROM data by a host.
- The user power-cycles the drive or resets it using the forced-eject mechanism.

---

NOTE: If the drive exits CD-ROM mode through either of the first two of these, the tape will remain at the last logical position when in CD-ROM mode.

---

## 2 Messages

This chapter includes all SCSI messages, both supported and unsupported. Parts of this chapter come from Section 5, Logical Characteristics, of the SCSI standards (see page 11).

The message system provides an initiator and a target on the SCSI bus with a means of managing communication. The available messages are listed in this chapter.

### Message Out support

Name	Code	Support
Abort	06h	An abort condition is generated (see “Abort handling” on page 14).
Bus Device Reset	0Ch	A reset condition is generated (see “Reset strategy” on page 13).
Extended Message	01h	See “Extended Message Support” below.
Identify	80h+	The Identify Out message is sent by the initiator to identify the Logical Unit to be accessed and to set Disconnect Privilege.
Initiator Detected Error	05h	<p>The initiator has detected an error in the data being sent in a Command, Data or Status phase. The drive will send a restore data pointers message to retry the data transfer. (See “Message In support” below for details).</p> <p>If the message is received immediately after an Identify message or after the Command Complete message has been sent, the drive will go Bus Free.</p>
Message Parity Error	09h	<p>The initiator has detected a parity error in a message. The drive will retry the message. (See “Message In support” below for details).</p> <p>If the message is received immediately after an Identify message or after the Command Complete message has been sent, the drive will go Bus Free.</p>
Message Reject	07h	<p>This message is sent when the initiator does not support a message sent by the drive or that the message is inappropriate. If the message being rejected is Disconnect, Synchronous Data Transfer Request or Wide Data Transfer Request, the operation continues without those features. For all other messages, the message is treated as an Abort message.</p> <p>If the message is received during a Command, Data or Status phase, immediately after an Identify message or after the Command Complete message has been sent, the drive will go Bus Free.</p>
No Operation	08h	This message has no effect and is ignored.

# Message In support

Name	Code	Support
Command Complete	00h	This message is sent by the drive at the end of the status phase to indicate that a command is complete. Once the message is sent, the drive releases the bus and goes to Bus Free.
Disconnect	04h	This message is sent by the drive to indicate that it is about to disconnect from the bus and go to Bus Free. During a Data phase, it is always pre-ceded by a Save Data Pointers message. If a Message Reject message is received in response to this message, then the disconnect is prevented.
Extended Message	01h	See "Extended Message Support" below.
Identify	8Xh	The Identify In message is sent to the initiator during reconnect to indicate which Logical Unit is reconnecting.
Ignore Wide Residue	23h	<p>This message is sent by the drive to the host to indicate that a byte on a wide bus is not valid.</p> <p>This is supported whenever a wide transfer is active. It should be sent at the end of the data phase. The standard action of the drive is to send this message between the data phase and the status phase with no disconnect.</p>
Message Reject	07h	This message is sent to the initiator when the message received by the drive is unsupported or inappropriate.
Restore Pointers	03h	This message causes the initiator to reset its data transfer pointers to the values they held when the last save data pointers message was sent. It will be sent when a parity error is detected on the bus or when an Initiator Detected Error message is received in order to retry the data phase.
Save Data Pointers	02h	This message instructs the initiator to save its current data transfer pointers for use with a subsequent Restore pointers message. This message will always be sent before a Disconnect message during data phases.



## Extended Message support

Name	Code	Support
Synchronous Data Transfer Request	01h	The drive can initiate a Synchronous data transfer negotiation. If the message is received after selection and before the command phase, it will then go to message-in phase and respond with a valid response to complete the negotiation.
Wide Data Transfer	03h	The drive can initiate a Wide data transfer negotiation. If the message is received after selection and before the command phase, it will then go to message-in phase and respond with a valid response to complete the negotiation.  Note that SDTR negotiated parameters will become asynchronous after a WDTR.
Parallel Protocol Request	04h	The drive will never initiate a Parallel Protocol Request transfer negotiation but will expect the initiator to do so.  If the message is received after selection and before the command phase, it will then go to message-in phase and respond with a valid response to complete the negotiation.

### Synchronous Data Transfer Request

	7	6	5	4	3	2	1	0
0	Extended Message (01h)							
1	Extended Message Length (03h)							
2	SDTR (01h)							
3	Transfer Period Factor							
4	Req/Ack Offset							

### Wide Data Transfer Request

	7	6	5	4	3	2	1	0
0	Extended Message (01h)							
1	Extended Message Length (02h)							
2	WDTR (01h)							
3	Transfer Width Exponent							

## Parallel Protocol Request

	7	6	5	4	3	2	1	0
0	Extended Message (01h)							
1	Extended Message Length (06h)							
2	Parallel Protocol Request (04h)							
3	Transfer Period Factor							
4	Reserved (0)							
5	Req/Ack Offset							
6	Transfer Width Exponent							
7	PComp_En	RTI	Rd_Strm	WR_Flow	Hold_MCS	QAS_Req	DT_Req	IU_Req

### Fields:

Transfer Period Factor	08h	Transfer period of 6.25 ns, Paced Information Unit transfers
	09h	Transfer period of 12.5 ns (FAST-80). Only valid when DT transfers have been requested
	0Ch	Transfer period of 50 ns (FAST-20) — LVD/SE drives only
	19h	Transfer period of 100 ns (FAST-10)
	32h	Transfer period of 200 ns (FAST-5)
Req/Ack Offset	This has a maximum value of 255.	
Transfer Width Exponent	For ST transfers, this can be either 0 (Narrow) or 1 (Wide). For DT transfers, it must be set to 1.	
PComp_En	Precompensation enable bit. Supported.	
RTI	Retain Training Information bit. Supported.	
Rd_Strm	0	Read streaming and read flow control enable bit. Not supported, so the drive will always return zero.
Wr_Flow	0	Write flow control enable bit. Not supported; the drive will always return zero.
Hold_MCS	0	Hold Margin Control Settings bit. Not supported; the drive will always return zero.
QAS_Req	0	QAS enable request bit. Not supported; the drive will always return zero.
DT_Req	This bit determines whether DT mode has been requested, in other words, packetized data transfers. Supported.	
IU-Req	Information units enabled request bit. Supported.	

## Status

A Status byte is sent from the drive to the host during the Status phase at the end of each command as specified in the SCSI specification, unless the command has been cleared by an ABORT message, by a BUS DEVICE RESET message, or by a hard reset.

The Status bytes that the drive returns are as follows:

00h	GOOD: This status indicates that the drive has successfully completed the command.
02h	CHECK CONDITION: Any error, exception, or abnormal condition that causes sense data to be set returns CHECK CONDITION. The REQUEST SENSE command should be sent following this status to determine the nature of the error.
04h	CONDITION MET: This status will never be returned by an HP Ultrium tape drive.
08h	BUSY: The drive is unable to execute the command at this time. Try again later. The drive tries to avoid using this status code during normal operation. It can sometimes be used after commands have been aborted, during power-on and if there are multiple selecting initiators.
10h	INTERMEDIATE: This status will never be returned by an HP Ultrium tape drive.
14h	INTERMEDIATE CND: This status will never be returned by an HP Ultrium tape drive.
18h	RESERVATION CONFLICT: Returned if the drive is reserved by another party. See the Reservation check.
22h	COMAND TERMINATED: This status will never be returned by an HP Ultrium tape drive.
28h	QUEUE FULL



# 3 Commands—introduction

This chapter contains notes relating to the SCSI commands listed in Chapter .

## Summary

The following table is a summary of the SCSI commands for sequential access devices, showing the operation code:

Opcode	Command Name	Opcode	Command Name
00h	TEST UNIT READY	2Bh	LOCATE
01h	REWIND	2Bh	SEEK <i>(CD-ROM)</i>
03h	REQUEST SENSE	34h	READ POSITION
05h	READ BLOCK LIMITS	3Bh	WRITE BUFFER
08h	READ	3Ch	READ BUFFER
08h	READ 6 <i>(CD-ROM)</i>	43h	READ TOC <i>(CD-ROM)</i>
0Ah	WRITE	44h	REPORT DENSITY SUPPORT
0Bh	SET CAPACITY	4Ch	LOG SELECT
10h	WRITE FILEMARKS	4Dh	LOG SENSE
11h	SPACE	55h	MODE SELECT (10)
12h	INQUIRY	56h	RESERVE UNIT (10)
13h	VERIFY	57h	RELEASE UNIT (10)
15h	MODE SELECT	5Ah	MODE SENSE (10)
16h	RESERVE UNIT	5Eh	PERSISTENT RESERVE IN
17h	RELEASE UNIT	5Fh	PERSISTENT RESERVE OUT
19h	ERASE	8Ch	READ ATTRIBUTE
1Ah	MODE SENSE	8Dh	WRITE ATTRIBUTE
1Bh	LOAD/UNLOAD	A0h	REPORT LUNS
1Bh	START/STOP UNIT <i>(CD-ROM)</i>	A3h (05h)	REPORT DEVICE IDENTIFIER
1Ch	RECEIVE DIAG RESULTS	A3h (0Ch)	REPORT SUPPORTED OPCODES
1Dh	SEND DIAGNOSTIC	A3h (0Dh)	REPORT SUPPORTED TASK MGMNT FNS
1Eh	PREVENT MEDIUM REMOVAL	A4h (06h)	SET DEVICE ID
25h	READ CAPACITY <i>(CD-ROM)</i>	ABh (01h)	READ MEDIA SERIAL NUMBER
28h	READ 10 <i>(CD-ROM)</i>		

## Command details

The command descriptions in Chapter 4 are listed in alphabetical order of command name. Each command is described briefly. This is followed by a list of pre-execution checks which are described below. The Command Descriptor Block (CDB) is then given, with details of the various parameter bits and fields.

---

# Pre-execution checks

---

**NOTE:** In compliance with the SCSI specification, the drive terminates a command with a CHECK CONDITION status and sets the sense key to ILLEGAL REQUEST when a reserved bit, byte, field or code is received which is not zero.

---

Before executing a command, the drive makes a number of checks. They fall into three categories:

- Checks on the command sent by the host. These ensure that no reserved or fixed fields have been set to illegal values. They check the syntax of commands, in other words the cross dependency of fields. For example, the Flag bit must not be set if the Link bit is not set.
- Checks to ensure that there are no outstanding UNIT ATTENTION or DEFERRED ERROR events posted for the host that has sent the command.
- Checks on media access abilities. These are performed for commands requiring access to the cartridge. A command is rejected if it attempts to access the cartridge when no cartridge is present or the cartridge is unloaded.

The checks are described below in alphabetical order. The usual order of execution is Illegal Field, Fixed Bit, Flag Link, Bad LUN, Reservation, Deferred Error, Unit Attention, Media Access, Media Write, Diagnostic Status, Humidity, Parameter List.

## Bad LUN check

For all commands except INQUIRY 12h, this checks that the LUN specified by the host is zero. The LUN is taken from the lowest 5 bits of the host's IDENTIFY message.

- If no IDENTIFY message is supplied, the LUN is taken from the host's Command Descriptor Block.
- If an IDENTIFY message *is* supplied, the LUN in the host's Command Descriptor Block is ignored
- If the LUN is unsupported, and the host command is not REQUEST SENSE, CHECK CONDITION is reported to the host with a sense key of ILLEGAL REQUEST, and additional sense of 2500h (logical unit not supported).
- If the LUN is unsupported, and the host command *is* REQUEST SENSE, the original sense data is replaced with a sense key of ILLEGAL REQUEST, and additional sense of 2500h (logical unit not supported). This new sense data is returned to the host. Once the command has completed successfully, the sense data is cleared.

## Deferred Error check

A deferred error is generated when a command with immediate report fails after the report has been returned. The check looks to see if a deferred error exists for the host which sent the command, in other words, a deferred error for which CHECK CONDITION status has not yet been

reported. If such an error exists, then the drive reports CHECK CONDITION. The sense data for the command is set to DEFERRED ERROR (which was generated when some previous command failed).

Note that if a UNIT ATTENTION condition and a DEFERRED ERROR condition both exist for an initiator, the DEFERRED ERROR condition will be reported first. This is because the operation leading to the deferred error must have been older than that leading to the unit attention. The drive reports the conditions in the order in which they arose.

## Diagnostic Status check

This ensures that the drive is in a fit state to access the media. It does this by checking that there is no DIAGNOSTIC FAIL status within the drive.

If the drive has failed diagnostics, CHECK CONDITION is reported with a sense key of HARDWARE ERROR and additional sense of 400Xh (diagnostic failure on component X).

## Fixed Bit check

For the READ, VERIFY and WRITE commands, a Fixed bit set to 1 indicates that the length parameter of the command is for fixed block mode. If fixed block mode is selected then the block size in the Mode Select block descriptor must not be zero. Otherwise CHECK CONDITION is reported and the sense data is set as described for the ILLEGAL FIELD check.

## Flag Link check

This check ensures that the host has not set the Flag bit in the control byte of the command without setting the Link bit as well. If the test fails then CHECK CONDITION is reported with a sense key of ILLEGAL REQUEST and additional sense of 2400h (invalid field in CDB). The Flag field is identified as the bad field.

## Illegal Command check

If the drive does not recognize the opcode of the command that it has been sent, it will do one of the following:

- Report CHECK CONDITION status. The sense key will be set to ILLEGAL REQUEST and the additional sense code will be set to 2000h (invalid command opcode).
- Report an invalid field in the command descriptor block. The sense key will be set to ILLEGAL REQUEST, the additional sense code will be set to 2400h (invalid field in CDB) and the field pointer in the sense data will be zero.

## Illegal Field/Request check

Checks are performed to ensure the host has not set any of the following in the command descriptor block:

- a fixed field

- a reserved field
- the control field
- two or more fields to logically conflicting values

If a field has been set to an illegal value:

- CHECK CONDITION status is reported to the host with a sense key of ILLEGAL REQUEST and additional sense of 2400h "invalid field in CDB".
- The sense key specific bit is set and the sense key specific bytes will be a field pointer.
- The command/data bit is set, indicating that the illegal parameter was in the command.

---

NOTE: Command descriptor blocks are scanned from left (bit 7) to right (bit 0), and down (from byte 0 to byte *n*). The field pointer will be set to point to the first bit of the first illegal field encountered using this scanning route. In some cases, where multiple fixed fields are contiguous, the field pointer might be set to point to the first bit of the first fixed field in the group of fixed fields, whereas the actual illegality may lie in a later bit.

---

## Media Access check

This checks if the drive is able to perform media access commands. If the media is inaccessible then CHECK CONDITION status is reported with a sense key of NOT READY. The additional sense will be set to one of the codes associated with the NOT READY key.



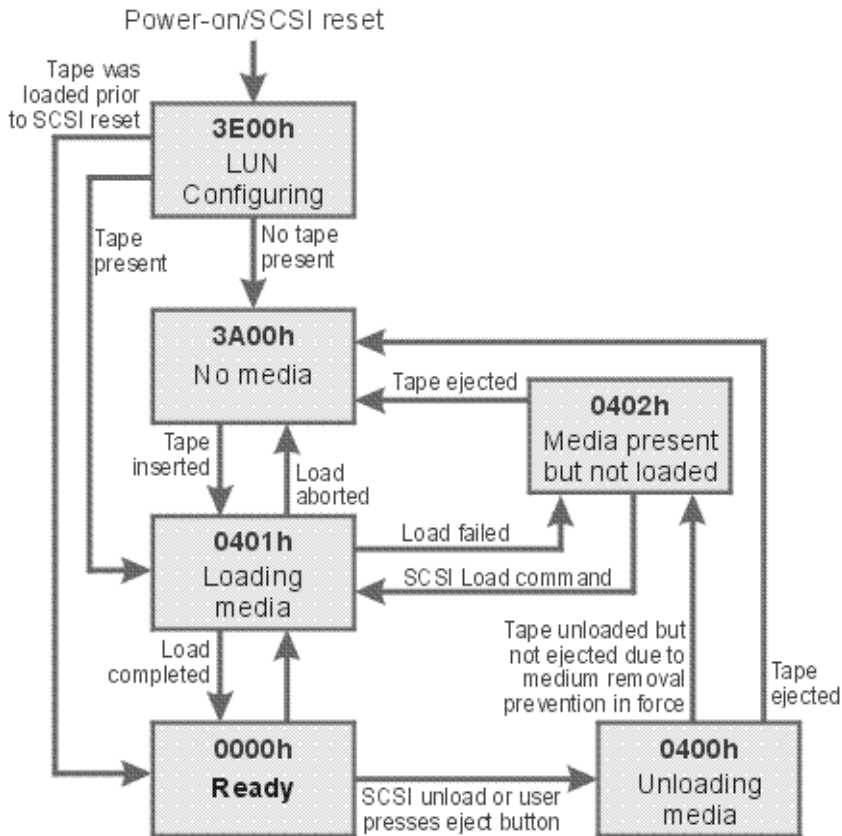

## Media Information check

During power-on and following a SCSI reset, knowledge of the whereabouts of the cartridge is unavailable. It is not possible to execute commands which assume that this knowledge is available until the drive has recovered from the power-on or reset.

The test checks whether the drive knows if a cartridge is physically present in the drive.

If information about the tape cartridge is not available, the test fails with CHECK CONDITION, a sense key of NOT READY, and additional sense of 3E00 (logical unit has not self-configured yet).

## Media Write check

This checks whether the media is write-protected. If it is, CHECK CONDITION is reported with a sense key of DATA PROTECT and additional sense of 2700h (write-protected).

## Parameter List check

For LOG SELECT, MODE SELECT and some diagnostic commands, the associated data sent to the drive is in the form of parameter lists. These are described under the command names in the next chapter. Checks are performed to test the following:

- Fixed and reserved fields have not been modified. Fixed fields are indicated by a number in round brackets following the field name.
- A field has been set to an invalid value.
- The syntax of the page of parameters has been violated—for example, where a particular value in one field imposes limitations on the valid range for another field.

If a field has been set to an illegal value, CHECK CONDITION is reported to the host with a sense key of ILLEGAL REQUEST and additional sense of 2600h (invalid field in parameter list).

The drive scans the data in the Command Description Block from “left” (bit 7) to “right”, and “down” (from byte 0 to byte *n*). It sets the field pointers to the first bit of the first bad field encountered. If the bad field is contained in a contiguous group of fixed fields, the pointers indicate the first bit of the first field in the group, even though the error may be in a later field in the group.

---

NOTE: With MODE SELECT, the drive checks the integrity of the whole parameter list before acting on any parameters, so all the mode parameters need to be correct before any of them are implemented.

---

## Reservation check

This checks to see if the drive has been reserved for use by a host, and if it has, whether the host is the same host that sent the command being executed.

If the drive has been reserved for some other host then RESERVATION CONFLICT status is reported.

See the RESERVE UNIT (page 164) and RELEASE UNIT (page 135) commands.

## Unit Attention check

This checks if a UNIT ATTENTION condition exists for the host which sent the command. If it does, the drive reports CHECK CONDITION status with a sense key of UNIT ATTENTION. The remaining sense data will be set according to the unit attention condition which exists. See Unit Attention Sense in the description of the REQUEST SENSE command on page 155.

# Command descriptor block

A SCSI command descriptor block (CDB) is a sequence of 6, 10, 12 or 16 bytes sent by a host to a SCSI target with the bus in command phase. The CDB tells the drive what action should be performed. The final byte is known as the Control byte.

	7	6	5	4	3	2	1	0
0	Group Code			Operation Code				
1	Reserved (0)							
2	(MSB)	Multi-Byte Parameter						(LSB)
$n-1$								
$n$	Vendor Unique (0)	Reserved (0)			NACA(0)	Flag (0)	Link (0)	

There are a number of fields in a CDB which are common to *all* commands. These are shown in the following table.

Group Code <i>and</i> Operation Code	The operation code uniquely identifies the command. The top three bits of the operation code are known as the <i>group code</i> and these define the length of the command descriptor block:																
	<table border="0"> <tr> <td><i>Group 0</i></td> <td>Six-byte commands</td> </tr> <tr> <td><i>Group 1</i></td> <td>Ten-byte commands</td> </tr> <tr> <td><i>Group 2</i></td> <td>Ten-byte commands</td> </tr> <tr> <td><i>Group 3</i></td> <td>Six-byte commands</td> </tr> <tr> <td><i>Group 4</i></td> <td>Sixteen-byte commands</td> </tr> <tr> <td><i>Group 5</i></td> <td>Twelve-byte commands</td> </tr> <tr> <td><i>Group 6</i></td> <td>not supported</td> </tr> <tr> <td><i>Group 7</i></td> <td>not supported</td> </tr> </table>	<i>Group 0</i>	Six-byte commands	<i>Group 1</i>	Ten-byte commands	<i>Group 2</i>	Ten-byte commands	<i>Group 3</i>	Six-byte commands	<i>Group 4</i>	Sixteen-byte commands	<i>Group 5</i>	Twelve-byte commands	<i>Group 6</i>	not supported	<i>Group 7</i>	not supported
<i>Group 0</i>	Six-byte commands																
<i>Group 1</i>	Ten-byte commands																
<i>Group 2</i>	Ten-byte commands																
<i>Group 3</i>	Six-byte commands																
<i>Group 4</i>	Sixteen-byte commands																
<i>Group 5</i>	Twelve-byte commands																
<i>Group 6</i>	not supported																
<i>Group 7</i>	not supported																
Reserved	A reserved field should always be set to zero. The drive checks reserved fields, and if one is non-zero then it will reject the command with CHECK CONDITION.																
Multi-Byte Parameter	A multi-byte parameter field in a command is "big-endian", that is, bit 7 of the first byte of this field is the most significant.																
Control	The control field is mainly concerned with the use of linked commands. These are not supported by the LTO SCSI Command Set, so a CHECK CONDITION will be generated if this field is set to anything other than zero.																
Vendor-Unique	This field is ignored by the firmware																
NACA	0 The Normal ACA flag is 0, indicating that it is not supported.																
Flag	0																
Link	0 Linked commands are not supported.																



---

# 4 Commands

This chapter describes all SCSI commands. Parts of the chapter are based on sections of the SCSI specification (see page 11).

For general notes on the command descriptions, see Chapter 3.

# ERASE

19h

The ERASE command is used to erase data on tape from the current logical position. The Long bit is used to decide whether the 'old' data is physically overwritten or not. ERASE commands (short or long) to a drive containing a WORM cartridge will not overwrite or erase user data on tape.

Pre-execution checks:

Illegal Field	Reservation	Deferred Error	Unit Attention
Media Access	Media Write	Diagnostic Status	

Command descriptor block:

	7	6	5	4	3	2	1	0
0	Operation Code (19h)							
1	Reserved (0)						Immed	Long
2-4	Reserved (0)							
5	Control							

CDB fields:

---

Immed	0	The drive reports status after the command has completed.
	1	The drive reports status when it starts the command (after any pre-execution checks and prerequisite unloads have completed).

---

Long	The Long bit controls the distance to be erased.	
	0	The current position becomes the end of logical data.
	1	End of Data is written, followed by Data Set Separators to the end of the tape.

---

NOTE: Short erase is only used to truncate data at the current logical position. It cannot be used to create a "hole" in the tape into which data can subsequently be written "in place". This will merely cause the drive to streamfail. The logical tape position is unaffected by this command. A CHECK CONDITION for Early Warning EOM (drive error code 2C98h) will only be given if the tape is logically positioned past EOT immediately before the erase.

Erase Specific status:

Event	Status	Key	Additional Sense
The erase fails	CHECK CONDITION	HARDWARE ERROR	5100h (erase failure)
<i>WORM media</i> : Erase would result in user data being overwritten.	CHECK CONDITION	DATA PROTECT	300Ch (WORM medium—overwrite attempted)

INQUIRY tells the drive to return information about the basic operating parameters to the host. These parameters cannot be changed. The drive returns Inquiry data to the host in a data-in phase.

**NOTE:** This command is immune from most of the pre-execution checks that other commands must pass (for example, it can be executed while the unit is reserved for another host). Unit attention and deferred error conditions are preserved and reported on subsequent commands.

**Pre-execution checks:**

Only the Illegal Field Check is performed before the command is executed.

If the EVPD bit is clear, the page code must be zero, otherwise illegal request is reported.

If the EVPD bit is set, the page code must be one of the supported page codes for Inquiry data. Otherwise illegal request is reported.

**Command descriptor block:**

	7	6	5	4	3	2	1	0
0	Operation Code (12h)							
1	LUN			Reserved (0)			EVPD	
2	Page Code							
3	Allocation Length							
4	Control							
5								

**CDB fields:**

LUN	This field is ignored.
EVPD	<i>Enable Vital Product Data</i>
0	Normal inquiry data is returned.
1	A page of vital product data is returned.

Page Code	If the EVPD bit is zero the Page Code field must be zero. If the EVPD bit is set to 1, the drive returns the Inquiry page in this Page Code field:  00h Supported Vital Product Pages page 80h Unit Serial Number page 83h Device Identification page 86h Extended Inquiry Data page C0h Firmware Revision Levels page C1h Hardware Revision Levels page C2h PCA Revision Levels page C3h Mechanism Revision Levels page C4h Head Assembly Revision Levels page C5h ACI page C6h ARM Firmware Revision Levels page
Allocation Length	The maximum amount of data (in bytes) that should be returned. If more than this is available, the amount returned is truncated to allocation length. No error is reported.

## INQUIRY data pages

Returned data:

INQUIRY returns its standard data if the EVPD bit is zero, or returns a page of data as specified by the Page Code field when EVPD is one.

Standard Inquiry Data format (LUN0)

This is the data returned by the drive in response to an Inquiry command with its EVPD bit set to zero. The data also depends on the value of the LUN field in the Inquiry CDB, the LUN value in the identify message and the configuration of the drive.

Note that the data below is for the *standard distribution firmware*.

	7	6	5	4	3	2	1	0
0	Peripheral Qualifier (000b)			Peripheral Device Type (01h)				
1	RMB (1)	Reserved (0)						
2	Version Number (5)							
3	Obsolete	Obsolete	NACA(0)	HiSup(0)	Response Data Format (2)			
4	Additional Length (5Bh)							
5	SCCS (0)	ACC (0)	TPGS (01b)		3PC (0)	Reserved (0)		Protect(0)
6	BQue(0)	EncSvr(0)	VS(0)	MultiP(0)	MChngr(0)	Obsolete		Adr16
7	Obsolete		WBus16	Sync	Linked(0)	Obsolete	CmdQue(1)	VS(0)
8	(MSB)			Vendor Identification				
15				("HP")				(LSB)
16	(MSB)			Product Identification				
31								(LSB)



	7	6	5	4	3	2	1	0
32	(MSB)	Product Revision Level						(LSB)
35								
36		Reserved (0)						
39								
40		WORM Version						WORM
41		Reserved (0)						
42								
43	(MSB)	OBDR string (“\$DR-10”) or Reserved (0) if not supported						(LSB)
48								
49		Reserved (0)						
55								
56		Reserved (0)			Clocking		QAS (0)	IUS
57		Reserved (0)						
58	(MSB)	Version Descriptor 1						(LSB)
59								
-----								
72	(MSB)	Version Descriptor 8						(LSB)
73								
74	(MSB)	Reserved (0)						(LSB)
95								

The Standard Inquiry Data is based on the SCSI 3 standard for Standard Inquiry Data.

For the LUN to which the drive is attached, the Peripheral Qualifier field is set to 000b, the Peripheral Device Type field is set to 01h, the Removable Medium (RMB) flag is set to 1 and the Device-type modifier is set to 0.

### Inquiry Data fields

Peripheral Qualifier	000b	There is a device on the logical unit selected, so the LUN field in the identify message was 0.
	011b	The LUN field in the identify message has specified an unsupported logical unit. This means any LUN other than 0.
Peripheral Device Type	01h	Sequential Access Device
	05h	CD Device (reported when in OBDR mode)
	1Fh	No Device (the Peripheral Qualifier will be 011b in this case)
RMB	1	The Removable Medium bit is one, indicating that the tape can be removed.
Device-Type Modifier	0	This is a six-bit user defined code, set to zero.
Version Number	5	The drive complies with the SPC-3 standard.

NACA	0	The Normal ACA flag is 0, indicating that it is not supported.
HiSup	0	The Hierarchical Support flag is 0, indicating that the hierarchical addressing model is not supported.
Response Data Format	2	The Inquiry Data format complies with the SCSI-3 standard.
Additional Length	The length in bytes of the length of the rest of the Inquiry data.	
SCCS	0	No storage array controller component is embedded in the drive.
ACC	0	No Access Controls Coordinator may be addressed through this LUN.
TPGS	01b	<i>Target Port Group Support</i> . Only implicit asymmetric logical unit access is supported.
3PC	0	Third-Party Copy commands are not supported.
Protect	0	Protection information is not supported.
BQue	Basic Queuing flag	
	0	The flag is zero for SCSI drives, with CmdQue = 1.
	1	The flag is 1 for Fibre Channel drives, with CmdQue = 0.
EncSvr	0	The drive does not support Enclosure Services command.
VS	0	Vendor-Specific field—not currently used
MultiP	1	The drives has multiple ports.
MChngr	0	The drive is not embedded within or attached to a medium transport element.
Adr16	1	16-Bit Addresses are supported. The flag is only valid for parallel SCSI.
WBus16	1	Wide Bus 16 is supported. The flag is only valid for parallel SCSI.
Sync	1	Synchronous data transfer is supported. The flag is only valid for parallel SCSI.
Linked	0	The drive does not support linked commands.
CmdQue	0	For FC drives, with BQue = 1.
	1	For SCSI drives, with BQue = 0.
Vendor Identification	A vendor-specific, 8-byte string of ASCII characters, left justified and padded with space characters "HP".	
Product Identification	<p>A left-justified, vendor-specific, 16-byte string field of ASCII characters with space character padding on the right. The string consists of two parts:</p> <ul style="list-style-type: none"> <li>• First half (bytes 16–23): "Ultrium"</li> <li>• Second half (bytes 24–31): "&lt;generation&gt;-&lt;interface type&gt;"</li> </ul> <p>The following strings have been defined:</p> <p><i>Gen 1 SCSI drive:</i> "Ultrium 1-SCSI"</p> <p><i>All Gen 2 drives:</i> "Ultrium 2-SCSI"</p> <p><i>All Gen 3 drives:</i> "Ultrium 3-SCSI"</p>	

Product Revision Level	<p>A vendor-specific string of four ASCII characters: "C<del>N</del>N<del>V</del>":</p> <ul style="list-style-type: none"> <li>• C is the codename (G for a Gen 3 SCSI drive, L for Gen 3 FC drive)</li> <li>• NN are two digits that indicate the build of the variant.</li> <li>• v is an ASCII character representing the OEM variant of the code. "D" is the standard distribution variant.</li> </ul>																																														
WORM Version	The version of WORM supported.																																														
WORM	1	The drive supports the LTO WORM specification.																																													
OBDR string	"SDR-10" if the drive supports Tape Disaster Recovery.																																														
Clocking	0	For FC drives.																																													
	3	For SCSI drives, indicating that the drive supports both ST and DT transfers.																																													
QAS	0	The drive does not support Quick Arbitration and Selection.																																													
IUS	Information Units																																														
	0	Not supported for all drives other than SCSI.																																													
	1	Supported for SCSI drives.																																													
Version Descriptor	<p>These fields can be used to identify up to eight standards to which the drive conforms. The values supported are listed below.</p> <p>For SCSI drives, it is recommended that the first version descriptor is used for the SCSI architecture standard, followed by the physical standard, if any, followed by the SCSI protocol, followed by the appropriate SPC version, followed by the device type command set, followed by the secondary command set, if any.</p> <p>The following are the SCSI version descriptors:</p> <table border="1"> <thead> <tr> <th></th> <th>Value</th> <th>Standard</th> </tr> </thead> <tbody> <tr> <td>1</td> <td>005Ch</td> <td>SAM2 ANSI INCITS.366.2003</td> </tr> <tr> <td>2</td> <td>0B56h</td> <td>SPI4 ANSI INCITS.362:2002</td> </tr> <tr> <td>3</td> <td>0300h</td> <td>SPC3</td> </tr> <tr> <td>4</td> <td>037Dh</td> <td>SSC2 ANSI INCITS</td> </tr> <tr> <td>5-8</td> <td>0000h</td> <td>not used</td> </tr> </tbody> </table> <p>The following are the FC version descriptors:</p> <table border="1"> <thead> <tr> <th></th> <th>Value</th> <th>Standard</th> </tr> </thead> <tbody> <tr> <td>1</td> <td>0054h</td> <td>SAM-2 T10/1157-D rev 23</td> </tr> <tr> <td>2</td> <td>0917h</td> <td>FCP-2 ANSI NCITS.332:1999</td> </tr> <tr> <td>3</td> <td>0D7Ch</td> <td>FC-AL-2 ANSI NCITS.350:200x</td> </tr> <tr> <td>4</td> <td>0DA0h</td> <td>FC-FS (no version claimed)</td> </tr> <tr> <td>5</td> <td>131Bh</td> <td>FC-Tape T11/1315 revision 1.17</td> </tr> <tr> <td>6</td> <td>1320h</td> <td>FC-FLA (no version claimed)</td> </tr> <tr> <td>7</td> <td>0277h</td> <td>SPC-2 ANSI NCITS.351:2001</td> </tr> <tr> <td>8</td> <td>021Ch</td> <td>SSC ANSI NCITS.335:2000</td> </tr> </tbody> </table>			Value	Standard	1	005Ch	SAM2 ANSI INCITS.366.2003	2	0B56h	SPI4 ANSI INCITS.362:2002	3	0300h	SPC3	4	037Dh	SSC2 ANSI INCITS	5-8	0000h	not used		Value	Standard	1	0054h	SAM-2 T10/1157-D rev 23	2	0917h	FCP-2 ANSI NCITS.332:1999	3	0D7Ch	FC-AL-2 ANSI NCITS.350:200x	4	0DA0h	FC-FS (no version claimed)	5	131Bh	FC-Tape T11/1315 revision 1.17	6	1320h	FC-FLA (no version claimed)	7	0277h	SPC-2 ANSI NCITS.351:2001	8	021Ch	SSC ANSI NCITS.335:2000
	Value	Standard																																													
1	005Ch	SAM2 ANSI INCITS.366.2003																																													
2	0B56h	SPI4 ANSI INCITS.362:2002																																													
3	0300h	SPC3																																													
4	037Dh	SSC2 ANSI INCITS																																													
5-8	0000h	not used																																													
	Value	Standard																																													
1	0054h	SAM-2 T10/1157-D rev 23																																													
2	0917h	FCP-2 ANSI NCITS.332:1999																																													
3	0D7Ch	FC-AL-2 ANSI NCITS.350:200x																																													
4	0DA0h	FC-FS (no version claimed)																																													
5	131Bh	FC-Tape T11/1315 revision 1.17																																													
6	1320h	FC-FLA (no version claimed)																																													
7	0277h	SPC-2 ANSI NCITS.351:2001																																													
8	021Ch	SSC ANSI NCITS.335:2000																																													

Vendor Specific data may be sent after the Product Revision Level.

# Vital Product Data pages

The following tables describe the vital product data pages. These pages are returned by the INQUIRY command when the EVPD bit is set and the appropriate Page Code is set in the Command Descriptor Block. They contain vendor-specific product information.

## Supported Vital Product Data Pages page

This is the data returned by the drive in response to an Inquiry command with its EVPD bit set to one and its Page Code field set to 0.

This page contains a list of all the VPD page-codes supported by the drive.

	7	6	5	4	3	2	1	0
0	Peripheral Qualifier (0)			Peripheral Device Type (1)				
1	Page Code (00h)							
2	Reserved (0)							
3	Page Length (XXh)							
4	Supported Pages Code (00h)							
5	Unit Serial Number page (80h)							
6	Device Identification page(83h)							
7	Extended Inquiry Data page (86h)							
8	Sequential Device Access Capabilities page (B0h)							
9	Firmware Revision Levels page (C0h)							
10	Hardware Revision Levels page (C1h)							
11	PCA Revision Levels page (C2h)							
12	Mechanism Revision Levels page (C3h)							
13	Head Assembly Revision Levels page (C4h)							
14	Auto-Changer Interface Revision Levels page (C5h)							
15	ARM Firmware Revision Levels page (C6h)							

## Unit Serial Number page

The Unit Serial Number page contains a single value which is a 10-byte ASCII string. The string, with the Vendor Identification and Product Identification fields in the standard Inquiry data, uniquely identifies the drive.

	7	6	5	4	3	2	1	0
0	Peripheral Qualifier (0)			Peripheral Device Type (1)				
1	Page Code (80h)							
2	Reserved (0)							
3	Page Length (0Ah)							
4	(MSB)							
13	Serial Number (LSB)							

## Device Identification page

The Device Identification page contains information that identifies the tape drive uniquely. For SCSI, a combination of the Vendor ID and Serial Number is returned. For Fibre Channel, the Port and Device Names are returned as well

	7	6	5	4	3	2	1	0
0	Peripheral Qualifier (0)			Peripheral Device Type (1)				
1	Page Code (83h)							
2	Reserved (0)							
3	Page Length ( $n-3$ )							
4	(MSB)							
n	Identification Descriptors (LSB)							

Identification Descriptors are constructed as follows:

	7	6	5	4	3	2	1	0
0	Protocol Identifier				Code Set			
1	PIV	Rsvd (0)	Association		Identifier Type			
2	Reserved (0)							
3	Identifier Length ( $n-3$ )							
4	(MSB)							
n	Identifier (LSB)							

Protocol Identifier	0h Fibre Channel
	1h Parallel SCSI
Code Set	1 The Identification Descriptor is a binary field.
	2 The Identification Descriptor contains only ASCII data.

PIV	1	The Protocol Identifier field is valid. This is set for an Association value of 1.
Association	0	The Identifier field is associated with the addressed logical unit.
	1	The Identifier field is associated with the port that received the request.
	2	The Identifier field is associated with the SCSI target device that contains the addressed logical unit.
	3	Reserved
Identifier Type	1	Vendor ID followed by the product identification field from the standard inquiry data and the serial number field from the Serial Number Inquiry page.
	3	All devices with a Fibre Channel interface support an Identifier type 3. In this case the Identification Descriptor is the Fibre Channel 64-bit Name Identifier.

## Defined identifiers

The following identifiers will be returned in the given order. What Port Name is returned depends on which port the Inquiry is sent to.

### Logical Unit Identifier

	7	6	5	4	3	2	1	0
0	Protocol Identifier (0)				Code Set (1)			
1	PIV (0)	Rsvd (0)	Association (0)		Identifier Type (3)			
2	Reserved (0)							
3	Identifier Length (8)							
4	(MSB)	SSC Device Logical Unit Name (IEEE Registered Name)						(LSB)
11								

### Port Name (FC only)

	7	6	5	4	3	2	1	0
0	Protocol Identifier (0)				Code Set (1)			
1	PIV (1)	Rsvd (0)	Association (1)		Identifier Type (3)			
2	Reserved (0)							
3	Identifier Length (8)							
4	(MSB)	Port Name (IEEE Registered Name)						(LSB)
11								

### Port Identifier (FC only)

	7	6	5	4	3	2	1	0
0	Protocol Identifier (0)				Code Set (1)			
1	PIV (1)	Rsvd (0)	Association (1)		Identifier Type (4)			
2	Reserved (0)							
3	Identifier Length (4)							
4	(MSB)							
7	Port Identifier							
	(LSB)							

The Port Identifier will be set to 1 if the addressed port is port A, and set to 2 if the addressed port is Port B.

### Target Name

	7	6	5	4	3	2	1	0
0	Protocol Identifier				Code Set (1)			
1	PIV (1)	Rsvd (0)	Association (2)		Identifier Type (3)			
2	Reserved (0)							
3	Identifier Length (8)							
4	(MSB)							
11	Device Name (IEEE Registered Name)							
	(LSB)							

### Target Name

	7	6	5	4	3	2	1	0
0	Protocol Identifier				Code Set (2)			
1	PIV (1)	Rsvd (0)	Association (2)		Identifier Type (1)			
2	Reserved (0)							
3	Identifier Length (34)							
4	(MSB)							
11	Vendor ID							
	(LSB)							
12	(MSB)							
27	Product Identification							
	(LSB)							
28	(MSB)							
37	Serial Number							
	(LSB)							

## Extended INQUIRY Data VPD page

This page provides an application client with a means of obtaining information about the drive.

	7	6	5	4	3	2	1	0
0	Peripheral Qualifier (0)			Peripheral Device Type (1)				
1	Page Code (86h)							
2	Reserved (0)							
3	Page Length (3Ch)							
4	Reserved (0)			RTO (0)	GRD_CHK(0)	APP_CHK(0)	REF_CHK(0)	
5	Reserved (0)				HEADSUP(0)	ORDSUP(0)	SIMSUP(1)	
6						NV_SUP(0)	V_SUP (0)	
7	Reserved (0)							
63	Reserved (0)							

---

SIMSUP      1      The drive supports the Simple Task attribute.

---

## Sequential Access Device Capabilities page

This page provides the application client with a means of determining which features are supported by the Device Server.

	7	6	5	4	3	2	1	0
0	Peripheral Qualifier (0)			Peripheral Device Type (1)				
1	Page Code (B0h)							
2	Reserved (0)							
3	Page Length (4h)							
	Reserved (0)						WORM	
	Reserved (0)							

---

WORM      1      The Device Server supports Write Once Read Many (WORM) operation.

---



## Drive Component Revision Levels pages

	7	6	5	4	3	2	1	0
0	Peripheral Qualifier (0)			Peripheral Device Type (1)				
1	Page Code							
2	Reserved (0)							
3	Page Length (5Ch)							
4	(MSB)	Component ("cccccccccccc")						(LSB)
29								
30	(MSB)	Version ("RRR.VVV")						(LSB)
48								
49	(MSB)	Date ("YYYY/MM/DD hh:mm")						(LSB)
72								
73	(MSB)	Variant ("xxxxxxxxxxxxx")						(LSB)
95								

The Drive Component Revision Levels pages contain details of the revisions of each of the major sub assemblies of the drive. For any given product, if these pages are the same then the drive has been built with the same components and with the same manufacturing process.

Each entry is a null-terminated ASCII string.

Page Code	Page Code	Component Name
	C0h - Firmware	"Firmware"
	C1h - Hardware	"Hardware"
	C2h - PCA	"PCA"
	C3h - Mechanism	"Mechanism"
	C4h - Head Assembly	"Head Assy"
	C5h - ACI	"ACI"
	C6h - ARM	"IO Firmware"
Component	A 12-character entry to identify the component that the revision is for.	
Version	A 7-character version code with a three-digit major revision number, a period and a three-digit minor version number.	
Date	The date of the version.	
Variant	An identifier indicating what version of the product this is.	

# LOAD/UNLOAD

1Bh

The LOAD/UNLOAD command allows the host to specify that a tape cartridge present in the drive is either made ready for data transfer ("loaded") or disabled for data transfer (if Prevent Media Removal is set). It can also cause the cartridge to be ejected from the drive ("unloaded").

Pre-execution checks:

Illegal Field	Reservation	Deferred Error
Unit Attention	Diagnostic Status	Media Information

If an *unload* is to be performed, the drive checks if the tape is currently being loaded. If it is, CHECK CONDITION is reported with a sense key of NOT READY and additional sense of 0401h (becoming ready).

If a *load* is to be performed, the drive checks to ensure that a tape cartridge is present. If not, it reports CHECK CONDITION with a sense key of NOT READY and additional sense of 3A00h (medium not present). If the media is currently being unloaded or ejected, it reports CHECK CONDITION with sense key of NOT READY and additional sense of 0400h (cause not reportable).

Command descriptor block:

	7	6	5	4	3	2	1	0
0	Operation Code (1Bh)							
1	Reserved (0)							Immed
2	Reserved (0)							
3	Reserved (0)							
4	Reserved (0)				Hold	EOT (0)	ReTen	Load
5	Control							

CDB fields:

---

Immed	0	The drive reports status after the command has completed.
	1	The drive reports status when it starts the command (after any pre-execution checks and prerequisite unloads have completed).

---

Hold	0	A normal load/unload will be performed.
	1	A load will cause the cartridge to be pulled in and seated in the drive, but the tape will not be threaded. An unload will cause the tape to be unthreaded, but the cartridge will not be ejected. In Hold position, the Cartridge Memory is accessible.

---

ReTen	This field is ignored.	
-------	------------------------	--

---

Load	0	The drive performs an <i>unload</i> operation.
	1	The drive performs a <i>load</i> operation.

---

## Load/Unload specific status:

Following a successful LOAD command, CHECK CONDITION is posted to all initiators other than the initiator of the LOAD command. The sense key is set to UNIT ATTENTION, with additional sense of 2800h (not ready to ready transition). There is an exception to this: if a load occurs when the tape is already loaded, no UNIT ATTENTION sense is generated.

Once UNIT ATTENTION is cleared, unsolicited positional sense is set. The sense key will be NO SENSE with additional sense of 0004h (BOT detected).

If an unformatted tape is inserted, the drive loads it and it behaves as if it is a blank tape.

If a cartridge with no Cartridge Memory or a failed Cartridge Memory is loaded, CHECK CONDITION is returned with a sense key of MEDIUM ERROR, with additional sense of 5200h (cartridge fault).

## Loading a cartridge

The drive loads a tape automatically when it is inserted, without any host interaction. If the load is successful, media access commands are permissible (see the Media Access check).

If the tape is already loaded when a Load request is received, the tape is positioned at the beginning of the tape (as though a REWIND had been sent). Unlike a "full" load, UNIT ATTENTION with additional sense of 2800h (not ready to ready transition) is not generated for other hosts.

If the tape is in the process of being loaded when the Load request is received, the drive will wait for the load to complete and, assuming the load was successful, take one of the following actions:

- If the Load was issued by the current host (that is, a previous immediate-reported load) and completed successfully, GOOD status is reported. No further action is taken.
- If the Load was issued by some other host (or was an autoload) and completed successfully, CHECK CONDITION is reported, with a sense key of UNIT ATTENTION and additional sense of 2800h (not ready to ready transition).
- If the Load was issued by the current host and failed, CHECK CONDITION is reported, since a deferred error condition will exist for the current host.
- If the Load was issued by some other host and failed, the load will be re-attempted on behalf of the current host.

## Unloading a cartridge

If an unload is requested and there is a tape present in the drive (either loaded, loading or unloading):

1. Any buffered data is written to tape.
2. The tape is rewound to the physical BOM (beginning of media).
3. If medium removal is prevented, CHECK CONDITION is reported with a sense key of ILLEGAL REQUEST and additional sense of 5302h (medium removal prevented).

4. GOOD status is reported if the tape unloaded successfully. Otherwise, another unload operation is initiated on behalf of the host that issued the unload request.

Following an unload, any media access commands will be rejected by the Media Access check.

- If an unload request is received while the tape is in the process of unloading (for example, as a result of pressing the eject button), it will be queued until the unload is complete.
- If an unload request is received while there is no tape present, or if a tape is present but not loaded and medium removal is prevented, GOOD status is reported.

It is possible to unload and eject the cartridge by pressing the Eject button on the front panel.

# LOCATE

2Bh

The LOCATE command moves the current logical position to the position specified by the command. The new position is specified by the offset from start of the media in terms of blocks. The first block (that is, BOT) is block address 0.

Any unwritten data is written to tape before the command is executed.

Pre-execution checks:

Illegal Field	Reservation	Deferred Error
Unit Attention	Media Access	Diagnostic Status

Command descriptor block (10-byte version):

	7	6	5	4	3	2	1	0
0	Operation Code (2Bh)							
1	Reserved (0)					BT (0)	CP (0)	Immed
2	Reserved (0)							
3	(MSB)	Block Address						(LSB)
6	Reserved (0)							
7	Partition (0)							
8	Control							

(16-byte version):

	7	6	5	4	3	2	1	0
0	Operation Code (92h)							
1	Reserved (0)			Dest Type	Rsvd (0)	CP (0)	Immed	
2	Reserved (0)						BAM (0)	
3	Partition (0)							
4	(MSB)	Logical Identifier						(LSB)
11	Reserved (0)							
12	Control							

CDB fields:

---

BT	<i>Block address Type.</i> This field is not supported and should always be set to zero indicating that the Block Address field represents the count of all blocks and filemarks between the beginning of the media and the current logical position.
----	---

---

CP	<i>Change Partition</i> . This field is not supported and should be set to zero.
Immed	0 The drive only reports status after the Locate command has completed.
	1 The drive reports status when it starts the command and continues with the positioning in the background.
BAM	0 This field is not supported.
Block Address	The Block Address specifies the number of blocks and filemarks between BOM and the position to be located.
Partition	Not supported.
Dest type	00b Specifies that the Logical Identifier field is a logical object identifier.
	01b Specifies that the Logical Identifier field is a logical file identifier.
	Other values are not supported.
Logical Identifier	The specific block on tape to locate. It can be a generic block, either a record or a filemark (Dest Type = 00b) or a specific filemark on tape (Dest Type = 01b).

#### Locate specific status:

Event	Status	Key	Additional Sense
EOD encountered	CHECK CONDN	BLANK CHECK	0005h (EOD encountered).
EOM encountered	CHECK CONDN	MEDIUM ERROR	0002h (EOT encountered). EOM bit set.
Failed to read data— media error or non-fatal drive error	CHECK CONDN	HARDWARE ERROR	3B00h (sequential positioning error)
Early Warning EOM encountered	Early warning end of medium information is not reported for Locate commands		
Data format corrupt	CHECK CONDN	MEDIUM ERROR	3001h (can't read media, unknown format)

The Log Select command causes log data on the drive to be reset to its default value or to be set to an initiator specific value.

Pre-execution checks:

Illegal Field          Reservation          Deferred Error          Unit Attention

Command descriptor block:

	7	6	5	4	3	2	1	0	
0	Operation Code (4Ch)								
1	Reserved (0)						PCR	SP (0)	
2	PC		Reserved (0)						
3	Reserved (0)								
6	Reserved (0)								
7	(MSB)		Parameter List Length				(LSB)		
8									
9	Control								

CDB fields:

The following are valid combinations of values for the PCR (Parameter Code Reset), Parameter List Length and PC (Page Control) fields:

PCR	Parameter List Length	PC	Result
1	0	01b or 11b	All the logs on the drive that can be reset are reset to their default values.
1	0	00b or 10b	No action is taken and GOOD status is returned.
0	>0	01b or 11b	Data is sent from the host and is written to the indicated logs, provided those logs are writable.

Otherwise CHECK CONDITION status is returned, the sense key is set to ILLEGAL REQUEST with additional sense of 2400h (Invalid Field in CDB).

PCR	0	Parameter Code Reset. The function performed is defined by the PC field.
SP	0	The Save Page (SP) flag is not supported and must be set to 0.

---

PC	The <i>Page Control</i> field defines the type of parameter values to be selected:
	00b No operation is performed. The Parameter List Length must be zero. If it is not, check <i>or</i> condition invalid field in CDB is set.
	10b
	01b The drive will clear logs as specified by the parameter data.
	11b The drive will clear all of its internal logs.

---

Parameter List Length	0 No data is to be transferred. This is not considered an error.
	>0 Specifies how many bytes of parameter data are to be sent. The data transferred will consist of zero or more 4-byte log page headers with the page length in those headers set to <i>zero</i> . For each log page header received, the drive clears the associated log.

---



LOG SENSE allows the host to read the drive's logs. A single log is returned with each invocation of LOG SENSE.

Pre-execution checks:

Illegal Field                  Deferred Error                  Unit Attention

The Page Code must match one of the supported log page codes. If it does not, then CHECK CONDITION status is reported. Sense data will be as described in the Illegal Field Checks.

Command descriptor block:

	7	6	5	4	3	2	1	0
0	Operation Code (4Dh)							
1	Reserved (0)						PPC (0)	SP (0)
2	PC		Page Code					
3	Reserved (0)							
4	Parameter Pointer							
5	Allocation Length							
6								
7	(MSB)						(LSB)	
8								
9	Control							

CDB fields:

PC	<p>The <i>Page Control</i> field defines the type of log parameter to be returned:</p> <ul style="list-style-type: none"> <li>00b Current Threshold Values—any parameters in the log that are counters contain the maximum value that they can count to.</li> <li>01b Current Cumulative Values—any parameters in the log that are counters contain their current counts. NOTE: Counts are reset to their default cumulative values (see below) following a power-on, reset or bus device reset. Media related counts are also reset following a load.</li> <li>10b Default Threshold Values—same as the Current Threshold Values</li> <li>11b Default Cumulative Values—any parameters in the log that are counters contain the initial values of those counters (set at power-on, reset, bus device reset and, in the case of media logs, load).</li> </ul> <p>The PC field has no effect on the data returned when the selected log contains event or trace codes rather than counts.</p>
Page Code	<p>The <i>Page Code</i> field identifies which log page is being requested by the host. See page 59 for the list of valid page codes.</p>

Parameter Pointer	0	All parameters are returned.
	$n$	Parameter data of a specified log page is returned in ascending order beginning from this code. If this code is larger than the largest parameter in the page, the drive will return CHECK CONDITION with additional sense of 2400h (Invalid Field In CDB).
Allocation Length		The Allocation Length field specifies the maximum number of bytes of data that should be returned to the host. The drive will return the entire log or Allocation Length bytes, whichever is the lesser.

## Log page format

All log pages except Page 0 consist of a page code header followed by a number of parameters. The page header has the following format:

	7	6	5	4	3	2	1	0	
0	Page Code								
1	Reserved (0)								
2	(MSB)	Page Length							
3								(LSB)	

The Page Code specifies which Log page is being returned. The Page Length indicates the number of additional bytes in the parameters.

For the Log Select command only, the four bytes shown above are sent for each log page to be cleared. The Page Length field should be set to zero.

For the Log Sense command one or more parameters is sent. See the actual page descriptions above for more information. Note that all the parameters for a particular page must be sent. Each parameter has the following format:

	7	6	5	4	3	2	1	0	
0	(MSB)	Parameter Code							
1								(LSB)	
2	DU (0)	DS (1)	TSD (0)	ETC (0)	TMC(0)	Rsvd (0)	LP (0)		
3	Parameter Length ( $n-3$ )								
4	(MSB)	Parameter Bytes							
$n$								(LSB)	

Parameter Code		A two-byte value that uniquely identifies the parameter within the log.
DU, TSD, ETC, TMC and LP	0	Must be zero. For a full description of these fields refer to the SCSI-2 standard.
DS	1	Must be 1, indicating that drive will maintain the saving of data itself. Note that the host must set the SP bit to 1 in a LOG SELECT command, otherwise a CHECK CONDITION will result.

---

Parameter Length	The length of Parameter Bytes in bytes.
------------------	---

---

Parameter Bytes	The actual parameter data.
-----------------	----------------------------

---

## Supported Log Pages page

This SCSI log may be recovered using a Log Sense command with the PC field set to anything and the Page Code field set to 00h. The page lists the page codes of other logs supported by the drive. It can neither be reset nor written.

The page has the following format:

	7	6	5	4	3	2	1	0
0	Reserved (0)		Page Code (00h)					
1	Reserved (0)							
2	(MSB)		Page Length (0Dh)				(LSB)	
3								
4	Supported Pages (00h)							
5	Write Error Counters (02h)							
6	Read Error Counters (03h)							
7	Sequential Access Device Log (0Ch)							
8	Temperature (0Dh)							
9	DTD Status (11h)							
10	Protocol Specific (18h)							
11	TapeAlert Log (2Eh)							
12	Tape Usage Log (30h)							
13	Tape Capacity Log (31h)							
14	Data Compression Log (32h)							
15	Performance Log (34h)							
16	Device Status Log (3Eh)							

---

## Write Error Counters log page

The Write Error Counters log is page 02h. The Page Length is 38h. There are seven parameters, 0 through 6. All fields are four bytes long.

All these counters are updated when the data set is physically written. They relate to the current tape and are cleared when the tape is unloaded.

Parm.	Definition	Description
0	Errors corrected without substantial delay	Total number of errors corrected without delay
1	Errors corrected with possible delays	Total number of errors corrected using retries
2	Total	Sum of parameters 3 and 6
3	Total errors corrected	The number of data sets that needed to be rewritten
4	Total times error correction processed	Number of CCQ sets rewritten
5	Total data sets processed	The total number of data sets written
6	Total uncorrected errors	The number of data sets that could not be written

This data can be reset to zero, but not written.

## Read Error Counters log page

The Read Error Counters log is page 03h. The Page Length is 38h. There are seven parameters, 0 through 6. All fields are four bytes long.

All these counters are updated when the data set is physically read. They relate to the current tape and are cleared when the tape is unloaded.

Parm.	Definition	Description
0	Errors corrected without substantial delay	Total number of errors corrected without delay
1	Errors corrected with possible delays	Total number of errors corrected using retries
2	Total	Sum of parameters 3 and 6
3	Total errors corrected	The number of data sets that were corrected after a read retry
4	Total times error correction processed	Number of times C2 correction is invoked
5	Total bytes processed	The total number of data sets read
6	Total uncorrected errors	The number of data sets that could not be read after retries

This data can be reset to zero, but not written.

## Sequential Access Device log page

The Sequential Access Device Log page is page 0Ch. The Page Length is 40h. Five parameters are supported, all eight bytes long. With the exception of 0100h (cleaning required), they are updated when a data set is logically written and cleared at the start of tape load; the values of each parameter relate to the current tape.

Parm.	Description
0001h	The number of data bytes received from application clients during write command operations. This is the number of bytes transferred over SCSI, before compression.
0002h	The number of data bytes written to the media as a result of write command operations, not counting the overhead from ECC and formatting. This is the number of data bytes transferred to media, after compression.
0003h	The number of data bytes read from the media during read command operations, not counting the overhead from ECC and formatting. This is the number of data bytes transferred from media with compression.
0004h	The number of data bytes transferred to the initiator or initiators during read command operations. This is the number of bytes transferred over SCSI, after decompression.
0100h	Cleaning required, a non-volatile cleaning indication.

A non-zero value of parameter 0100H (cleaning required) relates to the drive. It indicates that a condition requiring cleaning has been detected and a subsequent cleaning cycle has not yet been completed. The parameter is updated asynchronously. It persists across hard resets and power cycles, and is cleared when a cleaning cycle is performed.

# Temperature log page

The Temperature Log page is page 0Dh. The following parameters are supported:

Parm.	Description
0h	The current temperature of the drive in °C (binary value). If the temperature is less than 0, 0 is reported. If the temperature sensor is not functioning properly, FFh is reported.
1h	The maximum temperature in °C (binary value) at which the drive can operate continuously without degrading reliability and operation. This parameter is not supported so FFh is returned.

	7	6	5	4	3	2	1	0
0	Page Code (0Dh)							
1	Reserved (0)							
2	(MSB)		Page Length (0Ch)				(LSB)	
3								
4	(MSB)		Parameter Code (0000h)				(LSB)	
5								
6	DU (0)	DS (1)	TSD (0)	ETC (0)	TMC (0)	LBIN (1)	LP (1)	
7	Parameter Length (2h)							
8	Reserved (0)							
9	Temperature (°C)							
10	(MSB)		Parameter Code (0001h)				(LSB)	
11								
12	DU (0)	DS (1)	TSD (0)	ETC (0)	TMC (0)	LBIN (1)	LP (1)	
13	Parameter Length (2h)							
14	Reserved (0)							
15	Reference Temperature (°C)							

# DTD Status log page

The Data Transfer Device (DTD) Status Log page is page 11h. The following parameters are supported:

Parm.	Description
0000h	Very High Frequency data
0001h	Very High Frequency polling delay
0100h-01FFh	DTD Primary Port status

## Very High Frequency Data (VHF)

	7	6	5	4	3	2	1	0
0	(MSB) _____ Parameter Code (0000h) _____ (LSB)							
1								
2	DU (0)	DS (1)	TSD (0)	ETC (0)	TMC (0)		LBIN (1)	LP (1)
3	Parameter Length (4h)							
4	Rsvd (0)	HIU	MAcc	Cmpr	WrtP	CRqst	CRqrd	DInit
5	InXtm	Rsvd (0)	RAA	MPrsnt	Rsvd (0)	MStd	MThrd	DAcc
6	Tape Motion Status							
7	Reserved (0)					RRqst	IntfC	TAFc

HIU	Host Initiated Unload bit	
MAcc	If set, the MAM is accessible. MPrsnt must be set as well.	
Cmpr	Compress bit. If set, the DTD currently has data compression enabled.	
WrtP	Write Protect bit. If set, the media in the DTD is physically write-protected. Only valid if MPrsnt is set.	
CRqst	Clean Requested bit	
CRqrd	Cleaning Required. If set, head cleaning must be performed before normal data operations are possible. This takes priority over CRqst, and both may be set at the same time.	
DInit	DTD Initialized. When set, the data returned by the VHF parameter data is valid.	
InXtm	In Transition. If 0, the DTD is in the state reflected by the rest of byte 5 and is not attempting to leave this state. This bit must be 0 if RRqst is set.	
RAA	Robotic Access Allowed. If set, robotic media access to the DTD is allowed.	
MPrsnt	Media Present bit (hardware sensor)	
MStd	Media Seated. If set, the tape is mechanically seated, that it physical loading is complete. Otherwise the tape is still threading.	
MThrd	Media Threaded	
DAcc	Data Accessible. If set, the DTD has finished processing a load operation. The bit is cleared to 0 at the beginning of the next unload operation.	
Tape Motion Status	00h	No tape motion
	01h	Cleaning operation in progress
	02h	Tape being loaded
	03h	Tape being unloaded
	04h	Tape in motion
	05h	Reading
	06h	Writing
	07h	Locating
	08h	Rewinding
	09h–7Fh	Reserved
	80h–FFh	Vendor unique

RRqst	Recovery Requested. Set to 1 as long as a recovery procedure is available. In these circumstances, InXtn must be 0.
IntfC	Interface Changed. If set, the interface status has changed since the last time this page was retrieved. It is cleared to 0 when the page is retrieved for the initiator.
TAFc	If set, at least one TapeAlert Flag had Changed since the last time the TapeAlert flags were retrieved.

## Very High Frequency Polling Delay

	7	6	5	4	3	2	1	0
0	(MSB) _____ Parameter Code (0001h) _____ (LSB)							
1								
2	DU (0)	DS (1)	TSD (0)	ETC (0)	TMC (0)		LBIN (1)	LP (1)
3	Parameter Length (2h)							
4	(MSB) _____ VHF Polling Delay _____ (LSB)							
5								

The VHF Polling Delay is 16 milliseconds.

## DTD Primary Port Status

### Parallel SCSI

	7	6	5	4	3	2	1	0
0	(MSB) _____ Parameter Code (0101h) _____ (LSB)							
1								
2	DU (0)	DS (1)	TSD (0)	ETC (0)	TMC (0)		LBIN (1)	LP (1)
3	Parameter Length (4h)							
4	Reserved (0)				Current Bus Mode		Rsvd (0)	
5	Reserved (0)							
6	Most Recent Transfer Period Factor							
7	Current SCSI Address							



## Fibre Channel

### Port 0

	7	6	5	4	3	2	1	0	
0	(MSB)							Parameter Code (0101h)	(LSB)
1									
2	DU (0)	DS (1)	TSD (0)	ETC (0)	TMC (0)		LBIN (1)	LP (1)	
3	Parameter Length (8h)								
4	CrrTop	Current Speed			LC	Conflict	Signal	PIC	
5	(MSB)							Current N_Por_ID	(LSB)
7									
8-10	Reserved (0)								
11	Rsvd	Current FC_AL Loop ID							

### Port 1

	7	6	5	4	3	2	1	0	
0	(MSB)							Parameter Code (0102h)	(LSB)
1									
2	DU (0)	DS (1)	TSD (0)	ETC (0)	TMC (0)		LBIN (1)	LP (1)	
3	Parameter Length (8h)								
4	CrrTop	Current Speed			LC	Conflict	Signal	PIC	
5	(MSB)							Current N_Por_ID	(LSB)
7									
8-10	Reserved (0)								
11	Rsvd	Current FC_AL Loop ID							

## TapeAlert log page

The TapeAlert log page is page 2Eh. There are 64 parameters numbered from 1 through 64. Only parameters 1 through 18, 20 through 23, 29 through 39 and 55 have definitions for tape drives without attached loaders. The remaining parameters are always zero.

NOTE: Parameters 24-28, 50-54, 56-58 have recently been added to the list and may or may not be supported.

The Parameter Control Byte value for each parameter is 40h.

All parameters are one byte long. Each parameter is either zero to indicate the corresponding condition has not occurred or one to indicate that the corresponding condition has occurred. All log parameters are cleared when the log is read. The Log is also cleared at power on, on a reset

condition and by a Log Select command. Specific flags may be cleared when corrective action has removed the condition that caused the flag to be set.

The supported parameters are as follows:

Parameter	Description	Type
1	Read Warning	Warning
2	Write Warning	Warning
3	Hard Error	Warning
4	Media	Critical
5	Read Failure	Critical
6	Write Failure	Critical
7	Media Life	Warning
8	Not Data Grade	Warning
9	Write-Protect	Critical
10	No Removal	Information
11	Cleaning Media	Information
12	Unsupported Format	Information
13	Recoverable Snapped Tape	Critical
14	Unrecoverable Snapped Tape	Critical
15	Memory in Cartridge Failure	Warning
16	Forced Eject	Critical
17	Read-Only Format	Warning
18	Tape Directory Corrupted	Warning
19	Nearing Media Life	Information
20	Clean Now	Critical
21	Clean Periodic	Warning
22	Expired Cleaning Media	Critical
23	Invalid Cleaning Cartridge	Critical
24	Retension Requested	Warning
25	Dual-port Interface Error	Warning
26	Cooling Fan Failure	Warning
27	Power Supply Failure	Warning
28	Power Consumption	Warning
29	Drive Maintenance	Warning
30	Hardware A	Critical
31	Hardware B	Critical
32	Interface	Warning
33	Eject Media	Critical
34	Download Fault	Warning
35	Drive Humidity	Warning

Parameter	Description	Type
36	Drive Temperature	Warning
37	Drive Voltage	Warning
38	Predictive Failure	Critical
39	Diagnostics Required	Warning
50	Lost Statistics	Warning
51	Tape Directory Invalid at Unload	Warning
52	Tape System Area Write Failure	Critical
53	Tape System Area Read Failure	Critical
54	No Start of Data	Critical
55	Loading Failure	Critical
56	Unrecoverable load Failure	Critical
57	Automation Interface Failure	Critical
58	Firmware Failure	Warning
59	WORM medium — integrity check failed	Warning
60	WORM medium — overwrite attempted	Warning

## Tape Usage log page

The Tape Usage log page code is 30h. There are nine parameters. These are all read directly from the LTO-CM Tape Usage Log.

This data relates to the current tape and can be neither reset nor written.

Parm.	Description	Length	Updated When
1	Thread Count	4	Tape threaded
2	Total Data Sets Written	8	Data set physically written
3	Total Write Retries	4	Data set physically written
4	Total Unrecovered Write Errors	2	Data set physically written
5	Total Suspended Writes	2	Data set physically written
6	Total Fatal Suspended Writes	2	Data set physically written
7	Total Data Sets Read	8	Data set physically written
8	Total Read Retries	4	Data set physically written
9	Total Unrecovered Read Errors	2	Data set physically written

---

## Tape Capacity log page

The Tape Capacity log page code is 31h. The Page Length is 20h. There are four parameters, 1 through 4. Parameters 2 and 4 are not supported and are returned as zero. All parameters are 4 bytes long. All parameters are in megabytes (1,048,576 bytes) and assume no compression. This data relates to the current tape and can be neither reset nor written.

The supported parameters are as follows:

Parm.	Description	Length	Updated When
1	Main Partition Remaining Capacity	4	Data set physically written
2	Alternate Partition Remaining Capacity	4	n/a
3	Main Partition Maximum Capacity	4	If Set Capacity succeeds
4	Alternate Partition Maximum Capacity	4	n/a

## Data Compression log page

The Data Compression log page code is 32h and the page length is 4Ch. There are ten parameters, 0 through 9. Parameters 0 and 1 are two bytes long. Parameters 2 through 9 are each 4 bytes long.

The supported fields are listed below. Parameters 2 through 9 occur as pairs that represent a large number of bytes transferred. The first four-byte parameter represents the number of whole megabytes transferred, rounded to the nearest megabyte. The second four-byte parameter represents the difference between this number of megabytes and the actual number of bytes. This may be a signed quantity.

This data relates to the current tape and is cleared at the start of tape load. It may not be written.

Parameter	Description	Length	Updated When
0	Read compression ratio X 100	2	Data set logically read
1	Write compression ratio X 100	2	Data set logically written
2	Megabytes transferred to host	4	Data set logically read
3	Bytes transferred to host	4	Data set logically read
4	Megabytes read from tape	4	Data set logically read
5	Bytes read from tape	4	Data set logically read
6	Megabytes transferred from host	4	Data set logically written
7	Bytes transferred from host	4	Data set logically written
8	Megabytes written to tape	4	Data set logically written
9	Bytes written to tape	4	Data set logically written

## Performance Data log page

The Performance Data log page is 34h. This log is intended to report data of interest to a user/application on how efficiently the drive is being used.

Parameter	Description	Length	Updated
0	Repositions per 100 MB	2	After each 100 MB has been physically written
1	Data rate into buffer	2	After each data set has been logically written
2	Maximum data rate	2	After each data set has been logically written
3	Current data rate	2	After each data set has been logically written
4	Native data rate	2	Fixed

The Parameter Control Byte is 60h for all the parameters.

All the parameters relate to the current tape. They are all cleared at the start of tape load, except Parameter 4, which is never cleared. All data will be reset when the log page is reset. The parameters are as follows.

Repositions per 100 MB	Number of tape direction changes per 100 MB written. The higher the figure the more wear occurs.		
Data rate into buffer	Rate at which data is entering the buffer (after data compression), given in units of 100 KB/s. This is the true 'tape' data rate.		
Maximum data rate	Given the compressibility of the data that has been sent to the drive, this is the maximum data rate that could be achieved, given in units of 100 KB/s. The figure is calculated based on the compressibility of each dataset received, and datasets that have a compressibility greater than the compression bandwidth of the drive will be 'capped'.		
Current data rate	Rate at which data is being accepted by the drive <i>before</i> compression, given in units of 100 KB/s.		
Native data rate	The native rate (that is, without using compression) at which the drive writes data to tape, given in units of 100 KB/s:		
	Drive	Value	Native Data Rate
	Generation 1 full-height	96h	15 MB/s
	Generation 1 half-height	48h	7.5 MB/s
	Generation 2	12Ch	30 MB/s
	Generation 3	230h	80 MB/s

NOTE: These figures are for native media types and will vary when earlier format media is loaded

# Device Status log page

The Device Status log page is 3Eh, with a page length of 28h. PCB = Parameter Control Byte.

Parameter	Description	Length	Updated	PCB
0	Device Type	4	Obsolete. Set to all zeros.	40h
1	Device Status Bits	4	Used to provide remote status of selected monitoring points on the drive. See below for the format.	40h
2	Total Number of Loads	4	Number of loads/unloads over the life of the device.	60h
3	Cleaning Cartridge Status	4	Accumulated number of uses of the <i>last</i> cleaning cartridge. Updated after the tape is loaded and a cleaning event attempted. If there is no value, FFFFFFFFh is returned.	40h
4	Product Number	4	Unique number that identifies the product	40h

## Device Status Bits

The parameter has the following format:

	7	6	5	4	3	2	1	0
0	Reserved (0)				CRQ	CR	ECT	
1	Reserved (0)			Temperature		Device Status		
2	Reserved (0)					Medium Status		
5	Reserved (0)							

CRQ            Cleaning Required flag

CR             Cleaning Requested flag

ECT            Exhausted Cleaning Tape flag

Temperature    00b Field not supported  
                   01b Temperature OK  
                   10b Temperature degraded  
                   11b Temperature failed

Device Status    The overall status of the drive:  
                   00b Field not supported  
                   01b Device status OK  
                   10b Device status degraded  
                   11b Device status failed

Medium Status    The overall status of the tape cartridge:  
                   00b Field not supported  
                   01b Medium status OK  
                   10b Medium status degraded  
                   11b Medium status failed

# MODE SELECT

15h/55h

MODE SELECT is used to send configuration data to the drive. Both 6-byte and 10-byte versions of the command are supported.

The Mode Select parameter list is transferred from the host to the drive during the data-out phase. It contains zero or more bytes of information. If any information is sent, it should consist of a Mode Parameter Header followed by zero or more mode select pages. Internal parameters are set according to the values specified in the header and pages. Fields in the parameter list are checked and the operation will terminate if an error is found.

**NOTE:** The drive does not check that the parameter list is correct before modifying internal parameters. The list is checked as the operation proceeds, so if there is an error in the list, all parameters up to that point will be set to their new values, but the parameter in error and later parameters will not be updated.

## Pre-execution checks:

Illegal Field      Reservation      Deferred Error      Unit Attention

**NOTE:** Failure to flush write-behind data will be reported as a Deferred Error.

The parameter list length must be such that only "entire" parts of a parameter list are sent. It is illegal to send a partial mode parameter header, a partial mode block descriptor or a partial mode page. If this happens, then CHECK CONDITION status is reported. The sense key is set to ILLEGAL REQUEST. The additional sense is set to 1A00h (parameter list length error).

Extra checks may be performed on the data, see the descriptions for the parameter list for more details.

## Command descriptor block

### 6-Byte version

	7	6	5	4	3	2	1	0
0	Operation Code (15h)							
1	Reserved (0)			PF	Reserved (0)			SP (0)
2	Reserved (0)							
3	Reserved (0)							
4	Parameter List Length							
5	Control							

## 10-byte version

	7	6	5	4	3	2	1	0
0	Operation Code (55h)							
1	Reserved (0)			PF	Reserved (0)			SP (0)
2	(MSB)	Reserved (0)						(LSB)
6								
7	(MSB)	Parameter List Length						(LSB)
8								
9	Control							

## CDB fields:

PF	<i>Page Format</i>
0	The MODE SELECT parameter data is not SCSI-2 mode page compatible. Only the parameter header and block descriptor may be sent.
1	The parameter data is SCSI-2 mode-page compatible.
SP	<i>Save Pages</i>
0	This bit is not supported and must be zero.
Parameter List Length	0 No data is transferred. >0 The length in bytes of the MODE SELECT parameter list to be transferred.

## Specific status:

Following a successful Mode Select command, Unit Attention status is posted to all initiators other than the initiator of the Mode Select command. The sense key is set to UNIT ATTENTION. Additional sense is set to 2A01h (mode parameters changed).

## Mode parameter pages

Mode data is recovered from the drive by means of a MODE SENSE command. After modification, it is returned to the drive via a MODE SELECT command. In real-life, many hosts do not use MODE SENSE and return whatever MODE SELECT data suits them into the drive.



## Mode page representation

Certain conventions are used in the following Mode Parameter pages in order to describe the nature of the parameters. Most parameters are given by name, followed by a number in brackets. The brackets have the following meanings:

**Square brackets [ ]** Square brackets indicate that the parameter may be modified. The number inside the brackets is the default value for the field—in other words, the power-up or reset value.

- MODE SELECT may modify this value by sending the page with a new value in the field.
- MODE SENSE (current values) will return the current value of the parameter.
- MODE SENSE (default values) will return the value in brackets [ ].
- MODE SENSE (changeable values) will return a value of all ones.

**Round brackets ( )** Round brackets indicate that the parameter is fixed. The number inside the brackets is the fixed value for the field.

- MODE SELECT must set the parameter to this value, otherwise CHECK CONDITION will be reported with a sense key of ILLEGAL REQUEST.
- MODE SENSE (default values) will return the fixed value.
- MODE SENSE (changeable values) will return a value of all zeros.

## Mode data format

Mode data consists of a 4-byte header, optionally followed by block descriptor and Mode Parameter pages:

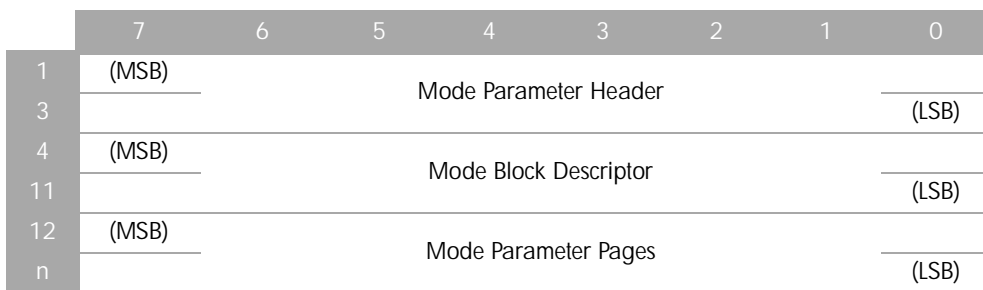

### Mode parameter pages

HP Ultrium drives support the following pages:

- 01h “Read-Write Error Recovery mode page” on page 76
- 02h “Disconnect-Reconnect page” on page 78
- 0Ah “Control mode page” on page 79
- 0Fh “Data Compression log page” on page 68
- 10h “Device Configuration page” on page 81
- 11h “Medium Partitions mode page” on page 83

- 18h (*FC drives only*) 18h (*SCSI drives only*) "SCSI LUN Control mode page" on page 84
- 19h (*FC drives only*) 19h (*SCSI drives only*) "SCSI Port Control Mode page" on page 87
- 1Ch "Information Exceptions mode page" on page 91
- 3Ch "Device Time Mode Page" on page 92
- 3Fh *OBDR FW variants only*: "CD-ROM Emulation/Disaster Recovery mode page" on page 94
- Return all pages (page 3Fh) — for MODE SENSE only

## Mode parameter header

The Mode Parameter header must always be sent at the start of Mode Select data. It is always returned at the start of Mode Sense data.

### 6-byte header

The 6-byte Mode Parameter header has the following format:

	7	6	5	4	3	2	1	0
0	Mode Data Length							
1	Medium Type [00h or 01h if WORM media is loaded or 80h if in CD-ROM mode]							
2	WP	Buffered Mode [001b]			Speed (0)			
3	Block Descriptor Length							

### 10-byte header

The 10-byte Mode Parameter header has the following format:

	7	6	5	4	3	2	1	0
0	(MSB)	Mode Data Length						(LSB)
1								
2	Medium Type [00h or 01h if WORM media is loaded or 80h if in CD-ROM mode]							
3	WP	Buffered Mode [001b]			Speed (0)			
4	Reserved (0)							
5								
6	(MSB)	Block Descriptor Length						(LSB)
7								

## Header fields

Mode Data Length	<i>MODE SELECT</i> : Mode Data Length field must be zero. <i>MODE SENSE</i> : Mode Data Length field is set to the number of bytes of data available to return excluding itself (in other words, the number of actual bytes available is mode data length + 1 for 6-byte MODE SENSE or +2 for 10-byte MODE SENSE). NOTE: The actual amount returned may be truncated to the allocation length for the command.
Medium Type	00h The usual medium type when the drive is in normal tape drive mode. 01h WORM media is loaded 80h The tape drive is in CD-ROM emulation mode for OBDR.
WP	<i>Write Protect</i> . Ignored for MODE SELECT. 0 MODE SENSE: The tape is write-enabled 1 MODE SENSE: The tape is write-protected
Buffered Mode	0 The drive will not report GOOD status on Write and Write Filemarks commands until all data (blocks and filemarks) has been successfully written to tape. 1 The drive will report GOOD status for Write and Write Filemarks commands as soon as all the data or marks specified in the command have been transferred to the data buffer. Data for multiple commands from different initiators may be buffered. This is the default value. NOTE: It is strongly recommended that this field is set to 1, otherwise there will be significant performance penalties. A method of flushing the buffer to tape without changing logical position is available with the Write Filemarks command. 2 The drive will report GOOD status for Write and Write Filemarks commands as soon as all the data or marks specified in the command have been transferred to the data buffer and all buffered data from different initiators has been successfully written to the tape.
Speed	0 The Speed field is not used and should be zero.
Block Descriptor Length	Only the values 0 and 8 are valid. Any value other than 0 or 8, CHECK CONDITION status is reported. See the Parameter List check for details of the sense data generated. 0 No block descriptor is being transferred. 8 The Mode Parameter header must be followed by the 8-byte block descriptor described in the next section.

## Mode block descriptor

The format of the Mode Parameter block descriptor is as follows:

	7	6	5	4	3	2	1	0
0	Density Code							
1	(MSB)	Number of Blocks (0)						(LSB)
3								
4	Reserved (0)							
5	(MSB)	Block Length [0 or 800h]						(LSB)
7								

Mode Parameter block descriptor fields:

Density Code	This specifies the format of the media loaded in the drive. See "REPORT DENSITY SUPPORT 44h" on page 137 for details.
Block Length	This indicates the size of fixed blocks for fixed mode Read and Write commands. It is also used in the decision process on whether to report an illegal length record on reads. <ul style="list-style-type: none"> <li>00h The default value when the drive is in normal tape drive mode.</li> <li>800h The tape drive is in CD-ROM emulation mode for OBDR.</li> </ul>

## Read-Write Error Recovery mode page

The Read-Write Error Recovery mode page has the following format:

	7	6	5	4	3	2	1	0
0	PS (0)	Rsvd (0)	Page Code {01h}					
1	Additional Page Length {0Ah}							
2	Reserved (0)		TB (0)	Res (0)	EER (1)	PER [0]	DTE (0)	DCR (0)
3	Read Retry Count							
4-7	Reserved (0)							
8	Write Retry Count							
9-11	Reserved (0)							

Read-Write Error Recovery page fields:

TB	Transfer Block <ul style="list-style-type: none"> <li>0 Always set to 0, meaning that an unrecoverable data block will not be transferred to the host.</li> </ul>
EER	Enable Early Recovery <ul style="list-style-type: none"> <li>1 The drive should attempt error correction before performing retries.</li> </ul>

PER	<p>Post Error. Although this bit is changeable, the drive's internal behavior always corresponds to PER=0.</p> <ul style="list-style-type: none"> <li>0 The drive does not report CHECK CONDITION for recovered errors. The DTE bit must also be zero.</li> <li>1 The drive reports CHECK CONDITION for recovered errors.</li> </ul>
DTE	<p>Disable Transfer on Error</p> <ul style="list-style-type: none"> <li>0 Always set to 0, meaning that the drive will not terminate the transfer for errors recovered within the limits established by the read-write error parameters.</li> </ul>
DCR	<p>Disable Correction</p> <ul style="list-style-type: none"> <li>0 Always set to 0, meaning that the use of error correction codes for error recovery is allowed.</li> </ul>
Read Retry Count	<p>The number of times the drive will attempt its recovery algorithm during a read operation before reporting an unrecoverable error.</p> <ul style="list-style-type: none"> <li>0 The drive will not use its recovery algorithm during read operations.</li> <li>15h The drive will attempt 21 retries.</li> </ul>
Write Retry Count	<p>The number of times the drive will attempt its recovery algorithm during a write operation before reporting an unrecoverable error.</p> <ul style="list-style-type: none"> <li>0 The drive will not use its recovery algorithm during read operations.</li> <li>0Ah The value for all Ultrium drives, giving 10 retries.</li> </ul>

# Disconnect-Reconnect page

## SCSI drives

The Disconnect-Reconnect page has the following format for SCSI drives:

	7	6	5	4	3	2	1	0
0	PS (0)	Rsvd (0)	Page Code {02h}					
1	Additional Page Length {0Eh}							
2	Buffer Full Ratio (0)							
3	Buffer Empty Ratio (0)							
4	(MSB)	Bus Inactivity Limit (0)						(LSB)
5								
6	(MSB)	Disconnect Time Limit [0]						(LSB)
7								
8	(MSB)	Connect Time Limit (0)						(LSB)
9								
10	(MSB)	Maximum Burst Size [0]						(LSB)
11								
12	Reserved (0)						DTDC (0)	
13–15	Reserved (0)							

### Disconnect-Reconnect page fields:

Buffer Full Ratio	0	Buffer management is controlled by the drive, so this should always be zero.
Connect Time Limit	0	Buffer management is controlled by the drive, so this should always be zero.
Bus Inactivity Limit	0	This parameter is not supported and should be zero.
Disconnect Time Limit	0	This parameter is not supported and should be zero.
Connect Time Limit	0	This parameter is not supported and should be zero.
Maximum Burst Size	>0	The maximum amount of data that will be transferred during a data-in or data-out phase before disconnecting. This field is in units of 512 bytes. The maximum burst size that the drive supports is 127 (7Fh) blocks of 512 bytes, that is, 64 KB less 512 bytes.
	0	The drive may send bursts of any size. This is the default value.
DTDC	0	The Data Transfer Disconnect Control field is not supported and should be zero.

**NOTE:** If the host does not grant disconnect privilege in its IDENTIFY message these parameters become meaningless. The drive will stay connected on the bus for the duration of an operation or until the host sends a mid-operation IDENTIFY granting disconnect privilege.

## Control mode page

The Control Mode page is defined as follows:

	7	6	5	4	3	2	1	0
0	PS (0)	Rsvd (0)	Page Code {0Ah}					
1	Page Length {0Ah}							
2	TST (0)			Reserved (0)			GLTSD(0)	RECL (0)
3	Queue Algorithm Modifier (0)				Rsvd (0)	QErr (0)		DQue (0)
4	Rsvd (0)	RAC [0]	Reserved (0)	SWP (0)	RAERP(0)	UAAERP(0)	EAERP(0)	
5	Reserved (0)					Autoload Mode		
6	(MSB)	Ready AER Hold-off Period (0)						(LSB)
7								
8	(MSB)	Busy Timeout Period (0)						(LSB)
9								
10	(MSB)	Extended Self-Test Completion Timeout (0)						(LSB)
11								

### Control mode page fields:

---

Autoload Mode    0    If a cartridge is inserted, the drive pulls it in and threads the tape.  
                          1 *or* When a cartridge is inserted, the drive pulls it in but does *not* thread the tape. In  
                          2    this position, only the Cartridge Memory is accessible.  
 All other values are invalid.

---

## Data Compression Characteristics page

The Data Compression Characteristics Mode page is defined as follows:

	7	6	5	4	3	2	1	0
0	Page Code {0Fh}							
1	Page Length {0Eh}							
2	DCE [1]	DCC (1)	Reserved (0)					
3	DDE (1)	RED (0)	Reserved (0)					
4	(MSB)	Compression Algorithm (1)						(LSB)
7								
8	(MSB)	Decompression Algorithm (1)						(LSB)
11								
12	Reserved (0)							
15								

## Data Compression Characteristics mode page fields:

---

DCE	<p><i>Data Compression Enable</i>. This bit controls whether the drive uses compression when writing. The value has no meaning when reading, that is, if the tape contains compressed data, decompression will occur regardless of the setting of this bit. The bit is analogous to the Select Data Compression Algorithm field on the Device Configuration mode page (see page 81).</p> <p>0 Compression is disabled 1 Compression is enabled</p>
DCC	<p><i>Data Compression Capable</i> Read only. It will have the value of 1, indicating that compression is supported.</p>
DDE	<p><i>Data Decompression Enable</i> Read only. It will have the value of 1, indicating that compression is enabled.</p>
RED	<p><i>Report Exception on Decompression</i> Read only. It will have the value 0, meaning that the drive returns CHECK CONDITION status when it encounters data that cannot be decompressed. This applies when data has been compressed with an unknown or unsupported compression algorithm.</p>
Compression Algorithm	<p>This indicates which compression algorithm will be used to process data from the host when the DCE bit is set to one. If the host selects an algorithm which the drive does not support, CHECK CONDITION is returned, with a sense key of ILLEGAL REQUEST. Only the default algorithm (ID 1) is supported.</p>
Decompression Algorithm	<p>This will also always be 1, indicating that the default decompression algorithm should be used.</p>

---



# Device Configuration page

The drive supports the Device Configuration page, which has the following format:

	7	6	5	4	3	2	1	0
0	PS (0)	Rsvd (0)	Page Code {10h}					
1	Additional Page Length {0Eh}							
2	Rsvd(0)	Obsolete	CAF (0)	Active Format (0)				
3	Active Partition (0)							
4	Write Buffer Full Ratio (0)							
5	Read Buffer Empty Ratio (0)							
6	(MSB)	Write Delay Time: 012Ch						(LSB)
7								
8	DBR (0)	BIS (1)	RSmk(0)	AVC (0)	SOCF (00)	RBO(0)	REW (0)	
9	Gap Size (0)							
10	EOD Defined (000)			EEG (1)	SEW (1)	Reserved (0)		
11	(MSB)	Buffer Size at Early Warning (0)						(LSB)
12								
13								
14	Select Data Compression Algorithm [1]							
15	Reserved (0)	WTRE	OIR	Rewind on Reset [0]	ASOCW P (0)	PERSWP (0)	PRMW P (0)	

## Pre-execution checks:

The only check made when this page is sent in Mode Select data is Parameter List.

## Changeable parameters:

Write Delay Time	0	This field can be modified by a MODE SELECT command, and this change will be reflected in a subsequent MODE SENSE command. However the actual value used as the delay time will remain as zero, and so the data in the buffer will never be flushed. The default value is zero.
	>0	The time in 100 ms increments that the drive should wait with unwritten data in the buffer and no activity on the interface before forcing data to tape. The delay is timed from the completion of the preceding Write or Write Filemarks command.
Select Data Compression Algorithm	0	Use Scheme 2 of the LTO-DC algorithm (pass-through mode). <i>Note that clearing this parameter is not advised.</i>
	1	Use the default compression scheme. This is the default.

WTRE	WORM Tamper Read Enable. Controls the behavior of the drive when reading WORM media if it appears that the integrity of the tape has been compromised by tampering. WTRE has no effect on reads of normal (non-WORM) media.
	<ul style="list-style-type: none"> <li>0 <i>Default:</i> If no tampering has been detected, data is returned as normal. If tampering has been detected, no data is returned in response to a READ command or after the position of tamper. CHECK CONDITION is returned with sense key of Medium Error and additional sense of 300Dh (WORM medium—integrity check failed). TapeAlert flag 3Bh (medium error—integrity check failed) is set. The Error Code field in the Error Usage page will be filled with the ASC/Q of 300Dh.</li> <li>1 Data is returned regardless of whether tampering has been detected on the WORM cartridge. The bit should only be set as a last resort where data recovery overrides concerns about WORM integrity.</li> </ul>
Rewind on Reset	<ul style="list-style-type: none"> <li>00b A Logical Unit Reset does not alter the logical position.</li> <li>01b A Logical Unit Reset will cause the tape to be rewound to BOT.</li> <li>10b A Logical Unit Reset does not alter the logical position.</li> <li>11b Reserved</li> </ul>

### Unchangeable parameters:

PS	0
CAF	0 The Change Active Format flag should be zero since changing formats is not supported.
Active Format	0 Changing formats is not supported.
Active Partition	0 Multiple partitions are not supported.
Write Buffer Full Ratio	0 Buffer management is done by the drive.
Read Buffer Empty Ratio	0 Buffer management is done by the drive.
DBR	0 The Data Buffer Recovery flag should be clear since this feature is not supported.
BIS	1 The Block Identifiers Supported flag should be set since block identifiers are supported.
Rsmk	0 The Report Set Marks flag should be clear since this feature is not supported.
AVC	0 The Automatic Velocity Control flag should be clear since velocity control is managed by the drive.
SOCF	0 The Stop On Consecutive Filemarks flag should be clear since this feature is not supported.
RBO	0 The Recover Buffer Order flag should be clear since this feature is not supported.
REW	0 The Report Early Warning on read flag should be clear since this feature is not supported.
Gap Size	0 There is no concept of inter-block gaps in the format.
EOC Defined	0

EEG	0	The Enable EOD Generation flag should be set since EOD generation is always enabled.
SEW	1	The Synchronize at Early Warning flag should be set since this feature is supported.
Buffer Size at Early Warning	0	The Buffer Size at Early Warning field should be zero as this cannot be set.

## Medium Partitions mode page

The Medium Partitions mode page has the following format. Note that none of the fields are changeable. The Partition Size will be patronized.

	7	6	5	4	3	2	1	0
0	Page Code (11h)							
1	Page Length (08h)							
2	Maximum Additional Partitions (0)							
3	Additional Partitions Defined (0)							
4	FDP (0)	SDP (0)	IDP (0)	PSUM (11b)	POFM (0)	CLEAR (0)	ADDP (0)	
5	Medium Format Recognition (3)							
6	Reserved (0)				Partition Units (9)			
7	Reserved (0)							
8	(MSB)	Partition Size						(LSB)
9								

None of the fields in this mode page are changeable.

Maximum Additional Partitions	0	Zero is returned, indicating that no additional partitions are present or supported.
Additional Partitions Defined	0	Zero must be returned, indicating that no additional partitions are present or supported.
FDP	0	The Fixed Data Partitions bit is not supported and must be set to zero.
SDP	0	The Select Data Partitions bit is not supported and must be set to zero.
IDP	0	The Initiator Defined Partitions bit is not supported and must be set to zero.
POFM	0	The Partitions on Format bit is set to zero since the drive does not support the FORMAT MEDIUM command through which the tape could be partitioned.
CLEAR	0	Set to zero indicating SCSI-2 compatibility.
ADDP	0	Set to zero indicating SCSI-2 compatibility.
Medium Format recognition	3	This indicates that the drive is capable of format and partition recognition.

PSUM	3	Partition Size Unit of Measure: The value of 11b indicates that the units of measure for the Partition Size descriptor are defined by the Partitions Units field: $10^{(\text{Partition Units})}$ bytes.
Partition Units	9	This defines the units of the Partition Size field as $10^9$ bytes, in other words in gigabytes.
Partition Size		The Partition Size field will be updated following successful execution of the Set Capacity command. 100 Gen 1 tape loaded 200 Gen 2 tape loaded 400 Default value. No data cartridge present or Gen 3 tape loaded.

## Fibre Channel Logical Unit Control mode page

This page is supported for Fibre Channel only:

	7	6	5	4	3	2	1	0
0	PS (0)	Rsvd (0)	Page Code {18h}					
1	Page Length {06h}							
2	Reserved (0)							
3	Reserved (0)						EPDC[1]	
4-7	Reserved (0)							

- EPDC
- 0 The target does not use the precise delivery function and ignores the contents of the CRN field in the Fibre Channel Extended Link Service `FCP_CNTL`. HP Ultrium drives support this feature by default.
  - 1 The logical unit uses the precise delivery function defined in the FCP-2 standard. It makes use of the CRN field.

## SCSI LUN Control mode page

NOTE: This page is supported for SCSI drives only, from Gen 3 onwards.

	7	6	5	4	3	2	1	0
0	PS (0)	Rsvd (0)	Page Code {18h}					
1	Page Length {06h}							
2	Reserved (0)				Protocol Identifier (1h)			
3-7	Reserved (0)							

- Protocol Identifier
- 1 The protocol to which this mode page applies is SPI SCSI.

# Fibre Channel Port Control mode page

NOTE: This page is supported for Fibre Channel only.

The Fibre Channel Port Control page allows you to set the initialization and addressing behavior of the Fibre Channel interface.

	7	6	5	4	3	2	1	0
0	PS (0)	Rsvd (0)	Page Code {19h}					
1	Page Length {06h}							
2	Reserved (0)				Protocol Identifier (FCP=0)			
3	DTFD (0)	PLPB(0)	DDIS(0)	DLM(1)	RHA(0)	ALWLI(0)	DTIPE(0)	DTOLI(0)
4	Reserved (0)							
5	Reserved (0)							
6	Reserved (0)					RR_TOV Units (3)		
7	Resource Recovery Time-Out Value—RR_TOV (F0h, that is, 24s)							

**DTFD** *Disable Target Fabric Discovery.* If the drive is not attached to an arbitrated loop, the DTFD bit is ignored.

- 0 When attached by an arbitrated loop, the drive will discover a fabric loop port if one is present on the loop and perform public loop functions.
- 1 When attached by an arbitrated loop, the drive will not recognize the presence of a fabric loop port on the loop. The drive performs only the private loop functions.

**PLPB** *Prevent Loop Port Bypass*

- 0 The drive allows the Loop Port Bypass (LPB) and Loop Port Enable (PBE) primitive sequences to control the port bypass circuit.
- 1 The drive ignores any Loop Port Bypass (LPB) and Loop Port Enable (LPE) primitive sequences. The loop port remains enabled. When the PLPB bit is zero, the drive allows the LPB and PBE primitive sequences to control the port bypass circuit.  
NOTE: If the PLPB bit is set to 1, the DTIPE bit must be set to 0.

**DDIS** *Disable Discovery*

- 0 The drive must wait to receive an Address Discovery Link Service (ADISC) or Port Discovery Link Service (PDISC) before it resumes processing tasks for the initiator.
- 1 The drive does not require receipt of Address or Port Discovery following loop initialization. The drive resumes processing of tasks on completion of loop initialization.

**DLM** *Disable Loop Master.*

- 0 The drive may become loop master during the loop initialization process.
- 1 The drive will never attempt to be a loop master; it only repeats LISM frames it receives. This allows the initiator to be loop master during loop initialization.

RHA	<p><i>Require Hard Address.</i> If the drive is not attached to an arbitrated loop, the RHA bit is ignored.</p> <ul style="list-style-type: none"> <li>0 The drive follows the normal initialization procedure, including the possibility of obtaining a soft address during the loop initialization process.</li> <li>1 When attached to an arbitrated loop, the drive will only attempt to obtain its hard address (available via the device address jumpers) during loop initialization. The drive will not attempt to obtain an address during the LISA phase of initialization. If there is a conflict for the hard address selection during loop initialization or it does not have a valid hard address available, the drive will enter the non-participating state. If the drive detects loop initialization while in the non-participating state, it will again attempt to get its hard address. If the hard address has not changed from the address obtained in a previous successful loop initialization, the drive will attempt to obtain the address in the LIFA phase if a valid Fabric Login exists or in the LIPA phase of loop initialization. If the hard address has changed, the target will attempt to obtain the new address in the LIHA phase.</li> </ul>
ALWLI	<p><i>Allow Login Without Loop Initialization</i></p> <ul style="list-style-type: none"> <li>0 The drive is required to verify its address through the loop initialization process before a login is accepted.</li> <li>1 The drive uses the hard address available in the SCA connector or device address jumpers and accepts logins without verifying the address with loop initialization.</li> </ul>
DTIPE	<p><i>Disable Target Initiated Port Enable</i></p> <ul style="list-style-type: none"> <li>0 The drive enables its port into the loop without waiting for a Loop Port Enable primitive.</li> <li>1 The drive waits for an initiator to send the Loop Port Enable primitive before inserting itself into the loop. The drive uses the hard address available in the SCA connector or device address jumpers to determine if primitives are addressed to it. A Loop Port Enable primitive with the broadcast address will also cause the drive to insert itself into the loop.</li> </ul> <p>NOTE: If the DTIPE bit is set to 1, the PLPB bit must be set to 0.</p>
DTOLI	<p><i>Disable Target Originated Loop Initialization</i></p> <ul style="list-style-type: none"> <li>0 The drive generates the Initializing LIP after it enables a port into a loop.</li> <li>1 The drive does not generate the Initializing LIP following insertion into a loop. It will respond to an Initializing LIP when it is received. It will generate the Loop Failure LIP at its input and the Initializing LIP when the loop failure is corrected.</li> </ul>
RR_TOV Units	<p><i>Resource Recovery Time-Out Value Unit.</i> The field specifies the unit of measure as follows:</p> <ul style="list-style-type: none"> <li>000b No timer specified</li> <li>001b 0.001s</li> <li>011b 0.1s, units used by HP Ultrium drives</li> <li>101b 10s</li> </ul>
RR_TOV	<p>The number of time units specified by the RR_TOV Units field that are used by the timer that performs the RR_TOV time-out functions.</p> <p>F0h 240 x 0.1s units = 24 seconds</p>

# SCSI Port Control Mode page

NOTE: This page is supported for SCSI drives only, from Gen 3 onwards.

## Normal page

If the Port Control mode page (19h) is requested via the MODE SENSE command with the Sub-Page code set to zero, the following data will be returned:

	7	6	5	4	3	2	1	0
0	PS (0)	SPF(0)	Page Code {19h}					
1	Page Length {06h}							
2	Reserved (0)				Protocol Identifier (1h)			
3	Reserved (0)							
4	Synchronous Transfer Timeout (0)							
5								
6-7	Reserved (0)							

Protocol Identifier                    1    The protocol to which this mode page applies is SPI SCSI.

Synchronous Transfer Timeout    0    Synchronous Transfer Timeout is disabled.

## Sub-pages

	7	6	5	4	3	2	1	0
0	PS (0)	SPF(0)	Page Code {19h}					
1	Subpage Code							
2	Page Length ( $n-3$ )							
3								
4	Reserved (0)							
5	Reserved (0)				Protocol Identifier (01h)			
6								
n	Protocol Specific Mode Parameters							

The following sub-pages are supported:

- Margin Control (01h) — static data
- Saved Training Configuration Values (02h) — static data
- Negotiated Settings (03h) — dynamic data
- Report Transfer Capabilities (04h) — static data

## Sub-page 01h—Margin Control

	7	6	5	4	3	2	1	0
0	Reserved (0)							
1	Driver Strength (0)				Reserved (0)			
2	Driver Asymmetry (0)				Drive Precompensation (1h)			
3	Driver Slew Rate (0)				Reserved (0)			
4	Reserved (0)							
6	Reserved (0)							
7	Vendor Specific (0)							
8	Reserved (0)							
15	Reserved (0)							

None of the fields are supported on this page, so they should all be zero.

## Sub-page 02h—Saved Training Configuration Values

	7	6	5	4	3	2	1	0
0	Reserved (0)							
3	Reserved (0)							
4	DB(0) Value (0)							
7	DB(0) Value (0)							
:								
64	DB(15) Value (0)							
67	DB(15) Value (0)							
68	P_CRCA Value (0)							
71	P_CRCA Value (0)							
72	P1 Value (0)							
75	P1 Value (0)							
76	BSY Value (0)							
79	BSY Value (0)							
80	SEL Value (0)							
83	SEL Value (0)							
84	RST Value (0)							
87	RST Value (0)							
88	REQ Value (0)							
91	REQ Value (0)							
92	ACK Value (0)							
95	ACK Value (0)							



	7	6	5	4	3	2	1	0
96	ATN Value (0)							
99								
100	C/D Value (0)							
103								
104	I/O Value (0)							
107								
108	MSG Value (0)							
111								
112	Reserved (0)							
227								

All the fields on this page are vendor-specific. None are supported, so they should all be zero.

### Sub-page 03h—Negotiated Settings

	7	6	5	4	3	2	1	0
0	Transfer Period Factor							
1	Reserved (0)							
2	Req/Ack Offset							
3	Transfer Width Exponent							
4	Protocol Options Bits							
5	Reserved (0)			Transceiver Mode		Sent PCOMP_EN	Received PCOMP_EN	
6	Reserved (0)							
7								

Transfer Period Factor	The negotiated transfer period factor.		
Req/Ack Offset	The negotiated Req/Ack offset.		
Transfer Width Exponent	The negotiated transfer width.		
Protocol Options Bits	The negotiated protocol options:		
Bit	Protocol Option	Meaning	Supported
7	PCOMP_EN	Precompensation	Yes
6	RTI	Retain training information	Yes
5	RD_STRM	Read streaming and read flow control	No
4	WR_FLOW	Write flow control	No
3	HOLD_MCS	Hold margin control	No
2	QAS_REQ	Quick arbitration and selection	No
1	DT_REQ	Double transition clocking	Yes
0	IU_REQ	Information units	Yes

Transceiver Mode	The current bus mode:	
	Code	Bus Mode
	00b	Unknown
	01b	SE
	10b	LVD
	11b	HVD (Note that this will never be reported since the drive will not operate on an HVD bus)
Sent PCOMP_EN	The value of the PCOMP_EN bit sent. This will be set if PCOMP_EN has been negotiated successfully.	
Received PCOMP_EN	The value of the PCOMP_EN bit received. This will be set if PCOMP_EN has been negotiated successfully.	

### Sub-page 04h—Report Transfer Capabilities

	7	6	5	4	3	2	1	0
0	Minimum Transfer Period Factor (08h)							
1	Reserved (0)							
2	Maximum Req-Ack Offset (40h)							
3	Maximum transfer Width Exponent (1)							
4	Protocol Option Bits Supported (C3h)							
5	Reserved (0)							
7								

Minimum Transfer Period Factor	08h	The smallest value of the transfer period factor supported. For Gen 3 SCSI, this is 8, in other words, FAST160.
Maximum Req/Ack Offset	40h	The maximum value for the Req/Ack offset. For Gen 3 SCSI, this is 64 (40h).
Maximum Transfer Width Exponent	1	The maximum width supported. For Gen 3 SCSI, this is 1.
Protocol Option Bits Supported	C3h.	The protocol options supported. The value of C3h indicates that PCOMP_EN, RTI, DT_REQ and IU_REQ are supported and RD_STRM, WR_FLOW, HOLD_MCS and QAS_REQ are not. See the Protocol Options Bits field on sub-page 03h (Negotiated Settings) on page 89 for details of the bits.

# Information Exceptions mode page

The Information Exceptions Mode page is used to control exception reporting through the "TapeAlert log page" on page 65:

	7	6	5	4	3	2	1	0
0	PS (0)	Rsvd (0)	Page Code {1Ch}					
1	Page Length {0Ah}							
2	Perf (0)	Reserved (0)			DExcpt	Test	Rsvd (0)	LogErr (0)
3	Reserved (0)				MRIE (3h)			
4	(MSB)	Interval Timer (0)						(LSB)
7								
8	(MSB)	Report Count/Test Flag Number						(LSB)
11								

Perf	0	Informational exception operations that cause delays are acceptable.
DExcpt		<p><i>Disable Exception Control.</i> It must be zero when the Test Flag Number is zero. When the Test Flag Number contains a valid non-zero value, the DExcpt flag can be 0 or 1.</p> <p>0 Information exception operations are enabled. The reporting of information exception conditions is determined from the MRIE field.</p> <p>1 A DExcpt bit of one indicates the target will disable all information exception operations. The method of reporting informational exceptions field is ignored when DExcpt is set to one. The Test bit must not be set at the same time.</p>
Test	0	If the Test flag is clear the next command will be processed normally.
	1	<p>A test bit of one will generate false informational exception conditions. As a result, the next SCSI command after the Mode Select will return CHECK CONDITION with a sense key of RECOVERED ERROR and additional sense of 5DFFh (failure prediction threshold exceeded - false). The DExcpt bit must not be set at the same time.</p> <p>The Test bit will never be read as 1 when performing a Mode Sense command. This is not an indication that the drive is in test mode.</p> <p>For example, using the Test bit and Test Flag Number, it may be possible to set a flag with the DExcpt bit set to 1. When the DExcpt bit is next set, the drive will report CHECK CONDITION with a sense key of RECOVERED ERROR and additional sense of 5DFFh (failure prediction threshold exceeded - false). In order to set the DExcpt bit again, note that the Test bit must still be set during the Mode Select command.</p>
LogErr	0	<i>Log Errors bit.</i> This bit must be zero, indicating that the logging of informational exception conditions within the drive is vendor-specific.

MRIE	<i>Method of Reporting Informational Exceptions</i>	
	3h	This field indicates the method used by the target to report informational exception conditions and must be set to 3. The target will report informational exception conditions by returning a CHECK CONDITION status on any command. The sense key will be set to RECOVERED ERROR with additional sense of 5D00h (failure prediction threshold exceeded). The command that has the CHECK CONDITION will complete without error before any informational exception condition may be reported.
Interval Timer	0	Must be zero, indicating that the drive only reports an informational exception condition once.
Report Count/Test Flag Number	0	If the Test bit is zero, this field is the Report Count and must be zero, indicating that there is no limit on the number of times the drive can report an informational exception condition.
	n	If the Test bit is one, this field is the Test Flag Number, that is, the number of a supported TapeAlert flag. The target will generate a test informational exception condition. As a result, the next SCSI command after Mode Select will return CHECK CONDITION with a sense key of RECOVERED ERROR and additional sense of 5DFFh (failure prediction threshold exceeded - false). The following are valid settings:
	1 through 64	This sets the TapeAlert flag with this number in the Log page.
	-1 through -64 (FFFFFFFh-FFFFFFC0h)	This clears the TapeAlert flag indicated by the absolute value of the Test Flag Number.
	32767 (7FFFFh)	This sets all the TapeAlert flags supported by the target in the Log page.

Note that if an attempt is made to set or clear a flag that is not supported by the drive, CHECK CONDITION will be reported with a sense key of ILLEGAL REQUEST and additional sense of 2600h (invalid field in parameter list).

## Device Time mode page

The Device Time Mode page consists of the following page header followed by three Timebase descriptors:

	7	6	5	4	3	2	1	0
0	PS (0)	SBF (0)	Page Code (3Ch)					
1	Page Length (1Ah)							
2	Reserved (0)					LT	WT	PT
3	Reserved (0)							

### Power-on time descriptor

	7	6	5	4	3	2	1	0
4	Timebase Identifier (00h)							
5	Timebase Field Length (06h)							
6	(MSB)	Current Power-on Count						(LSB)
7								
8	(MSB)	Power-on Time						(LSB)
11								

### World time descriptor

	7	6	5	4	3	2	1	0
12	Timebase Identifier (01h)							
13	Timebase Field Length (06h)							
14	Reserved (0)						UTC	NTP
15	Reserved (0)							
16	(MSB)	World Time						(LSB)
11								

### Library time descriptor

	7	6	5	4	3	2	1	0
20	Timebase Identifier (10h)							
21	Timebase Field Length (06h)							
22	Reserved (0)							
23	Library Time (hrs)							
24	Library Time (mins)							
25	Library Time (secs)							
26	Reserved (0)							
27								

	MODE SENSE	MODE SELECT
PT	0 Power-on Time is invalid. 1 Power-on Time is valid.	Ignored
WT	0 World Time is invalid. 1 World Time is valid.	1 to set world time
LT	0 Library Time is invalid. 1 Library Time is valid.	Ignored

	MODE SENSE	MODE SELECT
Current Power-on Count	The number of times the drive has been powered on	Ignored
Power-on Time	The number of seconds since the drive has been powered on	Ignored
World Time	The number of seconds from 00:00:00 on January 1, 1970	Ignored if WT = 0
UTC	0 The local timezone has been used. 1h World Time is UTC.	Ignored if WT is 0 Set to 1 if UTC World Time is being used.
NTP	0 Unsure if NTP-synced 1h World Time is set from NTP source.	Ignored if WT is 0 Set to 1 if World Time is NTP-synced.
Library Time	The time in hrs:mins:secs set by the library controller	Ignored

## CD-ROM Emulation/Disaster Recovery mode page

This page can be used irrespective of whether the drive is acting as a tape or a CD device.

	7	6	5	4	3	2	1	0
0	Page Code {3Eh}							
1	Page Length {02h}							
2	Reserved (0)						Non-Auto	CDmode
3	Reserved (0)							

### CD-ROM Emulation/Disaster Recovery mode page fields:

**Non-Auto** When a system restarts after booting off tape, the drive detects the SCSI resets issued during reboot and, in conjunction with knowing that more than 100 blocks have been read in CD-ROM emulation mode, will revert back to behaving as a tape device. This is the standard method by which the drive automatically reverts to being a tape drive in order that a backup application can do file system recovery. The method of reversion involves a firmware reboot, so the drive might become unavailable for a few seconds during its "power-on" following the SCSI reset. (Note that normal SCSI reset response does not involve a firmware reboot).

Setting this flag to 1 inhibits this automatic return to tape drive behavior; the drive will remain in CD-ROM mode irrespective of blocks read and SCSI resets.

**CDmode** *MODE SENSE* 0 The drive is in tape drive mode.  
1 The drive is in CD-ROM emulation mode.

*MODE SELECT* This flag can be used to switch the drive between normal operation and CD-ROM emulation mode:

- If this bit is set to its existing value, there is no change.
  - If this bit is changed from 0 to 1, the drive will enter CD-emulation mode. It will change its Inquiry and Mode data appropriately and cache the first 250 KB of the CD image off tape. CD-ROM support commands will be enabled. This transition is primarily present to support automated functional testing. If the bit is changed from 1 to 0, the drive leaves CD-ROM emulation mode and reverts to normal tape drive mode.
  - If this bit is changed from 1 to 0, the drive will leave CD-emulation mode. The Inquiry and Mode data will revert to that for a tape drive and CD-ROM command support will stop. The tape will be reloaded and the logical position will be BOP. Backup applications can use this transition to switch to a normal mode of operation for file system recovery off tape. Note that operating systems that pre-load class drivers at boot might not be prepared to talk to the erstwhile CD-ROM drive
-

MODE SENSE allows the drive to return its current configuration and report which configuration parameters can be changed through MODE SELECT.

The mode sense header, block descriptor (optional), and zero or more of the are sent to the host. Mode pages contain drive configuration parameters. Some of these parameters are fixed, others are configurable (through the MODE SELECT command). The host should use MODE SENSE to determine which drive parameters are configurable and what their current values are before using mode select to alter them.

NOTE: See MODE SELECT on page 71 for full descriptions of the Mode Parameters. If a MODE SENSE command is issued whilst an immediate reported Load command is executing or close to completing then the values of some parameters in some mode pages which depend on the results of the load may be undefined.

Similarly, the write-protect field in the Mode Parameter Header will be unstable unless a cartridge is present and medium removal is prevented.

### Pre-execution checks:

Illegal Field                  Reservation                  Deferred Error                  Unit Attention

The page code field must contain a valid mode page code or the value 0 or the value 3Fh. If it does not then CHECK CONDITION status is reported. Sense data will be as described in the Illegal Field Checks.

### Command descriptor block:

#### 6-Byte Version

	7	6	5	4	3	2	1	0
0	Operation Code (1Ah)							
1	Reserved (0)				DBD	Reserved (0)		
2	PC		Page Code					
3	Sub Page Code							
4	Allocation Length							
5	Control							



10-byte version

	7	6	5	4	3	2	1	0
0	Operation Code (5Ah)							
1	Reserved (0)				DBD	Reserved (0)		
2	PC		Page Code					
3	Sub Page Code							
4	Reserved (0)							
6	Reserved (0)							
7	(MSB)		Allocation Length				(LSB)	
8	Allocation Length							
9	Control							

CDB fields:

DBD	<i>Disable Block Descriptors flag</i>												
	<p>0 Allows the drive to return the MODE SELECT block descriptor.</p> <p>1 Prevents the drive from returning the MODE SELECT block descriptor.</p>												
PC	<i>Page Control</i> —Indicates the type of page parameter values to be returned to the host, as shown in the following table:												
	<table border="1"> <thead> <tr> <th>7</th> <th>6</th> <th>Description</th> </tr> </thead> <tbody> <tr> <td>0</td> <td>0</td> <td><i>Report Current Values</i>: the current values of the parameters are returned.</td> </tr> <tr> <td>0</td> <td>1</td> <td><i>Report Changeable Values</i>: the page returned has its non-changeable parameter fields cleared to 0. The fields that are changeable are set to all 1's.</td> </tr> <tr> <td>1</td> <td>0/1</td> <td><i>Report Default Values</i>: the page returned contains the power-on/reset/bus-device-reset values of the mode parameters.</td> </tr> </tbody> </table>	7	6	Description	0	0	<i>Report Current Values</i> : the current values of the parameters are returned.	0	1	<i>Report Changeable Values</i> : the page returned has its non-changeable parameter fields cleared to 0. The fields that are changeable are set to all 1's.	1	0/1	<i>Report Default Values</i> : the page returned contains the power-on/reset/bus-device-reset values of the mode parameters.
7	6	Description											
0	0	<i>Report Current Values</i> : the current values of the parameters are returned.											
0	1	<i>Report Changeable Values</i> : the page returned has its non-changeable parameter fields cleared to 0. The fields that are changeable are set to all 1's.											
1	0/1	<i>Report Default Values</i> : the page returned contains the power-on/reset/bus-device-reset values of the mode parameters.											
Page Code	<p>This allows the host to select any specific page, or all the pages supported by the drive.</p> <p>0 The drive returns no mode pages, so only the header and block descriptor are returned.</p> <p>Any mode page code The drive returns that page.</p> <p>3Fh The drive returns all mode pages.</p>												
Sub Page Code	The sub-page code of the page code for data to be returned. If there are no sub-pages, it should be set to 0.												
Allocation Length	<p>Specifies the number of bytes that the host has allocated for returned MODE SENSE data.</p> <p>0 No data transfer will occur. This is not considered an error.</p> <p><i>n</i> The maximum number of bytes which the drive should return in its data-out phase. Either the entire mode page or allocation length bytes of the page are returned, whichever is least.</p>												

# PERSISTENT RESERVE IN

5Eh

PERSISTENT RESERVE IN is used to obtain information about persistent reservations and reservation keys that are active within a tape drive logical unit.

Pre-execution checks:

Illegal Field          Reservation          Deferred Error          Unit Attention

Command descriptor block:

	7	6	5	4	3	2	1	0
0	Operation Code (5Eh)							
1	Reserved (0)				Service Action			
2	Reserved (0)							
6	Reserved (0)							
7	(MSB)	Allocation Length						(LSB)
8								
9	Control							

CDB fields:

---

Service Action The service action types that are supported are:

- 00h Read Keys Returns all registered reservation keys
- 01h Read Reservation Returns information on any current persistent reservation
- 02h Read Capabilities Returns details of the persistent reservation features supported

---

Allocation Length The maximum amount of data (in bytes) that should be returned to the host. The drive will return all of the requested information or allocation length bytes, whichever is least.

---

Returned data for service actions:

### Read Keys service action

The drive will return a parameter list containing an 8-byte header and list of each currently registered I\_T nexus' reservation key. Each key is 8 bytes long. The format of the returned data is as follows:

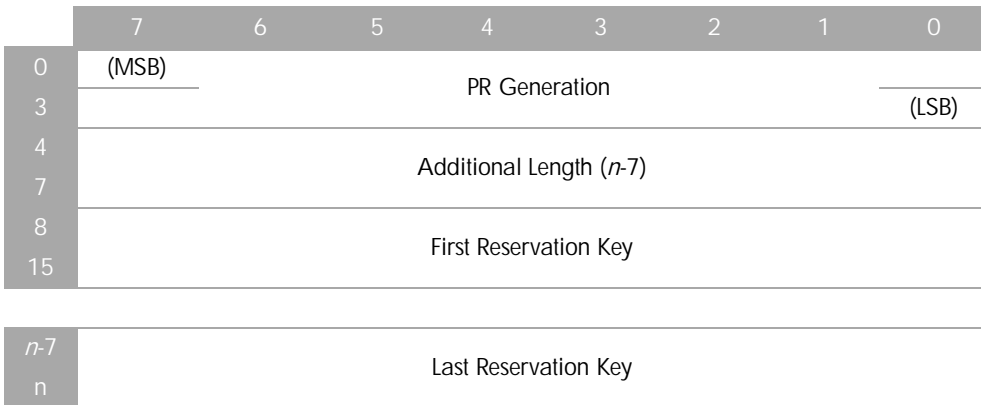



---

**PR Generation** A 32-bit counter that is maintained by the drive and incremented every time a PERSISTENT RESERVE OUT command requests a Register, Register and Ignore Existing Key, Clear, Preempt, or Preempt and Abort service action.

---

### Read Reservation service action

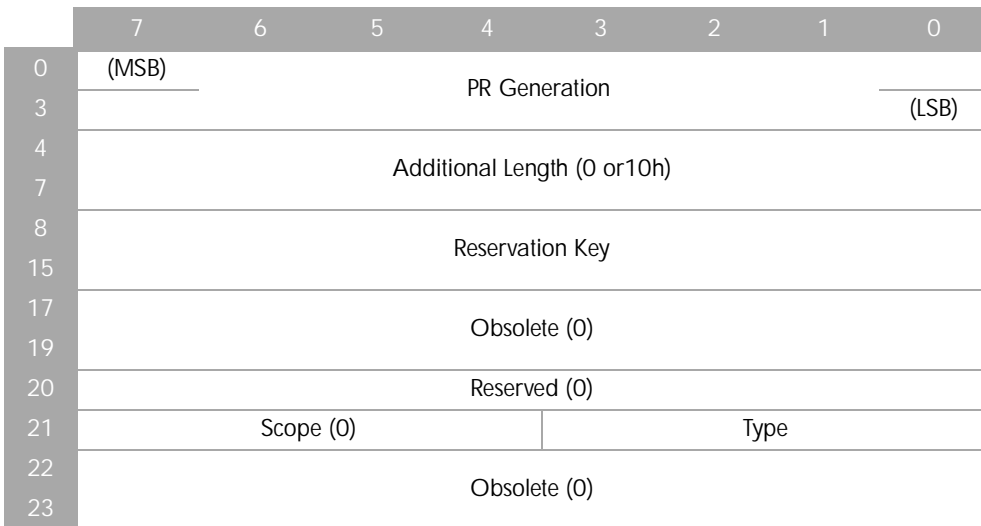
The drive returns a parameter list containing an 8-byte header and the persistent reservation, if any, that is present in the drive. If no persistent reservation is present, Additional Length is 0 and no reservation data is returned. If a persistent reservation is present, Additional Length is 10h and 16 bytes of reservation data are returned as follows:



PR Generation	As for "Read Keys service action" on page 99.
Reservation Key	The key under which the persistent reservation is held.
Scope	0 Indicates LU_SCOPE.
Type	The characteristics of the persistent reservation currently held. Persistent reservation types supported by the drive are: 3h Exclusive access 6h Exclusive access, registrants only 8h Exclusive access, all registrants  See PERSISTENT RESERVE OUT for more information and also the appropriate standards.

### Read Capabilities service action

This provides a mechanism for the drive to report which features of Persistent Reservation are implemented. The format of the data returned is as follows:

	7	6	5	4	3	2	1	0	
0	(MSB)							Length (0008h)	
1								(LSB)	
2	Reserved (0)			CRH (1)	SIP_C (1)	ATP_C(0)	Rsvd(0)	PTPL_C(1)	
3	TMV (1)	Reserved (0)						PTPL_A	
4	WR_EX_AR(0)	EX_AC_RO(1)	WR_EX_RO(0)	Rsvd(0)	EX_AC(1)	Rsvd(0)	WE_EXC(0)	Rsvd(0)	
5	Reserved (0)							EX_AC_AR(1)	
6	Reserved (0)								
7	Reserved (0)								

PTPL_A	0	Persist Through Power Loss has not been activated
	1	The most recent successfully completed PERSISTENT RESERVE OUT command with <i>Register</i> or <i>Register and Ignore Existing Key</i> service action had the APTPL bit set to one in the parameter data.

All the other fields are fixed. Refer to the description of PERSISTENT RESERVE OUT or the appropriate standards for more information.

the PERSISTENT RESERVE IN command, and clause 5.6 for a detailed discussion of reservations.

# PERSISTENT RESERVE OUT

5Fh

PERSISTENT RESERVE OUT is used to request service actions that create a persistent reservation in a logical unit within the tape drive for the exclusive or shared use of a particular I\_T nexus. The command uses other service actions to manage and remove such persistent reservations.

An I\_T nexus performing Persistent Reserve Out service actions is identified by a reservation key.

Pre-execution checks:

Illegal Field          Reservation          Deferred Error          Unit Attention

Command descriptor block:

	7	6	5	4	3	2	1	0
0	Operation Code (5Fh)							
1	Reserved (0)				Service Action			
2	Scope				Type			
3	Reserved (0)							
6	Reserved (0)							
7	Parameter List Length							
8	Parameter List Length							
9	Control							

CDB fields:

Service Action	00b Register	Registers or unregisters a reservation key with the device server.
	01b Reserve	Creates the persistent reservation.
	02b Release	Releases the persistent reservation.
	03h Clear	Clears all reservation keys and the persistent reservation.
	04h Preempt	Pre-empt the persistent reservation and/or remove registrations.
	05h Preempt and Abort	Pre-empt the persistent reservation and/or remove registrations, and aborts all tasks for all pre-empted I_T nexuses.
	06h Register and Ignore Existing Key	Registers or unregisters a reservation key with the device server.
Scope	0	Indicates LU_SCOPE.

Type	The characteristics of the persistent reservation currently held. Persistent reservation types supported by the drive are: 3h Exclusive access 6h Exclusive access, registrants only 8h Exclusive access, all registrants
Parameter List Length	The amount of data (in bytes) that should be sent to the drive from the host in parameter list data. If the SPEC_I_PT bit in the parameter data is 0, this field is set to 18h. If SPEC_I_PT is 1, this field specifies the number of bytes of parameter data (minimum is 18h).

## Parameter data

	7	6	5	4	3	2	1	0
0	(MSB) _____							
7	Reservation Key							_____ (LSB)
8	(MSB) _____							
15	Service Action Reservation Key							_____ (LSB)
16	Obsolete (0)							
19	Obsolete (0)							
20	Reserved (0)			SPEC_1_PT	ALL_TG_PT	Rsvd(0)	APTPL	
21	Reserved (0)							
22	Obsolete (0)							
23	Obsolete (0)							
24	(MSB) _____							
n	Additional Parameter Data							_____ (LSB)

**Reservation Key** Identifies the I\_T nexus that sent the command. The value must match the registered reservation key for the I\_T nexus except for:

- The *Register and Ignore Existing Key* service action, where this field is ignored.
- The *Register* service action for an unregistered I\_T nexus, where this field is 0.

If the Reservation Key does not match with the one registered in the device server for the I\_T nexus, the device server returns Reservation Conflict.

**Service Action Reservation Key** Information needed for the following service actions: *Register*, *Register and Ignore Existing Key*, *Preempt*, and *Preempt and Abort*.

For the *Register* and *Register and Ignore Existing Key* service actions:

- 0 Unregisters the registered reservation key specified in the Reservation Key field.
- n The new reservation key to replace the existing one as specified in the Reservation Key field for the I\_T nexus.

For the *Preempt* and *Preempt and Abort* service actions, this field contains:

*n* The reservation key of registrations to be removed

or

if this field also identifies a persistent reservation holder, the persistent reservation to be pre-empted.

SPEC_I_PT	Valid only for the <i>Register</i> and <i>Register and Ignore Existing Key</i> service actions. <ul style="list-style-type: none"> <li>0 The Additional Parameter Data is ignored and the registration is applied only to the I_T nexus that sent the command.</li> <li>1 The Additional Parameter Data includes a list of transport IDs and the device server applies the registration to the I_T nexus for every initiator port specified in the transport list.</li> </ul>
ALL_TG_PT	Not supported and ignored.
APTPL	Only valid for the <i>Register</i> and <i>Register and Ignore Existing Key</i> service actions.

This is a summary of the field validity in the parameter data:

Service Action	Scope	Type	Reservation Key	Service Actions Reservation Key	APTPL	SPEC_I_PT
Register	ignored	ignored	valid	valid	valid	valid
Register and Ignore Existing Key	ignored	ignored	ignored	valid	valid	valid
Reserve	LU_SCOPE	valid	valid	ignored	ignored	ignored
Release	LU_SCOPE	valid	valid	ignored	ignored	ignored
Clear	ignored	ignored	valid	ignored	ignored	ignored
Preempt	LU_SCOPE	valid	valid	valid	ignored	ignored
Preempt and Abort	LU_SCOPE	valid	valid	valid	ignored	ignored

### Additional parameter data

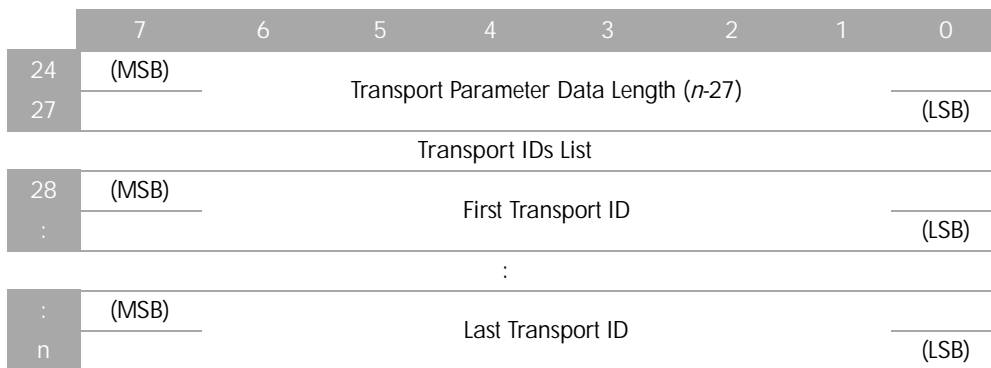

Transport Parameter Data Length Specifies the number of bytes of Transport IDs to follow. The Parameter List Length in the CDB contains all the bytes specified in Transport Parameter Data Length.

### Fibre Channel Transport ID

	7	6	5	4	3	2	1	0
0	Format Code (00b)		Reserved (0)		Protocol Identifier (0)			
1	Reserved (0)							
7	Reserved (0)							
8	(MSB)		World Wide Name				(LSB)	
15	Reserved (0)							
16	Reserved (0)							
23	Reserved (0)							

### Parallel SCSI Transport ID

	7	6	5	4	3	2	1	0
0	Format Code (00b)		Reserved (0)		Protocol Identifier (1h)			
1	Reserved (0)							
2	(MSB)		SCSI Address				(LSB)	
3	Reserved (0)							
4	(MSB)		Relative Port Identifier (0)				(LSB)	
7	Reserved (0)							
8	Reserved (0)							
23	Reserved (0)							



# PREVENT/ALLOW MEDIUM REMOVAL

1Eh

PREVENT/ALLOW MEDIUM REMOVAL tells the drive to enable or disable the removal of the cartridge.

When cartridge removal is prevented, the front panel eject button is completely disabled (though a 'forced eject' will still work). An Unload command issued by a host will result in CHECK CONDITION. The sense key will be ILLEGAL REQUEST or MEDIUM REMOVAL PREVENTED.

When cartridge removal is enabled, pressing the front panel eject button or sending an Unload command from a host will cause the media to be unloaded and ejected.

Removal prevention is on a per-host basis. All the hosts have to allow media removal for any of them to do so.

---

NOTE: If a firmware upgrade is initiated over any interface, the cartridge will be ejected from the drive regardless of the state of this command.

---

Pre-execution checks:

Illegal Field          Reservation          Deferred Error          Unit Attention

Command descriptor block:

	7	6	5	4	3	2	1	0
0	Operation Code (1Eh)							
1-3	Reserved (0)							
4	Reserved (0)						Prevent	
5	Control							

CDB fields:

---

Prevent	00b	Medium removal is allowed for the drive
	01b	Media removal is prohibited for the drive
	10b, 11b	Invalid

---

READ transfers zero or more data blocks to the host starting at the current logical position.

Pre-execution checks:

Illegal Field	Fixed Bit	Reservation	Deferred Error
Unit Attention	Media Access	Diagnostic Status	

If both the SILI and Fixed bits are set, CHECK CONDITION status is reported. Sense data is as described in the Illegal Field Checks. The field pointers indicate the Fixed bit field.

---

NOTE: Transfers of 4 bytes or less are not supported.

---

Command descriptor block:

	7	6	5	4	3	2	1	0
0	Operation Code (08h)							
1	Reserved(0)						SILI	Fixed
2	(MSB) _____							
4	Transfer Length _____ (LSB)							
5	Control							

CDB fields:

If the Fixed flag is clear and Transfer Length is not zero, then a single block of the length in Transfer Length is to be transferred. If the next block on tape is of this length or shorter it is transferred to the initiator. If the next block is longer than this length, only the length requested is returned and the logical position is set to after the record. If the length of the block was the same as the Transfer Length field, GOOD status is returned. If the length of the block was not the same as in Transfer Length and the Suppress Illegal Length Indicator (SILI) flag was clear, Check Condition status is returned, ILI will be reported as described below. If the length of the block was not the same as in Transfer Length and the Suppress Illegal Length Indicator (SILI) flag was set, Good status is returned.

If the fixed flag is set and the Transfer Length field is not zero and the Suppress Illegal Length Indicator (SILI) flag is clear, a sequence of blocks of the currently configured block length is to be returned, the number of blocks being indicated in the Transfer Length field. If there is a sequence of blocks of this length on the tape, they are returned to the initiator with GOOD status. If a block that is longer than the configured length is encountered before the sequence is complete, the blocks up to that block are returned followed by the configured length from the record that was too long and Check Condition status (ILI will be reported as described below). If a block that is shorter than the configured length is encountered before the sequence is complete, the blocks up to that block are returned followed by all of that block and Check Condition status (ILI will be reported as

described below). The current position is set after the last block that was returned or partially returned

SILI	<i>Suppress Incorrect Length Indicator</i>
	<p>0 The read operation is terminated when the length of a block (on the tape) differs from the Transfer Length. Transfer Length bytes of data will have been transferred. The logical tape position will be the EOM side of the illegal sized block.</p> <p>1 The drive will not report CHECK CONDITION status if the only error is that the Transfer Length is not equal to the actual block length recorded on the media.</p>
Fixed	<p>0 The Transfer Length field specifies the length of the transfer in bytes.</p> <p>A single block of the length in Transfer Length is to be transferred.</p> <ul style="list-style-type: none"> <li>• If the next block on tape is of Transfer Length, it is transferred to the initiator and GOOD status is returned.</li> <li>• If the next block on tape is not of Transfer Length:</li> <li>• If it is shorter, the whole block is transferred to the initiator.</li> <li>• If it is longer, only the length requested is returned and the logical position is set to after the record.</li> <li>• If SILI = 0, CHECK CONDITION status is returned. ILI is reported as described below.</li> <li>• If SILI = 1, GOOD status is returned.</li> </ul> <p>1 The Transfer Length field specifies the length of the transfer in blocks. The size of each block (in bytes) is specified by the current block length specified in the Mode Parameter block descriptor.</p> <p>If SILI = 0, a sequence of blocks of the currently configured block length is to be returned, the number of blocks being indicated in the Transfer Length field.</p> <ul style="list-style-type: none"> <li>• If there is a sequence of blocks of this length on the tape, they are returned to the initiator with GOOD status.</li> <li>• If a block that is shorter than the configured length is encountered before the sequence is complete, the blocks up to that block are returned followed by all of that block and CHECK CONDITION status (ILI will be reported as described below). The current position is set after the last block that was returned.</li> <li>• If a block that is longer than the configured length is encountered before the sequence is complete, the blocks up to that block are returned followed by the configured length from the record that was too long and CHECK CONDITION status (ILI will be reported as described below). The current position is set after the last block that was partially returned.</li> </ul>
Transfer Length	<p>0 No data is transferred. This is not considered an error and the current logical position will be unchanged.</p> <p>&gt;0 The amount of data to be transferred, in bytes or blocks as specified by the Fixed field.</p> <p>NOTE: Transfers of 4 bytes or less are not supported.</p>

## Read specific status:

Event	Status	Key	Notes
SILL error	CHECK COND'N	NO SENSE	ILI and Valid bits are set. The information bytes will be set as follows: <i>Variable Block Mode:</i> The difference between the requested Transfer Length and the actual block size. If the block size is bigger than the Transfer Length, this will be negative (twos complement). <i>Fixed Block Mode:</i> The difference between the requested number of records and the number of whole good records transferred. If the last record was under length, it is considered "whole good" for the purposes of this calculation.
Filemark encountered during a read	CHECK COND'N	NO SENSE	The Mark bit is set. Logical position will be on the EOM side of the filemark. Additional sense is 0001h (filemark detected). The logical position will be on the EOM side of the filemark. Residue information is as described below.
EOD encountered during a read	CHECK COND'N	BLANK CHECK	Additional sense is set to 0005h (EOD detected). Residue information is as described below.
EOP/M encountered during a read	CHECK COND'N	MEDIUM ERROR	The EOM bit is set. Additional sense is set to 0002h (EOP/M detected). Residue information is as described below.
Failure to read data through media error or non-fatal drive error	CHECK COND'N	MEDIUM ERROR	Additional sense is set to 1100h (unrecovered read error) or 3B00h (sequential positioning error). Residue information is as described below.
Corrupt data format	CHECK COND'N	MEDIUM ERROR	Additional sense set to 3002h (can't read media).
Blank media encountered during a read	CHECK COND'N	BLANK CHECK	Caused by an attempt to read an unformatted tape. Additional sense is set to 5000h (EOD not found). Residue information is as shown below.

NOTE: Early warning end of medium information is not reported on reads.

## Residue information:

The Valid bit will be set. The information bytes will be as follows:

Variable Block Mode	The requested transfer length (in bytes).
Fixed Block Mode	The difference (in blocks) between the requested transfer size and the actual number of blocks transferred. A partially transferred block is not counted, so for example, if 3.5 out of 10 blocks have been transferred the residue will be 7. If the last block is an illegal length block, it is not counted among those transferred. For example, if 4 legal length blocks and 1 illegal length block have been transferred out of a total of 10, the residue will be 6.

# READ 6 (CD-ROM mode)

08h

Transfer Length blocks of data are transferred to the host, starting from the current logical position specified by Logical Block Address. Any spacing performed to locate to the specified block address is performed with mark counting disabled.

Requests falling within the first 250 kilobytes of data on tape will be performed with very little delay (less than 2 seconds) because the drive caches this data at load time.

Pre-execution checks:

Illegal Field	Fixed Bit	Flag Link
Bad LUN	Reservation	Deferred Error
Unit Attention	Media Access	Diagnostic Status

Command descriptor block:

	7	6	5	4	3	2	1	0
0	Operation Code (08h)							
1	(MSB)		Logical Block Address				(LSB)	
3								
4	Transfer Length							
5	Control							

CDB fields:

Logical Block Address	Specifies the block address from which to read. The tape drive will space to this block before reading data.
Transfer Length	The number of blocks of data to return. Each CD-ROM block is 2048 bytes in size. This size is automatically set in the mode data's fixed block length while in CD-ROM mode.

Read 6 Specific status:

See the "Read specific status:" on page 108.

Residue Information:

See the "Residue information:" on page 108 for the normal Read command.

Transfer Length blocks of data are transferred to the host, starting from the current logical position specified by Logical Block Address. Any spacing performed to locate to the specified block address is performed with mark counting disabled.

Requests falling within the first 250 kilobytes of data on tape will be performed with very little delay (less than 2 seconds) because the drive caches this data at load time.

Pre-execution checks:

Illegal Field	Fixed Bit	Flag Link
Bad LUN	Reservation	Deferred Error
Unit Attention	Media Access	Diagnostic Status

Command descriptor block:

	7	6	5	4	3	2	1	0
0	Operation Code (28h)							
1	Logical Unit Number			DPO (0)	FUA (0)	Reserved (0)		RelAdr(0)
2	(MSB) _____ Logical Block Address _____ (LSB)							
5								
6	Reserved (0)							
7	(MSB) _____ Transfer Length _____ (LSB)							
8								
9	Control							

CDB fields:

Logical Block Address	Specifies the block address from which to read. The tape drive will space to this block before reading data.
Transfer Length	The number of blocks of data to return. Each CD-ROM block is 2048 bytes in size. This size is automatically set in the mode data's fixed block length while in CD-ROM mode.

Read 10 specific status:

See the "Read specific status:" on page 108.

Residue information:

See the "Residue information:" on page 108 for the normal Read command.

# READ ATTRIBUTE

# 8Ch

The READ ATTRIBUTE command allows an application client to read attribute values to MAM (Medium Auxiliary Memory). It should be executed before sending a WRITE ATTRIBUTE command.

Pre-execution checks:

Illegal Field      Deferred Error      Unit Attention      Media Access

In order to execute a READ ATTRIBUTE command, there must be a cartridge in the drive, even if it is only partially loaded, so that the MAM can be read.

Command descriptor block:

	7	6	5	4	3	2	1	0
0	Operation Code (8Ch)							
1	Reserved (0)				Service Action			
2	Reserved (0)							
4	Reserved (0)							
5	Volume Number (0)							
6	Reserved (0)							
7	Partition Number (0)							
8	(MSB)		First Attribute ID				(LSB)	
9								
10	(MSB)		Allocation Length				(LSB)	
13								
14	Reserved (0)							
15	Control							

CDB fields:

Service Action	Description	
Service Action	Service actions are defined as follows. The data returned for each Service Action is described below.	
Code	Name	Description
00h	Attribute Values	Returns the attribute values.
01h	Attribute List	Returns a list of attribute IDs that are available (both supported and existing IDs)
02h	Volume List	Returns a list of known volume numbers. For Ultrium drives, there is only a single volume, Volume 0.
03h	Partition List	Returns a list of known partition numbers. For Ultrium drives, there is only a single partition, Partition 0.
04h–1Fh	Reserved	

Element Address	Set to zero to indicate that Ultrium tapes only support a single element.
Element Type Code	Set to zero to indicate that Ultrium tapes only support a single element.
Volume Number	Set to zero to indicate that Ultrium tapes only support a single volume.
Partition Number	Set to zero to indicate that Ultrium tapes only support a single partition.
First Attribute ID	The identifier of the first attribute to be returned. This field is not checked if the Service Action value is 01h (Attribute List). If the attribute does not exist in MAM but there are more attributes available after it, the data returned will contain the values of those attributes. Otherwise CHECK CONDITION is returned with ILLEGAL REQUEST sense.
Allocation Length	The maximum amount of data (in bytes) that will be returned to the host. The drive will return the entire list of values or Allocation Length bytes, whichever is the lesser.

### Returned data for service actions:

#### Attribute Values service action

This service reads the values of attributes for the specified volume and partition, starting at the First Attribute ID. The attributes are returned in ascending numerical order. The format of the returned data is as follows:

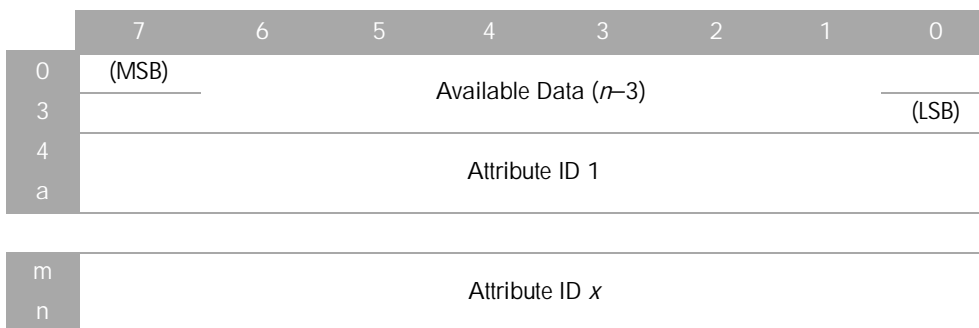

The Available Data field contains the number of bytes of attribute values returned. Even if the data returned has to be truncated because the Allocation Length is too small, the contents of the Available Data field remain the same.

For details of the available attributes and the format of the data returned for each, see "MAM attribute data" on page 115.



### Attribute List service action

This service action is used to retrieve the identifiers of all the attributes that are supported and exist. The First Attribute ID field in the CDB is ignored. The attribute identifiers are returned in ascending numerical order. The format of the returned data is as follows:

	7	6	5	4	3	2	1	0
0	(MSB)		Available Data ( $n-3$ )				(LSB)	
3								
4	Attribute ID 1							
a								
:								
m	Attribute ID $x$							
n								

The Available Data field specifies the number of bytes of attribute ID data returned. Even if the data returned has to be truncated because the Allocation Length is too small, the contents of the Available Data field remain the same.

A two-byte Attribute ID is returned for each attribute available on MAM. See “Attribute ID values” on page 116 for a description of the Attribute ID values.

### Partition List service action

The Partition List service action is used to report the number of partitions supported in the specified volume, which in the case of Ultrium drives is 1. The Partition Number and Attribute fields in the CDB are ignored. The information returned is as follows:

	7	6	5	4	3	2	1	0
0	(MSB)		Available Data (2)				(LSB)	
1								
2	First Partition Number (0)							
3	Number of Partitions Available (1)							

The First Partition Number is the first partition available on the specified volume. Since Ultrium drives do not support multiple partitions, this is 0.

The Number of Partitions Available indicates the number of partitions available on the specified volume. Since Ultrium drives do not support multiple partitions, this is 1.

## Volume List service action

The Volume List service action is used to report the number of volumes that the device server supports, which in the case of Ultrium drives is 1. The Volume Number, Partition Number and Attribute fields in the CDB are ignored. The information returned is as follows:

	7	6	5	4	3	2	1	0	
0	(MSB)								
1	Available Data (2)								(LSB)
2	First Volume Number (0)								
3	Number of Volumes Available (1)								

The First Partition Number is the first volume. Since Ultrium drives do not support multiple volumes, this is 0.

The Number of Volumes Available indicates the number of partitions available. Since Ultrium drives do not support multiple volumes, this is 1.

## Read Attribute specific status:

The command will be terminated and will return CHECK CONDITION under the following circumstances:

Description	Sense Key	Additional Sense
There is no cartridge present in the drive, not even partially loaded.	NOT READY	3A00h (medium not present)
The MAM is not accessible even though there is a tape in the drive.	MEDIUM ERROR	0410h (MAM not accessible)
The MAM has failed (for example from a bad checksum).	MEDIUM ERROR	1112h (MAM read error)
The combination of Volume Number and Partition Number is not valid.	ILLEGAL REQUEST	2400h (invalid field in CDB)
The Service Action field does not match a supported Service Action ID.	ILLEGAL REQUEST	2400h (invalid field in CDB)
The First Attribute ID field does not match a supported First Attribute ID.	ILLEGAL REQUEST	2400h (invalid field in CDB)

## MAM attribute data

Attribute data sent with a WRITE ATTRIBUTE command or returned in response to a READ ATTRIBUTE command has the following format:

	7	6	5	4	3	2	1	0
0	(MSB) Attribute Identifier							(LSB)
1								
2	Read-Only	Reserved (0)				Format		
3	(MSB) Attribute Length ( $n-4$ )							(LSB)
4								
5	(MSB) Attribute Value							(LSB)
n								

The format implies nothing about the physical representation of the data in the Medium Auxiliary Memory.

Attribute Identifier	The binary identifier for a single attribute. See "Attribute ID values" on page 116 for a description of attribute ID values.										
Read-Only	Specifies whether an attribute is read-only. The bit is ignored by the READ ATTRIBUTE command. <ul style="list-style-type: none"> <li>0 The attribute may be changed by the WRITE ATTRIBUTE command.</li> <li>1 The attribute cannot be changed by WRITE ATTRIBUTE.</li> </ul>										
Format	Specifies the data format of the attribute. The possible values are: <table border="1" data-bbox="454 968 1310 1258"> <thead> <tr> <th>Value</th> <th>Description</th> </tr> </thead> <tbody> <tr> <td>00b</td> <td>Binary. The attribute contains binary data.</td> </tr> <tr> <td>01b</td> <td>ASCII. Attributes contain only graphic codes (code values 20h–7Eh). It must be left-aligned and contain 20h (ASCII space) in any unused bytes.</td> </tr> <tr> <td>10b</td> <td>Text. The attribute contains textual data. The character set is as described in the Text Localization Identifier attribute in "Standard host type attributes" on page 118.</td> </tr> <tr> <td>11b</td> <td>Reserved.</td> </tr> </tbody> </table>	Value	Description	00b	Binary. The attribute contains binary data.	01b	ASCII. Attributes contain only graphic codes (code values 20h–7Eh). It must be left-aligned and contain 20h (ASCII space) in any unused bytes.	10b	Text. The attribute contains textual data. The character set is as described in the Text Localization Identifier attribute in "Standard host type attributes" on page 118.	11b	Reserved.
Value	Description										
00b	Binary. The attribute contains binary data.										
01b	ASCII. Attributes contain only graphic codes (code values 20h–7Eh). It must be left-aligned and contain 20h (ASCII space) in any unused bytes.										
10b	Text. The attribute contains textual data. The character set is as described in the Text Localization Identifier attribute in "Standard host type attributes" on page 118.										
11b	Reserved.										
Attribute Length	The length in bytes of the Attribute Value field.										

## Attribute ID values

Attributes can be Standard or Vendor-Unique. There are three groups of attributes: Device, Medium and Host attributes. Each group has a list of attributes, which characterize the group:

Attribute ID	Attribute Type	Standard/Vendor-Unique	Read-Only
0000h–03FFh	Device	Standard	Yes
0400h–07FFh	Medium	Standard	Yes
0800h–0BFFh	Host	Standard	No
0C00h–0FFFh	Device	Vendor-Unique	Yes
1000h–13FFh	Medium	Vendor-Unique	n/a
1400h–17FFh	Host	Vendor-Unique	No
1800h–FFFFh	Reserved		

WRITE ATTRIBUTES commands are only accepted for Host type attributes (either Standard or Vendor-Unique).

Trying to read or write Device or Medium type Vendor-Unique attributes will fail and CHECK CONDITION status is reported. Sense data will be as described in the Illegal Field Checks.

## Standard device type attributes

ID	Attribute	Size (bytes)	Format
0000h	Remaining capacity in partition	8	Binary
0001h	Maximum capacity in partition	8	Binary
0002h	TapeAlert flags	8	Binary
0003h	Load count	8	Binary
0004h	MAM space remaining	8	Binary
0005h	Assigning organization	8	ASCII
0006h	Formatted density code	1	Binary
0007h–0209h	Reserved		
020Ah	Device make/serial number at last load	40	ASCII
020Bh	Device make/serial number at load -1	40	ASCII
020Ch	Device make/serial number at load -2	40	ASCII
020Dh	Device make/serial number at load -3	40	ASCII
020Eh–021Fh	Reserved		
0220h	Total MB written in medium life	8	Binary
0221h	Total MB read in medium life	8	Binary
0222h	Total MB written in current/last load	8	Binary
0223h	Total MB read in current/last load	8	Binary

ID	Attribute	Size (bytes)	Format
0224h-03FFh	Reserved		
Remaining capacity in partition <i>and</i> Maximum capacity in partition		Native capacities in MB, assuming no data compression.	
TapeAlert flags	The bits specify flags that were set during the previous load. 1 bit per flag (MSB = flag 1, LSB = flag 64).		
Load count	The number of times this tape has been fully loaded. It is never reset.		
MAM space remaining	<p>The space currently free in the MAM. The total MAM capacity is reported in the MAM Capacity attribute defined in "Standard medium type attributes" on page 118.</p> <p>Note that it may not always be possible to use all the free space in a given MAM implementation. Depending on the internal organization of the memory and the software that controls it, fragmentation issues may mean that certain attribute sizes might not be fully accommodated as the MAM nears its maximum capacity.</p>		
Assigning organization	The Vendor ID of the organization that will define attribute 0006h. It contains the string "LTO-CVE".		
Formatted density code	The medium density code.		
Device make/serial number at last load <i>and</i> Device make/serial number at load <i>-n</i>	These attributes provide a rolling history of the last four device servers in which the tape has been loaded. The format of the attributes is as follows:		

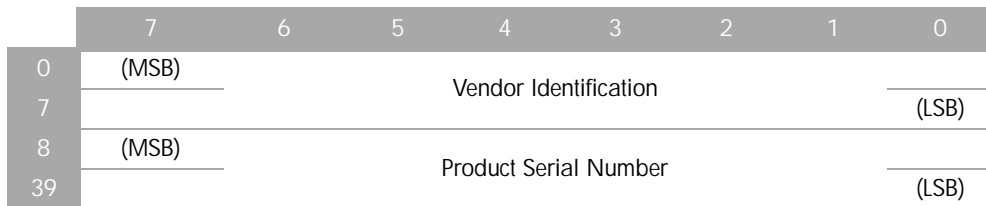

Vendor Identification	The same value as is returned in the SCSI INQUIRY command by the device server, padded with ASCII spaces (20h).
Product Serial Number	Vendor-assigned serial number, padded with ASCII spaces (20h).

Total MB written in medium life <i>and</i> Total MB read in medium life	The total number of data bytes written to or read from the tape (after any data compression has been applied) over the entire tape life. These figures are cumulative and will never be reset.
Total MB written in current/last load <i>and</i> Total MB read in current/last load	These are similar to the attributes above but apply to the current load (if the tape is currently loaded) or the last load (if the tape is currently unloaded). The device server should reset these attributes to zero when the tape is loaded.

## Standard medium type attributes

ID	Attribute	Size (bytes)	Format	Description
0400h	Medium manufacturer	8	ASCII	The name of the manufacturer.
0401h	Medium serial number	8	ASCII	The serial number, left-aligned and padded with ASCII spaces (20h).
0402h	Medium length	4	Binary	The length of the tape in meters. A value of 0 means the length is undefined.
0403h	Medium width	4	Binary	127 The width of the tape in mm
0404h	Assigning organization	8	ASCII	Contains the string "LTO-CVE".
0405h	Medium density code	1	Binary	The tape density code.
0406h	Medium manufacturer date	8	ASCII	The date of manufacture in the format YYYYMMDD.
0407h	MAM capacity	8	Binary	The total capacity of the MAM, not its free space.
0408h	Medium type	1	Binary	The type of tape: 0 Data cartridge 1 Cleaning cartridge Other values are reserved.
0409h	Medium type information	2	Binary	Only meaningful for a cleaning cartridge, where it gives the maximum number of cleaning cycles permitted.
040Ah – Reserved 07FFh				

## Standard host type attributes

These only exist if they are initialized by an application:

ID	Attribute	Size (bytes)	Format	Description
0800h	Application vendor	8	ASCII	
0801h	Application name	32	ASCII	
0802h	Application version	8	ASCII	
0803h	User medium text label	160	Text	The user level identifier for the tape.
0804h	Data and time last written	12	ASCII	Format is YYYYMMDDHHMM (0–24 hours)
0805h	Text localization identifier	1	Binary	Defines the character set for the attributes defined as "text". See the table below.
0806h	Barcode	32	ASCII	Allows an application server to store the contents of a barcode associated with the medium in the MAM. Format is YYYYMMDD.

ID	Attribute	Size (bytes)	Format	Description
0807h	Owning host textual name	80	Text	The host server from which the User Medium Text Label originates.
0808h	Media pool	160	Text	Indicates the media pool to which this tape belongs.
0809h	Partition user text label*	16	ASCII	Identifier for the partition specified in the CDB.
080Ah	Load/unload at partition*	1	Binary	0 The load or unload occurs at the beginning of the tape. This is the default setting if the attribute does not exist. 1 Loads and unloads at the partition specified in the CDB are allowed
080Bh	Application format version	16	ASCII	
080Ch– BFFh	Reserved			

\*0809h and 080Ah are optional for LTO drives because they only support a single partition.

#### Text localization indentifiers

The Text Localization Identifier defines the character set used for attributes with a text format:

ID	Format
00h	No code specified (ASCII)
01h	ISO/IEC 8859-1 (Europe, Latin America)
02h	ISO/IEC 8859-2 (Eastern Europe)
03h	ISO/IEC 8859-3 (SE Europe/miscellaneous)
04h	ISO/IEC 8859-4 (Scandinavia/Baltic)
05h	ISO/IEC 8859-5 (Cyrillic)
06h	ISO/IEC 8859-6 (Arabic)
07h	ISO/IEC 8859-7 (Greek)
08h	ISO/IEC 8859-8 (Hebrew)
09h	ISO/IEC 8859-9 (Latin 5)
0Ah	ISO/IEC 8859-10 (Latin 6)
0Bh–7Fh	Reserved
80h	ISO/IEC 10646 (Unicode)
81h	ISO/IEC 10646 -1, Amendment no. 2 (UTF-8)
82h–FFh	Reserved

# READ BLOCK LIMITS

05h

READ BLOCK LIMITS tells the drive to return data defining the maximum block size that it can support. Note that this is the maximum supportable, not the fixed block size.

Pre-execution checks:

Illegal Field      Reservation      Deferred Error      Unit Attention

Command descriptor block:

	7	6	5	4	3	2	1	0
0	Operation Code (05h)							
1	Reserved (0)							
4	Control							
5	Control							

Read Block Limits data:

	7	6	5	4	3	2	1	0	
0	00h								
1	(MSB)	Maximum Block Length							
2		(FFFFFh)							
3								(LSB)	
4	(MSB)	Minimum Block Length (0001h)							
5								(LSB)	



READ BUFFER reads data from the memory on the drive and sends it to the initiator. The value of the Mode field determines whether only the 4-byte descriptor is returned, only the data is returned, or whether both are returned.

Pre-execution checks:

Illegal Field                  Reservation                  Deferred Error                  Unit Attention

If any of the following rules are broken then CHECK CONDITION status is reported. Sense data will be as described in Illegal Field Checks.

Command descriptor block:

	7	6	5	4	3	2	1	0
0	Operation Code (3Ch)							
1	Reserved(0)			Mode				
2	Buffer ID							
3	(MSB)	Buffer Offset						(LSB)
5								
6	(MSB)	Allocation Length						(LSB)
8								
9	Control							

CDB fields:

Mode	00000b	A 4-byte descriptor is returned, followed by ( <i>Allocation Length</i> – 4) bytes of data. The data is read from the buffer identified by the Buffer ID, starting from offset zero in the buffer. The Buffer ID and Buffer Offset must both be 00h.												
	00010b	The drive returns Allocation Length bytes of data which is read from the buffer identified by the Buffer ID, starting from Buffer Offset bytes from the start of the buffer. There are no restrictions on the value of Buffer ID and Buffer Offset, except that the Buffer Offset must be kept within the buffer size.												
	00011b	The drive returns a 4-byte descriptor for the buffer identified by the Buffer ID field. Invalid buffer IDs will return a buffer descriptor of all zeros. The Buffer Offset field must be zero.												
	01010b	The drive returns data from the Echo Buffer. The Buffer ID and Offset are ignored.												
	01011b	The drive returns the Echo Buffer descriptor. The Buffer ID and Offset are ignored.												
Buffer ID	The Buffer ID indicates which buffer is to be read. The buffers are defined as follows:													
	<table border="1"> <thead> <tr> <th>Buffer ID</th> <th>Memory Area</th> <th>Category</th> <th>Offset Boundary</th> </tr> </thead> <tbody> <tr> <td>00h</td> <td>Main buffer memory</td> <td>RAM</td> <td>4 bytes</td> </tr> <tr> <td>01h</td> <td>Processor addressable memory</td> <td>RAM</td> <td>1 byte</td> </tr> </tbody> </table>	Buffer ID	Memory Area	Category	Offset Boundary	00h	Main buffer memory	RAM	4 bytes	01h	Processor addressable memory	RAM	1 byte	
Buffer ID	Memory Area	Category	Offset Boundary											
00h	Main buffer memory	RAM	4 bytes											
01h	Processor addressable memory	RAM	1 byte											

02h	SCSI burst buffer	RAM	4 bytes	
10h	CM EEPROM	EEPROM	1 byte	
11h	Mechanical EEPROM	EEPROM	1 byte	
12h	Head assembly EEPROM	EEPROM	1 byte	
13h	PCA EEPROM	EEPROM	1 byte	
20h	Main buffer segment 0	RAM	4 bytes	<i>see below for details</i>
21h	Main buffer segment 1	RAM	4 bytes	<i>see below for details</i>
22h	Main buffer segment 2	RAM	4 bytes	<i>see below for details</i>
23h	Main buffer segment 3	RAM	4 bytes	<i>see below for details</i>
24h	Main buffer segment 4	RAM	4 bytes	<i>see below for details</i>
25h	Main buffer segment 5	RAM	4 bytes	<i>see below for details</i>
26h	Main buffer segment 6	RAM	4 bytes	<i>see below for details</i>
27h	Main buffer segment 7	RAM	4 bytes	<i>see below for details</i>

**Buffer Offset** The Buffer Offset field may be set to any address in the buffer, but must obey the specified Offset Boundary.

**Allocation Length** The amount of data to return. Allocation Length + Buffer Offset must be within the buffer size.

## Memory sizes:

**Main Buffer Memory** Size: 128 MB, reported size FFFFFFFh.  
Because the buffer is greater than 16 MB, additional buffer IDs have been defined to allow the buffer to be accessed in 16 MB segments. these are as follows:

Buffer ID	Address
20h	00000000h + Buffer Offset (same as Buffer ID 00h)
21h	01000000h + Buffer Offset (in other words, +16 MB)
22h	02000000h + Buffer Offset (in other words, +32 MB)
23h	03000000h + Buffer Offset (in other words, +48 MB)
24h	04000000h + Buffer Offset (in other words, +64 MB)
25h	05000000h + Buffer Offset (in other words, +80 MB)
26h	06000000h + Buffer Offset (in other words, +96 MB)
27h	07000000h + Buffer Offset (in other words, +112 MB)

**Processor Memory** Not all of the Processor Memory space is accessible. The following table shows valid address segments:

Segment Start Address	Segment Size	Segment Description
100000h	100000h	External flash
200000h	80000h	External SRAM (if fitted)
380000h	80000h	Formatter ASIC

	400000h	40000h	Servo Controller ASIC
	FF8000h	7000h	Controller internal SRAM
SCSI Burst Buffer	3F8000h bytes		
LTO-Cartridge Memory	Size = 4 KB		
Mechanism EEPROM	Size = 8 KB		
Head Assembly EEPROM	Size = 16 KB		
PCA EEPROM	Size = 32 KB		

Returned data:

The format of the 4-byte descriptor for Mode 00000b is as follows:

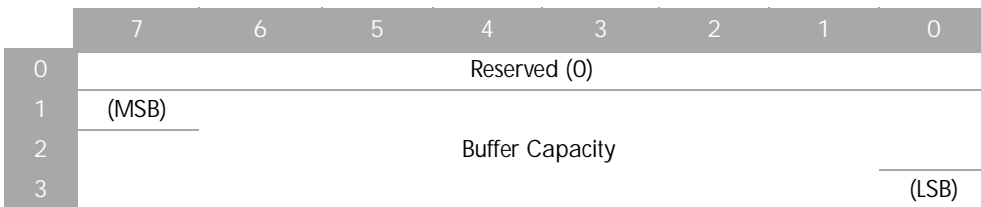

The format of the 4-byte descriptor for Mode 00011b is as follows:

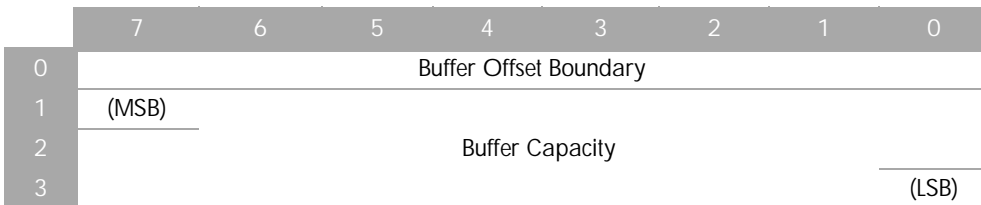

The format of the 4-byte Echo buffer descriptor for Mode 01011b is as follows:

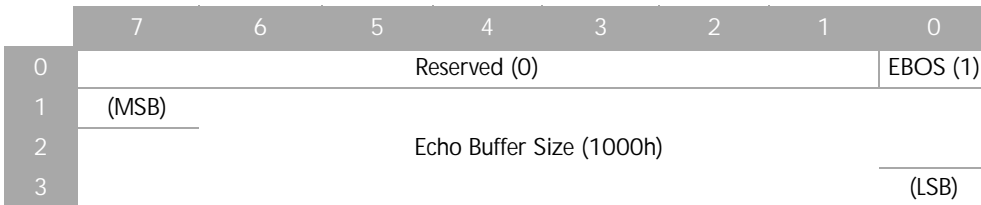

# READ CAPACITY (CD-ROM mode)

25h

READ capacity transfers Read Capacity data to the host.

Pre-execution checks:

Illegal Field	Fixed Bit	Flag Link	Bad LUN
Reservation	Deferred Error	Unit Attention	

If the drive is not in CD-ROM mode, the request will return CHECK CONDITION status with a sense key Illegal Command.

Command descriptor block:

	7	6	5	4	3	2	1	0
0	Operation Code (25h)							
1	Logical Unit Number			Reserved (0)				RelAdr(0)
2	(MSB)							
5	Logical Block Address (0)							
	(LSB)							
6	Reserved (0)							
7	Reserved (0)							
8	Reserved (0)						PMI	
9	Control							

CDB fields:

---

Logical Block Address This flag is ignored. It is recommended that it should be zero.

---

PMI This flag is ignored. It is recommended that it should be zero.

---

## Read Capacity data

The following data is always returned:

	7	6	5	4	3	2	1	0
0	(MSB)							
3	Returned Logical Block Address							
	(0004B000h)							
	(LSB)							
4	(MSB)							
7	Block Length in bytes							
	(00000800h)							
	(LSB)							

# READ MEDIA SERIAL NUMBER

ABh

READ MEDIA SERIAL NUMBER provides a method for the host application to read the serial number of the cartridge currently loaded in the drive.

Pre-execution checks:

Illegal Field      Reservation      Deferred Error      Unit Attention      Media Access

Command descriptor block:

	7	6	5	4	3	2	1	0
0	Operation Code (ABh)							
1	Reserved(0)				Service Action (01h)			
2	Reserved (0)							
6	(MSB)		Allocation Length				(LSB)	
9								
10	Reserved(0)							
11	Control							

CDB fields:

Service Action	01h	The Service Action must be set to 01h.
Allocation Length		The maximum amount of data (in bytes) to be returned to the host. The drive will return the entire serial number string or allocation length bytes, whichever is least.

If there is no cartridge in the drive, the command is terminated with CHECK CONDITION status. The sense key is set to NOT READY with additional sense of 3A00h (medium not present).

Returned data:

The data returned depends on whether a barcode number has been stored in the LTO-CM using the WRITE ATTRIBUTE command. Storing this is the responsibility of the library controller or host application.

No barcode stored:

	7	6	5	4	3	2	1	0
0	(MSB)	Serial Number Length (0Ch)						(LSB)
3								
4	(MSB)	Cartridge Serial Number						(LSB)
13								
14	(MSB)	ASCII NUL characters (00h)						(LSB)
15								

---

Cartridge Serial Number    The serial number of 10 ASCII characters stored in the LTO-CM Cartridge Manufacturer's Information page.

---

Barcode stored:

	7	6	5	4	3	2	1	0
0	(MSB)	Serial Number Length (2Ch)						(LSB)
3								
4	(MSB)	Cartridge Serial Number						(LSB)
13								
14	(MSB)	ASCII Space characters (20h)						(LSB)
15								
16	(MSB)	Barcode Number						(LSB)
47								

---

Barcode Number    The barcode number of 32 ASCII characters stored in the LTO-CM Application Specific page.

---

# READ POSITION

34h

The READ POSITION command returns data representing the current logical position to the host. The position is the count of all marks and blocks between BOM and the current logical position. The first block is block 0.

The command causes no tape movement.

The Read Position command is complimented by the LOCATE command.

Pre-execution checks:

Illegal Field	Reservation	Deferred Error
Unit Attention	Media Access	Diagnostic Status

Command descriptor block:

	7	6	5	4	3	2	1	0
0	Operation Code (34h)							
1	Reserved(0)				Service Action			
2	Reserved (0)							
6	Allocation Length							
7	Control							
8								
9								

CDB fields:

---

Service Action	<i>The following values are supported:</i> 00h Short Form Block ID 06h Long Form 08h Extended Form
----------------	---

---

Allocation Length	For Service Actions 00h and 06h, must be 0.
-------------------	---

---

## Short Form Block ID

	7	6	5	4	3	2	1	0
0	BOP	EOP	LOCU (1)	BYCU (1)	Rsvd (0)	LOLU (0)	PERR	Rsvd (0)
1	Partition Number (0)							
2	Reserved (0)							
3	Reserved (0)							
4	(MSB)	First Block Location						(LSB)
7								
8	(MSB)	Last Block Location <i>(same as First Block Location)</i>						(LSB)
11								
12	Reserved (0)							
13	(MSB)	Number of blocks in buffer (0)						(LSB)
15								
16	(MSB)	Number of bytes in buffer (0)						(LSB)
19								

### Returned data fields:

BOP	0	The current logical position is <i>not</i> at BOM (beginning of media).
	1	The current logical position is at BOM.
EOP	1	The current logical position is within the EW-EOM region.
LOCU	1	The number of blocks in the buffer is unknown.
BYCU	1	The number of bytes in the buffer is unknown.
LOLU	0	The Partition Number, First Block Location and Last Block Location fields are valid.
PERR	0	No position error
	1	There has been a position error caused by the overflow of some position field data.
Partition Number	This will always be zero.	
First Block Location	The number of blocks and filemarks from BOM to the current position. Counting starts at zero, so BOM is block location 0.	
Last Block Location	Always set to the value of the First Block Location.	



## Long Block Form ID

	7	6	5	4	3	2	1	0
0	BOP	EOP	Reserved (0)		MPU	LONU (0)	Reserved (0)	
1	Reserved (0)							
3								
4	(MSB)	Partition Number (0)						(LSB)
7								
8	(MSB)	Block Number						(LSB)
15								
16	(MSB)	File Number						(LSB)
23								
24	(MSB)	Set Number(0)						(LSB)
31								

Returned data fields:

MPU	Mark Position Unknown
	0 The File Number and Set Number fields are valid.
LONU	0 The Partition Number and Block Number are valid.
Partition Number	This will always be zero because Ultrium drives do not support multiple partitions.
Block Number	The number of logical blocks between BOP (beginning of partition) and the current logical position. Filemarks count as one logical block each.
File Number	The number of filemarks between BOP and the current logical position.
Set Number	The number of setmarks between BOP and the current logical position.

## Extended Block Form ID

	7	6	5	4	3	2	1	0
0	BOP	EOP	LOCU (1)	BYCU (1)	Rsvd (0)	LOLU (0)	Reserved (0)	
1	Partition Number (0)							
2	Additional Length (1Ch)							
3	Additional Length (1Ch)							
4	Reserved (0)							
5	(MSB)	Number of blocks in buffer (0)						(LSB)
7	Number of blocks in buffer (0)							
8	(MSB)	First Block Location						(LSB)
15	First Block Location							
16	(MSB)	Last Block Location						(LSB)
23	Last Block Location (same as First Block Location)							
24	(MSB)	Number of bytes in buffer (0)						(LSB)
31	Number of bytes in buffer (0)							

READ TOC transfers the Table of Contents data to the host.

Pre-execution checks:

Illegal Field	Fixed Bit	Flag Link
Bad LUN	Reservation	Deferred Error
Unit Attention	Media Access	Diagnostic Status

If the drive is not in CD-ROM mode, the request will return CHECK CONDITION status with a sense key Illegal Command.

The Track/Session Number must be set to 0 or 1. Any other value will result in CHECK CONDITION status with sense data as described in Illegal Field Checks.

Command descriptor block:

	7	6	5	4	3	2	1	0
0	Operation Code (43h)							
1	Logical Unit Number			Reserved (0)			MSF	RelAdr(0)
2	Reserved (0)				Format (0)			
3	(MSB)	Reserved (0)						(LSB)
5								
6	Track/Session Number							
7	(MSB)	Allocation Length						(LSB)
8								
9	Control							

CDB fields:

MSF	This flag is ignored.
Track/Session Number	This may be set to 0 or 1. It does not affect the data returned.
Allocation Length	The maximum number of data bytes that may be returned.

## Read TOC data

The following data is always returned:

	7	6	5	4	3	2	1	0
0	(MSB)	TOC Data Length (12h)						(LSB)
1								
2	First Track Number (1)							
3	Last Track Number (1)							
4	Reserved (0)							
5	ADR (1)				Control (4)			
6	Track Number (1)							
7	Reserved (0)							
8	(MSB)	Logical Block Address						(LSB)
11	(00000000h)							
12	Reserved (0)							
13	ADR (1)				Control (4)			
14	Track Number (AAh)							
15	Reserved (0)							
16	(MSB)	Logical Block Address						(LSB)
19	(0004B000h)							

# RECEIVE DIAGNOSTICS RESULTS

1Ch

RECEIVE DIAGNOSTIC RESULTS tells the drive to return data from the last diagnostic test requested through the SEND DIAGNOSTIC command. If none has been sent, the data refers to the power-on self-test.

Pre-execution checks:

Illegal Field          Reservation          Deferred Error          Unit Attention

Command descriptor block:

	7	6	5	4	3	2	1	0
0	Operation Code (1Ch)							
1	Reserved(0)							PCV
2	Page Code							
3	(MSB)	Allocation Length						(LSB)
4								
5	Control							

CDB fields:

PCV	The page code valid flag is ignored.	
Page Code	0	Identifier for the diagnostic information page to be returned.
Allocation Length	0	No data will be returned. This is not considered an error. The drive will return allocation length bytes or the amount of data that is available, whichever is least.
	>0	The number of bytes which the host has allocated for returned diagnostic data.

Specific status:

If the drive not is connected to a compatible enclosure, a RECEIVE DIAGNOSTIC command with a Enclosure Services page number (01 to 0F) will return a CHECK CONDITION with Sense key of NOT READY and additional sense of 3502h, "enclosure services unavailable".

If other invalid pages are requested, CHECK CONDITION will result with status of ILLEGAL REQUEST and additional sense of 2601h, "parameter not supported".

## Data returned

### Page code 70h — Self-Test (Read/Write)

*Page Format for Write:*

	7	6	5	4	3	2	1	0
0	Page Code (70h)							
1	Reserved (0)							
2	(MSB)	Parameter List Length (0)						(LSB)
3								

No parameters are needed. Sending this page is equivalent to a Send Diagnostic command with both the SelfTest and UnitOfI bits set.

*Page format for Read:*

	7	6	5	4	3	2	1	0
0	Page Code (70h)							
1	Reserved (0)							
2	(MSB)	Parameter List Length (4)						(LSB)
3								
4	(MSB)	Error Code						(LSB)
7								

# RELEASE UNIT

17h/57h

RELEASE UNIT enables the host to release any reservation it may have on the drive. Reserving a device is a way of ensuring exclusive access to that device from a single initiator for the period of the reservation. The drive may be reserved using a RESERVE command.

Pre-execution checks:

Illegal Field      Deferred Error      Unit Attention

Command descriptor block:

6-byte

	7	6	5	4	3	2	1	0
0	Operation Code (17h)							
1	Reserved (0)			3rd Pty	Third-Party Device ID			Rsvd(0)
2	Reserved (0)							
4	Reserved (0)							
5	Control							

3rdPty      This bit is always zero because third-party reservation is not supported.

Third-Party Device ID      This bit is always zero because third-party reservation is not supported.

10-byte

	7	6	5	4	3	2	1	0
0	Operation Code (57h)							
1	Reserved (0)			3rd Pty	Reserved (0)		LongID	Rsvd(0)
2	Reserved (0)							
3	Third-Party Device ID							
4	Reserved (0)							
6	Reserved (0)							
7	(MSB)	Parameter List Length						(LSB)
8	Parameter List Length							
9	Control							

10-byte only

3rd Pty      0      Third-party release is not requested.  
                  1      The initiator requests third-party release. The value in the Third-Party Device ID field is valid.

---

LongID	This is always zero because device IDs greater than 255 are not supported.
Third-Party Device ID	<p>This is required and used only when the 3rd Pty bit is set. The device will perform the release operation only if the initiator ID, the 3rd Pty bit and the Third-Party Device ID are identical to those in the RESERVE UNIT command that established the reservation.</p> <p>The drive ignores any attempt to release the reservation made by any other initiator, including the initiator for which the reservation was made.</p> <p>If an initiator reserved the drive using a third-party reservation over itself, a non-third-party RELEASE UNIT command could also release the reservation.</p>

---

### Release Unit specific status:

Status is returned as follows:

- If the drive is not reserved, GOOD status is reported.
- If the drive is reserved by another host, GOOD status is reported.
- If the drive is reserved by this host for this host, the reservation status is cleared.



# REPORT DENSITY SUPPORT

44h

The Report Density Support command returns details about the tape formats supported by the drive.

The data is returned as a header and a series of descriptor blocks.

## Pre-execution checks

Illegal Field      Deferred Error      Unit Attention

## Command descriptor block

	7	6	5	4	3	2	1	0
0	Operation Code (44h)							
1	Reserved (0)							Media
2	Reserved (0)							
6	Reserved (0)							
7	(MSB)	Allocation Length						(LSB)
8	Reserved (0)							
9	Control							

## CDB fields

Media	0	One descriptor block is returned for each format supported by the drive. The capacity field in the descriptor block will indicate the capacity of the current media.
	1	One descriptor block is returned with the data for the currently loaded tape. The capacity field will indicate the maximum for the format. If there is no tape inserted in the drive, the drive will return CHECK CONDITION with a sense key of NOT READY and additional sense of 3A 00h (medium not present).
Allocation Length		This specifies the maximum number of bytes which the drive should return in its data-out phase. Either the entire available data or allocation length bytes of the page are returned, whichever is least.
	0	No data transfer will occur. This is not considered an error.

## Header

	7	6	5	4	3	2	1	0
0	(MSB)	Available Density Descriptor Length						(LSB)
1	Reserved (0)							
2	Reserved (0)							
3	Reserved (0)							

The available length gives the total amount of data available to be returned.

## Descriptor blocks

The header is followed by one or more Report Density Support descriptor blocks with the following format:

	7	6	5	4	3	2	1	0
0	Primary Density Code							
1	Secondary Density Code							
2	WRTOK	DUP (0)	DEFLT	Reserved (0)				
3	Reserved (0)							
4	Reserved (0)							
5	(MSB)	Bits per mm						(LSB)
7								
8	(MSB)	Media Width						(LSB)
9								
10	(MSB)	Tracks						(LSB)
11								
12	(MSB)	Capacity (MB)						(LSB)
15								
16	(MSB)	Assigning Organization (LTO-CVE)						(LSB)
23								
24	(MSB)	Density Name						(LSB)
31								
32	(MSB)	Description						(LSB)
51								

The values reported for Ultrium 3 format tapes are as follows:

Primary Density Code	44h	This is reported via the Mode Sense command.
Secondary Density Code	44h	Not used
WRTOK	The Write OK flag indicates whether the drive can write at the density indicated by the Density Code.	
	0	The drive does not support writing to a tape with this density.
	1	The drive is capable of writing at this density to the current tape (if the Media bit in the CDB = 1) or for some tape (if Media = 0).
DUP	The Duplicate flag will be set to zero for every descriptor block indicating that each density is only reported once.	
DEFLT	The Default flag will be set for the density for which the currently mounted medium is formatted and clear for all other densities.	
Bits per mm	4880	

Media Width	127	Tape width is 1/2" or 12.65 mm. The value in this field is in tenths of millimeters rounded to the nearest 0.1 mm.
Tracks	704	
Capacity	400,000 MB	The maximum capacity for the format (or the capacity of the media if the Media bit is set)
Assigning Organization	LTO-CVE	The CVE assigns these codes.
Density Name	U-316	The format of this is: [U/A]-[Format Generation: 1,2...][No of Tracks: 4,8,16...]
Description	Ultrium 3/16T	A longer version of the above

If this command is sent to the HP Ultrium 3 drive with the Media bit set to 0, three descriptor blocks will be returned with key values as follows:

Density Code	WRTOK	DEFLT	Capacity
40h	0	0	186A0h
42h	1	0	30D40h
44h	1	1	61A80h

# REPORT DEVICE IDENTIFIER

A3h

## Description:

The REPORT DEVICE IDENTIFIER command returns the identifier of the current device to the initiator.

## Pre-execution checks:

Illegal Field      Reservation      Deferred Error      Unit Attention

## Command descriptor block:

	7	6	5	4	3	2	1	0
0	Operation Code (A3h)							
1	Reserved (0)				Service Action (05h)			
2	Reserved (0)							
5	Reserved (0)							
6	(MSB) _____ Allocation Length _____ (LSB)							
9	_____							
10	Reserved (0)							
11	Control							

## CDB fields:

---

**Allocation Length**      The number of bytes that have been allocated for the Device Identifier The actual number returned will be the lower of the stored Device Identifier length and the allocation length specified in this command.

---

## Data returned:

The returned Parameter Data is as follows:

	7	6	5	4	3	2	1	0
0	(MSB) _____ Identifier Length ( $n-3$ ) _____ (LSB)							
3	_____							
4	Identifier							
n	_____							

## Description:

The Report LUNS command allows the host to retrieve information about what logical units the drive supports. The standard drive only has a single LUN.

## Pre-execution checks:

Illegal Field

## Command descriptor block

	7	6	5	4	3	2	1	0
0	Operation Code (A0h)							
1	Reserved (0)							
2	Select Report							
3	Reserved (0)							
5	Reserved (0)							
6	(MSB)	Allocation Length						(LSB)
9								
10	Reserved (0)							
12	Control							

## CDB fields:

Select Report	The type of logical unit address that will be reported. Allowable values: 00h/02h Report all logical units accessible by the initiator through the address target port. 01h No logical unit descriptors are returned because there are no well-known logical units. 03h–FFh Reserved. CHECK CONDITION returned.
Allocation Length	Must be at least 16 bytes. If not, the drive will return CHECK CONDITION status and provide a sense key of ILLEGAL REQUEST and additional sense of 2400h (invalid field in CDB).

Data returned:

	7	6	5	4	3	2	1	0
0	(MSB)	LUN List Length (08h)						(LSB)
3								
4	(MSB)	Reserved (0)						(LSB)
7								
<i>List of LUNs</i>								
8	(MSB)	LUN 0 (0)						(LSB)
15								

# REPORT SUPPORTED OPCODES

A0h

## Description:

The REPORT SUPPORTED OPCODES command requests information on commands supported by logical unit that is addressed.

## Pre-execution checks:

Illegal Field                      Reservation                      Deferred Error

## Command descriptor block:

	7	6	5	4	3	2	1	0
0	Operation Code (A0h)							
1	Reserved (0)			Service Action (0Ch)				
2	Reserved (0)				Reporting Options			
3	Requested Operation Code(0)							
4	(MSB)	Requested Service Action						(LSB)
5								
6	(MSB)	Allocation Length						(LSB)
9								
10	Reserved (0)							
11	Control							

## CDB fields:

Reporting Options	000b	Only reporting option 000b is supported. This requests that the Device Server returns a list of supported operations and service actions from the port through which the REPORT SUPPORTED OPERATION CODES command was received.
Requested Operation Code	Ignored for Reporting Option 000b.	
Requested Service Action	Ignored for Reporting Option 000b.	
Allocation Length	The number of bytes allocated for the returned parameter data.	

## Data returned

The returned Parameter Data contains a 4-byte header followed by one or more command descriptors:

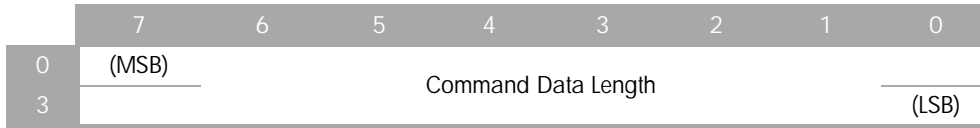



---

Command Data Length	The amount of Parameter Data available for return minus the size of the header.
---------------------	---

---

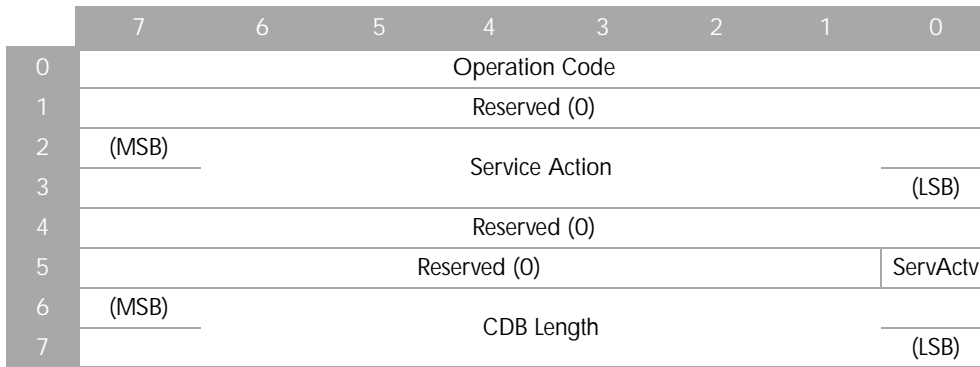
Each command descriptor contains either a supported Operation Code or an Operation Code/Service Action combination. The format of each descriptor is as follows:



---

Operation Code	The operation code of the supported command.
----------------	--

---

Service Action	A supported service action of the operation code. If no service actions are supported this field will be 00h.
----------------	---

---

ServActv	<p>0 No service actions are supported and the Service Action field should be ignored.</p> <p>1 This operation code supports service actions and the Service Action field contains a valid service actions.</p>
----------	--

---

CDB Length	The length of the CDB for this operation code or operation code/service action command.
------------	---

---



# REPORT SUPPORTED TASK MANAGEMENT FUNCTIONS

A3h

## Description:

The REPORT SUPPORTED TASK MANAGEMENT FUNCTIONS command returns information about which task management functions are supported by the logical unit that is addressed.

## Pre-execution checks:

Illegal Field	Reservation	Deferred Error
Unit Attention	Diagnostic Status	

## Command descriptor block:

	7	6	5	4	3	2	1	0
0	Operation Code (A3h)							
1	Reserved (0)				Service Action (0Dh)			
2	Reserved (0)							
5	Reserved (0)							
6	(MSB)	Allocation Length						(LSB)
9	Reserved (0)							
10	Reserved (0)							
11	Control							

## CDB fields:

Allocation Length	The number of bytes that have been allocated for the returned parameter data. This value must be at least four.
-------------------	---

## Data returned:

The returned Parameter Data is as follows:

	7	6	5	4	3	2	1	0
0	ATS	ATSS	CACAS	CTSS	LURS	QTS	TRS	Wakes
1	Reserved (0)							
3	Reserved (0)							

ATS	1	The Abort Task task management function is supported.
ATSS	1	The Abort Task Set task management function is supported.
CACAS	0	The Clear ACA task management function is not supported.

CTSS	1	The Clear Task Set task management function is supported.
LURS	1	The Logical Unit Reset task management function is supported.
QTS	0	The Query Task task management function is not supported.
TRS	0	The Target Reset task management function is not supported.
WakeS	0	The Wakeup task management function is not supported.

The REQUEST SENSE command transfers sense data held within the drive to the host during a data-in phase. The data is valid in the following circumstances:

- After reporting CHECK CONDITION status to the host.
- After a command has terminated with an unexpected BUS FREE.
- Immediately after the following commands that cause tape motion:

READ	SPACE	VERIFY
WRITE	WRITE FILEMARKS	REWIND

Positional sense data is valid whenever media is present and loaded and no higher priority sense data is present. An unsolicited request sense (that is, one with no preceding CHECK CONDITION) will result in sense data with no valid data, which will be all zeros.

**NOTE:** The drive maintains valid positional information for normal read and write commands only (READ, WRITE, SPACE, WRITE FILEMARKS, REWIND). If abnormal commands (such as WRITE BUFFER) are received this positional sense information is lost. See "Sense data management" on page 154.

The drive clears sense data for the host following execution of the REQUEST SENSE command for that host, unless the data is positional sense data.

Pre-execution checks:

Only Illegal Field Check is performed before execution of the command.

Command descriptor block:

	7	6	5	4	3	2	1	0
0	Operation Code (03h)							
1	LUN			Reserved (0)				DESC
2-3	Reserved (0)							
4	Allocation Length							
5	Control							

CDB fields:

LUN	This field is ignored.
DESC	0 Fixed Format sense data will be returned.
	1 Descriptor Format sense data will be returned.

Allocation Length	0	No data is transferred to the host.
	>0	The maximum amount of sense data in bytes that should be transferred to the host. The drive returns up to Allocation Length bytes of data; any extra sense data is lost.

## Request Sense data

Sense data is recovered from the drive by means of a REQUEST SENSE command following the reporting of CHECK CONDITION by the drive. There are two formats in which the data can be returned: Fixed and Descriptor.

### Fixed format

The Fixed format of the returned data is as follows:

	7	6	5	4	3	2	1	0
0	Valid	Error Code						
1	Segment Number (0)							
2	Mark	EOM	ILI	Rsvd(0)	Sense Key			
3	(MSB)	Information Bytes						(LSB)
6	Additional Sense Length (10h)							
7	(MSB)	Command Specific Information Bytes						(LSB)
8	Additional Sense Code							
11	Additional Sense Code Qualifier							
12	Field Replaceable Unit Code							
13	SKSV	C/D	Reserved (0)	BPV	Bit Pointer			
14	(MSB)	Field Pointer/Drive Error Code						(LSB)
15	Reserved (0)							
16-20	Reserved (0)							
21	Reserved (0)			CLN	Reserved (0)			
22	Pad bytes (0)							
23								

### Returned Sense data fields:

Valid	1	Indicates that the information bytes contain valid information as defined in the SCSI specification.
Error Code	70h	Indicates that the error is <i>current</i> , that is, it is associated with the command for which CHECK CONDITION status has been reported.

	71h	Indicates that the error is <i>deferred</i> . A deferred error occurs when there is a failure for an operation that has already been terminated with a GOOD status, or when failure occurs in “cleanup” activity following an operation that was terminated by BUS RELEASE. The command for which CHECK CONDITION status was reported is therefore unlikely to be the cause of the deferred error. It simply gives the drive the opportunity to report CHECK CONDITION status for an error that already exists.
Segment Number		This field is cleared to zero.
Mark	1	The Mark bit is set to 1 if a SPACE, READ or VERIFY command did not complete because a filemark was read. This bit may only be set if the sense key is NO SENSE.
EOM	1	The End of Medium flag is set if a WRITE or WRITE FILEMARKS command completed in the early warning area. If no other error occurred, the sense code will be set to NO SENSE with additional sense of 0002h (EOT). If another error occurred, the sense code and additional sense will reflect that error. It is also set if BOP is encountered while spacing over blocks or filemarks in the reverse direction.
ILI	1	Indicates that the requested block length did not match the actual block length. Only READ and VERIFY can cause this bit to be set.
Sense Key		See “Sense Keys” on page 157 for details of sense keys that can be returned.
Information Bytes		The Information Bytes field is only valid if the Valid bit is set. It contains residue information following the failure of either a READ, WRITE, WRITE FILEMARKS or SPACE command. The field can take a negative value, expressed in 2’s complement notation for the SPACE command. See the description of the command that failed for the contents of the field.
Additional Sense Length	10h	Specifies the number of additional sense bytes to follow. It is never truncated to reflect the actual Transfer Length.
Command Specific Information Bytes	0	Provides additional information specific to the failing command. The field is normally set to 0.
Additional Sense Code and Qualifier		These two bytes provide additional information about the cause of the CHECK CONDITION, or the current tape position when the REQUEST SENSE is unsolicited. See “Additional Sense Codes” on page 159.
SKSV	0	The Sense Key Specific Bytes (bytes 15 through 17) are invalid. The C/D, BPV and Bit pointer fields will be zero. The top byte of the Field Pointer will be zero, and the bottom byte will contain a product-specific error code.
	1	The Sense Key Specific Bytes are valid. This will only happen when the bytes assume the role of Field Pointer Bytes as defined by ANSI. This occurs when an Illegal Field check detects an error in a command descriptor block or a Parameter List check detects an error in a command parameter list.
C/D		<i>Command Data</i> . Only valid if the SKSV flag is set.
	0	The Field Pointer information applies to the parameter list for the command.
	1	The Field Pointer information applies to the command descriptor block.

	71h	Indicates that the error is <i>deferred</i> . A deferred error occurs when there is a failure for an operation that has already been terminated with a GOOD status, or when failure occurs in "cleanup" activity following an operation that was terminated by BUS RELEASE. The command for which CHECK CONDITION status was reported is therefore unlikely to be the cause of the deferred error. It simply gives the drive the opportunity to report CHECK CONDITION status for an error that already exists.
Segment Number		This field is cleared to zero.
Mark	1	The Mark bit is set to 1 if a SPACE, READ or VERIFY command did not complete because a filemark was read. This bit may only be set if the sense key is NO SENSE.
EOM	1	The End of Medium flag is set if a WRITE or WRITE FILEMARKS command completed in the early warning area. If no other error occurred, the sense code will be set to NO SENSE with additional sense of 0002h (EOT). If another error occurred, the sense code and additional sense will reflect that error. It is also set if BOP is encountered while spacing over blocks or filemarks in the reverse direction.
ILI	1	Indicates that the requested block length did not match the actual block length. Only READ and VERIFY can cause this bit to be set.
Sense Key		See "Sense Keys" on page 157 for details of sense keys that can be returned.
Information Bytes		The Information Bytes field is only valid if the Valid bit is set. It contains residue information following the failure of either a READ, WRITE, WRITE FILEMARKS or SPACE command. The field can take a negative value, expressed in 2's complement notation for the SPACE command. See the description of the command that failed for the contents of the field.
Additional Sense Length	10h	Specifies the number of additional sense bytes to follow. It is never truncated to reflect the actual Transfer Length.
Command Specific Information Bytes	0	Provides additional information specific to the failing command. The field is normally set to 0.
Additional Sense Code and Qualifier		These two bytes provide additional information about the cause of the CHECK CONDITION, or the current tape position when the REQUEST SENSE is unsolicited. See "Additional Sense Codes" on page 159.
SKSV	0	The Sense Key Specific Bytes (bytes 15 through 17) are invalid. The C/D, BPV and Bit pointer fields will be zero. The top byte of the Field Pointer will be zero, and the bottom byte will contain a product-specific error code.
	1	The Sense Key Specific Bytes are valid. This will only happen when the bytes assume the role of Field Pointer Bytes as defined by ANSI. This occurs when an Illegal Field check detects an error in a command descriptor block or a Parameter List check detects an error in a command parameter list.
C/D		<i>Command Data</i> . Only valid if the SKSV flag is set.
	0	The Field Pointer information applies to the parameter list for the command.
	1	The Field Pointer information applies to the command descriptor block.

BPV	Bit Pointer Valid
	<ul style="list-style-type: none"> <li>0 The Bit Pointer field is invalid.</li> <li>1 The Bit Pointer field is valid. If the SKSV bit is set then the BPV bit must be set as well.</li> </ul>
Bit Pointer	Identifies the bit position of the field in error, whether it is a command descriptor or a command parameter list field. When a multi-bit field is in error, this will point to the most significant bit of that field. Only valid when the SKSV flag is set.
Field Pointer /Drive Error Code	<p><i>If SKSV = 1</i>, the interpretation of this field depends on the sense key reported.</p> <p>For Sense Key = 5 (ILLEGAL REQUEST), this field represents the Field Pointer, identifying in which byte of the command descriptor or parameter list an error was detected.</p> <p>Note that the drive scans from byte 0 bit 7 of a command or parameter list through to byte <i>n</i> bit 0. The field and bit pointers are set to point to the most significant bit of the field that is in error. See the illegal field check and the parameter list check.</p> <p>For Sense Key = 0 (NO SENSE) or 2 (NOT READY), this field represents the Progress Indication, where the returned value is a numerator that has 65536 (10000h) as its denominator. This reflects the progress being made through the total operation</p> <p><i>If SKSV = 0</i>, this field represents the Drive Error Code. The top byte of this field will be zero. The bottom byte contains the drive error code associated with the failure of the previous command, or zero in the case of no failure and no appropriate error code. If the drive's power-on self-test failed then, in the absence of an error code associated with the most recent command, this byte will be set to the error code generated by the failing test.</p> <p>NOTE: Drive error codes are provided for information only; they are intended to assist in product integration and fault diagnosis. The codes should <i>not</i> be relied on by "generic" host drivers, since these are specific to the product. For a list of codes, see Chapter 10 of the Hardware Integration Guide, Volume 1 of the HP Ultrium Technical Reference Manual.</p>
CLN	<ul style="list-style-type: none"> <li>0 The drive is OK.</li> <li>1 The drive requires cleaning. The front panel LEDs will be displaying a "clean me" sequence or message. This bit is cleared to zero after a cleaning cartridge has been used.</li> </ul>

## Descriptor format

The Descriptor format of the returned data is as follows:

	7	6	5	4	3	2	1	0
0	Valid	Response Code						
1	Reserved(0)				Sense Key			
2	Additional Sense Code							
3	Additional Sense Code Qualifier							
4-6	Reserved (0)							
7	Additional Sense Length ( $n-7$ )							
8	(MSB)	Sense Data Descriptor 0						(LSB)
:								
:								
n	Sense Data Descriptor $X$							

### Returned Sense data fields:

Response Code	72h	The error is <i>current</i> , that is, it is associated with the command for which CHECK CONDITION status has been reported.
	73h	The error is <i>deferred</i> . A deferred error occurs when there is a failure for an operation that has already been terminated with a GOOD status, or when failure occurs in "cleanup" activity following an operation that was terminated by BUS RELEASE. The command for which CHECK CONDITION status was reported is therefore unlikely to be the cause of the deferred error. It simply gives the drive the opportunity to report CHECK CONDITION status for an error that already exists.
Additional Sense Length		The number of additional sense bytes to follow, $\leq 244$ . It is never truncated to reflect the actual Transfer Length.
Additional Sense Code and Qualifier		Additional information about the cause of the CHECK CONDITION, or the current tape position when the REQUEST SENSE is unsolicited. See "Additional Sense Codes" on page 159.
Sense Data Descriptor		At least one descriptor is sent (Drive Error Code), the others may or may not be sent depending on the nature of the CHECK CONDITION.



## Information Sense data descriptor

	7	6	5	4	3	2	1	0
0	Descriptor Type (00h)							
1	Additional Length (0Ah)							
2	Valid (1)	Reserved (0)						
3	Reserved (0)							
4	Information Bytes							
11								

## Sense Key Specific Sense data descriptor

Only one of these is reported: Field Pointer or Progress Indication.

### Field Pointer

The Sense Key is set to Illegal Request.

	7	6	5	4	3	2	1	0
0	Descriptor Type (02h)							
1	Additional Length (06h)							
2-3	Reserved (0)							
4	SKSV (1)	C/D	Reserved (0)			BPV	Bit Pointer	
5	Field Pointer							
6								
7	Reserved (0)							

### Progress Indication

The Sense Key is set to No Sense or Not Ready.

	7	6	5	4	3	2	1	0
0	Descriptor Type (02h)							
1	Additional Length (06h)							
2-3	Reserved (0)							
4	SKSV (1)	Reserved (0)						
5	Progress Indication							
6								
7	Reserved (0)							

---

**Process Indication** The percent complete indication in which the returned value is a numerator that has 65,536 (10000h) as its denominator. The progress indication is based on the total operation.

---

## Stream Commands Sense data descriptor

	7	6	5	4	3	2	1	0
0	Descriptor Type (04h)							
1	Additional Length (02h)							
2-3	Reserved (0)							
4	Mark	EOM	ILI	Reserved (0)				

## Drive Error Code Sense data descriptor (*Vendor Specific*)

	7	6	5	4	3	2	1	0
0	Descriptor Type (80h)							
1	Additional Length (02h)							
2-3	Reserved (0)							
4	Mark	EOM	ILI	Reserved (0)				
4	Drive Error Code							
11								

## Cleaning Needed Sense data descriptor (*Vendor Specific*)

	7	6	5	4	3	2	1	0
0	Descriptor Type (81h)							
1	Additional Length (02h)							
2-3	Reserved (0)							CLN (1)
4	Reserved (0)							

## Sense data management

The drive maintains three sets of sense data for every initiator on the bus. For a single host the following sense data is maintained:

- Current sense
- UNIT ATTENTION sense
- DEFERRED ERROR sense

Unless otherwise stated, all the following descriptions apply to the sense data for a single host whose command is being executed.

### Current sense

*Current sense* is the data that is returned in response to a REQUEST SENSE command. It is modified or updated in the following circumstances:

- It is cleared in response to the arrival of any command other than REQUEST SENSE or INQUIRY.
- It is cleared following execution of a REQUEST SENSE command.
- If the current command fails, sense is set according to the failure and CHECK CONDITION is reported to the host that sent the command.
- If the previous command terminated with an unexpected BUS FREE, current sense is set according to the reason for the bus release.
- If the command fails its pre-execution check for Unit Attention, UNIT ATTENTION sense is copied to the Current sense, and CHECK CONDITION is reported to the host that sent the command.
- If the command fails its pre-execution check for Deferred Error, DEFERRED ERROR sense is copied to the Current sense, and CHECK CONDITION is reported to the host that sent the command.

### Clearing current sense:

Clearing the Current sense involves setting sense fields as follows:

```
Valid = 0
error code = 0x70
segment number = 0
ILI = 0
sense key = 0
information bytes = 0
command specific information = 0
fru code = 0
SKSV = 0
```

## UNIT ATTENTION sense

UNIT ATTENTION sense is set when one of the following Unit Attention conditions occur:

- Power On, SCSI Reset, Bus Device Reset
- Media inserted
- A load command executed by a third party
- Mode Sense parameters changed by another initiator
- Drive firmware has been updated

UNIT ATTENTION sense will persist for a host until the host sends a command that has Unit Attention as part of its pre-execution checks. When the Unit Attention pre-execution check fails, the UNIT ATTENTION sense is copied to the Current sense and CHECK CONDITION status is reported to the host. The UNIT ATTENTION sense is cleared. The host is then expected to issue a REQUEST SENSE command to recover the UNIT ATTENTION sense (which is now the new Current sense).

It is possible for multiple UNIT ATTENTION conditions to arise (for example, after a power-on followed by a tape load), such that the initiator does not read one condition before the next occurs. In this case a prioritizing scheme is used. If a UNIT ATTENTION condition exists and a new one occurs, then the UNIT ATTENTION sense will be overwritten by the new sense only if the new sense has a higher priority.

The order of priority is as follows:

Power-on, Reset	<i>highest priority</i>
Tape Loaded	
Mode Parameters Changed	
Microcode Downloaded	<i>lowest priority</i>

UNIT ATTENTION sense that arises as a result of a command executing will not be posted to the sending initiator, but will be set for the other initiators.

## DEFERRED ERROR sense

DEFERRED ERROR sense is generated when an operation fails and CHECK CONDITION status cannot be reported to the host for one of the following reasons:

- The operation had immediate-report on (for example, REWIND with the Immed bit set, or LOAD).
- The operation was a write that was immediate-reported on after its data was successfully placed in the write-behind queue.
- The operation was abandoned without status (that is, a bus release occurred) after what the drive perceived was a catastrophic error or when an error occurred following the drive's honoring of an ABORT message. Following the bus release, the drive performed "cleanup" activity that failed. The Deferred Error refers to the reason for this failure.

When any one of the above occurs, the sense generated will be DEFERRED ERROR sense. This sense persists until the host sends a command that has Unit Attention as part of its pre-execution checks. When the Deferred Error pre-execution check fails, the DEFERRED ERROR sense is moved to the Current sense and CHECK CONDITION status is reported to the host. The host is then expected to issue a REQUEST SENSE command to recover the new Current sense data, otherwise the data will be lost.

### Write-behind deferred errors:

If the Buffered Mode field of the MODE SELECT parameter header is not zero, data buffering is enabled. If an error occurs in flushing the write-behind data, DEFERRED ERROR sense is set for all hosts that the drive thinks have write-behind data in the buffer. For each of these hosts, the following occurs when its next command is to be executed:

- If the command is WRITE or WRITE FILEMARKS the DEFERRED ERROR sense is copied to Current sense and the error is changed to a Current error (the Error Code field is set to 70h). The information bytes will contain residue information reflecting the size of the write-behind queue plus the transfer size of the current command. CHECK CONDITION is

reported. When the host reads sense data with a REQUEST SENSE, it will see an error for the WRITE with residue information indicating data lost for that write and previous writes.

- If the command is not a write command and the Deferred Error check is performed as part of the pre-execution checks, CHECK CONDITION status is reported. The DEFERRED ERROR sense is copied to Current sense. The DEFERRED ERROR sense is cleared. The host is expected to retrieve the sense by sending a REQUEST SENSE, otherwise the data will be lost.

### Bus release deferred errors:

The drive will release the bus to terminate an operation (such as READ) when the host sends an ABORT message or when the drive fails to send status due to a catastrophic error.

In each case, the operation does not terminate immediately since the logical position will have to be established on the other side of the block that was about to be transferred, or was being transferred. If an error subsequently occurs while trying to complete the read, the sense generated is a DEFERRED ERROR. It is therefore possible but highly unlikely to have DEFERRED ERROR sense flagged for a command without immediate report.

## Sense keys

The following table lists the sense keys that may be returned by HP Ultrium drives. SCSI sense keys are 4-bit codes returned in the sense data. They indicate in what general area the problem that has just been experienced falls. For a clearer indication of the nature of the problem, refer to the additional sense code.

Code	Name	Description	ASC/Qs
0h	NO SENSE	There is no real problem. The sense information is probably indicating some condition (such as encountering a filemark).	0000h, 0001h, 0002h, 8282h
1h	RECOVERED ERROR	Returned if a Mode Select parameter is truncated or if a TapeAlert event is being reported.	5D00h, 3700h
2h	NOT READY	The drive is not in a state to be able to execute the request. See also the Media Access check.	0400h, 0401h, 0402h, 3003h, 3007h, 3A00h, 3E00h
3h	MEDIUM ERROR	The command failed, believed to be caused by a problem with the tape.	0002h, 0004h, 0407h, 0410h, 0C00h, 1100h, 1102h, 1400h, 3001h, 3002h, 3004h, 3100h, 3B00h, 5000h, 5200h, 5300h
4h	HARDWARE ERROR	The command failed, believed to be caused by a problem with the drive hardware. The FRU in the sense data should indicate which part of the hardware is faulty.	0403h, 40XXh, 4400h, 5100h, 5300h

Code	Name	Description	ASC/Qs
5h	ILLEGAL REQUEST	The last command sent to the drive or the data associated with the command violated conditions imposed by the drive on its acceptance. See also the Illegal Command, Illegal Field, Fixed Bit, Reservation and Parameter List pre-execution checks.	1A00h, 2000h, 2400h, 2500h, 2600h, 2601h, 5302h, 8283h
6h	UNIT ATTENTION	Indicates some condition of which the host needs to be made aware. See also the Unit Attention check.	2800h, 290Xh, 2A01h, 3F01h, 5DFFh
7h	DATA PROTECT	A request has been made to modify the media despite the media being write-protected. See also the Media Write check.	2700h, 3000h
8h	BLANK CHECK	The drive tried to read unwritten tape.	0005h, 1403h
9h	VENDOR SPECIFIC	Never returned by HP tape drives	
Ah	COPY ABORTED	Never returned by HP tape drives	
Bh	ABORTED COMMAND	The drive has stopped trying to act on a command, usually through some problem on the SCSI bus.	3D00h, 4300h, 4500h, 4700h, 4800h, 4900h, 4A00h, 4B00h, 4E00h
Ch	EQUAL	Never returned by HP tape drives	
Dh	VOLUME OVERFLOW	Data could not be written due to lack of remaining space on the tape. See the WRITE and WRITE FILEMARKS commands.	0002h
Eh	MISCOMPARE	Never returned by HP tape drives	
Fh	RESERVED	Never returned by HP tape drives	

## Additional Sense codes

This section contains a list of all the additional sense codes that an HP Ultrium drive can return, in numerical order. The Sense Keys under which each code could appear are also listed. The ASCQ bytes are present at bytes 12 and 13 of the sense data.

Code	Description	Explanation
00 00h	No additional sense	The flags in the sense data indicate the reason for command failure.
00 01h	Filemark detected	A Read or a Space command terminated early because a filemark has been encountered. The File Mark flag will be set.
00 02h	End of Tape detected	A Write or a Write Filemarks command ended in the early warning area. <i>or</i> A command terminated early because End of Tape or physical end of tape was encountered. The EOM flag will be set.
00 04h	Beginning of Tape detected	A Space command terminated early because beginning of tape was encountered. The EOM flag will be set.
00 05h	End of Data detected	A Read or a Space command terminated early because End of Data was encountered.
00 16h	Operation in progress	An immediate mode command is in progress
00 18h	Erase operation in progress	An immediate mode ERASE is still in progress
00 19h	Locate operation in progress	An immediate mode LOCATE is still in progress
00 1Ah	Rewind operation in progress	An immediate mode REWIND is still in progress
04 00h	LUN not ready, cause not reportable	A tape is present in the drive but is in the process of being unloaded.
04 01h	LUN in process of becoming ready	A medium access command has been received during a load initiated from the front panel or by an immediate-reported Load command
04 02h	LUN not ready, Initializing command required	A tape is present in the drive but is not logically loaded. A Load command is required.
04 03h	LUN not ready, manual intervention required	A tape is present in the drive but could not be loaded or unloaded without manual intervention.
04 07h	Immediate mode command in progress	The tape drive is currently executing an immediate mode command.
04 10h	Media Auxiliary Memory is not accessible	MAM is not accessible.
0C 00h	Write error	A Write operation has failed. This is probably due to bad media but may be hardware related.
0C 0Bh	Media Auxiliary Memory write error	An error has occurred while attempting to write to MAM.
11 00h	Unrecovered read error	A Read operation failed. This is probably due to bad media but may be hardware related.
11 12h	Media Auxiliary Memory read error	The Host Attribute area in MAM is invalid.
14 00h	Recorded entity not found	A Space or Locate failed because a format violation prevented the target of the operation from being found.

Code	Description	Explanation
14 03h	End of data not found	A read-type operation failed because a format violation related to a missing EOD data set, or there was an attempt to read a brand new tape.
1A 00h	Parameter list length error	The amount of data sent in a Mode Select or Log Select command is incorrect <i>or</i> The Mode Header indicates a Mode Block Descriptor but no Mode Block Descriptor is sent.
20 00h	Invalid command operation code	The operation code in the command was not valid.
24 00h	Invalid field in Command Descriptor Block	An invalid field has been detected in a Command Descriptor Block.
25 00h	LUN not supported	The command was addressed to a non-existent logical unit number.
26 00h	Invalid field in parameter list	An invalid field has been detected in the data sent during the data phase
26 01h	Parameter not supported	The command was addressed to a non-existent logical unit number.
26 04h	Invalid release of persistent reservation	The Persistent Reservation holder has tried to release the persistent reservation using the PERSISTENT RESERVE OUT command, but the Scope or Type supplied was invalid.
27 00h	Write-protected	A write-type operation has been requested on a tape that has been write-protected.
28 00h	Not ready to ready transition, medium may have changed	A tape has been loaded successfully into the drive and is now ready to be accessed.
29 01h	Power-on reset	The drive has powered on since the host last accessed it.
29 02h	SCSI bus reset	<i>SCSI drives:</i> The drive has received a SCSI reset signal since the host last accessed it.  <i>FC drives:</i> The drive has received its first process login. The drive will be implicitly logged out after a Target Reset so this ASCQ will be posted after the host has performed port/process login.
29 03h	Bus device reset	<i>SCSI drives:</i> The drive has received a SCSI bus device reset message since the host last accessed it.  <i>FC drives:</i> The drive has received a process login when it was previously logged in for a particular host.
29 04h	Internal firmware reboot	The drive has reset itself.
29 05h	Transceivers to SE	<i>SCSI drives:</i> The transceivers on the bus have been reset to Single-Ended.
29 06h	Transceivers to LVD	<i>SCSI drives:</i> The transceivers on the bus have been reset to LVD.
2A 01h	Mode parameters changed	The Mode parameters for the drive have been changed by an initiator other than the one issuing the command.
2A 02h	Log parameters changed	The Log parameters for the drive have been changed by an initiator other than the one issuing the command.
2A 03h	Reservations pre-empted	A PERSISTENT RESERVE OUT command with the Clear service action was attempted. All reservations and the persistent reservation have been removed.



Code	Description	Explanation
2A 04h	Reservations released	The original persistent reservation has been replaced with another of a different type or removed completely.
2A 05h	Registrations pre-empted	A PERSISTENT RESERVE OUT command was executed and all registrations removed.
2C 00h	Command sequence invalid	The use of the echo buffer was invalid. A WRITE BUFFER command is necessary before a READ BUFFER command.
30 00h	Incompatible medium installed	A write-type operation could not be executed because it is not supported on the type of tape that is loaded.
30 01h	Unknown format	An operation could not be carried out because the tape in the drive is of a format not supported by the drive.
30 02h	Cannot read media: incompatible format	An operation could not be completed because the logical format is not correct.
30 03h	Cleaning cartridge installed	An operation could not be carried out because the tape in the drive is a cleaning cartridge.
30 04h	Cannot write medium	An attempt was made to write to a cartridge that has Cartridge Memory errors.
30 05h	Cannot write medium, incompatible format	For example, the drive tried to write to a tape of an incompatible generation.
30 07h	Cleaning failure	A cleaning operation was attempted but could not be completed for some reason.
30 0Ch	WORM—overwrite attempted	A write operation could not be executed because an overwrite has been attempted on a WORM cartridge. This may be because an overwrite backup was specified instead of an appended backup.
30 0Dh	WORM medium—integrity check failed	The drive has detected an inconsistency when performing an integrity check on a WORM cartridge. The cartridge may have been tampered with.
31 00h	Medium format corrupted	Data could not be read because the format on tape is not valid, although it is in a known format.
35 01h	Unsupported enclosure function	The drive cannot respond to this Enclosure Services request.
35 02h	Enclosure services unavailable	No compatible enclosure hardware has been detected by the drive.
37 00h	Rounded parameter	A Mode Select command parameter has been rounded because the drive cannot store it with the accuracy of the command.
3A 00h	Medium not present	A media-access command has been received when there is no tape loaded.
3A 04h	Medium not present, Media Auxilliary Memory accessible	A media access command has been received when the tape has been loaded but not threaded. This will be reported if the hold bit of the LOAD CDB was set or the Autoload field in the Control mode page is non zero.
3B 00h	Sequential positioning error	A command has failed and left the logical position at an unexpected location.
3B 0Ch	Position past BOM	A SET CAPACITY command was received when the logical position was not BOT, a necessary condition for this command.
3D 00h	Invalid bits in Identify message	An illegal Identify message has been received by the drive at the start of a command.

Code	Description	Explanation
3E 00h	Logical unit has not self-configured yet	The drive has just powered on and has not completed its self-test sequence, so it cannot process commands.
3F 01h	Firmware upgraded	The firmware in the drive has just been changed by a Write Buffer command.
3F 05h	Device identifier changed	The Device ID has been changed successfully.
3F 0Fh	Echo buffer overrun	A Read Buffer command has been received with Echo Buffer mode set, and the echo buffer has been overwritten by a different host from that which issued the Read Buffer command.
3F 11h	Media Auxiliary Memory accessible	MAM is accessible but the cartridge is in the Hold position. Unit Attention is generated.
40 XXh	Diagnostic failure on component XX	A diagnostic test has failed. The Additional Sense Code Qualifier is a vendor-specific code indicating the failing component.
43 00h	Message error	A message could not be sent or received because of excessive transmission errors.
44 00h	Internal target failure	A hardware failure has been detected in the drive that has caused the command to fail.
45 00h	Select or reselect failure	An attempt to reselect an initiator in order to complete the command has failed.
47 00h	SCSI parity error	A command failed because of an excessive number of parity errors on the SCSI interface.
47 01h	Data phase CRC error detected	For parallel SCSI only in non-Information Units mode, the drive has detected a CRC error during the data out phase.
47 03h	Information Unit CRC error detected	For parallel SCSI only in Information Units mode, the drive has detected a CRC error during the command IU or data out phase.
48 00h	Initiator Detected Error message received	A command failed because an Initiator Detected Error message was received.
49 00h	Invalid message error	The command failed because an invalid message was received by the drive.
4A 00h	Command phase error	A command could not be executed because too many parity errors occurred in the command phase
4B 00h	Data phase error	A command could not be completed because too many errors occurred during the data phase.
4B 90h	Data phase error	FCL_DL to CDB Allocation Length mis-match.
4E 00h	Overlapped commands attempted	An initiator selected the drive even though it already had a command outstanding.
50 00h	Write append error	A write-type command failed because the point at which to append data was unreadable.
51 00h	Erase failure	An erase command failed to erase the required area on the tape.
52 00h	Cartridge fault	A command could not be completed because of a fault in the tape cartridge.
53 00h	Media load or eject failed	An attempt to load or eject the tape failed because of a problem with the tape.
53 02h	Medium removal prevented	An Unload command has failed to eject the tape because medium removal has been prevented.
55 03h	Insufficient resources	

Code	Description	Explanation
55 04h	Insufficient registration resources	<i>FC interface only:</i> There is only space for requests from 32 initiators to register, using PERSISTENT RESERVE OUT commands.
55 06h	Media Auxiliary Memory full	There is insufficient space in the Host Attribute area in MAM to fit the attribute that need to be written.
5D 00h	Failure prediction threshold exceeded	Failure Prediction thresholds have been exceeded indicating that a failure may occur soon.
5D FFh	Failure prediction threshold exceeded (false)	A Mode Select command has been used to test for the Failure Prediction system.
82 82h	Drive requires cleaning	The drive has detected that a cleaning operation is advisable to maintain good operation.
82 83h	Bad microcode detected	The data transferred to the drive during a firmware upgrade is corrupt or incompatible with the drive hardware.

## Error codes

The error codes that can be reported in bytes 16 and 17 are listed in Chapter 10 of the Hardware Integration Guide, Volume 1 of the HP Ultrium Technical Reference Manual.

# RESERVE UNIT

16h/56h

This command enables the host to reserve the drive. Reserving a device is a way of ensuring exclusive access to that device from a single initiator for the period of the reservation.

Once reserved, the drive will execute commands received from the reserving initiator or from the third-party initiator if the 3rd-Pty option has been selected. Commands from other initiators will have RESERVATION CONFLICT status reported for them, apart from INQUIRY, REQUEST SENSE, LOG SENSE, REPORT LUNS, REPORT DENSITY SUPPORT, READ BLOCK LIMITS and RELEASE UNIT.

The INQUIRY, REQUEST SENSE, LOG SENSE, PREVENT/ALLOW MEDIUM REMOVAL (Allow=0), REPORT LUNS, READ BLOCK LIMITS and REPORT DENSITY SUPPORT commands are immune to the effects of a reservation and will continue to execute for all hosts. The RELEASE UNIT command will have GOOD status reported for other hosts, but will have no effect on the reservation.

The reservation will stay in effect until:

- The reserving host sends another RESERVE UNIT command.
- The reserving host sends a RELEASE UNIT command, clearing the reservation.
- A power-on, firmware upgrade or forced eject.

Pre-execution checks:

Illegal Field                      Deferred Error                      Unit Attention

If the drive is reserved by some other host then reservation conflict status is reported to the host.

Command descriptor block:

6-byte

	7	6	5	4	3	2	1	0
0	Operation Code (16h)							
1	Reserved (0)			3rd Pty(0)	Third-Party Device ID (0)			Rsvd(0)
2	Reserved (0)							
4								
5	Control							

---

3rdPty                      This is always zero because third-party reservation is not supported.

---

Third-Party Device ID                      This is always zero because third-party reservation is not supported.

---

10-byte

	7	6	5	4	3	2	1	0
0	Operation Code (56h)							
1	Reserved (0)			3rd Pty	Reserved (0)		LongID(0)	Rsvd(0)
2	Reserved (0)							
3	Third-Party Device ID							
4	Reserved (0)							
6	Reserved (0)							
7	(MSB)	Parameter List Length					(LSB)	
8								
9	Control							

# REWIND

01h

REWIND causes the drive to write all buffered logical objects to tape and then positions the tape at BOM (beginning of media). Once a rewind is started, it will complete even if the SCSI operation is aborted (for example, if the host selects and sends an abort message).

Pre-execution checks:

Illegal Field	Reservation	Deferred Error
Unit Attention	Media Access	Diagnostic Status

Command descriptor block:

	7	6	5	4	3	2	1	0
0	Operation Code (01h)							
1	Reserved (0)							Immed
2	Reserved (0)							
4								
5	Control							

CDB fields:

---

Immed	0	Status is returned after the rewind has completed.
	1	The drive first writes any unwritten buffered data to tape. It then returns GOOD status to the host before beginning the actual rewind operation.

---

Rewind specific status:

If the rewind is successful, unsolicited positional sense will indicate that the tape is at BOM by the EOD bit being set and an additional sense code of 0004h (BOP).

# SEEK (CD-ROM mode)

2Bh

SEEK is executed for 2Bh when the drive is in CD-ROM mode. When out of CD-ROM, the LOCATE command, which shares the opcode, is executed.

Assuming the pre-execution checks are passed, GOOD status is always reported.

Pre-execution checks:

Illegal Field	Flag Link	Bad LUN	Reservation
Deferred Error	Unit Attention	Media Access	Diagnostic Status

Command descriptor block:

	7	6	5	4	3	2	1	0
0	Operation Code (2Bh)							
1	Logical Unit Number				Reserved (0)			
2	(MSB) _____ Logical Block Address _____ (LSB)							
5								
6-8	Reserved (0)							
9	Control							

CDB fields:

---

Logical Block Address This field is ignored.

---

# SEND DIAGNOSTIC

1Dh

SEND DIAGNOSTIC tells the drive to perform either its standard self-test, or diagnostics specified in the parameter list on itself. The parameter list is transferred to the drive in a series of data-out phases; each 8-byte data-out phase specifies a diagnostic to be performed by the drive. It is not an error to set Self-Test = 0 and to have a zero-length parameter list.

The test results can be retrieved with the RECEIVE DIAGNOSTIC RESULTS command.

Pre-execution checks:

Illegal Field                  Reservation                  Deferred Error                  Unit Attention

- If Self-Test = 0, the UntOffl bit must be set, otherwise CHECK CONDITION is reported. Sense data will be as described in Illegal Field Checks.
- If Self-Test = 1, the Parameter List Length field must be zero. Otherwise CHECK CONDITION is reported. Sense data will be as described in Illegal Field Checks.
- It is not an error to set Self-Test = 0 and to have a zero-length parameter list.

Command descriptor block:

	7	6	5	4	3	2	1	0
0	Operation Code (1Dh)							
1	Reserved (0)			PF (1)	Rsvd(0)	Self-Test	DevOffl(0)	UnitOffl
2	Reserved (0)							
3	(MSB)	Parameter List Length						(LSB)
4								
5	Control							

CDB fields:

PF	<i>Page Format.</i> Specifies that the accompanying data follows the SCSI-3 Diagnostic Page format. It must be set to 1.
Self-Test	0 Perform the diagnostics specified in the parameter list. The UnitOffl bit must be set, otherwise CHECK CONDITION is reported. The drive reports status when the command has been completed. 1 Perform the standard self-test depending on the value of UnitOffl (see above). The Parameter List Length must be 0 otherwise CHECK CONDITION is reported. The drive will report GOOD status following the pre-execution checks and before executing the command.
DevOffl	<i>Device Offline bit.</i> Must be cleared to zero.
UnitOffl	<i>Unit Offline bit</i> 0 Indicates that the host is not prepared for the drive to perform tests that could affect logical position.



- 1 Indicates that the host is prepared for the drive to perform tests that could affect logical position, modify the tape or modify cartridge status. This bit must be set if the Self-Test bit is 0.

---

Parameter List Length	Indicates how many bytes of diagnostic parameter data are to be sent to the drive. The length of the data phase for SEND DIAGNOSTIC is limited to 4 bytes of header plus 34 parameters, each of which is 4 bytes long. This gives an upper limit for the parameter list length of 136 bytes.
-----------------------	--

---

### Data required

No data is required if the standard self-test is to be performed. Otherwise, a single diagnostic page must be provided as a parameter.

### Specific status

Any Send Diagnostic command received with a Enclosure Services page number (01h to 0Fh) will generate CHECK CONDITION with sense key of ILLEGAL REQUEST and additional sense of 3501h (unsupported enclosure function).

The drive reports GOOD status if the diagnostics pass. It will report CHECK CONDITION if the diagnostics fail, with a sense key of HARDWARE ERROR and additional sense of 4000h.

More detailed results can then be recovered using the Receive Diagnostic Results page.

## Standard self-test

---

<i>With a tape inserted:</i>	<p>If Self-Test = 1 and UntOffl = 0, a test is performed that does not affect the contents of the tape. This test is a more extensive set of the tests carried out at power-on.</p> <p>If UntOffl = 1, the tape contents can be overwritten and will be undefined after the test. A user can re-use the tape after the test.</p>
<i>With no tape in the drive:</i>	<p>The same self-test will be executed regardless of the setting of UntOffl.</p> <p>The results of any self-test (power on or not) can be determined by reading the Self-Test diagnostic page before executing a diagnostic (which will overwrite the result).</p>

---

# SET CAPACITY

0Bh

This provides a means of changing the logical length of the currently-loaded media. The primary use envisaged is for testing purposes, although it may also be used in other circumstances where a shortened tape may be beneficial.

Note that all data currently on the media will be lost following successful execution of this command. The command is only accepted when the media is positioned at Beginning of Media (BOM).

With WORM cartridges, the command is only accepted and executed if the cartridge has not been initialized, that is, it has never been written to. Otherwise the cartridge is rejected with CHECK CONDITION, sense key of Data Protect and additional sense of 300Ch (WORM media—overwrite attempted). TapeAlert flags 3Ch (WORM media—overwrite attempted) and 09h (write-protect) are set.

Pre-execution checks:

Illegal Field	Reservation	Deferred Error
Unit Attention	Media Access	Media Write

Command descriptor block:

	7	6	5	4	3	2	1	0
0	Operation Code (0Bh)							
1	Reserved (0)							Immed
2	Reserved (0)							
3	(MSB)	Capacity Proportion Value						(LSB)
4								
5	Control							

CDB fields:

Immed	0 Status will not be returned until the SET CAPACITY operation has completed. 1 Status will be returned as soon as the CDB has been parsed.
Capacity Proportion Value	The portion of the total volume capacity to be made available for use. The value given here is the numerator of a fraction with a denominator of 65,535. The resulting available capacity will be $\frac{\text{total volume capacity} \times \text{capacity proportion value}}{65535}$ .  Note that the LTO-3 format enforces a minimum tape length. A value that would result in a tape length below this minimum will be silently rounded up to the minimum permitted length.

# SET DEVICE IDENTIFIER

# A4h

SET DEVICE IDENTIFIER allows a initiator to set the Device ID information to that supplied in the Parameter List. This information can be later retrieved by the REPORT DEVICE IDENTIFIER command.

Upon successful completion the command will post sense key UNIT ATTENTION with additional sense of 3F05h (device identifier changed) to all initiators except the one that issued the command. Once set the Device Identifier will only be cleared by a successful Set Device Identifier command or a drive reset.

Pre-execution checks:

Illegal Field          Reservation          Deferred Error          Unit Attention

Command descriptor block:

	7	6	5	4	3	2	1	0
0	Operation Code (A4h)							
1	Reserved (0)				Service Action (06h)			
2-5	Reserved (0)							
6	(MSB)	Parameter List Length						(LSB)
9								
10	Reserved (0)							
11	Control							

CDB fields:

Service Action	Must be 06h
Parameter List Length	The length in bytes of the Device Identifier to be set. If the value exceeds 64, CHECK CONDITION is returned with additional sense of 2400h (invalid field in CDB). 0 Not an error, but clears any previously stored Device ID.

Data

The format of the Device Identifier supplied in the Parameter List is as follows:

	7	6	5	4	3	2	1	0
0	(MSB)	Identifier						(LSB)
n								

SPACE provides a variety of positioning functions that are determined by Code and Count fields in the Command Descriptor Block. Both forward (towards EOM) and reverse (towards BOM) positioning are provided.

Any unwritten data in the buffer is flushed to tape before the space is started. The logical media position is then modified according to the Code and Count fields. Once the space has started, it will complete even if the SCSI operation is aborted for some reason (for example, the host selects and sends an abort message).

Pre-execution checks:

Illegal Field	Reservation	Deferred Error
Unit Attention	Media Access	Diagnostic Status

The Code field must be 0, 1 or 3. If it is not then CHECK CONDITION status is reported. Sense data will be as described in the Illegal Field Checks.

Command descriptor block:

6-byte version

	7	6	5	4	3	2	1	0
0	Operation Code (11h)							
1	Reserved (0)					Code		
2	(MSB)							
3	Count ( <i>n</i> )							
4	(LSB)							
5	Control							

16-byte version

	7	6	5	4	3	2	1	0
0	Operation Code (91h)							
1	Reserved (0)					Code		
2-3	Reserved (0)							
4	(MSB)							
11	Count ( <i>n</i> )							
11	(LSB)							
12	(MSB)							
13	Parameter Length							
13	(LSB)							
14	Reserved (0)							
15	Control							

## CDB fields:

Code	The Code field indicates what is to be spaced to: 000 Blocks—The number of blocks crossed is dictated by Count. 001 Filemarks—The number of filemarks crossed is dictated by Count. 011 EOD—Space to the end of data in the current active partition.
Count	<ul style="list-style-type: none"> <li>When spacing over <i>blocks</i> or <i>filemarks</i> this field indicates how many blocks or marks should be crossed. Spacing is forward (towards EOM) unless Count is negative (twos complement) when the spacing is towards BOM.</li> <li>When spacing to <i>EOD</i> the Count field is ignored.</li> <li>When not spacing to EOD, if Count is zero, the SPACE command is treated as a null operation. The logical position remains unchanged, and unwritten data is not flushed to tape.</li> </ul>
Parameter Length	0 Explicit block mode is not supported.

## Space specific status:

If the drive fails to space either from a medium error or from some sort of non-fatal drive error, CHECK CONDITION status is reported. The sense key will be set to MEDIUM ERROR. Additional sense depends on the nature of the error. The two most common additional sense code and qualifiers in this case will be: 1100h (unrecovered read error) and 3B00h (sequential positioning error).

The drive implements the following priority scheme when a tape position point is encountered:

<i>Lowest priority</i>	Blocks	
	Filemarks	If the drive meets a filemark while spacing to a block CHECK CONDITION is reported. The Mark bit in the sense data is set, and the sense key is NO SENSE. Additional sense is 0001h (filemark encountered). The final position will be before or after the filemark depending on whether the space was reverse or forward.
	EOD	If the drive meets EOD while spacing to a block or mark, CHECK CONDITION is reported. The EOM bit in the sense data is set. The sense key is BLANK CHECK and additional sense is 0005h (EOD encountered).
	BOM	If the drive meets BOM while spacing, CHECK CONDITION is reported. The EOM bit and Valid bit in the sense data are set to 1 and the information bytes set to the total number of blocks or filemarks that remain to be spaced over (in other words, the requested number minus the number that have been spaced over). The sense key is NO SENSE and additional sense is 0004h (BOT detected).
<i>Highest priority</i>	EOM	If the drive meets EOM while spacing, CHECK CONDITION is reported. The EOM bit in the sense data is set. The sense key is MEDIUM ERROR and additional sense is 0002h (EOP/M detected).

- If “blank media” is encountered during a space (in other words, the drive attempted to space on an unformatted tape), the drive behaves as if EOD was at BOM. It will then

respond with GOOD status to a request to space to EOD, and with CHECK CONDITION to any other forward spacing request. Additional sense is set to 1403h (End of data not found).

- Early warning end of medium information is not reported.
- If a space records or space filemarks command fails then the sense data information bytes will be set to the absolute value of the difference between the requested number of marks/records and the actual number of marks/records spaced over and the Valid bit set. The residue for a prematurely terminated Space towards BOM will always be a positive value. NOTE: This value will only be accurate if the sense key is NO SENSE.
- If the format of the data on tape is corrupt then CHECK CONDITION status is reported. The sense key will be set to MEDIUM ERROR. Additional sense will be set to 3001h (unknown format).
- If the drive fails to read data from tape due to either a MEDIUM ERROR or some sort of non fatal drive error then CHECK CONDITION status is reported. The sense key will be set to HARDWARE ERROR Additional sense will be set to 3B00h (sequential positioning error).

# START/STOP (CD-ROM mode)

1Bh

START/STOP is executed for 1Bh when the drive is in CD-ROM mode. When out of CD-ROM mode, the LOAD/UNLOAD command, which shares the opcode, is executed.

Assuming that the pre-execution checks are passed, GOOD status is always reported.

Pre-execution checks:

Illegal Field	Flag Link	Bad LUN
Reservation	Deferred Error	Unit Attention

Command descriptor block:

	7	6	5	4	3	2	1	0
0	Operation Code (1Bh)							
1	Logical Unit Number				Reserved (0)			Immed
2	Reserved (0)							
3	Reserved (0)							
4	Reserved (0)					LoEj	Start	
5	Control							

CDB fields:

Immed	This flag is ignored.
LoEj	Load/Eject. This flag is ignored.
Start	This flag is ignored.

# TEST UNIT READY

00h

TEST UNIT READY checks if the drive is ready for commands that access the tape. This is done by the pre-execution Media Access check; it is not a request for a self-test. If the drive has a tape loaded, the command returns a GOOD status. Otherwise, CHECK CONDITION is reported and the sense key is NOT READY.

Pre-execution checks:

Illegal Field	Reservation	Deferred Error
Unit Attention	Media Access	Media Information

Command descriptor block:

	7	6	5	4	3	2	1	0
0	Operation Code (00h)							
1	Reserved (0)							
4	Reserved (0)							
5	Control							

Test Unit Ready specific status:

If all the pre-execution checks pass, GOOD status is reported.



VERIFY verifies one or more blocks beginning with the next block on the tape. The verification is media verification only. It reads data from the tape as it would for a read but then immediately discards it. No data is transferred between the host and drive.

The command is identical to the READ command in most respects. The pre-execution checks are identical. Sense data reporting on errors/exceptions is identical. The only differences are:

- No data phases occur during verification.
- The Verify command has no SILI bit. When an illegal length record is encountered, Verify behaves like READ with the SILI bit clear.

**NOTE:** Verify will not complete until all data has been read. It does support the ANSI "byte compare" or "Immed" options (see the ANSI SCSI specification).

### Pre-execution checks:

Illegal Field	Fixed Bit	Reservation	Deferred Error
Unit Attention	Media Access	Diagnostic Status	

### Command descriptor block:

	7	6	5	4	3	2	1	0
0	Operation Code (13h)							
1	Reserved (0)					Immed(0)	BCmp(0)	Fixed
2	(MSB)							
3	Verification Length							
4	(LSB)							
5	Control							

### CDB fields:

Immed	0	The Immediate Reporting option is not supported, so this bit must be 0.
BCmp	0	The Byte compare option is not supported, so this bit must be 0.
Fixed	0	The Verification Length field specifies the length of the data to be verified in bytes.
	1	The Verification field specifies the length of the data to be verified in blocks. The size of each block (in bytes) is specified by the current block length specified in the Mode Parameter block descriptor.
Verification Length	0	No data is verified. This is not considered an error and the current logical position will be unchanged.
	>0	The amount of data to be verified, in bytes or blocks as specified by the Fixed field.

# WRITE

0Ah

Zero or more blocks of data are transferred from the host to tape starting at the current logical position.

It is recommended that the Buffered Mode field of the MODE SELECT Parameter is set to either 1 or 2 so that Immediate reporting is enabled; upon a write command the drive will report GOOD status once the data is successfully transferred to the data buffer (but not necessarily to tape).

Data held in the buffer is flushed to tape in the following circumstances:

- A SCSI command is received that forces a flush:

ERASE	LOAD	LOCATE	LOG SELECT	MODE SELECT	READ
REWIND	SEND DIAGNOSTIC	SPACE	VERIFY	WRITE BUFFER	

- Buffered mode is not enabled. If buffered mode has not been set to 1 or 2, the buffer is flushed before the command completes.
- The write delay time is exceeded. This is defined by the Write Delay field of the Device Configuration Mode Select page. If the drive is idle for longer than this (no operations that access the tape have been performed), any data in the buffer is flushed to tape.

Pre-execution checks:

Illegal Field	Fixed Bit	Reservation	Deferred Error
Unit Attention	Media Access	Media Write	Diagnostic Status

Command descriptor block:

	7	6	5	4	3	2	1	0
0	Operation Code (0Ah)							
1	Reserved (0)							Fixed
2	(MSB)							
3	Transfer Length							
4								(LSB)
5	Control							

CDB fields:

Fixed	0	The Transfer Length field specifies the length of the transfer in bytes.
	1	The Transfer Length field specifies the length of the transfer in blocks. The size of each block (in bytes) is determined by the current Block Length given in the Mode Select Parameter block descriptor.
Transfer Length	0	No data is transferred. The current logical position will be unchanged.
	>0	The amount of data to be transferred, in bytes or blocks as determined by the Fixed field.

## Write specific status:

See also the “Additional Sense codes” on page 159 for a variety of possible hard errors.

An attempt to write to a write-protected cartridge will produce a CHECK CONDITION with a sense key of DATA PROTECT and additional sense of 2700h (write-protected).

An attempt to write to a cartridge whose Cartridge Memory has failed will produce a CHECK CONDITION with a sense key of MEDIUM ERROR and additional sense of 3004h (cannot write medium). If, however, the tape is not positioned at BOT, the drive will respond with sense data as if the tape is write-protected. The WP flag in the Mode Parameter Header will also be set.

If EOM (end of medium) is encountered during a write, CHECK CONDITION status is reported. The EOM flag will be set. The sense key will be set to VOLUME OVERFLOW with additional sense of 0002h (EOT). Residue information will be as below. The logical position will be EOD.

Subsequent Request Sense commands will, however, give tape position as EOP/M. It may still be possible to write a smaller quantity of information (such as filemarks or a smaller block). This is because logical position after failure to write a block returns to the start of the unwritten block.

Early Warning EOM information is reported only if a write operation is successful. This is done by reporting CHECK CONDITION status with a sense key of NO SENSE and additional sense of 0002h (EOT). Residue information is valid and indicates zero blocks/bytes.

## Residue information:

Residue information depends on two variables:

- Fixed or Variable block mode.
- Immediate or Non-Immediate Report (Buffered mode).

Block Mode	Buffered Mode	Residue
Variable	0	Number of unwritten bytes
Fixed	0	Number of unwritten blocks
Variable	not 0	Total number of unwritten bytes and marks (including those buffered before the command was received). The size can be greater than the command operation size.
	specifically 1	Contains residues of all initiators with data in the buffer.
Fixed	not 0	Total number of unwritten blocks and marks (including those buffered before the command was received). The size can be greater than the command operation size.
	specifically 1	Contains residues of all initiators with data in the buffer.

Residue information is set in the sense data byte, with the Valid bit set and the information bytes set to the residue.

# WRITE ATTRIBUTE

8Dh

The WRITE ATTRIBUTE command allows an application client to write attribute values to MAM (Medium Auxiliary Memory). Application clients should issue READ ATTRIBUTE commands before using this command to discover what support the device server has for MAM.

Pre-execution checks:

Illegal Field      Deferred Error      Unit Attention      Media Access

For this command to be executed, there must be a tape in the drive, even if it is only partially loaded.

Command descriptor block:

	7	6	5	4	3	2	1	0
0	Operation Code (8Dh)							
1	Reserved (0)							
4	Reserved (0)							
5	Volume Number (0)							
6	Reserved (0)							
7	Partition Number (0)							
8	Reserved (0)							
9	Reserved (0)							
10	(MSB)	Parameter List Length						(LSB)
13	Reserved (0)							
14	Reserved (0)							
15	Control							

CDB fields:

Volume Number	The number of the volume within the MAM. The number of volumes of the MAM must be equal to that of the tape. In the case of Ultrium, the only has a single volume, so this field is be set to 0.
Partition Number	The number of the partition within the MAM. The number of partitions of the MAM must be equal to that of the tape. In the case of Ultrium, the only has a single partition, so this field is be set to 0.
Parameter List Length	The length in bytes of the parameter list contained in the Data-Out buffer. 0 The Data-Out buffer is empty. This condition is not be considered an error. <i>n</i> The length in bytes of the parameter list contained in the Data-Out buffer.

## Parameter list format:

The parameter list has the following format. The attributes should be sent in ascending numerical order. For details of attribute data see “MAM attribute data” on page 115.

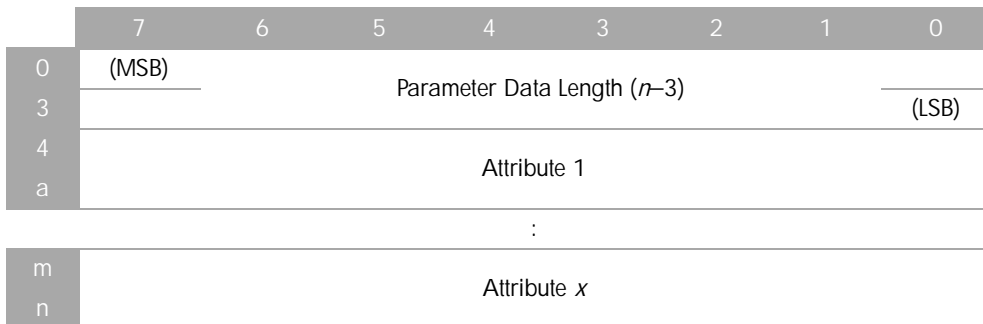

---

Parameter Data Length	This is not mandatory and will be ignored by the device server because it duplicates the Parameter List Length.
-----------------------	---

---

If the parameter data contains an attribute with an Attribute Length of zero, one of the following actions will occur:

- If the attribute is read-only or unsupported, no attributes are changes. The command fails, returning CHECK CONDITION with ILLEGAL REQUEST sense and additional sense of 2600h (invalid field in parameter list).
- If the attribute can be written to, it is deleted and will not be returned after a subsequent READ ATTRIBUTE command.
- If the attribute does not exist, the command cannot affect it. This is not considered an error.

## Write Attribute specific status:

The command will be terminated and will return CHECK CONDITION under the following circumstances:

Description	Sense Key	Additional Sense
There is no cartridge present in the drive, not even partially loaded.	NOT READY	3A00h (medium not present)
The MAM is not accessible even though there is a tape in the drive. None of the attributes are changed.	MEDIUM ERROR	0410h (MAM not accessible)
The MAM has failed (for example from a bad checksum)	MEDIUM ERROR	0COBh (MAM write error)
The Parameter List Length results in the truncation of an attribute.	ILLEGAL REQUEST	1A00h (parameter list length error)
The combination of Volume Number and Partition Number is not valid.	ILLEGAL REQUEST	2400h (invalid field in CDB)

Description	Sense Key	Additional Sense
The parameter data attempts to change a read-only attribute, that is, one that has the Read-Only bit (see "MAM attribute data" on page 115) set to one when read with the READ ATTRIBUTE command. None of the attributes are changed.	ILLEGAL REQUEST	2600h (invalid field in parameter list)
The parameter data contains an attribute with an incorrect Attribute Length field value. None of the attributes are changed.	ILLEGAL REQUEST	2600h (invalid field in parameter list)
The parameter data contains an attribute with an unsupported Attribute Value field value. None of the attributes are changed.	ILLEGAL REQUEST	2600h (invalid field in parameter list)
The attributes are not in ascending order in the Parameter List. None of the attributes are changed.	ILLEGAL REQUEST	2600h (invalid field in parameter list)
There is not enough space to write all the attributes to the MAM. None of the attributes are changed.	ILLEGAL REQUEST	5506h (MAM full)

# WRITE BUFFER

3Bh

Write Buffer is used to transfer data into memory on the drive for the purposes of diagnostics, tests or firmware upgrade. The data is placed into one of the drive buffers depending on the Mode and Buffer ID fields of the command.

**CAUTION:** Do not attempt to use the buffer modifying functions of this command unless you really know what you are doing. The buffer modifying functions are intended as a diagnostic aid to be used in conjunction with the Read Buffer command. It is not possible to modify data in the buffer so that it subsequently written to media because all host data is flushed before executing the command.

The firmware download functions are intended for use by manufacturing and by customers using upgrade utilities supplied by HP.

Pre-execution checks:

Illegal Field      Reservation      Deferred Error      Unit Attention

Command descriptor block:

	7	6	5	4	3	2	1	0
0	Operation Code (3Bh)							
1	Reserved (0)				Mode			
2	Buffer ID							
3	(MSB) Buffer Offset (LSB)							
5								
6	(MSB) Parameter List Length (LSB)							
8								
9	Control							

CDB fields:

- Mode** This field can be set to one of the following values:
- 00h** The drive transfers a 4-byte header from the host (which should be set to zeros), followed by (*allocation length* – 4) bytes of data. The data is written into the buffer identified by the Buffer ID, starting from offset zero in the buffer.  
The Buffer ID and Buffer Offset must both be zero. Allocation Length must not exceed (*buffer size* + 4).
  - 02h** The drive transfers allocation length bytes of data from the host, bytes of data which is placed in the buffer indicated by Buffer ID, starting from Buffer Offset from the start of the buffer. No header is sent.  
The Buffer Offset and Allocation Length must be kept within the buffer size, and the Buffer ID must to set to one of the valid values.

04h	<p>This mode is used to transfer new firmware to the drive. The drive receives Allocation Length bytes of data from the host. The data is stored in the drive's buffer. The location in the buffer at which the data is written is determined by the firmware.</p> <p>The firmware image is divided into a number of blocks of data which are sent to the drive using multiple Write Buffer commands.</p> <p>All the firmware image data should be transferred using this mode.</p> <p>The Buffer ID and Buffer Offset are ignored.</p>
05h	<p>This mode is used to indicate that the complete firmware image has been sent to the drive. This is the signal for entering the FLASH reprogramming stage of the firmware upgrade process.</p> <p>Once this command has been received, and the associated data stored in the buffer, the resident firmware checks the validity of the image that has been received. If this seems to be correct, the Firmware Upgrade operation will commence. If any faults are detected in the format of the image, the drive will report CHECK CONDITION to the host. The sense key is ABORTED COMMAND, and the additional sense is set to 2600h (invalid field in parameter list).</p> <hr/> <p><b>CAUTION:</b> Once this command has been sent and completed, the drive's power supply must not be interrupted until the drive has completed the firmware upgrade.</p> <hr/> <p>The Buffer ID and Buffer Offset are ignored.</p>
0Ah/ 1Ah	<p>This mode is used to write to the Echo Buffer.</p> <p>The Buffer ID and Offset are ignored.</p>
Buffer ID	<p>Specifies which buffer to read.</p> <p>00h Main buffer (RAM) Offset Boundary: 1 byte</p> <p>01h Processor addressable memory (RAM) Offset Boundary: 1 byte</p> <p>02h SCSI burst buffer (RAM) Offset Boundary: 4 bytes or FC burst buffer (RAM) Offset boundary: 512 bytes</p> <p>13h PCA EEPROM Offset Boundary: 1 byte</p> <p>20h Main buffer segment 0 (RAM) — see below for description</p> <p>21h Main buffer segment 1 (RAM) — see below for description</p> <p>22h Main buffer segment 2 (RAM) — see below for description</p> <p>23h Main buffer segment 3 (RAM) — see below for description</p> <p>24h Main buffer segment 4 (RAM) — see below for description</p> <p>25h Main buffer segment 5 (RAM) — see below for description</p> <p>26h Main buffer segment 6 (RAM) — see below for description</p> <p>27h Main buffer segment 7 (RAM) — see below for description</p>
Buffer Offset	<p>Where in the buffer the data should be written. This must be smaller than the size of the buffer and must obey the specified offset boundary. When downloading new firmware, this field is ignored.</p>
Parameter List Length	<p>The amount of data. This must be smaller than the difference between the Buffer Offset field and the size of the buffer.</p>



## Memory sizes

### Main buffer memory:

The Main Buffer memory is 128 MB.

Areas of the Main Buffer memory are used by the firmware. These should not be written to and should not be expected to retain values that are written to them. Any Write and Read Buffer tests can be performed while the drive is idle. If the drive is reading or writing, the data being written or read can be corrupted.

Since the drive has more than 16 MB of Main Buffer memory, additional buffer IDs have been defined to allow the whole buffer to be accessed in 16 MB segments. These are defined as follows:

Buffer ID	Address
20h	00000000h + Buffer Offset (same as Buffer ID 00h)
21h	01000000h + Buffer Offset (that is, +16 MB)
22h	02000000h + Buffer Offset (that is, +32 MB)
23h	03000000h + Buffer Offset (that is, +48 MB)
24h	04000000h + Buffer Offset (that is, +64 MB)
25h	05000000h + Buffer Offset (that is, +80 MB)
26h	06000000h + Buffer Offset (that is, +96 MB)
27h	07000000h + Buffer Offset (that is, +112 MB)

### Main processor memory:

Not all the Processor memory space is accessible. Take care when writing to any addresses within this buffer.

### SCSI burst buffer:

Addressable range from 00000h through 3F8000h.

### PCA EEPROM:

The write range is limited to 500h bytes, starting at 100h (TapeTools area).

# WRITE FILEMARKS

10h

WRITE FILEMARKS causes the specified number of filemarks to be written beginning at the current logical position on tape.

If the Immed bit is set, GOOD status may be reported and the marks left in the data buffer. Otherwise, all buffered data and marks are written before status is reported.

If zero filemarks are to be written, the Immed bit must be zero. The drive writes any buffered data and marks to tape before reporting. This is the recommended way for a host to flush the buffer.

Pre-execution checks:

Illegal Field	Reservation	Deferred Error	Unit Attention
Media Access	Media Write	Diagnostic Status	

Command descriptor block:

	7	6	5	4	3	2	1	0
0	Operation Code (10h)							
1	Reserved (0)						WSmk	Immed
2	(MSB)	Number of Filemarks						(LSB)
4								
5	Control							

CDB fields:

Immed	0	Status will not be returned until the operation is complete.
	1	The drive returns GOOD status following the pre-execution checks (that is, before the command starts executing).
WSmk	0	This bit is not supported and must be set to zero.
Number of Marks	0	Zero is valid only when immediate report is disabled.
	>0	This number of filemarks is to be written.

Specific status:

Write Filemark sense is identical to status for the Write command.

# Glossary

algorithm	rigorous set of rules for a procedure. In the context of data compression, the rules are for transforming the way data is represented.
ANSI	American National Standards Institute, which sets standards for, amongst other things, SCSI and the safety of electrical devices.
asynchronous	<i>see</i> data transfer phase
BOM	Beginning Of Media. The first point on the tape that can be accessed by the drive.
checksum	The sum of a series of bytes written to the tape, which can be checked against the sum of the same series of bytes when the tape is read in order to identify errors.
compression	A procedure in which data is transformed by the removal of redundant information in order to reduce the number of bits required to represent the data.
compression ratio	A measure of how much compression has occurred, defined as the ratio of the amount of uncompressed data to the amount of compressed data into which it is transformed. The LTO-DC algorithm can typically achieve a compression ratio of between 2:1 and 4:1 depending on the nature of the data.
data set	A fixed-size block of compressed host information.
data transfer phase	After accepting a command from the host (initiator), the tape drive (target) sets the SCSI bus to transfer the data associated with the command. Information is transferred in one of three ways, depending on the negotiated settings between initiator and target. The simplest (and slowest) is <i>asynchronous</i> , where the target requests the transfer of each byte or word, then must wait for the initiator to signal that the byte or word has been transferred before it starts the next byte transfer. <i>Synchronous</i> transfers allow the target to request many transfers at once, up to a limit agreed between initiator and target at startup. Only once the "credit" has been used up, does the target have to pause and wait for the initiator to signal successful transfer of the words. Ultra320 SCSI introduces a faster still method called <i>paced</i> transfers; these are similar in concept to synchronous transfers. Asynchronous and synchronous transfers may take place either with eight-bit bytes ("narrow") or sixteen-bit words ("wide"). Paced transfers are always wide.
decompression	A procedure in which the original data is generated from compressed data.
DSIT	Data Set Information Table. Part of the data set that describes its contents.

ECMA	European Computer Manufacturers Association. The European equivalent of ANSI.
enhanced commands	SCSI commands that are vendor-unique and not part of the common SCSI set.
EOD	End Of Data. An area that signifies the end of the valid data. If new data is written over a larger quantity of old data, it is possible for data to exist after EOD, but because it is after EOD, this old data is no longer valid.
EOM	End Of Media format. The last usable point on the tape.
EW-EOM	Early Warning End Of Media. A physical mark or a device-computed position on the tape that tells the drive that it is approaching EOM.
filemark	A mark written by the host. It does not necessarily separate files; it is up to the host to assign a meaning to the mark.
filemark count	The number of filemarks written since the beginning of the current tape up to and including the current group.
FRU	Field Replaceable Unit, an assembly or group of components that is replaced in its entirety by Service Engineers when it contains a fault.
host	The host computer system acting as controller for the drive.
immediate mode	A mode of responding to SCSI commands where the drive or other peripheral does not wait until the command has finished before returning status information back to the host. For writing filemarks, Immediate mode can significantly improve the performance of systems that do not set the Immediate bit when sending a SCSI Write Filemarks command. On the other hand, data is not flushed to tape in response to a filemark command.
load	The process in which the drive takes in an inserted cartridge and goes online.
LUN	Logical Unit Number, by which different devices at a particular SCSI ID can be addressed individually. The drive has a fixed LUN of 0.
LVD	Low-Voltage Differential. <i>See</i> SCSI.
RAW	<i>see</i> read-after-write
read-after-write	RAW improves data integrity by reading data immediately after it is written and writing the data again if an error is found.
reserved	Not generally available for use with the drive. A reserved field should contain all zero bits.

## SCSI

Small Computer System Interface—a standard command specification and command set that enables computers and peripherals to communicate with each other. HP's Ultrium drives adhere to the SCSI specifications (see Chapter 1, "Interface Implementation" in Volume 3, *The SCSI Interface*, of the HP Ultrium Technical Reference Manual) and support all features required by those standard.

## Single-Ended and Low Voltage Differential SCSI

These terms define how the signals are transmitted along the cable.

With *single-ended* (SE) SCSI, each signal travels over a single wire and each signal's value is determined by comparing the signal to a paired ground wire. Signal quality tends to decrease over longer cable lengths or at increased signal speed.

With *low voltage differential* (LVD) signaling, signals travel along two wires and the difference in voltage between the wire pairs determines the signal value. This enables faster data rates and longer cabling with less susceptibility to noise than SE signaling and reduced power consumption.

## Narrow and Wide, Fast, Ultra SCSI and above

*Narrow* SCSI devices can transfer data one byte at-a-time (and are sometimes called "8-bit SCSI" devices). They can conform to either the SCSI-2 or SCSI-3 protocols. They have a 50-pin connection to the SCSI bus.

*Wide* SCSI devices can transfer two bytes of data simultaneously ("16-bit SCSI"). They usually have a single, 68-pin connection to the SCSI bus. (This physical arrangement is part of the SCSI-3 specification.) They may support either SCSI-2 or SCSI-3 protocols. Wide and narrow devices can simultaneously be connected to the same bus without problem, provided certain rules are followed.

*Fast* SCSI can transfer data at up to 20 MB/s wide, using a cable of up to 6 meters total length.

*Ultra* SCSI can transfer data at up to 40 MB/s wide, but the cable length cannot exceed 3 meters (it is also known as "Fast20").

*Ultra2* SCSI can transfer data at up to 80 MB/s wide, using a cable of up to 25 meters total length for a single device, or up to 12 meters for two or more devices (it is also known as "Fast40").

*Ultra3* or *Ultra160* can transfer data at up to 160 MB/s wide. Cable lengths are as for *Ultra2*.

*Ultra4* or *Ultra320* transfer data at up to 320 MB/s. Cable lengths are as for *Ultra2*.

Ultra SCSI supports both SE and LVD interfaces. In normal situations, slower devices can coexist with faster devices, and narrow devices can be used on the same SCSI bus as wide devices using a suitable adapter.

HP's Generation 1 Ultrium drives are Ultra2, wide SCSI-3 compatible devices. They can be used with both LVD and SE host bus adapters.

Generation 2 Ultrium drives are Ultra160, wide SCSI-3 compatible.

Generation 3 Ultrium drives are Ultra320 compatible; however for performance reasons they should not be used on an SE bus.

sense data	Data returned after the execution of a SCSI command, telling the host whether the transaction was successful, and if not, what went wrong.
sequential access	Sequential access devices store data sequentially in the order in which it is received. Tape devices are the most common sequential access devices. Devices such as disk drives are direct access devices, where data is stored in blocks, not necessarily sequentially. Direct access allows for speed of retrieval, but is significantly more costly.
single-ended	<i>see</i> SCSI
spacing	Spacing is moving along the tape over a specified number of blocks or filemarks, or to EOD, in order to find data quickly.
sub-data set	One sixteenth of a data set
synchronous	<i>see</i> data transfer phase
TapeAlert	A set of 64 flags is held in the TapeAlert log that indicate faults or predicted faults with the drive or the media. By reading this log, host software can inform the user of existing or impending conditions, and can, for example, advise the user to change the tape.
vendor-unique	The addition of commands to SCSI that are not included in the standard.

# Index

## A

- abort handling 14
- Aborted Command 158
- additional sense codes 149, 150, 152, 159
- addressing, fibre channel 18
- algorithms 187
  - compression 80
  - decompression 80
- ANSI 7, 187
- append error 162
- ASC/Q 159
- asynchronous 187
- asynchronous data transfer 11
- asynchronous transfers 187
- attribute data 115
- attributes
  - ID values 116
  - standard device types 116
  - standard host type 118
  - standard medium type 118
  - writing 180

## B

- Bad LUN check 30
- bit pointer 151
- BLANK CHECK 158
- blank media, met during read 108
- blocks, spacing over 173
- BOM 149, 150, 187
  - detected 159
  - met during space 173
- BOP, met during space 173
- BPV bit 151
- brackets, round, square 73
- buffer
  - echo 121, 184
  - reading 121
  - writing 180, 183

- buffered data, flushed to tape 178
- burst size 78
- bus device deferred errors 157
- bus device reset 13, 155
- bus inactivity limit 78
- bus parity errors 15
- BUSY status 27

## C

- capacity data 124
- cartridge memory
  - accessible in hold position 50, 79
  - failed 51, 179
  - size 123
- cartridges
  - faulty 162
  - removal prevented 162
- CDB 35
- CD-ROM Emulation/Disaster Recovery Mode page 94
- CD-ROM mode
  - READ 10 command 110
  - READ CAPACITY command 124
  - READ TOC command 131
  - SEEK command 167
  - START/STOP command 175
- CHECK CONDITION 27
- checksum 187
- cleaning 151, 161
- cleaning cartridge 161
- Cleaning Needed sense data descriptor 154
- clearing logs 55
- CLN bit 151
- command descriptor block 35
- command phase error 162
- commands 37
  - enhanced 188

- ERASE 38
- INQUIRY 39
- LOAD/UNLOAD 50
- LOCATE 53
- LOG SELECT 55
- LOG SENSE 57
- MODE SELECT 71
- MOVE MEDIUM 105
- overlapping 162
- PERSISTENT RESERVE IN 98
- PERSISTENT RESERVE OUT 101
- READ 106
- READ 10 21, 110
- READ 6 21
- READ ATTRIBUTE 111
- READ BLOCK LIMITS 120
- READ BUFFER 121
- READ CAPACITY 21, 124
- READ MEDIA SERIAL NUMBER 125
- READ TOC 21, 131
- RECEIVE DIAGNOSTIC RESULTS 133
- RELEASE UNIT 135
- REPORT DENSITY SUPPORT 137
- REPORT DEVICE IDENTIFIER 140
- REPORT LUNS 141
- REPORT SUPPORTED OPCODES 143
- REPORT SUPPORTED TASK MANAGEMENT FUNCTIONS 145
- REQUEST SENSE 147
- RESERVE UNIT 164
- REWIND 166
- SEEK 21, 167
- SEND DIAGNOSTIC 168
- SET CAPACITY 170

SET DEVICE IDENTIFIER 171  
 SPACE 172  
 START/STOP 21, 175  
 supported 12  
 VERIFY 177  
 WRITE 178  
 WRITE ATTRIBUTE 180  
 WRITE BUFFER 183  
 WRITE FILEMARKS 186  
 compatibility 161  
 compression 187  
   algorithm 80  
   ratio 187  
 control byte 35  
 control field 35  
 Control Mode page 79  
 current sense 154  
   clearing 155

**D**

Data Compression  
   Capable bit 80  
   Characteristics Mode page 79  
   Enable bit 80  
   log 68  
   SDCA 81  
 data compression 187  
   algorithm 80  
 data decompression algorithm 80  
 Data Decompression Enable bit 80  
 data phase error 162  
 DATA PROTECT 158  
 data transfer  
   asynchronous 11  
   synchronous 11  
 data transfer phase 187  
 DCC bit 80  
 DCE bit 80  
 DDE bit 80  
 decompression 187  
   algorithm 80  
 Deferred Error check 30  
 DEFERRED ERROR sense 156

deferred errors 149, 150, 152  
 descriptor format sense data 152  
 Device Configuration page 81  
 Device Status log 70  
 Device Time Mode page 92  
 Diagnostic Status check 31  
 diagnostics 133  
   failure 162  
   sending 168  
 disconnect strategy 16  
 Disconnect-Reconnect Mode page 78  
 documents, related 7  
 Drive Error Code sense data descriptor 154  
 drive error codes 151, 163  
 DSIT 187  
 DTD primary port status 64  
 DTD Status Log page 62

**E**

echo buffer 121, 184  
 ECMA 188  
 ejection failure 162  
 enhanced commands 188  
 EOD 188  
   detected 159  
   met during locate 54  
   met during read 108  
   met during space 173  
   not found 160  
   spacing to 173  
 EOM 149, 150, 188  
   detected 159  
   met during locate 54  
   met during read 108  
   met during space 173  
 EOP, met during space 173  
 ERASE command 38  
 erase, failure 162  
 error codes 148, 163  
   drive 151  
 errors  
   bus device deferred 157  
   command phase 162

counters 60  
 data phase 162  
 deferred 149, 150, 152  
 invalid message 162  
 message 162  
 parity 162  
 read, unrecovered 159  
 sequential positioning 161  
 write 159  
   write append 162  
   write-behind deferred 156

EVPD bit 39  
 EW-EOM 188  
   met during locate 54

**F**

failed cartridge memory 51, 179  
 faults, predicting 65  
 fibre channel  
   addressing 18  
   names 18  
 Fibre Channel Logical Unit Control Mode page 84  
 fibre channel operation 18  
 Fibre Channel Port Control Mode page 85  
 field pointer 151  
 field replaceable units 20  
 field, invalid 160  
 filemark count 188  
 filemarks 149, 150, 188  
   detected 159  
   met during read 108  
   met during space 173  
   spacing over 173  
   writing 186  
 Fixed bit 107, 178  
 Fixed Bit check 31  
 fixed format sense data 148  
 Flag Link check 31  
 flush, buffered data 178  
 format, corrupt 161  
 FRUs 20, 188



- G**  
 GOOD status 27  
 group code 35
- H**  
 HARDWARE ERROR 157  
 heads, cleaning 151  
 hold bit 50  
 hold position 50, 79  
 Host 188
- I**  
 IDENTIFY message, invalid bits 161  
 identifying LUNs 15  
 ILI bit 149, 150  
 Illegal Command check 31  
 Illegal Field check 31  
 ILLEGAL REQUEST 158  
 immediate mode 188  
   during writing 178  
 Information Exceptions Mode page 91  
 Information sense data descriptor 153  
 INQUIRY  
   command 39  
   data pages 40  
   Defined Identifiers page 46  
   Device Identification page 45  
   drive component revision levels pages 49  
   extended INQUIRY data VPD page 48  
   sequential access device capabilities page 48  
   Unit Serial Number page 45  
 interface, SCSI 11
- L**  
 libraries, fibre channel addressing 20  
 Load bit 50  
 LOAD/UNLOAD command 50
- Load/Unload Specific Status 51  
 loading 188  
   failure 162  
   tape 51  
 localization identifiers 119  
 LOCATE command 53  
 LOG SELECT command 55  
 LOG SENSE 57  
   Data Compression Log page 68  
   Device Status Log page 70  
   DTD Status Log page 62  
   parameter pages 58  
   Performance Data Log page 69  
   Read Error Counters Log page 60  
   Sequential Access Device Log page 61  
   Supported Log Pages page 59  
   Tape Capacity Log page 68  
   Tape Usage Log page 67  
   TapeAlert Log page 65  
   Temperature Log page 62  
   Write Error Counters Log pages 60
- logs  
   clearing 55  
   Data Compression 68  
   Device Status 70  
   parameter pages 58  
   Performance Data 69  
   reading 57  
   supported 59  
   Tape Capacity 68  
   Tape Usage 67  
   TapeAlert 65, 190
- LUN 188  
   becoming ready 159  
   identifying 15  
   not ready 159  
   not self-configured 162  
   not supported 160
- LVD 188
- M**  
 MAM  
   accessible 162  
   attribute data 115  
   full 163  
   inaccessible 159  
   reading 111  
   write error 159  
   writing 180  
 Margin Control mode sub-page 88  
 Mark bit 149, 150  
 Media Access check 32  
 Media Information check 33  
 Media Write check 33  
 MEDIUM ERROR 157  
 Medium Partitions Mode page 83  
 messages 23  
   error 162  
   invalid 162  
   supported 11  
 microcode download 162  
 Mode Parameter pages 72  
 MODE SELECT  
   CD-ROM Emulation/Disaster Recovery Mode page 94  
   command 71  
   Control Mode page 79  
   Data Compression Characteristics page 79  
   Device Configuration page 81  
   Device Time Mode page 92  
   Disconnect-Reconnect page 78  
   Fibre Channel Logical Unit Control Mode page 84  
   Fibre Channel Port Control Mode page 85  
   Information Exceptions Mode page 91  
   Medium Partitions page 83  
   Mode Parameter header 74  
   Mode Parameter pages 72

Read-Write Error Recovery  
page 76  
SCSI LUN Control Mode  
page 84  
SCSI Port Control Mode  
page 87  
monitoring condition 65, 190  
MOVE MEDIUM command  
105  
multi-initiator support 17

## N

names, fibre channel 18  
Negotiated Settings mode sub-  
page 89  
NO SENSE 157  
NOT READY 157

## O

opcode 35  
unrecognized 160  
overlapping commands 162

## P

paced transfers 187  
parallel protocol request 26  
Parameter List check 34  
parameter list, invalid field 160  
parameter rounding 161  
parity error 162  
Performance Data log 69  
PERSISTENT RESERVE IN  
command 98  
PERSISTENT RESERVE OUT  
command 101  
polling delay 64  
power-on 155  
PPR 26  
pre-execution checks 30  
Bad LUN 30  
Deferred Error 30  
Diagnostic Status 31  
Fixed Bit 31  
Flag Link 31  
Illegal Command 31  
Illegal Field 31

Media Access 32  
Media Information 33  
Media Write 33  
Parameter List 34  
Reservation 34  
Unit Attention 34  
prevent media removal 162  
PREVENT/ALLOW MEDIUM  
REMOVAL 105  
problems, predicting 65

## R

RAW 188  
READ 10 command 21, 110  
READ 6 command 21  
READ ATTRIBUTE command  
111  
READ BLOCK LIMITS command  
120  
READ BUFFER command 121  
Read Capabilities service  
action 100  
READ CAPACITY command  
21, 124  
READ command 106  
Read Error Counters Log page  
60  
Read Keys service action 99  
READ MEDIA SERIAL NUMBER  
command 125  
Read Reservation service action  
99  
READ TOC command 21, 131  
reading  
error 159  
failure 54, 108  
logs 57  
Read-Write Error Recovery  
Mode page 76  
RECEIVE DIAGNOSTIC  
RESULTS command 133  
RELEASE UNIT command 135  
REPORT DENSITY SUPPORT  
command 137  
REPORT DEVICE IDENTIFIER  
command 140  
REPORT LUNS command 141

REPORT SUPPORTED  
OPCODES command 143  
REPORT SUPPORTED TASK  
MANAGEMENT  
FUNCTIONS command 145  
Report Transfer Capabilities  
mode sub-page 90  
REQUEST SENSE  
command 147  
data 148  
reselect failure 162  
Reservation check 34  
RESERVATION CONFLICT  
status 27  
reservations, releasing 135  
RESERVE UNIT command 164  
reserved field 35, 188  
reset 155  
strategy 13  
REWIND command 166  
rounding 161

## S

Saved Training Configuration  
Values mode sub-page 88  
SCSI 7, 11, 189  
commands 37  
interface 11  
messages 23  
parity error 162  
supported messages 11  
SCSI LUN Control Mode page  
84  
SCSI Port Control Mode page  
87  
SCSI-2, support 13  
SCSI-3 11  
SDTR 25  
SEEK command 21, 167  
select failure 162  
self-test 133, 168  
SEND DIAGNOSTIC command  
168  
sense  
DEFERRED ERROR 156  
UNIT ATTENTION 155  
sense data 190

- descriptor format 152
- fixed format 148
- management 154
- sense data descriptors
  - Cleaning Needed 154
  - Drive Error Code 154
  - Information 153
  - Sense Key Specific 153
  - Stream Commands 154
- Sense Key Specific sense data descriptor 153
- sense keys 149, 150, 157
  - specific bytes 149, 150
- sequential access 190
- Sequential Access command set 11
- Sequential Access Device Log page 61
- sequential positioning error 161
- service actions 112
  - Read Capabilities 100
  - Read Keys 99
  - Read Reservation 99
- SET CAPACITY command 170
- SET DEVICE IDENTIFIER command 171
- SILI 107
  - bit 107
  - error 108
- SKSV bit 149, 150
- SPACE command 172
- spacing 190
- START/STOP command 21, 175
- status
  - BUSY 27
  - byte 26
  - CHECK CONDITION 27
  - GOOD 27
  - RESERVATION CONFLICT 27
- Stream Commands sense data descriptor 154
- Summary 29
- supported commands 12
- Supported Log Pages page 59
- synchronous 190
- synchronous data transfer 11
- synchronous data transfer request 25
- synchronous transfers 187
- T
- tape
  - faulty 162
  - incompatible 161
  - loaded 155
  - loading 51
  - removal prevented 162
  - unloading 51
- Tape Capacity log 68
- Tape Usage log 67
- TapeAlert log 190
- TapeAlert Log page 65
- Temperature Log page 62
- text localization identifiers 119
- third-party, reserving for 135
- TOC data 132
- U
- Unit Attention check 34
- UNIT ATTENTION sense 155, 158
- UNLOAD command 50
- unloading tape 51
- V
- Vendor-Unique 190
- VERIFY command 177
- very high frequency data 62, 63
- very high frequency polling delay 64
- VHF 62, 63
- Volume Overflow 158
- W
- WDTR 25
- wide data transfer request 25
- WORM cartridges 82
- write
  - append error 162
  - error 159
- WRITE ATTRIBUTE command 180
- WRITE BUFFER command 183
- WRITE command 178
- write delay time 81
- Write Error Counters Log page 60
- WRITE FILEMARKS command 186
- write-behind deferred errors 156
- write-protection 160
- WSmk bit 186



## Free Manuals Download Website

<http://myh66.com>

<http://usermanuals.us>

<http://www.somanuals.com>

<http://www.4manuals.cc>

<http://www.manual-lib.com>

<http://www.404manual.com>

<http://www.luxmanual.com>

<http://aubethermostatmanual.com>

Golf course search by state

<http://golfingnear.com>

Email search by domain

<http://emailbydomain.com>

Auto manuals search

<http://auto.somanuals.com>

TV manuals search

<http://tv.somanuals.com>