

hp
photosmart
620 series
digital
camera



user's manual



Trademark and copyright information

© Copyright 2002 Hewlett-Packard Company

All rights are reserved. No part of this document may be photocopied, reproduced, or translated to another language without the prior written consent of Hewlett-Packard Company.

The information contained in this document is subject to change without notice. Hewlett-Packard shall not be liable for errors contained herein or for consequential damages in connection with the furnishing, performance, or use of this material.

Microsoft® and Windows® are U.S. registered trademarks of Microsoft Corporation.

Apple, Macintosh, and Mac are registered trademarks of Apple Computer, Inc.



SD Logo is a trademark.

Materials disposal

This HP product contains the following materials that might require special handling at end-of-life:

- Alkaline manganese dioxide-zinc or lithium-iron disulfide AA batteries.
- Lead in the solder and some component leads.

Disposal of this material can be regulated because of environmental considerations. For disposal or recycling information, please contact your local authorities or the Electronic Industries Alliance (EIA) (www.eiae.org).

Table of Contents

1-Getting started

Camera parts	8
Setup	12
Attaching the wrist strap	12
Inserting the batteries	12
Inserting the memory card (optional)	13
Turning on power	13
Choosing the language	14
Setting the date and time	14
Installing the software	15
Windows	15
Macintosh	15

2-Taking pictures

Taking still pictures	17
Using focus lock	18
Using instant review	18
Recording video clips	18
Using Preview mode	20
Using the self-timer	20
Using zoom	21
Optical zoom	21
Digital zoom	21
Using the flash	22
Changing the image quality	23

3-Using Playback and the Main menu

Using Playback mode	25
Reviewing images	26
Reviewing video clips	26
Using the Main menu	27
Rotating images	27
Deleting images	28

Viewing thumbnail images	29
Magnifying images	29
Using the Setup menu	30
Date & Time	30
Welcome Screen	30
USB Configuration	31
Move Images to Card	31
Language	32
Exit	32
4-Using hp instant share	
Using hp instant share to print pictures	35
Using the hp instant share e-mail service	35
Adding, modifying, and removing e-mail addresses	36
Selecting images to be e-mailed	37
Windows	38
Macintosh	38
5-Unloading, printing, and displaying images	
Unloading to a computer	39
Printing images	40
Displaying images on a TV	41
Displaying a slideshow	41
6-Troubleshooting and support	
Problems and solutions	43
Error messages	50
Error messages on the camera	50
Error messages on the computer	53
Getting assistance	53
Finding help on the web	53
HP product support	53
HP photosmart website	53
HP accessibility website	53

Contacting hp customer support	54
How hp can help	54
Before you call	54
Obtaining support in the United States	54
Free telephone support for one year	54
After the first year	55
Upgraded warranty options	55
Obtaining support worldwide	56
Hewlett-Packard limited warranty statement	58
Regulatory information	60
Appendix A: Batteries and accessories	
Managing batteries	61
Extending battery life	62
Rechargeable batteries	62
Power conservation.	62
Purchasing accessories.	63
Appendix B: Camera dock	
Unloading images to a computer using the dock	67
Printing images using the dock	68
Displaying images on a TV using the dock.	68
Appendix C: Reference	
Camera specifications	69

1 Getting started

The HP Photosmart 620 digital camera is a 2.1 mega-pixel camera with 3x optical zoom and 4x digital zoom capability, and 8 MB of internal memory. You can add additional memory by purchasing an optional memory card.

You can use the **Share** menu to select images that you want to print or e-mail. Then, you automatically e-mail or print your selected pictures when you connect to your computer. You can bypass the computer altogether and print your selected pictures directly on certain HP printers.

You can enhance your experience by purchasing an HP Photosmart 8881 Camera Dock. The Camera Dock allows you to easily download images to a computer, send images to a printer, or view images on a television (TV) individually or as a slideshow.

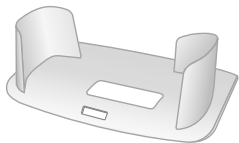

NOTE A camera Dock Insert is included in your camera box. This insert enables your camera (and others of the same model) to use the HP Camera Dock.

Please do not use it without the Camera Dock, and **DO NOT** discard it. Instructions for its use are included with the Camera Dock as well as in Appendix B of this manual.



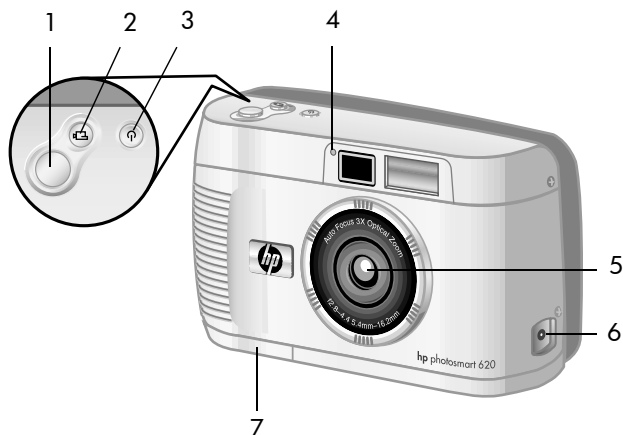





Camera parts

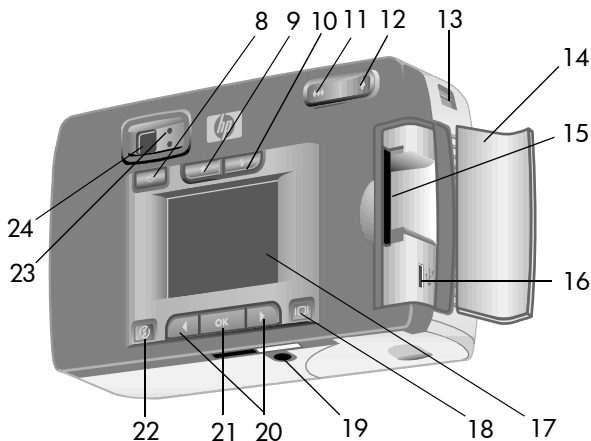



#	Name	Description
1	Shutter button	Focuses and locks the exposure of the camera when pressed halfway down, and takes the picture when pressed all the way down
2	 Video button	Records a video clip; press once to start and press again to stop
3	 Power button	Turns the camera power on and off
4	Video/self-timer light	<ul style="list-style-type: none">● Solid red indicates that the camera is recording video● Blinking red indicates that the self-timer is activated

#	Name	Description
5	Zoom lens	3x optical zoom lens allows you to take telephoto and wide angle pictures
6	Power adapter connector	Allows you to connect an optional HP AC power adapter to the camera to operate the camera without batteries, or to charge optional rechargeable batteries
7	Battery door	Allows access to the batteries



#	Name	Description
8	 Self-timer button	Sets the 10 second self-timer for pictures and video clips
9	 Quality button	Increases image quality from Good to Better to Best
10	 Flash button	Selects the Flash setting
11	 Zoom Out button	Zooms the lens to wide angle position
12	 Zoom In button	Zooms the lens to telephoto position
13	Wrist strap mount	Wrist strap attachment
14	Memory card door	Provides access to the memory card and USB connector
15	Memory card slot	Slot where memory card is inserted

#	Name	Description
16	USB connector	Provides connection to either a computer or printer by using a USB cable
17	Image display	Provides menu information to operate the camera; you can also preview the picture before taking it and review it afterward
18	 Display button	Activates Preview mode or turns off the image display
19	Tripod mount	Allows camera to be mounted to a tripod
20	 Arrow buttons	Move to menu options and navigate through images
21	OK button	Switches to Playback mode and selects menu options
22	 Share button	Turns the HP Instant Share menu on and off
23	Viewfinder light	<ul style="list-style-type: none"> ● Blinking orange indicates that the camera is busy or is experiencing an error ● Blinking green indicates that the camera can't focus or that you need to hold it steady for a long exposure
24	Optical viewfinder	Allows you to frame the subject of the picture

Setup

Attaching the wrist strap

Attach the wrist strap as shown in the illustration.

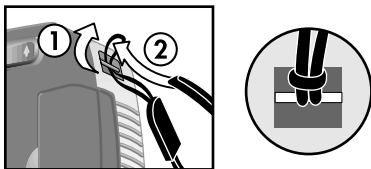

NOTE It is easiest to install the wrist strap by inserting it from the bottom of the camera.

Inserting the batteries

1 Open the battery door on the bottom of the camera.

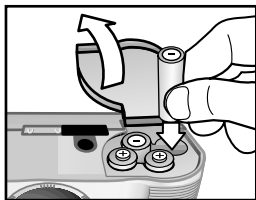

2 Insert the batteries as indicated.

NOTE For more information about batteries, see **Appendix A: Batteries and accessories** on page 61.

Inserting the memory card (optional)

Your digital camera contains 8 megabytes (MB) of internal memory to store images and video clips. You can also use a memory card (purchased separately) to store more images and video clips. After you unload images to a computer, you can reuse the card.

- 1 Open the memory card door.

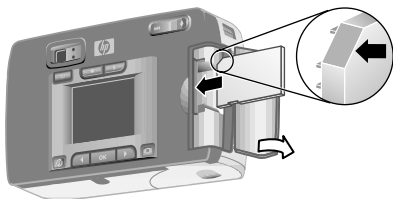

- 2 Insert the memory card as shown.
- 3 Close the memory card door.

To remove the memory card, pull the card out.

Turning on power

- Press the **Power**  button to turn on the camera. When the camera is ready, the orange viewfinder light is solid.



Choosing the language

The first time you turn the camera on, the following screen appears and prompts you to choose a language.

- 1 Scroll to the language that you want by using the **Arrow** ◀ ▶ buttons.
- 2 Press **OK** to select the highlighted language.



Setting the date and time

- 1 Press **OK** repeatedly until your preferred date format appears (M = month, D = day, Y = year). Press the right **Arrow** ▶ button to highlight the date.
- 2 Press **OK** to select the first value, and then use the ◀ ▶ buttons to change it. Press **OK** to confirm. Set the remaining values in the same way.
- 3 Press the ▶ button to highlight the time format, and then press **OK** if you want to change it.
- 4 Press the ▶ button to highlight the time. Set the time values in the same way you set the date values in step 2.
- 5 When finished setting the date and time, press the ▶ button to highlight **Exit**, and then press **OK**.

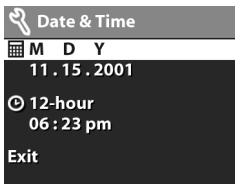

If the batteries are removed from the camera for longer than ten minutes, you might need to reset the date and time. For more information about batteries, see **Appendix A: Batteries and accessories** on page 61.

Installing the software

The software allows you to unload images from the camera, view them, print them, and e-mail them. It also allows you to configure the **Share** menu on the camera.

Windows

1 Insert the HP Photo & Imaging CD into the CD drive of your computer. The installation window automatically appears.

NOTE If the installation window does not appear, click **Start**, and then click **Run**. Type *X:\Setup.exe*, where *X* is the letter of your CD drive.

2 Click **Next**, and then follow the on-screen instructions to install the software.

To install any bonus software

1 Click **Start**, click **Run**, and in the **Open** box, type *X:\Bonus\setup.exe* (where *X* is the drive letter of your CD drive).

2 Click **OK**, and then follow the on-screen instructions to install the bonus software.

Macintosh

1 Insert the HP Photo & Imaging CD into the CD drive of your computer.

2 Double-click the CD icon on the desktop.

3 Double-click the installer icon.

4 Follow the on-screen instructions to install the software.

To install any bonus software

- 1 Double-click the installer icon located in the Bonus folder on the CD.
- 2 Follow the on-screen instructions to install the bonus software.

2 Taking pictures

Taking still pictures

You can take a picture with the image display on or off. To take a picture:

- 1 Frame the subject that you want to photograph in the viewfinder.
- 2 Hold the camera steady and press the **Shutter** button halfway down. The camera automatically adjusts exposure and focus.
- 3 When the viewfinder light is solid green, press the **Shutter** button all the way down to take the picture.



To achieve the best focus in low light conditions, secure the camera to a tripod and make sure the focus area has sufficient contrast.

To achieve the best exposure in low light conditions, turn on the flash when the subject is less than 2 meters away. When the subject or scenery is more than 2 meters away, turn the flash off and secure the camera to a tripod to prevent blurring the image. When the flash is turned off, the longer exposure will make the image brighter.

If the orange viewfinder light is blinking, you must wait before taking a picture. This means that the camera is starting up, the flash is charging, or another situation might exist. For troubleshooting information, see **Chapter 6: Troubleshooting and support** on page 43.

Using focus lock

Focus lock allows you to focus on a subject that is not in the center of the image. It is also useful to verify that your image is focused before taking the picture. To use focus lock:

- 1 Press the **Shutter** button halfway down to lock the exposure and focus. When exposure and focus are locked, the green viewfinder light is solid.
- 2 When exposure and focus are locked, continue to hold the **Shutter** button halfway down, and you can re-frame or adjust your subject for proper positioning.
- 3 Press the **Shutter** button all the way down.

Using instant review

After you take a picture, the image display shows the image while it is being saved to memory. You can delete the image before it is saved by pressing the left **Arrow** ◀ button.

Recording video clips

To record a video clip:

- 1 Frame the subject that you want to record.

- 2 Press and release the **Video**  button to start recording. You will see **REC** on the image display. No audio will be recorded.

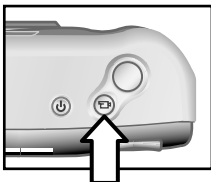



- 3 To stop recording at any time, press the  button again.

After recording has stopped, the last frame of the video clip remains on the image display during instant review. During this time, the video clip is saved to memory unless you choose to delete it.



During recording, the green viewfinder light and the red Video/self-timer light are solid. You can view the time remaining for recording on the image display. The camera automatically stops recording when the timer reaches zero.

NOTE To delay recording by 10 seconds, simply press the **Self-timer**  button to activate the self-timer before pressing the  button.

Although the maximum recording time for a video clip is always 30 seconds, the number of video clips you can record can be increased by using a memory card. Video clips can be very large and use a lot of space on the memory card.

Using Preview mode

You can also use the image display to preview a picture and show a more accurate view of what your picture will look like. This is useful for close-up pictures and for instances in which framing your subject precisely is important.



To take a picture by using the image display:

- 1 Press the **Display**  button to activate Preview mode.
- 2 Frame your subject in the image display, and then press the **Shutter** button.

In addition to taking pictures and recording video clips, you can zoom in on your subject, adjust the flash setting, determine how many more pictures can be taken, or increase the quality of your image—all from within Preview mode.

NOTE Using the image display consumes a large amount of battery power.

Using the self-timer

To use the self-timer:

- 1 Secure the camera to a tripod or set it on a stable surface.
- 2 Frame your subject in the viewfinder or image display.
- 3 Press the  button once. The self-timer icon appears on the image display.
- 4 Press the **Shutter** button all the way down, and then release it. The Video/self-timer light and viewfinder light blink for 10 seconds before the picture is taken.

Using zoom

Optical zoom



Use optical zoom to make your subject appear closer. To use optical zoom:

- Press the **Zoom Out/Zoom In**  button to move the lens between wide angle and telephoto positions (1x to 3x). Use the telephoto position for close-up pictures.

Optical zoom can be used for video clips, but you cannot adjust the setting while recording.

Digital zoom

To use digital zoom:





- 1 Press the  button to activate Preview mode, and frame the picture by using the image display.
- 2 Press and hold the right side of the  button until you reach maximum optical zoom, then release the button.
- 3 Press and hold the right side of the  button again to turn on digital zoom. (Digital zoom goes from 1.3x to 4x.) A yellow cropping frame appears in the image display showing the region captured.

To cancel digital zoom, press and hold the left side of the  button until zooming stops, and then release. You can also cancel digital zoom by exiting Preview mode.

NOTE Digital zoom does not work when recording video clips.

Using the flash

When the camera is turned on, the flash is automatically set to **Auto Flash**. If you change the flash setting, the camera will remain in that setting until you change it again or turn off the camera. By using the **Flash** ⚡ button, you can move through the flash settings in the following order.

Icon	Setting	Description
	Auto Flash	The camera measures light and uses the flash if necessary.
	Red-eye reduction	The camera measures light and uses the flash with red-eye reduction if necessary.
	Flash On	The camera always flashes. If the light is behind your subject, you can use the flash to increase the light on the front of your subject. This is also called "fill-flash."
	Flash Off	The camera will not flash. Use this setting when you do not want a flash (such as with distant objects). This might result in long exposures that will require a tripod.

Changing the image quality

The camera has three image quality settings: **Good**, **Better**, and **Best**. You can view the current quality setting, as well as the number of pictures that can be taken, on the image display. This setting determines the quality of the images and how many images can be stored in internal memory or on the memory card. Higher quality images take up more space in memory. The following table identifies the approximate number of pictures that you can take at each setting based on internal memory or a 16 MB memory card with digital zoom off.

Setting	Icon	Description and capacity
Good	★	This is the most memory-efficient setting. This is recommended for sending images in e-mail or posting to the Internet. Internal memory—87 images 16 MB memory card—200 images
Better	★★	This setting produces high-quality images and requires less memory than Best . This is recommended for printing pictures 10 by 15 cm (4 by 6 inches). This is the default quality setting. Internal memory—14 images 16 MB memory card—32 images
Best	★★★	This setting produces the highest-quality images and uses the most memory. This is recommended if you plan to enlarge images, or print images that are 20 by 25 cm (8 by 10 inches) or larger. Internal memory—7 images 16 MB memory card—17 images

To change the image quality:

Press the **Quality** ★ button until the setting you want appears on the image display. The settings change incrementally from **Good** to **Better**, and then to **Best**.

3 Using Playback and the Main menu

Using Playback mode

After you have taken some pictures and they are stored in the camera, you can view them in Playback mode. You can also view video clips.



#	Icon	Description
1	★★★	Indicates the quality setting of the image
2	2x	Indicates zoom level
3	12.25.2001	Date the image was taken
4	SD	Visible if a memory card is inserted
5	🔋	Indicates battery level
6	12 of 43	Image number of total number of images stored in the camera or on the memory card (if inserted)

Reviewing images

To review images that are stored in the camera's memory:

- 1 Press OK or use the ◀ ▶ buttons to activate Playback mode.
- 2 Scroll through your images by using the ◀ ▶ buttons. Press and hold the ◀ ▶ buttons to scroll automatically.

NOTE To preserve battery life, connect to an optional HP AC adapter while reviewing your images. For more information, see **Appendix A: Batteries and accessories** on page 61.

If you do not have images stored in your camera or on the memory card, the **No images** screen appears on the image display. To return to Preview mode, press the |□| button.



Reviewing video clips

You can review video clips the same way that you view images on the camera. When a video clip is reviewed, a video icon and progress bar appear in the lower-right corner of the image display. Video clips begin playing automatically. When reviewing video clips:

- Press the ▶ button to navigate to the next image.
- Press the ◀ button to reset the video clip to the first frame or navigate to the previous image.

Using the Main menu

Use the **Main** menu in Playback mode to rotate, delete, or magnify images. You can also view thumbnails of your images, or change the settings on the camera. To view the **Main** menu, press OK twice (or just once if Playback mode is activated). Scroll through the menu options by using the ◀ ▶ buttons.



Icon	Description
	Rotates the image 90 degrees clockwise per rotation
	Deletes the current image or all images and files; formats internal memory or the memory card Undelete restores the last deletion you made
	Displays images as thumbnails (nine at a time)
	Magnifies the view of the current image
	Allows you to adjust the camera settings
	Exits the Main menu

Rotating images

Selecting the **Rotate**  option from the **Main** menu rotates the current image in 90-degree increments clockwise on the image display. The image rotation is permanent. To rotate an image, press OK and then select **ROTATE**.

Pressing OK again rotates the image an additional 90 degrees.

NOTE This option works only on still images, not video clips.



Deleting images

Selecting the **Delete**  option from the **Main** menu deletes the current image or all images.

Scroll to the image you want by using the **◀ ▶** buttons. Highlight the image, and then press **OK**. By using the  option, you can select:







- **This Image** - Deletes the current image.
- **All Images** or **All Images on Card** - Deletes all images from internal memory or the memory card (if inserted).
- **Format Memory** or **Format Card** - Deletes all images and files from internal memory or the memory card (if inserted), and formats either internal memory or the memory card.
- **Undelete** - Appears if you have deleted any images or video clips. This option restores the last deletion you made. The **Undelete** option is available until another picture or video clip is taken, another deletion occurs, or the camera is turned off or connected to your computer.
- **Exit** - Exits the **Delete** menu.

Viewing thumbnail images

Selecting the **View Thumbnails**  option from the **Main** menu enables you to view up to nine thumbnail images at a time on the image display.



You can scroll through thumbnail images by using the   buttons. To view an enlarged image, select it, and then press **OK** (pressing **OK** also exits this option). To move to the next set of images, use the   buttons.





Magnifying images

Selecting the **Magnify**  option from the **Main** menu enlarges your images on the image display.

Select an image that you want to magnify, and then press **OK**. A progress bar is visible on the image display as the image is magnified.



Use the   buttons to scroll the magnified image. Press **OK** to view the **Magnify** menu. The menu allows you to change the scroll direction, change the magnification, or exit.

NOTE This option works only on still images, not video clips.

Using the Setup menu

Selecting this option from the **Main** menu enables you to configure preferences on the camera.

Move through the **Setup**  menu by using the **◀ ▶** buttons, and then press **OK** to make your selection.



Date & Time

This setting determines the current date and time for the camera. For information about setting the date and time, see **Chapter 1: Getting started** on page 7.

Welcome Screen

This setting determines the image that appears when the camera is turned on. You can set any image available in the camera or the HP logo, which is the default setting.

To set the **Welcome Screen**:



- 1 Press **OK** or use the **◀ ▶** buttons to activate Playback mode.
- 2 Locate the image that you want, and navigate to the **Setup** menu.
- 3 Select **Welcome Screen**, and then press **OK**. Select **This Image**, and then press **OK** again.

USB Configuration

This setting determines how the camera appears when connected to a computer. To change the connection setting:

- 1 Select **USB Configuration** in the **Setup** menu.
- 2 Using the ◀ ▶ buttons, make one of the following choices and press OK .
 - **Digital Camera** - causes the computer to recognize the camera as a digital camera (Picture Transfer Protocol (PTP) standard). This is the default setting on the camera.
 - **Disk Drive** - causes the computer to recognize the camera as a disk drive (Mass Storage Device Class (MSDC) standard). Use this setting for unloading and sharing on a Macintosh computer or unloading to Windows operating systems if no HP Photo & Imaging software is loaded on the computer.



Move Images to Card

This option allows you to move images from the camera's internal memory to a memory card. This option appears only if you have a memory card inserted and internal memory contains at least one image.



If the memory card can store all of the images from internal memory, you are prompted to move all images. If the memory card is running out of space, you can move only the number of images that will fit on the card.



If you select **Yes** to move images, a progress bar will appear on the image display, showing the progress of the move. The images previously stored in internal memory are deleted after they are moved to the memory card.



NOTE When a memory card is inserted, only the images on the card can be viewed. If you want to view the images stored in internal memory, you must first remove the memory card.

Language

This setting determines the language of the menus and the text on the image display. For information about how to select a language for your camera, see **Chapter 1: Getting started** on page 7.

Exit

This option exits the **Setup** menu and returns to Playback mode.

4 Using hp instant share

This camera has an exciting feature called **HP Instant Share**. This feature lets you select images in the camera to be automatically processed later when the camera is connected to your computer or to certain HP printers.





For example, you can select images that you want to have printed, then connect the camera to the computer or printer, and the selected images will be printed automatically.

As another example, you can select images in the camera to be automatically processed by HP's e-mail service. When the camera connects to your computer, the selected images are e-mailed to family, friends, or any e-mail address that you specify. The details about this are explained later in this chapter.

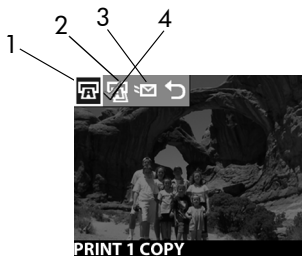







When you press the **Share**  button on the camera, the most recently taken or reviewed image appears on the image display, along with any e-mail or print destinations that have been selected for the image. The ◀ ▶ buttons allow you to scroll through the images to see destinations for the other images in the camera.

After you press the  button, you can activate the **Share** menu by pressing **OK**. The following table provides information about the **Share** menu.



#	Icon	Description
1		Print 1 copy of current image. If paper size is 4 by 6 inches or 8.5 by 11 inches, the picture is printed 4 by 6 inches. If paper size is A4 or A6, the picture is printed at A6 size.
2		Print 2 copies of current image.
3		E-mail... Lets you add e-mail addresses to the Share menu. This procedure is explained later in this chapter.
4		Check mark indicates a destination has been selected for the currently displayed image. (You can select more than one destination per image.)

Using hp instant share to print pictures

- 1 Turn on the camera, then press the  button.
- 2 Use the   buttons to scroll to the image you want to print. Video clips cannot be selected for printing.
- 3 Press OK to activate the **Share** menu, then use the   buttons to scroll to the print option you want.
- 4 Press OK, and a  appears next to that option.
- 5 Scroll to other images by using the   buttons and repeat steps 3 and 4 to select print options for each image.
- 6 When you are finished selecting all the images you want to have printed, press the  button.
- 7 The next time you connect the camera to your computer or a compatible printer, the images you selected will be automatically printed. See **Chapter 5: Unloading, printing, and displaying images** on page 39 for information about connecting the camera to a computer or printer.

NOTE The Share menu creates a standard Digital Print Order Format (DPOF) file for print options.

Using the hp instant share e-mail service

Using **HP Instant Share** to e-mail images involves three steps:

- 1 Adding e-mail addresses to the **Share** menu on the camera (using your computer and the camera together).
- 2 Selecting images to be e-mailed (using the **Share** menu on the camera).
- 3 Connecting the camera to your computer to send selected images.

Adding, modifying, and removing e-mail addresses









NOTE You will need an internet connection to complete this procedure.

- 1 Open the **HP Director** in the HP Photo & Imaging software, select your camera in the **Select Device** menu, then in the **Settings** menu, click **Camera Share Menu Setup**.
- 2 Turn on the camera and connect it to your computer (by using a USB cable or an optional HP Camera Dock).
- 3 On the computer, click **Retrieve from Camera**.
- 4 In the screen called **Modify Share Menu**, verify that **Photo E-mail** is visible above the **Add...** button, then click the **Add...** button.
- 5 If you are using a Macintosh computer, skip to step 7. If you are using a computer running Windows, you will be asked to sign in to HP's Passport program. HP Passport allows you to use HP's free e-mail service and other services that might be available in the future. The first time you see this screen, you will need to register as a new user. Follow the on-screen instructions for doing that.
- 6 Once you have successfully registered, sign in to the HP Passport program, and then the **Photo E-mail Setup** screen will appear. Here, you can enter an e-mail address and specify how you want it to appear in the camera's **Share** menu. You can also enter a subject and body text to go with the e-mail that will be sent to that address. After completing the form, click **Next**. In the confirmation screen that appears, click **Finish**.

- 7 Your newly added e-mail destination should now appear in the **Modify Share Menu** screen (in the **Current Share Menu** section). To add additional e-mail addresses to the camera's **Share** menu, repeat steps 4-6. You will not need to sign in to the HP Passport program again.
- 8 When you have finished adding e-mail addresses, click on **Save to Camera** to add the new addresses to the camera's **Share** menu. When the computer confirms that the addresses were saved to your camera, disconnect the camera from the computer, and press the  button to view the new e-mail destinations in the **Share** menu.
- 9 You are now ready to select images to be e-mailed. See the next section for how to do this.

NOTE You can also start the process described above from your camera, by selecting **E-mail...**  on the **Share** menu.

Selecting images to be e-mailed

- 1 Turn on the camera, then press the  button.
- 2 Use the   buttons to scroll to an image you want to e-mail. Video clips cannot be selected for e-mail.
- 3 Press **OK** to activate the **Share** menu, then use the   buttons to scroll to the e-mail destination that you want to select.
- 4 Press **OK** to select the e-mail destination, and a check mark appears next to that selection. (You can select more than one e-mail destination or print option for an image.)
- 5 Scroll to other images by using the   buttons and repeat steps 3 and 4 to select e-mail destinations for each image.
- 6 When you are finished selecting all the images you want to e-mail, press the  button.

- 7 The next time you connect the camera to your computer, images are unloaded to the computer, and the images selected for e-mail will be sent to their respective destinations.

The way in which the images are e-mailed works differently on Windows and Macintosh computers.

Windows

Images are not e-mailed directly to anyone. Rather, a message is sent to each e-mail address that you selected in the **Share** menu. The message contains a thumbnail of each of the images that were selected for that address, as well as a link to a web page where the recipient can view the images. From that web page, the recipient can do things like reply to you or print the image. This makes it easy for people who use different e-mail programs to be able to see your images without the difficulty of dealing with e-mail attachments.

Macintosh

Images are e-mailed directly to recipients using the default e-mail program on your computer.

5 Unloading, printing, and displaying images

Once you have taken pictures, you can unload them from your camera to a computer, print them directly to a printer, or display them on a TV (using the optional HP Camera Dock).

Unloading to a computer

NOTE You can also use the optional HP Camera Dock to do this task. See **Appendix B: Camera dock** on page 65 for details.

NOTE If you are using a Macintosh computer, switch the camera to **Disk Drive** in the **USB Configuration** menu found in the **Setup** menu.

- 1 Your camera came with a special USB cable for connecting the camera to a computer. Connect the larger end of that USB cable to the computer.
- 2 Open the memory card door on the side of the camera and connect the small end of the USB cable to the USB connector on the camera.

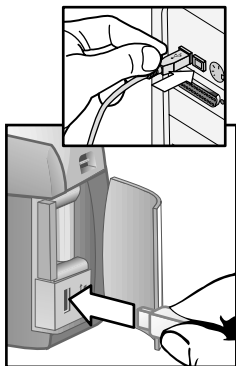

- 3 Turn on the camera. The HP Image Unload software will launch on your computer, and the images in the camera will automatically unload to the computer. If there were any images in the camera that were selected in the **Share** menu for printing or e-mail, those actions are started after the images have been unloaded to the computer.
- 4 When the unload screen on the computer says **Finished**, your images have been saved and shared. You can now disconnect the camera from the computer.

NOTE To unload the camera images to a computer that does not have the HP Photo & Imaging software installed on it, switch the camera to **Disk Drive** in the **USB Configuration** menu found in the **Setup** menu. This allows the camera to appear as another disk drive on the computer.

Printing images

NOTE You can also use the optional HP Camera Dock to do this task. See **Appendix B: Camera dock** on page 65.

To print images that have been unloaded to the computer, you can use the HP Photo & Imaging software that was shipped with the camera.

You can also connect the camera directly to any HP DeskJet or Photosmart printer that has a USB connection, then print images selected from the camera's **Share** menu or all images in the camera.

- 1 Your camera came with a special USB cable for connecting the camera directly to a printer.
- 2 Connect the square end of the USB cable to the printer.
- 3 Open the memory card door on the side of the camera and connect the small end of the USB cable to the USB connector on the camera.
- 4 Adjust the settings in the **Print Setup** menu on the camera to complete the printing process.

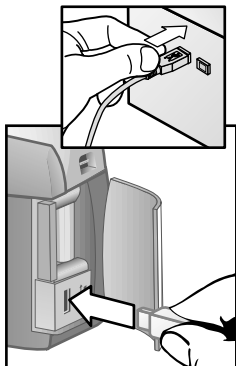



Displaying images on a TV

Images in your camera can easily be displayed as a slideshow on almost any TV. You must use the optional HP Camera Dock to do this task. See **Appendix B: Camera dock** on page 65.

Displaying a slideshow

Once the camera is connected to the TV with the optional HP Camera Dock, you are ready to start.

- 1 Turn on the camera. The  button on the Camera Dock should light up. Press the  button to display the **Slideshow** menu. The menu choices are described in the following table.

Option	Description
NTSC Television	Used mostly in North America and Japan
PAL Television	Used mostly in Europe and Asia
5 Sec/Image	Displays each image for 5 seconds
10 Sec/Image	Displays each image for 10 seconds
Manual Advance	Waits for you to advance each image using the ◀ ▶ buttons on the camera
Begin	Starts the slideshow

- To change an option in the **Slideshow** menu, highlight the selection and press OK . Each time OK is pressed, the next option is selected. All selections except **Begin** are stored in the camera and become the defaults until changed.
- To start the slideshow, select **Begin**. The camera's image display turns off and the slideshow starts on the TV. The slideshow begins with the image last taken or reviewed and displays each image in sequence. When the end is reached the sequence moves to the beginning and continues. Video clips are always played to completion, regardless of the rate you specified in the **Slideshow** menu.
- To exit the slideshow, press the  button on the dock or turn off the camera.

At any time during the slideshow, you can press the ◀ ▶ buttons to move forward or backward. Pressing and holding these keys auto repeats similar to Playback mode.

NOTE The **Main** menu and **Share** menu are available during the slideshow. You can rotate, delete, view thumbnails, magnify, share, etc. during the slideshow.

6 Troubleshooting and support

Problems and solutions

Problem	Possible cause	Solution
The camera does not turn on.	The batteries are not functioning correctly.	Use only photo-quality AA lithium, alkaline, or NiMH batteries. Ensure the batteries are inserted correctly. The charge in the batteries can be low or completely drained. Try inserting new or recharged batteries.
	The HP AC adapter is not functioning correctly.	Ensure that the HP AC adapter is not damaged or defective. If it appears undamaged, plug it into an electrical outlet with power.
	The HP AC adapter is connected to the camera, but it is not connected to a power outlet.	If you want to use battery power, disconnect the HP AC adapter from the camera. If you want to use AC power, connect the HP AC adapter to a working electrical outlet.

Problem	Possible cause	Solution
The camera does not respond when I press a button.	The camera is off.	Turn on the camera.
	The camera is connected to a computer.	The camera buttons other than the  button do not respond when the camera is connected to a computer.
	The batteries are drained.	Replace or recharge the batteries.
	The camera has stopped operating.	Remove and reinsert the batteries. Replace the batteries if necessary.
The camera does not take a picture when I press the Shutter button.	You did not press the Shutter button hard enough.	Press the Shutter button all the way down.

Problem	Possible cause	Solution
I replace the camera batteries frequently.	Extended image display use and excessive use of flash consume a lot of battery power.	Use an HP AC adapter to power the camera when you are using the image display for an extended period of time and when you are unloading several images to your computer. Use the flash only when needed. Do not use ordinary alkaline batteries. Purchase higher-grade batteries, such as "ultra" or "premium" grade alkaline or photo-lithium batteries, or switch to rechargeable NiMH batteries.
	The NiMH batteries you are using were recharged incorrectly.	You must recharge all NiMH batteries after fully draining them four times for the batteries to reach their optimum capacity and performance.
The wrong date and/or time is shown.	The batteries died or were removed from the camera for more than 10 minutes.	Reset the date and time by using the camera menus.

Problem	Possible cause	Solution
A long delay occurs between the time I press the Shutter button and the camera takes a picture.	The camera needs time to focus and set exposure.	Press the Shutter button halfway down to let the camera focus, then when you press all the way down, there is much less delay.
	The flash is recharging.	Wait until the orange viewfinder light stops blinking before taking another picture.
	The self-timer is activated.	Turn the self-timer off.
	The camera is still saving the last picture you took.	Wait a few seconds for the camera to finish processing the image, and then press the Shutter button. The camera can store up to three images in memory at a time.
My image is blurry.	Your subject was too close to the camera lens.	Do not try to get closer than the camera's minimum focus range of 20 cm (approximately 8 inches).
	You moved the camera while you took the picture.	Hold the camera steady as you press the Shutter button or use a tripod.
	The light is low and the flash is turned off.	In dim light, the camera requires longer exposure. Use a tripod to hold the camera steady, improve lighting conditions, or use the flash.

Problem	Possible cause	Solution
My image is too dark.	There was not enough light.	Before taking the picture, press the Shutter button halfway down to adjust focus and exposure automatically. Use the Flash Off setting and hold the camera steady. Wait for natural lighting conditions to improve or add indirect lighting.
	The shutter speed was too fast.	Use the Flash Off setting to take a longer exposure, and hold the camera steady (or use a tripod).
	The flash was on, but the subject was too far away.	Make sure your subject is within 3 meters (approximately 10 feet) of the camera when you take the picture using the flash.
	A light shone behind the subject.	Use the Flash On setting to brighten the subject when there is a bright light such as the sun or a window behind your subject.
	Your finger blocked the flash.	Be sure to move your fingers away from the flash when you take a picture.

Problem	Possible cause	Solution
My image is too bright.	The flash provided too much light.	Change the flash setting to Flash Off .
	A natural or artificial source other than the flash provided too much light.	Try taking the picture from a different angle. Avoid pointing the camera directly toward a bright light or reflective surface on a sunny day.
	You were too close to the subject to use the flash.	Move back from the subject or set the flash to Flash Off and take the picture again.

Problem	Possible cause	Solution
When I connect the camera to my computer, the software says it cannot find the camera.	The camera is turned off.	Turn on the camera.
	The cable is not connected correctly.	Make sure that the cable is firmly connected at both ends.
	The camera is connected to the computer through a USB hub and your USB hub is not compatible with the camera.	Connect the camera directly to a USB port on the computer.
	The camera is not working correctly.	Connect the camera to a USB-enabled HP DeskJet or HP Photosmart printer and print an image. This will verify that the image, memory, USB connection to the camera, and USB cable are functioning correctly.
When I connect the camera to a Macintosh computer, I do not get a Disk Drive icon on my desktop.	The USB Configuration setting is not set to Disk Drive.	Change the USB Configuration setting to Disk Drive .

Error messages

You might receive error messages on the camera's image display or on your computer screen.

Error messages on the camera

Message	Possible cause	Solution
BATTERIES DEPLETED Camera is shutting down	Battery power is too low to continue operation.	Replace batteries, use an optional HP AC adapter, or recharge batteries by using an optional Camera Dock.
Batteries are too low for Preview	Battery power is too low to use Preview mode.	Switch to Playback mode or continue taking pictures in Display Off mode. Replace batteries, use an optional HP AC adapter, or recharge batteries by using an optional Camera Dock.
Batteries are too low to record a video clip	Battery power is too low to record a video clip.	Replace or recharge batteries, or use an optional HP AC adapter during video recording.
Unsupported card	Unusable or corrupt memory card is detected.	Ensure that the memory card is the proper type for your camera.
The card requires formatting	The memory card needs to be formatted.	Press OK to display the Format Card option in the Delete menu. This will delete all data on the card.

Message	Possible cause	Solution
The card is locked	The memory card is write-protected.	Press OK to cancel the request. Unlock the memory card or insert a new one.
The card is too full to move any images	There is insufficient room on the memory card to store images.	Unload images from the memory card to your computer, then delete all images on the memory card.
Invalid date	The date was set incorrectly.	Enter the correct date.
Unsupported image file	You are trying to magnify, rotate, or print an image file that was not created by the camera.	You can only view or delete images taken by a different digital camera.
Memory is too full OR The card is too full	There is insufficient memory to rotate an image.	Unload the images from the camera, delete unwanted pictures, or replace the memory card with a new one.
Unknown USB device	The connected USB device is not a printer.	Disconnect the current USB connection and connect to your printer.
Unsupported printer	The printer is an unsupported device.	Disconnect the USB cable, and connect to an HP printer, such as HP Photosmart or HP DeskJet.

Message	Possible cause	Solution
Unable to communicate with printer	The printer has a problem.	Check the printer.
Disengage photo tray	The selected paper size cannot be used with the printer photo tray.	Disengage the printer photo tray.
Printer top cover is open	The printer is open.	Close the top cover of the printer.
Incorrect or missing print cartridge	Ensure that you have the correct printer cartridge.	Install a new printer cartridge, turn the printer off, then turn it back on.
Printer has a paper jam	There is a paper jam or the printer carriage has stalled.	Turn off the printer. Clear the paper jam, and then turn on the printer.
Printer is out of paper	Your printer is out of paper.	If OK is visible on the image display, load paper and then press OK . Otherwise, load paper, and then press OK or Continue on your printer.
Printing canceled	The print job has been canceled.	Press OK on the camera. Complete the print request again.

NOTE If you see a three-digit error number on the image display, turn the camera off. If an error number reappears when you turn the camera on, record that error number and call customer support.

Error messages on the computer

Message	Possible cause	Solution
Connection between the imaging device and computer failed	The camera might be connected to a computer through a USB hub.	Make sure the camera is on, try connecting the camera directly to the computer, or disconnect other devices attached to the hub.

Getting assistance

Finding help on the web

HP product support

Visit www.hp.com/cposupport/loc/regional.html, select your language, and then type your camera model in the “quick find” box to find information about setting up and using your camera, downloading drivers, solving a problem, ordering, and warranty information.

HP photosmart website

Visit www.hp.com/photosmart for tips on using your camera more effectively and creatively as well as HP digital camera driver updates and software.

HP accessibility website

Visit www.hp.com/hpinfo/community/accessibility/prodserv/ if you have a disability and need help.

Contacting hp customer support

In addition to the Web, you can contact HP by telephone or mail for support and service for your camera. Prices, availability, and hours of support are subject to change without notice.

How hp can help

The HP support hotline can help resolve problems with setup, installation, configuration, and operation. For help with non-HP hardware or software, please contact the manufacturer.

Before you call

Review troubleshooting tips.

Have the following information ready before you call:

- serial number (found on the bottom of your camera)
- product name
- date of purchase

Obtaining support in the United States

Free telephone support for one year

Within one year of your purchase, telephone support is provided to you free of charge. If this is a long distance call for you, long distance charges will apply.

Call (1) (208) 323-2551.

Our support staff is available from 6 am to 10 pm Mountain Time, Monday through Friday, or 9 am to 4 pm Saturday.

If you think your HP product might need service, call HP Customer Support, which can help determine if service is required. Or, visit www.hp.com/cpso-support/guide/psd/repairhelp.html for the nearest sales and service office.

After the first year

Call (1) (208) 323-2551.

A fee of \$25.00 per call (U.S.) will be charged to your credit card. Charges begin only when you connect with a support technician.

Upgraded warranty options

You can select one of the following upgraded warranty options (available in the U.S. only):

- Standard Next Day Exchange
- Accidental Damage Protection with Next Day Exchange

Upgrade your standard factory warranty to three years with the HP SupportPack. Service coverage begins on product purchase date and the pack must be purchased within the first 180 days of product purchase. HP will determine the hardware service offering based upon the outcome of system self-test programs run by the customer through the initial call to the HP Customer Care Center. If during your technical support call it is determined that your product needs replacement, HP will ship you this replacement product next business day free of charge. Optional Accidental Damage Protection is also available. This warranty upgrade protects against accidental breakage such as spills, drops, or falls. Both of these warranty upgrades offer maximized uptime and productivity, the convenience of door-to-door pickup with delivery, packaging and freight prepaid by HP.

For more information call 1-888-999-4747 or visit www.homeandoffice.hp.com and select “warranty upgrades” under “product support.”

Obtaining support worldwide

Telephone support is free for one year in Asia and the South Pacific, and for 30 days in the Middle East and Africa.

The information contained in this document and the applicable conditions for HP phone support are subject to change without notice. Please check for the latest information and conditions at www.hp.com/cposupport/loc/regional.html.

Alternatively, you can ask your dealer or call HP at the phone number listed in this document. For English support in Europe, contact +44 (0) 207 512 52 02.

Algeria +212 22404747

Argentina 0810 555 5520

Australia +63 (3) 8877 8000 (or local (03) 8877 8000)

Austria +0810 00 6080

Belgium Dutch: +32 (0)2 626 8806 French: +32 (0)2 626 8807

Brazil 3747 7799 (Grande São Paulo) 0800 157 751 (outside Grande São Paulo)

Canada 905 206 4663 (for support during the warranty period)
877 621 4722 (for support after the warranty period)

Chile 800 360 999 (Post-sales Home Computing)

China +86 (10) 6564 5959

Colombia +9 800 114 726

Czech Republic +42 (0)2 6130 7310

Denmark +45 39 29 4099

Egypt 02 532 5222

Finland +358 (0)203 47 288

France +33 (0)8 92 69 60 22 (Euro 0.34/min)
Germany +49 (0)180 52 58 143 (Euro 0.12/min)
Greece +30 1 6073 603
Guatemala 1 800 995 5105
Hong Kong SAR +852 3002 8555
Hungary +36 (0)1 382 1111
India 1 600 112267 or +91 11 682 6035
Indonesia +62 (21) 350 3408
Ireland +353 (0)1 662 5525
Israel +972 (0)9 952 48 48
Italy +39 02 264 10350
Korea, Republic of +82 (2) 3270 0700 (Seoul) 0-80-999-0700 (outside Seoul)
Malaysia 60 (3) 295 2566 (Penang) 03 2695 2566 (outside Penang)
Mexico 52 58 9922 (Mexico City) 01-800-472-6684 (outside Mexico City)
Middle East/Africa +44 (0) 207 512 52 02
Netherlands +31 (0)20 606 8751
New Zealand +64 (9) 356 6640
Norway +47 22 11 6299
Peru 0 800 10111
Philippines +63 (2) 867-3551
Poland +48 22 865 98 00
Portugal +351 21 3176333
Puerto Rico 1 877 232 0589
Romania +40 1 315 44 42 (or local 01 3154442)
Russian Federation +7 095 797 3520 (Moscow) +7 812 346 7997 (St. Petersburg)
Saudi Arabia 800 897 14440
Singapore +65 272 5300

Slovakia +421-2-68208080

South Africa 086 000 1030 (RSA) +27-11 258 9301 (outside RSA)

Spain +34 902 321 123

Sweden +46 (0)8 619 2170

Switzerland +41 (0)848 80 11 11

Taiwan 0 800 01 0055

Thailand +66 (2) 661 4000

Turkey +90 216 579 71 71

Ukraine +7 (380-44) 490-3520

United Arab Emirates 971 4 883 8454

United Kingdom (UK) +44 (0) 207 512 52 02

Venezuela 0 800 4746 8368

Viet Nam +84 (0) 8 823 4530

Hewlett-Packard limited warranty statement

The HP Photosmart 620 camera comes with a one year limited warranty.

- HP warrants to you, the end-user customer, that HP hardware, accessories, software, and supplies will be free from defects in materials and workmanship after the date of purchase, for the period specified above. If HP receives notice of such defects during the warranty period, HP will, at its option, either repair or replace products which prove to be defective. Replacement product may be either new or equivalent in performance to new.
- HP warrants to you that HP software will not fail to execute its programming instructions after the date of purchase, for the period specified above, due to defects in material and workmanship when properly installed and used. If HP receives notice of such defects during the warranty period, HP will replace software which does not execute its programming instructions due to such defects.
- HP does not warrant that the operation of HP products will be uninterrupted or error free. If HP is unable, within a reasonable

time, to repair or replace any product to a condition as warranted, you will be entitled to a refund of the purchase price upon prompt return of the product.

- HP products may contain remanufactured parts equivalent to new in performance or may have been subject to incidental use.
- Warranty does not apply to defects resulting from (a) improper or inadequate maintenance or calibration, (b) software, interfacing, parts or supplies not supplied by HP, (c) unauthorized modification or misuse, (d) operation outside of the published environmental specifications for the product, or (e) improper site preparation or maintenance.
- TO THE EXTENT ALLOWED BY LOCAL LAW, THE ABOVE WARRANTIES ARE EXCLUSIVE AND NO OTHER WARRANTY OR CONDITION, WHETHER WRITTEN OR ORAL, IS EXPRESSED OR IMPLIED AND HP SPECIFICALLY DISCLAIMS ANY IMPLIED WARRANTIES OR CONDITIONS OF MERCHANTABILITY, SATISFACTORY QUALITY, AND FITNESS FOR A PARTICULAR PURPOSE. Some countries, states or provinces do not allow limitations on the duration of an implied warranty, so the above limitation or exclusion might not apply to you. This warranty gives you specific legal rights and you might also have other rights that vary from country to country, state to state, or province to province.
- HP's limited warranty is valid in any country or locality where HP has a support presence for this product and where HP has marketed this product. The level of warranty service you receive may vary according to local standards. HP will not alter form, fit or function of the product to make it operate in a country for which it was never intended to function for legal or regulatory reasons.
- TO THE EXTENT ALLOWED BY LOCAL LAW, THE REMEDIES IN THIS WARRANTY STATEMENT ARE YOUR SOLE AND EXCLUSIVE REMEDIES. EXCEPT AS INDICATED ABOVE, IN NO EVENT WILL HP OR ITS SUPPLIERS BE LIABLE FOR LOSS OF DATA OR FOR DIRECT, SPECIAL, INCIDENTAL, CONSEQUENTIAL (INCLUDING LOST PROFIT OR DATA), OR OTHER DAMAGE, WHETHER BASED IN CONTRACT, TORT, OR OTHERWISE. Some countries, states or provinces do not allow the exclusion or limitation of incidental or

consequential damages, so the above limitation or exclusion may not apply to you.

- THE WARRANTY TERMS CONTAINED IN THIS STATEMENT, EXCEPT TO THE EXTENT LAWFULLY PERMITTED, DO NOT EXCLUDE, RESTRICT OR MODIFY AND ARE IN ADDITION TO THE MANDATORY STATUTORY RIGHTS APPLICABLE TO THE SALE OF THIS PRODUCT TO YOU.

Regulatory information

For regulatory information, see the regulatory_supplement.htm file on the CD that came with your camera.



Appendix A: Batteries and accessories

Managing batteries

When the batteries are removed from the camera, the date and time settings are preserved for approximately ten minutes. If the camera is without batteries for longer than ten minutes, the clock is set to the last time and date at which it stopped. You might be prompted to update the date and time.

NOTE If you do not intend to use the camera for extended periods of time (more than a month), we strongly recommend that you remove the batteries from the camera.

The following battery levels are visible on the image display.

Level	Icon	Description
Full		Batteries have 30-100% remaining
Partially full		Batteries have 10-30% remaining
Empty		Batteries have less than 10% remaining and need to be recharged or replaced
N/A		Camera is operating on AC power

The camera uses four AA batteries. Acceptable batteries include alkaline, photo-lithium, and NiMH. For the best results with your camera, use photo-lithium or NiMH batteries.

Extending battery life

- Use an optional HP AC adapter or HP Camera Dock when unloading pictures to your computer, printing, or connecting to the TV.
- Turn the camera off during a pause in picture taking.
- Use the **Auto Flash** setting rather than **Flash On** or **Red-eye reduction**.

Rechargeable batteries

NiMH batteries can be recharged by using a battery charger or optional HP Camera Dock (both purchased separately). Rechargeable batteries might be used either by recharging outside the camera in a charger, or in the camera by connecting to the dock or using the AC adapter. Both of these accessories are optional.

NOTE Rechargeable batteries have a longer life if they are fully discharged before charging occurs.

Power conservation

To conserve battery power, the image display turns off automatically if there is no button activity for 60 seconds. If no buttons are pressed for five minutes, the camera turns off (unless it is printing or connected to a computer).

NOTE If the camera is connected to an AC adapter, power conservation occurs after ten minutes.

Purchasing accessories

You can purchase additional accessories for your camera from your local retailer or online at www.hpshopping.com. Some accessories for the HP Photosmart 620 digital camera are listed below:

NOTE HP supports only HP AC adapters and other accessories expressly approved by HP.

- HP AC power adapter
 - North America - C8875A #001
 - Outside of North America - C8875A #002
- HP Photosmart 8881 Camera Dock
- Secure digital (SD) memory card (128 MB is the maximum usable card size)
- HP Digital Camera Accessory Kit (Y1788 for United States, Y1789 for outside the United States). Contents include:
 - Camera bag
 - Rechargeable NiMH batteries
 - Battery charger
- HP Digital Camera Accessory Kit (C8884A). Contents include:
 - Camera bag
 - Rechargeable NiMH batteries
 - Battery charger
 - 32 MB SD memory card
 - Tripod



Appendix B: Camera dock

NOTE The Camera Dock does not work without AC power. Be sure to use **ONLY** the HP AC adapter and the cables that came with the Camera Dock.

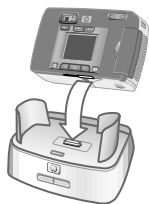
- 1 Follow the setup instructions provided with the HP Camera Dock. This includes installing the camera Dock Insert onto the dock, inserting rechargeable batteries in the camera, connecting the AC power source, and connecting the Camera Dock to a computer, printer, and/or TV.
- 2 Make sure your camera is set up correctly and remove any cables that might be attached to it before putting it in the dock.
- 3 Place the camera in the HP Camera Dock with the rear of the camera facing the front of the Camera Dock.



The Camera Dock has three I/O connectors on the back:

-  —Connects to the TV
-  —Connects directly to HP USB DeskJet and Photosmart printers
-  —Connects to your computer



There is a sliding door over the computer and printer connectors that prevents you from using both connectors at the same time (the Camera Dock is not a USB hub).

The Camera Dock has a light near the top front that provides battery charging status. A blinking light indicates that batteries are charging.

There are two buttons on the front that light up, showing the camera is connected to the associated device.

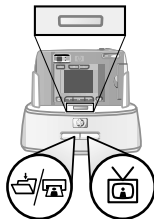

 —This button activates the connection to the computer or the printer, depending on which of those devices is connected to the dock.

 —This button activates the TV connection.

The functions of the dock button lights are described below:

State	Indication
On	Camera Dock has power and a device is connected. When you press a button for one device, the other button device light goes out.
Blinking	The associated device is active.
Off	<ul style="list-style-type: none"> • The associated device is not connected to the Camera Dock. • The associated device is not available because the other device is active. • Camera Dock has no power or there is no camera connected.

Unloading images to a computer using the dock

NOTE If you are using a Macintosh computer, switch the camera to **Disk Drive** in the **USB Configuration** menu found in the **Setup** menu.

- 1** Check that the HP Camera Dock is connected to your computer.
- 2** Place the camera in the HP Camera Dock. It will turn on automatically, and a dock intro screen will appear.
- 3** Press the  button on the dock to start the unload process. The HP Image Unload software will launch on your computer, and the images in the camera will automatically unload to the computer. If there were any images on the camera that had been selected in the **Share** menu for printing or e-mail, those actions are started after the images have been unloaded to the computer.
- 4** The camera will return to the dock intro screen when your images have been saved and shared. You can now take the camera out of the dock, or leave it there to recharge the camera batteries.

Printing images using the dock

- 1 Check that the HP Camera Dock is connected to your printer. (The dock cannot be connected directly to both a computer and a printer at the same time).
- 2 Place the camera in the HP Camera Dock. It will turn on automatically, and a dock intro screen will appear.
- 3 Press the  button on the dock to start printing.
- 4 Adjust the settings in the **Print Setup** menu on the camera to complete the printing process.
- 5 The camera will return to the dock intro screen when printing is complete. You can now take the camera out of the dock, or leave it there to recharge the camera batteries.

Displaying images on a TV using the dock

- 1 Check that the HP Camera Dock is connected to your TV.
- 2 Refer to the documentation for your TV to determine how to set the TV to take video input from your camera instead of the antenna or cable TV.
- 3 Place the camera in the dock. It will turn on automatically, and a dock intro screen will appear.
- 4 Press the  button on the dock, and the **Slideshow** menu will appear on the camera's image display.

The rest of this procedure is described in **Chapter 5: Unloading, printing, and displaying images** on page 39.

Appendix C: Reference

Camera specifications

Feature	Description												
Sensor	2.1 MP												
Color depth	30 bits (10 bits x 3 colors)												
Resolution	Good 0.3 MP (640 x 480) Better 2.0 MP (1632 x 1232) Best 2.0 MP (1632 x 1232)												
Memory type	8 MB internal flash memory Secure Digital (SD) memory card up to 128 MB												
Internal memory capacity	<table><thead><tr><th>Quality</th><th>Images</th><th>Target File Size</th></tr></thead><tbody><tr><td>Good</td><td>87</td><td>80 KB</td></tr><tr><td>Better</td><td>14</td><td>500 KB</td></tr><tr><td>Best</td><td>7</td><td>900 KB</td></tr></tbody></table>	Quality	Images	Target File Size	Good	87	80 KB	Better	14	500 KB	Best	7	900 KB
Quality	Images	Target File Size											
Good	87	80 KB											
Better	14	500 KB											
Best	7	900 KB											
Lens	Focal Length <ul style="list-style-type: none">• Wide - 5.4 mm• Telephoto - 16.2 mm F-Number <ul style="list-style-type: none">• Wide - <i>f</i>2.8 and <i>f</i>5.6• Telephoto - <i>f</i>4.4 and <i>f</i>8.6												
Zoom	3x optical zoom, 4x digital zoom 3x/6x Playback magnify												
Capture methods	Still and video												

Feature	Description
Exposure control	Auto exposure
Shutter speed	1/1000 second to 1/3 second
Video capture and playback	Video clip capture
Audio	None
Flash settings	Auto Flash, Red-eye Reduction, Flash On, Flash Off
Focus	Auto focus range: 20 cm to infinity
ISO (Sensitivity)	100
Metering	Average
White balance	Daylight, overcast, sunset, tungsten, fluorescent
Self-timer	10 second delay
Viewfinder	Optical real image viewfinder
Flash working range	Built-in flash with range up to 2 meters
Image LCD	Backlit color TFT 1.5 inch
Compressed format	JPEG AVI (Motion JPEG) for video
Power	4 AA batteries (included) or optional HP AC adapter (6V 2000 mA) The camera has a maximum power consumption of 1.5 W.

Feature	Description
Interfaces	<ul style="list-style-type: none"> ● USB to computer or USB to HP DeskJet and HP Photosmart printers ● DC IN 6V ● Camera Dock <ul style="list-style-type: none"> • Video to TV
Standards	PTP MSDC NTSC/PAL JPEG DPOF EXIF DCF
Case material	Plastic
Tripod mount	Yes
Dimensions	External Body Dimensions: 120 mm (L) x 50 mm (W) x 74 mm (H)
Weight	203 g

Index

A

- AC power adapter
 - connector 9
 - purchasing 63
 - troubleshooting 43
- accessories for camera 63
- adjusting camera settings 27
- Auto-Flash setting 22

B

- batteries
 - access door 9
 - extending life 62
 - inserting 12
 - level indicators 25, 61
 - managing 61
 - messages 50
 - recharging 62
 - troubleshooting 43, 45, 50
 - types to use 61
- battery charger 63
- Best image quality 23
- Better image quality 23
- blinking lights
 - Camera Dock 66
 - green 11
 - orange 11, 18
 - red 8
- blurry images 46
- bonus software 15, 16
- bright, image too 48

C

- Camera Dock

- connecting to computer, printers, and TV 65
- connectors 65
 - insert 7
 - printing images 68
 - purchasing 63
 - setting up 65
 - turning on and off 66
 - unloading images to a computer 67
- close-up pictures 9
- color depth 69
- compression format 70
- computer
 - connecting to 65
 - unloading images to 39
 - unloading images to using Camera Dock 67
- connectors
 - Camera Dock 65
 - power adapter 9
 - USB 11, 39, 41
- conserving power 62
- customer support. *See* support

D

- dark, image too 47
- date and time
 - setting 14
 - troubleshooting 45
- date image was taken 25
- deleting
 - e-mail addresses 36
 - images 28

digital zoom 21
dimensions of camera 71
disk drive, camera as 31
Display button 11
dock, camera. *See* Camera Dock

doors
batteries 9
memory card 13

E

e-mail
adding, changing, and deleting addresses 36
selecting images for 37
sending pictures by 34, 35
error messages 50, 53
exposure, locking 8, 18

F

fill-flash 22
flash
button 10
turning on and off 22
using 22
working range 70

focus
locking 18
range 70
formatting memory 27, 28

G

Good image quality 23

H

HP Customer Support. *See* support
HP Instant Share

description 33
turning menu on and off 11, 34
HP SupportPack 55

I

image quality. *See* quality
images
date taken 25
deleting 28
magnifying 27, 29
moving from internal memory to memory card 31
previewing 20
printing 40
printing using Camera Dock 68
rotating 27
selecting destinations 34
selecting for automatic processing 33
selecting for e-mail 37
troubleshooting 46, 47, 48
turning on and off 11
unloading from Camera Dock to computer 67
unloading to a computer 39
using instant review 18
viewing on TV 41
viewing on TV using Camera Dock 68
viewing stored 26
viewing thumbnails 27, 29
See also pictures
insert for Camera Dock 7
inserting
batteries 12
camera in Camera Dock 65

- memory card 13
- installing software 15
- interfaces for camera 71
- internal memory
 - capacity 23, 69
 - deleting images 28
 - formatting 27, 28
 - moving images to memory card 31
- ISO sensitivity 70

L

- language setting 14, 32
- LEDs. *See* lights
- lens specifications 69
- lights
 - Camera Dock 66
 - self-timer 8
 - viewfinder 11
- locked memory card 51
- locking
 - exposure 8, 18
 - focus 18

M

- Macintosh
 - e-mail from camera 38
 - installing software 15
 - troubleshooting connection 49
- magnifying images 27, 29
- Mass Storage Device Class (MSDC) 31
- memory card
 - capacity 23
 - deleting images 28
 - formatting 27, 28
 - indicator 25

- inserting 13
- locked 51
- moving images to from internal memory 31
- slot 10
- too full 51
- unsupported 50
- messages, error 50, 53
- mounts
 - tripod 11
 - wrist strap 10
- MSDC (Mass Storage Device Class) 31

N

- navigating through images 11

O

- OK button 11
- optical viewfinder 11
- optical zoom 21

P

- phone support
 - United States 54
 - worldwide 56
- photos. *See* pictures
- Picture Transfer Protocol (PTP) 31
- pictures
 - close-up 21
 - previewing 20
 - printing 34, 35
 - sending by e-mail 34, 35
 - taking 17
 - viewing stored 25
- Playback mode
 - menu 27

- switching to 11
- using 25
- power
 - adapter 9, 63
 - button 8
 - conserving 62
 - specifications 70
 - troubleshooting 43, 45, 50
 - turning on and off 13
- Preview mode
 - turning on and off 11
 - using 20
- printers
 - connecting Camera Dock to 65
 - troubleshooting 51, 52
- printing
 - images 40
 - images using Camera Dock 68
 - pictures 34, 35
- PTP (Picture Transfer Protocol) 31
- purchasing accessories 63
- Q**
- quality
 - changing for images 23
 - settings 23
- Quality button 10
- R**
- recharging batteries 62
- recording video clips 18
- red-eye reduction 22
- regulatory information 60
- resolution. *See* quality
- reviewing pictures. *See* viewing

- rotating images 27

S

- self-timer
 - button 10
 - delay 70
 - light 8
 - using 20
- service. *See* support
- Setup menu 30
- Share button 11, 33
- Share menu. *See* HP Instant Share
- shutter
 - button 8
 - speed 70
 - troubleshooting 44, 46
- slideshow, viewing 41
- software
 - bonus 15, 16
 - installing 15
- specifications for camera 69
- speed of shutter 70
- standards for camera 71
- support
 - United States 54
 - warranty options 55
 - Web sites 53
 - worldwide 56

T

- taking pictures 17
- technical support. *See* support
- telephone support
 - United States 54
 - worldwide 56
- telephoto pictures 9
- thumbnails, viewing 27, 29

- time and date
 - setting 14
 - troubleshooting 45
- tripod mount 11
- troubleshooting problems 43
- turning on and off
 - Camera Dock 66
 - flash 22
 - HP Instant Share menu 34
 - power 13
 - video clips 8

TV

- connecting Camera Dock to
 - 65
- viewing images 41
- viewing images using Camera Dock 68
- viewing slideshow 41

U

- Unloading images 39

USB

- configuring 31
- connector 11, 39, 41
- unknown device 51

V

- Video button 8
- video clips
 - increasing recording time 19
 - maximum recording time 19
 - recording 8, 18
 - reviewing 26
- Video/self-timer light 8
- viewfinder
 - light 11
 - optical 11
- viewing

- images 18
- images on TV 41
- images on TV using Camera Dock 68
- slideshow on TV 41
- stored images 26
- stored pictures 25
- thumbnails 27
- video clips 26

W

warranty

- options 55
- statement 58

- Web sites for support 53

- weight of camera 71

- Welcome Screen, setting 30

- wide angle pictures 9

Windows

- e-mail from camera 38
- software installation 15

- wrist strap 10, 12

Z

zoom

- digital 21
- lens 9
- optical 21

- Zoom Out button 10

www.hp.com/photosmart

Printed in Singapore 2002



Q2170-90010

Free Manuals Download Website

<http://myh66.com>

<http://usermanuals.us>

<http://www.somanuals.com>

<http://www.4manuals.cc>

<http://www.manual-lib.com>

<http://www.404manual.com>

<http://www.luxmanual.com>

<http://aubethermostatmanual.com>

Golf course search by state

<http://golfingnear.com>

Email search by domain

<http://emailbydomain.com>

Auto manuals search

<http://auto.somanuals.com>

TV manuals search

<http://tv.somanuals.com>