

HP Photosmart R837

Digital Camera



User Guide



Legal and notice information

© Copyright 2007 Hewlett-Packard Development Company, L.P.

The information contained herein is subject to change without notice. The only warranties for HP products and services are set forth in the express warranty statements accompanying such products and services. Nothing herein should be construed as constituting an additional warranty. HP shall not be liable for technical or editorial errors or omissions contained herein.

Windows® is a U.S. registered trademark of Microsoft Corporation.



SD Logo is a trademark of its proprietor.

Contents

1	Getting started	5
	Camera top, side, and back	5
	Camera front and bottom.....	6
	Before taking pictures.....	6
	Install the battery.....	7
	Charge the battery.....	7
	Turn on the camera.....	7
	Choose the language.....	8
	Set the region.....	8
	Set the date and time.....	8
	Install and format an optional memory card.....	9
	Install the software.....	9
	Using your camera.....	10
2	Taking pictures and recording video clips	11
	Taking pictures.....	11
	Recording video clips.....	12
	Instant Review.....	12
	Auto focus and exposure.....	12
	Focusing on the subject.....	12
	Optimizing focus.....	13
	Using Focus Lock.....	13
	Optimizing exposure.....	13
	Using zoom.....	14
	Optical zoom.....	14
	Digital zoom.....	14
3	Setting options for taking pictures and recording video clips	16
	Setting the flash.....	16
	Red eye.....	16
	Using the shooting modes.....	16
	Using Panorama mode.....	17
	Using the Picture Capture and Video Record menus.....	18
	Using the Self-Timer settings.....	21
	Using the Burst setting.....	21
	Adaptive Lighting.....	22
	Exposure Compensation.....	22
	White Balance.....	22
	ISO speed.....	22

4	Reviewing images and video clips	24
	Using Playback.....	24
	Deleting images.....	25
	Viewing thumbnails.....	25
	Magnifying images.....	25
	Using the Playback Menu.....	26
	Tagging images.....	26
	Viewing slideshows.....	27
	Stitching panoramas.....	27
5	Using the Design Gallery Menu	28
	Removing red eyes.....	28
	Applying artistic effects.....	28
	Enhancing photos.....	29
	Modifying colors.....	30
	Adding borders.....	30
	Cropping images.....	31
6	Transferring and printing images	32
	Transferring images with HP Photosmart Software.....	32
	Transferring images without HP Photosmart Software.....	33
	Connecting to the computer.....	33
	Using a memory card reader.....	33
	Printing directly to a printer.....	33
7	Using HP Photosmart Express	36
	Using the Photosmart Express Menu.....	36
	Marking images for printing.....	36
	Buying prints online.....	37
	Sharing images.....	37
	Setting up online destinations in the camera.....	38
	Sending images to online destinations.....	38
8	Using the Camera Setup Menu	39
9	Troubleshooting	41
	Resetting the camera.....	41
	Problems and solutions.....	41
	Camera error messages.....	45
10	Product support	46
	Helpful websites.....	46
	Getting assistance.....	46
A	Managing batteries	48
	Top points about batteries.....	48
	Extending battery life.....	48
	Safety precautions for using batteries.....	48
	Power indicators.....	49
	Number of shots per battery charge.....	49
	Recharging the Lithium Ion battery.....	49
	Safety precautions for recharging batteries.....	50
B	Specifications	52
	Memory capacity.....	53
	Image quality.....	54
	Video quality.....	54
	Index	55

1 Getting started

Use this section to get familiar with the camera controls, set up your digital camera for use, and begin taking pictures.

Camera top, side, and back

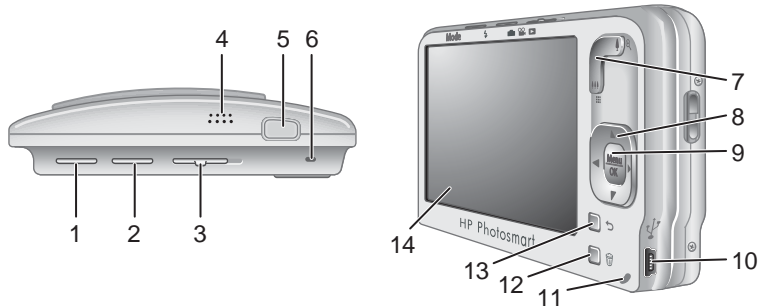

1	Mode button —Accesses the Mode Shooting Mode menu while in Picture Capture (see <i>Using the shooting modes on page 16</i>).
2	Flash button —Accesses the flash settings while in Picture Capture (see <i>Setting the flash on page 16</i>).
3	Mode Selector —Switches between Picture Capture , Video Record , and Playback (see <i>Taking pictures on page 11</i> , <i>Recording video clips on page 12</i> , and <i>Reviewing images and video clips on page 24</i>).
4	Speaker.
5	Shutter button .
6	Power light.
7	Zoom lever —Accesses Zoom (see <i>Using zoom on page 14</i>), Thumbnails (see <i>Viewing thumbnails on page 25</i>), and Magnify (see <i>Magnifying images on page 25</i>) functions.
8	▲▼ and ◀▶ buttons —Scroll through menus and images.
9	Menu/OK button —Displays camera menus, selects options, and confirms actions.
10	USB connector.
11	Battery Charging light.
12	Delete button — Accesses the Delete function while in Playback (see <i>Deleting images on page 25</i>) or Instant Review (see <i>Instant Review on page 12</i>).

(continued)

13	 Back button—Returns you to the previous menu or view.
14	Image Display.

Camera front and bottom

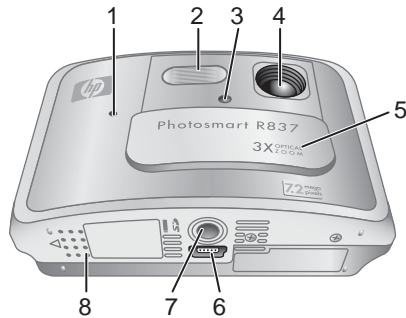

1	Microphone.
2	Flash.
3	Self-Timer/Focus Assist light—See <i>Using the Self-Timer settings</i> on page 21.
4	Lens.
5	Lens cover/Power switch—Turns the camera on and off and protects the lens while the camera is off.
6	Dock connector.
7	Tripod mount.
8	Battery/Memory Card door.

Before taking pictures

Complete the following procedures before taking pictures or recording video clips.

Install the battery

1. Open the Battery/Memory Card door by sliding the door latch as indicated on the Battery/Memory Card door.
2. Insert the battery in the larger slot, pushing the battery in until the latch catches.
3. Close the Battery/Memory Card door.

To remove the battery, press the battery latch as shown until the battery springs free.



Note Fully charge the battery before using it the first time (see [Charge the battery on page 7](#)). Turn off the camera before removing the battery.

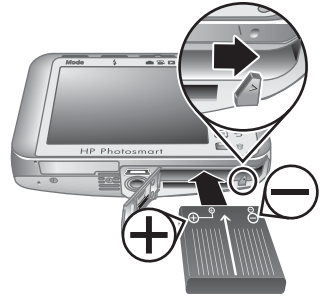

Charge the battery

To charge the battery in the camera:

1. Plug the small end of the USB cable into the camera and the large end into the power adapter, then plug the power adapter into an electrical outlet, as shown.

The camera's blinking Battery Charging light indicates that the battery is charging. The battery is fully charged when the Battery Charging light turns on solid (see [Recharging the Lithium Ion battery on page 49](#) for information on charging times).

2. When charging is complete, disconnect the camera from the power adapter.



Note For other methods for recharging the battery, see [Recharging the Lithium Ion battery on page 49](#).

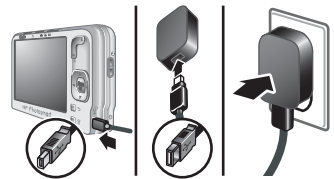

Turn on the camera

To turn on the camera, slide the lens cover open until it clicks, uncovering the lens.

To turn off the camera, slide the lens cover closed until it clicks, covering the lens.



Caution When sliding the lens cover, keep your fingers clear of the lens. Fingerprints on the lens can impair the quality of the picture.



Choose the language

Use $\blacktriangle\blacktriangledown$ $\blacktriangleleft\blacktriangleright$ to choose the language you want, then press $\frac{\text{Menu}}{\text{OK}}$.

To change the language later, use the **Camera Setup Menu** (see [Using the Camera Setup Menu](#) on page 39).



Set the region

Along with the **Language** setting, the **Region** setting determines the default date format and the format of the video signal for displaying camera images on a television when connected through an optional HP Photosmart dock (see [Using the Camera Setup Menu](#) on page 39).

Use $\blacktriangle\blacktriangledown$ to choose the region you want, then press $\frac{\text{Menu}}{\text{OK}}$.

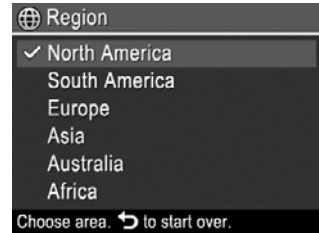

Set the date and time

Accurately setting the date and time will help you locate images once you have transferred them to your computer, and will ensure that images are accurately marked if you use the date and time imprint feature. See **Date & Time Imprint** under [Using the Picture Capture and Video Record menus](#) on page 18.

1. Use $\blacktriangle\blacktriangledown$ to adjust the highlighted value.
2. Use $\blacktriangleleft\blacktriangleright$ to move to the other selections and repeat Step 1 until the date and time are set correctly.
3. Press $\frac{\text{Menu}}{\text{OK}}$ when the date, time, and format settings are correct, then press $\frac{\text{Menu}}{\text{OK}}$ again to confirm.

To change the date and time later, use the **Camera Setup Menu** (see [Using the Camera Setup Menu](#) on page 39).

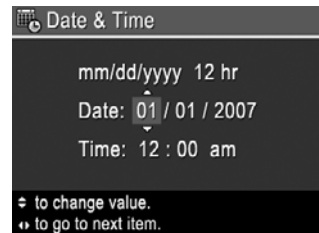

Install and format an optional memory card

This camera supports standard, high speed, and high capacity Secure Digital (SD) memory cards, 32MB to 4GB.

1. Turn off the camera and open the Battery/Memory Card door.
2. Insert the optional memory card in the smaller slot as shown. Make sure the memory card snaps into place.
3. Close the Battery/Memory Card door and turn on the camera.



Always format new memory cards before first use. Formatting removes all images from the memory card, so make sure to transfer existing images before formatting (see *Transferring and printing images on page 32*).

1. With the camera turned on, slide to .
2. Press .
3. Use to select **Format Card**, then press .
4. Use to select **Yes**, then press to format the card.



Note Once you install a memory card, all new images and video clips are stored on the card, rather than in internal memory. To use internal memory and view images stored there, remove the memory card. To transfer images from internal memory to an optional memory card, see **Move Images to Card** under *Using the Playback Menu on page 26*.

For information about supported memory cards, see **Storage** under *Specifications on page 52*.

Install the software

The HP Photosmart Software provides features for transferring images and video clips to your computer, as well as features for modifying stored images (remove red eyes, rotate, crop, resize, adjust image quality, and more). See the **Help** feature in the HP Photosmart Software.

To install the HP Photosmart Software, your computer must meet the system requirements as stated on the camera packaging.

To learn about Windows Vista support for your camera, see www.hp.com/go/windowsvista (English only).

1. Close all programs and temporarily disable any virus protection software.
2. Insert the HP Photosmart Software CD into the CD drive and follow the on-screen instructions. If the installation screen does not appear, click **Start**, click **Run**, type **D:\Setup.exe**, where **D** is the letter of your CD drive, then click **OK**.
3. When the software has finished installing, re-enable virus protection software.



Note If you have trouble installing or using the HP Photosmart Software, see the Hewlett-Packard Technical Support website for more information: www.hp.com/support.

About the HP Photosmart Software

The CD that came with your camera contains HP Photosmart Software for computers running Windows XP or x64 with at least 128MB of RAM.







To learn more about the software features and how to use them, see the **Help** feature in the HP Photosmart Software.

Using your camera

Now that you've completed setup, you can take and review pictures and video clips.

For information on taking pictures and capturing video clips	See <i>Taking pictures on page 11</i> and <i>Recording video clips on page 12</i> .
For information on setting picture capture and video record options	See <i>Setting options for taking pictures and recording video clips on page 16</i> .
For information on reviewing images and video clips on the camera	See <i>Reviewing images and video clips on page 24</i> .
For information on enhancing your images	See <i>Using the Design Gallery Menu on page 28</i> .
For information on transferring images from your camera to a computer	See <i>Transferring images with HP Photosmart Software on page 32</i> .
For information on printing images	See <i>Printing directly to a printer on page 33</i> .



Tip To switch between  **Picture Capture**,  **Video Record**, and  **Playback**, slide    to the desired option.

2 Taking pictures and recording video clips

You can take pictures when you are in **Picture Capture** and you can record video when you are in **Video Record**. Slide to to take pictures or to to record video clips. The Image Display resembles the following:



1		<ul style="list-style-type: none"> • Picture Capture indicator. • Video Record indicator.
2	12 0:15	<ul style="list-style-type: none"> • When taking pictures, pictures remaining count. • When recording video clips, time remaining (in minutes and seconds).
3		Memory card indicator.
4		Battery level indicator (see <i>Power indicators</i> on page 49).
5		Focus brackets (see <i>Auto focus and exposure</i> on page 12).

Taking pictures

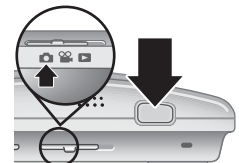

You can take a picture when the camera is set to **Picture Capture**.

1. Slide to .
2. Frame the subject for your picture in the Image Display.
3. Press the **Shutter** button halfway down to measure and lock the focus and exposure. The focus brackets in the Image Display turn solid green when focus is locked (see *Auto focus and exposure* on page 12).
4. Press the **Shutter** button all the way down to take the picture.





Recording video clips

You can record a video clip when the camera is set to  **Video Record**.

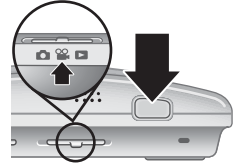
1. Slide  to .
2. Frame the subject in the Image Display.
3. Press the **Shutter** button halfway down to measure focus and exposure. The focus brackets in the Image Display turn solid green when focus is locked (see [Auto focus and exposure on page 12](#)).
4. Press the **Shutter** button all the way down and release to begin recording video.
5. To stop recording video, press and release the **Shutter** button again.





Instant Review

After you have taken a picture or recorded a video clip, the camera displays it briefly in **Instant Review**. If you want to delete the image or video clip, press , select **This Image** from the **Delete** sub-menu, then press .

Auto focus and exposure

When you press the **Shutter** button halfway down, the camera automatically measures and locks the focus (for pictures and video clips) and exposure (for pictures only). When you auto focus:

Indicator	Description
Green focus brackets	Focus found.
Red focus brackets	Focus not found (see Optimizing focus on page 13).
 (shaking hand icon)	(Pictures only) Long exposure required (see Optimizing exposure on page 13).

 **Tip** If you follow the suggestions for focus and exposure and your image does not appear to be in proper focus or exposure when viewed in  **Playback**, see the topics on blurry, dark, light, or grainy images in [Troubleshooting on page 41](#).

Focusing on the subject

When you press the **Shutter** button halfway down, the camera searches for focus within the focus brackets. When it finds focus, the focus brackets turn green. If the focus brackets do not frame your subject, use **Focus Lock** (see [Using Focus Lock on page 13](#)).



Optimizing focus

When the camera cannot auto focus, the focus brackets turn red. This indicates the picture may be out of focus because the subject is out of the focus range or the scene has low contrast.



If you are recording a video or taking a picture with a shooting mode (see [Using the shooting modes on page 16](#)) other than  **Close-up** and cannot focus, it will still take the picture. Try releasing the **Shutter** button, reframing, and then pressing the **Shutter** button halfway down again. If the focus brackets are still red:

For pictures and video clips: If the scene has low contrast, use **Focus Lock** (see [Using Focus Lock on page 13](#)) and aim at a point on the subject that has more colors or crisp edges.

For pictures only:

- Select a shooting mode more appropriate for the scene you are capturing (see [Using the shooting modes on page 16](#)).
- If the subject is too close (less than 100 mm or 4.7 in), move farther away from the subject or use  **Close-up** (see **Close-up** under [Using the shooting modes on page 16](#)).

If the camera is set to  **Close-up** and cannot focus, the camera will not take the picture. Try one of the following:

- Move within the  **Close-up** range (100 mm to 1 m or 4.7 to 39.4 in) or set the camera to  **Auto** (see **Auto** under [Using the shooting modes on page 16](#)).
- In low contrast scenes, use **Focus Lock** (see [Using Focus Lock on page 13](#)).

Using Focus Lock

Use **Focus Lock** to focus on a subject that is not in the center of the picture, to capture action shots more quickly by pre-focusing in the area where the action will occur, or to focus in low light or low contrast situations.

1. Frame the subject for your picture within the focus brackets. In low light or low contrast situations, frame a brighter or higher contrast object.
2. Press the **Shutter** button halfway down.
3. Hold the **Shutter** button halfway down and re-frame.
4. Press the **Shutter** button all the way down to take the picture.



Optimizing exposure

When you are taking a picture and press the **Shutter** button halfway down, the camera also measures the light level to set the proper exposure.

If the camera determines the scene will require a very long exposure, a shaking hand icon (👋) appears. The camera will take the picture, but it may be blurry because it is difficult to hold the camera still for the length of time required. Try one of the following:

- Set the flash to **Auto Flash** or **Flash On** (see [Setting the flash on page 16](#)).
- Set the camera on a tripod or stable surface.
- If the subject is out of the flash range or you do not have a tripod, set the shooting mode to **Steady Photo** (see **Steady Photo** under [Using the shooting modes on page 16](#)).
- Turn on more light.



Note When you are recording a video, the camera continuously updates exposure.

Using zoom

Your camera has both optical and digital zoom. Optical zoom physically adjusts the lens to make the subject of your picture appear closer. After you have zoomed the lens fully using optical zoom, the camera employs digital zoom. Digital zoom uses no moving lens parts.



Tip The more you zoom in on the subject of your picture, the more small movements of the camera are magnified (this is called camera shake). If **👋** appears when you press the **Shutter** button halfway down, the picture may be blurry. Hold the camera still, add more light to the scene, or use **Steady Photo** shooting mode (see [Using the shooting modes on page 16](#)). Try holding the camera closer to your body or against a steady object, or set the camera on a tripod or stable surface.

Optical zoom

Optical zoom moves the lens between wide angle (1x) and telephoto (3x).

While in **Picture Capture** or **Video Record**, use the buttons on the **Zoom** lever to control zoom. Press **▲** to zoom in and **▼** to zoom out.







Digital zoom

In digital zoom, the Image Display shows a yellow frame around the scene and the image quality setting (MP value). As you zoom in, the scene enlarges within the yellow frame to indicate the area of the scene the camera will capture, and the MP value decreases to indicate the resolution at which the scene will be captured.

When capturing images using digital zoom, make sure that the MP value shown in the Image Display is appropriate for the size at which you want to print the captured image.

For MP values and their recommended print sizes, see **Image Quality** under *Using the Picture Capture and Video Record menus* on page 18.

1. While in  **Picture Capture**, press  on the **Zoom** lever to optically zoom to the maximum level, then release the lever.
2. Press and hold  until the image you want to capture fills the yellow frame. If you zoom in too far, press .
3. To return to optical zoom, press .







Note Digital zoom is not available in **Panorama** mode nor when recording video clips.

3 Setting options for taking pictures and recording video clips









Your camera's settings work well for most shooting situations. For some situations, however, the features described in this chapter can improve the pictures you take and the video clips you record. In addition to setting features that optimize the camera for lighting and motion, you can also set the camera to create a panorama, to take a series of pictures rapidly or take images 10 seconds after you press the **Shutter** button, giving you time to put yourself in the image.

Setting the flash

To select a flash setting, press  while in  **Picture Capture**, use   to highlight the desired flash mode, then press . To exit without changing the flash setting, press .

	Auto Flash (Default)—The camera uses the flash, if necessary. The flash may cause a phenomenon called red-eye (see Red eye on page 16).
	Flash On —The camera always uses flash. If the light is behind your subject, use this setting to increase the light on the front of your subject. The flash may cause a phenomenon called red-eye (see Red eye on page 16).
	Flash Off —The camera does not use flash. Use this setting to capture poorly lit subjects beyond the flash range or to capture scenes with the existing light.

The **Flash** setting remains in effect until it is changed again, or you turn off the camera.

 **Note** The flash is set to  **Flash Off** in  **Landscape**,  **Panorama**,  **Sunset**, and  **Theatre** shooting modes, with the  **Burst** setting, and while recording video clips. The flash is set to  **Flash On** in  **Night Portrait** shooting mode.













Red eye

The red-eye phenomenon is caused when light from the flash reflects off the subjects' eyes, which can make human eyes appear red and animal's eyes appear to glow in the captured image. You can remove the red eyes in human subjects after you have captured the image, using either **Remove Red Eyes** (see **Remove Red Eyes** under [Using the Design Gallery Menu on page 28](#)) or the HP Photosmart Software that came with your camera. You can remove the glowing eyes in animal subjects after you have captured the image using **Pet-Eye Fix** (see [Enhancing photos on page 29](#)).

Using the shooting modes

Shooting modes are predefined settings for everyday situations. They are optimized for particular types of scenes or shooting situations.

To select a shooting mode, press **Mode** while in  **Picture Capture**, use **◀▶** to highlight a shooting mode, then press **Menu** OK. To exit without changing the shooting mode, press **↶**.

	Auto Mode (Default)—For taking good shots quickly, when you do not have time to select a special shooting mode.
	Close-up —Use when taking close-up pictures of subjects between 100 mm and 1 m (4.7 to 39.4 in) away.
	Steady Photo —For minimizing picture blur when the subject is moving or you cannot hold the camera still long enough in moderate to dim light conditions (see Optimizing exposure on page 13).
	Theatre —For capturing images at school programs, concerts, or indoor sporting events without using flash.
 or 	Panorama —For grand landscapes or group pictures where you need to capture a wide shot that one image cannot capture (see Using Panorama mode on page 17).
	Landscape —For scenes with deep perspective, such as mountain scenes.
	Portrait —For pictures that have one or more people as their primary subject.
	Action —For capturing sporting events, moving cars, or any scene where you want to stop the action.
	Night Portrait —For capturing images of people at night. This mode uses the flash and a long exposure. As a result, you must set the camera on a tripod or stable surface.
	Beach —For capturing scenes at the beach.
	Snow —For capturing scenes in snow.
	Sunset —For capturing outdoor scenes at sunset.



Note The shooting modes do not apply when you are recording video clips.

The shooting mode remains in effect until it is changed again, or until you turn off the camera.

Using Panorama mode

Panorama mode allows you to take a sequence of 2 to 5 pictures that can be stitched together to capture a scene too wide to fit into a single picture. To stitch your panoramic sequence together, use **Stitch Panorama** on the camera (see [Stitching panoramas on page 27](#)). If you installed the HP Photosmart Software (see [Install the software](#)

on page 9), you can also stitch panoramas automatically as you transfer them to your computer.

1. While in **Picture Capture**, press **Mode**, use **◀▶** to select either **Panorama** (left to right) or **Panorama** (right to left), then press $\frac{\text{Menu}}{\text{OK}}$.
2. Press the **Shutter** button to take the first picture in the panoramic sequence.
3. Position the camera to take the second picture. Use the transparent overlay of the first image superimposed on one third of the Image Display to align your second picture with the first.
4. Press the **Shutter** button to take the second picture.
5. Continue adding up to three more pictures to the panorama, or press $\frac{\text{Menu}}{\text{OK}}$ to end the panoramic sequence.

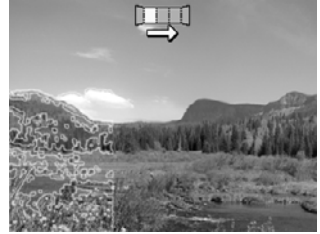

During **Instant Review** (see *Instant Review on page 12*), each image in the panoramic sequence is displayed. When the last image is displayed, you can stitch the sequence by pressing **◀**, then pressing $\frac{\text{Menu}}{\text{OK}}$ when the stitched panorama appears. You can also delete the panoramic sequence by pressing **🗑**, selecting **Entire Panoramic Sequence**, then pressing $\frac{\text{Menu}}{\text{OK}}$.







Using the Picture Capture and Video Record menus

The **Picture Capture** and **Video Record** menus allow you to adjust camera settings that affect the characteristics of the pictures and video clips you capture. The **Picture Capture Menu** displays only those features available for taking pictures while the **Video Record Menu** displays only features available for recording video clips.







1. Slide **📷**, **📹** to **📷** or **📹**, then press $\frac{\text{Menu}}{\text{OK}}$.
2. Use **▲▼** to highlight a menu option, then press $\frac{\text{Menu}}{\text{OK}}$ to display the menu option's sub-menu.
3. Use **▲▼** to highlight a setting, then press $\frac{\text{Menu}}{\text{OK}}$ to change the setting or press **↶** to exit without changing the setting.
4. To exit the menu, press **↶** repeatedly until you return to **📷 Picture Capture** or **📹 Video Record**.

For on-camera information about an option, use **▲▼** to highlight **Help...** in the option's sub-menu, then press $\frac{\text{Menu}}{\text{OK}}$.



Unless otherwise noted, the setting remains in effect until you turn off the camera. The next time you turn on the camera, the settings reset to their defaults.

	<p>Video Quality (📷 only)—Sets resolution and compression for video clips. The setting remains in effect until it is changed, even when you turn off the camera.</p> <ul style="list-style-type: none"> ● Best (Default)—For outdoor action video clips or printing individual video frames up to 10.2 by 15.2 cm (4 by 6 in). ● ★★ Better—For indoor video clips or printing individual video frames up to 7.6 by 12.7 cm (3 by 5 in). ● ★ Good—For capturing longer video clips or e-mailing shorter clips.
	<p>Self-Timer—For capturing images or recording video after a 10-second delay (see Using the Self-Timer settings on page 21). The setting resets to Off after the image is taken.</p> <ul style="list-style-type: none"> ● Off (Default)—Disables Self-Timer. ● On—For taking one delayed shot or video clip. ● On-2 Shots (📷 only)—For taking two delayed shots.
	<p>Adaptive Lighting (📷 only)—Balances the relationship between light and dark areas. For more information, see Adaptive Lighting on page 22.</p> <p>Off (Default), On</p>
	<p>Image Quality (📷 only)—Sets resolution and compression for images. The greater the number, the higher the resolution. The setting remains in effect until it is changed, even when you turn off the camera.</p> <ul style="list-style-type: none"> ● 7MP Best—For enlarging or printing images greater than 28 x 36 cm (11 by 14 in). ● Normal (7MP) (Default)—For printing images up to 28 x 36 cm (11 by 14 in). ● 5MP—For printing images up to 20 x 25 cm (8 by 10 in). ● 2MP—For printing images up to 13 x 18 cm (5 by 7 in). ● VGA—For sending images via e-mail or posting them to the Internet.
	<p>Burst (📷 only)—For taking two or more shots quickly in succession (see Using the Burst setting on page 21).</p> <p>Off (Default), On</p>
	<p>Tag—Applies a tag to pictures and video clips as they are taken or recorded. The setting remains in effect until it is changed, even when you turn off the camera.</p> <p>To select a tag to apply, use ▲▼ to highlight a tag, then press <small>Menu</small> <small>OK</small> .</p> <p>For more information about tags, see Tagging images on page 26.</p>

(continued)

	<p>Date & Time Imprint (📷 only)—Imprints date in lower left corner of image. The setting remains in effect until it is changed, even when you turn off the camera.</p> <ul style="list-style-type: none"> • Off (Default)—No date or time imprinted on the image. • Date Only—Date permanently imprinted. • Date & Time—Date and time permanently imprinted.
	<p>Exposure Compensation—Overrides the camera's automatic exposure setting. For more information, see Exposure Compensation on page 22.</p> <ul style="list-style-type: none"> • To make the images you are about to capture brighter, press ▶ to increase the value. • To make the images you are about to capture darker, press ◀ to decrease the value.
	<p>Exposure Bracketing (📷 only)—Creates a set of three images captured at the value set for Exposure Compensation and under- and over-exposed by the value you select using ▲▼.</p> <ul style="list-style-type: none"> • Off (Default) • ± 0.5 • ±1.0 <p>During Instant Review (see Instant Review on page 12), you can delete the entire bracketing sequence. To delete individual images, see Deleting images on page 25.</p>
	<p>White Balance—Balances color based on lighting conditions. For more information, see White Balance on page 22.</p> <ul style="list-style-type: none"> • Auto (Default)—Corrects for scene illuminance. For general picture taking. • Sun—For outdoor scenes in sunny or cloudy conditions. • Shade—For outdoor scenes in shade or at dusk. • Tungsten—For indoor scenes with incandescent or halogen lighting. • Fluorescent—For indoor scenes with fluorescent lighting.
	<p>ISO Speed—Adjusts the camera's sensitivity to light. For more information, see ISO speed on page 22.</p> <ul style="list-style-type: none"> • Auto (Default)—Camera selects the best ISO speed for the scene. • ISO 100—For best quality. • ISO 200—For lower light conditions. • ISO 400—For lower light conditions and/or action when short shutter speeds are desired.
	<p>AE Metering—Specifies which region of a scene the camera uses to calculate the exposure.</p> <ul style="list-style-type: none"> • Average (Default)—Useful when you want the entire scene to be used when calculating exposure. • Spot—Useful in backlit scenes or when the subject is very dark or light compared to the rest of the scene. For best results, use Focus Lock (see Using Focus Lock on page 13) with Spot.

(continued)









	Camera Setup... —Displays the Camera Setup Menu for setting camera behavior (see Using the Camera Setup Menu on page 39).
	Camera Help... —Displays a list of help topics for commonly used features.



Note Some options are not available in certain shooting modes or in combination with other **Picture Capture** or **Video Record** menu options.

Using the Self-Timer settings

The Self-Timer allows you to take one or two pictures or one video clip after a 10-second delay.

1. While in the **Picture Capture** or **Video Record** menu, use  to highlight  **Self-Timer**, then press .
2. In the **Self-Timer** sub-menu, use  to select **On** (for one shot) or **On-2 Shots**, press , then press  repeatedly until you return to  **Picture Capture** or  **Video Record**. For more details on selecting options in the **Picture Capture** and **Video Record** menus, see [Using the Picture Capture and Video Record menus on page 18](#).
3. Set the camera on a tripod or stable surface.
4. Frame the subject in the Image Display.
5. Press the **Shutter** button halfway down to lock focus and exposure. When the focus brackets turn green, press the **Shutter** button all the way down. The camera begins the 10-second countdown, then takes the picture or begins recording the video clip. If you chose **On-2 Shots**, the camera takes the second picture a few seconds after the first.
6. If you are recording a video clip, press the **Shutter** button to stop recording.









Tip If you want to include yourself in the picture, place the camera on a tripod or stable surface, then press the **Shutter** button all the way down. The camera locks focus and exposure just before the end of the countdown, allowing you time to place yourself in the scene.

The **Self-Timer** setting resets to the default **Off** setting after the picture or video clip is taken.

Using the Burst setting

Burst allows you to take two or more pictures as quickly as possible when you press and hold the **Shutter** button all the way down.

1. While in the **Picture Capture Menu**, use  to highlight  **Burst**, press , highlight **On**, press , then press  repeatedly until you return to  **Picture Capture**. For more details on selecting options in the **Picture Capture Menu**, see [Using the Picture Capture and Video Record menus on page 18](#).
2. Frame the subject, then press the **Shutter** button halfway down to lock the focus and exposure. Then press the **Shutter** button all the way down and hold it. The camera takes pictures as quickly as possible until you release the **Shutter** button or the camera runs out of memory.

The Image Display remains off during the burst capture. After the burst images have been taken, each image appears one at a time in **Instant Review** (see [Instant Review](#)

on page 12). You can delete the entire burst sequence in **Instant Review**. To delete individual images, see *Deleting images* on page 25.

The **Burst** setting remains in effect until it is changed again, or until it resets to the default **Off** setting when you turn off the camera.

Adaptive Lighting

This setting balances the relationship between bright and dark areas in a picture, preserving gentle contrasts while reducing harsh contrasts. When used with a flash, **Adaptive Lighting** can brighten areas that a flash wouldn't reach. **Adaptive Lighting** is useful in situations like these:

- Outdoor scenes with a mixture of sun and shade
- High contrast scenes that contain both light and dark objects
- Indoor scenes that use flash photography (to soften or even out the effect of the flash)
- Backlit scenes where the subject is too far away for the flash to reach, or is severely backlit (for example, in front of a window)

You can use **Adaptive Lighting** with or without flash, but it is not recommended as a replacement for flash. Unlike the flash, **Adaptive Lighting** does not affect exposure settings, so brightened areas may appear noisy or grainy, and indoor or night images may be blurry if taken without a flash or a tripod.

Exposure Compensation

You can use **Exposure Compensation** to override the camera's automatic exposure setting. **Exposure Compensation** is useful in scenes that contain many light objects (like a white object against a light background) or many dark objects (like a black object against a dark background). Such scenes could turn out gray without the use of **Exposure Compensation**. For a scene with many light objects, increase the **Exposure Compensation** to a positive number. For a scene with many dark objects, decrease the **Exposure Compensation**.



Tip To see the effect varying **Exposure Compensation** settings might have on a scene, use **Exposure Bracketing** (see **Exposure Bracketing** under *Using the Picture Capture and Video Record menus* on page 18).

White Balance

Different lighting conditions cast different colors. This setting allows the camera to compensate for this, reproducing colors more accurately and ensuring that whites appear white in the final image. You can also adjust the white balance to produce creative effects. For example, the **Sun** setting produces a warmer look to the image.

ISO speed

This setting adjusts the sensitivity of the camera to light. When **ISO Speed** is set to the default **Auto** setting, the camera selects the best ISO speed for the scene.

Lower ISO speeds capture images with the least amount of grain (or noise), but result in slower shutter speeds. If taking a picture in low light conditions without a flash at **ISO 100**, use a tripod.

Higher ISO numbers allow faster shutter speeds, and can be used when taking pictures in dark areas without a flash, or when taking pictures of fast moving objects. Higher ISO speeds produce pictures with more grain (or noise) and, therefore, can be of lower quality.

4 Reviewing images and video clips

You can review and manipulate images and video clips in **Playback** as described here. For information about enhancing images, see [Using the Playback Menu on page 26](#) and [Using the Design Gallery Menu on page 28](#).

Using Playback



1. Slide to .
2. Use to scroll through your images and video clips.
3. Press to play video clips; press to pause a clip. When paused, use to scroll through the individual frames; press to resume playing the video.

During **Playback**, the Image Display also indicates additional information about each image or video clip.







1		Playback indicator.
2		Memory card indicator.
3		Battery indicator (see Power indicators on page 49).
4	1 of 30	Number of this image or video clip out of the total number of stored images and video clips.
5		Image position in a panoramic sequence.
6		Tagged image (see Tagging images on page 26). If tagged as a Favorite , displays; if tagged with any other tag, and the number of attached tags display.
7		Image marked to buy prints online (see Buying prints online on page 37).

(continued)











8	 1	Number of electronic Photosmart Share destinations (see <i>Sharing images on page 37</i>).
9	 3	Number of copies to print (see <i>Marking images for printing on page 36</i>).

Deleting images

To delete a displayed image during  **Playback**:









1. Press .
2. Use   to select an option, then press  .
 - **This Image**—Deletes the image or video clip.
 - **All Except Favorites**—Deletes all images except those tagged as **Favorites**. This menu option only appears if you have images tagged as **Favorites** (see *Tagging images on page 26*).
 - **Entire Panoramic Sequence**—If the current image is part of a panoramic sequence, deletes all images in the panoramic sequence.
 - **All Images (in Memory/on Card)**—Deletes all stored images and video clips.
 - **Format (Memory/Card)**—Deletes all stored files, then formats the internal memory or memory card.

Viewing thumbnails

1. While in  **Playback**, press  **Thumbnails** (same as  **Zoom Out** on the **Zoom** lever) to view thumbnails.
2. Use   and   to scroll through the thumbnails.
3. Press   to exit  **Thumbnails** and view the highlighted image on the Image Display.















Once in  **Thumbnails** view, you can view thumbnails by date:

1. Press . Each thumbnail in this view represents a group of images taken on the same date.
2. Use   and   to scroll through the thumbnails.
3. Press   to return to  **Thumbnails**.





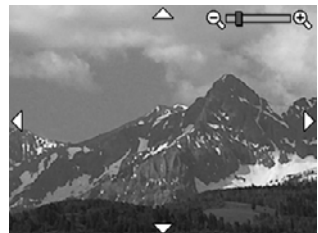

Magnifying images









This feature is for viewing purposes only; it does not permanently alter the image.

1. While in  **Playback**, press  (same as  **Zoom In** on the **Zoom** lever). The currently displayed image is magnified 2x.
2. Use   and   to pan around the magnified image.
3. Use  and  to change the magnification.
4. Press   to return to  **Playback**.







Using the Playback Menu

1. While in  **Playback**, press .
2. Use  to highlight an option.
3. Use  to select an image or video clip, press , and follow the on-camera instructions.
4. Press  repeatedly to return to  **Playback**.

	Design Gallery... —See <i>Using the Design Gallery Menu</i> on page 28.
	Photosmart Express... —See <i>Using HP Photosmart Express</i> on page 36.
	Tag —Allows you to tag images with a predefined tag, which you can then use to mark images for printing, sharing, or buying prints online, or use to sort images once you have transferred them to your computer. See <i>Tagging images</i> on page 26.
	View Slideshow —See <i>Viewing slideshows</i> on page 27.
	Stitch Panorama —See <i>Stitching panoramas</i> on page 27.
	Move Images to Card —Moves images from internal memory to a memory card. This option is only available if there are images in internal memory and a memory card is inserted. To move images, select this option and follow the on-screen prompts.
	Camera Setup... —Displays the Camera Setup Menu for setting camera behavior (see <i>Using the Camera Setup Menu</i> on page 39).
	Camera Help... —Displays a list of help topics for commonly used features.





Tagging images

To tag a displayed image during  **Playback**:

1. While in the **Playback Menu**, press  to highlight  **Tag**, then press .
2. Use  to select a tag from the **Tag** sub-menu.
 - Select  **Favorites**, **Holidays**, **Birthdays**, **Family**, **Children**, **Friends**, **Pets**, **Activities**, **Vacations**, or **Other** to select a predefined tag.
 - Select **Tag Menu Setup...** to define new tags (see *Defining tags* on page 26).
 - Select **Tag All Images...** then select a tag to tag all images with the same tag.



Note You can apply multiple tags to the same picture or video.

3. Press  to apply the selected tag to the displayed image; press  again to deselect the tag.
4. Press  repeatedly to return to  **Playback**.

Defining tags

The HP Photosmart Software that came with your camera includes a feature that allows you to define custom tags on your computer, then transfer the tags to your camera.

To define tags:

1. In the **Tag** sub-menu, select **Tag Menu Setup...**
2. Connect your camera to your computer (see [Connecting to the computer on page 33](#)).
The Tag Setup Software launches automatically.
3. Follow the instructions in the Tag Setup Software help system to create, delete, and reorder tags, and to save new and modified tags to your camera.

Viewing slideshows

Select  **View Slideshow** to configure and run a slideshow of images and/or video clips on the camera Image Display or on a TV (if the camera is docked in an optional HP Photosmart dock and connected to a TV).

- **Images**—Plays the specified images: **All** (default), **Favorites**, **Pictures Only**, **Videos Only**.
- **Interval**—Sets the amount of time each image is shown: **2 secs**, **5 secs** (default), **10 secs**, **15 secs**, **60 secs**.
- **Loop**—Specifies how often the slideshow repeats: **Once** (default), **2x**, **3x**, **Continuous**.
- **Image Type**—Specifies the image type to include in the slideshow: **Pictures & Videos**, **Pictures Only**, **Videos Only**.

Stitching panoramas

When an image from a panoramic sequence is displayed and you select **Stitch Panorama**, the camera displays a stitched view of the panoramic sequence.



Note Stitching on-camera will result in a smaller image than if you stitched when transferring images to a computer. To stitch a panorama at the resolution at which you took the panoramic sequence, transfer the panoramic sequence of images to your computer (see [Transferring images with HP Photosmart Software on page 32](#)).







1. Scroll to one of the images in a panoramic sequence, then press $\frac{\text{Menu}}{\text{OK}}$.
2. While in the **Playback Menu**, use \blacktriangle \blacktriangledown to select **Stitch Panorama**, then press $\frac{\text{Menu}}{\text{OK}}$ to view a preview of the stitched image.
You can use \blacklozenge to magnify the stitched panorama preview, and \blacktriangle \blacktriangledown \blacktriangleleft \blacktriangleright to pan around the image and examine the stitching.
3. Press $\frac{\text{Menu}}{\text{OK}}$ to stitch and save the panoramic image; press \curvearrowright to cancel panorama stitching.

A new file is created when you stitch a panorama, and the individual images in the panoramic sequence are retained.

5 Using the Design Gallery Menu

You can use the **Design Gallery** features to enhance your captured images.

1. While in **Playback**, use **◀▶** to scroll to an image, then press $\frac{\text{Menu}}{\text{OK}}$.
2. Use **▲▼** to highlight **Design Gallery**, then press $\frac{\text{Menu}}{\text{OK}}$.
3. Use **▲▼** to highlight an option, then press $\frac{\text{Menu}}{\text{OK}}$ and follow the on-camera instructions.
4. Press **↶** repeatedly to return to **Playback**.

	Remove Red Eyes —See Removing red eyes on page 28 .
	Rotate —Rotates the displayed image. Use ◀▶ to rotate the image clockwise or counter-clockwise in 90-degree increments. Press $\frac{\text{Menu}}{\text{OK}}$ to save the image in the new orientation.
	Apply Artistic Effects —See Applying artistic effects on page 28 .
	Enhance Photos —See Enhancing photos on page 29 .
	Modify Color —See Modifying colors on page 30 .
	Add Borders —See Adding borders on page 30 .
	Crop —See Cropping images on page 31 .

Removing red eyes

When you select  **Remove Red Eyes**, the camera processes the current still image to remove red eyes from the subjects.

The red-eye removal process takes a few seconds, after which the image displays with green boxes around corrected areas, along with the **Remove Red Eyes** submenu:

- **Save Changes** (Default)—Overwrites the original image and returns to the **Design Gallery Menu**.
- **View Changes**—Displays a magnified view of the image with green boxes around the corrected areas.
- **Cancel**—Returns to the **Design Gallery Menu** without saving the red eye changes.

Remove Red Eyes is only available for pictures taken with a flash.

Applying artistic effects



Tip If you need to crop an image (see [Cropping images on page 31](#)), do so before applying artistic effects, adding borders, or enhancing photos. If you plan to apply artistic effects, modify colors, or enhance photos, do so before adding a border.

 **Apply Artistic Effects** allows you to create a copy of a selected image and apply creative effects to the copy. To apply artistic effects:

1. While in the **Design Gallery Menu**, use ▲▼ to select  **Apply Artistic Effects**, then press $\frac{\text{Menu}}{\text{OK}}$.
2. Use ▲▼ to select an option and preview the effect it has on the image.
 - **Ink Dots**—Uses dots to simulate the art technique of pointillism.
 - **Cartoon**—Simulates a highly-graphical comic book image.
 - **Watercolor**—Simulates a watercolor painting.
 - **Center Focus**—Creates a feathered blur radiating from a sharp center to a blurred edge.
 - **Posterize**—Creates a high-contrast, flat-toned effect.
 - **Retro**—Creates a two-color, high-contrast look from the 70s.
 - **Soft Glow**—Adds a diffuse, bright ethereal glow.
 - **Vintage**—Adds an aged, scratched look.
 - **Sky Color**—Enhances sky with a feathered color that fades from the top down.
 - **Ground Color**—Enhances landscapes with a feathered color that fades from the bottom up.
 - **Kaleidoscope**—Mirrors the image in four directions.
 - **Solarize**—Creates a partial reversal of tones and emphasizes outlines.
 - **Drawing**—Creates a pencil drawing using the edges in the image.
3. Press $\frac{\text{Menu}}{\text{OK}}$ to select the artistic effect and display the **Creative** sub-menu. Follow the on-camera instructions to adjust the artistic effect.
4. Press $\frac{\text{Menu}}{\text{OK}}$ to save a copy of the image with the artistic effect and return to the **Design Gallery Menu**. Press ⏪ to exit the **Creative** sub-menu without saving and return to the **Apply Artistic Effects** sub-menu.

Enhancing photos



Tip If you plan to apply artistic effects, modify colors, crop, or enhance photos, do so before adding a border.

 **Enhance Photos** allows you to correct common problems or improve the image.

1. While in the **Design Gallery Menu**, use ▲▼ to select  **Enhance Photos**, then press $\frac{\text{Menu}}{\text{OK}}$.
2. Use ▲▼ to select an enhancement.
 - **Slimming**—Compresses centered subjects for a slimmer look.
 - **Pet-Eye Fix**—Allows you to correct glowing-eye problems in images of animals.
 - A yellow selection box displays in the center of the image.
 - Use ▲▼◀▶ to position the selection box over the eye to be corrected.
 - Press $\frac{\text{Menu}}{\text{OK}}$ to correct the selected eye.
 - Repeat these steps, if necessary, to correct a second eye.
 - Once all corrections are made, press $\frac{\text{Menu}}{\text{OK}}$ again to save the changes, create a new file, and return to the **Design Gallery Menu**. Press ⏪ to exit the **Creative** sub-menu without saving and return to the **Enhance Photos** sub-menu.

- **Touch Up**—Allows you to touch up superficial blemishes in an image.
 - A yellow selection box displays in the center of the image.
 - Use ▲▼◀▶ to position the selection box over the blemish to be corrected.
 - Press $\frac{\text{Menu}}{\text{OK}}$ to correct the selected blemish.
 - Repeat these steps, if necessary, to correct additional blemishes.
 - Once all corrections are made, press $\frac{\text{Menu}}{\text{OK}}$ again to save the changes, create a new file, and return to the **Design Gallery Menu**. Press ↵ to exit the **Creative** sub-menu without saving and return to the **Enhance Photos** sub-menu
 - **Brightness/Contrast**—Allows you to adjust brightness, saturation, and contrast.
3. **Slimming** and **Brightness/Contrast**: Press $\frac{\text{Menu}}{\text{OK}}$ to select the enhancement and display the **Creative** sub-menu.
Follow the on-camera instructions to adjust the enhancement.
 4. **Slimming** and **Brightness/Contrast**: Press $\frac{\text{Menu}}{\text{OK}}$ to save a copy of the image with the specified enhancement and return to the **Design Gallery Menu**. Press ↵ to exit the **Creative** sub-menu without saving and return to the **Enhance Photos** sub-menu.

Modifying colors



Tip If you plan to apply artistic effects, modify colors, or enhance photos, do so before adding a border.

 **Modify Color** allows you to apply color schemes to the displayed image. To modify colors:





1. Use ▲▼ to select  **Modify Color**, then press $\frac{\text{Menu}}{\text{OK}}$.
2. Use ▲▼ to select a color scheme and preview the effect it has on the image.
 - **Black & White**—Converts color images to black and white.
 - **Sepia**—Converts image to a brownish tone to look old-fashioned.
 - **B&W Tints**—Applies color tones on a black and white version of an image.
 - **Color Tints**—Adds an extra color layer to create a mood or feeling.
3. Press $\frac{\text{Menu}}{\text{OK}}$ to select the color scheme and display the **Creative** sub-menu.
Follow the on-camera instructions to adjust the color.
4. Press $\frac{\text{Menu}}{\text{OK}}$ to save a copy of the image with the specified color scheme and return to the **Design Gallery Menu**. Press ↵ to exit the **Creative** sub-menu without saving and return to the **Modify Color** sub-menu.

Adding borders





Tip If you need to crop an image, do so before adding borders, applying artistic effects, or enhancing photos. If you plan to apply artistic effects, modify colors, or enhance photos, do so before adding a border.

 **Add Borders** allows you to add one or more predefined borders to the displayed image. To add a border:



1. Use  to select  **Add Borders**, then press $\frac{\text{Menu}}{\text{OK}}$.
2. Use  to select a border type and preview the effect it has on the image.
 - **Soft Edge**—Applies a soft, vignetted frame to the image.
 - **Inset Border**—Image extends beyond the inset frame.
 - **Torn Edge**—Creates random tears for an uneven border effect.
 - **Burned Edge**—Creates a border with darkened areas that appear burned.
 - **Spatter**—Creates an edge that appears to dissolve into the paper, like spray.
 - **Oval**—Adds an oval matte border with beveled edges.
 - **Circle**—Adds a circular matte border with beveled edges.
 - **Rectangle**—Adds a rectangular matte border with sharp corners.
 - **Rounded Rectangle**—Uses a rectangle with soft corners for the matte border.
 - **Square**—Adds a square matte border with beveled edges.
3. Press $\frac{\text{Menu}}{\text{OK}}$ to select the border and display the **Creative** sub-menu. Follow the on-camera instructions to adjust the border.
4. Press $\frac{\text{Menu}}{\text{OK}}$ to save a copy of the image with the specified border and return to the **Design Gallery Menu**. Press  to exit the **Creative** sub-menu without saving and return to the **Add Borders** sub-menu.

Cropping images

 **Crop** allows you to crop the displayed image to the selected orientation, then use the **Zoom** lever and   to ensure that the image content you want gets printed.



Tip Make sure you crop images as needed before adding borders, applying artistic effects, or enhancing photos.

1. Use  to select  **Crop**, then press $\frac{\text{Menu}}{\text{OK}}$.
2. Use  to select a crop orientation.
 - **Landscape** (Default)—Horizontally crops the displayed image to a 3:2 aspect ratio (one third wider than tall).
 - **Portrait**—Vertically crops the displayed image to a 2:3 aspect ratio (one-third taller than wide).
 - **Help**—Provides extended help information for the **Crop** function.
3. Press $\frac{\text{Menu}}{\text{OK}}$ to select the crop orientation and display the crop view. Follow the on-camera instructions to use the **Zoom** lever and adjust what appears in the cropped image.

When you print, the normal aspect ratios get cropped on the top and bottom (landscape) or on the sides (portrait). Cropping helps ensure that the content you want gets printed.
4. Press $\frac{\text{Menu}}{\text{OK}}$ to save a copy of the cropped image and return to the **Design Gallery Menu**. Press  to exit the **Creative** sub-menu without saving and return to the **Crop** sub-menu.

6 Transferring and printing images

You can transfer images and video clips with or without the HP Photosmart Software that came with your camera. However, the HP Photosmart Software has several features for transferring and managing your images and also guides you through the transfer process.

Transferring images with HP Photosmart Software

If you have installed the HP Photosmart Software (see [Install the software on page 9](#)), use this method to transfer images and video clips to your computer.

When you connect your camera to a computer with the HP Photosmart Software installed:

- If you have marked images for printing (see [Marking images for printing on page 36](#)) and the computer is connected to a printer, the marked images are automatically printed.
- If you have marked images for sharing (see [Sharing images on page 37](#)) and the computer is connected to the Internet, the selected images are automatically sent to their destinations.
- If you have marked images to buy as prints (see [Buying prints online on page 37](#)) and the computer is connected to the Internet, you can follow the instructions on the computer screen to buy prints of those images you selected.
- You can transfer the images on the camera to the computer by following the instructions on the computer screen. Panoramic sequences that you have not stitched on the camera (see [Using Panorama mode on page 17](#)) are automatically stitched as you transfer them.

 **Tip** You can also perform these tasks using an optional HP Photosmart dock (see the documentation that came with your dock).

1. If you have marked images for sharing, printing, or buying prints online (see [Using HP Photosmart Express on page 36](#)), verify that the computer is connected to a printer and/or the Internet.
2. Turn off the camera.
3. Connect the camera and computer using the USB cable that came with your camera.
4. Turn on the camera. When the Image Display indicates that the camera is connected to the computer, follow the instructions on the computer screen. For more information, see the Help feature in the HP Photosmart Software.



Note If the camera does not successfully connect to the computer, see [My camera stalls when establishing a connection to the computer. on page 45](#).

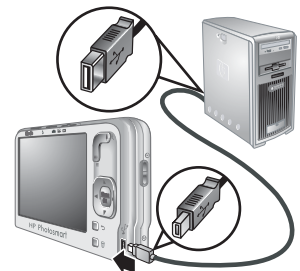

After you have transferred the images, you can then use the HP Photosmart Software to edit, print, or send the images from your computer.

Transferring images without HP Photosmart Software

If you do not install the HP Photosmart Software:

- You cannot use the **Share** features or **Buy Prints Online** on the camera's **Photosmart Express Menu** (see [Using HP Photosmart Express on page 36](#)).
- Panoramic sequences are not automatically stitched when you transfer the images to your computer.
- Images marked for printing do not automatically print when the camera is connected to the computer.
- Tags associated with images are not transferred to the computer. For information about tagging images, see [Tagging images on page 26](#).

However, you can still transfer images and video clips to your computer by:

- Connecting your camera directly to the computer (see [Connecting to the computer on page 33](#))
- Using a memory card reader (see [Using a memory card reader on page 33](#))

Connecting to the computer

1. Turn off the camera, connect the camera and computer using the USB cable that came with your camera, then turn on the camera. Your computer's provided image transfer software should start. Follow the on-screen instructions to transfer your images.
2. When you have finished transferring images, disconnect the camera from the computer.

If you encounter problems, set the camera's **USB Configuration** to **Disk Drive** (see **USB Configuration** under [Using the Camera Setup Menu on page 39](#)) and reconnect to your computer.

Using a memory card reader

You can put your camera's optional memory card into a (separately purchased) memory card reader. Some computers and HP Photosmart printers have built-in memory card slots which act as a memory card reader.

1. Insert your camera's memory card into the memory card reader (or into your computer's memory card slot).
2. Right-click **My Computer** on your desktop, then select **Explore**.
3. Expand the removable drive folder, expand the **DCIM** folder, then click on the folder for your camera.
4. Select and copy all the images to a folder on your computer.
5. After verifying that the images were successfully transferred, return the memory card to your camera.

Printing directly to a printer

You can print images directly from the camera to any PictBridge-certified printer. For information about printing images from your computer, see [Transferring images with HP Photosmart Software on page 32](#).



Note You cannot print video clips using the method described in this section. You can, however, print a frame from a video clip using the HP Photosmart Software. For more information, see Help in the HP Photosmart Software.

1. Check that the printer is turned on, there is paper in the printer, and there are no printer error messages.



Note If you are printing a stitched panorama (see [Using Panorama mode on page 17](#)), verify that your PictBridge-certified printer can print panoramas and that you have loaded panorama paper.

2. Turn off the camera, connect the camera to the printer using the USB cable that came with your camera, then turn on the camera.
3. If the **Print marked pictures?** screen is displayed on the camera's Image Display, do one of the following:

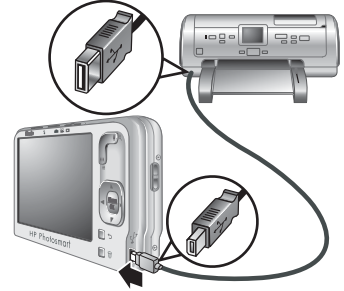

- If you want to print the pictures you marked for printing (see [Marking images for printing on page 36](#)), highlight **Yes**, press Menu/OK , then follow the on-camera instructions to select print options and print the marked pictures.



Note After the printer prints the marked images, the Image Display on the camera shows an image. You can then select individual images to print by following the remaining steps in this procedure.

- If you want to select individual images to print, highlight **No**, then press Menu/OK .
4. When the Image Display on the camera shows an image:
 - If you want to print one or more images, use $\blacktriangleleft\blacktriangleright$ to display an image you want to print, use $\blacktriangle\blacktriangledown$ to specify the number of copies, then press Menu/OK . In the **Print Options** sub-menu, highlight **Print This Image Now**, and press Menu/OK .
 - If you want to print a group of images or modify the printer settings, press Menu/OK , highlight **Print Menu...**, then press Menu/OK again. Highlight the option you want.
 - **Printer Settings**—Specifies paper size, print size and quality, and borderless printing. Use $\blacktriangle\blacktriangledown$ to select a print option and use $\blacktriangleleft\blacktriangleright$ to modify the selected print option. When you are done specifying print options, press Menu/OK .



Note If you are printing a stitched panorama (see [Stitching panoramas on page 27](#)), set **Print Size** to **Panorama** in the **Printer Settings** menu.

- **Print All**—Prints one copy of each image. Press Menu/OK and follow the on-camera instructions to begin printing.
 - **Print Index**—Prints all images as thumbnails. Press Menu/OK to begin printing.
 - **Print Favorites**—Prints all images tagged as **Favorites**. Press Menu/OK to begin printing. This option is available only if you have tagged at least one image as a **Favorite** (see [Tagging images on page 26](#)).
 - **Cancel Printing**—Stops the printing of any images that have not yet printed. Press Menu/OK , highlight **Yes**, then press Menu/OK .
5. After the printer has printed all the images you selected, disconnect the camera from the printer.



Note If you connect the camera to a non-HP printer and encounter problems with printing, contact your printer manufacturer. HP does not provide customer support for non-HP printers.

7 Using HP Photosmart Express

With **HP Photosmart Express**, you can select pictures in your camera to print automatically (see [Marking images for printing on page 36](#)), to buy prints online (see [Buying prints online on page 37](#)), or to send to custom destinations (see [Sharing images on page 37](#)) the next time you connect the camera to your computer or printer.

You must have the HP Photosmart Software installed on your computer to use some features in the **Photosmart Express Menu**. For information about this software, see [About the HP Photosmart Software on page 9](#).



Note Available online services vary by country or region.

Using the Photosmart Express Menu

To display the **Photosmart Express Menu**:

1. Slide to and press Menu OK.
2. Use to highlight **Photosmart Express...**, then press Menu OK.
3. Use to highlight a menu option, then press Menu OK.

	Print —Allows you to select images and specify number of copies to print. See Marking images for printing on page 36 .
	Share —Allows you to add custom online destinations and share images to one or more destinations. See Sharing images on page 37 .
	Buy Prints Online —Specifies images you want printed by an online printing service. See Buying prints online on page 37 .



Note The features in the **Photosmart Express Menu** are available only for pictures. They are not available for video clips.

Marking images for printing

Marked images are automatically printed when you connect the camera to a PictBridge-certified printer or a computer with the HP Photosmart Software installed. You can mark individual images, all images, or tagged images (see [Tagging images on page 26](#)).

1. While in the **Photosmart Express Menu**, use to highlight **Print**, then press Menu OK.
2. In the **Print** menu, highlight an option, then press Menu OK.
 - **This Image**—Marks the image currently displayed. You can scroll to a different image using .
 - **All Tagged...**—Displays the **Print All Tagged** sub-menu. Highlight a tag, then press Menu OK. To specify the number of copies to print,

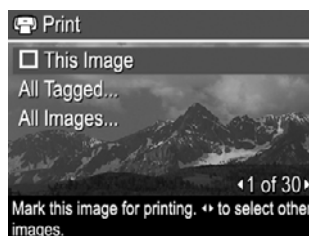

use ▲▼, then press $\frac{\text{Menu}}{\text{OK}}$. This option is available only if you have tagged at least one image (see *Tagging images on page 26*).

- **All Images...**—Displays the **Print All Images** sub-menu. Press $\frac{\text{Menu}}{\text{OK}}$. This option is available only if you have more than one image in the camera.
3. If you selected **This Image** or **All Images...** and want to print more than one copy, highlight **Change Number of Copies**, then press $\frac{\text{Menu}}{\text{OK}}$. In the **Print** sub-menu for changing the number of copies, use ▲▼ to specify the number of copies to print, then press $\frac{\text{Menu}}{\text{OK}}$.
 4. From the main **Print** menu, you can mark additional images for printing, using ◀▶ to display an image, then repeating Steps 2 and 3.
 5. When you are done marking images for printing, press ↻ repeatedly until you return to **Playback**.
 6. To print the marked images directly to a printer, see *Printing directly to a printer on page 33*. To print them from a computer connected to a printer, see *Transferring images with HP Photosmart Software on page 32*.

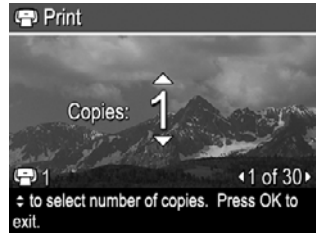

Buying prints online

For professional photo finishing at Wal*Mart, follow these steps.

1. While in the **Photosmart Express Menu**, use ▲▼ to highlight **Buy Prints Online**, then press $\frac{\text{Menu}}{\text{OK}}$.
2. In the **Buy Prints Online** sub-menu, highlight an option, then press $\frac{\text{Menu}}{\text{OK}}$.
 - **This Image**—Marks the image currently displayed. You can scroll to a different image using ◀▶.
 - **All Tagged...**—Displays the **Buy Prints of All Tagged** sub-menu. Highlight a tag, then press $\frac{\text{Menu}}{\text{OK}}$ for each tag you want. When you are done selecting tags, press ↻. This option is available only if you have tagged at least one image (see *Tagging images on page 26*).
 - **All Images...**—Displays the **Buy Prints of All Images** sub-menu. Press $\frac{\text{Menu}}{\text{OK}}$, then press ↻. This option is available only if you have more than one image in the camera.
3. To mark additional images, use ◀▶ to display an image, then repeat Step 2.
4. When you are done marking images for which you want to buy prints, press ↻ repeatedly until you return to **Playback**.
5. To buy prints of the images you selected, see *Transferring images with HP Photosmart Software on page 32*.



If you encounter problems, e-mail help@walmart.com or go to the website: <https://www.walmart.com/photo>.

Sharing images

You can customize the **Share** sub-menu to include e-mail addresses, group distribution lists, online albums, or other online services. You can then select images to send to these destinations.

Setting up online destinations in the camera

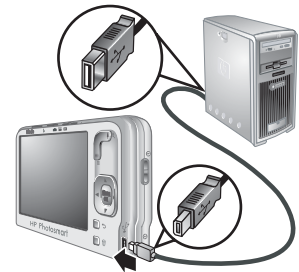

You can specify up to 34 custom destinations (such as individual e-mail addresses or group distribution lists) in the **Photosmart Express Menu**.

1. Verify that your computer is connected to the Internet.
2. While in the **Photosmart Express Menu**, use $\blacktriangle/\blacktriangledown$ to highlight  **Share**, then press $\frac{\text{Menu}}{\text{OK}}$. If you have already created destinations, highlight **Share Menu Setup** and press $\frac{\text{Menu}}{\text{OK}}$ again.
3. Connect the camera to your computer. Follow the on-screen instructions to set up destinations in your camera.
4. Turn off the camera and disconnect the camera from the computer. Turn on the camera, access the **Photosmart Express Menu**, then highlight  **Share** and press $\frac{\text{Menu}}{\text{OK}}$ to verify that the new destinations are now in the camera.



Sending images to online destinations





After you have set up online destinations in the camera, you can mark images to be sent to these custom destinations the next time you connect your camera to your computer.

1. While in the **Photosmart Express Menu**, use $\blacktriangle/\blacktriangledown$ to highlight  **Share**, then press $\frac{\text{Menu}}{\text{OK}}$.
2. In the **Share** sub-menu, highlight an option, then press $\frac{\text{Menu}}{\text{OK}}$.
 - **Custom Destinations**—Selects the destination to send the image displayed in the background. There may be multiple destinations depending on the number of them you created (see [Setting up online destinations in the camera on page 38](#)). You can scroll to a different image using $\blacktriangle/\blacktriangledown$.
 - **All Tagged...**—Displays the **Share All Tagged** sub-menu. Highlight the tag you want, press $\frac{\text{Menu}}{\text{OK}}$ in the sub-menu, then highlight each destination to which you want to send the pictures with the tag you selected, pressing $\frac{\text{Menu}}{\text{OK}}$ to select each destination. After selecting destinations, press \blackrightarrow . This option is available only if you have tagged at least one image (see [Tagging images on page 26](#)).
 - **All Images...**—Displays the **Share All Images** sub-menu. Highlight each destination to which you want to send all images, pressing $\frac{\text{Menu}}{\text{OK}}$ to select each destination. After selecting destinations, press \blackrightarrow . This option is available only if you have more than one image in the camera.
3. To mark additional images to share, use $\blacktriangle/\blacktriangledown$ to display an image, then repeat Step 2.
4. When you are done marking images to share, press \blackrightarrow repeatedly until you return to  **Playback**.
5. To send the images to the destinations, see [Transferring images with HP Photosmart Software on page 32](#).









8 Using the Camera Setup Menu



The **Camera Setup Menu** allows you to set preferences for the camera's behavior. The **Camera Setup Menu** is available from the **Picture Capture**, **Video Record**, and **Playback** menus.

1. While in the **Picture Capture**, **Video Record**, or **Playback** menu, use ▲▼ to highlight  **Camera Setup...**, then press $\frac{\text{Menu}}{\text{OK}}$.
2. Use ▲▼ to highlight a menu option, then press $\frac{\text{Menu}}{\text{OK}}$ to display the menu option's sub-menu.
3. Use ▲▼ to highlight a setting, then press $\frac{\text{Menu}}{\text{OK}}$.
4. To exit the **Camera Setup Menu**, press  repeatedly until you return to  **Picture Capture**,  **Video Record**, or  **Playback**.

Settings you specify remain until you change them.

	Display Brightness —Adjusts the brightness of the Image Display. <ul style="list-style-type: none">● Low—For extending battery life.● Medium (Default)—For normal viewing conditions.● High—For very bright lighting conditions.
	Camera Sounds —Adjusts the speaker volume for camera sounds (such as button presses and shutter clicks) and audio recorded with video clips. Off, Low (Default), High .
	Display Timeout —Specifies the time after which the Image Display turns off if you do not press a button. Never, 15, 30, 45 (Default), 60 seconds .
	Digital Zoom —Enables or disables digital zoom. On (Default), Off .
	Date & Time —Sets the date and time. See Set the date and time on page 8 .
	USB Configuration —Specifies how a computer recognizes the camera. See Connecting to the computer on page 33 . <ul style="list-style-type: none">● Digital Camera (Default)—Recognizes the camera as a digital camera using PTP (Picture Transfer Protocol).● Disk Drive—Recognizes the camera as a disk drive using MSDC (Mass Storage Device Class).

(continued)

	<p>TV Configuration—Sets the video signal format for displaying camera images on a TV.</p> <ul style="list-style-type: none">● NTSC—Used primarily in North America, parts of South America, Japan, Korea, and Taiwan.● PAL—Used primarily in Europe, Uruguay, Paraguay, Argentina, and parts of Asia.
	<p> (Language)—Sets the language. See Choose the language on page 8.</p>

9 Troubleshooting

Use this section to find information on:

- Resetting the camera (see [Resetting the camera on page 41](#)).
- Possible problems and solutions (see [Problems and solutions on page 41](#)).

Resetting the camera

If your camera does not respond when you press buttons, reset the camera.

1. Turn off the camera.
2. Remove the memory card and battery.
3. Press the straightened end of a paper clip into the **Reset** switch (the small hole located inside the tripod mount, as shown), hold the switch down for 3-6 seconds, then release.
4. Reinstall the battery and close the Battery/Memory Card door.
5. Turn on the camera. On successful reset, the camera prompts you to set the date and time (see [Set the date and time on page 8](#)).
6. Verify that the camera works without an optional memory card, then reinstall the card.

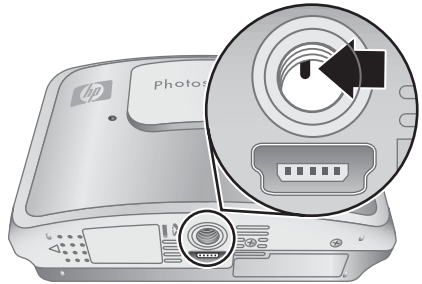

When the camera is reset, any images or video clips stored in memory are retained.

Problems and solutions

Use this information to find solutions to common issues you may have using your camera.

How can I get professional-quality prints if I don't have a photo printer?

Use the **Buy Prints Online** feature on the **Photosmart Express Menu** (see [Buying prints online on page 37](#)).

The camera does not turn on.

- Install a new or recharged battery, ensuring that the battery is inserted correctly (see [Install the battery on page 7](#)) and that you are using a rechargeable HP Photosmart R07 Lithium Ion battery for HP Photosmart R-series cameras (L1812A/L1812B).
- Ensure that a battery is installed in the camera, that the power adapter is connected to the camera and is plugged into a working electrical outlet, and that power adapter is not damaged or defective.
- Reset the camera (see [Resetting the camera on page 41](#)).
- Ensure that the memory card is the proper type (see [Storage on page 53](#)). If so, remove the memory card and turn on the camera; if the camera turns on, format the memory card (see [Install and format an optional memory card on page 9](#)). If the camera still does not turn on, format the memory card using a memory card reader, or replace the memory card.

The battery gauge goes up and down frequently.

See [Power indicators on page 49](#).

I have to recharge the Lithium Ion battery frequently.

- See [Extending battery life on page 48](#).
- A battery that is new or has not been charged recently must be recharged to reach full capacity.
- If you have not used the battery for two months or longer, recharge it.

The Lithium Ion battery will not charge.

- Try charging it again after it has drained awhile.
- Use only the power adapter that came with your camera.
- If charging the battery in the HP quick recharger or the spare battery charging bay of an optional HP Photosmart dock does not work, replace the battery.

It takes the camera a long time to turn on.

Having a large number of files (over 300) stored on an optional memory card affects the time it takes for the camera to turn on. Transfer stored files to your computer, then format the memory card.

The camera does not respond when I press a button.

- Turn on the camera.
- Most of the camera buttons do not respond when the camera is connected to a computer.
- Replace or recharge the battery.
- Reset the camera (see [Resetting the camera on page 41](#)).
- The memory card may be defective. Remove the memory card and test the camera; if the camera works, replace the memory card.
- Format the internal memory and/or the memory card (see [Install and format an optional memory card on page 9](#)).





The camera does not take a picture when I press the Shutter button.

- Press the **Shutter** button all the way down.
- The memory card or internal memory may be full. Transfer images from the camera to your computer, then format the internal memory or the memory card (see [Install and format an optional memory card on page 9](#)). Or replace the card with a new one.
- The camera may be processing. Wait a few seconds for the camera to finish processing the last image before taking another picture.



The Image Display is not working.

- The Image Display may have timed out. Press any camera button to wake up the camera.
- Reset the camera (see [Resetting the camera on page 41](#)).
- Replace or recharge the battery.





My image is blurry.

- Use **Focus Lock** (see *Using Focus Lock* on page 13).
- Use  **Steady Photo** shooting mode (see **Steady Photo** under *Using the shooting modes* on page 16).
- Use a tripod to hold the camera steady, or improve lighting conditions.
- Set the flash to  **Auto Flash** or  **Flash On** and set the shooting mode to 

My image is too bright.

- Turn the flash off (see *Setting the flash* on page 16).
- Move back from the subject and use zoom.
- Adjust  **Exposure Compensation** (see **Exposure Compensation** under *Using the Picture Capture and Video Record menus* on page 18).
- Use  **Exposure Bracketing** (see **Exposure Bracketing** under *Using the Picture Capture and Video Record menus* on page 18).

My image is too dark.

- Wait for natural lighting conditions to improve, use the flash (see *Setting the flash* on page 16) or add indirect lighting.
- Adjust  **Exposure Compensation** (see **Exposure Compensation** under *Using the Picture Capture and Video Record menus* on page 18).
- Use  **Exposure Bracketing** (see **Exposure Bracketing** under *Using the Picture Capture and Video Record menus* on page 18).
- Use  **Adaptive Lighting** (see **Adaptive Lighting** under *Using the Picture Capture and Video Record menus* on page 18).
- Use the **Spot** setting for  **AE Metering** (see **AE Metering** under *Using the Picture Capture and Video Record menus* on page 18).
- If the subject you are trying to capture is outside the flash range (see **Flash working distance** under *Specifications* on page 52), turn off the flash. This causes a longer exposure time, so use a tripod or hold the camera steady.

My image is grainy.

- Add indirect lighting, use the flash (see *Setting the flash* on page 16), or wait for natural lighting conditions to improve.
- Use a lower **ISO Speed** setting (see **ISO Speed** under *Using the Picture Capture and Video Record menus* on page 18).
- Using  **Steady Photo** shooting mode can increase graininess.
- You may have zoomed in too far using digital zoom (see *Digital zoom* on page 14).
- If the camera is warm, the effect will diminish as the camera cools. For best image quality, avoid storing the camera in very hot locations.



Images are missing on my camera.

Remove the memory card and see if the images are stored in internal memory. If so, transfer the images to the memory card (see **Move Images to Card** under *Using the Playback Menu* on page 26).

I have two memory cards that are the same size, but one stores many more pictures than the other.

- Your memory card may contain files that are not images or videos recognized by the camera. Save any data on the memory card that you want to keep, then format the memory card (see [Install and format an optional memory card on page 9](#)).
- If your memory cards are 4GB or larger, the card that stores fewer images may have been improperly formatted by a device that does not support 4GB or larger cards. A new type of High Capacity Secure Digital (marked SDHC) memory card is now available that prevents improper formatting and use by devices not supporting 4GB or larger cards. Try formatting the card in this camera, which supports High Capacity Secure Digital cards.
- Your memory card may be defective. If you have formatted your memory card in the camera and it does not show the expected capacity, consider replacing the memory card.

The Power light is on but the Image Display is off, or the camera seems stuck and won't operate.

- Slide   to a different position or press any camera button to reactivate the Image Display.
- Reset the camera (see [Resetting the camera on page 41](#)).

The camera responds sluggishly when trying to review images.

See [Storage on page 53](#) and [Memory capacity on page 53](#) for tips about memory cards.

Video recording terminates abruptly. The video is saved successfully, but it is shorter than expected.

- Choose a lower resolution/compression combination for the video. If you used **Best**, consider using **★★ Better** or **★ Good**; if you used **★★ Better**, consider using **★ Good** (see **Video Quality** under [Using the Picture Capture and Video Record menus on page 18](#)).
- Replace your memory card with a faster card. Look for cards marked High Performance, Pro, Ultra, or High Speed.

Video recording terminates abruptly and the video will not play back.

- Remove the memory card and see if the video is stored in internal memory. If so, transfer the video to a memory card (see **Move Images to Card** under [Using the Playback Menu on page 26](#)) or to your computer (see [Transferring and printing images on page 32](#)).
- If the video is stored on a memory card, transfer the video to your computer (see [Transferring and printing images on page 32](#)), then reformat the card (see [Install and format an optional memory card on page 9](#)).

The camera gets warm (or even hot) to the touch.

This is normal. However, if anything seems out of the ordinary, turn off the camera and remove it from AC power, and allow the camera to cool. Then examine the camera and the battery for signs of possible damage.

For best image quality, turn off the camera when not using. Always store the camera in a cool place.

My camera stalls when establishing a connection to the computer.

- Ensure that the USB cable is properly connected to the camera and computer.
- Try connecting the USB cable to another USB port on the computer.
- Turn the camera off, then on again. If that does not fix the problem, reset the camera (see [Resetting the camera on page 41](#)).
- If the problem persists, contact Hewlett-Packard Technical Support (see [Product support on page 46](#)).

I cannot transfer images from the camera to my computer.

- Either install the HP Photosmart Software (see [Install the software on page 9](#)), or see [Transferring images without HP Photosmart Software on page 33](#).
- Set your camera to act as a **Disk Drive** (see **USB Configuration** in [Using the Camera Setup Menu on page 39](#)), then follow the steps in [Connecting to the computer on page 33](#).

I get an error message when transferring images to my computer.

A power surge or electrostatic discharge may have affected the camera. Close the HP Photosmart Software, disconnect the camera from the computer or printer if necessary, and reset the camera (see [Resetting the camera on page 41](#)). Then restart the image transfer process (see [Transferring images with HP Photosmart Software on page 32](#)).

My camera shuts down unexpectedly.

- A power surge or electrostatic discharge may have affected the camera. Remove the battery and reset the camera (see [Resetting the camera on page 41](#)). Then reinstall the battery and turn on the camera.
- Recharge the battery.
- Connect the camera to AC power via the power adapter (see [Charge the battery on page 7](#)), then turn on the camera.
- Replace the battery.

I am having a problem installing or using the HP Photosmart Software.

- Make sure your computer meets the minimum system requirements as stated on the camera packaging.
- Refer to the HP Photosmart Software online help system.
- Refer to the Hewlett-Packard Technical Support website: www.hp.com/support.

Camera error messages

Should you receive one of the following error messages when using your camera, you can look up details about the message by visiting www.hp.com and searching on the specific code.

- **Lens Error (general)**—R837-021
- **Unsupported card**—R837-200
- **Unable to format card**—R837-202
- **Error saving image**—R837-100
- **Error saving video**—R837-102
- **Batteries cannot be charged**—R837-435

10 Product support

Use this section to find support information for your digital camera, including links to helpful websites and an overview of the support process.

Helpful websites

To optimize your digital photography experience, periodically check the websites listed below for updates to your camera's software, drivers, and firmware.

Camera tips, product registration, newsletter subscriptions, driver and software updates, purchase HP supplies and accessories	www.hp.com Under Learn about: , click Digital Photography
Customers with disabilities	www.hp.com/hpinfo/community/accessibility (English only)
Hewlett-Packard Technical Support; driver, software, and firmware updates; support information	www.hp.com/support

Getting assistance

To get the best from your HP product, consult the following standard HP support offerings:

1. Consult the product documentation.
 - Review *Troubleshooting on page 41* in this document.
 - Review the electronic Help section within the software.
 - Refer to the camera's Help screens.
2. Visit the Hewlett-Packard Technical Support website at www.hp.com/support, or contact the store where you purchased this camera. The Hewlett-Packard Technical Support website is available to all HP customers. The Hewlett-Packard Technical Support website is the fastest source of up-to-date product information and expert assistance, including:
 - Fast e-mail access to qualified online support specialists.
 - Software and driver updates for your camera.
 - Valuable product and troubleshooting information for technical issues.
 - Proactive product updates, support alerts, and HP newsletters (available when you register your camera).
3. HP support by phone. Support options and fees vary by product, country/region, and language. For a list of support conditions and phone numbers, visit www.hp.com/support.
4. Post-warranty period. After the limited warranty period, help is available online at www.hp.com/support.

5. Extending or upgrading your warranty. If you would like to extend or upgrade your camera's warranty, please contact the store where you bought the camera or check the HP Care Pack offers at www.hp.com/support.
6. If you already purchased an HP Care Pack Service, please check the support conditions on your contract.

A Managing batteries

Your camera uses a rechargeable HP Photosmart R07 Lithium Ion battery (L1812A/L1812B).

Top points about batteries



Always insert the battery in the camera correctly (see [Install the battery on page 7](#)). If the battery is inserted improperly, the compartment door may close but the camera will not operate.

- New rechargeable Lithium Ion batteries are shipped partially charged. Fully charge them before first use.
- If you do not intend to use your camera for more than two months, leave the camera connected to AC power using the power adapter that came with your camera. The camera will top off the battery periodically to ensure that the camera is always ready for use.
- A rechargeable Lithium Ion battery can be left in the camera or optional dock or quick recharger for any period of time without harm.
- If a rechargeable Lithium Ion battery has not been used for more than two months, recharge it before using it again. Fully recharge Lithium Ion batteries every six months to a year to prolong their useful life.
- The performance of Lithium Ion batteries degrades over time, especially if stored and used at high temperatures. If battery life is unacceptably short, replace the battery.
- The performance of Lithium Ion batteries will decrease as the temperature drops. To improve battery performance, store the camera and batteries in a warm inside pocket when in a cold environment. To prevent short-circuiting the batteries, never carry small metal items such as keys or coins in the same pocket with your batteries.

Extending battery life

To conserve battery power, the Image Display turns off after 45 seconds by default. Pressing any button wakes up the camera. After five minutes of inactivity, the camera turns off.

To further extend battery life:

- Set **Display Brightness** to **Low** (see **Display Brightness** under [Using the Camera Setup Menu on page 39](#)).
- Change the **Display Timeout** value to a shorter interval (see **Display Timeout** under [Using the Camera Setup Menu on page 39](#)).
- Set your camera to **Auto Flash** (see **Auto Flash** under [Setting the flash on page 16](#)).
- Use optical zoom sparingly.
- If you are turning on the camera only to view images, slide   to , then turn on the camera to start in **Playback** without zooming the lens.
- When printing directly to a PictBridge-certified printer, place your camera in an optional HP Photosmart dock connected to AC power.

Safety precautions for using batteries

- Do not place the battery in fire or heat the battery. Always store charged batteries in a cool location.
- Do not connect the positive and negative terminals of the battery to each other with any metal object.
- Do not carry or store the battery with metal objects. Do not drop the battery into a change-filled pocket.
- Do not pierce the battery or subject it to strong impacts or shocks.
- Do not solder directly onto the battery.
- Do not allow the battery to get wet.
- Do not disassemble or modify the battery.

- Immediately discontinue use of the battery if, while using, charging, or storing the battery, the battery emits an unusual smell, feels excessively hot (note that it is normal for the battery to feel warm), changes color or shape, or appears abnormal in any other way.
- In the event the battery leaks and the fluid gets into one's eye, do not rub the eye. Rinse well with water and immediately seek medical care. If left untreated, the battery fluid could cause damage to the eye.



Caution Risk of explosion if battery is replaced by an incorrect type. Dispose of used batteries according to the instructions.

Power indicators

The power indicators are most accurate after a few minutes of use. The following table explains the meaning of these indicators.

Icon	Description
	Battery has more than 70 percent energy remaining.
	Battery has 30 to 70 percent energy remaining.
	Battery has 10 to 30 percent energy remaining.
	Battery level is low. You cannot take pictures or record video clips but you can still review images in ▶ Playback and use the Playback Menu .
Blinking	Battery is depleted. Camera will power down.
	Camera is operating on AC power.
Animated battery filling up	Camera is operating on AC power and is charging the battery.
	Camera has successfully completed battery charging and is operating on AC power.



Note If the camera is without a battery for a prolonged period, the clock may be reset and you may be prompted to update it the next time you power on the camera.

Number of shots per battery charge

A fully charged HP Photosmart R07 Lithium Ion battery should take approximately 240 pictures. However many factors affect the actual number of pictures you will be able to take. Minimizing battery drain (see [Extending battery life on page 48](#)) may yield as many as 340 pictures. Heavy battery drain may yield approximately 140 pictures. For information about other factors that affect battery life, see [Top points about batteries on page 48](#).





Note For more information about batteries, go to www.hp.com/support, enter **R837** in the **Search** field, then click the button next to the field. Select your camera model, click **Support & Troubleshooting**, click **Solve a problem**, then click **Batteries & power** for a list of battery topics.

Recharging the Lithium Ion battery

You can recharge the HP Photosmart R07 Lithium Ion battery using the methods listed below.

The following table shows the average recharge time for a fully discharged battery, based on recharge location.

Charge location	Average charge time	Signals
In camera connected to AC power via the power adapter	2–3 hours	Charging: Camera's battery charging light blinks and the animated battery icon is displayed. Charging complete: Camera's battery charging light turns on solid and the battery gauge changes to  on the Image Display.
In camera connected to a computer or printer via the USB cable	4–6 hours	Charging: For most computers and printers, camera's battery charging light blinks and the animated battery icon is displayed, but see the note at the end of this table. Charging complete: Camera's battery charging light turns on solid and the battery gauge changes to  on the Image Display.
In camera connected to AC power via an HP Photosmart dock	2–5 hours	Charging: Dock's camera battery charging light blinks. Charging complete: Dock's camera battery charging light turns on solid.
In battery bay of an HP Photosmart dock	2–3.5 hours	Charging: Dock's battery bay light blinks. Charging complete: Dock's battery bay light turns on solid.
In an HP Photosmart R-Series quick recharger	1 hour	Charging: Quick recharger light is yellow. Charging complete: Quick recharger light is green.



Note Some printers and computers provide lower power via the USB connection. If you are charging using the USB cable connected to one of these printers or computers, the camera's battery charging light may not blink while the battery is charging, but will turn on solid when charging is complete.

Safety precautions for recharging batteries

You can recharge a Lithium Ion battery in the camera or purchase an optional dock with battery bay or a quick recharger. These devices may be warm while charging a Lithium Ion battery. This is normal. However, you should follow the safety precautions below.

- Do not charge any other battery than the HP Photosmart R07 Lithium Ion battery in the camera, dock, or quick recharger.
- Insert the Lithium Ion battery in the correct orientation.
- Use the camera, dock, or quick recharger in a dry location only.
- Do not charge a Lithium Ion battery in a hot location, such as in direct sunlight or near a fire.
- When recharging a Lithium Ion battery, do not cover the camera, dock, or quick recharger.
- Do not operate the camera, dock, or quick recharger if the Lithium Ion battery appears damaged.
- Do not disassemble the camera, dock, or quick recharger.

- Unplug the power adapter or quick recharger from the electrical outlet before cleaning the power adapter or quick recharger.
- After extensive use, the Lithium Ion battery may begin to swell. If it becomes difficult to insert the battery into or remove the battery from the camera, dock, or quick recharger, discontinue use of the battery and replace it with a new one. Please recycle the old battery.

B Specifications

Resolution	<p>Pictures:</p> <ul style="list-style-type: none"> • 7.24MP (3112 by 2328) effective pixel count • 7.4MP (3164 by 2342) total pixel count <p>Video clips:</p> <ul style="list-style-type: none"> • VGA <ul style="list-style-type: none"> – 640 by 480 total pixel count – Best—24 frames/sec – ★★ Better—12 frames/sec • QVGA <ul style="list-style-type: none"> – 320 by 240 total pixel count – ★ Good—24 frames/sec
Sensor	Diagonal 7.208 mm (1/2.5 in, 4:3 format) CCD
Color depth	36 bit (12 bits by 3 colors). 36 bit images are transformed into an optimized 24 bit image and stored in the JPEG format. This transformation results in no discernible change to color or detail in the stored image, and allows the image to be read by computers.
Lens	<p>Focal length:</p> <ul style="list-style-type: none"> • Wide—6.5 mm • Telephoto—19.5 mm • 35 mm equivalent—39 mm to 1.18 m <p>F-number:</p> <ul style="list-style-type: none"> • Wide—f/3.5 to f/7.4 • Telephoto—f/4.2 to f/8.8
Viewfinder	None
Zoom	<ul style="list-style-type: none"> • 3x optical zoom with 10 positions between wide and telephoto • 8x digital zoom
Focus	<p>Focus settings: Auto (Default), Close-up</p> <p>Auto (Default):</p> <ul style="list-style-type: none"> • Wide—500 mm (19.7 in) to infinity • Telephoto—600 mm (23.62 in) to infinity <p>Close-up—Wide, 100 mm to 1 m (3.94 in to 39.4 in)</p>
Shutter speed	1/2000 to 10 seconds
Built-in flash	Yes, 6-second typical recharge time (9-second maximum recharge time at power-on)
Flash working range	<ul style="list-style-type: none"> • Zoom Position Wide—Maximum with ISO Speed set to Auto: 4.1 m (13.5 ft) at f/3.5 • Zoom Position Telephoto—Maximum with ISO Speed set to Auto: 3.3 m (10.8 ft) at f/4.2

(continued)

Image Display	7.57 cm (2.98 in) color LTPS TFT LCD with backlight; 230,400 pixels (960 by 240) total pixel count
Storage	<ul style="list-style-type: none">• 32MB internal flash memory, not all of which is available for storing images and video clips (see <i>Memory capacity on page 53</i>).• Slot for memory card.• This camera supports standard, high speed, and high capacity Secure Digital (SD) memory cards, 32MB to 4GB.• The number of images or video clips that can be saved in memory depends on the Image Quality and Video Quality settings (see <i>Memory capacity on page 53</i>).
Compression format	<ul style="list-style-type: none">• JPEG (EXIF) for pictures• Motion JPEG for video clips
Interfaces	Dock connector (HP 1253–7135) and USB cable connector (USB 2.0 Full Speed/USB mini-B) connected to either: <ul style="list-style-type: none">• Power adapter (via USB connector on the side of the camera)• Optional HP Photosmart dock (via dock connector on the bottom of the camera)
Standards	<ul style="list-style-type: none">• PTP• USB—MSDC and SIDC• JPEG• Motion JPEG• DPOF• EXIF• DCF• DPS
External body dimensions	Measurements with camera off and lens cover closed (width, depth, height): 98 mm (3.86 in) by 26.5 mm (1.04 in) by 63.15 mm 2.49 in)
Weight	146 grams (5.15 ounces) without battery
Power	Typical power usage: 1800 mW (with Image Display on). Power sources include: <ul style="list-style-type: none">• One rechargeable HP Photosmart R07 Lithium Ion battery for HP Photosmart R-series cameras• Power adapter included with camera (5 Vdc, 1A, 5 W)• HP AC power adapter included with an optional HP Photosmart dock (5 Vdc, 2A, 10 W)
Temperature range	Operational: 0° to 50° C (32° to 122° F) at 15% to 85% relative humidity Storage: –30° to 65° C (–22° to 149° F) at 15% to 90% relative humidity

Memory capacity

Not all 32MB of internal memory is available for storing images, because some memory is used for internal camera operations. The actual file sizes and number of still images that can be stored in internal memory or on a memory card will vary depending on the content of each still image and the length of any associated audio clip.

Image quality

The following table lists the approximate number and average size of pictures that can be stored in internal memory when the camera is set to different **Image Quality** settings (see **Image Quality** under *Using the Picture Capture and Video Record menus* on page 18).

7MP Best	4 images (3.5MB each)
Normal (7MP) (Default)	5 images (2.5MB each)
5MP	8 images (1.8MB each)
2MP	20 images (800KB each)
VGA	93 images (200KB each)

Video quality

The following table lists the approximate number of seconds of video clips that can be stored in internal memory when the camera is set to different **Video Quality** settings (see **Video Quality** under *Using the Picture Capture and Video Record menus* on page 18).

Best (Default)—24 frames/sec	15 seconds
★★ Better —12 frames/sec	50 seconds
★ Good —24 frames/sec	90 seconds

Index

A

- Action mode 17
- Adaptive Lighting 19, 22
- adding borders 30
- AE Metering 20
- apply artistic effects 28
- arrow buttons 5
- artistic effects 28
- assistance 46
- Auto mode 17

B

- Back button 6
- battery
 - charge 7
 - conserving 48
 - door 6
 - install 7
 - shots per 49
 - top points about use 48
- Beach mode 17
- blinking lights on camera 5
- borders 30
- Burst setting 19, 21

C

- camera
 - dimensions 53
 - parts 5, 6
 - reset 41
 - specifications 52
 - turn on/off 7
 - weight 53
- Camera Setup Menu 39
- Camera Sounds 39
- Close-up mode 17
- color depth 52
- colors 30
- compression format 53
- computer, connect to 32, 33
- correcting images 29

D

- Date & Time 8, 39
- Date & Time Imprint 20
- deleting images 5, 25
- Design Gallery 28

- digital zoom 14, 39
- dimensions 53
- direct print 33
- Display Brightness 39
- Display Timeout 39

E

- e-mail images 37, 38
- enhancing photos 29
- exposure 13
- Exposure Bracketing 20
- Exposure Compensation 20, 22

F

- F-number 52
- flash
 - settings 16
 - working range 52
- Flash button 5
- focal length 52
- focus
 - auto focus 12
 - brackets 12
 - focus lock 13
 - optimizing 13
 - settings 52
- folded lens 6
- format memory card 9

G

- getting assistance 46

H

- HP Photosmart Express 36
- HP Photosmart Software 9, 10

I

- Image Display 6
- Image Quality 19, 54
- images
 - correcting 29
 - Date & Time Imprint 20
 - deleting 25
 - Image Quality 19, 54
 - magnifying 25

- number remaining 11
- Panorama mode 17
- per battery 49
- sending 38
- shooting modes 16
- tagging 26
- transfer to computer 32
- install memory card 9
- install software 9
- Instant Review 12, 18, 22
- interfaces 53
- internal memory 11, 53
- ISO Speed 20, 22

L

- Landscape mode 17
- Language 8, 40
- LEDs 5
- lens 6
- lights on camera 5
- Lithium Ion battery 48, 50

M

- Magnify control 5
- magnifying images 25
- memory
 - capacity 53
 - card 11
 - card door 6
 - memory card 9, 53
- Menu/OK button 5
- menus
 - Camera Setup 39
 - Design Gallery 28
 - Photosmart Express 36
 - Picture Capture 18
 - Playback 26
 - Video Record 18
- microphone 6
- modifying colors 30
- Move Images to Card 26

N

- Night Portrait mode 17
- number of
 - pictures 54

- pictures remaining 11
- O**
- on/off 7
- online
 - destinations 37, 38
 - print buying 37
- optical zoom 14
- P**
- Panorama mode 17, 27
- parts of camera 5, 6
- Photosmart Express Menu
 - buying prints online 37
 - marking images for printing 36
 - sharing images 37
- Picture Capture Menu 18
- pictures 11, 21
- Playback 24
- Playback Menu 26
- Portrait mode 17
- power
 - indicators 49
 - light 5
 - usage 53
- preview Panorama 27
- print images 33, 36
- prints, buy online 37
- problems and solutions 41
- product support 46
- R**
- record video clips 12
- red-eye removal 16, 28
- Region 8
- remaining pictures count 11
- removing red eyes 28
- reset camera 41
- resolution 52
- reviewing images 24
- S**
- safety precautions for
 - batteries 48, 50
- selecting images for
 - destinations 37, 38
- selecting images for printing 36
- Self-Timer
 - light 6
 - setting 19, 21
- sending individual images 37, 38
- set date and time 8
- setting up destinations 37, 38
- share pictures 36
- shooting mode 16
- Shutter button 5, 12
- shutter speed 52
- slideshow 27
- Snow mode 17
- software install 9
- solving problems 41
- sounds of camera 39
- space remaining in memory 11
- specifications 52
- State Selector 5
- Steady Photo mode 17
- Stitch Panorama 27
- storage 53
- Sunset mode 17
- support process 46
- T**
- tagging images 26
- Theatre mode 17
- Thumbnails 25
- Thumbnails control 5
- Time & Date 8, 39
- transfer images 32, 33
- troubleshooting 41
- turn on/off power 7
- TV Configuration 40
- U**
- USB configuration 33, 39
- V**
- video clips 12, 19, 54
- Video Quality 19, 54
- Video Record Menu 18
- View Slideshow 27
- viewing thumbnails 25
- W**
- websites 46
- weight 53
- White Balance 20, 22
- Z**
- zoom 14, 52
- Zoom lever 5

Free Manuals Download Website

<http://myh66.com>

<http://usermanuals.us>

<http://www.somanuals.com>

<http://www.4manuals.cc>

<http://www.manual-lib.com>

<http://www.404manual.com>

<http://www.luxmanual.com>

<http://aubethermostatmanual.com>

Golf course search by state

<http://golfingnear.com>

Email search by domain

<http://emailbydomain.com>

Auto manuals search

<http://auto.somanuals.com>

TV manuals search

<http://tv.somanuals.com>