

HP PE4240n 42" Plasma Television

User's Guide

you + hp

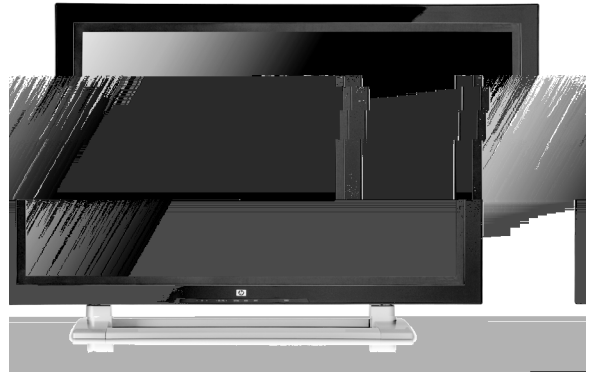

SRS
WOW

BBE
DIGITAL

hp
invent

The information in this document is subject to change without notice.

Hewlett-Packard Company makes no warranty of any kind with regard to this material, including, but not limited to, the implied warranties of merchantability and fitness for a particular purpose.

HP shall not be liable for errors contained herein or for incidental or consequential damages in connection with the furnishing, performance, or use of this material.

THE WARRANTY TERMS CONTAINED IN THIS STATEMENT, EXCEPT TO THE EXTENT LAWFULLY PERMITTED, DO NOT EXCLUDE, RESTRICT OR MODIFY AND ARE IN ADDITION TO ANY MANDATORY STATUTORY RIGHTS APPLICABLE TO THE SALE OF THIS PRODUCT OR SERVICE TO YOU.

HP assumes no responsibility for the use or reliability of its software on equipment that is not furnished by HP.

This document contains proprietary information that is protected by copyright. All rights are reserved. No part of this document may be photocopied, reproduced, or translated to another language without the prior written consent of HP.

Hewlett-Packard Company
P.O. Box 4010
Cupertino, CA 95015-4010
USA

© 2004 Hewlett-Packard Development Company, L.P.
All rights reserved.

HP supports lawful use of technology and does not endorse or encourage the use of our products for purposes other than those permitted by copyright law.

SRS WOW and the  are trademarks of SRS Labs, Inc. SRS WOW technology is incorporated under license from SRS Labs, Inc.

BBE Digital — License manufactured under license from BBE Sound, Inc. Patent licensed by BBE Sound, Inc. under USP4638258, 5510752, and 5736897. BBE and BBE symbol are registered trademarks of BBE Sound, Inc.



WARNING: Text set off in this manner indicates that failure to follow directions could result in bodily harm or loss of life.



CAUTION: Text set off in this manner indicates that failure to follow directions could result in damage to equipment or loss of information.

NOTE: Text set off in this manner indicates additional information.



DANGEROUS VOLTAGE: Text set off in this manner indicates the presence of uninsulated voltages within the product enclosure that may be of sufficient magnitude to constitute a risk of electrical shock to persons.

Table of Contents

Safety	1
Precautions	2
Cleaning the TV.....	3
Preventing Image Retention	4
Wall Mounting or Stand Replacement	4
Introduction	5
What is in the Box	5
Features	5
Overview	7
Identifying front panel controls and indicators	7
Identifying the remote control buttons	8
Identifying connectors	10
Set Up	12
Attaching and Connecting Optional External Speakers.....	12
Attaching the speakers to the TV.....	13
Connecting the speakers to the TV	14
Connecting an Antenna or Cable TV.....	15
Connecting an antenna or cable directly to the TV	15
Connecting a set-top-box to the TV.....	16
Connecting a digital TV (DTV) receiver to the TV.....	16
Connecting a PC or Other Equipment to the TV Using the VGA or DVI Connector	17
Connecting a Composite Video Source	18
Connecting an S-Video Source	19
Connecting a Component Source	20
Connecting the HP Media Center PC.....	21
Using the HP MCPC with the TV remote control	21
Installing or Replacing Remote Control Batteries.....	23

Using the TV	24
Front Panel Buttons	24
Basic Operations.....	25
Turning on the TV	25
Selecting the input source.....	26
Adjusting volume	26
Muting sound	26
Using the PIP/POP	26
Using the sleep timer to turn off the TV	27
Selecting the screen aspect.....	27
Using the On Screen Display (OSD) Controls	28
Using the OSD menus.....	29
Changing the OSD Settings	33
Setting up TV channels (Auto Scan)	33
Fine tuning a channel	37
Mapping channels	38
Adjusting the picture.....	40
Setting up the PIP/POP	41
Adjusting sound settings.....	42
Using the screen washing feature	44
Selecting Auto Off mode	45
Setting up V Chip.....	46
Using closed caption	50
Setting up VGA.....	51
Selecting color system.....	51
Using the Remote Control	52
Programming the remote control for component control.....	53
Troubleshooting	64
Specifications	66
Connector Specifications	67
Agency Regulatory Notice	69
Federal Communications Commission Notice.....	69
Modifications.....	69
Cables	69
Declaration of Conformity for products marked with the FCC logo – United States only	69
Index	70

Safety

First:

- Read all instructions before installing and operating the TV.
- Keep this user guide in a safe place for future reference.
- To reduce the risk of bodily injury, electric shock, fire, and damage to the TV, observe all warnings and precautions in this user guide.
- Do not use attachments that are not recommended by HP with this product. Use of inadequate attachments may result in damage to the product or personal injury.
- Follow all instructions.

Opening the package:

- Due to the size and weight of the TV, it is recommended that a minimum of two people move it.
- Whenever possible, use the handles on the back of the TV for transport.
- If speakers are attached to the TV, do not lift the TV by the speakers; instead, use the handles and the area under the screen.
- The protective glass and the glass substrate are installed on the front of the TV. Because both glasses can be broken and scraped easily, move the product gently. Never place the TV with the glass facing downward, unless it is protected with pads.
- The TV is packaged in a carton with other standard accessories. When opening the carton, check that the TV is in good condition and that all standard accessories and items are included. Any optional accessories come separately in another carton.

Installing the TV:

- A specified technician from the distributor or authorized agent should install the TV. Refer to “Wall Mounting or Stand Replacement” on page 4 for more information.
- Install the TV on a flat surface to avoid tipping. Leave some distance between the back of the TV and the wall for proper ventilation. Never install the unit where the ventilation on the top of the TV is covered. Otherwise, fire or damage to the unit may occur.
- Avoid installing the TV in the kitchen, the bathroom, or any other area with high humidity. Damp conditions may shorten the service life of the electronic components, or may cause fire or electrical shock.
- Route power and signal cords appropriately to avoid stepping or tripping on them.
- Do not install this TV outdoors; rain or extended direct sunlight may damage the unit.
- Do not install the TV in a vehicle; vibrations may damage the unit, or the unit may fall and cause injury.
- Do not install the TV in a ship or a vessel; seawater damages the unit and may start a fire.
- Install the TV horizontally; any 90-degree clockwise or counterclockwise installation may induce poor ventilation and subsequent component damage. Do not hang the TV from the ceiling; the unit may fall and cause injury.
- Do not install near appliances, such as a microwave.
- Do not install near a heat source, such as a fireplace or radiator.

- Do not place the TV on an unstable cart or stand; the unit may fall over and cause injury.
- Do not install the TV where it has a protruding edge. For example, do not place the TV where an edge overhangs a table. Do not install the product on a column, where it may accidentally fall.
- If moving the TV from a cold place to a warm place, condensation may occur inside the unit. Allow the condensation to dry before turning on the unit.

Precautions



DANGEROUS VOLTAGE: Do not attempt to repair your television yourself. Removing the back cover of the TV may cause fire or electric shock. An HP authorized service provider should do service needed on components inside the TV.



CAUTION: Danger of explosion if batteries are incorrectly replaced. Replace with the same or equivalent type.

If the following conditions exist, unplug the TV from the electrical outlet and contact a qualified service professional:

- When the power cord or plug is damaged.
- When liquid was spilled on the product or when objects have fallen into the product.
- When the product does not operate as described in the instructions.
- When the product has been damaged or dropped.
- When the product displays an abnormal condition.
- When the product was exposed to rain or water.
- When the product shows signs of overheating.

Avoid hot areas: The TV should be placed away from heat sources such as radiators, heat registers, stoves, or other products (including amplifiers).

Avoid wet areas: Never use the TV in a wet location or near water. Do not expose the TV to dripping or splashing. Do not place objects filled with liquids, such as vases, on the TV.



WARNING: To reduce the risk of fire or electrical shock, do not expose the TV to rain or moisture.

Avoid pushing objects into the product: Never push objects of any kind into cabinet slots or other openings in the TV. Slots and openings are provided for ventilation. These opening must not be blocked or covered.

Using mounting accessories: Any mounting of the TV should follow the manufacturer's instructions and should use the mounting accessory recommended by the manufacturer.

Adjust the volume: Turn down the volume before using headphones or other audio devices.

Use the correct external power source: The product should be operated only from the type of power source indicated on the electrical ratings label. If you are not sure of the type of power source required, consult your HP authorized service provider or local power company.

Position the power cord carefully: Route the power cord so that it will not be walked on, tripped over, or pinched by items placed upon or against it. Pay particular attention to the plug, electrical outlet, and the point where the power cord exits the product.

Overloading: Do not overload an electrical outlet, power strip, or convenience receptacle. The overall system load must not exceed 80% of the power strip input rating.

Observe extension cord ratings: If an extension cord or power strip is used, make sure that the cord or strip is rated for the product and that the total ampere ratings of all products plugged into the extension cord or power strip do not exceed 80% of the extension cord or strip ampere ratings limit.

Using cables and power cords:

- Plug the product into a grounded (earthed) electrical outlet that is easily accessible at all times.
- Do not disable the power cord grounding plug. The ground plug is an important safety feature.
- Disconnect power from the TV by unplugging the power cord from the electrical outlet.
- Do not pull on cords and cables. When unplugging the cord from an electrical outlet, grasp and pull the cord by the plug.
- Do not attempt to power the TV with converter kits sold for appliances.
- Unplug the TV from the electrical outlet before cleaning. Do not use liquid cleaners or aerosol cleaners.



WARNING: Do not place any objects on top of the TV. Spilled water or metal objects may cause short circuit, fire, or electric shock if they penetrate into the housing of the TV.

Never use a damaged power cord. Do not place power cords in areas where they can be pinched, stepped on, or otherwise compromised. Heavy objects, heat, chemicals, or tensile force may damage the power cord and cause fire or electric shock.

Do not change or open the back cover. Removing the back cover of the TV may cause fire or electric shock. Contact the manufacturer when inspection or adjustment is required.

Unplug the TV during lightning storms or when unused for long periods of time.

Do not use the TV if any abnormality occurs. If any smoke or odor becomes apparent, unplug the power cord and contact the manufacturer immediately.

Do not try to repair the TV on your own.

Cleaning the TV

Use a dry, soft cloth to remove dust from the TV screen and the chassis.

- Unplug the TV before cleaning the screen.
- A special anti-glare coating is applied to the screen of your TV. Using solvents such as alcohol or abrasive material such as a power towel may affect the screen coating or bezel paint.
- Do not expose the product to volatile gas or fluid such as a pesticide.
- Do not put the TV in contact with vinyl or rubber products for a long period of time. Extended contact may result in the removal of the coating or degradation of the surface.

Preventing Image Retention

Your plasma TV illuminates phosphor to display images, much like a conventional tube-type television. Viewing stationary images for extended periods of time results in uneven aging of the phosphor, causing grayed-out images to permanently appear on the screen.

Permanent image retention can be avoided by taking some basic precautions. Following the recommendations listed below ensures your plasma TV will have longer life and offer better performance:

- Whenever possible, avoid frequently displaying stationary images, such as Web sites, computer graphics, or video games for extended periods of time.
- Display video and images in the widescreen 16:9 ratio format. Use the Aspect button on the remote control to change from 4:3 screen size (such as standard television) to fill the screen in 16:9 ratio. This will prevent potential image retention of sidebars. Refer to "Selecting the screen aspect" on page 27.
- Avoid viewing the onscreen display (OSD) menus from DVD players, VCRs, and other components for extended periods of time.
- When watching a movie from a DVD player or VCR, do not leave the same image paused continuously over a long period of time.
- Turn down the contrast and brightness of the screen. High brightness and contrast can accelerate image retention of stationary images.
- Your plasma TV has a special feature that illuminates the entire screen and can remove very minor instances of screen image retention. See "Using the screen washing feature" on page 44 for more information.

Image retention and uneven screen aging are not covered by your HP Warranty; refer to the *Warranty and Support Guide* that came with your TV.

Wall Mounting or Stand Replacement

A specified technician from the distributor or authorized agent should install the TV, including stand replacement or wall mounting. Wall mounting brackets are sold separately and are not included with the TV.

Wall mounting the TV requires:

- Removal of the transport handles on the back of the TV.
- Removal of the stand from the TV panel.
- Assembly of the wall mounting bracket and installation of the bracket onto the TV panel.
- Placement and installation of the TV panel with wall bracket onto the wall.

Due to the size and weight of the TV, it is recommended that a minimum of two people move it.

Introduction

The HP PE4240n 42" plasma TV is designed to deliver a fantastic image for an immersive home theater experience. Your new television features a bright and high-contrast enhanced definition plasma panel with Faroudja's Emmy-Award winning DCDi video processing. Your television is encased in a stylish piano black cabinet, and can be wall mounted or used with the included stand.

What is in the Box

- Plasma television with attached stand
- Power cord
- Remote control with batteries (two, non-rechargeable, size AA)
- Shielded coaxial cable (1.8m) for the antenna
- This guide
- Warranty and Support Guide
- Quick Start Guide

These items are all you need to set up your television for operation in its most basic configuration. Optional external speakers can attach to the TV and are available separately.

Features

The features you'll enjoy include:

- **Enhanced definition plasma display with 3000:1 contrast** provides a clear progressively scanned image with rich colors and deep black levels.
- **Picture-in-Picture or Picture-On-Picture** (side-by-side) viewing.
- **Emmy-Award winning DCDi video processing by Faroudja** detects low-angle lines and smoothes out staircases and jagged edges, bringing a new tier of realism to sporting events and movies.
- **Motion Adaptive Noise Reduction** greatly enhances the quality of standard definition and off air video.
- **FilmMode Processing** 3:2 and 2:2 pull down accurately reproduces film-originated content from video sources.
- **Fine Detail Enhancer** identifies and enhances areas of fine detail in a picture, such as skin and hair, for a dramatically more life-like appearance.
- **3D Y/C Digital Comb Filter** reduces flickering and enhances color purity in complex scenes from broadcast and composite signals from your DVD player or VCR.
- **Variable aspect ratio support** enables scaling of 4:3 video to fill the screen.
- **Svelte, wall-mountable design** that is only 4.3 inches (110 millimeters) thick.
- **DVI-D input** for digital video connections to set-top-boxes, DVD players, and PCs.

- Supports two selectable audio enhancements:
 - BBE High Definition Audio** restores clarity and presence for better speech intelligibility and musical realism.
 - SRS WOW™** creates a bigger, enhanced sound experience by providing three-dimensional sound, enhancing musical vocals, and creating the perception of deep, rich bass without the need for a subwoofer.
- **Universal Remote Control** compatible with additional consumer electronic devices, including HP Media Center PCs.

Overview

Identifying front panel controls and indicators

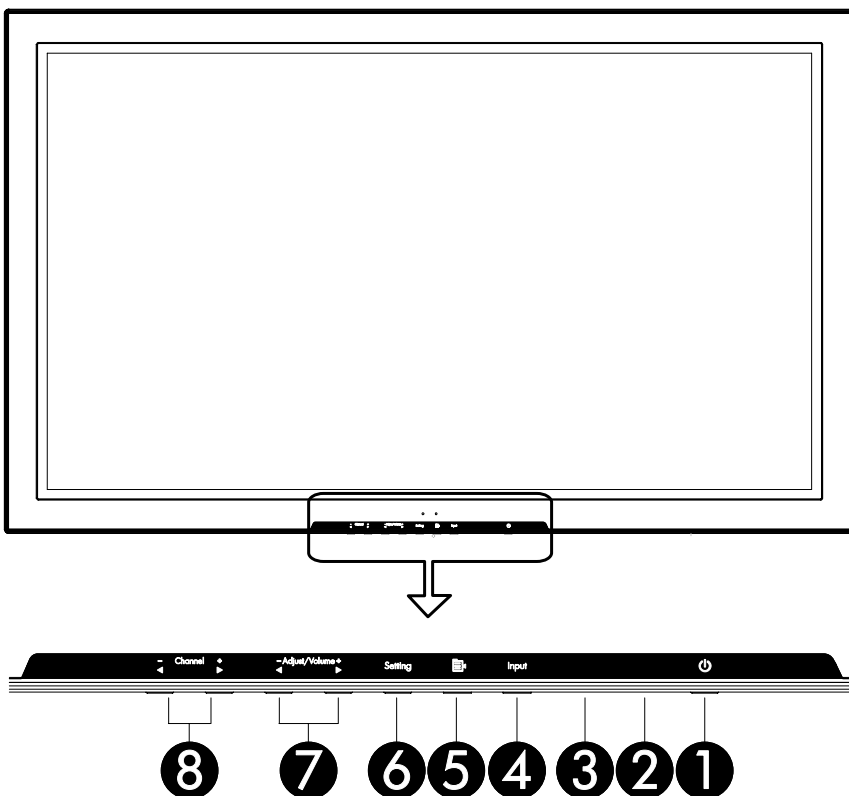

- 1 Power button
- 2 Power/standby indicator
- 3 Remote control sensor window
- 4 Input button
- 5 Menu button
- 6 Setting button
- 7 ADJ.+, ADJ-/VOL+, VOL- buttons
- 8 CH+, CH- buttons

The Power button (1) turns on the TV when the main power switch is on. (The main power switch is located on the bottom of the TV and is set to the On position from the factory. See "Identifying connectors" on page 10 for more information about the main power switch.)

The Power/standby indicator (2) shows the power status of the TV. See "Turning on the TV" on page 25 for more information.

Aim the remote control at the remote control sensor window (3) and press a button to operate the TV.

The Input button (4) selects the input signal source for the main picture.

The Menu button (5) sets the onscreen display (OSD) mode and shows the main menu or exits the OSD menu.

The Setting button (6) selects the input signal source for the Picture-in-Picture/Picture-on-Picture (PIP/POP), or in an OSD menu executes the selected item or setting.

The Adjustment/Volume buttons (7) adjusts the volume, or in an OSD menu selects an item or adjusts a level.

The Channel buttons (8) adjust the channel when the input signal source is the TV antenna/cable in connector.

Remote control item	Description
Info	Use INFO to display current channel and program information.
Menu	Press MENU to access the menu of your chosen component.
V-Chip/Fast reverse	Press V-Chip when using the TV to display a menu to enter a PIN to change (unlock) parental controls for a channel. (Set up the PIN in the Function OSD menu.) Press Fast reverse when using a VCR or other device.
PIP/Play	Press PIP to display the PIP mode. Press Play when using a VCR or other device.
Swap/Fast forward	Press Swap when using the PIP to exchange the pictures in the main display and the PIP/POP display. Press Fast forward when using a VCR or other device.
PIP Input/Record	Press PIP Input to select the source for PIP in this order: Video-1, S-video-1, Video-2, S-video-2. Use PIP Input as the Record button for HP MCPC.
Stop play	Press the Stop play button to stop when using a VCR or other device.
Freeze	Press the Freeze play button to pause on a frame of video when using a VCR or other video input source.
A	Use this key for a pre-set channel, selected in the OSD menus.
Sleep	Use the Sleep button set the sleep timer in this order: 30 MIN, 60 MIN, 90 MIN, 120 MIN, 000 (off). The timer cannot be canceled after it starts.
Replay/Reverse	Use the Replay button for HP MCPC Replay.
Skip/Forward	Use the Skip button for HP MCPC Skip.
B	Use this key for a pre-set channel, selected in the OSD menus.
Aspect	Use the Aspect button to select one of four screen sizes when viewing videos or digital discs.
Caption	Use the Caption button to display closed caption content.
MTS	Use MTS to select STEREO, MONO, SAP (second audio program) for TV sound.
AV, COMP, DVI/VGA, TV	Press one of these buttons one or more times to select the input source for the main picture: AV selects the input sources connected to the Video Inputs and S-video Inputs, in this order: Video Input 1, Video Input 2, S-video Input 1, S-video Input 2. COMP selects the input sources connected to the Component Video Inputs (YPBPR), in this order: Component Video 1, Component Video 2. DVI/VGA selects the input sources connected at the DVI or VGA connectors. TV selects the input from the TV antenna/cable in connector.

connectors

al board

eo
uts

dio
uts

deo
uts

onent
deo
uts

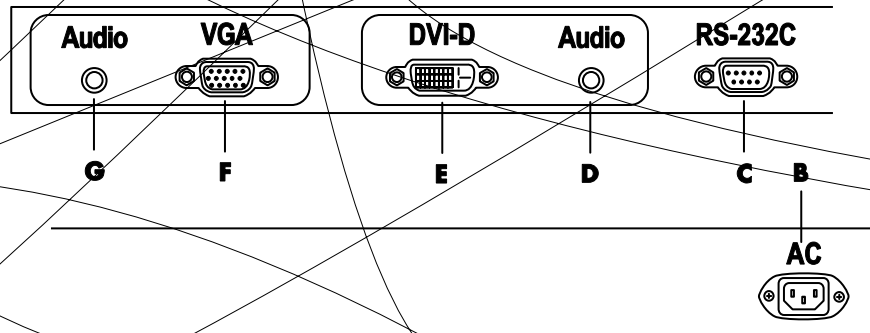
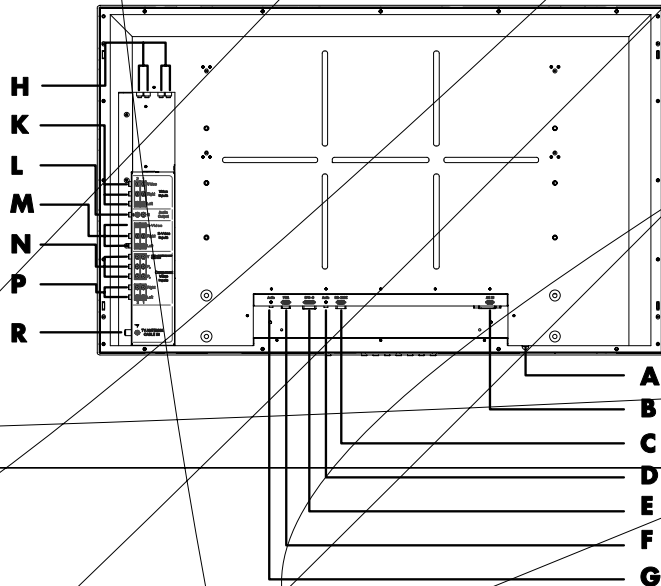

	Item	Description
A	Main power switch	Turns the AC power on and off. This switch is on from the factory. When this main power switch is off, the TV is fully unpowered; the power/standby indicator light on the front of the TV is off, and neither the front panel power button nor the remote control can be used to turn on the TV. If you turn the main power switch off, wait at least 5 seconds before turning it on again.
B	AC in connector	Connect the included power cord here.
C	RS232C	This terminal is used for service only.
D	Audio for DVI-D connector	Connect the audio cable for the DVI-D input.
E	DVI-D (29-pin) input	Connect a digital video cable for digital input signals from a PC monitor connector, or from a digital cable or satellite receiver set-top-box. This connector supports HDCP, a form of copy protection.
F	VGA, a D-sub (15-pin) input	Connect an analog cable for input signals from a PC monitor connector. See your component user documentation for information about the connector types it supports.
G	Audio for VGA connector	Connect the audio cable for the VGA input.
H	External speaker left and right output	Connect the optional external speakers here, and then select external speakers in the OSD menus.
K	Video Inputs	Connect composite video cable and left-right audio cables for one or two devices such as a VCR, a DVD player, or a laser disc player.
L	Audio Output	Connect audio out left-right cables to a powered amplifier.
M	S-video Inputs	Connect S-video cable and left-right audio cables for one or two devices such as a VCR, a DVD player, or a laser disc player.
N	Component Video Inputs	Connect cables for component video input. Use YPbPr 1 for input from devices that support High Definition signals such as a progressive scan DVD player, or a digital cable or satellite set-top-box. This connector supports 480p, 720p, and 1080i format video signals. Use YPbPr 2 for input from devices that support component signals in 480i video format such as a VCR, a DVD player, or a laser disc player.
P	Audio for component video inputs connectors	Connect audio left-right cables for the YPbPr-1 input and the YPbPr-2 input.
R	TV Antenna Cable In	Connect broadcasting (terrestrial) antenna or cable TV signal cable here.

Set Up

This section describes:

- How to attach and connect the optional external speakers; see page 12.
- How to connect an antenna or cable TV input; see page 15.
- How to connect a PC to the TV using the VGA or DVI-D connectors; see page 17.
- How to connect a composite video source, such as a VCR; see page 18.
- How to connect an S-video video source, such as a VCR or DVD; see page 19.
- How to connect a component video source, such as a DVD; see page 20.
- How to connect the HP Media Center PC (HP MCPC) and use the remote to operate the HP MCPC; see page 21.
- How to install or replace the batteries in the remote control; see page 23.

Attaching and Connecting Optional External Speakers

External speakers are optional equipment, and are not included with the TV.

You can attach the optional external speakers to the TV. You connect the speakers to the TV by using the external left and right speaker connections on the back of the TV. The right speaker is located at the right side of the TV when viewed from the front.

components before attaching external

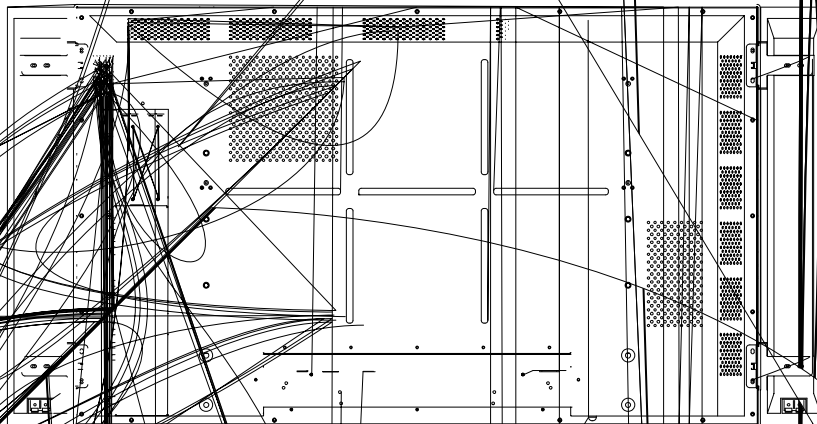

Connecting the speakers to the TV



CAUTION: Unplug the TV and all connected components before connecting external speakers. Use only speakers with 8-ohm impedance and a power input rating of 8 watts or more.

1 If necessary, strip the ends of the speaker cables to expose the wires.

NOTE: The right speaker is located at the right side of the TV when viewed from the front.

2 Press down the tab for the speaker connector, insert the speaker wire and release the tab to secure the wire:

- Connect the right speaker red (positive +) wire to the right red (+) connector.
- Connect the right speaker black (negative -) wire to right black (-) connector.
- Connect the left speaker red (positive +) wire to the left red (+) connector.
- Connect the left speaker black (negative -) wire to left black (-) connector.

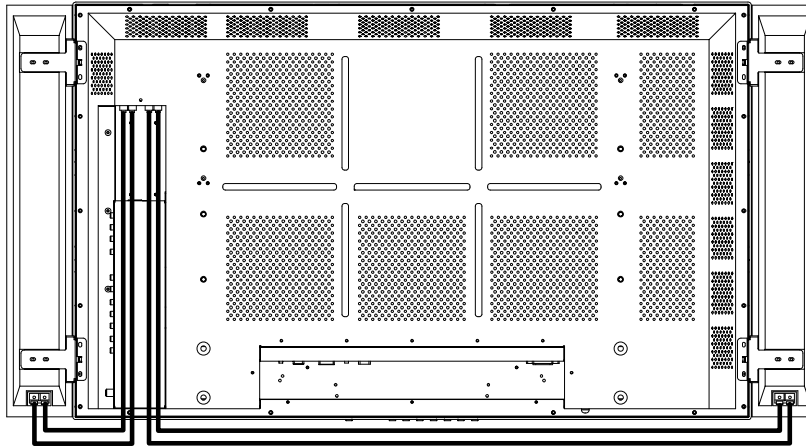

3 Select External speaker in the Sound menu of the on screen display (OSD) menus. Refer to "Selecting the speaker source" on page 43.

Connecting an Antenna or Cable TV

Use the first procedure that follows when connecting an antenna or cable TV cable directly to the TV. Refer to the next procedure, "Connecting a set-top-box to the TV" on page 16, when connecting a set-top-box for cable or satellite. Refer to "Connecting a digital TV (DTV) receiver to the TV" on page 16 when connecting a digital TV receiver (DTV).

Connecting an antenna or cable directly to the TV

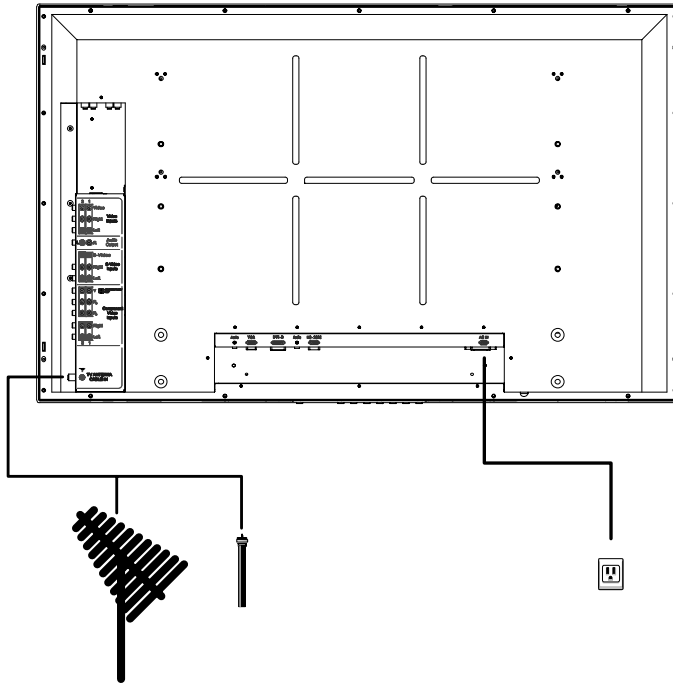

Use standard 75-ohm coaxial cable to connect a ground antenna or cable TV signal cable to the TV. Use shielded coaxial cable to reduce radio frequency (RF) interference. To make this connection:

- 1** Turn off the TV.
- 2** Connect the antenna or cable TV coaxial cable to the TV antenna cable in connector on the back of the TV.
- 3** Turn on the TV.
- 4** Select TV (the channel number) as the input source for the main TV picture by using the front panel buttons or the TV remote control. Refer to "Selecting the input source" on page 26.
- 5** Perform the Automatic Channel Scan (auto scan) procedure; refer to "Run auto scan" on page 33. This procedure includes the following tasks:
 - Selects Antenna or Cable for Signal Type in the TV Setup menu of the OSD menus.
 - Scans and identifies the available channels.

Connecting a set-top-box to the TV

Use standard 75-ohm coaxial cable to connect a cable TV set-top-box signal cable to the TV. Use shielded coaxial cable to reduce radio frequency (RF) interference. To make this connection:

- 1** Turn off the TV and the cable TV set-top-box.
- 2** Connect one end of a coaxial cable to the cable TV set-top-box output connector, and the other end of the cable to the TV antenna cable in connector on the back of the TV.
- 3** Turn on the TV and the cable TV set-top-box.
- 4** Select TV (the channel number) as the input source for the main TV picture by using the front panel buttons or the TV remote control. Refer to "Selecting the input source" on page 26.
- 5** Perform the Automatic Channel Scan (auto scan) procedure; refer to "Run auto scan" on page 33. This procedure includes the following tasks:
 - Selects Antenna or Cable for Signal Type in the TV Setup menu of the OSD menus.
 - Scans and identifies the available channels.
- 6** To set up the TV remote control to operate the set-top-box, refer to "Programming the remote control for component control" on page 53.

Connecting a digital TV (DTV) receiver to the TV

To connect the signal cable from a digital TV (DTV) receiver to the TV, use the component video input connectors (YPbPr-1) or the DVI-D connector on the back of the TV. Refer to "Connecting a Component Source" on page 20, or "Connecting a PC or Other Equipment to the TV Using the VGA or DVI Connector" on page 17.

Connecting a PC or Other Equipment to the TV Using the VGA or DVI Connector

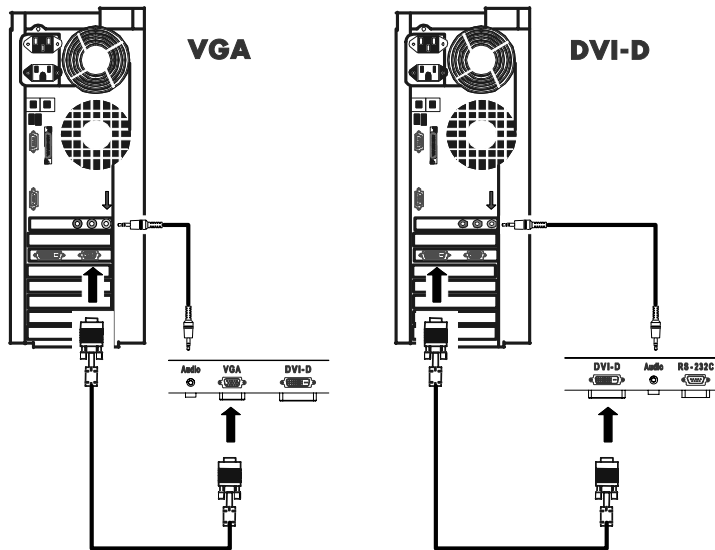

You may connect the TV to a PC or other equipment with a VGA cable or a digital interface compliant with the Digital Visual Interface (DVI) standard. Use a DVI-D 29-pin signal cable when making connections to the DVI connector. This connector supports HDCP, a form of copy protection. Note that the DVI terminal does not support analog RGB input.

NOTE: To maintain display quality, use a DVI-standard cable no longer than 5 meters (16.4 feet).

To make these connections:

- 1 Turn off the TV and the PC or other equipment.
- 2 Connect one end of the VGA or DVI cable to the output connector on the PC or other equipment, and the other end of the cable to the VGA or DVI-D connector on the back of the TV.
- 3 Turn on the TV and the PC or equipment.
- 4 Select DVI or VGA as the input source for the main TV picture by using the front panel buttons or the TV remote control. Refer to "Selecting the input source" on page 26.
- 5 For the VGA connector, perform these tasks:
 - In the Configuration menu of the OSD menus select the VGA source type (as Normal or Wide). Refer to "Setting up VGA" on page 51.
 - When you have an active input signal, select VGA as the input signal and perform Auto Adjustment in the Display menu of the OSD menus to have the TV automatically adjust Focus, Clock, Horizontal and Vertical Position, and H/V Size. Refer to "How to automatically adjust the picture for VGA input" on page 41.

- 6** For a set-top-box, perform these tasks:
 - Perform the Automatic Channel Scan procedure to establish the available channels. Refer to “Run auto scan” on page 33.
 - To set up the TV remote control to operate the set-top-box, refer to “Programming the remote control for component control” on page 53.
- 7** To have the TV screen turn off when there is no input signal on the DVI or VGA connector, change the setting for Auto Off in the Function OSD menu. Refer to “Selecting Auto Off mode” on page 45.

Connecting a Composite Video Source

Use RCA cables to connect your composite video source, such as a VCR, to the TV.

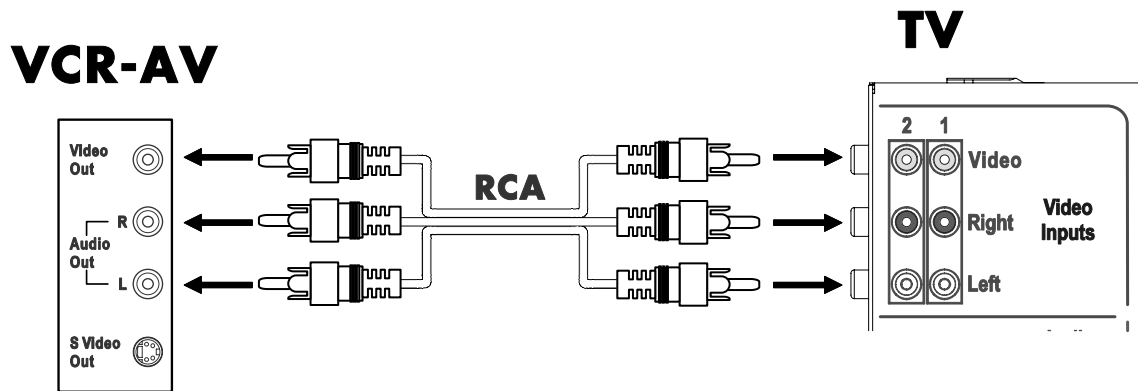

To make these connections:

- 1** Turn off the TV and the VCR.
- 2** Connect one end of the RCA cable to the video output connector on the back of your VCR, and connect the other end to the Video connector at the Video Inputs on the back of the TV. Use standard RCA audio patch cords to connect the audio from your VCR to the TV (if your VCR has this capability). Be careful to keep the audio right and left channel connections correct for stereo sound.
- 3** Turn on the TV and the VCR. Insert a cassette into the VCR and play it.
- 4** Select Video 1 or Video 2 (AV) as the input source for the main TV picture (so you see the image playing from the VCR) by using the front panel buttons or the TV remote control. Refer to “Selecting the input source” on page 26.
- 5** To set up the TV remote control to operate the VCR, refer to “Programming the remote control for component control” on page 53.

Refer to your VCR owner’s manual for information about your equipment’s video output requirements.

Connecti

Use



Connecting a Component Source

Use component video cables to connect your component video source, such as a DVD player or other equipment, to a component input connector (YPbPr-1 or YPbPr-2) on the TV.

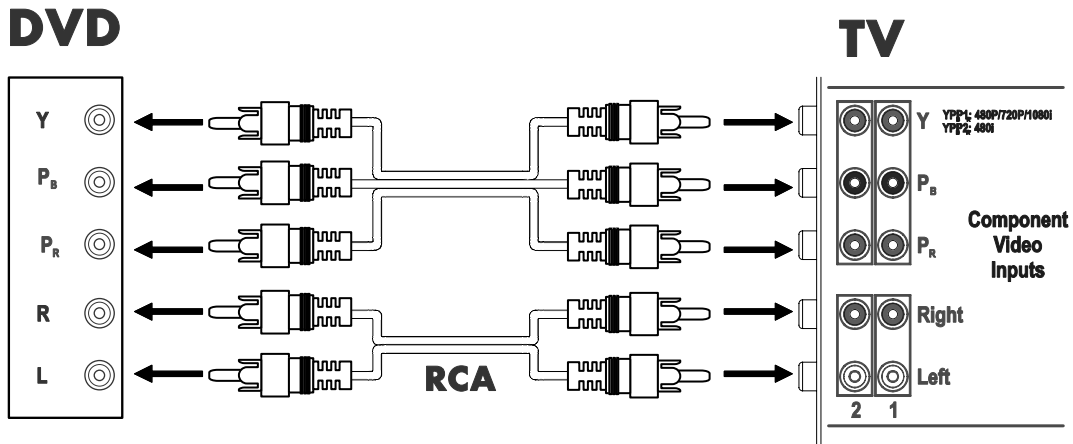

To make these connections:

- 1 Turn off the TV and the DVD player or other component input source equipment.

NOTE: YPbPr-1 supports 480p, 720p, and 1080i signals. YpbPr-2 supports only 480i signals.

- 2 Connect one end of the cables to the component video output connectors on the DVD player, and connect the other end to the YPbPr component video connectors on the TV. Be sure to match the cable to the connectors. Use standard RCA audio patch cords to connect the audio from your DVD to the TV (if your DVD has this capability). Be careful to keep the audio right and left channel connections correct for stereo sound.
- 3 Turn on the TV and the DVD player. Insert a disc into the DVD player and play it.
- 4 Select YPBPR1 or YPBPR2 (COMP) as the input source for the main TV picture (so you see the image playing from the DVD) by using the front panel buttons or the TV remote control. Refer to "Selecting the input source" on page 26.
- 5 To set up the TV remote control to operate the DVD, refer to "Programming the remote control for component control" on page 53.

Refer to your equipment owner's manual for information about your equipment's video output requirements.

Connecting the HP Media Center PC

You can connect the TV to an HP Media Center PC (HP MCPC) and use the special buttons on the remote control associated with the HP MCPC.

Refer to your HP MCPC documentation to connect the TV to the HP MCPC as:

- A monitor using either a VGA cable or a DVI-D cable; see “Connecting a PC or Other Equipment to the TV Using the VGA or DVI Connector” on page 17.
- A TV using the TV input source connectors for video (composite) inputs, S-video, or component video inputs; see the appropriate procedure in this document.

Using the HP MCPC with the TV remote control

- 1** Turn on the TV and the HP MCPC.
- 2** Press the appropriate TV input source button (**A** in the following figure) on the TV remote control to display the image on the main picture (refer to “Selecting the input source” on page 26):
 - Choose the DVI/VGA button when you’ve connected the TV to the HP MCPC as a monitor using the DVI-D or VGA connectors.
 - Choose the AV button when you’ve connected the TV to the HP MCPC as a TV using the Video or S-video inputs.
 - Choose the Comp button when you’ve connected the TV to the HP MCPC as a TV using the Component Video inputs.
- 3** Press HP.PC button (**B**) on the remote control to select the HP MCPC as the controlled device.
- 4** Point the remote control at the HP MCPC remote control sensor and press the buttons you want to use. The remote control buttons, such as the guide, channel, volume, and cursor buttons, function along with the special HP MCPC buttons (**C** through **H**) described in the table.

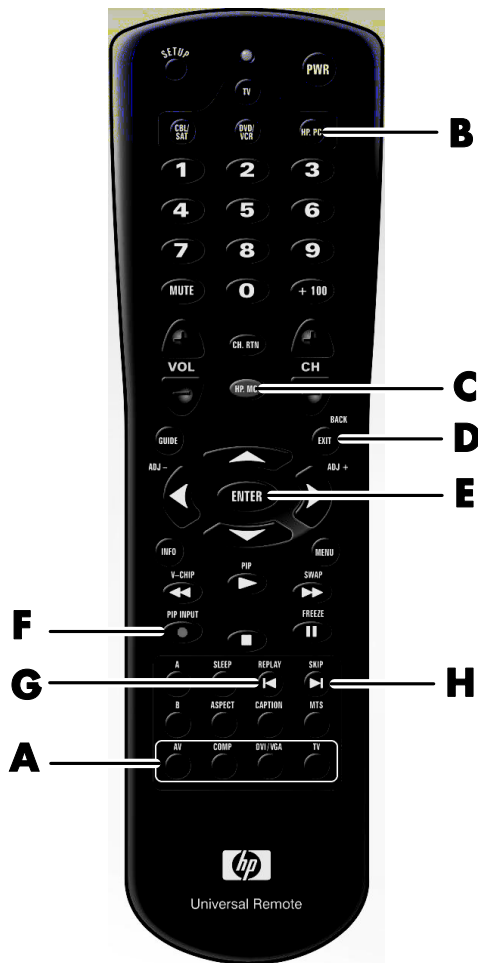

	TV remote button	HP MCPC button function
A	AV, COMP, or DVI/VGA	Selects the TV input source for the main screen
B	HP.PC	Selects the HP MCPC as the device controlled by the remote control.
C	HP.MC	Start
D	Back (Exit)	Back
E	Enter	OK
F	PIP Input	Record
G	Replay/Reverse	Replay
H	Skip/Forward	Skip

Installing or Replacing Remote Control Batteries

When the batteries are low, the red light on the remote control blinks twice when a button is pushed. Insert two AA non-rechargeable batteries into the remote control ensuring that you place them with the proper polarity.

- 1 Press and open the cover on the back of the remote control.
- 2 Insert the batteries into the remote control, and make sure that you match polarities.
- 3 Close the cover.



CAUTION: Use only the size and type of batteries specified.

Be sure to follow the correct polarity when installing the batteries as indicated in the battery compartment. Reversed batteries may cause damage to the device.

Do not mix different types of batteries together (e.g., alkaline and carbon-zinc) or old batteries with fresh ones.

When not using the remote for a long period of time, remove the batteries to prevent damage or injury from possible battery leakage.

Do not try to recharge batteries that are not intended to be recharged; they can overheat and rupture. (Follow the battery manufacturer's directions for the batteries you are using.)

Always remove batteries as soon as they become weak. Weak batteries can leak and severely damage the unit.

The battery life depends on how much the remote control is used. Replace batteries when remote control operation becomes erratic.

Do not take apart the batteries, heat them, or throw them into a fire.

Using the TV

Front Panel Buttons

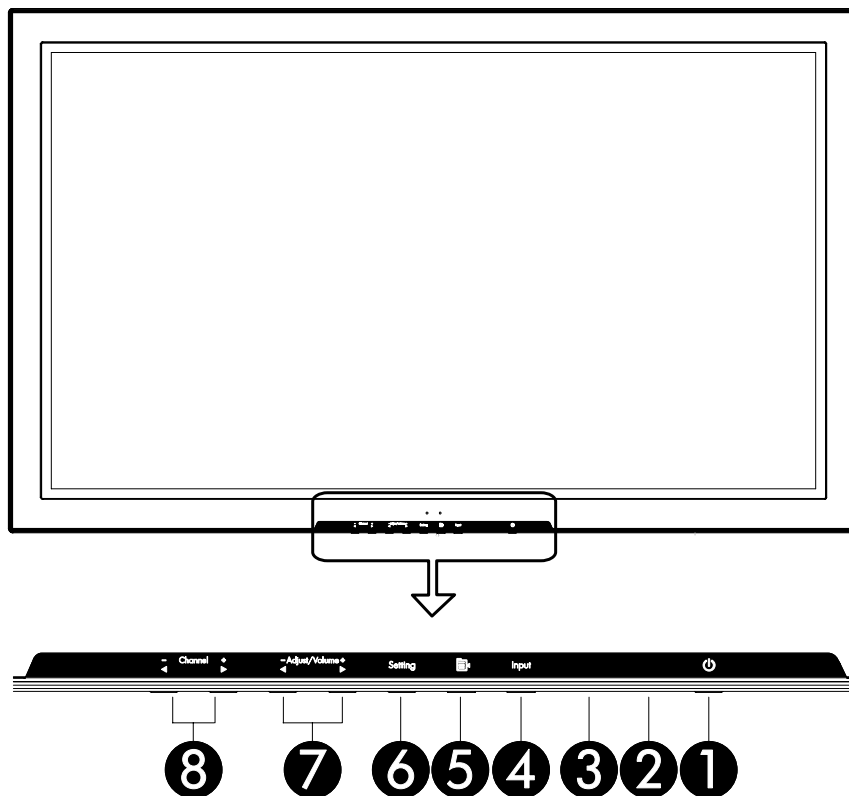

- 1 Power button
- 2 Power/standby indicator
- 3 Remote control sensor window
- 4 Input button
- 5 Menu button
- 6 Setting
- 7 ADJ.+, ADJ-/VOL+, VOL-
- 8 CH+, CH-

Bo

21

Selecting the input source

Select the input source for the main picture and the Picture-in-Picture/Picture-on-Picture (PIP/POP) using the front panel buttons or the remote control buttons.

Selecting the main picture input source using the front panel buttons

Press the Input button repeatedly until you see the desired input source. The sources appear in this order: Video1, S-video1, YPBPR1, VGA, DVI, Video2, S-video2, YPBPR2, Channel# (the TV channel).

Selecting the PIP/POP input source using the front panel buttons

Press the Setting button repeatedly until you see the desired input source. The sources appear in this order: Video1, S-video1, Video2, S-video2, YPBPR2.

Selecting the main picture input source using the remote control

Press the TV button (below the remote control indicator light) to select the TV as the controlled home entertainment device, and then press one of these input source buttons at the bottom of the remote control:

- **AV** selects the input sources connected to the Video Inputs and S-video Inputs, in this order: Video Input 1, Video Input 2, S-video Input 1, S-video Input 2.
- **COMP** selects the input sources connected to the Component Video Inputs (YPBPR), in this order: Component Video 1, Component Video 2.
- **DVI/VGA** selects the input sources connected at the DVI or VGA connectors.
- **TV** selects the input from the TV antenna/cable in connector.

Selecting the PIP/POP input source using the remote control buttons

Press the TV button (below the remote control indicator light) to select the TV as the controlled home entertainment device, press PIP to display the Picture-in-Picture, and then press PIP Input to select the source for PIP.

Adjusting volume

- 1 Press and hold the VOL+ button (on the remote control or on the TV) to increase to the desired level.
- 2 Press and hold the VOL- button (on the remote control or on the TV) to decrease to the desired level.

Muting sound

Press the Mute button on the remote control to cancel the sound; press it again to restore sound.

Using the PIP/POP

This section describes how to view the PIP/POP and how to swap the PIP/POP image with the main picture screen image. To select the PIP/POP input source signal, see "Selecting the input source" on page 26. To learn how to select the display for the PIP/POP, and how to adjust the picture, refer to "Setting up the PIP/POP" on page 41.

Viewing the PIP/POP

On the remote control, press the PIP button to display the PIP mode: PIP (picture inside the main picture), POP-left or POP-right (main picture and PIP shown side-by-side), or PIP off (full screen main picture).

Swapping the PIP/POP with the main screen image

With the PIP/POP screen displayed, on the remote control press the Swap button to exchange the image on the main screen with the image on the PIP/POP screen.

NOTE: Swap cannot exchange the pictures when the main picture source is the VGA, DVI, or YPBPR-1.

Using the sleep timer to turn off the TV

Press the Sleep button on the remote control to set the timer at 30 minutes. Press the button again until you arrive at your desired turn-off time or 000 to cancel the timer.

The timer cannot be canceled after it starts.

Selecting the screen aspect

With this function you can select one of four screen sizes when viewing videos or digital discs.

Press the Aspect button on the remote control, and if necessary press it again to select the desired screen size.

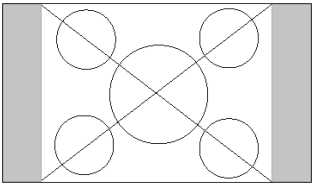
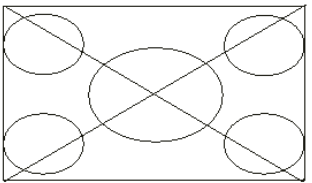
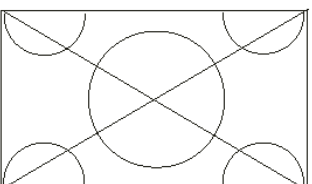
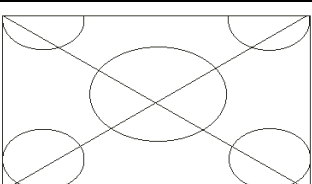
Image area	Ratio	Description
	4:3	The normal size screen display has a picture the same size as a video with a 4:3 aspect ratio. Use this mode for watching standard definition television in its original format. Do not use this mode for extended periods of time to avoid image retention of the black bars.
	16:9	This image is expanded in the horizontal direction. Use this mode for viewing wide screen movies from DVD players.
	Zoom 1	The image is expanded in the horizontal and the vertical directions, maintaining the original proportions. Use this mode to zoom in on the image.
	Zoom 2	The image is expanded in the horizontal and the vertical directions at different ratios. Use this mode to zoom in on the image.

Using the On Screen Display (OSD) Controls

Operate the onscreen display (OSD) controls using the front panel buttons or the remote control buttons to highlight, adjust, and enter items as described here.

Display the OSD by pressing the Menu button on the front panel or the remote control. The OSD shows the current menu with all of the available menus as small icons above it. Select the right-most menu icon to Exit or press Menu again.



To display a menu, highlight the menu and then press the button to execute it. The text of the current highlighted item in the submenu displays in green. The text displays in red when selected for adjustment. Adjust the setting and then press the execute button to accept it. Choose Exit Menu to exit the menu, and then select the Exit menu icon or press Menu to close the display. The menu disappears after 20 seconds of no operation.

- Using the front panel buttons (Refer to “Front Panel Buttons” on page 24 for button location):
 - 1 Press the Menu button **(5)** to display the OSD main menu.
 - 2 Press the ADJ buttons **(7)** to highlight a submenu or item, or to adjust or change a setting.
 - 3 Press the Setting button **(6)** to execute the selected item or the level setting.
- Using the remote control (Refer to “Identifying the remote control buttons” on page 8 for button location):
 - 1 Press the Menu button to display the OSD main menu.
 - 2 Press the ADJ buttons to highlight a submenu or item, or to adjust or change a setting.
 - 3 Press the Enter button to execute the selected item or the level setting.

Using the OSD menus

Refer to the following tables for the menu arrangement and functions.

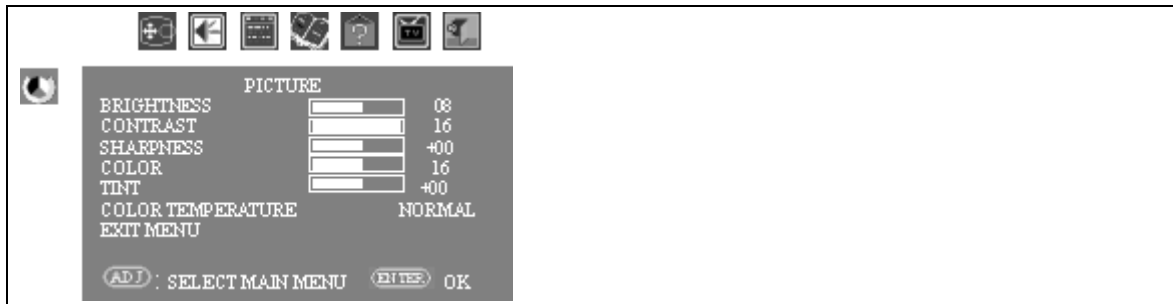

Picture menu	Function	Default	Reset
BRIGHTNESS	Adjusts the brightness.	Center	Yes
CONTRAST	Adjusts the contrast.	MAX	Yes
SHARPNESS	Adjusts the sharpness.	Center	Yes
COLOR	Adjusts the color.	Center	Yes
TINT	Adjusts the tint.	Center	Yes
COLOR TEMPERATURE	Adjusts the color temperature and white balance. Cool is high (a blue temperature), Normal is middle (standard), and Warm is low (a red temperature).	Normal	Yes

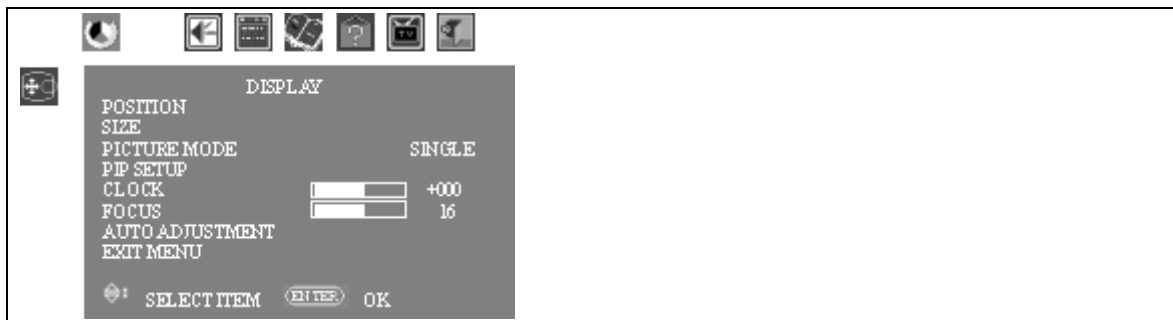

Display menu	Function	Default	Reset
POSITION	Adjusts the vertical/horizontal position.	Center	Yes
SIZE	Adjusts the vertical/horizontal size.	Center	Yes
PICTURE MODE	Select SINGLE, PIP, POP mode.	Single	Yes
PIP SETUP	Adjusts PIP picture, position, size, border size.	Center	Yes
CLOCK	Adjusts for striped patterns on the computer.	Center	No
FOCUS	Fine tunes the image.	Min	No
AUTO ADJUSTMENT	Select this to have the TV automatically adjust Focus, Clock, Horizontal and Vertical Position, and H/V Size for an active VGA input signal.	Not applicable	No

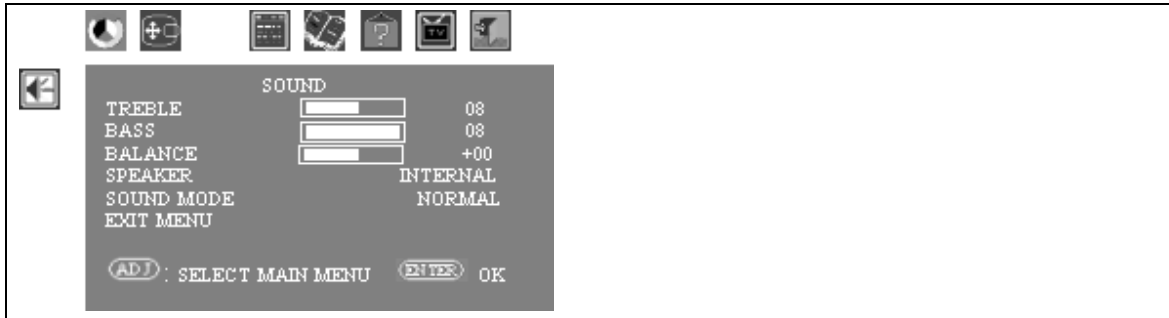

Sound menu	Function	Default	Reset
TREBLE	Sets the treble.	Center	Yes
BASS	Sets the bass.	Center	Yes
BALANCE	Sets the left and right balance.	Center	Yes
SPEAKER	Selects the internal or external speakers.	Internal	No
SOUND MODE	Set sound mode: NORMAL, 3D STEREO, WOW, BBE.	NORMAL	No

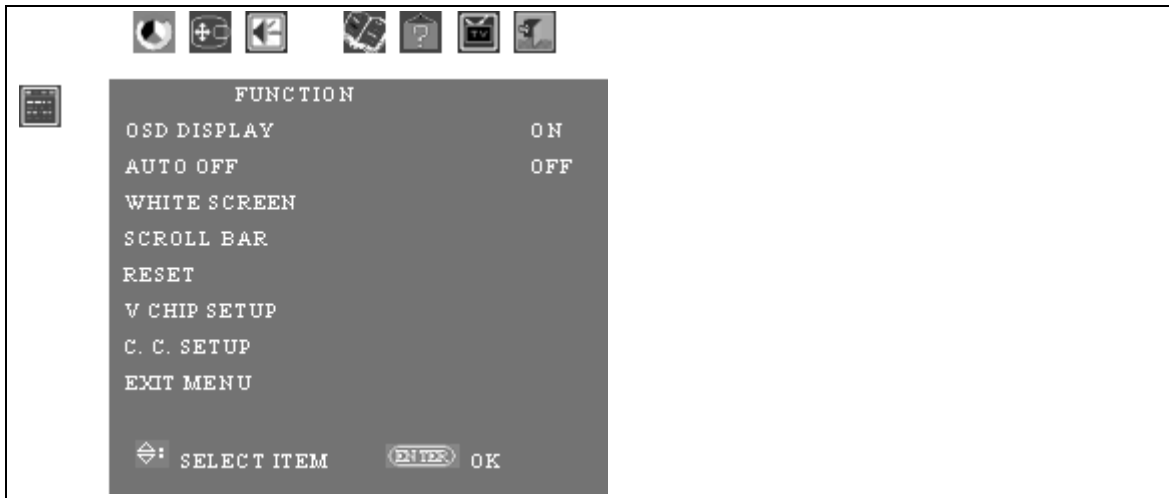

Function menu	Function	Default	Reset
OSD	When set to On, the input source information (screen mode, etc.) is displayed.	ON	Yes
AUTO OFF	Sets the TV for use as an energy-saving display so the TV turns off when the selected input is not active.	OFF	Yes
WHITE SCREEN	Select White Screen on or off. (Used for troubleshooting.)	OFF	Yes
SCROLL BAR	Select Scroll Bar on or off. (Used for troubleshooting.)	OFF	Yes
RESET	Resets all the settings (PICTURE, SOUND, SCREEN, FUNCTION, etc.) to the factory default values.	Not applicable	Not applicable
V CHIP SETUP	Select the V Chip settings menu.	NA	NA
C.C. SETUP	Select the Closed Caption settings menu	NA	NA

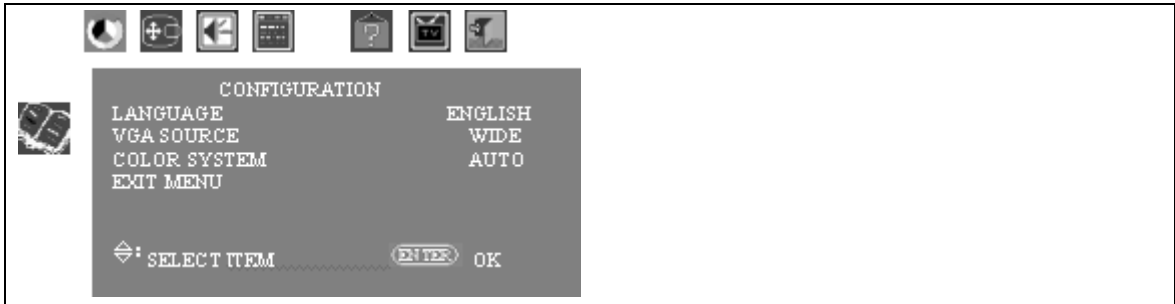

Configuration menu	Function	Default	Reset
LANGUAGE	Select the language for display.	ENGLISH	No
VGA SOURCE	Select WIDE, NORMAL.	NORMAL	No
COLOR SYSTEM	Select VIDEO SYSTEM, AUTO, NTSC*, PAL.	AUTO	No

*Only NTSC is supported.

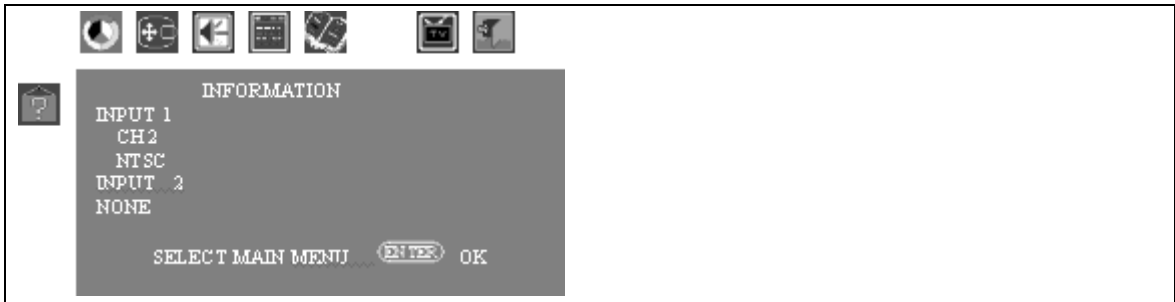

Information menu	Function	Default	Reset
INPUT 1	Shows input information for the main screen.	Not applicable	Not applicable
INPUT 2	Shows input information for the PIP/POP.	Not applicable	Not applicable

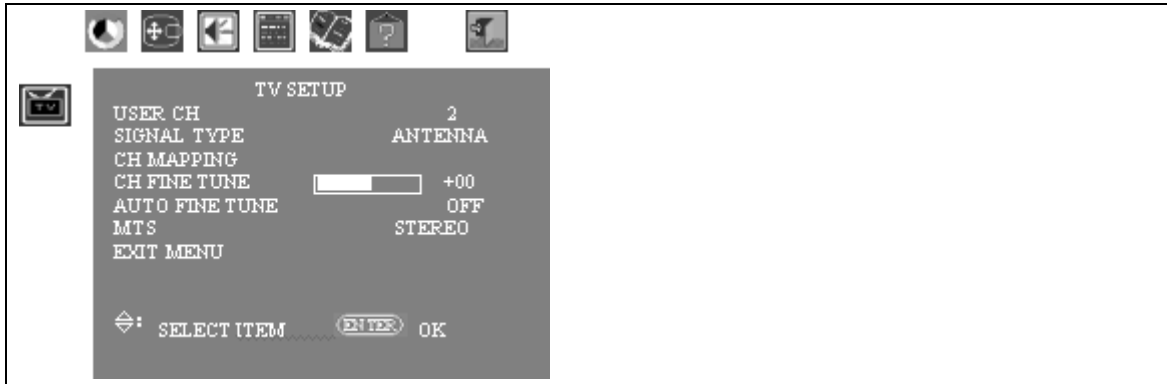

TV Setup menu	Function	Default	Reset
USER CH	SETTING USER CHANNEL.	Not applicable	No
SIGNAL TYPE	Select TV input signal type: Antenna or Cable.	ANTENNA	No
CH MAPPING	USER CH, TV CH, CH Status, To be CH A, To be CH B, AUTO CH SCAN (RECOMMEND).	Not applicable	No
CH FINE TUNE	Manual Fine Tune -64 ~ +64.	0	No
AUTO FINE TUNE	Select on or off for Fine Tune.	OFF	No
MTS	Select STEREO, SAP, MONO.	MONO	No

Changing the OSD Settings

The steps in this section describe how to:

- Set up the TV channels, including Automatic Scan of channels, adding or deleting a channel, and setting up favorite channels: see page 33.
- Fine tuning a channel: see page 37.
- Mapping channels: see page 38.
- Adjusting the picture: see page 40.
- Setting up the Picture-in-Picture/Picture-on-Picture display: see page 41.
- Adjusting the sound, including selecting the speaker source and selecting the SAP channel: see page 42.
- Washing the screen to reduce the effects of image retention on the plasma screen: see page 44.
- Selecting Auto Off mode to turn off the TV when the input signal is lost (as when the TV is connected as a monitor to a PC): see page 45.
- Setting parental guidance by using the V Chip setup: see page 46.
- Using closed caption: see page 50.
- Setting up the VGA connector for use: see page 51.
- Selecting the color system: see page 51.

Setting up TV channels (Auto Scan)

This section has three procedures:

- **Run auto scan.** The first time you connect an antenna or cable TV, perform the Auto Scan procedure to obtain the available channels.
- **Add or delete a channel.** After channels are identified using auto scan, use this procedure to modify the channel list.
- **Set up favorite channel.** Defines the channel to use for the A and for the B buttons on the remote control.

Run auto scan

- 1** Make sure TV is the input signal for the main picture. Refer to "Selecting the input source" on page 26.
- 2** Display the OSD menus. Refer to "Using the On Screen Display (OSD) Controls" on page 28 for steps to open and use the menus using the front panel buttons (or the remote control buttons).

3 Select and display TV Setup menu.



4 Highlight and select Signal Type so it turns red. Adjust the setting so it is correct for your set up (Antenna or Cable), and then press Setting front panel button (Enter on the remote control).

IMPORTANT: If you have Antenna selected for Signal Type in the TV Setup menu but have a cable input source connected, the automatic channel scan does not find all the available cable channels.

5 On the TV Setup menu, select CH Mapping, and then press Setting front panel button (Enter on the remote control).

6 The Channel Mapping menu appears.



7 Highlight and select Auto CH Scan, and then press Setting front panel button (Enter on the remote control) to start the scan.

8 If you need to stop the scan, press the CH RTN button on the remote control.

Add or delete a channel

- 1 Make sure TV is the input signal for the main picture. Refer to "Selecting the input source" on page 26.
- 2 Display the OSD menus. Refer to "Using the On Screen Display (OSD) Controls" on page 28 for steps to open and use the menus using the front panel buttons (or the remote control buttons).
- 3 Select and display TV Setup menu.



- 4 On the TV Setup menu, select CH Mapping, and then press Setting front panel button (Enter on the remote control). The Channel Mapping menu appears.



- 5 Highlight and select User CH so it turns red. Adjust the setting so it reads the channel number you want to add or delete, and then press Setting front panel button (Enter on the remote control).
- 6 Highlight and select CH Status so it turns red. Adjust the setting so it reads ADD or DEL, and then press Setting front panel button (Enter on the remote control).
- 7 Exit the menu.

Set up favorite channel

- 1 Make sure TV is the input signal for the main picture. Refer to "Selecting the input source" on page 26.
- 2 Display the OSD menus. Refer to "Using the On Screen Display (OSD) Controls" on page 28 for steps to open and use the menus using the front panel buttons (or the remote control buttons).
- 3 Select and display TV Setup menu.



- 4 On the TV Setup menu, select CH Mapping, and then press Setting front panel button (Enter on the remote control). The Channel Mapping menu appears.



- 5 Highlight and select User CH so it turns red. Adjust the setting so it reads the channel number you want to make a favorite, and then press Setting front panel button (Enter on the remote control).

- 6 Highlight and select To Be CH A or To Be CH B so it turns red. Adjust the setting so it reads YES to select the channel (or NO), and then press Setting front panel button (Enter on the remote control).



- 7 Exit the menu.

Fine tuning a channel

- 1 Make sure TV is the input signal for the main picture. Refer to "Selecting the input source" on page 26.
- 2 Display the OSD menus. Refer to "Using the On Screen Display (OSD) Controls" on page 28 for steps to open and use the menus using the front panel buttons (or the remote control buttons).
- 3 Select and display TV Setup menu.



- 4 Highlight and select User CH so it turns red. Adjust the setting so it reads the channel number you want to fine tune, and then press Setting front panel button (Enter on the remote control).

5 To fine tune the channel, do one of the following:

- Highlight and select CH Fine Tune so it turns red. Adjust the setting to fine tune the channel frequency, and then press Setting front panel button (Enter on the remote control).

Or

- Highlight and select Auto Fine Tune so it turns red. Adjust the setting to read On to automatically fine tune the channel frequency, and then press Setting front panel button (Enter on the remote control).

6 Exit the menu.

Mapping channels

Use this procedure to change what the TV displays when you select a channel. For example, use this procedure to have the TV show "CH 56" when you've select channel 38 from your input signal.

- 1** Make sure TV is the input signal for the main picture. Refer to "Selecting the input source" on page 26.
- 2** Display the OSD menus. Refer to "Using the On Screen Display (OSD) Controls" on page 28 for steps to open and use the menus using the front panel buttons (or the remote control buttons).
- 3** Select and display TV Setup menu.



- 4 On the TV Setup menu, select CH Mapping, and then press Setting front panel button (Enter on the remote control). The Channel Mapping menu appears.



- 5 Highlight and select User CH so it turns red. Adjust the setting so it reads the channel number you want to define (map), and then press Setting front panel button (Enter on the remote control).
- 6 Highlight and select TV CH so it turns red. Adjust the setting so it reads the channel number you want displayed (when the mapped user channel is selected), and then press Setting front panel button (Enter on the remote control).



- 7 Exit the menu.

Adjusting the picture

This section describes two procedures:

- How to adjust the main picture.
- How to have the TV automatically adjust the picture (focus, clock, horizontal and vertical position and size) for the active VGA input signal.

How to adjust the main picture

- 1 Select TV as the input source for the main TV picture by using the front panel buttons or the TV remote control. Refer to "Selecting the input source" on page 26.
- 2 Display the OSD menus. Refer to "Using the On Screen Display (OSD) Controls" on page 28 for steps to open and use the menus using the front panel buttons (or the remote control buttons).
- 3 Select and display Picture menu.



- 4 Highlight and select an item, such as Contrast, so it turns red. Adjust the setting, and then press Setting front panel button (Enter on the remote control).

Color Temperature adjusts the color temperature and white balance ratio: Cool is high (a blue temperature), Normal is middle (standard), and Warm is low (a red temperature).

How to automatically adjust the picture for VGA input

- 1 Select VGA as the input source for the main TV picture by using the front panel buttons or the TV remote control. Refer to "Selecting the input source" on page 26.
- 2 Display the OSD menus. Refer to "Using the On Screen Display (OSD) Controls" on page 28 for steps to open and use the menus using the front panel buttons (or the remote control buttons).
- 3 Select and display the Display menu.



- 4 Highlight Auto Adjustment, and then press Setting front panel button (Enter on the remote control).
- 5 Exit the menu.

Setting up the PIP/POP

This procedure describes how to select the display for the PIP/POP, and how to adjust the picture. To view the PIP/POP and swap the image with the main picture screen image, refer to "Using the PIP/POP" on page 26. To select the PIP/POP input source signal, see "Selecting the input source" on page 26.

IMPORTANT: To display the PIP Setup menu, the PIP/POP screen must have an input signal. In order to change the PIP setup, if necessary, view the PIP and then swap the image with the main picture.

- 1 Display the OSD menus. Refer to "Using the On Screen Display (OSD) Controls" on page 28 for steps to open and use the menus using the front panel buttons (or the remote control buttons).
- 2 Select and display the Display menu.

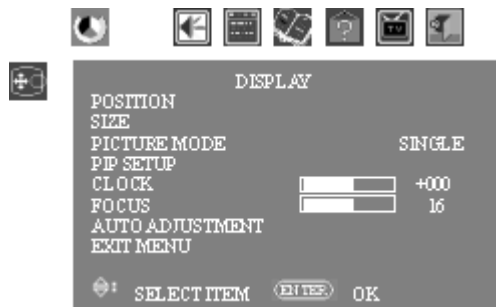

- 3 To select how the PIP/POP displays, highlight and select Picture Mode so it turns red, adjust the setting for Single, PIP, or POP, and then press Setting front panel button (Enter on the remote control).
 - Single shows only the main picture until PIP is selected with the front panel buttons or the remote control.
 - PIP always displays the PIP with the main picture.
 - POP always displays the POP with the main picture.
- 4 To adjust the PIP/POP picture (including PIP position and size), highlight PIP Setup, and then press Setting front panel button (Enter on the remote control). The PIP Setup menu appears with items Picture, PIP Position, and PIP Size.
 - Highlight Picture, and then press Setting front panel button (Enter on the remote control). The PIP Picture menu appears. Highlight and select an item, such as Contrast, so it turns red. Adjust the setting, and then press Setting front panel button (Enter on the remote control). Exit the menu.



- Highlight PIP Position, and then press Setting front panel button (Enter on the remote control). The Position screen appears. Highlight and select an item so it turns red, adjust the setting, and then press Setting front panel button (Enter on the remote control). Exit the menu.
 - Highlight PIP Size, and then press Setting front panel button (Enter on the remote control). The Size screen appears. Highlight and select an item so it turns red, adjust the setting, and then press Setting front panel button (Enter on the remote control). Exit the menu.
- 5 Exit the menu.

Adjusting sound settings

This section describes:

- Selecting the speaker source, including adjusting sound levels.
- Selecting SAP.

Selecting the speaker source

- 1 Display the OSD menus. Refer to "Using the On Screen Display (OSD) Controls" on page 28 for steps to open and use the menus using the front panel buttons (or the remote control buttons).
- 2 Select and display Sound menu.

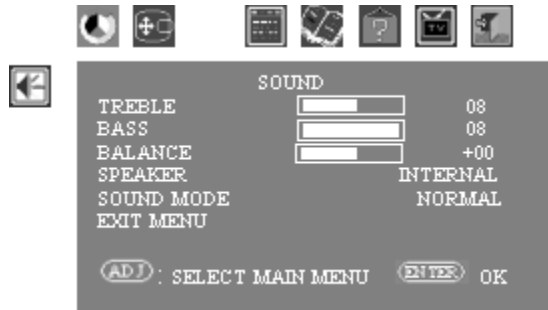

- 3 Highlight and select an item, such as Bass, so it turns red, adjust the setting, and then press Setting front panel button (Enter on the remote control).
 - For Speaker, choose Internal or External, depending on your speakers.
 - For Sound Mode, choose Normal, 3D Stereo, WOW, or BBE.
- 4 Exit the menu.

Selecting SAP

- 1 Display the OSD menus. Refer to "Using the On Screen Display (OSD) Controls" on page 28 for steps to open and use the menus using the front panel buttons (or the remote control buttons).
- 2 Select and display TV Setup menu.



- 3 Highlight and select MTS so it turns red, adjust the setting to select Stereo, SAP, or Mono, and then press Setting front panel button (Enter on the remote control).
- 4 Exit the menu.

Using the screen washing feature

Use this procedure to illuminate the entire screen and remove very minor instances of screen image retention.

NOTE: White Screen washes the screen using an entirely white screen, while Scroll Bar uses a bar of white that moves across the screen.

- 1 Display the OSD menus. Refer to “Using the On Screen Display (OSD) Controls” on page 28 for steps to open and use the menus using the front panel buttons (or the remote control buttons).
- 2 Select and display Function menu.



- 3 Highlight and select either White Screen or Scroll Bar, and then press Setting front panel button (Enter on the remote control). The TV immediately displays the white screen or the moving white scroll bar.
- 4 Let the TV display the white screen image for 30 minutes. Let the scroll bar continue until the image retention is no longer visible.
- 5 Press the Menu button to turn off the screen washing.

Selecting Auto Off mode

To have the TV screen turn off when there is no input signal, change the setting for Auto Off in the Function OSD menu to On. The TV turns off the screen approximately 5 minutes after losing the input signal.

- 1 Display the OSD menus. Refer to "Using the On Screen Display (OSD) Controls" on page 28 for steps to open and use the menus using the front panel buttons (or the remote control buttons).
- 2 Select and display Function menu.



- 3 Highlight and select Auto Off so it turns red. Adjust the setting so it reads On, and then press Setting front panel button (Enter on the remote control).
- 4 Exit the menu.

Setting up V Chip

Use the first procedure to set the guidelines for parental guidance. Use the second procedure to set the personal identification number (PIN). Use the remote control with these two procedures.

Changing the V Chip settings

- 1 Select TV as the input source for the main TV picture by using the front panel buttons or the TV remote control. Refer to "Selecting the input source" on page 26.
- 2 Display the OSD menus. Refer to "Using the On Screen Display (OSD) Controls" on page 28 for steps to open and use the menus using the remote control buttons.
- 3 Select and display Function menu.



- 4 Highlight V Chip Setup, and then press Enter on the remote control. The V Chip Setup screen appears.



- 9 Use the remote control ADJ buttons to highlight an item, and then press Enter on the remote control to turn the item red. Use the remote control ADJ buttons to change the item to Block or Unblocked, and then press Enter.
- 10 Exit the menu. Repeat steps 8 and 9 for the other guideline.
- 11 Exit the menu.

You can use the V-Chip button on the remote control to enter the pin and unlock a channel for immediate viewing.

Changing the V Chip PIN

- 1 Select TV as the input source for the main TV picture by using the front panel buttons or the TV remote control. Refer to "Selecting the input source" on page 26.
- 2 Display the OSD menus. Refer to "Using the On Screen Display (OSD) Controls" on page 28 for steps to open and use the menus using the remote control buttons.
- 3 Select and display Function menu.



- 4 Highlight V Chip Setup, and then press Enter on the remote control. The V Chip Setup screen appears.



- 5** Highlight and select Enter Pin so it turns red, use the remote control number buttons to enter the pin (the TV comes with pin 0000 until you change it), and then press Enter on the remote control. The expanded V Chip Setup screen appears.



- 6** Highlight Change PIN, and then press Enter on the remote control. The Change PIN Number screen appears.



- 7** Highlight and select Enter New PIN so it turns red, press the number buttons on the remote control to enter the new PIN, and then press Enter on the remote control.
- 8** Highlight and select Confirm New PIN so it turns red, press the number buttons on the remote control to reenter the new PIN, and then press Enter on the remote control.
- 9** Exit the menu.

Using closed caption

- 1 Select TV as the input source for the main TV picture by using the front panel buttons or the TV remote control. Refer to "Selecting the input source" on page 26.
- 2 Display the OSD menus. Refer to "Using the On Screen Display (OSD) Controls" on page 28 for steps to open and use the menus using the front panel buttons (or the remote control buttons).
- 3 Select and display Function menu.



- 4 Highlight C.C. Setup, and then press Setting front panel button (Enter on the remote control). The C.C. Setup screen appears.



- 5 Highlight and select Caption so it turns red. Adjust the setting so it reads On, and then press Setting front panel button (Enter on the remote control).
- 6 Highlight and select Mode so it turns red. Adjust the setting so it reads either Text or Caption, and then press Setting front panel button (Enter on the remote control).
- 7 Highlight and select Channel so it turns red. Adjust the setting so it shows 1, and then press Setting front panel button (Enter on the remote control).

NOTE: The Channel options are 1, 2, 3, or 4. A broadcast may contain other closed caption data on channels 2–4; for most uses, set the channel to 1.

- 8 Highlight and select Display so it turns red. Adjust the setting so it reads either Shadow or Box, and then press Setting front panel button (Enter on the remote control).
- 9 Exit the menu.

Setting up VGA

Use this procedure to select the VGA source signal type (Normal is 640 x 480, Wide is 852 x 480).

- 1 Display the OSD menus. Refer to “Using the On Screen Display (OSD) Controls” on page 28 for steps to open and use the menus using the front panel buttons (or the remote control buttons).
- 2 Select and display Configuration menu.



- 3 Highlight and select VGA Source so it turns red. Adjust the setting so it reads either WIDE or NORMAL, and then press Setting front panel button (Enter on the remote control).
- 4 Exit the menu.

Selecting color system

Select the color system for the Video input as Automatic, NTSC, or PAL input using this procedure.

- 1 Display the OSD menus. Refer to “Using the On Screen Display (OSD) Controls” on page 28 for steps to open and use the menus using the front panel buttons (or the remote control buttons).
- 2 Select and display Configuration menu.



- 3 Highlight and select Color System so it turns red. Adjust the setting so it reads Auto, NTSC, or PAL, and then press Setting front panel button (Enter on the remote control).

- 4 Exit the menu.
- 5 Exit the main menu.

Using the Remote Control

The remote control operates the TV, your cable or satellite set-top-box, your DVD/VCR, and your HP Media Center PC (HP PC). Refer to "Identifying the remote control buttons" on page 8 for information on the remote control buttons.

NOTE: Use the remote control within a distance of 16.4 feet (5 meters) from the front of the TV remote control sensor window and at the maximum horizontal and vertical angles of 30°.

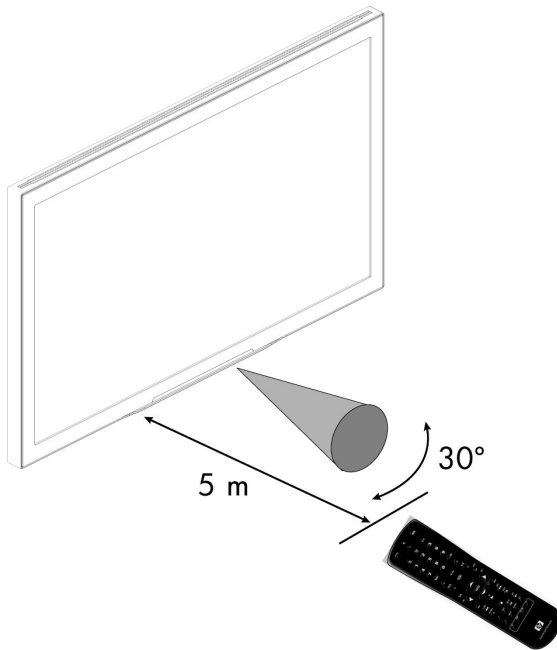

To use the remote control:

- 1 Press the TV, CBL/SAT, DVD/VCR, or HP.PC button to select the home entertainment component (TV, set-top-box, DVD/VCR, or HP MCPC) to control.
- 2 Aim the remote control at the remote control sensor of the selected home entertainment component, and then press the button you want to use.

Programming the remote control for component control

Programming the component code

- 1 Turn on the TV. Turn on the cable or satellite set-top-box, VCR, or DVD and, if applicable, insert media (a cassette or a disc).

NOTE: Please read steps 2 through 4 completely before proceeding. We recommend highlighting or writing down the codes and device you wish to program before performing step 2.

- 2 On the remote control, press CBL/SAT button or DVD/VCR button once. Press and hold SETUP until the red light blinks twice, then release SETUP.
- 3 Use the Manufacturer's Codes (see listing that follows) to locate the type of component by brand name and then enter the first four-digit code for your component. If performed correctly, the red light blinks twice.

NOTE: If the red light did not blink twice, then repeat steps 2 and 3, entering the code again.

- 4 Aim the remote control at the component and press PWR once. The component should turn off. If it does not respond, repeat steps 2 and 3, trying each code for your brand until you find one that works. If it still does not work, try searching for the code; see "Searching for the component code" on page 53.

NOTE: If the device does not have a power button, press PLAY.

- 5 Repeat steps 1 through 4 for each component you want to control with the remote control.

Searching for the component code

If your device does not respond to the remote control after trying all codes listed for your brand, or if your brand is not listed at all, try searching for your code:

- 1 On the remote control, press CBL/SAT button or DVD/VCR button once.
- 2 Press and hold SETUP until the red light blinks twice, then release SETUP.
- 3 Press the number buttons 9, 9, 1. The red light blinks twice.
- 4 Aim the remote control at the set-top-box or the VCR or DVD and slowly alternate between pressing PWR and the component (CBL/SAT or DVD/VCR) button. Stop when the component turns off.

NOTE: In the search mode, the remote control sends codes from its library to the selected device, starting with the most popular code first.

- 5 Press SETUP once to lock in the code.

Checking the component code

If you have set up the remote control to use a component, you may need to find out which four-digit code is operating your component equipment:

- 1 On the remote control, press CBL/SAT or DVD/VCR once.
- 2 Press and hold SETUP until the red light blinks twice, then release SETUP.
- 3 Press the number buttons 9, 9, 1. The red light blinks twice.
- 4 For the first digit of the code, press the number button 1 once. Wait 3 seconds, and then count the number of times the red light blinks and write down the number.

NOTE: When you count three blinks, it means the code digit is 3. When a code digit is 0, the red light will not blink.

- 5 Repeat step 4 for the three remaining digits of the code, pressing 2 for the second digit, 3 for the third digit, and 4 for the fourth digit.

Reassigning component buttons

The remote control can be set up to control a second TV or VCR, or any combination of eight home entertainment components.

For example, to control a TV, a Cable Converter, and two VCRs, you need to re-assign a component button to operate the second VCR as follows:

- 1 On the remote control, press and hold SETUP until the red light blinks twice, then release SETUP.
- 2 Press the number buttons 9, 9, 1. The red light blinks twice.
- 3 Press DVD/VCR once, then press CBL/SAT once.
- 4 The CBL/SAT button is now ready to be programmed for your second VCR. See "Programming the component code" on page 53.

To re-assign other device keys, repeat steps 1 through 4 by substituting the key sequence from the following table for the most popular components:

To assign	Use this sequence
TV as 2nd DVD/VCR button	SETUP - 9 - 9 - 2 — DVD/VCR - TV
TV as 2nd CBL/SAT button	SETUP - 9 - 9 - 2 — CBL/SAT - TV
TV back to TV	SETUP - 9 - 9 - 2 — TV - TV
VCR as 2nd CBL/SAT button	SETUP - 9 - 9 - 2 — CBL/SAT - VCR
VCR back to VCR	SETUP - 9 - 9 - 2 — VCR - VCR
CBL/SAT as 2nd VCR button	SETUP - 9 - 9 - 2 — VCR - CBL/SAT
CBL/SAT back to CBL/SAT	SETUP - 9 - 9 - 2 — CBL/SAT - CBL/SAT

When a re-assignment is done, the red light blinks twice to confirm your choice. Then, you need to program the remote control to control the new component; see "Programming the component code" on page 53.

Changing volume lock

The remote control is set to control volume of a component through your TV while in the TV, DVD/VCR, or CBL/SAT mode. However, in the HP.PC mode you have separate control of the volume.

If you want the volume to be controlled by a different component than the TV, you can change the Volume Lock setting to control volume through a non-associated mode (e.g., through the cable in the TV mode).

To change volume lock to another mode:

- 1 On the remote control, press and hold SETUP until the red light blinks twice, then release SETUP.
- 2 Press the number buttons 9, 9, 3, and then press any mode key once (except TV). The red light will blink twice.
- 3 Now, whenever you press VOL+, VOL-, or MUTE, volume is controlled by your component mode choice.

To change volume lock back to the TV mode:

- 1 On the remote control, press and hold SETUP until the red light blinks twice, then release SETUP.
- 2 Press the number buttons 9, 9, 3, and then press TV. The red light blinks twice.
- 3 Now, whenever you press VOL+, VOL-, or MUTE on the remote control, volume is controlled by your TV.

Troubleshooting the remote control programming

Problem	Solution
Red light does not blink when you press a key.	Replace the batteries with two (2) new AA non-rechargeable batteries.
Red light blinks when you press a key, but home entertainment component does not respond.	Make sure the remote control is aimed at your home entertainment component and is not farther than 15 feet away.
Remote control does not control home entertainment components or commands are not working properly.	Try all listed codes for the component brands being set up. Make sure they can be operated with an infrared remote control.
No volume on a 2nd TV.	Follow instructions in "Changing Volume Lock."
CH+, CH-, and CH.RTN do not work for your RCA TV.	Due to RCA design (1983-1987), only the original remote control will operate these functions.
Changing channels does not work properly.	If original remote control required pressing ENTER to change channels, press ENTER on the Remote control after entering the channel number.
Tried "Search Method" and still could not find a working code.	Try the "Search Method" again after clearing out the component button as follows: Press and hold SETUP until red light blinks twice, then release. Next enter 9 - 9 - 2. Then press and release the component button to be cleared twice.

Manufacturer's codes

Manufacturer	Codes for VCR
Admiral	0048
Adventura	0000
Aiko	0278
Aiwa	0037, 0000
Akai	0041
American High	0035
Asha	0240
Audiovox	0037
Beaumarck	0240
Bell & Howell	0104
Broksonic	0184, 0121, 0209, 0002
CCE	0072, 0278
Calix	0037
Canon	0035
Carver	0081
Cineral	0278
Citizen	0037, 0278
Colt	0072
Craig	0037, 0047, 0240, 0072, 0271
Curtis Mathes	0060, 0035, 0041, 0162
Cybernex	0240
Daewoo	0045, 0278
Denon	0042
Dynatech	0000
Electrohome	0037
Electroponic	0037
Emerex	0032
Emerson	0037, 0184, 0000, 0121, 0043, 0209, 0002, 0278
Fisher	0047, 0104
Fuji	0035, 0033
Funai	0000
GE	0060, 0035, 0048, 0240
Garrard	0000
Go Video	0526
GoldStar	0037, 0038

Manufacturer	Codes for VCR
Gradiente	0000
HI-Q	0047
Harley Davidson	0000
Harman/Kardon	0081, 0038
Harwood	0072
Headquarter	0046
Hitachi	0000, 0042, 0041
JVC	0067, 0041
Jensen	0041
KEC	0037, 0278
KLH	0072
Kenwood	0067, 0041, 0038, 0046
Kodak	0035, 0037
LXI	0037
Lloyd's	0000
Logik	0072
MEI	0035
MGA	0240, 0043
MGN Technology	0240
MTC	0240, 0000
Magnasonic	0278
Magnavox	0035, 0039, 0081, 0000, 0149
Magnin	0240
Marantz	0035, 0081, 0038
Marta	0037
Matsushita	0035, 0162, 0454
Memorex	0035, 0037, 0048, 0039, 0047, 0240, 0000, 0104, 0046, 1162, 1262
Minolta	0042
Mitsubishi	0048, 0067, 0043
Motorola	0035, 0048
Multitech	0000, 0072
NAP	0035, 0037, 0039, 0042, 0033
NEC	0104, 0067, 0041, 0038
Nikko	0037
Noblex	0240
Olympus	0035

Manufacturer	Codes for VCR
Optimus	0037, 0048, 0104, 0162, 0454, 1062, 1162, 1262
Orion	0184, 0002
Panasonic	0035, 0162, 0225, 0454, 1162
Penney	0035, 0037, 0240, 0042, 0038
Pentax	0042
Philco	0035, 0209
Philips	0035, 0081
Pilot	0037
Pioneer	0067
Profitronic	0240
Proscan	0060
Protec	0072
Pulsar	0039
Quarter	0046
Quartz	0046
Quasar	0035, 0162, 0454, 1162
RCA	0060, 0035, 0048, 0240, 0042, 0149
Radio Shack	0000
Radix	0037
Randex	0037
Realistic	0035, 0037, 0048, 0047, 0000, 0104, 0046
Runco	0039
STS	0042
Samsung	0240, 0045
Sanky	0048, 0039
Sansui	0000, 0067, 0041, 0271
Sanyo	0047, 0240, 0104, 0046
Scott	0184, 0045, 0121, 0043
Sears	0035, 0037, 0047, 0000, 0042, 0104, 0046
Semp	0045
Sharp	0048
Shintom	0072
Shogun	0240
Signature	0035
Singer	0072
Sony	0035, 0032, 0000, 0033

Manufacturer	Codes for VCR
Sylvania	0035, 0081, 0000, 0043
Symphonic	0000
TMK	0240
Tatung	0041
Teac	0000, 0041
Technics	0060, 0035, 0039, 0162
Teknika	0035, 0037, 0000
Thomas	0000
Toshiba	0045, 0043
Totevision	0037, 0240
Unitech	0240
Vector	0045
Vector Research	0038
Video Concepts	0045
Videosonic	0240
Wards	0060, 0035, 0048, 0047, 0081, 0240, 0045, 0000, 0042, 0072, 0149
White Westinghouse	0278
XR-1000	0035, 0000, 0072
Yamaha	0041, 0038
Zenith	0039, 0000, 0033

Manufacturer	Codes for cable converter box
ABC	0003, 0008, 0014, 0017, 0007, 0011, 0013
Allegro	0153, 0315
Archer	0153, 0797
Bell & Howell	0014
Century	0153
Citizen	0153, 0315
Comtronics	0040
Contec	0019
Eastern	0002
Emerson	0797
Everquest	0015, 0040
Focus	0400
Garrard	0153
Gemini	0015
General Instrument	0476, 0276, 0011, 0810
GoldStar	0144, 0040
Goodmind	0797
Hamlin	0020, 0259, 0009, 0034
Hitachi	0011
Hytex	0007
Jasco	0015, 0153, 0315
Jerrold	0003, 0012, 0476, 0276, 0014, 0015, 0011, 0810
Magnavox	0014
Memorex	0000
Movie Time	0063
NAP	0007
NSC	0063
Oak	0019, 0007
Optimus	0021
Panasonic	0000, 0107, 0021
Paragon	0000
Philips	0153
Pioneer	0144, 0533

Manufacturer	Codes for cable converter box
Popular Mechanics	0400
Proscan	0021
Pulsar	0000
Quasar	0000
RCA	0021
Radio Shack	0015, 0315, 0797, 0883
Recoton	0400
Regal	0020, 0259
Regency	0002
Rembrandt	0011
Runco	0000
SL Marx	0040
Samsung	0144, 0040
Scientific Atlanta	0008, 0477, 0017, 0877
Signal	0015, 0040
Signature	0011
Sprucer	0021
Starcom	0003, 0015
Stargate	0015, 0040, 0797
Starquest	0015
TV86	0063
Televue	0040
Tocom	0012, 0013
Toshiba	0000
Tusa	0015
Unika	0153
United Artists	0007
Universal	0153, 0191
Viewstar	0063
Zenith	0008, 0000, 0015, 0525
Zentek	0400

Manufacturer	Codes for satellite or DBS receivers
AlphaStar	0772
Echostar	0775
Expressvu	0775
General Instrument	0627, 0361, 0869
HTS	0775
Hitachi	0819
Hughes Net. Sys.	0749
JVC	0775
Jerrold	0627, 0361
Magnavox	0724, 0722
Memorex	0724
Next Level	0869
Panasonic	0701
Philips	0724, 0722
Primestar	0627, 0361
Proscan	0566
RCA	0566, 0143, 0855
Radio Shack	0566, 0869
Sony	0639
Star Choice	0869
Toshiba	0790
Uniden	0724, 0722
Zenith	0856

Manufacturer	Codes for DVD players
Harman/Kardon	0582
JVC	0558
Kenwood	0534
Magnavox	0503
Mitsubishi	0521
Onkyo	0503
Optimus	0525
Panasonic	0490
Philips	0503, 0539
Pioneer	0525, 0571
Proscan	0522
RCA	0522
Samsung	0573
Sony	0533
Technics	0490
Theta Digital	0571
Toshiba	0503
Yamaha	0490, 0545
Zenith	0503, 0591

Troubleshooting

If the picture quality is poor or you are experiencing another type of problem, check the adjustments and operations before requesting service. See the symptoms listed below, and try the checks and remedies.

Symptom	Checks	Remedy
The picture is disturbed. The sound is noisy. The remote control operates erroneously.	Is a connected component set directly in front of or at the side of the TV?	Leave some space between the TV and the connected components.
The remote control does not work.	Are the remote control's batteries worn out?	Replace both batteries with new ones.
The TV power does not turn on when I press the remote control power button.	Is the TV power cord plugged into a power outlet?	Plug the TV power cord into a power outlet.
	Is the power/standby indicator on the front of the TV off?	Press the main power button under the TV to turn it on.
	Are the remote control's batteries worn out?	Replace both batteries with new ones.
The TV does not respond when I press the remote control buttons.	Is the remote control pointed at the TV, or is there an obstacle between the remote control and the TV?	Point the remote control at the TV remote control sensor window on the front of the TV when pressing buttons, or remove the obstacle.
	Is the TV the selected component for the remote control to control?	Press the TV, CBL/SAT, DVD/VCR, or HP.PC button to select the home entertainment component (TV, set-top-box, DVD/VCR or HP MCPC) to control, and then aim the remote at the selected component and press the button you want to use.
	Is direct sunlight or strong artificial light shining on the TV remote control sensor window?	Eliminate the light by closing curtains, pointing the light in a different direction, or making other lighting adjustments.
	Are the remote control's batteries worn out?	Replace both batteries with new ones.
I do not hear sound or see a picture.	Is the TV power cord plugged into a power outlet?	Plug the TV power core into a power outlet.
I see a picture but hear no sound.	Is the volume set at the minimum?	Increase the volume.
	Is the mute mode set?	Press the remote control Mute button.
	Are the speakers properly connected?	Connect the speakers properly.
	Is the audio input set correctly?	Set the audio input on the Sound menu.

Symptom	Checks	Remedy
I get a poor picture with video signal input.	Improper control setting. Local interference. Cable interconnections. Input impedance is not correct level.	Adjust picture control as needed. Try another location for the TV. Be sure all connections are secure.
I get a poor picture with RGB signal input.	Improper control setting. Incorrect 15-pin connector pin-connections.	Adjust picture controls as needed. Check pin assignments and connections.
The tint is poor or colors are weak.	Are the tint and colors properly adjusted?	Adjust picture controls as needed. Check pin assignments and connections.
Nothing appears on the screen and I have an external device controlling the TV.	Is the external device or computer power turned on?	Turn on the external device or computer power.
	Is a source connected?	Connect source to the TV.
	Is the power management function in the standby or off mode?	Operate the external device or computer (move the mouse, or press a key).
Part of the picture is cut off or the picture is not centered.	Is the position adjustment appropriate?	Adjust the screen settings.
The picture image is too large or too small.	Is the screen size adjustment appropriate?	Press the Aspect button on the remote control and adjust properly.
The picture is unstable.	Is the external device or computer resolution setting appropriate?	Set to the proper resolution.
The Power/standby indicator on the front of the TV blinks in red.	The horizontal or vertical sync signal is not present when the Intelligent Power Manager control is on.	Check the input signal.
The Power/standby indicator on the front of the TV blinks rapidly in red.	Did the TV turn off 5 seconds after you turned it on?	Turn off the TV immediately and contact your dealer or authorized service center. The power supply circuit, the plasma display panel, or the temperature sensor has been damaged.

Specifications

Picture	
Screen size	36.3 (H) × 20.4 (V) in. [921 (H) × 518 (V) mm] diagonal 42 in. (1066.8 mm)
Aspect ratio	16:9
Resolution	852 (H) × 480 (V) pixels
Pixel pitch	0.43 (H) × 0.43 (V) in. [1.08 (H) × 1.08 (V) mm]
Color reproduction	256 levels, 16,770,000 colors
Signals	
Synchronization range	Horizontal: 31 to 69 kHz Vertical: 56.0 to 85 Hz
Input signals	VGA, DVI-D, Component, S-video, Composite, NTSC Tuner
Input terminals	
VGA	One Analog: mini D-sub 15-pin
DVI-D	One Digital: DVI-D 29-pin (digital only, not compatible with analog), supports HDCP (a form of copy protection)
Video	Two Component video: YPbPr-1 supports 480p, 720p, and 1080i signals, YPbPr-2 supports 480i Two S-video, DIN 4-pin type Two Composite video: RGB type
NTSC tuner	One IEC female TV system: NTSC3.58 (US)
Audio	Six Stereo RCA (R/L) Two Audio Jack
RS232C control	D-sub 9-pin, used for service only
Audio output	Internal 5W + 5W at 16 ohms External (optional) 10W + 10W at 8 ohms
TV	
Electrical rating	100 ~ 240 V _~ , 50/60 Hz, 3.5 A
Power consumption	380 W (typical)
Dimensions (W x H x D)	40.9 × 27.9 × 9.68 in. [1038 × 708.5 × 245.9 mm]
Weight	83.6 lb. (38 kg)
Environmental considerations	
Operating temperature	32°F to 104°F (0°C to 40°C)
Operating humidity	20 to 80% (no condensation)
Storage temperature	14°F to 122°F (-10°C to 50°C)
Storage humidity	10 to 90% (no condensation)

Connector Specifications

Pin assignments and signal for VGA D-sub 15-pin RGB (analog) connector

Pin number	VGA Signal (analog)
1	Red
2	Green or sync-on-green
3	Blue
4	No connection
5	Ground
6	Red ground
7	Green ground
8	Blue ground
9	No connection
10	Sync signal ground
11	No connection
12	Bi-directional data (SDA)
13	Horizontal sync or composite sync
14	Vertical sync
15	Data clock

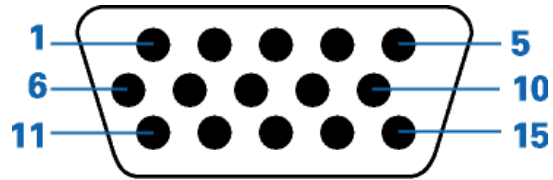

Pin assignments and signals for DVI-D connector

(TMDS can be used for one link only.)

Pin number	DVI-D Signal (digital)
1	TMDS data 2- -
2	TMDS data 2- +
3	TMDS data 2-shield
4	No connection
5	No connection
6	DDC clock
7	DDC data
8	No connection
9	TMDS data 1- -
10	TMDS data 1- +
11	TMDS data 1-shield
12	No connection
13	No connection
14	+5V power
15	Ground
16	Hot plug detect
17	TMDS data 0- -
18	TMDS data 0- +
19	TMDS data 0-shield
20	No connection
21	No connection
22	TMDS clock-shield
23	TMDS clock +
24	TMDS clock -
25	No connection
26	No connection
27	No connection
28	No connection
29	No connection

Agency Regulatory Notice

Federal Communications Commission Notice

This equipment has been tested and found to comply with the limits for a Class B digital device, pursuant to Part 15 of the FCC Rules. These limits are designed to provide reasonable protection against harmful interference in a residential installation. This equipment generates, uses, and can radiate radio frequency energy and, if not installed and used in accordance with the instructions, may cause harmful interference to radio communications. However, there is no guarantee that interference will not occur in a particular installation. If this equipment does cause harmful interference to radio or television reception, which can be determined by turning the equipment off and on, the user is encouraged to try to correct the interference by one or more of the following measures:

- Reorient or relocate the receiving antenna.
- Increase the separation between the equipment and receiver.
- Connect the equipment into an outlet on a circuit different from that to which the receiver is connected.
- Consult the dealer or an experienced radio or television technician for help.

Modifications

The FCC requires the user to be notified that any changes or modifications made to this device that are not expressly approved by Hewlett-Packard Company may void the authority to operate the equipment.

Cables

Connections to this device must be made with shielded cables with metallic RFI/EMI connector hoods in order to maintain compliance with FCC Rules and Regulations.

Declaration of Conformity for products marked with the FCC logo – United States only

This device complies with Part 15 of the FCC Rules. Operation is subject to the following two conditions: (1) this device may not cause harmful interference, and (2) this device must accept any interference received, including interference that may cause undesired operation.

For questions regarding your product, contact:

Hewlett-Packard Company
P.O. Box 692000, Mail Stop 530113
Houston, Texas 77269-2000

Or call: 1-800-652-6672

For questions regarding this FCC declaration, contact:

Hewlett-Packard Company
P.O. Box 692000, Mail Stop 510101
Houston, Texas 77269-2000

Or call: (281) 514-3333

To identify this product, refer to the part, series, or model number found on the product.

Index

A

- add a channel, 33
- adjusting the main picture, 40
- adjusting, sound, 42
- adjusting, volume, 26
- antenna, 15
- aspect, 27
- auto adjustment, 40
- Auto Off for DVI/VGA input, 45
- Auto Scan, 33
- auto screen turn off, 45
- automatic channel setup (scan), 33

B

- balance, adjusting sound, 42
- bass, adjusting sound, 42
- batteries for remote control, 23
- brackets for speakers, 13
- buttons on the TV, 7

C

- cable TV connection, 15
- cable TV digital receiver connection, 16
- cable TV set-top-box connection, 16
- channel
 - favorite, 36
 - fine tune, manual, 32
 - fine tuning procedure, 37
 - mapping, 38
 - scan, 33
- channel setup, 33
- cleaning the screen, 3
- closed caption, setup, 50
- coaxial cable connection, 15
- color system, selecting for Video inputs, 51
- component input source, 20
- composite video input, 18
- Configuration menu, 31

- connecting
 - antenna, 15
 - component input (YPBPR-1), 20
 - composite video source, 18
 - DTV, 16
 - DVI-D, 17
 - HP MCPC, 21
 - PC, 17
 - speakers, 14
 - s-video, 19
 - VGA, 17
- connectors, 10, 11
- contents of box, 5

D

- delete a channel, 33
- Display menu, 29
- DTV, 16
- DVI-D, 17
 - connector, 11, 68
 - signals, 68

B

- external speakers, 12
 - selecting, 30
- external speakers (optional), 11

F

- favorite channel, 36
- features, 5
- fine tune channel, 32, 37
- Function menu, 30

G

- grayed-out images on the screen, 4

H

- handles, 1, 4
- HP MCPC
 - buttons on remote control, 22
- HP Media Center PC, 21

I

- image retention, 4
 - screen washing feature, 44
- image size (aspect), 27
- Information menu, 31
- installing the TV, 1, 4

M

- main power switch, 11, 25
- mapping channels, 38
- MCPC, 21
- Media Center PC, 21
- menu controls, 28
- mounting brackets, 4
- moving the TV, 1
- muting sound, 26

N

- normal, VGA input signal, 51
- NTSC, 51

O

- on screen display menus, 28
- opening the package, 1, 4
- OSD menu operation, 28
- OSD menus, 28

P

- PAL, 51
- parental guides, setting using V Chip, 46
- PC connection to the TV, 17
- picture
 - adjusting, 40
- Picture-in-Picture, 26, 41
- Picture menu, 29
- PIN for parental guides, 46
- PIP/POP
 - picture mode, 41
 - setting up, 41
 - using, 26
- Power button, 7, 25
- power switch
 - main, 11
 - main switch and power button, 25
- Power/standby indicator light, 25
- programming the remote control, 53
- protecting the screen, 4

R

- remote control
 - batteries, 23
 - buttons, 8
 - operation distance, 52
 - programming components, 53
 - troubleshooting, 55
 - with the HP MCPC, 21
- renaming channels, 38
- replacing remote control batteries, 23
- RS232 connector, 11

S

- safety, 1
- SAP, 42
- scan channels, for antenna or cable TV, 33
- screen
 - cleaning, 3
- screen aspect, 27
- screen image retention, 4
- screen washing feature, 44
- second audio program, 42
- set-top-box, 16
- setup of remote control, 53
- sleep timer, 27
- sound
 - adjusting treble, bass, and balance, 42
 - settings, 42
- Sound menu, 30
- Sound mode, 30
- speaker
 - brackets, 13
 - wires, 14
- speakers, 11, 12
- specifications, 66
- stand replacement, 4
- S-video, 19

T

- transport handles, 1, 4
- treble, adjusting sound, 42
- troubleshooting, 64
 - remote control, 55
- turn off screen when no input signal, 45
- turn off TV
 - sleep timer, 27
- turn on TV
 - main power switch, 11
- TV buttons, 7
- TV channel setup, 33
- TV Setup menu, 32
- TV stand, 4

U

using HP MCPC, 21

V

V Chip

changing the PIN, 48
settings, 46

VCR, 18, 19

VGA, 17

connector, 67
set up, 51
signals, 67

VGA connector, 11

VGA input signal, 51
auto adjustment, 29, 40

Video input

color system, selecting, 51
volume, adjusting, 26

W

wall mounting the TV, 4

white screen, 44

wide screen, 27

Wide, VGA input signal, 51

Y

YPBPR-1 component input source, 20



Printed on at least
50 % total recycled fiber with
at least 10% post-consumer paper

© 2004 Hewlett-Packard Development Company, L.P.

Printed in

www.hp.com



invent

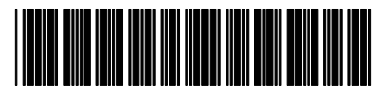

5 9 9 1 - 1 4 0 2

Free Manuals Download Website

<http://myh66.com>

<http://usermanuals.us>

<http://www.somanuals.com>

<http://www.4manuals.cc>

<http://www.manual-lib.com>

<http://www.404manual.com>

<http://www.luxmanual.com>

<http://aubethermostatmanual.com>

Golf course search by state

<http://golfingnear.com>

Email search by domain

<http://emailbydomain.com>

Auto manuals search

<http://auto.somanuals.com>

TV manuals search

<http://tv.somanuals.com>