

HP 54504A 400 MHz Digitizing Oscilloscope

Front-Panel Reference

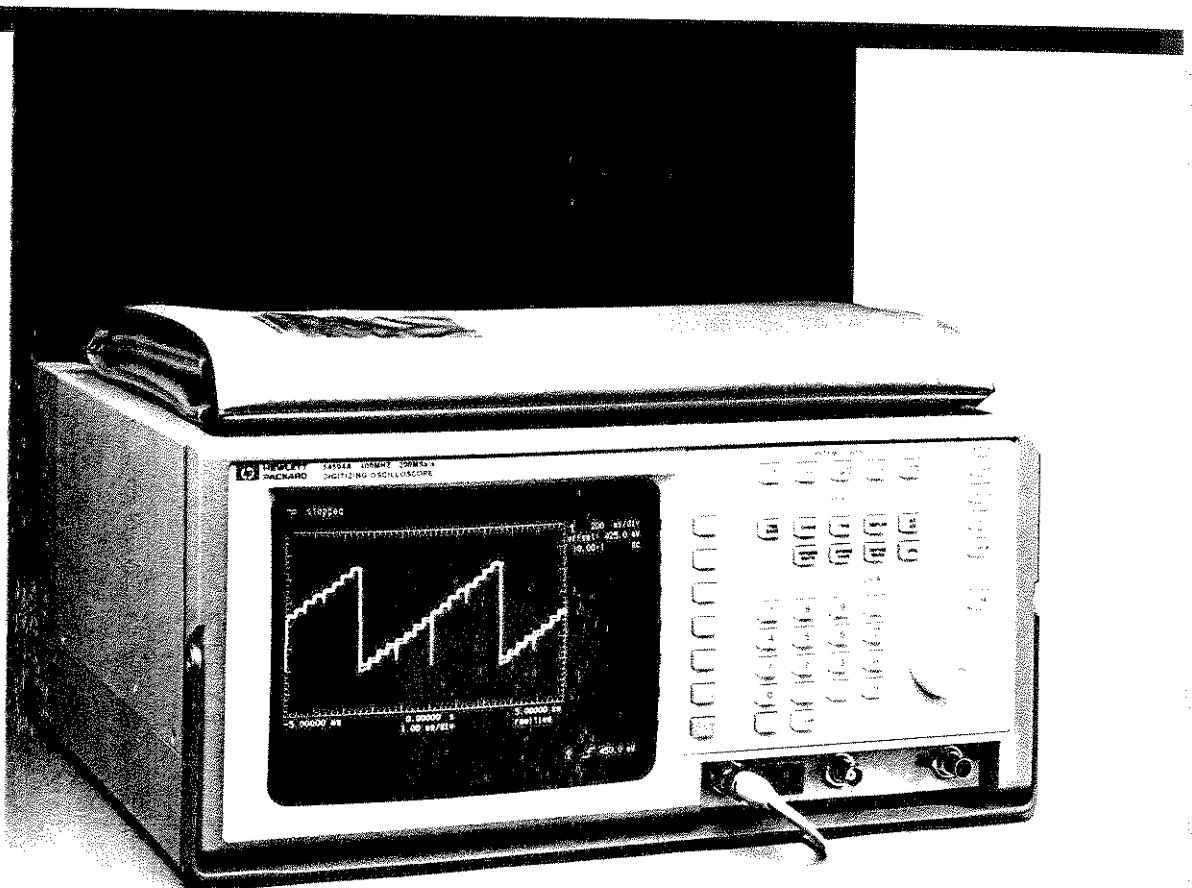

 **HEWLETT
PACKARD**

Front-Panel Reference

HP 54504A 400 MHz Digitizing Oscilloscope



©Copyright Hewlett-Packard Company 1989

Publication 54504-90901

Printed in the U.S.A. December 1989

Herstellerbescheinigung

Hiermit wird bescheinigt, daß das Gerät/System

HP 54504A

in Übereinstimmung mit den Bestimmungen von Postverfügung 1046/84 funkentstört ist.

Der Deutschen Bundespost wurde das Inverkehrbringen dieses Gerätes/Systems angezeigt und die Berechtigung zur Überprüfung der Serie auf Einhaltung der Bestimmungen eingeräumt.

Zusatzinformation für Meß- und Testgeräte

Werden Meß- und Testgeräte mit ungeschirmten Kabeln und/oder in offenen Meßaufbauten verwendet, so ist vom Betreiber sicherzustellen, daß die Funk-Entstörbestimmungen unter Betriebsbedingungen an seiner Grundstücksgrenze eingehalten werden.

Manufacturer's declaration

This is to certify that this product HP 54504A meets the radio frequency interference requirements of directive 1046/84. The German Bundespost has been notified that this equipment was put into circulation and was granted the right to check the product type for compliance with these requirements.

Additional Information for Test- and Measurement Equipment

Note: If test and measurement equipment is operated with unshielded cables and/or used for measurements on open set-ups, the user must insure that under these operating conditions, the radio frequency interference limits are met at the border of his premises.

Product Warranty

This Hewlett-Packard product has a warranty against defects in material and workmanship for a period of three years from date of shipment. During warranty period, Hewlett-Packard Company will, at its option, either repair or replace products that prove to be defective.

For warranty service or repair, this product must be returned to a service facility designated by Hewlett-Packard. However, warranty service for products installed by Hewlett-Packard and certain other products designated by Hewlett-Packard will be performed at the Buyer's facility at no charge within the Hewlett-Packard service travel area. Outside Hewlett-Packard service travel areas, warranty service will be performed at the Buyer's facility only upon Hewlett-Packard's prior agreement and the Buyer shall pay Hewlett-Packard's round trip travel expenses.

For products returned to Hewlett-Packard for warranty service, the Buyer shall prepay shipping charges to Hewlett-Packard and Hewlett-Packard shall pay shipping charges to return the product to the Buyer. However, the Buyer shall pay all shipping charges, duties, and taxes for products returned to Hewlett-Packard from another country.

Hewlett-Packard warrants that its software and firmware designated by Hewlett-Packard for use with an instrument will execute its programming instructions when properly installed on that instrument. Hewlett-Packard does not warrant that the operation of the instrument software, or firmware will be uninterrupted or error free.

Limitation of Warranty

The foregoing warranty shall not apply to defects resulting from improper or inadequate maintenance by the Buyer, Buyer-supplied software or interfacing, unauthorized modification or misuse, operation outside of the environmental specifications for the product, or improper site preparation or maintenance.

**NO OTHER WARRANTY IS EXPRESSED OR IMPLIED.
HEWLETT-PACKARD SPECIFICALLY DISCLAIMS THE
IMPLIED WARRANTIES OR MERCHANTABILITY AND FITNESS
FOR A PARTICULAR PURPOSE.**

Exclusive Remedies THE REMEDIES PROVIDED HEREIN ARE THE BUYER'S SOLE AND EXCLUSIVE REMEDIES. HEWLETT-PACKARD SHALL NOT BE LIABLE FOR ANY DIRECT, INDIRECT, SPECIAL INCIDENTAL, OR CONSEQUENTIAL DAMAGES, WHETHER BASED ON CONTRACT, TORT, OR ANY OTHER LEGAL THEORY.

Assistance Product maintenance agreements and other customer assistance agreements are available for Hewlett-Packard products.

For any assistance, contact your nearest Hewlett-Packard Sales and Service Office.

Certification Hewlett-Packard Company certifies that this product met its published specifications at the time of shipment from the factory. Hewlett-Packard further certifies that its calibration measurements are traceable to the United States National Bureau of Standards, to the extent allowed by the Bureau's calibration facility, and to the calibration facilities of other International Standards Organization members.

Safety This product has been designed and tested according to International Safety Requirements. To ensure safe operation and to keep the product safe, the information, cautions, and warnings in this manual must be heeded.

Printing History

New editions are complete revisions of the manual. Update packages, which are issued between editions, contain additional and replacement pages to be merged into the manual by the customer. The dates on the title page change only when a new edition is published.

A software code may be printed before the date; this indicates the version of the software product at the time the manual or update was issued. Many product updates and fixes do not require manual changes and, conversely, manual corrections may be done without accompanying product changes. Therefore, do not expect a one to one correspondence between product updates and manual updates.

Edition 1

December 1989

54504-90901

List of Effective Pages

The List of Effective Pages gives the date of the current edition and of any pages changed in updates to that edition. Within the manual, any page changed since the last edition is indicated by printing the date the changes were made on the bottom of the page. If an update is incorporated when a new edition of the manual is printed, the change dates are removed from the bottom of the pages and the new edition date is listed in the Printing History and on the title page.

Pages

Effective Date

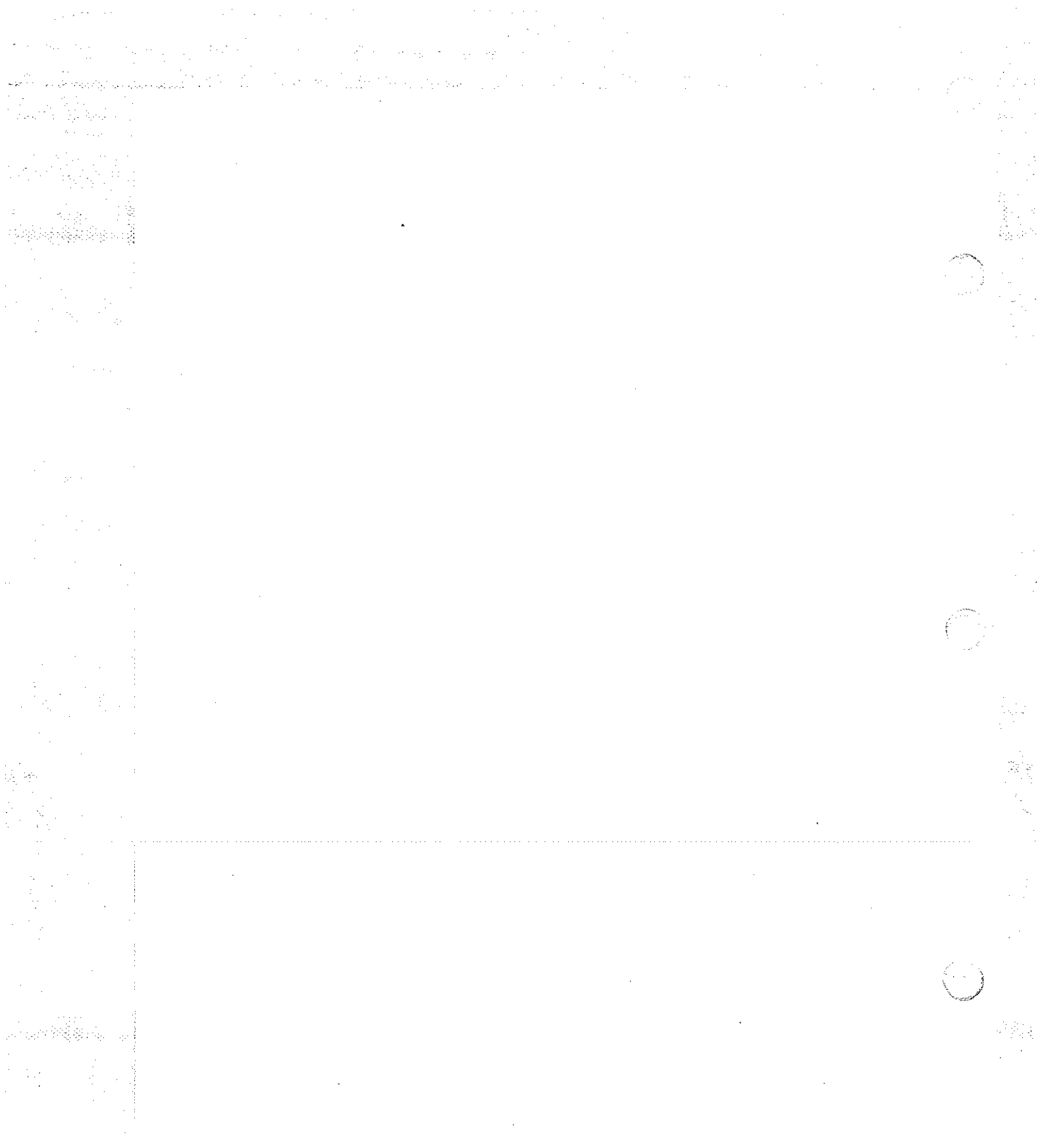

Table of Contents

Chapter 1	Page	Introducing the HP 54504A
	1-1	Introduction

Chapter 2	Page	Instrument Setup
	2-1	Introduction
	2-1	Initial Inspection
	2-1	Contents of Shipment
	2-2	Available Accessories
	2-2	Operating Environment
	2-2	Storage and Shipping
	2-3	Rear Panel
	2-3	Power Requirements
	2-4	Selecting Line Voltage
	2-5	Verifying the Fuse
	2-5	Power Cord
	2-5	Line Switch
	2-7	Intensity Control
	2-7	Air Flow Requirements
	2-8	Connecting External Equipment

Chapter 3	Page	Front-Panel Overview
	3-1	Introduction to the Front Panel
	3-2	System Control
	3-2	RUN/STOP Key
	3-3	SINGLE Key
	3-3	CLEAR DISPLAY Key
	3-3	LOCAL Key
	3-3	HARDCOPY Key
	3-4	Setup
	3-5	AUTOSCALE Key
	3-5	RECALL Key

**HP 54504A Front-Panel
Reference**

Table of Contents

1

3-6	SAVE Key
3-6	SHOW Key
3-7	Menus
3-8	Entry
3-8	Numeric Keypad
3-9	Knob
3-9	FINE Key
3-9	Input
3-10	Display
3-11	Instrument Reset

Chapter 4

	Page	Timebase Menu
4-1		Introduction to the Timebase
4-1		Time/Div Key
4-3		delay Key
4-3		reference Key
4-4		window Key
4-5		timebase Key
4-5		position Key
4-5		repetitive/realtime Key
4-5		repetitive mode
4-6		realtime mode
4-6		Window Exercise
4-6		Setting the Input Signal
4-7		Setting the Oscilloscope
4-9		Viewing the Window

Chapter 5

	Page	Channel Menu
5-1		Introduction to Channels
5-2		CHANNEL Key
5-2		Vertical Sensitivity Key
5-2		offset Key
5-3		Coupling Key
5-3		Input Impedance
5-4		more Key
5-4		probe key
5-5		ECL Key

Chapter 6

Page	Trigger Menu
6-1	Introduction to the Triggers
6-1	Trigger Mode Interaction
6-2	Edge Trigger Mode
6-3	trig'd/auto Key
6-3	source Key
6-3	level Key
6-3	slope Key
6-3	noise reject Key
6-3	holdoff Key
6-4	Holdoff Exercise
6-4	Instrument Setup
6-5	Oscilloscope Setup
6-8	Pattern Trigger Mode
6-9	pattern Key
6-9	when Key
6-10	holdoff Key
6-10	Pattern Trigger Exercise
6-11	Instrument Setup
6-11	Oscilloscope Setup
6-15	State Trigger Mode
6-15	clock Key
6-15	when Key
6-16	present Key
6-16	holdoff Key
6-16	State Trigger Exercise
6-16	Instrument Setup
6-17	Oscilloscope Setup
6-20	Delay Trigger Mode
6-20	qualify on Key
6-20	qualify on edge
6-21	qualify on pattern
6-21	qualify on state
6-22	delay Key
6-23	trigger on Key
6-23	Delay Trigger Exercise
6-23	Instrument Setup

6-24	Oscilloscope Setup
6-27	TV Trigger Mode
6-27*	Standard Select Key
6-27	Source Select Key
6-28	level/polarity Key
6-28	field Key
6-28	line Key
6-28	holdoff Key
6-29	TV Trigger Exercise
6-29	Instrument Setup
6-29	Oscilloscope Setup

Chapter 7

Page	Display Menu
7-1	Introduction to the Display
7-3	Display Mode Key
7-3	norm
7-4	avg
7-5	env
7-5	# of screens Key
7-6	off/frame/ axes/grid Key
7-7	connect dots Key
7-8	display record Key
7-8	filter Key

Chapter 8

Page	Delta t/Delta V Menu
8-1	Introduction to the Markers
8-2	DV markers Key
8-2	Vmarker 2 Key
8-2	Vmarker 1 Key
8-3	Dt markers Key
8-3	start marker Key
8-3	stop marker Key

Chapter 9

Page	Waveform Math Menu
9-1	Introduction to the Functions

Table of Contents
4

HP 54504A Front-Panel
Reference

9-2	Defining a Function
9-2	Function Key
9-2	display Key
9-3	chan/mem Key
9-3	Operator Key
9-4	chan/mem Key
9-4	sensitivity Key
9-4	offset Key
9-4	Vertical Scaling Units
9-4	Displaying Functions
9-6	Waveform Math Exercise
9-6	Instrument Setup
9-6	Oscilloscope Setup

Chapter 10

	Page	Waveform Save Menu
10-1		Introduction to the Memories
10-1		waveform/pixel Key
10-2		waveform Menu
10-2		nonvolatile Key
10-2		display Key
10-2		source Key
10-2		store Key
10-3		pixel Menu
10-3		volatile Key
10-3		display Key
10-3		clear memory Key
10-3		add to memory Key
10-4		Waveform Save Exercise
10-4		Instrument Setup
10-4		Oscilloscope Setup

Chapter 11

	Page	Define Measure Menu
11-1		Introduction to Measurements
11-2		Measurement Selection
11-3		meas/meas def/meas limit Key
11-3		meas Submenu

HP 54504A Front-Panel
Reference

Table of Contents
5

11-3	continuous Key
11-3	statistics Key
11-4	Measure Define Sub-menu
11-4	standard/user defined Key
11-4	thresholds/measurements Key
11-7	Measure Limit Sub-menu
11-7	test Key
11-8	set Key
11-8	fail if > Key
11-8	or if < Key
11-8	save to Key
11-8	after fail Key

Chapter 12

	Page	Utility Menu
12-1		Introduction to the Utilities
12-2		HP-IB menu
12-2		talk only mode
12-2		addressed mode
12-3		EOI Key
12-3		form feed Key
12-3		paper length Key
12-3		device mode Key
12-3		exit menu Key
12-4		SELFTEST MENU
12-6		ram Test
12-6		rom Test
12-6		acquisition Test
12-6		Miscellaneous Test
12-6		loop Test
12-6		start test Key
12-6		test all Key
12-6		exit menu Key
12-7		PROBE CAL MENU
12-8		attenuation submenu
12-8		channel Key
12-8		start cal Key
12-8		continue Key
12-8		abort Key
12-8		exit menu Key

Table of Contents
6

**HP 54504A Front-Panel
Reference**

12-9	time Key
12-9	exit menu Key
12-10	Self Cal menu
12-10	cal select Key
12-11	channel Key
12-11	start cal Key
12-11	print cals Key
12-11	continue Key
12-11	abort Key
12-11	exit menu Key
12-11	service menu
12-12	clicker Key
12-12	ac BNC Key
12-12	Calibration Procedure

Appendix A

Page	Algorithms
A-1	Measurement Setup
A-1	Making Measurements
A-2	Standard Measurements
A-2	User defined Measurements
A-2	Automatic Top-Base
A-3	Edge Definition
A-3	Algorithm Definitions
A-3	delay
A-4	+ width
A-5	- width
A-5	Period
A-5	Frequency
A-5	Duty Cycle
A-5	Risetime
A-5	Falltime
A-5	Vmax
A-5	Vmin
A-5	Vp-p
A-6	Vtop
A-6	Vbase
A-6	Vamp
A-6	Vavg
A-6	Vrms

Appendix B

Page	Specifications and Characteristics
B-1	Specifications
B-1	Vertical
B-1	Horizontal
B-1	Trigger
B-2	Characteristics
B-2	Vertical
B-4	Horizontal
B-4	Trigger
B-5	Operating Characteristics
B-5	Vertical
B-6	Horizontal
B-6	Trigger Modes
B-7	Delayed Trigger
B-7	TV Trigger
B-8	Display
B-8	Display Modes
B-10	Delta-t / Delta-V
B-10	Waveform Math
B-10	Waveform Save
B-11	User-definable Measurement Thresholds
B-11	Setup Aids
B-12	Hardcopy
B-12	Full HP-IB Programmability
B-13	Product Support
B-13	General Characteristics
B-13	Environmental Conditions
B-14	Power Requirements
B-14	Weight
B-14	Dimensions

Table of Contents

8

HP 54504A Front-Panel
Reference

Introducing the HP 54504A

1

Introduction

The HP 54504A 400 MHz Digitizing Oscilloscope is a general purpose repetitive and realtime oscilloscope, fully programmable and transportable. The HP 54504A has two input channels and an external trigger input. Full HP-IB programmability is incorporated into the HP 54504A and may be used in a broad range of HP-IB applications, from high-speed ATE to device characterization in research and development environments. The HP 54504A also features powerful triggering, easy waveform storage, automatic measurements, and instant hardcopy output.

The HP 54504A features an easy-to-use human interface, yet has many sophisticated capabilities and multiple triggering functions. Waveforms are easily stored for future reference, waveform measurements are automatic, and instant hardcopy is available when the HP 54504A is teamed with an HP-IB compatible printer or plotter.

Some of the key features of the HP 54504A are listed here. See Appendix B for a complete listing of specifications and characteristics.

- Repetitive Bandwidth - dc to 400 MHz
- Single Shot(Realtime) Bandwidth - dc to 50 MHz
- Sample Rate - 200 MSa/s
- 8 bits vertical resolution
- Two channel input and display
- External Selectable Trigger
- Maximum Vertical Sensitivity - 1 mV/division
- Minimum Vertical Sensitivity - 5 V/division
- Autoscale for automatic setup
- Automatic measurements, with User Defined and Statistics
- Hardcopy output
- Measurement Limit test

- Waveform Math (+ , - , x , vs , invert , only)
- Four nonvolatile set-up memories
- Four nonvolatile waveform memories
- Two volatile pixel memories
- Dual Timebase Windowing
- Advanced Logic Triggering
- TV Triggering
- Pre and Post trigger viewing capability
- ECL/TTL Presets

Introduction
1-2

HP 54504A
Front-Panel Reference

Introduction

This chapter contains information for unpacking, applying power, and connecting optional accessories to the HP 54504A. Inspection, power requirements, and instructions for running the HP 54504A self-test for performance verification are also included in this chapter.

For safe and trouble-free operation, follow the instructions and advisories in this chapter. Read the Safety Summary included in this manual.

Initial Inspection

Inspect the shipping container for damage. If the shipping container or cushioning material is damaged, keep it until the contents of the shipment have been checked. Check the shipment for completeness and the instrument electrically and mechanically.

If the contents are incomplete, there is mechanical damage or defect, or if the instrument does not pass the selftest performance verification, notify the nearest Hewlett-Packard Office. Keep the shipping materials for carrier's inspection. The Hewlett-Packard Office will arrange for repair or replacement at HP's option without waiting for claim settlement.

Contents of Shipment

The following items are shipped with the HP 54504A Digitizing Oscilloscope:

- Two HP 10430A Probes
- Probe to BNC Adapter, 1250-1454
- *HP 54500 Digitizing Oscilloscopes Getting Started Guide*
- *HP 54504A Front-Panel Reference*
- *HP 54504A Programming Reference*
- *HP 54504A Service Manual*
- *Feeling Comfortable with Digitizing Oscilloscopes*

Available Accessories The following optional accessories are available for use with the HP 54504A:

- Carrying Case, HP Part Number 1540-1066
- Rack Mount Kit, HP Part Number 5061-6175
- HP 1180A Testmobile
- HP 1133A TV/Video Sync Pod
- HP 10024A Integrated Circuit 16-pin Test Clip
- HP 10211A Integrated Circuit 24-pin Test Clip
- PC Board Horizontal Mini Probe Socket, HP Part Number 1250-1737
- PC Board Vertical Mini Probe Socket, HP Part Number 1250-1918

Operating Environment

The HP 54504A oscilloscope is operated in a normal lab or bench environment without any additional considerations. Note the non-condensing humidity limitation in the list of characteristics supplied in this manual. Condensation in the instrument cabinet can cause poor operation or malfunction. Protection should be provided against temperature extremes which cause condensation.

Storage and Shipping The HP 54504A may be stored or shipped in environments with the following limitations:

- Temperature: -40° C to +75° C
- Humidity: Up to 90% at 65° C
- Altitude: Up to 15 300 meters (50 000 feet)

If the HP 54504A is to be shipped to a Hewlett-Packard Service Center for service or repair, attach a tag to the instrument identifying owner, address of owner, complete instrument model number and serial number and a description of required service.

If the original packaging material is no longer available, identical packing material is available through local Hewlett-Packard offices. Mark the

container FRAGILE to ensure careful handling. In any correspondence, refer to the instrument by the model and serial number.

Rear Panel

The rear panel of the HP 54504A contains the power input, voltage selector module, power switch, external connectors, and calibrator protection switches as shown in figure 2-1.

Power Requirements The HP 54504A requires a power source of either 115 or 230 Volts ac, -25% to +15%; single phase, 48 to 66 Hz; 200 Watts maximum power.

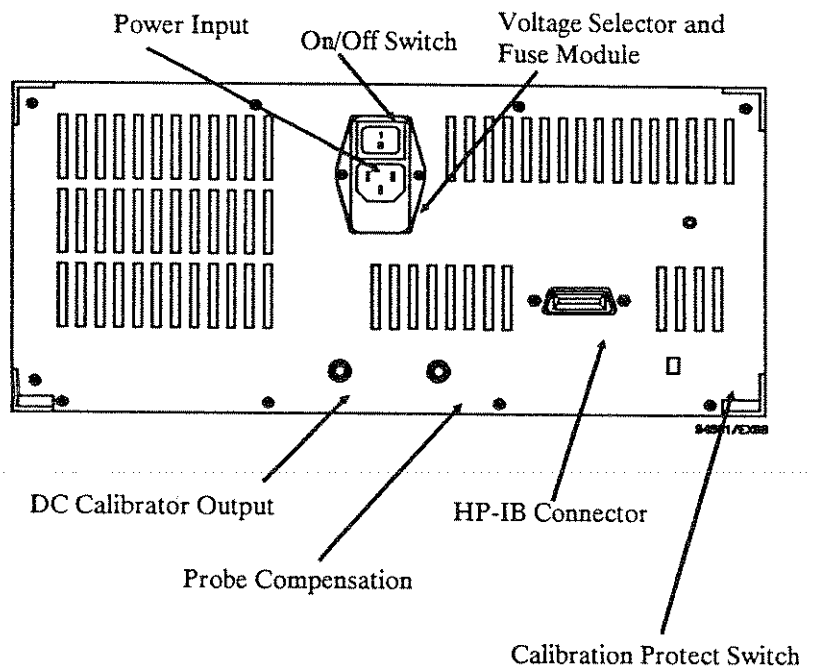

Figure 2-1. HP 54504A Rear Panel

HP 54504A
Front-Panel Reference

Instrument Setup
2-3

Selecting Line Voltage The fuse module is set at the factory to the line voltage used in the country of destination. Check the setting of the fuse module to verify it is in the correct position for the voltage to be used. If the setting needs to be changed, use the following procedure.

CAUTION

BEFORE APPLYING POWER TO THE INSTRUMENT, BE SURE THE FUSE MODULE IS SET TO THE CORRECT LINE VOLTAGE POSITION. Severe damage will occur if the line voltage is not properly set.

- Carefully pry at the top center of the module as shown in figure 2-2, until it can be grasped and pulled out.
- Pull the fuse module out and reinsert it with the arrows properly aligned.

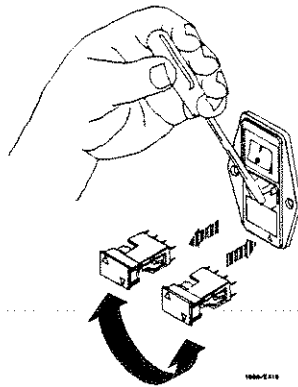

Figure 2-2. Selecting Line Voltage

Verifying the Fuse If it is necessary to check or change fuses, remove the fuse module and look at each fuse for its amperage and voltage ratings.

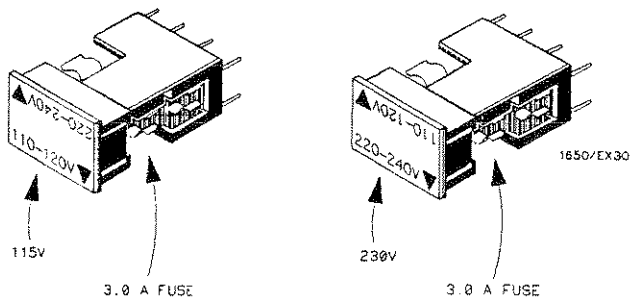

Figure 2-3. Checking for the Correct Fuse

Power Cord The HP 54504A is a Safety Class 1 instrument with an exposed chassis that is directly connected to earth via the power supply cord to meet IEC Standard 348. This instrument is provided with a three-wire power cable. When connected to an appropriate AC power outlet, this cable grounds the instrument cabinet. The type of power cable plug shipped depends on the country of destination. See figure 2-5 for available power cords.

Line Switch The line switch is located on the rear panel. Turn on the oscilloscope by pressing 1 on the rocker switch. The rocker switch is labeled 1 and 0, corresponding to on and off.

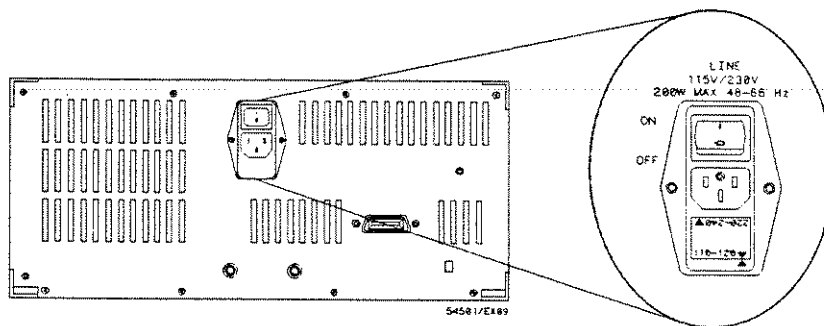









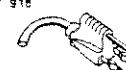

Figure 2-4. Line Switch

HP 54504A
Front-Panel Reference

Instrument Setup
2-5

PLUG TYPE	CABLE PART NO.	PLUG DESCRIPTION	LENGTH IN/CM	COLOR	COUNTRY
OPT 900  250V	8120-1351 8120-1703	Straight *BS1363A 90°	90/228 90/228	Gray Mint Gray	United Kingdom, Cyprus, Nigeria, Zimbabwe, Singapore
OPT 901  250V	8120-1359 8120-0690	Straight *NZSS198/ASC 90°	79/200 87/221	Gray Mint Gray	Australia New Zealand
OPT 902  250V	8120-1689 8120-1692 8120-2857	Straight *CEE7-Y11 90° Straight (Shielded)	79/200 79/200 79/200	Mint Gray Mint Gray Coco Brown	East and West Europe, Saudi Arabia, So. Africa, India (Unpolarized in many nations)
OPT 903**  125V	8120-1378 8120-1821 8120-1992	Straight *NEMA5-15P 90° Straight (Medical) UL544	90/228 90/228 96/244	Jade Gray Jade Gray Black	United States, Canada, Mexico Philippines, Taiwan
OPT 904**  250V	8120-0698	Straight *NEMA6-15P	90/228	Black	United States, Canada
OPT 905  250V	8120-1396 8120-1825	CEE22-V1 (System Cabinet Use) 250V	30/75 96/244	Jade Gray	For interconnecting system components and peripherals United States and Canada only
OPT 906  250V	8120-2104 8120-2290	Straight *SEV1011 1959-2450* Type 12 90°	79/200 79/200	Mint Gray Mint Gray	Switzerland
OPT 912  320V	8120-2956 8120-2957	Straight *DHCR 107 90°	79/200 79/200	Mint Gray Mint Gray	Denmark
OPT 917  250V	8120-4211 8120-4600	Straight SABS164 90°	79/200 79/200	Jade Gray	Republic of South Africa India
OPT 918  100V	8120-4753 8120-4754	Straight Mini 90°	90/230 90/230	Dark Gray	Japan

Rev. 1/19/98

HP100019

*Part number shown for plug is industry identifier for plug only. Number shown for cable is HP part number for complete cable including plug.

**These cords are included in the CSA certification approval of the equipment.

E=Earth Ground

L=Line

N=Neutral

Figure 2-5. Available Power Cords

Intensity Control Once the oscilloscope has been turned on, the display intensity can be adjusted, if necessary. The intensity is adjusted with the Display Intensity control on the rear panel.

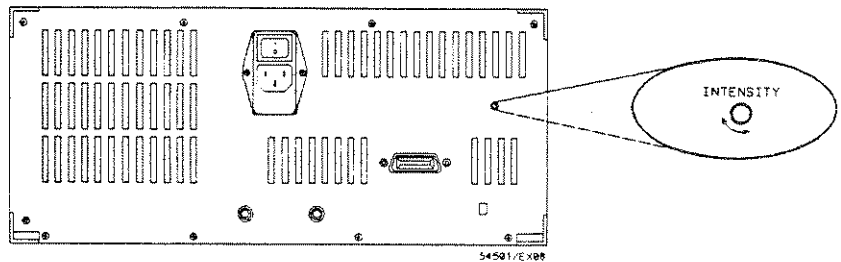

Figure 2-6. Intensity Control

Air Flow Requirements The HP 54504A must have unrestricted air flow for the fan and ventilation openings in the rear panel. The HP 54504A may be stacked under, over, or between other instruments provided the other instruments are adequately cooled.

Connecting External Equipment

The HP 54504A is equipped with an HP-IB connector on the rear panel. This allows a direct connection to an HP-IB compatible printer, plotter, or external controller.

Connect an HP-IB cable to the oscilloscope and any HP-IB compatible device. Tighten the HP-IB cable with the captive screws of the cable to eliminate the potential of an inadvertent disconnection.

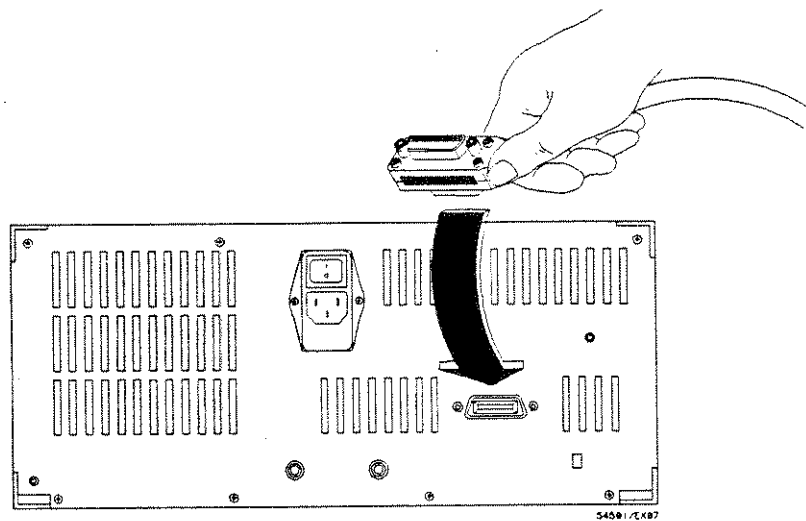

Figure 2-7. Connecting External Equipment

The HP 54504A must be properly addressed to communicate with the connected device. The HP 54504A HP-IB address is set in the HP-IB submenu. See Chapter 12 for detailed information about the HP-IB submenu.

Introduction to the Front Panel

This chapter describes the functional sections of the HP 54504A front panel. The explanation of each area also contains their interaction with each other and provide a basis for applications and usages.

The front panel is separated into six functional areas.

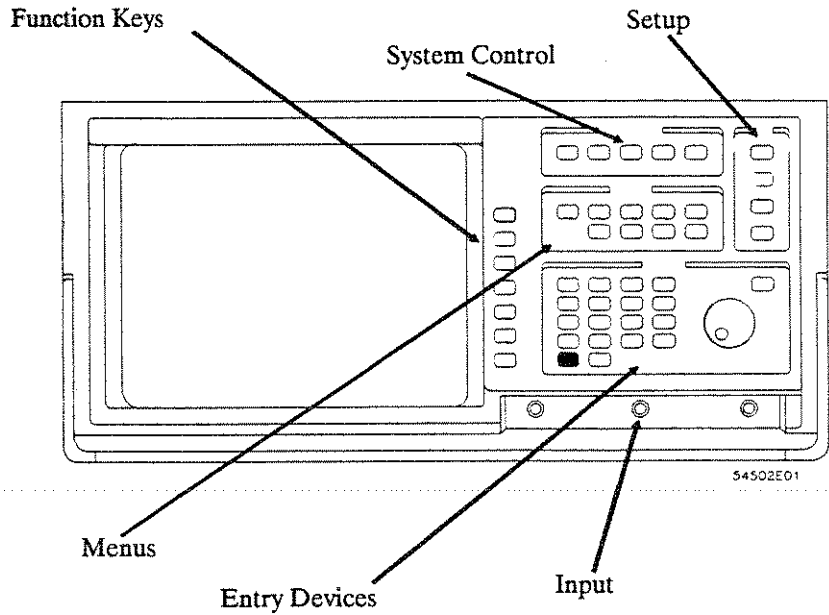

Figure 3-1. HP 54504A Front Panel

System Control

The SYSTEM CONTROL keys are located along the top of the oscilloscope to the right of the display. This section controls the following functions:

- Dynamic display features
- Selecting local control
- Activating hardcopy

Selection of any key in the SYSTEM CONTROL section causes the oscilloscope to execute that command immediately.

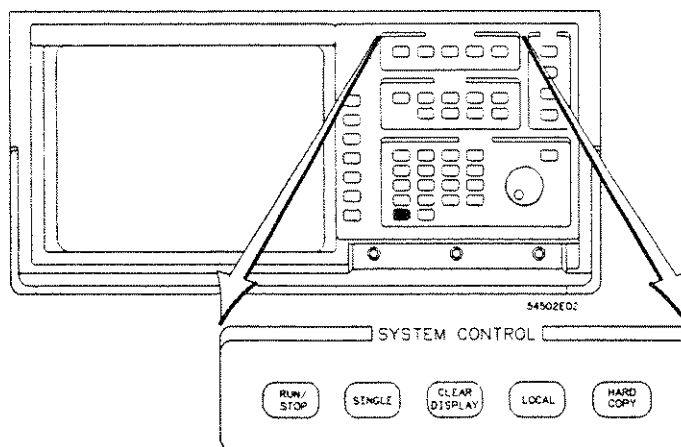

Figure 3-2. System Control Section

RUN/STOP Key The RUN/STOP key toggles the acquisition status of the HP 54504A. If the oscilloscope is currently *running* (current status is displayed in the top left corner of the display in the message field) the instrument is placed in the *stopped* mode. In this mode, normal acquisition is stopped and the last acquired data is displayed. If the oscilloscope is stopped, it is immediately changed to another mode (i.e. *running*, *awaiting trigger*, *auto-trigger*, etc).

SINGLE Key The SINGLE key activates the acquisition system for one trigger event. One acquisition is made, displayed and then the data acquisition and display cycle is stopped. This single acquisition is superimposed on the current displayed data. If the display has been cleared before the SINGLE key is pressed, only one acquisition is displayed.

CLEAR DISPLAY Key The CLEAR DISPLAY key clears the display and resets all associated measurements. If the oscilloscope is in the stopped mode, all data that is currently displayed is erased. If the oscilloscope is *running*, all data is erased, however, new data is displayed on the next acquisition. The RUN/STOP and SINGLE keys are not affected.

The RUN/STOP, SINGLE, and CLEAR DISPLAY keys have a relationship that make it possible to manipulate data acquisitions and view one, two, or several acquisitions. It is possible to stop acquiring, clear the display and capture one acquisition for evaluation. The display can be cleared while acquiring to capture new data. The acquisitions can be manipulated with these three keys and other keys and settings are not affected.

LOCAL Key The LOCAL key sends a return to local control message to the HP-IB interface and returns control to the front panel. This key can be locked out if a local lockout command is executed over the HP-IB.

This is the only active front panel key while the oscilloscope is in remote operation, if it has not been locked out.

HARDCOPY Key The HARDCOPY key executes an immediate hardcopy of the currently displayed data on a compatible plotter or graphics printer and stops all other oscilloscope functions while printing.

The oscilloscope must be in talk only, and the hardcopy device must be in listen always. Setup of the hardcopy options are accessed in the HP-IB submenu (see Chapter 12, "Utilities Menu.").

Selection of any key aborts the hardcopy action.

Setup

The **SETUP** section of the front panel controls subsystems for proper display of input data. This section controls display information:

- **AUTOSCALE** for automatic scaling of the waveform display area
- **SAVE** and **RECALL** setups
- Quick access to channel, function, and trigger information on the **SHOW** screen

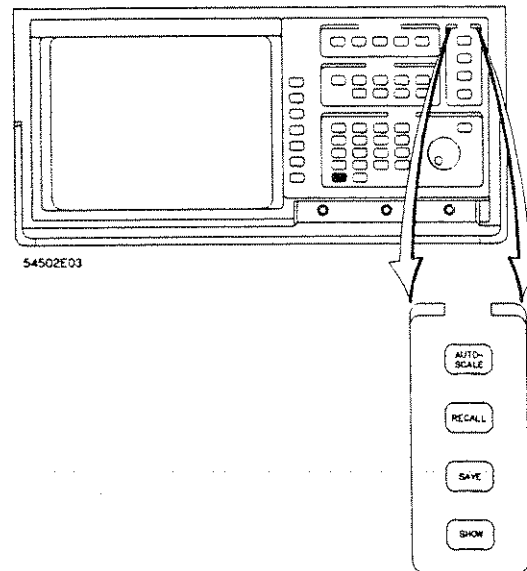

Figure 3-3. Setup Section

AUTOSCALE Key This key causes the oscilloscope to evaluate all input signals and set the correct conditions to display the signals. When AUTOSCALE is pressed the following conditions are set:

- Vertical sensitivity on all channels (if applicable)
- Vertical offset on all channels (if applicable)
- Trigger edge mode, positive slope, and proper trigger level for the trigger source
- Sets to minimum persistence when in normal display and repetitive acquisition modes
- Sweep speed of displayed channel

In addition, autoscale includes a soft reset:

- Displays one screen
- Turns $\Delta t/\Delta V$ markers off
- Turns all measurements off
- Turns measurement limit test off
- Turns waveform math functions off
- Turns timebase window off
- Turns waveform/pixel memory display off
- Turns filter off (realtime acquisition mode)
- Turns display record to normal
- Turns statistics off
- Turns connect the dots off
- Sets holdoff to 40 ns (minimum value)

The previous oscilloscope settings are stored in volatile memory RECALL 0. To recall settings, press RECALL 0.

RECALL Key The RECALL key has three primary functions:

- By pressing the RECALL key and then selecting 1, 2, 3, or 4, the HP 54504A executes a recall of a previously saved setup configuration.
- The oscilloscope automatically saves the current configuration before executing an autoscale, recall, or setting up ECL/TTL presets. RECALL 0 is an undo of these actions. Waveforms cannot be saved to RECALL 0.

- **RECALL CLEAR** executes an instrument reset and returns the HP 54504A to default/power-up settings. The oscilloscope does not perform power-up self-tests (see Instrument Reset).

SAVE Key The SAVE key immediately stores the oscilloscope setup configuration in volatile memory. Press SAVE, and then select a save register: 1, 2, 3, or 4. An advisory is displayed above the waveform display area indicating the setup configuration has been saved.

SHOW Key The SHOW key accesses the following information:

1 2.00 V/div
offset: 50.00 mV

4 40.0 V/div
offset: -1.000 V

f2 1 + 1
4.00 V/div
offset: 100.0 mV

1 50.00 mV
54501/WF 18

- Channel scaling
- Channel offset
- Channel coupling
- Probe attenuation
- Trigger source
- Trigger level
- Math function operation
- Math function scaling
- Math function offset
- Memories

Pressing the SHOW key toggles between the currently selected menu and the SHOW screen.

This screen presents the most complete and detailed instrument setup information. Select this screen before making a hardcopy and all SHOW screen information is included on the hardcopy.

Menus

The MENUS section consists of nine keys:

- TIMEBASE
- CHANNEL
- TRIG
- DISPLAY
- $\Delta t/\Delta V$
- WFORM MATH
- WFORM SAVE
- DEFINE MEAS
- UTIL

Each of these menus is discussed in the following chapters.

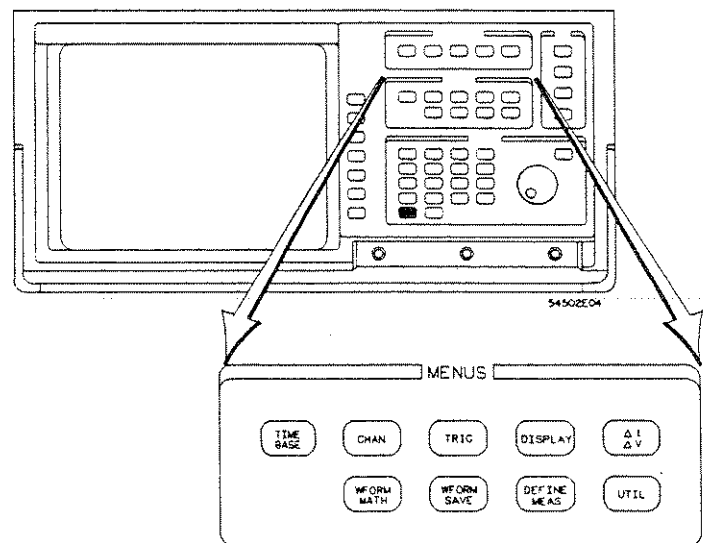

Figure 3-4. Menu Section

Entry

The ENTRY device section contains a multi-function numeric keypad, a selection knob, and a FINE key.

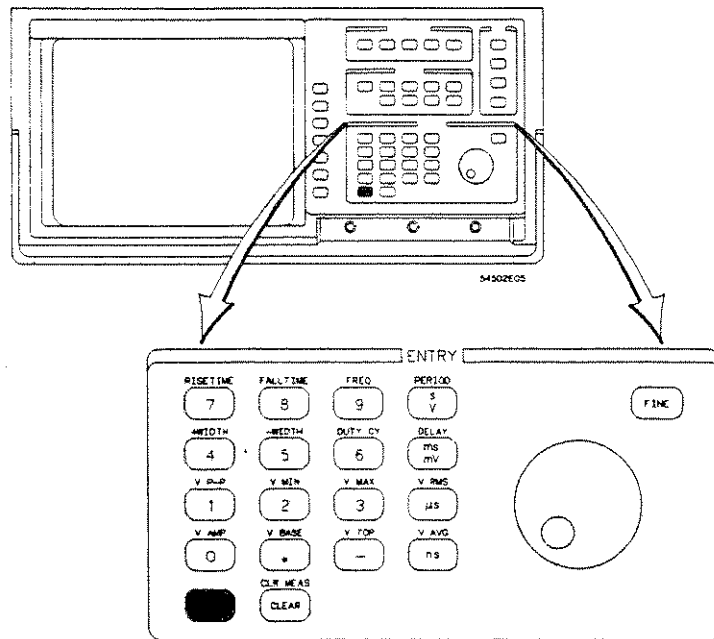

Figure 3-5. Entry Section

Numeric Keypad

The keypad is for direct numeric input. To input known values directly, press the associated softkey to activate the desired field on screen, and then select the units with the numeric keys. For example, to set the vertical sensitivity to 500 mV:

- Ensure V/div in the Channel menu is the active field (displayed in fullbright)
- Press 5, 0, 0, mv in sequence.

The blue key on the numeric keypad selects the alternate function when pressed before the key. The alternate function of the keys on the right column are measurement units. The CLEAR key clears any selections made for the active field.

Knob The knob changes values within each function. It increments, decrements, or toggles the selection in the active field or function. The current selection is displayed in fullbright in the displayed menu area and can be changed with the knob.

FINE Key The FINE key changes the increment and decrement sequence. Instead of sequencing in the normal sequence, the values increment/decrement in more precise values. Use this feature when the normal sequence is too coarse for precision measurements or settings.

When the HP 54504A is operating in the fine mode, the word *fine* is displayed in the lower right corner of the CRT.

Input

The input section consists of connectors for signal input. Channel inputs 1 and 2 select 1 M Ω or 50 Ω input impedances and each is shunted by approximately 7 pF at the input BNC with a maximum input voltage of 250 V.

Display

The display section contains the screen and function keys.

The vertical column on the right side of the screen is the function display. The functions that are displayed at any one time will correspond to a softkey. The softkeys select any function or field that is displayed in half-bright.

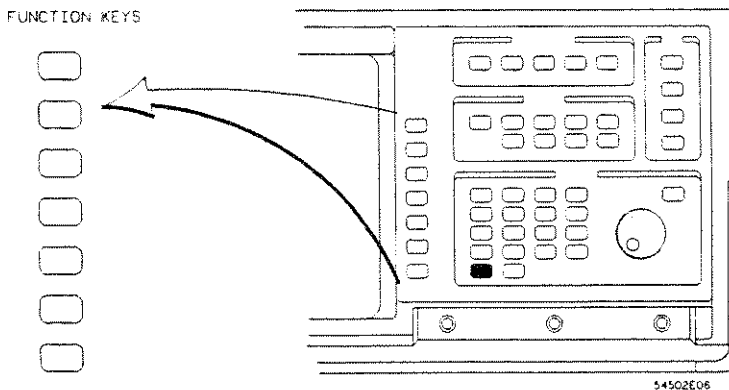

Figure 3-6. Function Keys

- Numeric key fields displayed in full-bright video are changed by either numeric keys on the keypad or the knob. When these functions are not active, they are displayed in half-bright; when displayed in full-bright they are active.
- Non-numeric fields displayed in half-bright video toggle with the corresponding function key. These fields are displayed in half-bright, but are active for the function keys.

Instrument Reset

The HP 54504A has two methods of instrument reset.

- Key-down power up is a hard reset of the oscilloscope. It is done by pressing and holding any front panel key while cycling power. If input signals are not present, the oscilloscope will power-up displaying a baseline in the SHOW screen and set to all default settings (see Table 3-1).
- RECALL CLEAR performs a soft reset of the oscilloscope. All default conditions are set (see Table 3-1). RECALL CLEAR is the same as a key-down power-up except the previous menu selections are retained.

Table 3-1. Reset Default Conditions

Timebase Menu	
reference	cntr
Time/Div	100 μ s
delay	0.00 s
timebase window	off
repetitive/realtime	realtime
Channel Menu	
Channel 1	on
Channel 2	off
Volts/Div	500 mV
offset	0.00
coupling	dc
impedance	1 M ohm
probe attenuation	1.000:1

Table 3-1. Reset Default Conditions (continued)

Trigger Menu	
Mode	edge
source	Channel 1
level	0.0 V
slope	positive
holdoff	40 ns
Display Menu	
Mode	norm
# of avg	8
persistence	minimum
# of screens	1
off/frame/axes/grid	axes
connect dots	off
display record	norm
filter	off
$\Delta t/\Delta V$ Menu	
Δt markers	off
ΔV markers	off
Waveform Math Menu	
f1	off
f2	off
chan/mem	chan 1
operator	+
chan/mem	chan 1
function sensitivity	1.00 V/div
function offset	0.0 V
Waveform Save Menu	
waveform/pixel	waveform
nonvolatile	m1
display	off
source	chan 1
Define Meas Menu	
meas/def/limit	meas
continuous	on

Timebase Menu

Introduction to the Timebase

This chapter contains a description of the TIMEBASE menu and how the entire horizontal display and parameters are controlled with this menu.

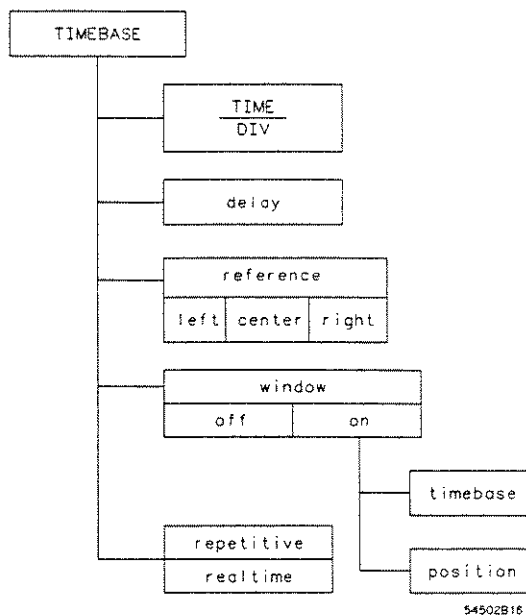
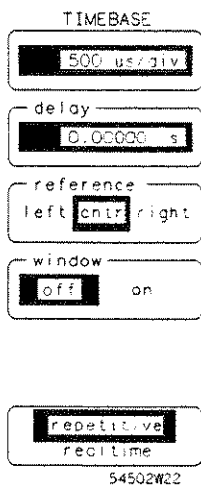

Figure 4-1. Timebase Menu

Time/Div Key

The time/division function controls the sweep speed on the horizontal axis from 1 ns/div to 5 sec/div. The main Timebase is incremented and decremented in a 1-2-5 sequence. The FINE key does not affect the timebase settings.

When using slow sweep speeds (200 ms/div to 5 sec/div) there are two acquisition modes available. These two modes are regular acquisition and scroll mode.

Regular acquisition occurs when in triggered mode with pre-trigger time on-screen, i.e. some of the data occurs before the trigger point.

Triggered acquisitions are not displayed until all data is available (similar to normal acquisitions) to display. As data is being sampled, the advisory **n s to initialized** is displayed while pre-trigger data is collected and **n s to complete** is displayed while post-trigger data is collected. This message indicates the time needed to complete acquisition where **n** is the remaining time (in seconds, **s**) and continues to countdown until the time has elapsed. The advisory **running** is displayed as the write cycle to the screen is executed and displayed data is updated. At 5 sec/div, 50 seconds are needed for each acquisition.

The other acquisition mode in these ranges is scroll mode. The scroll mode has two forms: *auto-triggered scroll* and *triggered scroll*.

- *auto-triggered scroll* is used in auto trigger. The oscilloscope acquires and displays data in the auto triggered scroll mode and displays each data sample as it is acquired. As it samples and displays, a message is shown at the top left corner of the display indicating this acquisition mode.
- *triggered scroll* (when all information on the screen is after the trigger), acquisition is not started until after the trigger occurs. The oscilloscope then displays the data as in auto-triggered scroll, putting each new point on the screen as it is acquired. In this way, a stable triggered waveform is displayed as it is acquired.

In these scroll modes, a scroll indicator (small dot) moves across the top of the waveform display area to show where new samples are being plotted.

Any key entry during the scroll mode interrupts the acquisition and causes errors in the displayed waveform.

delay Key

Selecting **delay** assigns delay as the active function. When delay is set to 0 the trigger event occurs at the delay reference point. Positive delay indicates time after trigger and negative delay indicates time before trigger. Therefore, a delay setting of -50 ns indicates that the trigger event occurs 50 ns after the delay reference point.

$$\text{reference} = \text{trigger event} + \text{delay}$$

reference Key

The **reference** key changes the delay reference point to one of three reference points:

- left
- cntr (center)
- right

If delay is set to 0, the reference point consists of pre-trigger data to the left and post-trigger data to the right.

NOTE

The time from trigger changes with the delay setting and is displayed at the bottom of the waveform area at the left, center, and right of the display.

Window Key

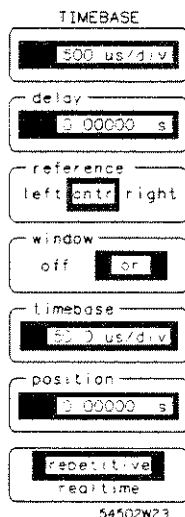

The window function turns on an expanded timebase and the oscilloscope is placed in a multiple screen mode. The normal waveform, in the original timebase setting, is displayed in the top screen with markers, vertical dotted lines, that enclose a portion of the displayed waveform. Only the enclosed portion, between the markers, is displayed in the bottom screen.

Note

The displayed timebase information under the waveform display area is windowed timebase information. When the window is on all measurement results and information are windowed information.

This feature is much the same as the delayed sweep on an analog oscilloscope, however, with the dual screen the portion of the normal waveform can be viewed simultaneously.

The **timebase** of the windowed waveform can be varied from equal to the normal timebase to 1/20 of the normal timebase. This equates to 1/2 of a major division.

When the **reference** position is set to left, only the right window marker moves when the window timebase is changed. When reference is set to right, only the left marker moves, and when center is selected, both markers move. This maintains a specified time reference without changing any timebase settings and the ability to move the reference points for better viewing.

When the window function is enabled, two selections are available for placing and sizing the window:

- Window timebase
- Window position

timebase Key This key is activated only when the window function is turned on and sets the timebase in the window.

As the window timebase is increased the time in the window displayed in the bottom screen is increased. The markers in the top screen move farther apart. When the window reaches full screen the main timebase and the window timebase become equal. As the window timebase is decreased the markers move closer together.

position Key This key is activated only when the window function is turned on.

The window can be placed anywhere on the normal waveform. By adjusting the window position you can see any part of the waveform.

Note

When window timebase = time/division, there is only one possible setting for window position. Turning the knob will have no effect.

repetitive/ realtime key

The bottom function key selects one of the two acquisition modes used by the HP 54504A:

- repetitive acquisition
- realtime acquisition

See Chapter 7, "Display Menu" for more on acquisition modes.

repetitive mode The repetitive mode sets the HP 54504A to acquire data in the random repetitive mode (see *Feeling Comfortable With Digitizing Oscilloscopes*). In this mode, the oscilloscope samples data continuously and reconstructs a waveform after many data points have been attained; this mode is useful when viewing a continuous waveform.

In the repetitive mode:

- The HP 54504A displays data collected from multiple acquisitions from either or both channel inputs.
- Data from multiple acquisitions can be averaged to generate a display (the **avg** key is activated when in the *repetitive avg* mode).
- Data from each acquisition can be displayed for a definable period of time (persistence).
- Waveform records are established at 501 data points on the 5 ns - 5s/div ranges, 401 data points on the 2 ns/div range and 201 data points on the 1 ns/div range.

realtime mode When in realtime mode the HP 54504A displays data collected during successive single-shot acquisitions from either or both input channels. The HP 54504A can make a single-shot capture simultaneously on both channels.

Each single-shot acquisition record is 2001 data points. When viewing a 10 division display, 501 data points are displayed. The HP 54504A can be set for viewing the entire 2001 data points with the extended display record function. See chapter 7, "Display Menu," **display record** key.

Window Exercise

For demonstration on how the window is useful in making measurements and viewing the windowed waveform, perform the following exercise.

Setting the Input Signal For this exercise use a simulated ECL input signal, a 1 volt, 2 kHz square wave with adequate offset to display the signal at midscreen.

Set up an HP 8116A Pulse/Function Generator or another signal generator that is capable of the same signal.

- Mode = NORM
- Set AMP = 1.00 V
- Set FRQ = 2 kHz
- Set DTY = 50%
- Set OFS = -1.20 V
- Set signal to squarewave

Setting the Oscilloscope

Input this signal to channel 1 on the HP 54503A and disconnect any inputs to any other channel.

- Press AUTOSCALE (see Figure 4-2).

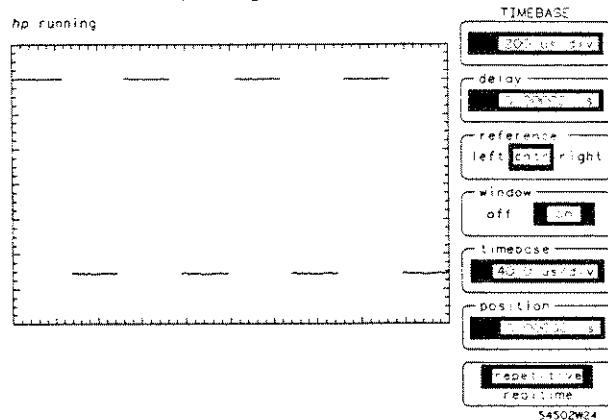

4-2. Input Signal for Window Viewing

- Select the TIMEBASE menu key.
- Press the selection key to turn on the window function.
- Set the window timebase to 40 $\mu\text{s}/\text{div}$ (see Figure 4-3).

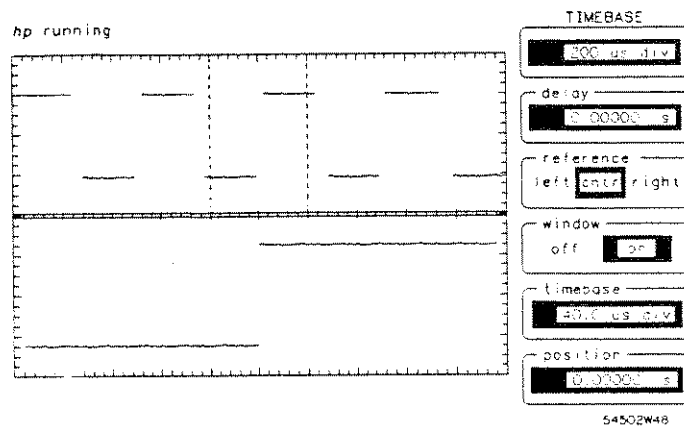

4-3. Input Signal with Window Turned On

Note

The timebase factors under the waveform display area have changed to reflect the window.

Viewing the Window

The timebase width in the window is $40 \mu\text{s}$ (1/20 of 1 ms) with the trigger point at center reference and 0 time delay. The knob has the following actions when these fields are active:

- **time/division field (top)** - the knob changes both timebases and displayed waveforms will change until window timebase equals the normal timebase.
- **delay** - the knob moves the window and waveform sideways while maintaining the same size. This allows viewing of the same section of the waveform at a different point in time. The two timebases will not change.
- **window timebase** - the knob changes only the window timebase. The range is from 1/20 of the normal timebase to equal the normal timebase.
- **window position**, as you turn the knob, the window changes position on the normal waveform allowing you to view different sections of the waveform.

Introduction to Channels

The channel menu is a two-level menu and controls the vertical operation of the HP 54504A. This chapter describes the use of the two input channels, including vertical sensitivity, offset, coupling, attenuation and preset levels.

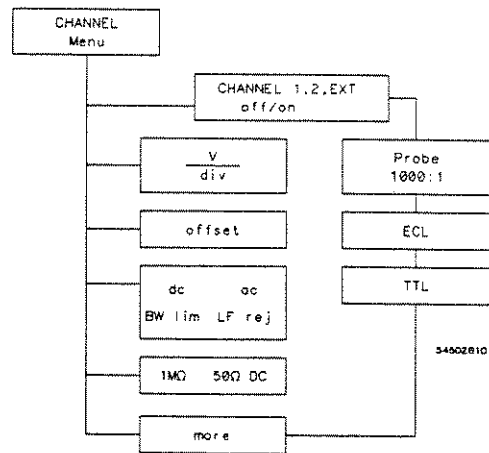

Figure 5-1. HP 54504A Channel Menu

CHANNEL Key

The top key in the first channel menu is for channel selection. The key toggles channels 1 and 2. When a channel is selected (highlighted in inverse video) it can then be turned on. When a channel is turned on the small circle immediately below the channel number is highlighted.

Note

It is possible to have a channel turned on and view while being in the vertical control menu of another channel. When making changes, ensure you have the proper channel and function selected and you are changing the channel you intend to change.

Vertical Sensitivity Key

The vertical sensitivity key is the third key from the top in the channel menu. The field itself is not labeled, however, the current volts/division is displayed with the units of the current selection. When this function is selected, either of the entry devices can be used for data entry.

The range of the vertical sensitivity for the HP 54504A is from 2 mV/division to 5 V/division. Vertical sensitivity changes in a 1-2-5 sequence in the normal mode or can be changed in the fine mode.

offset Key

When **offset** is selected, 0 volts is on the vertical midpoint of the display. Offset is the voltage level at mid-screen.

Offset moves the displayed signal up or down, similar to the vertical position adjustment on an analog oscilloscope. However, offset on the HP 54504A has a range of ± 16 divisions from center screen.

Coupling Key

The coupling key has several selection variables:

- dc
- dc BW lim
- ac
- ac BW lim
- ac LF reject

When dc is selected, $1\text{ M}\Omega$ and 50Ω DC input impedances are available as choices for input impedance.

Bandwidth limit is switchable with the different combinations of the coupling function. Bandwidth limit reduces the effective dc bandwidth to $\approx 30\text{ MHz}$. Ac coupling provides a high-pass filter rejecting frequencies below $\approx 90\text{ Hz}$. The LF reject provides a high-pass filter rejecting frequencies below $\approx 450\text{ Hz}$. Bandwidth limits and LF reject filters reduce the noise in the vertical path as well as the trigger path.

Input Impedance

Input impedance is $1\text{ M}\Omega$ for ac coupling and selectable $1\text{ M}\Omega$ or 50Ω dc when dc coupling is selected in the coupling function.

more Key

The **more** key toggles between the two levels of the channel menu.

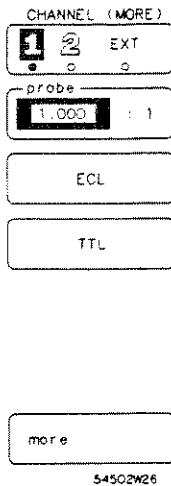

54502W26

probe key

The **probe** key selects probe attenuation with a range of 1000:1 to .9000:1. Attenuation is adjusted by either knob or entry keypad. When the knob is in coarse mode, adjustments are incremented or decremented in the 1-2-5 sequence. When in fine mode adjustments are in 0.1 increments.

Probe attenuation affects scaling factors for the display, not sensitivity at the input.

Probe attenuation is calibrated in the Utility menu. See chapter 12 for information on probe calibration.

Attenuation factors are saved with the front panel setup.

ECL Key

The ECL key sets the oscilloscope to levels optimized for ECL circuits:

- V/Div: 200 mV/div
- offset: -1.3 V
- coupling: dc
- Trigger level: -1.3 V
- Trigger slope: no change

RECALL 0 returns the menu to the previous settings.

TTL Key

The TTL key sets the oscilloscope to levels optimized for TTL circuits:

- V/Div: 1 V/div
- offset: 2.5 V
- coupling: dc
- Trigger level: 1.4 V
- Trigger slope: no change

To return to the previous settings press RECALL 0.

Introduction to the Triggers

The trigger modes of the HP 54504A provide many distinctive techniques to trigger and capture data. The triggering capabilities range from simple edge triggering to logic triggering on multiple signals.

This chapter contains descriptions of the triggering modes, and explanations on how to use them, and exercises detailing some real life applications. The HP 54504A has five triggering modes:

- Edge
- Pattern
- State
- Delay
- TV

Trigger Mode Interaction

The trigger level (threshold) for each channel is set in the edge trigger menu and is independent for each channel. It is carried over to all other modes, except the TV trigger mode. These levels are important settings because the high and low levels in the pattern, state, and delay modes are defined as being greater than or less than the trigger level.

The level for TV trigger mode is a special case and is set in the TV trigger menu.

Edge Trigger Mode

The edge trigger mode has the following selections:

- Trig'd/auto
- Trigger source
- Trigger level adjust
- Slope
- Noise reject
- Holdoff

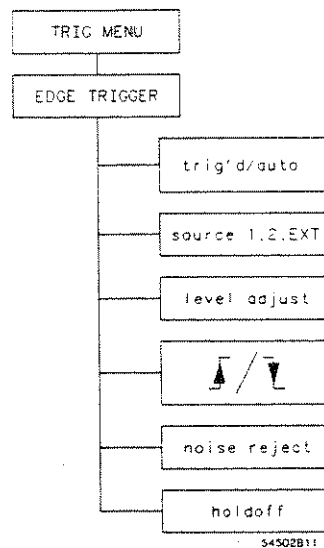

Figure 6-1. Edge Trigger Menu

trig'd/auto Key The **trig'd/auto** selection toggles between the two trigger modes. The current selection is displayed in inverse video. This field is available in all trigger menus.

In the **trig'd** mode, the oscilloscope does not acquire data until all of the trigger requirements are satisfied. In the **auto** mode, if a trigger is not found, a trigger is generated and acquired data is displayed. A status message is displayed in the upper left corner of the screen.

If the oscilloscope is auto-triggered and the sweep speed is 200 ms/div, 500 ms/div, 1 s/div, 2 s/div, or 5 s/div, it operates in the auto-triggered scroll mode and displays data points as they are acquired (see Chapter 4, "Timebase Menu").

source Key The **source** key selects the trigger source. The options are channels 1 or 2, or external trigger. The current selection is highlighted in inverse video.

level Key The **level** key sets the trigger level. The range on this function is ± 12 divisions from center. It provides flexibility for setting exact triggering points and specifies levels used in the more sophisticated triggering modes.

slope Key This field is not labeled, however, the available selections are graphic representations of the rising edge and falling edge. The current selection is highlighted in inverse video.

noise reject Key Turn **noise reject** on for triggering on noisy signals without the problem of false triggering.

holdoff Key Pressing the **holdoff** key assigns the entry devices to control holdoff. Holdoff disables the trigger circuit for a selectable time period or number of events after the trigger event. Holdoff is selected in 20 ns time increments, from 40 ns to 320 ms or in number of events from 2 to 16 000 000. Time and event (number of patterns, **patrn**) are toggled with the knob.

Holdoff Exercise

This exercise sets up the oscilloscope and a signal generator to view some of the features of the edge trigger. Holdoff is used to gain a stable trigger. This technique is not necessary for most applications and waveforms, however, for many non-recurring and irregular waveforms it is useful.

Instrument Setup Follow the instructions for setting up the signal generator. The signal for this exercise is a burst pattern with two positive cycles that repeats every 5 μ s. Use an HP 8116A Pulse/Function Generator with the burst option or a signal generator capable of the same signal.

Make the following settings:

- MODE: I.BUR
- RPT: 5.00 μ s
- BUR: 2
- FRQ: 1 MHz
- DTY: 50%
- AMP: 1 V
- OFS: -200 mV
- Set the signal for a square wave.

Oscilloscope Setup Connect the the signal generator to the channel 1 input and disconnect all other inputs.

- Press **AUTOSCALE** (see Figure 6-2).

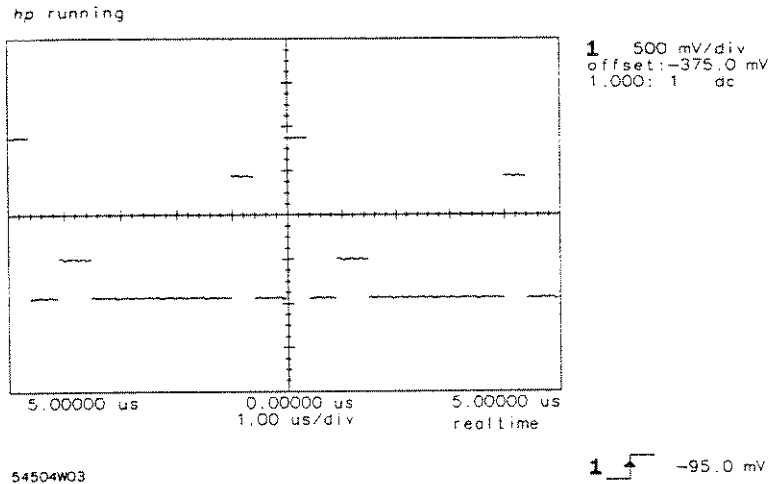

Figure 6-2. Two-Burst Waveform after Autoscale

- Select the **TIMEBASE MENU**.
- Set the sweep speed to **500 ns/div**.
- Set acquisition mode to **repetitive**.

The HP 54504A sets up the display parameters. It is now attempting to trigger on the first rising edge of the two cycle burst.

- Enter the **TRIGGER MENU** and press the slope key.

The oscilloscope is now triggering on the first falling edge of the two cycle burst. Press the slope key again to trigger on the positive edge.

Note

The signal generator is set for two 500 ns pulses. The display on the oscilloscope appears to have three pulses. This is an unstable trigger condition. The following steps explain this condition and how to overcome it.

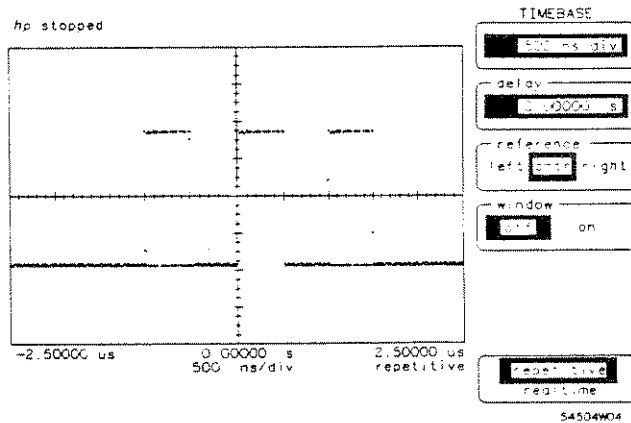

6-3. Two-burst Pulse

- **Determining holdoff time.** Change the time/div setting to 2 μ s/div. Press RUN/STOP (STOP), CLEAR DISPLAY, and SINGLE. This shows the period of the waveform. Since the oscilloscope is recognizing two valid trigger events (edges, in this case) of the burst, the holdoff time needs to be set such that it ignores the second pulse in the burst. Using Δt markers, the second edge can be found to be about 1 μ s from the first edge. (See Chapter 8, "Delta t/Delta V Menu.")
- Press the holdoff key.
- Set holdoff to 1.04000 μ s, with keypad or knob.

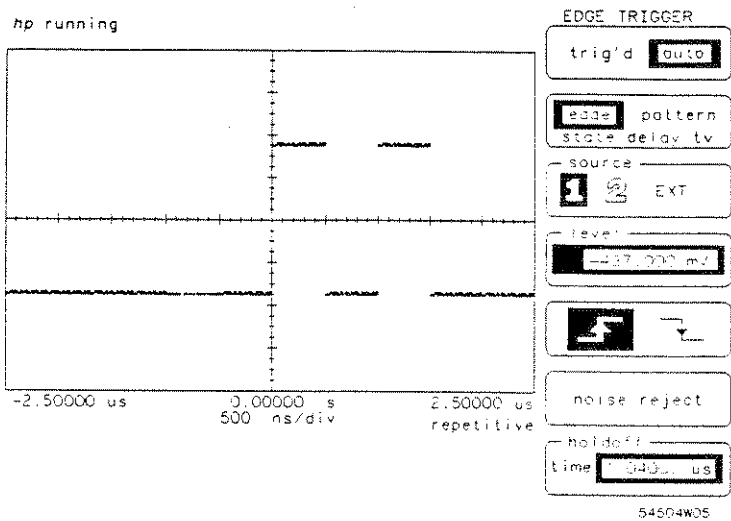

Figure 6-4. Two-Burst Pulse w/Stable Trigger

The input signal to the oscilloscope has two 500 ns pulses. On the first rising edge a trigger occurs and activates the holdoff timer. When the holdoff time (1.04000 μ s) has elapsed, the oscilloscope looks for another trigger. The oscilloscope triggers on the first rising edge of the second burst. Each trigger event occurs on a different pulse, and is consequently an unstable condition.

By adjusting holdoff to wait until the rising edge of the second pulse passes, the oscilloscope triggers only on the first rising edge and the signal is stable. In this case the trigger is stable with approximately 1.04 μ s holdoff.

Pattern Trigger Mode

The pattern mode defines a 3-bit pattern for the oscilloscope to recognize and generate a trigger event. When the inputs satisfy the trigger pattern and conditions, the HP 54504A triggers and displays the desired portion of the waveform.

The pattern mode is very useful for glitch detection because the HP 54504A triggers on a glitch and displays the resulting waveform.

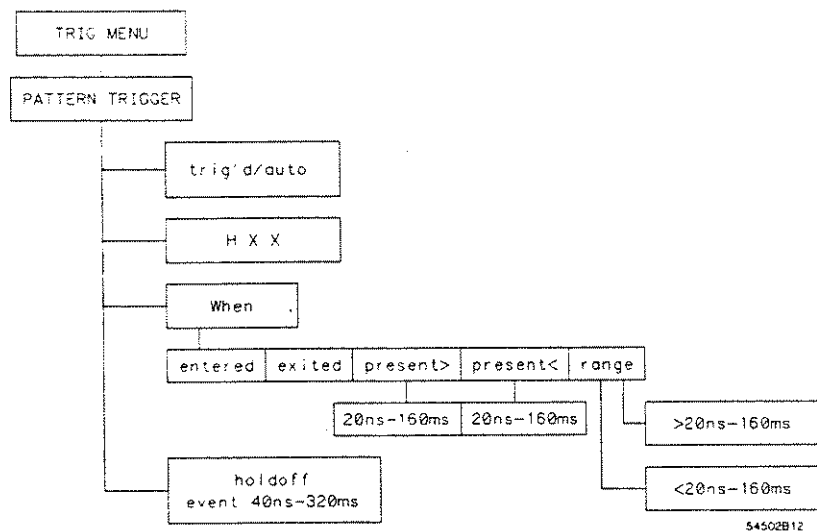

Figure 6-5. Pattern Trigger Menu

pattern Key This is an unlabelled field. The display depicts the 3-bit pattern. The active field is displayed in full-bright and is changed with the knob. The function key changes the bit selection of three levels:

- H – high
- L – low
- X – don't care

The criteria for high is higher than the current trigger level, and low is lower than the current trigger level.

The 3-bit pattern is representative of the two channel inputs and the external trigger.

For example, if the pattern is LXH, the voltage on channel 1 must be lower than the trigger level set for channel 1, channel 2 is don't care so the input level is disregarded, and the external trigger input must be higher than the trigger level set for external trigger. If these conditions are satisfied by the inputs, then the oscilloscope generates a trigger event.

Note

When any channel is not being used in the qualifier pattern, it should be set as don't care. The trigger level is still compared to the no input channel and a high or low is determined. The only true don't care is X.

If the pattern XXX is selected, a trigger event does not occur because a trigger event is not defined.

when Key This key controls five sets of conditions that must be satisfied to generate a trigger event. These conditions are as follows:

- **when entered:** a trigger is generated on the first transition that makes a pattern true. The pattern must be false and go true to generate the trigger.

- **when exited:** a trigger is generated on the first transition that makes the pattern false. The pattern must be true and go false to generate a trigger.
- **when present > :** a trigger is generated when a trigger pattern is true longer than a specified minimum time period. This time period is specified in the next selection key that is activated when present > is selected. The present > time ranges from 20 ns to 160 ms.
- **when present < :** a trigger is generated when a trigger pattern is true less than a specified maximum time period. This time period is specified in the next selection key that is activated when present < is selected. The present < time ranges from 20 ns to 160 ms.
- **range:** this trigger condition is a combination of present < and present > . A trigger is generated when a trigger pattern is true for longer than a specified minimum and shorter than a specified maximum time period. These time periods are specified in the next two selection keys that are activated when range is selected. The first range time setting must be less than the second range time setting.

holdoff Key The holdoff key assigns the entry devices to control holdoff. Holdoff disables the trigger circuit for a selectable time period or number of events after the trigger event. Holdoff is selected in time units, from 40 ns to 320 ms and is incremented in 20 ns intervals or by number of patrn (patterns) from 2 to 16 000 000.

Pattern Trigger Exercise

This exercise demonstrates how to define the 3-bit pattern and how it affects the trigger and the resulting display.

Note

Set the trigger level for each trigger source while in the edge mode. These trigger levels must be set before you go to the pattern mode, or proper triggering may not occur.

Instrument Setup To perform the following exercise use the HP 8116A Pulse/Function Generator, or another function generator capable of producing the same 1 MHz, 1 volt, square wave signal.

Set up the HP 8116A Pulse/Function Generator:

- Mode = NORM
- FRQ = 1.00 MHz
- DTY = 50%
- AMP = 1.00 V
- OFS = -200 mV
- Pulse = square wave

Connect the signal to a BNC tee on channel 1 using a 1-meter coaxial cable. Connect another 1-meter cable from the other side of the BNC tee and terminate in 50Ω to channel 2.

Oscilloscope Setup The extra cable length between channels 1 and 2 provides a time delay between the signals displayed on the oscilloscope. The propagation of a 1-meter coaxial cable is approximately 6 to 7 ns. This time delay is used to demonstrate the HP 54504A triggering capability.

- Press AUTOSCALE.

Set up the HP 54504A as follows:

- Timebase = 10.00 ns/div
delay = 0.00 s
reference = cntr
window = off
acquisition mode = repetitive
- Channel 1
Vertical sensitivity = 400 mV/div
offset = -200.00 mV
dc coupling
input impedance = $1 M \Omega$

- Channel 2
 - Vertical sensitivity = 400 mV/div
 - offset = -200.00 mV
 - dc coupling
 - input impedance = 50 Ω
- Display
 - minimum persistence
 - 2 screens
 - axes
- Trigger
 - Channel 1 level = -200 mV
 - Channel 2 level = -200 mV
 - Set the trigger mode to pattern.

Set the pattern to HLX as follows:

- Press the function key until the first character is highlighted.
- Turn the knob until the highlighted area is H.
- Select the next character in the pattern.
- Continue until all characters are selected in the HLX pattern.
- Press the when key until entered is selected.

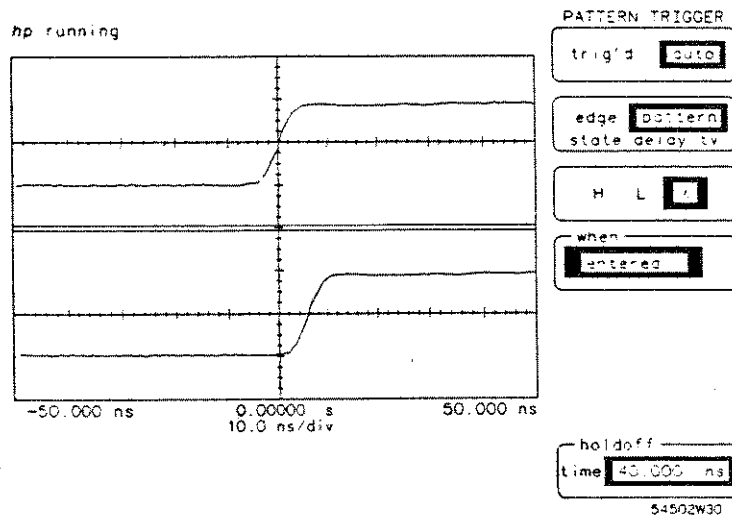

Figure 6-6. HLX when entered Pattern

Channel 1 is displayed in the top screen. To satisfy the conditions of the bit pattern, channel 1 must be high (higher than the channel 1 trigger level) or greater than -200 mV. When the signal on channel 1 goes higher than -200 mV and channel 2 is still low (less than -200 mV) the pattern conditions have been satisfied as the signal is entering the trigger conditions and the HP 54504A triggers.

- Press the when key and change the condition to when exited.

The oscilloscope triggers on the first transition that makes the bit pattern false, in this case when channel 2 goes high.

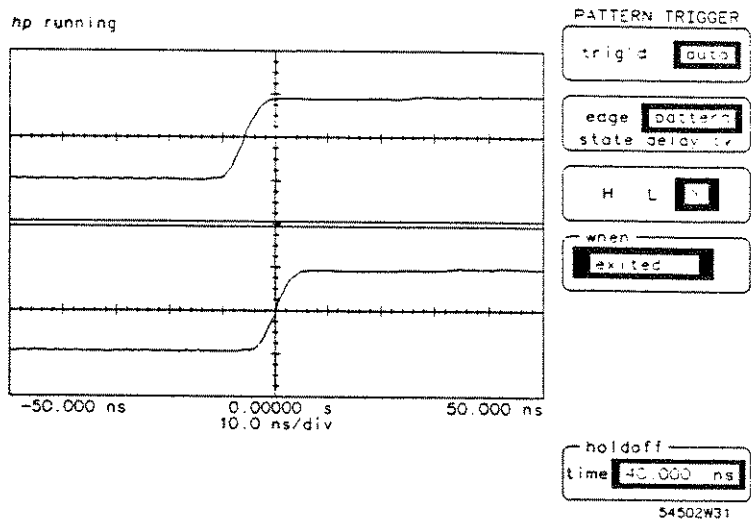

Figure 6-7. HLX when exited Pattern

- Change the bit pattern to HHX and select the entered condition.

To satisfy this bit condition both channels must be high. The oscilloscope does not trigger until channel 2 goes high while channel 1 is high.

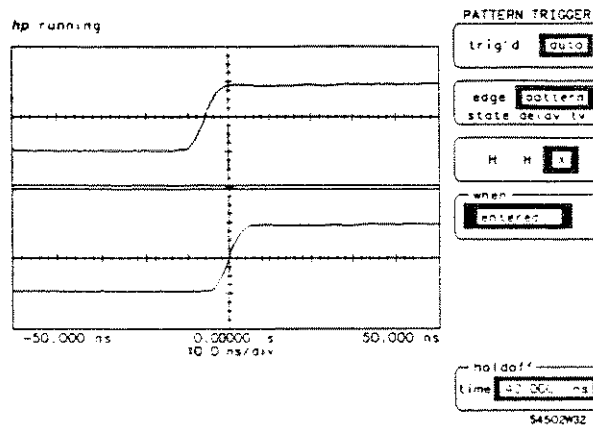

Figure 6-9. HHX when entered Pattern

- Change the trigger condition to when exited.

While channel 2 is still high, when channel 1 goes low the bit pattern is no longer true and the HP 54504A triggers.

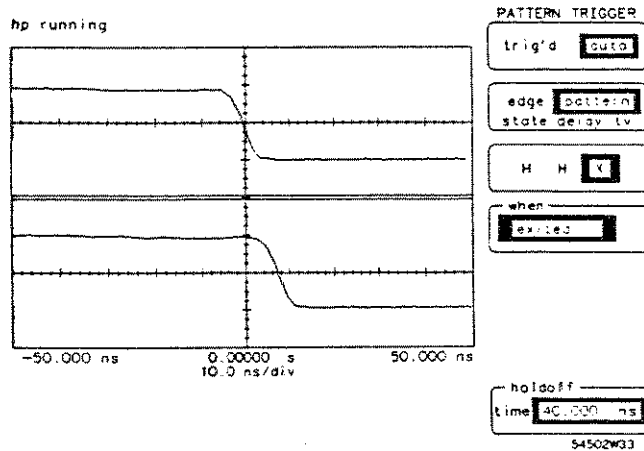
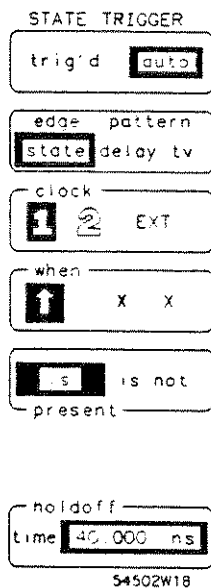

Figure 6-8. HHX when exited Pattern

State Trigger Mode



The state trigger mode is similar to the pattern trigger mode except that one channel is selected as a clock edge and the other two trigger sources define a pattern. When the pattern becomes true the HP 54504A triggers on the next clock edge if the pattern meets setup and hold criteria.

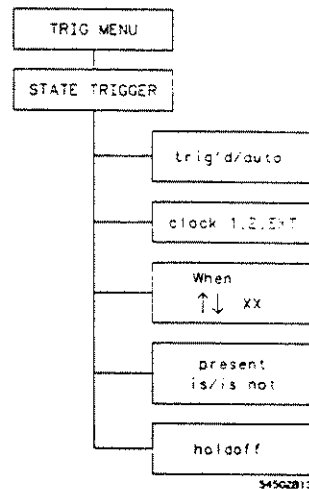

Figure 6-10. State Trigger Menu

The trig'd/auto and trigger mode function keys remain displayed in all trigger modes.

- clock Key** Select any channel to be used as the state clock. Select the channel by pressing the function key until the desired channel is highlighted. The clock selection is reflected in the next field with an arrow, pointing either up for a positive slope or down for a negative slope.
- when Key** The when key depicts the desired pattern. The displayed pattern shows the arrow at the selected clock channel. The other two trigger sources define the logic pattern that must be satisfied to generate a trigger event using the H, L, X convention described in the pattern trigger mode.

To change the pattern:

- Press the function key until the bit to be changed is highlighted.
- Rotate the knob until the desired setting is highlighted.
- Select the arrow to change the trigger slope, if necessary, and turn the knob until the desired settings appear.

present Key A trigger event is generated on the selected edge when the pattern is true and **present** is selected, or a trigger occurs when the pattern is false and **not present** is selected.

holdoff Key The **holdoff** key assigns the entry devices to control holdoff. Holdoff disables the trigger circuit for a selectable time period after the trigger event. Holdoff is selected in 20 ns time increments, from 40 ns to 320 ms, or for events (count of states) 2 to 16 000 000. Time and event are toggled with the knob.

State Trigger Exercise

This exercise demonstrates how an input pattern is used to qualify a clock edge as a trigger.

State triggering extends the logic triggering capability of the HP 54504A by selecting one of the inputs as a clock and using the other inputs as qualifiers.

This is useful when it is necessary to synchronize the display with a system clock to detect a system state. For example, consider a synchronous memory bus. The state trigger mode enables only those events that occur when reading from a block of memory to be captured and displayed.

Instrument Setup To perform the following exercise use an HP 8116A Pulse/Signal generator or another signal generator capable of the same 1 MHz, 1 volt square wave.

Set up the HP 8116A as follows:

- Mode = NORM
- FRQ = 1.00 MHz
- DTY = 50%
- AMP = 1.00 V
- OFS = -200 mV

Connect the signal to a BNC tee on channel 1 using a 1-meter coaxial cable. Connect another 1-meter cable from the other side of the BNC tee to channel 2.

Oscilloscope Setup

The extra cable length between channels 1 and 2 provides a time delay between the signals displayed on the oscilloscope. The propagation of a 1-meter coaxial cable is approximately 6 to 7 ns. This time delay demonstrates the HP 54504A triggering capability.

- Press AUTOSCALE.

Set up the HP 54504A as follows:

- Timebase = 10.00 ns/div
delay = 0.00 s
reference = cntr
window = off
acquisition mode = repetitive
- Channel 1 turned on
Vertical sensitivity = 500 mV/div
offset = -200 V
dc coupling
input impedance = 1 M Ω
- Channel 2 turned on
Vertical sensitivity = 500 mV/div
offset = -200 mV
dc coupling
input impedance = 50 Ω

- Display
 - minimum persistence
 - 2 screens
- Trigger
 - Channel 1 level = -200 mV
 - Channel 2 level = -200 mV
 - Set the trigger mode to state
- Set the pattern to \uparrow L X as follows:
 1. Press the function key until the first bit is highlighted.
 2. Turn the knob until the highlighted area is \uparrow .
 3. Select the next bit in the pattern and select L.
 4. Continue until all bits are selected in the \uparrow LX pattern.
- Press the when key until is present is selected (see Figure 6-11).

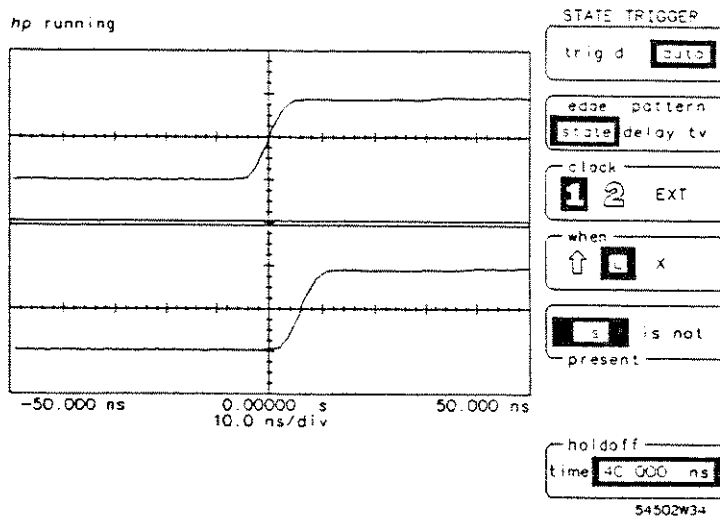

Figure 6-11. Channel 1 Clock LX State

Channel 1 is displayed in the top screen. To satisfy the conditions of the bit pattern, channel 2 must be low (lower than the channel 2 trigger level) or less than -200 mV. When the signal on channel 1 goes higher than -200 mV and channel 2 is still low (less than -200 mV) the pattern conditions have been satisfied, the HP 54504A triggers.

- Change the bit pattern to ↑ LX and select the is not present condition.

To satisfy this bit condition the clock channel must go low while channel 2 is high. The oscilloscope triggers on the falling edge of channel 1 when the L on channel 2 is not present, i.e. channel 2 is high.

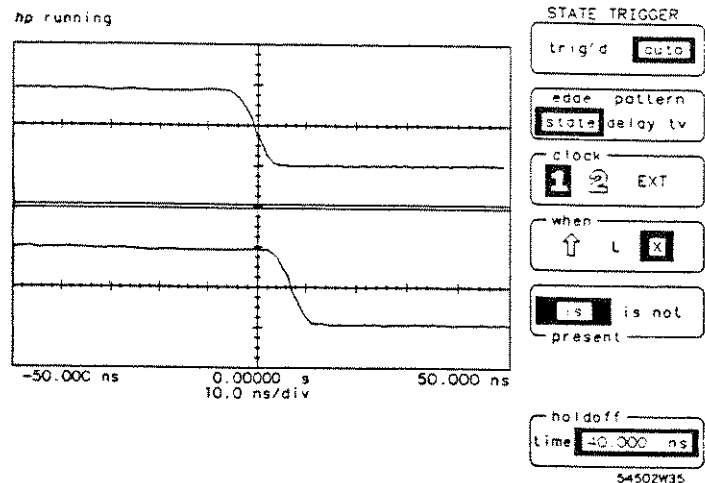
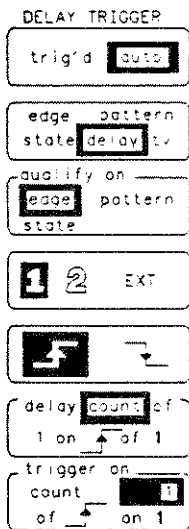

Figure 6-12. Channel 1 Clock LX State

Delay Trigger Mode

The delay trigger mode qualifies on a signal edge, pattern, or state, delay for a period of time (or occurrence of edges), and then triggers on a selected edge from any source.



54502W13

This trigger mode is versatile and accommodates most complex triggering situations. It has the flexibility to select different trigger sources, delay times, delay counts and then display various points of the waveform.

qualify on Key

The **qualify on** key selects which mode to qualify the trigger before a delay is defined.

The qualify options are:

- edge
- pattern
- state

qualify on edge

Select the edge qualifier and the next two function keys defines the parameters. The next key is an unlabelled field that selects the channel to be the source. The second key below the edge selection is the slope selection.

qualify on pattern

When the pattern trigger option is selected, the next function key defines the qualifier pattern. Defining a pattern is the same as in the pattern trigger mode.

- Highlight the bit to be changed by pressing the function key.
- Change the bit by rotating the knob.

After selecting through all four bits, the active field is changed to the condition field. This field to sets conditions as in the Pattern Trigger mode:

- when entered
- when exited
- when present > [time]
- when present < [time]
- range > [time2] and < [time1]

These settings activate the next field, as appropriate, so the specific time parameters can be set.

qualify on state

If the state trigger option is selected the next two function keys define the state conditions.

As in the state trigger mode, select the channel to define the state clock. This selection is reflected in the pattern with an arrow and the slope is depicted with the arrowhead pointing up or down. Use the function key to move the highlighted bit to change the pattern. When the pattern is set, the **is/not present** setting can be changed by moving the highlight to the **is/not present** field label and pressing the function key again. When the label is highlighted, toggle the setting between **is/not present** with the knob.

delay Key This field selects between two delay options. To change between the **time** and **count** options rotate the knob until the desired option is displayed in the **inverse video** field.

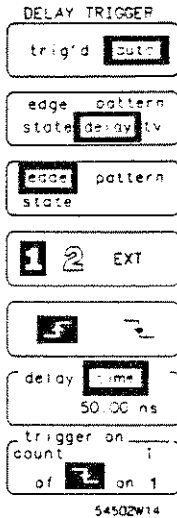

delay time disables the trigger circuit for a selected period of time, from 30 ns to 160 ms after the trigger has been qualified

Note

Time delay is not available in the time qualified pattern settings of when present >, when present <, or range.

- Press the function key until the highlight is on the first numeric field. This field selects the amount of delay after qualification, ranging from 30 ns to 160 ms.

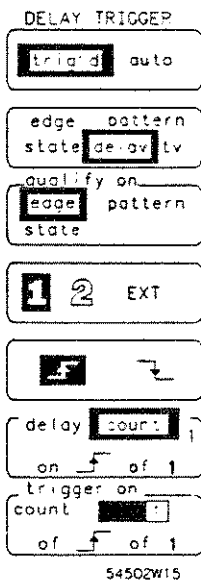

delay count (delay by edges) disables the trigger circuit for a selected count from 1 to 16 000 000 after the trigger has been qualified. After the selected count has been attained the HP 54504A looks for the user specified trigger edge.

- Press the function key until the highlight is on the first numeric field. This field to selects the number of edges to delay after the trigger has been qualified (from 1 to 16 000 000).
- Press the function key once more to activate the rising edge/falling edge option and select the desired edge with the knob.
- Press the function key once more to highlight the third option field and select the channel to delay on.
- Press the function key a fourth time to return to the first numeric field.

trigger on Key This key selects a specific edge to trigger on after the qualification and delay conditions have been satisfied. All other keys in this menu have dealt with **defining** qualifying conditions, however, this field sets the trigger point. This is another three position option switch.

- Press the function key to highlight the numeric field and select which occurrence to trigger, using the knob to set the number (1 to 16 000 000).
- Press the function key again and move the highlighted field to select the slope. The knob toggles the selection between rising and falling edge.
- Press the function key again and highlight the channel selection. The knob is used to change the channel selection.

Delay Trigger Exercise

This exercise demonstrates how to use the delay trigger to trigger on the exact point of a waveform. The exercise leads through setting up a complex signal, setting up the HP 54504A, and changing settings and counts for viewing various points on the waveform.

Instrument Setup Set up an HP 8116A (or comparable signal/generator) for a burst pulse with ten bursts that repeats every 50 μ seconds.

Set up the HP 8116A Pulse/Function Generator:

- Mode = I.BUR
- RPT = 50 μ s
- BUR = 10
- FRQ = 5.0 MHz
- DTY = 50%
- AMP = 1.00 V
- OFS = -200 mV

Connect the signal to channel 1 of the HP 54504A.

Oscilloscope Setup The HP 54504A autoscales and displays this signal, however, for this example make the listed triggering changes after autoscaling.

- Press **AUTOSCALE**.

hp running

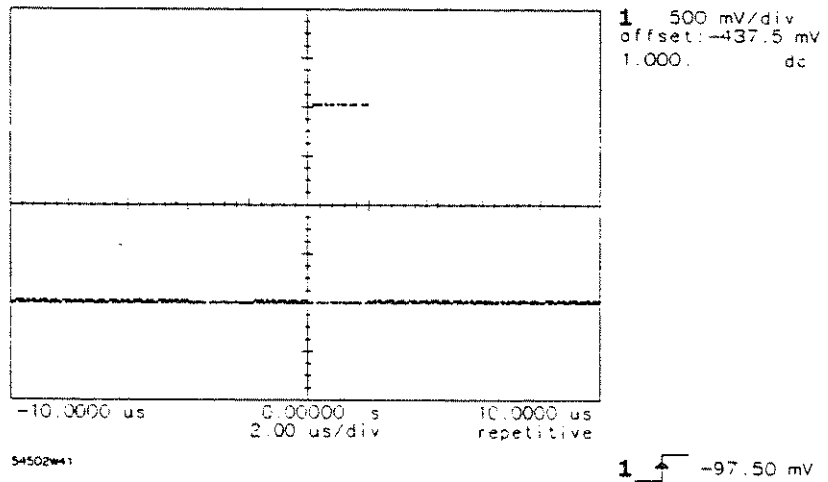

Figure 6-13. Ten Burst Pulse after AUTOSCALE

Set up the HP 54504A as follows:

- Press **TIMEBASE** and select **repetitive**.
- Press **TRIG** and select **trig'd display**.
- Select **delay trigger mode**.
- **Qualify on edge** and the rising edge of channel 1 as the source.
- Select a delay time of $2.5 \mu\text{s}$ to gain a stable trigger.
- Set **trigger on** to trigger on rising edge 1 of channel 1.

This trigger setup qualifies on the first rising edge of the burst, delays through the remaining portion of the burst, then triggers on the first edge of the next burst.

- Press TIMEBASE and set time/division to 500 ns.

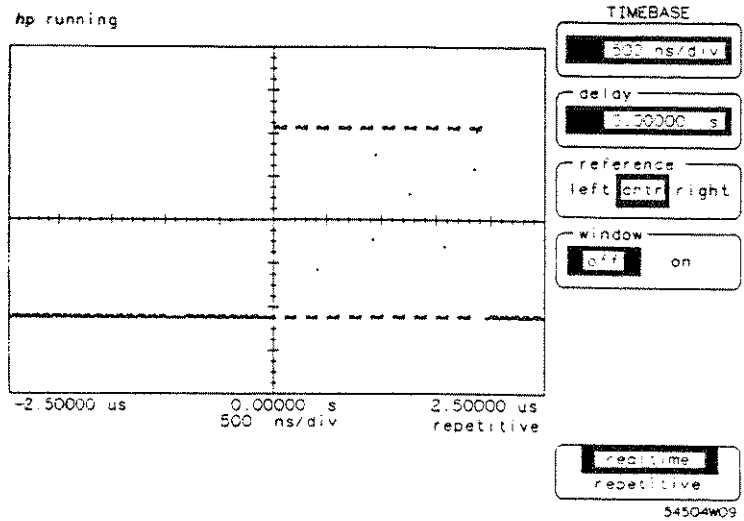

Figure 6-14. Ten Burst Pulse w/Stable Trigger

- Return to the trigger menu and set trigger on count to 5. This tells the oscilloscope to trigger on the 5th rising edge of the next burst (see Figure 6-15).

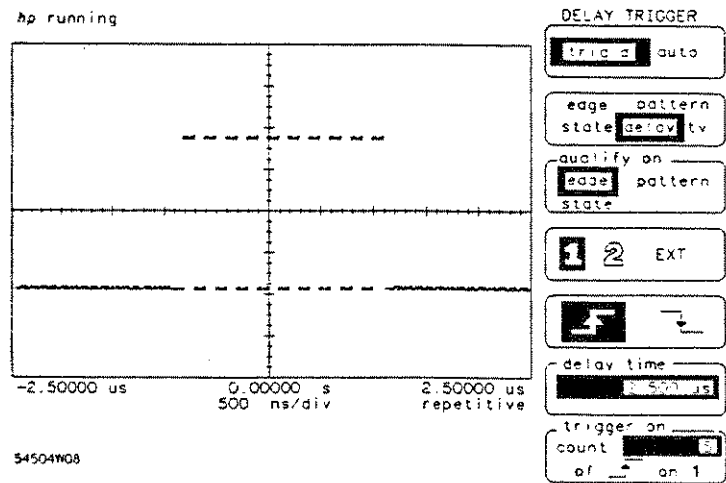

Figure 6-15. Ten Burst Pulse Triggered on Pulse 5

- Change the trigger on count key to 9 (see Figure 6-16).

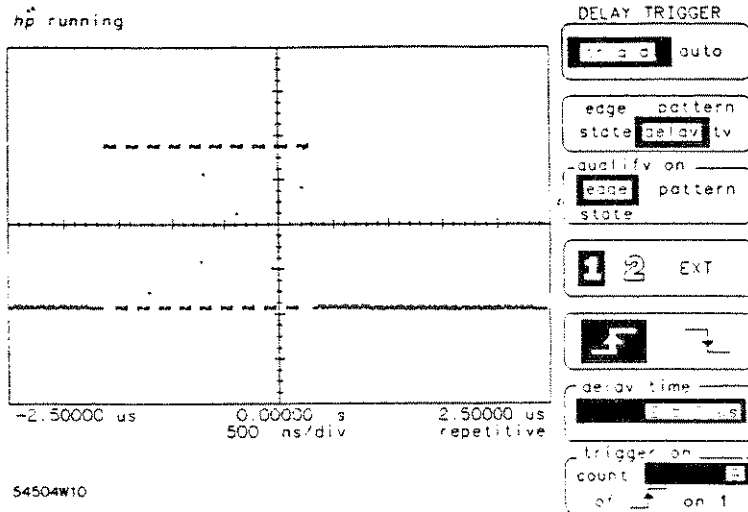
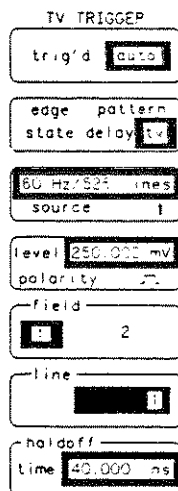

Figure 6-16. Ten Burst Pulse Triggered on Pulse 9

By setting the oscilloscope to the delay trigger mode, a specific time or count to delay between qualification and trigger can be added.

In this exercise, the trigger was delayed to get a stable display. When the time delay had elapsed the HP 54504A began counting rising edges until it found the ninth edge.

TV Trigger Mode



54501/WF 17

The TV TRIGGER menu enables the HP 54504A to trigger on clamped tv signals. The two most common tv standards; 60 Hz/525 lines or NTSC is the standard used in the United States, 50 Hz/625 lines is the standard used in most European countries. This trigger menu also allows for user defined tv signals that may be used in other parts of the world.

To move the highlighted inverse video window within a field you must press the selection key and to change the value displayed in the window you must rotate the knob.

Note

Pay close attention to the movement of the highlighted window; it moves to various options within the field.

Standard Select Key The source key chooses between the NTSC standard tv signal used in the United States with a 60 Hz and 525 lines per frame, the standard of 50 Hz and 625 lines per frame used in most countries in Europe. The third option is for user defined ranges of the tv signal.

To make the desired selection:

- Press the selection key and select the standard by rotating the knob. The active field is highlighted in inverse video.

Source Select Key To select the trigger channel to be used as a source,

- Press the selection key and move the highlighted field, rotate the knob until the desired channel is displayed.

level/polarity Key The level option sets the trigger level that is applicable only to the tv trigger source.

- Press the function key again and the highlighted window moves to the polarity option and selects the rising edge or falling sync pulses to trigger on.

field Key The field key selects field, 1 or 2.

line Key The line key selects which line the trigger will be generated on. This selection is dependent upon which field has been selected previously.

If the previous selection is the 60 Hz, 525 lines standard, the options available depend upon which field, 1 or 2 is selected:

- If field 1 is selected, select from line 1 to 263 in field 1.
- If field 2 is selected, choose from line 1 to 262 in field 2.

This tv trigger mode is compatible with broadcast standard M.

If the 50 Hz, 625 lines standard is selected, the options are also dependent upon field settings:

- If field 1 is selected the range of lines is from 1 to 313,
- If field 2 is selected the range of lines is from 314 to 625.

This tv trigger mode is compatible with broadcast standards: B, C, D, G, H, I, K, K1, L, and N.

holdoff Key The holdoff key enables the oscilloscope to hold off the trigger event from 40 ns to 320 ms and is incremented in 20 ns time frames.

TV Trigger Exercise

Video signals are unique, and as such have unique requirements for proper triggering. This exercise demonstrates how to display and work with video signals on the HP 54504A.

Instrument Setup Use a standard NTSC signal generator with clamped video output for this exercise. Turn color bars on.

Oscilloscope Setup Connect the NTSC video signal to channel 1 of the HP 54504A.

- Press AUTOSCALE.
- Select the tv trigger mode.
- Set 60 Hz/525 lines and channel 1 as the source.

Determine the polarity of the sync pulse.

- Select the trigger level and rotate the knob until a stable display is attained. When a sync pulse is visible, determine the polarity, select polarity (press the function key) and set the sync pulse in accordance with the actual pulse.
- Set the trigger level at approximately the midpoint of the sync pulse.

This sets the trigger level just below the middle of the sync pulse and tells the oscilloscope to trigger on the leading edge.

- Set trig'd/auto to trig'd.

This eliminates the possibility of a premature trigger event occurring.

- Select field 1 and line 1.
- Press TIMEBASE and set time/division to 100 μ s/div.

- Press DISPLAY and set persistence to ≈ 600.0 ms to accommodate video signals.

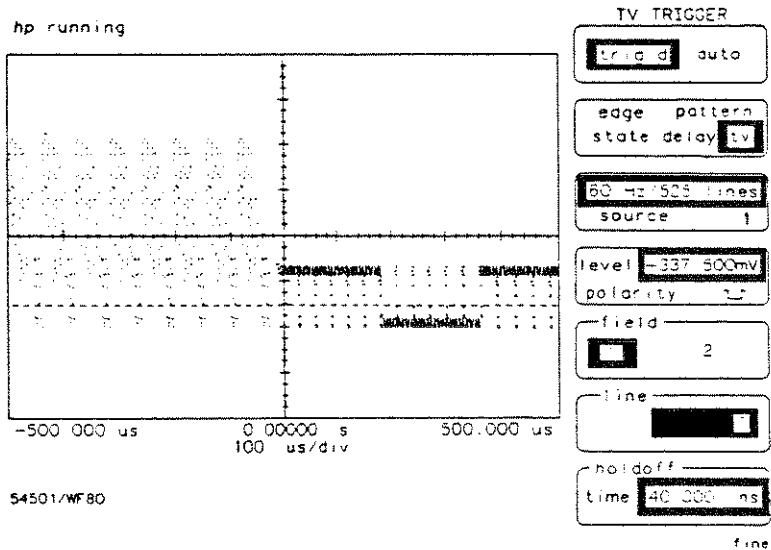

Figure 6-17. Trigger at Field 1, Line 1

The HP 54504A is triggering on the first equalizing pulse of field 1, the first pulse in the vertical interval. The pretrigger data that is being viewed (left half of the screen) is field 2, lines 256-262.

- Set time/division to $10 \mu\text{s}/\text{div}$ and set the trigger to field 1, line 10.

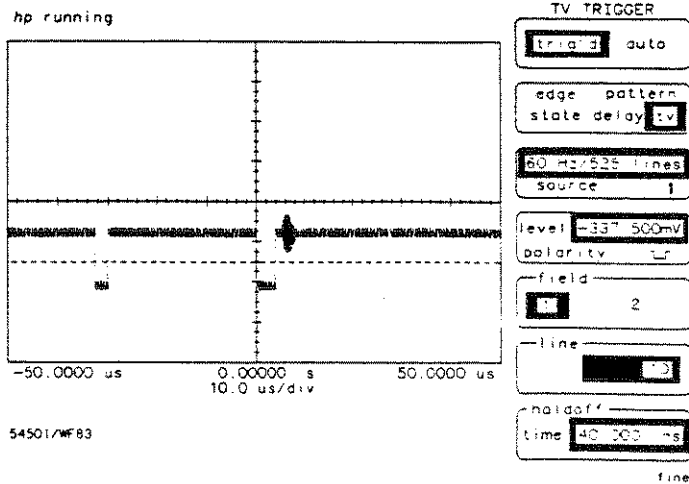

Figure 6-18. Trigger on Field 1, Line 10

The trigger is now on the first horizontal sync pulse in the vertical interval with color burst information.

- Change the trigger point to field 1, line 21.

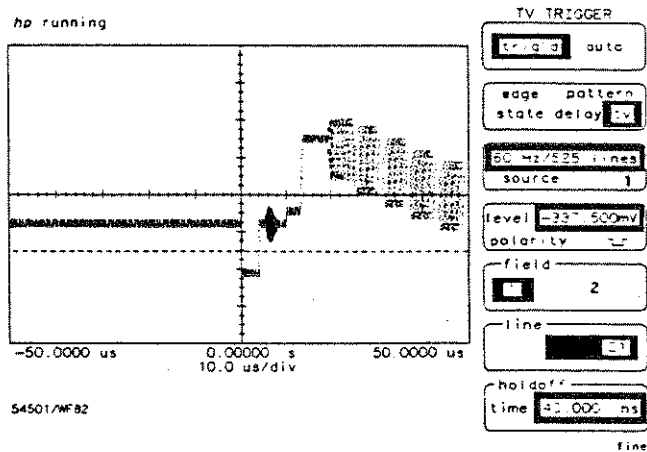

Figure 6-19. Trigger on Field 1, Line 21

The trigger point is now on the last sync pulse of the vertical interval. The next line contains color information, in this case color bars are present.

- Change the trigger to field 2, line 1.

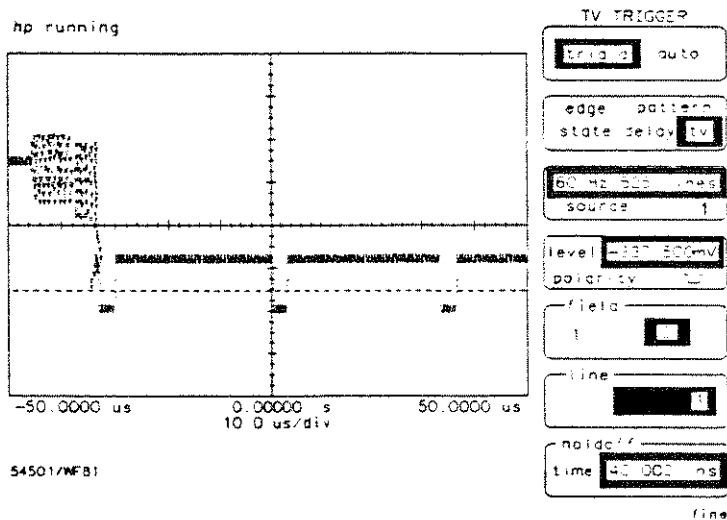

Figure 6-20. Trigger on Field 2, Line 1

The trigger point is on the second sync pulse of the vertical interval. This is the correct trigger point because fields 1 and 2 are interlaced.

Introduction to the Display

The **DISPLAY** menu controls most of the features that dictate how the acquired data is displayed. These features include ways to manipulate data for clarity, to eliminate noise, viewing best case/worst case situations, or the displayed background. There are two display menus, depending on which acquisition mode the oscilloscope is set to in the **TIMEBASE** menu.

This chapter describes the **DISPLAY** menu, the submenus, how to control all the features, and how to display the most meaningful waveform for measurements.

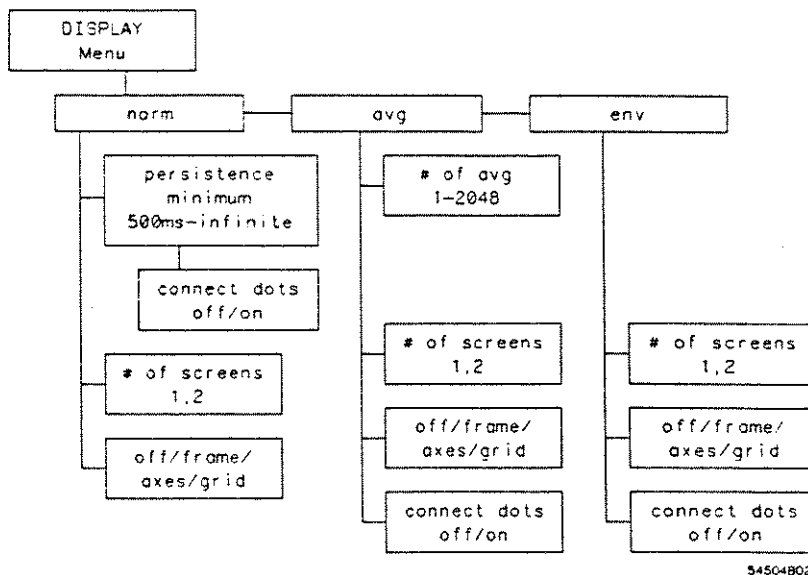
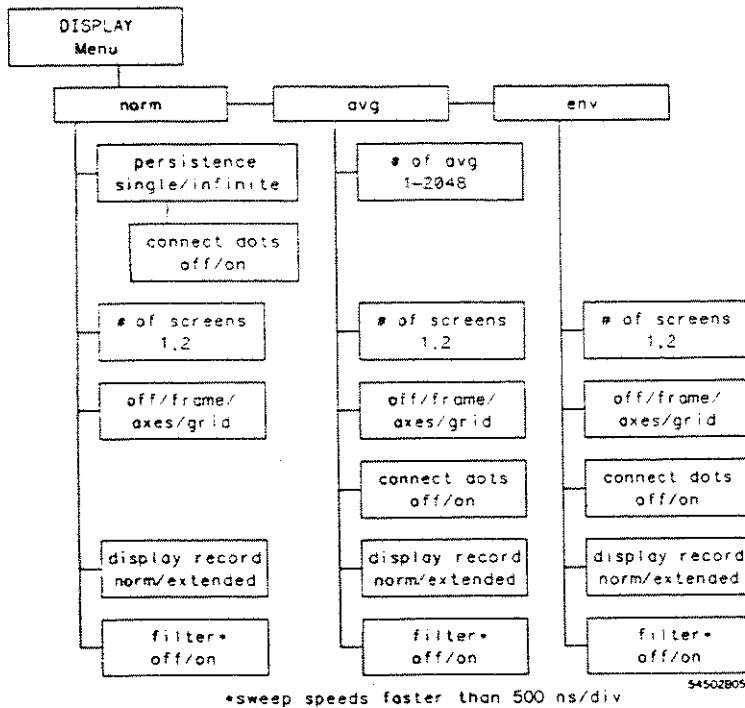

Figure 7-1. Repetitive Acquisition Mode Display Menu



7-2. Realtime Acquisition Mode Display Menu

Display Mode Key

The **DISPLAY** mode key selects one of three display modes:

- normal
- averaged
- envelope

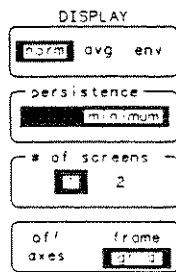

54502W44

norm The **norm** mode sets the time parameters for displaying data or persistence. The range in the variable persistence mode is from minimum, very fast overwriting and updating the display, to infinite with variable settings in between, from 500 ms to 10 seconds. This means that data display records can be preset to any of the persistence settings. Settings less than infinite display data for the specified period of time and then overwrite old data.

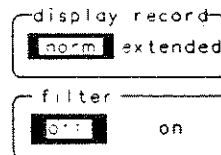
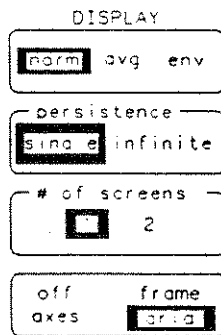

54502W09

In realtime acquisition mode:

- Single or infinite persistence are the two choices during realtime acquisition. Single persistence is very fast overwrite. As each new acquisition is displayed it overwrites the previous data. The current display is always the most recent acquisition.

In repetitive acquisition mode:

- Fast persistence settings are useful when the input signal is changing and immediate feedback is needed.
- More persistence is useful when observing long-term changes in the signal or low signal repetition rates.

In repetitive acquisition mode:

At minimum persistence, a point is erased when a new point is acquired in the same time on the display. Therefore, the waveform fills quickly and each point remains for a minimum amount of time.

NOTE

When the keypad is used to change persistence settings, any entry longer than 10 seconds causes the message value out of range, set to limit to be displayed. Persistence is automatically set to infinite. Any entry less than 500 ms causes the same message to be displayed and persistence is set to minimum.

In both acquisition modes:

- Infinite persistence can be used for worst-case characterizations of signal noise, jitter, drift, etc. In this mode the HP 54504A is used as a storage oscilloscope.

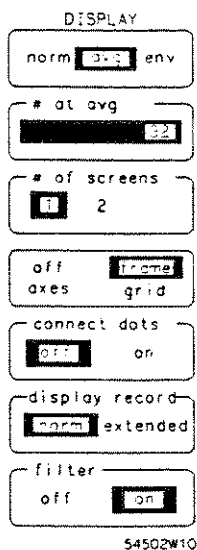

When **norm** is selected, the function key beneath the norm field is activated. This field displays the current persistence setting that can be set using either of the entry devices. Connect the dots is available only in norm mode and minimum persistence.

avg The averaged mode selects the number of waveform acquisitions that are averaged to generate the displayed waveform. The range for the averaging function is 1 to 2048 in powers of 2.

When averaged mode is selected, the next function key is activated and the number of averages is set using either entry keys or knob.

Displayed signal noise is significantly reduced by using the averaging mode. As the number of averages is increased from 1 to 2048, the display becomes less responsive to changes in the input signal(s), however, using more averages reduces the effects of displayed signal noise and improves resolution.

env The envelope mode needs no other parameters set. The display reflects the minimum and maximum voltages in each horizontal position. This is useful in viewing voltage or time jitter.

of screens Key

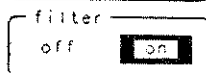
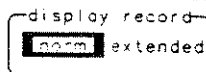
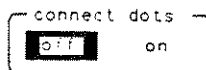
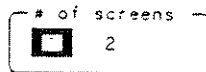

54502W11

The next function key selects the number of screens to be displayed:

- **1:** the entire display area is one screen and any displayed waveforms are superimposed on top of each other.
- **2:** the display area is divided into two screens. Channel 1 is displayed in the top screen and channel 2 is displayed in the bottom screen (See Figure 7-2).

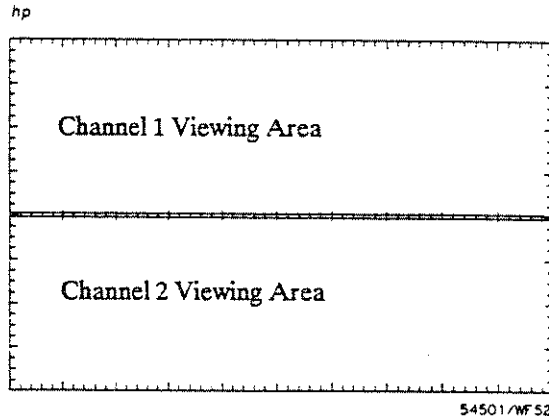

Figure 7-3. Dual Screen Display

When waveform math functions or the dual timebase window are turned on, they are displayed in the lower half of the screen and the channels are displayed in the top half.

**off/frame/
axes/grid Key**

This unlabelled field selects one of four display backgrounds:

- **off:** turns the background graticule off. The displayed waveform and waveform information is not turned off.
- **frame:** displays the outside border with a measurement scale. The measurement scale is incremented/decremented with major divisions and minor divisions based on the vertical and horizontal measurement settings.
- **axes:** displays a background with the measurement scale crossing at mid-screen.
- **grid:** background is a complete graticule with ten horizontal major divisions and eight vertical major divisions. Only the axes portion of the graticule has a minor division scale.

connect dots Key

Connect-the-dots is a technique used to display waveforms with all data points connected. This makes viewing the waveforms easier because the signal is complete and has no breaks. The waveform in figure 7-4 is the same as in figure 6-15 after connect dots key is on.

Note

Connect-the-dots does not interpolate data and generate data points. The HP 54504A connects data points linearly.

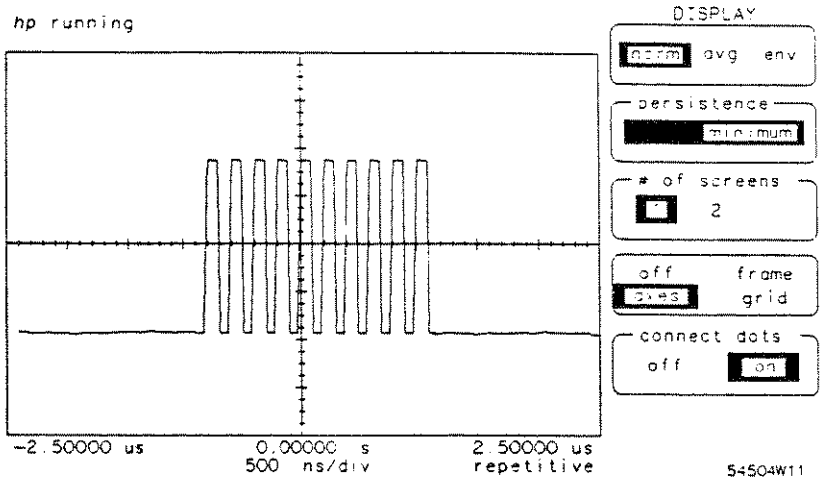
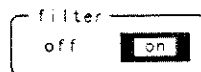
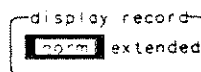
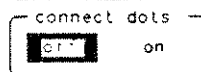
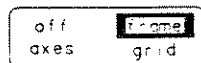
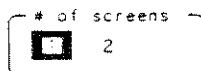
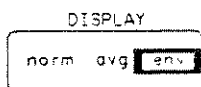

Figure 7-4. Connect the Dots

display record Key



54502W11

This key is available only when the HP 54504A is in realtime acquisition mode. In realtime acquisition mode, 2001 points are acquired and processed with each acquisition. Five hundred of these points are displayed on the normal 10 division display. With extended display record selected, the 2001 points of data is compressed and displayed. The timebase is then multiplied by 4 to reflect this change.

It is easy to search for glitches when the display is in this mode.

Use this mode in combination with window (in Timebase menu) for a macro and micro view of the acquired data. The top screen is the compressed 2001 data points display and the bottom screen is the 501 data points display.

This key toggles the 501 and 2001 point displays while the HP 54504A is running only. Since all 2001 points are processed, data is not lost, except when the display persistence is set to infinite.

This key is not present in repetitive acquisition mode.

filter Key

The filter key turns on a smoothing filter for the 8-bit A/D converter for realtime acquisition sweep speeds greater than 200 ns/division. As opposed to connect-the-dot display mode, the filter improves the smoothness of data collected for display rather than connecting acquired points linearly.

For realtime acquisition sweep speeds of 200 ns/division and below, this key is not present on the display menu and another filter is always on.

This key is not present in repetitive acquisition mode.

Display Menu
7-8

HP 54504A
Front-Panel Reference

Introduction to the Markers

This chapter describes how to use the markers and make manual measurements on displayed waveforms.

In this menu, two sets of markers, the ΔV markers (horizontal voltage markers) and the Δt markers (vertical time markers) are controlled. When the desired set of markers have been turned on the two marker fields are turned on. Each marker is individually controlled.

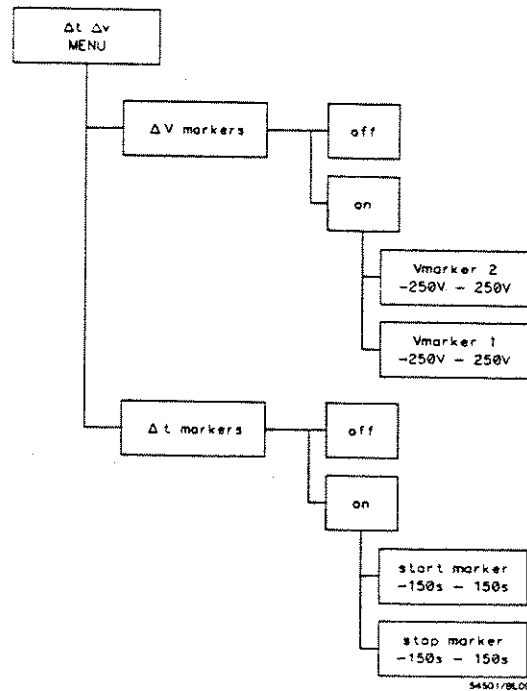
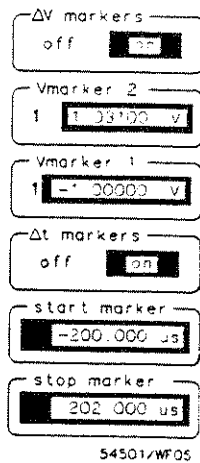
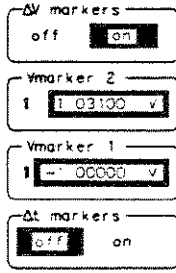

Figure 8-1. Delta t/Delta V Menu

ΔV markers Key



This function key toggles the markers on and off. With the ΔV function turned on the next two fields are activated allowing individual control of the two markers.

When the ΔV markers are turned on, *Vmarker2*, *Vmarker1*, and *delta V* appear in the factors display area. The delta V entry is calculated as the following:

$$Vmarker\ 2 - Vmarker\ 1 = \text{delta } V$$

If delta V is negative, Vmarker 1 is located at a more positive voltage level than Vmarker 2.

Vmarker 2 Key

This function key is a two function control field. The first selection is the desired channel, memory, or function to place Vmarker 2 for measurement. By pressing the key again, the highlighted field moves to the numeric display to select the voltage level. Typically, place Vmarker 2 at the desired level on the waveform display and read the level in the highlighted field, and in the factors area of the waveform display.

Vmarker 2 is the voltage marker with shorter dashes.

Vmarker 1 Key

Vmarker 1 operation is identical to Vmarker 2, except it is represented by longer dashes.

NOTE

The markers can be moved on a selected source even though that source is not displayed. Make sure that the markers are assigned to the proper source to be measured, or the numeric field may be incorrect.

Δt markers Key

This function key toggles the time markers on and off. With the Δt function turned on the next two fields are activated allowing individual control of the two markers.

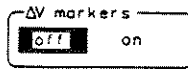

The markers are placed on the display respective of the trigger point. Positive time values are to the right of the trigger point and negative time values are to the left. Delta t values are determined by the following:

$$\text{stop marker} - \text{start marker} = \text{delta t}$$

There is no such thing as negative delta t, this only means that the start marker is placed later in time than the stop marker.

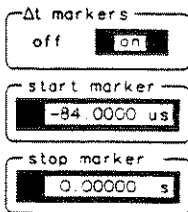

54501/WF 64

The inverse of delta t is 1/delta t. Since the inverse of time is frequency, this ratio produces an answer in frequency. However, if the markers are placed across parts of a waveform of differing time frames, the answer may not be valid. This feature is useful when looking for the frequency in a burst that is different from the rest of the waveform. Place the time markers across the burst (at similar points on the waveform) to determine the frequency of the burst.

start marker Key

To set the start marker, press the function key to highlight the field. This makes the start marker field active. Set the marker with the knob.

The start marker is represented with long dashes.

stop marker Key

The stop marker is identical to the start marker, except that it is represented by short dashes.

Introduction to the Functions

The WAVEFORM MATH menu defines one of two math functions. The functions are used on data that is displayed on screen from any of the four channels or from any of the four waveform memories. If data from a channel is used for a function, the channel must be turned on. However, if data from a waveform memory is used for a function, that memory does not have to be displayed.

A function is generated by mathematically manipulating one or two operands with known operations. The HP 54504A uses the following mathematical operations:

- plus (+)
- minus (-)
- times (x)
- versus
- only
- invert

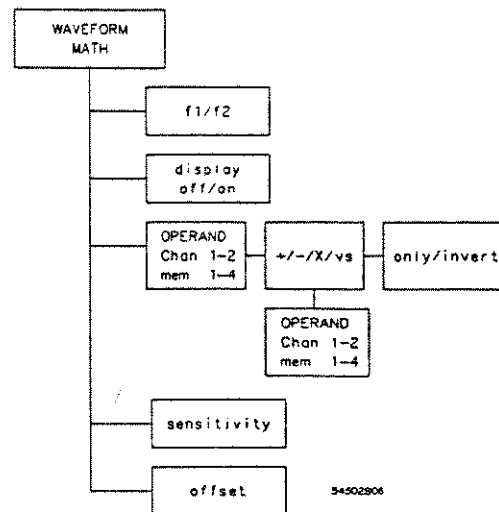

Figure 9-1. Waveform Math Menu

The vertical display and offset can be adjusted to place the function for best viewing.

When the function has been calculated, it can be used in the following manners:

- displayed
- evaluated with the measurement features
- stored in memory
- outputted over the HP-IB

Defining a Function

The Waveform Math menu selects and presets any of various operations, sources, and displayed results.

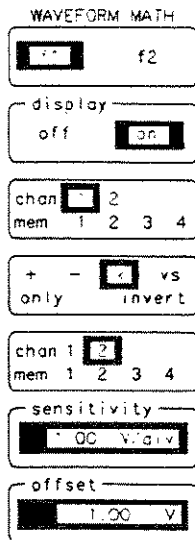

54502W36

Function Key This key selects either function 1 or function 2.

display Key The display key turns the selected function on or off. The vertical sensitivity and offset are displayed in the function menu fields.

When the function display is turned on, the screen splits and the original waveforms are displayed in the top half screen while the functions are displayed in the bottom half screen. Both functions can be on at the same time and they are displayed superimposed or in two screens in the bottom half of the CRT if multiple screens have been selected.

The timebase window automatically turns off when a function is turned on.

chan/mem Key Press this key to select the first operand of the mathematical operation, or the waveform to be manipulated. The choice can be any displayed channel or any waveform memory that has a waveform stored. Ensure that the channel or memory source is turned on.

If the operator is only or invert, this is the only operand that may be selected.

Operator Key This key selects any of the six functions. Continue pressing the selection key until the operation desired is highlighted.

- **plus (+):** the two selected operands are added together. Addition is calculated on a point-by-point basis.
- **minus (-):** the minus operation subtracts the second operand from the first.
- **times (x):** the times operation multiplies the value of the first operand by the value of the second operand. Each data point is multiplied with a corresponding data point and the product is placed on the function display. The displayed waveform is scaled to correspond to a different sized waveform.
- **vs (versus):** the versus function draws a volts versus volts display of the two selected operands. Versus cannot be stored in a waveform memory because measurements cannot be made on the resultant waveform, however, it can be stored in pixel memory. In source x versus source y, the vertical range of source y determines the horizontal range of the vs function.

- **only:** The only function displays the first operand and scales it.
- **invert:** The invert function inverts the data of the first operand.

chan/mem Key This key selects the second operand, or the waveform that is manipulated against the first operand. The choices are any of the displayed channels or any of the memories.

This key is not available if the operator is **only** or **invert**.

sensitivity Key The vertical sensitivity of the function is set with this key. This setting is for ease of viewing and making measurements with the newly developed waveform.

offset Key The offset of the function is set with this key.

Vertical Scaling Units

The fundamental measuring units of an oscilloscope are volts/division in the vertical axis and time/division on the horizontal axis. This philosophy is used regardless of the mathematical function chosen. No provisions have been made to manage units for all combinations of operands and operations.

For example, apply a +2V signal to channel 1 and a -3V signal to channel 2. The HP 54504A displays the product as -6V, when in reality it is $-6V^2$.

Displaying Functions

The HP 54504A has several screen variations available to accommodate a 2-channel display, as well as two functions.

- The single screen mode with a function on, the mathematical results are displayed in the bottom half of the screen while the operands are superimposed in the top half of the screen.

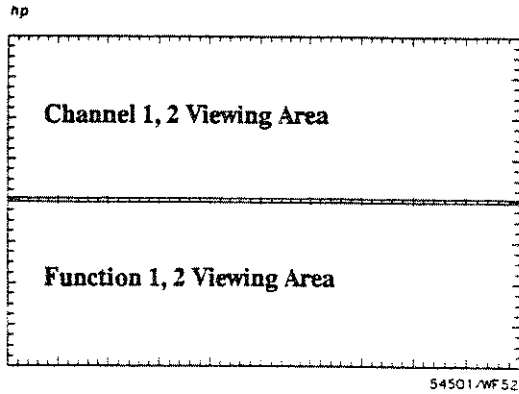

Figure 9-2. Single Screen w/Function On

- In the dual screen mode the functions are again displayed in the bottom half of the screen, however, the dual screens are displayed in the top half.

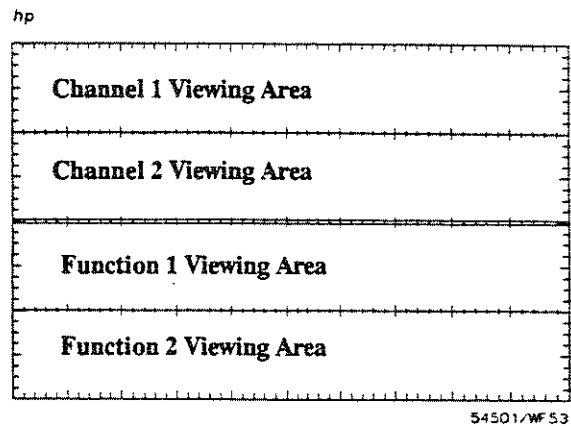

Figure 9-3. Dual Screen w/Function On

Waveform Math Exercise

In this exercise the **WAVEFORM MATH** menu is used to subtract one waveform from another.

Instrument Setup Set up an HP 8116A, or a signal generator capable of a 1 MHz, 1 volt squarewave, as follows:

- **MODE** = NORM
- **FRQ** = 1 MHz
- **DTY** = 50%
- **AMP** = 1.00 V
- **OFS** = 0.00 V
- **Pulse** = square wave

Connect the signal to a BNC tee on channel 1 using a 1-meter coaxial cable. Connect another 1-meter cable from the other side of the BNC tee and terminate in 50 Ω to channel 2.

Oscilloscope Setup The extra cable length between channels 1 and 2 provides a time delay between the signals on the oscilloscope. The propagation of a 1-meter coaxial cable is approximately 6 to 7 ns. This delay is used to demonstrate the math function.

The following procedure assists in setting up the HP 54504A for optimal viewing.

- Press **AUTOSCALE**.
- Press **DISPLAY** to set the best viewing conditions. Set display mode to *avg*, # of *avg* to 8, # of *screens* to 2.
- Press **WFORM MATH** to define the function. Select *f1* and turn the display on. Select *chan 1*, - (*minus*), *chan 2* and set the function sensitivity to 2.00 V/div.

The function subtracts channel 2 from channel 1. The propagation between channels has allowed a 6 to 7 ns spike. To better view the results:

- Press TIMEBASE and set the horizontal display to 50.0 ns/div (see Figure 9-5). This display is best viewed when the oscilloscope is in repetitive acquisition mode.

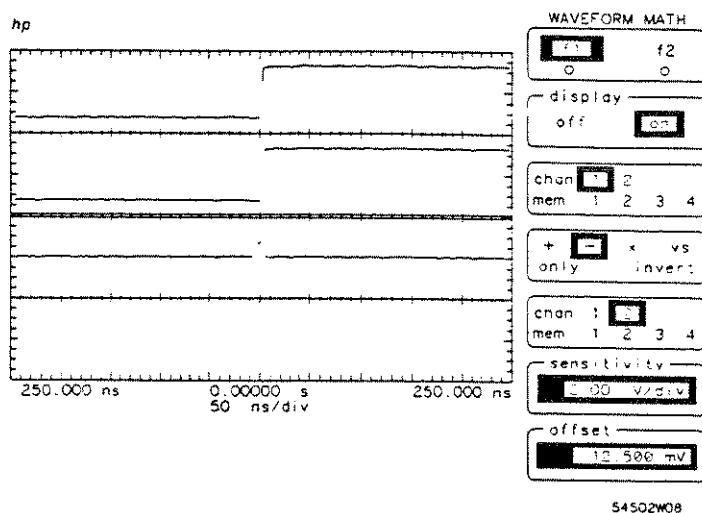

Figure 9-5. Channel 1 minus Channel 2

Introduction to the Memories

This chapter describes how to select the waveform and pixel memories on the HP 54504A. The menu consists of two submenus:

- waveform memories m1 - m4 used to store one waveform at a time.
- pixel memories p1 and p2 used as a screen store. In this manner the memories are used as a storage oscilloscope.

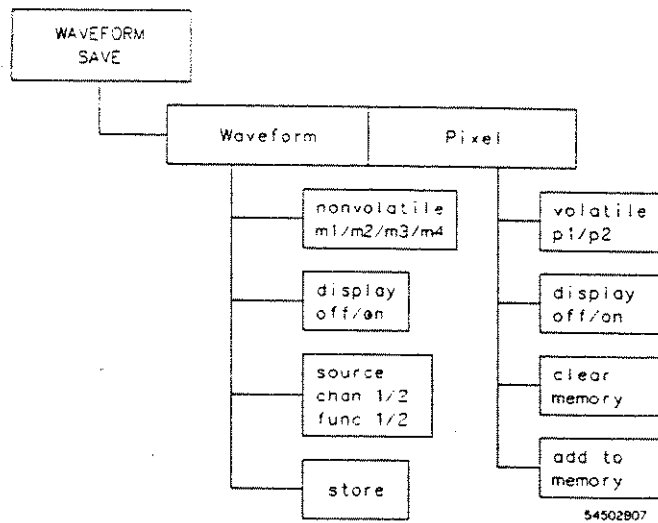
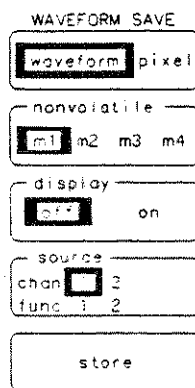

Figure 10-1 Waveform Save Menu

waveform/pixel Key

This is the function key used to choose the desired type of memory. The active menu is highlighted. Each memory type, waveform or pixel, has a separate menu. When this key is pressed, the rest of the menu changes.

waveform Menu



54502W05

The waveform menu has four available memories, m1, m2, m3, and m4. These memories are nonvolatile and will not be cleared during AUTOSCALE, RECALL CLEAR, or recycling power. This permits disconnection of power and transportation of the oscilloscope without losing the contents of waveform memories.

A waveform memory consists of a single waveform record, including the horizontal and vertical scaling parameters. This allows measurements on previously stored waveform and function data. Voltage and time markers can be set on waveforms when they are displayed however, the time markers follow the TIMEBASE menu time/division and not that of the memory waveform.

When the HP 54504A is in the envelope display mode and a waveform store is executed, the min value and max value are stored separately. The min value will be stored in m1 if m1 or m3 are the selected store locations, or m2 if m2 or m4 are the storage locations. The max values are stored in m3 or m4 respectively. A store message is displayed above the waveform display area to show the storage locations of both values.

nonvolatile Key This key selects which memory to use. The selections are nonvolatile memories m1, m2, m3 and m4. When a memory is turned on the small circle below the label is highlighted.

The waveform memories are record memories that store 2000 points of waveform information in each memory.

display Key This key toggles the selected memory display on or off.

source Key The source key selects the source waveform to be stored. The source alternatives are any channel or either function.

store Key This is the active key in the menu. By pressing this key the specified waveform is stored in the specified memory. When the key is pressed an immediate erase of the selected memory and a write to the memory is executed.

pixel Menu

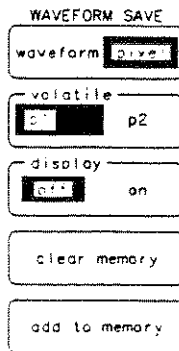

54501/WF19

The pixel submenu selects the pixel memories. These memories are useful when additive memory capabilities are needed. Waveforms can be stored to and added to indefinitely.

volatile Key This is the memory select key. The alternatives are pixel memory 1 or 2. The pixel memories are complete pixel saves of the waveform area (excluding the graticule and markers) in volatile memory. The waveform display area is 256 X 451 pixels.

In pixel memory the entire screen is saved, therefore, data is mapped directly onto the display and displayed in halfbright. There are no measurement capabilities on pixel memories.

Pixel memories are additive. When all pixels are full, add to memory will merely overwrite existing data.

display Key This key toggles the selected pixel memories on or off.

clear memory Key This key purges all data from the selected pixel memory.

add to memory Key Pressing this key adds the currently displayed waveforms to the specified pixel memory.

Waveform Save Exercise

This exercise demonstrates how a waveform is stored, the offset setting changed, and the stored waveform recalled to be compared with the current display.

Instrument Setup Set up an HP 8116A or a signal generator capable of a 6 kHz, 1 volt squarewave:

- Mode = NORM
- FRQ = 6.00 kHz
- DTY = 50%
- AMP = 1.00 V
- OFS = 0.00 V
- Pulse = squarewave

Oscilloscope Setup This procedure assists in setting up the HP 54504A for optimal viewing.

- Connect this signal to the Channel 1 input.
- Press AUTOSCALE.
- Press WFORM SAVE and select the waveform submenu.
- Press the nonvolatile key until m3 is selected.
- Press the source key until chan 1 is selected.

- Press the **store** key.

The currently displayed waveform is saved in nonvolatile memory m3. The remainder of this exercise demonstrates how to recall the stored waveform.

- Press the **display** key to turn on the m3 display.
- Press the **CHAN** menu key, change the **offset** of channel 1.

This moves the current display so the stored waveform can be viewed. The display should look like the following figure.

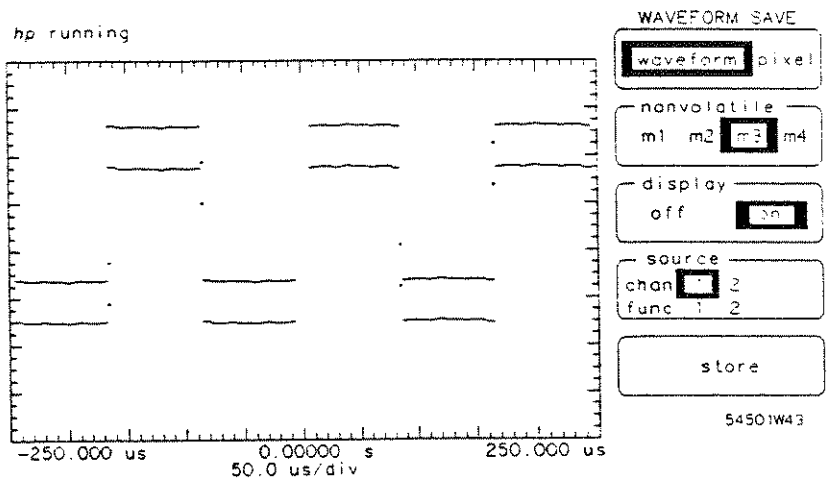

Figure 10-2. Displayed Memory

Introduction to Measurements

This chapter contains a description of the measurement menu. The entire measurement function, with all possible options, is accessed with the **DEFINE MEAS** menu.

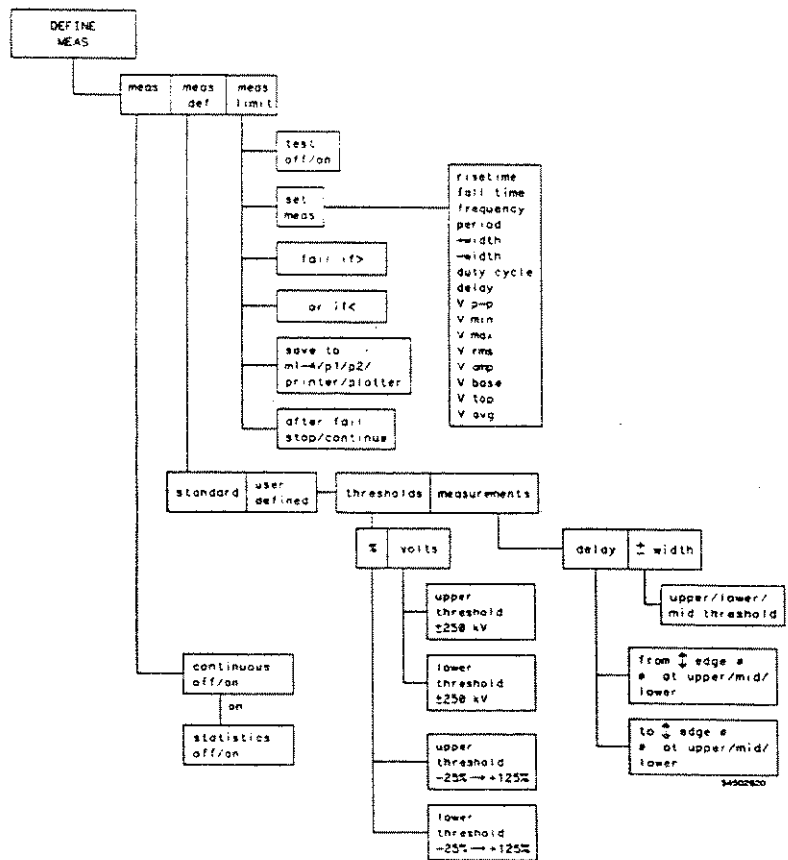

Figure 11-1. Define Measure Menu

The first menu sets the dynamic controls for measurements. The second menu sets user-defined parameters for the measurements. The third menu sets up the measurement comparison test.

Measurement Selection

Each key in the numeric keypad section has a secondary function. Above each key is a measurement selection printed in blue. To make an immediate measurement of the displayed waveform perform the following keystrokes:

- Press the blue (Shift) key on the numeric keypad to access the secondary keys.
- Press the key that corresponds to the measurement about to be made.
- Rotate the knob to select the measurement source (channel number, c#; memory number, m#; or function number, f#). The choice made is displayed below the waveform display area.
- Press the appropriate number to select the source, channels 1-2, memories 1-4, or functions 1-2.

To make a selected measurement on a waveform source, it must be turned on. Upon selection of the measurement the time and voltage markers are placed on the waveform to show where the measurement was made if continuous measurements are off.

To clear measurements, press Shift CLR MEAS.

For complete details of the measurement definitions and algorithms, see Appendix A, "Algorithms."

**meas/meas
def/meas limit
Key**

This key is the primary sub-menu selection key. Press to select one of the available sub-menus. This field is always the top selection so other submenus may be selected at any time.

meas Submenu

The measure submenu is the default condition. Continuous and statistics options are accessed from this submenu.

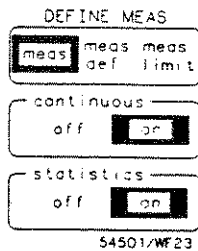

continuous Key

If this option is turned on when a measurement selection is made, the displayed measurement is updated periodically. All subsequent measurements are continuously updated when selected.

When **continuous** is off, the measurement is made once and the $\Delta t/\Delta V$ markers are placed on that measurement showing where the measurement was made.

statistics Key

The continuous function must be on before the statistics key is available. When **continuous** is on, statistics display the *min value*, *max value*, *average value*, and *current value* on up to three measurements.

Measure Define Sub-menu

The Measure Define submenu selects measurement standards assigned by the user. This gives the option of making measurements based on signal width or delay settings or threshold parameters.

standard/user defined Key

If **standard** is selected, no other choices are available and the HP 54504A makes measurements based on IEEE standards.

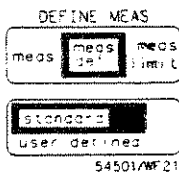

If, however, **user defined** is selected, two sets of test conditions are available to define the measurements.

thresholds/measurements Key

This key sets vertical test conditions, voltage or percentage ratios, independent of the horizontal test conditions, edge, slope, and count. Both sets of test conditions must be set to define the measurement.

The **thresholds** submenu sets the vertical test conditions at:

- percentage ratio from -25% to 125%
- voltage levels from -250 kV to +250 kV

Note

The upper and lower thresholds must be set to levels that will fall on the displayed waveform. If either threshold is not on the waveform the measurement results will be the message 'not found.'

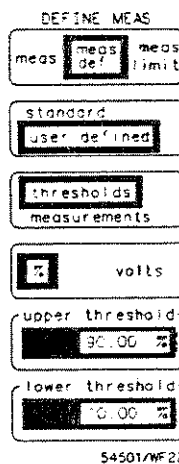

Threshold settings apply to all user defined front panel measurements.

This feature is useful when measuring for excessive overshoot or ringing. By defining the measurements, testing for pass/fail criteria of any choice. Test from the front panel, or set the HP 54504A in the limit test and allow the oscilloscope to report without supervision.

Note

If the user defined upper and lower thresholds are placed too close together it is possible the HP 54504A will not be able to determine the mid-point. The message 'not found' will be displayed in the measurement factors area.

Measurements define more parameters, the horizontal test conditions, for three specific front panel keypad measurements:

- Delay
- + width
- - width

When any of the three measurements are selected the measurement is made on the selected edge count, slope, and transition point. The HP 54504A starts counting edges from the left edge of the screen, not at the reference point. The selected edge must be displayed. If the edge is not displayed, the message *not found* is displayed in the measurement results area below the screen.

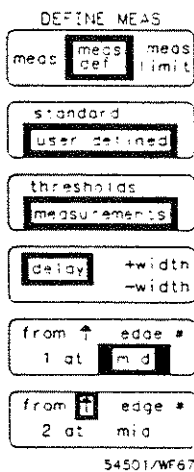

Measurement delay, not to be confused with timebase delay (see Chapter 4, "Timebase Menu") is useful when measuring source-to-source delays or measuring time separation on the same source or a different source. The front panel delay measurement can be redefined by edge slope, edge count (from 1 to 100), and what part of the transition edge (upper, lower, mid) is used as a reference point.

- When setting edge count fields, it is handy to press the fine key. In the course mode the HP 54504A increments/decrements by tens (1, 11, 21, ..., 100). In the fine mode the increment/decrement sequence is in 1's.

When the delay measurement is selected from the front panel, the source (c#, f#, m#) and the source number must also be selected.

+ width allows choice of only the point on the waveform transition (upper, lower, mid) to measure when making the positive width of a displayed waveform.

- width allows the choice of only the point on the waveform transition (upper, lower, mid) to measure when making the negative width of a displayed waveform.

Measure Limit Sub-menu

```

DEFINE MEAS
meas meas meas
def  limit
test
off on
set
period
fail if >
50.0000 s
or if <
1.000 ns
save to
off m1 m2 m3 m4
p1 p2 hardcopy
after save
stop continue
54504W06
  
```

The HP 54504A can run limit tests on up to three measurements. The menu presets certain conditions and stores any failure data for evaluation at a later time. Set the limit test while in this menu and select the measurement from the front panel.

When a test is running, statistical data is displayed describing the test:

- current measurement
- minimum value
- maximum value
- average value

Failure data, as well as information regarding memory and save data is displayed.

Note

At least one measurement and up to three measurements must be selected from the keypad. The limit test will be run on front panel measurements.

test Key This key toggles the test routine on or off. When the test is turned on the oscilloscope starts running in the test mode on the most current measurements that have been selected.

set Key This key selects the measurement. There are sixteen measurements available; the same ones as are available on the numeric keypad.

- Press the function key to highlight the field and rotate the knob to select the desired measurement.

Note

This key does not select the measurements on which the limit test operates, that selection is made from the keypad with the blue (Shift) key.

fail if > Key This field sets the upper failure threshold. The range on this field is dependent upon the units of the desired measurement.

or if < Key This key sets the lower threshold of the failure parameters.

save to Key Key saves the data associated with the failure to memories or to a hardcopy device. The source of the save is selected in the WAVEFORM SAVE menu.

- In the case of saving to nonvolatile memory, one memory may be selected. If multiple failures occur, only the last failure data is saved because the most current data will overwrite the memory contents.
- If the data is saved to pixel memory, an accumulated save occurs. No measurements may be made on the pixel data.
- A save to a printer immediately sends the data to the peripheral device.
- The save to key can be turned off and no save is effected.

after fail Key The test can be stopped when a failure occurs, or can be continued.

Introduction to the Utilities

The **UTILITY** menu accesses the calibration and service functions, as well as sets up the HP-IB interface. The submenus include self-test, calibration, service and a listing for the current firmware revision date.

This menu controls all of the service functions that maintain the reliable performance of the oscilloscope.

These submenus are part of the **UTILITY** menu:

- HP-IB menu
- selftest menu
- probe cal menu
- self cal menu
- service menu

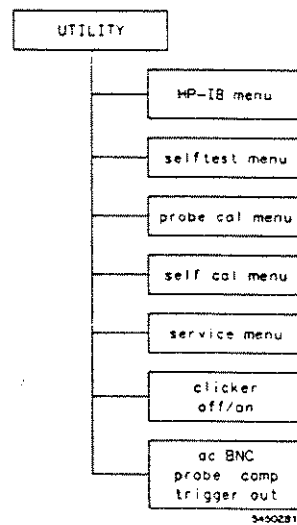
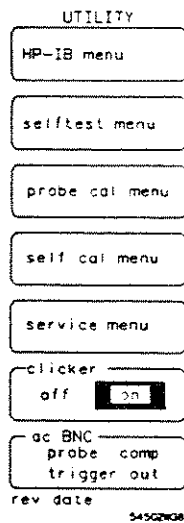
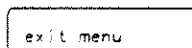
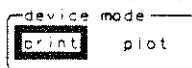
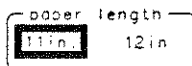
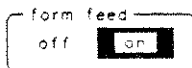
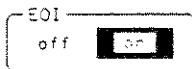

Figure 12-1. Utility Menu

HP-IB menu



54503W01

The HP-IB submenu makes settings so the HP 54504A can talk to peripheral devices. This interface includes two primary settings:

- Talk-only mode
- Addressed mode

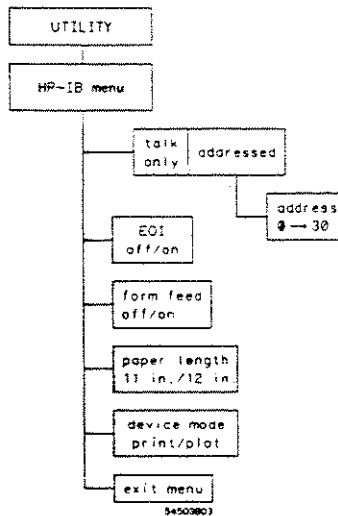

Figure 12-2. HP-IB Menu

- talk only mode** Set the oscilloscope to **talk only** to perform a hardcopy without intervention from an external controller. The attached printer must be set in the **listen only** or **listen always** mode.
- addressed mode** This mode selectively addresses the HP 54504A for talking or listening. The address of the HP 54504A can be selected while the instrument is in the addressed mode.

The range of available addresses is 0-30.

EOI Key The EOI (End or Identify) key toggles this function on or off. EOI is a line on the HP-IB asserted with the last data byte of a message. If this function is on, EOI is asserted by the HP 54504A on the last byte of each message sent. If it is off, EOI is not asserted.

This function only affects messages sent from the HP 54504A. The HP-IB accepts any of the legal IEEE 488.2 message terminators regardless of the setting of this function.

Note

IEEE 488.2 requires that EOI is asserted. Therefore, with EOI off, the HP 54504A will send messages that do not follow IEEE 488.2 rules concerning EOI. EOI should only be turned off if the controller does not deal with EOI appropriately.

form feed Key If the form feed option is on, the printer performs a form feed at the end of the hardcopy. If form feed is off, the page is scrolled up four lines when the hardcopy is complete.

paper length Key Select between 11-inch or 12-inch pagelengths for auto form feed. This is used to set the 11-inch page, the U.S. standard, or the 12-inch page, U.K. and European standard.

device mode Key This key selects whether the hardcopy goes to a printer or plotter. The HP 54504A sends hardcopy to HP printers and plotters with HP-IB options.

The following printers have been successfully tested with the HP 54504A: HP 2225A HP-IB ThinkJet, HP 2227B QuietJet, and HP 3630A Option 002 PaintJet.

The following plotters have been tested successfully with the HP 54504A: HP 7440A Option 002 Color Pro, HP 7470A Option 002, HP 7475A Option 002, HP 7550A and HP 9872C.

exit menu Key Pressing exit returns the UTILITY menu to the screen.

SELFTEST MENU

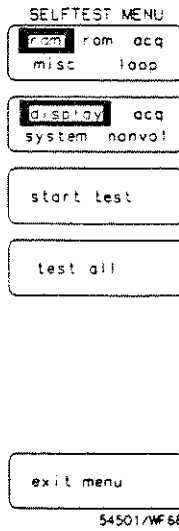

The HP 54504A is designed to perform internal diagnostics. This selftest submenu tests the oscilloscope to give a high confidence level of instrument functionality. Before starting any self-test, always perform a key-down power-up (RECALL CLEAR). This resets critical parameters to known values to assure erroneous test failures do not occur.

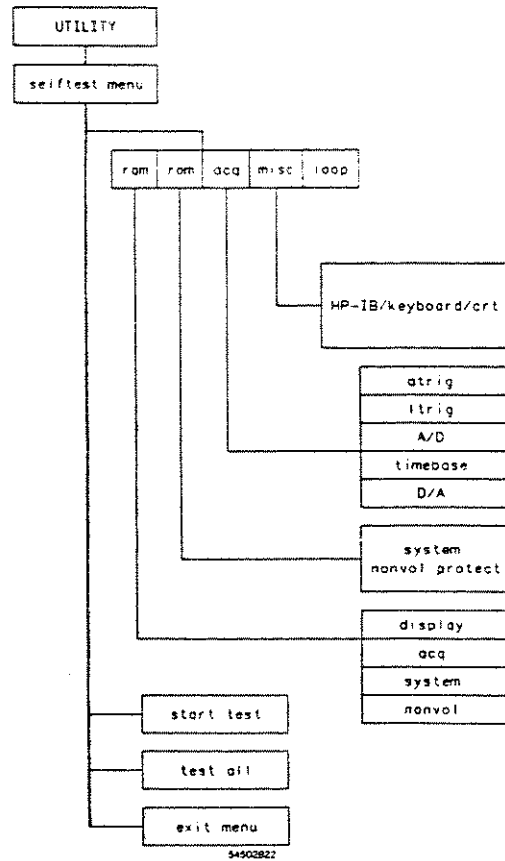

Figure 12-3. Self-Test Menu

If the HP 54504A fails any selftest perform the following:

- Recalibrate the oscilloscope.
- If that does not fix the problem, refer to the *HP 54504A Service Manual*.

The HP 54504A self-diagnostics and self-tests are designed to run operational tests on the following:

- RAM
- ROM
- Acquisition
- Miscellaneous

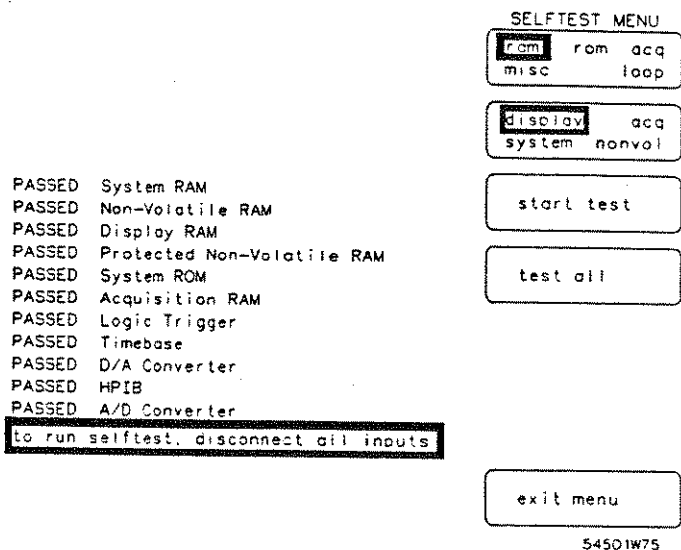

Figure 12-4. Results of Selftest

ram Test The RAM test is a multiple selection field. The options are:

- display
- acquisition
- system
- unprotected nonvolatile memory

rom Test Two ROM tests are available:

- system
- protected nonvolatile memory

acquisition Test Five acquisition tests are available:

- atrig
- ltrig
- A/D
- timebase
- D/A

Miscellaneous Test Three miscellaneous tests are available:

- HP-IB
- keyboard
- CRT

loop Test The loop test is a function designed for use by qualified service personnel. It is unnecessary to use this function for normal oscilloscope operation. When a self-test loop has been initiated it runs until stopped by pressing and holding any key.

start test Key Pressing this key begins the selected test.

test all Key This key runs all tests in sequence.

exit menu Key Pressing this key returns the Utility menu to the screen.

PROBE CAL MENU

Two probe calibration procedures are available in the probe cal menu:

- attenuation
- time null

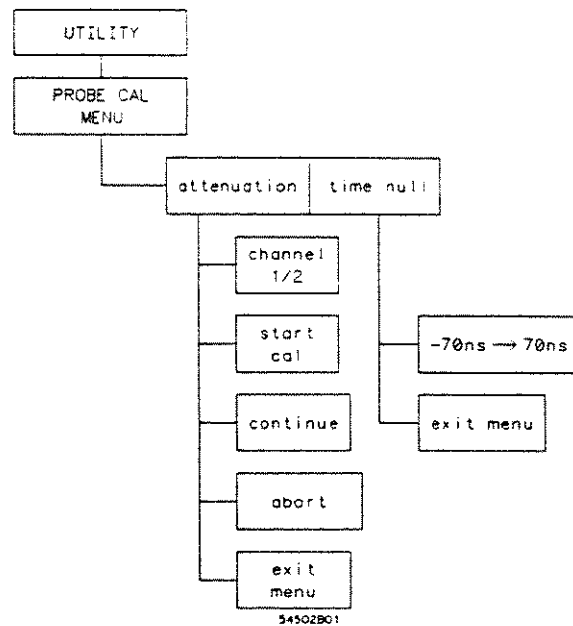
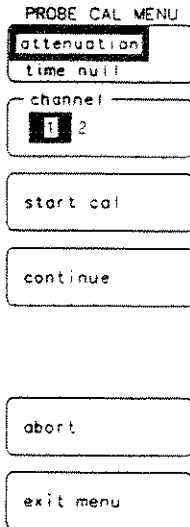

Figure 12-5. Probe Cal Menu

attenuation submenu



54502W04

The attenuation submenu calibrates channel gain at the probe tip. Channel gain can be corrected through probe attenuation down to 0.9 attenuation.

- Below 0.9 the error message *Attenuation less than 1, see manual for action* is displayed. The corrective action is to recalibrate the HP 54504A.

If the probe is not connected to the DC CALIBRATOR OUTPUT on the rear panel or the probe attenuation exceeds approximately 250, the error message *Attenuation too high or bad connection* is displayed. The corrective action is to check the connections and recalibrate. If recalibration is unsuccessful, refer to the *HP 54504A Service manual*.

- If the probe attenuation calibration is successful the displayed message is *Probe Attenuation = n.nnnnn This value has been entered into your channel probe setting.*

channel Key Pressing this key selects a channel to calibrate.

start cal Key When the channel to be calibrated has been selected, press **start cal**. The advisory appears at the bottom of the waveform display area *Connect the DC Cal rear panel bnc to the probe of channel n, then press continue*. Pressing this key prompts for setup requirements.

continue Key Press this key when all setup requirements have been satisfied. The actual calibration process begins.

abort Key This is the only active front panel key during the calibration process. The calibration process is terminated with the previous calibration factors intact when this key is pressed.

exit menu Key Pressing this key returns the Utility menu to the screen.

time null submenu

Time null sets the timing of all channels to correspond to each other at the probe tip. This eliminates time discrepancies between channels and channel-to-channel skew variations. This is useful to manually adjust any differences in cable length.

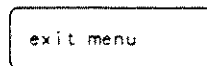
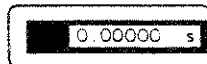
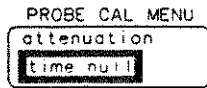

54502W03

time Key This is an unlabelled field. The time null between the two channels can be set using either of the entry devices. The range is ± 70 ns.

exit menu Key Pressing this key returns to the Utility menu.

Self Cal menu

The self cal menu calibrates two internal functions:

- vertical cal
- delay and repetitive cal

cal select Key This field selects which of the calibration processes to perform. The cal select key and the highlighted window increments through 0-1 and the active field in the display changes to correspond with the selection. See Calibration procedure in this chapter.

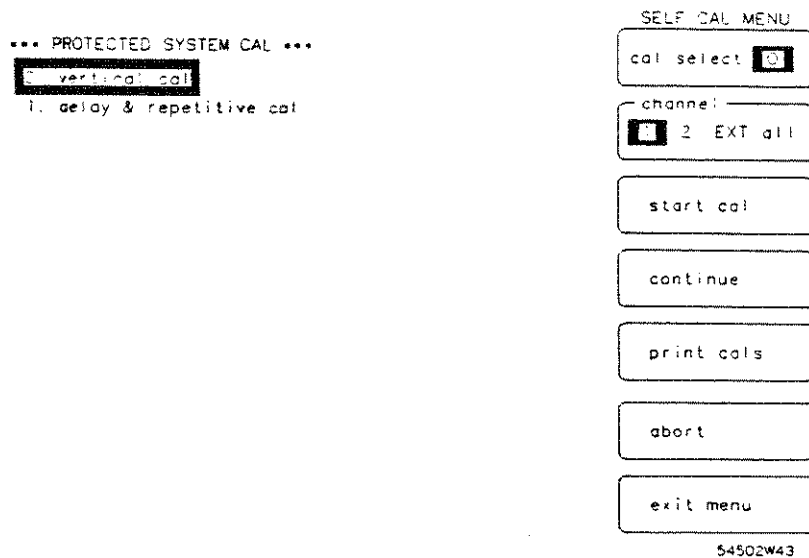

Figure 12-6. Self Cal Options

NOTE

Cal 0 must pass before Cal 1 can be performed successfully.

- channel Key** The channel key selects the channel to calibrate.
- start cal Key** When the channel to calibrate is selected, and the specific cal routine is selected, press the **start cal** key and follow the instructions displayed.
- print cals Key** The print cals key sends a complete listing of the most recent self calibration factors to a printer, if connected to the oscilloscope. Refer to the service manual for more information on self calibration and calibration factors.
- continue Key** When all of the setup requirements are satisfied, press the **continue** key and the actual calibration process begins.
- abort Key** This is the only active front panel key during the calibration process. Pressing this key terminates the calibration process leaving the previous calibration factors intact.
- exit menu Key** This key returns to the Utility menu.
-

service menu

The service menu is used firmware calibrations, hardware adjustments, and calibrations that need not be performed often. These are explained in the service manual and are to be used only by qualified service personnel.

Note

When certain calibrations have been performed, other calibrations must be continued. Only qualified service personnel, with access to the service manual, are to perform calibrations in the service menu.

See the *HP 54504A Service Manual* for complete information on the service menu and calibration cycles.

clicker Key

The clicker key turns on the clicker function. When the clicker is turned on, an audible click is heard each time a key is pressed. The selections are either on or off.

ac BNC Key

The ac BNC key selects the output for the rear panel BNC. The probe compensation signal is a square wave of approximately 500 Hz. When trigger out is selected, the BNC is a trigger output.

Calibration Procedure

There are two levels of calibration for the HP 54504A. The first level is in the self cal menu and suggested by HP to be performed under the following conditions:

- at six month intervals or every 1000 hours of use
- if the ambient temperature changes more than 10° C from the temperature at full calibration
- the user would like to optimize measurement accuracy

Self cals do not require any equipment other than cables. It is necessary to UNPROTECT the calibration which may not be allowed in some circumstances. Follow the Self Cal Menu calibration procedures to perform this first level of self cal.

The second level of self calibrations are to be performed only by qualified service personnel with access to the service manual.

Note

Before the HP 54504A can be calibrated the CALIBRATION toggle switch on the rear panel must be set to UNPROTECTED.

The procedure for calibration is:

- Set the rear panel CALIBRATION switch to UNPROTECTED. .
- Select 0 in the cal select field and calibrate the vertical factors. This routine calibrates the A/D, vertical gain, offset, and trigger with the rear panel dc calibrator signal.
- Select 1 in the cal select field and calibrate the delay and the repetitive factors. This procedure uses the rear panel ac calibrator signal.

When the software calibrations are complete reset the CALIBRATION toggle switch on the rear panel to PROTECTED.

One of the primary features of the HP 54504A is the ability to make automatic measurements on displayed waveforms. This chapter provides details on how automatic measurements are calculated and some tips on how to improve results.

Measurement Setup

Measurements typically should be made at the fastest possible sweep speed for the most accurate measurement results. The entire portion of the waveform that is to be measured must be displayed on the oscilloscope. For the most accurate measurements, consider the following conditions:

- at least one complete cycle must be displayed for period or frequency measurements
 - the entire pulse must be displayed for width measurements
 - the leading edge of the waveform must be displayed for risetime measurements
 - the trailing edge of the waveform must be displayed for falltime measurements
-

Making Measurements

If more than one waveform, edge, or pulse is displayed, the measurements are made on the first (leftmost) portion of the displayed waveform that can be used. If there are not enough data points the oscilloscope will display \leq with the measurement results. This is to remind you that the results may not be as accurate as possible. It is recommended that you re-scale the displayed waveform and make your measurement again.

Standard Measurements

When any of the standard measurements are requested, the HP 54504A first determines the top-base voltage levels at 100%-0%. From this information, it can determine thresholds (10%, 90%, and 50%) needed to make the measurements. The 10% and 90% thresholds are used in the risetime and falltime measurements. The 50% midpoint is used for measuring frequency, period, pulse width, and duty cycle.

The voltage thresholds are precise settings and sets specific locations on the waveform. If the thresholds are not placed on the waveform (above or below) the HP 54504A cannot make a measurement.

User defined Measurements

When any of the user defined measurements are requested, the HP 54504A still must determine the top-base voltage thresholds. From this information it can determine user defined upper and lower thresholds. The mid-point is then determined to be the 50% point between the upper and lower threshold.

Automatic Top-Base

Top-Base is the heart of most automatic measurements. It is used to determine V_{top} and V_{base} , the 0% and 100% voltage levels at the top and the bottom of the waveform. From this information the oscilloscope can determine the 10%, 50%, and 90% points, which are also used in most measurements. The top or base of the waveform is not necessarily the maximum or minimum voltage present on the waveform. Consider a pulse that has slight overshoot. It would be wrong to select the highest point of the waveform as the top since the waveform normally rests below the perturbation.

Top-Base performs a histogram on the waveform and finds the most prevalent point above and below the waveform midpoint. The most prevalent point is one that represents greater than approximately 5% of the total display points (501) and is considered to be either the top or base. If no point accounts for more than 5% of the total, then the top is chosen as the absolute maximum and the base is chosen as the absolute minimum.

Edge Definition

Both rising and falling edges are defined as transitional edges that must cross three thresholds.

A rising edge must cross the lower threshold in a positive direction (defining it as a rising edge), cross the mid threshold (any number of crossings, both positive and negative are permissible) and then cross the upper threshold without any crossing of the lower threshold.

A falling edge must cross the upper threshold in a negative direction, cross the mid threshold (any number of times), and then cross the lower threshold without crossing the upper threshold.

Note

Most time measurements are made based on the position of the first crossing of the middle threshold.

Algorithm Definitions

Following are the definitions that all measurements are based on:

delay There are three types of delay measurement:

- jitter
- standard
- user-defined

Jitter occurs only under the following circumstances:

- standard/user-defined key is set to standard
- two delay parameters are the same
- display mode is envelope

```

if
  first edge on minimum waveform is rising
then
  delay = mid-threshold of first rising edge of max waveform minus
  mid-threshold of first rising edge on min waveform
else
  delay = mid-threshold of first falling edge on min waveform
  minus mid-threshold of first falling edge on max waveform

```

The standard delay measurement occurs when in the standard mode (not user-defined) and is not a jitter measurement.

standard delay = mid-threshold of the first edge of second parameter minus mid-threshold of the first edge of the first parameter

Note

Negative delay is possible.

User defined delay = second channel edge minus first channel edge

+ width The + width algorithm has standard and user-defined considerations.

```

if
  first edge is rising
then
  + width = mid-threshold crossing of first falling edge -
  mid-threshold crossing of first rising edge
else
  + width = mid-threshold crossing of second falling edge -
  mid-threshold crossing of first rising edge

```

User-defined is the same as Standard definition except user-defined threshold.

- width The - width algorithm has standard and user-defined considerations:

if
first edge is rising
then
- width = second rising edge - first falling edge
else
- width = first rising edge - first falling edge

Period **if**
first edge is rising
then
period = second rising edge - first rising edge

Frequency frequency = 1/period

Duty Cycle duty cycle = (+ width/period) * 100

Note

+ width is always calculated using mid-threshold.

Risetime risetime = time at upper threshold - time at lower threshold

Falltime falltime = time at lower threshold - time at upper threshold

V_{max} V_{max} = voltage of the maximum point on screen

V_{min} V_{min} = voltage of the minimum point on screen

V_{p-p} $V_{p-p} = V_{max} - V_{min}$

V_{top} **V_{top} = most prevalent point above waveform midpoint**

V_{base} **V_{base} = most prevalent point below waveform midpoint**

V_{amp} **V_{amp} = V_{top} - V_{base}**

V_{avg} **Average voltage of the first cycle of the displayed signal is measured. If a complete cycle is not present the oscilloscope averages all data points.**

V_{rms} **The rms voltage of the first cycle of the displayed signal is measured. If a complete cycle is not present, the measurement computes rms on all data points.**

$$V_{rms} (ac) = \left\{ \frac{1}{t} \sum v^2 (t) - \left[\frac{1}{t} \sum v (t) \right]^2 \right\}^{1/2}$$

Specifications and Characteristics

Specifications

The following are performance specifications for the HP 54504A Digitizing Oscilloscope.

Vertical

Bandwidth (-3dB, dc coupled)

Real-time: dc to 50 MHz

Repetitive: dc to 400 MHz¹

Risetime²

Realtime: 7.0 ns

Repetitive: 875 ps

Input R (selectable): 1 M Ω \pm 1% or 50 Ω \pm 1%

Maximum Input Voltage³

1 M Ω : \pm 250 V [dc + peak ac(< 10 kHz)]

50 Ω : 5 Vrms

Offset Accuracy⁴ \pm (0.5 % of ch. offset + 2% of full scale)

Voltage Measurement Accuracy (dc)^{4,5}

Dual Cursor: \pm (1.25% of full scale + 0.032 \times V/div)

Single Cursor: \pm (1.25% of full scale + offset accuracy + 0.016 \times V/div)

Horizontal

Time Base Reference Accuracy: 0.01%

Delta-t Accuracy

Real-time: \pm (0.2% of screen diameter + 0.01% \times delta-t + 500 ps)

Repetitive: \pm (0.2% of screen diameter + 0.01% \times delta-t + 200 ps)

Trigger

Trigger Sensitivity⁴

Internal - dc to 50 MHz

Real-time and repetitive: 0.5 division

HP 54504A
Front-Panel Reference

Specifications and Characteristics
B-1

Internal - 50 MHz to 100 MHz

Real-time: N/A

Repetitive: 0.125 × full scale

External - dc to 250 MHz

100 mV_{p-p} into 50Ω

NOTES: Specifications valid for temperature range ±10°C from software calibration temperature with eight or more averages selected.

1. Upper bandwidth reduces by 2.5 MHz for each °C above 35°C. For time/div ranges 1 μs/div and slower, bandwidth in repetitive mode is 100 MHz.
2. Rise time figures are calculated from: $t_r = 0.35/\text{Bandwidth}$.
3. On ranges ≤50 mV/div, the maximum overdrive of the input must not exceed 1000 times the V/div setting.
4. Expansion is used below 7 mV/div range so vertical resolution and accuracies are correspondingly reduced. Below 7 mV/div full scale is defined as 56 mV.
5. Vertical gain accuracy decreases 0.08% per °C from software calibration temperature.

Characteristics

The following are performance characteristics of the HP 54504A Digitizing Oscilloscope.

Vertical

Switchable Bandwidth Limits

ac-coupled (lower -3 dB frequency): 90 Hz

LF reject (lower -3 dB frequency): 450 Hz

bandwidth limit (upper -3 dB frequency): 30 MHz

Number of channels: 2(simultaneous)

Vertical Sensitivity Range: 1 mV/div to 5 V/div

Vertical Gain Accuracy (dc):^{1,2} ±1.25% of full scale

Vertical Resolution:^{2,3} ±0.1% of full scale (8-bit A/D) 10 bits with averaging over HP-IB)

Maximum Sample Rate

Real-time: 200 MSa/s

Repetitive: 25 MSa/s

Repetitive:	Time/div	5 ns - 5s/div	2 ns/div	1 ns/div
	Record Length	501 pts	401 pts	201 pts

Waveform Record Length⁴

Realtime - Normal: 501 points

Realtime - Extended: 2001 points

Input C: 7 pF nominal

Input coupling: ac, dc

Offset Range:	Vertical Sensitivity	Available Offset
	2 mV - 50 mV/div	±2 V
	> 50 mV - 250 mV/div	±10 V
	> 250 mV - 1.25 V/div	±50 V
	> 1.25 V - 5 V/div	±250 V

Dynamic range: ±1.5 × full scale from center of screen

Channel-to-channel Isolation: (with channels at equal sensitivity)

Realtime	Repetitive
40 dB: dc to 50 MHz	40 dB: dc to 50 MHz
	30dB: 50 to 400 MHz

NOTES: Specifications valid for temperature range ±10°C from software calibration temperature with eight or more averages selected.

1. Vertical gain accuracy decreases 0.08% per °C from software calibration temperature.
2. Expansion is used below 7 mV/div range so vertical resolution and accuracies are correspondingly reduced. Below 7 mV/div full scale is defined as 56 mV
3. Available over HP-IB, waveform record length is:

Real-time-	Normal: 500 points	Extended: 2000 points
Repetitive-	10 ns - 5 s/div	1024 points
	5 ns/div	1000 points
	2 ns/div	400 points
	1 ns/div	200 points

Horizontal

Timebase Range: 1 ns/div to 5 s/div

Timebase Resolution: 50 ps repetitive, 5 ns realtime

Delay Range (post-trigger):

<u>Time/div Setting</u>	<u>Available Delay</u>
50 ms - 5 s	$40 \times (\text{s/div})$
100 μs - 20 ms	1 s
1 ns - 50 μs	$10,000 \times (\text{s/div})$

Delay Range (pre-trigger):

Realtime	Repetitive
<u>All Time/div Settings</u>	<u>Time/div Setting</u>
<u>Available Delay</u>	
$40 \times (\text{s/div})$	$2 \mu\text{s} - 5 \text{s/div}$
$40 \times (\text{s/div})$	
10 ns - 1 $\mu\text{s/div}$	80 μs
1 ns - 5 ns/div	$10\,000 \times (\text{s/div})$

Trigger

Trigger Pulse Width: (minimum)	Real-time	Repetitive
Internal	14 ns	1.75 ns
External	2.8 ns	2.8 ns

Trigger Level Range

Internal: $\pm 1.5 \times$ full scale from center of screen
External: $\pm 2 \text{ V}$

Operating Characteristics

Vertical Deflection Factors: Channels 1 and 2: With single screen selected, attenuation factors are adjustable from 1 mV/div to 5 V/div in a 1-2-5 sequence with the knob. Finer adjustments can be made using direct keypad entry or the knob with the FINE key selected.

Probe Attenuation Factors: Values from 0.9 to 1000 may be entered to scale the oscilloscope for external probes or attenuators attached to the channel inputs. When probe tip calibration is done, this value is calculated automatically.

Input Impedance: 1 M Ω or 50 Ω , selectable for CH1, CH2 and external.

Bandwidth Limit (HF Reject): Provides low pass filter with a -3 dB point at approximately 30 MHz for both triggering and signal display. Can be selected for each vertical input individually.

LF Reject: Provides high pass filter with a -3 dB point at approximately 450 Hz for triggering and vertical signal. Can be selected for each vertical input individually.

AC Coupling: Provides high-pass filter with a -3 dB point at approximately 90 Hz for both triggering and signal display. Can be selected for each vertical input individually.

ECL/TTL Presets: Vertical deflection factor, coupling, offset, and trigger level can be preset independently on both channels for ECL and TTL levels.

Effective Resolution: Vertical resolution refers to the oscilloscope's ability to resolve small incremental differences in voltage. This characteristic is often assumed to be directly related to the number of bits in the instrument's analog-to-digital conversion system.

In fact, the A/D resolution is only one of several components of vertical performance. Hewlett-Packard single-shot digitizing oscilloscopes are characterized for Effective Bits of resolution. This method considers quantization error, A/D non-linearities, and system noise, all of which affect the measurement accuracy of the instrument. Typical performance:

Frequency:	1 MHz	10MHz	22MHz	150Hz
Eff. Bits:	6.0 Bits	6.0 Bits	5.9 Bits	5.4 Bits

For more information about effective resolution, please contact your Hewlett-Packard sales office, and ask for Product Note 5180A-2, "Dynamic Performance Testing of A to D Converters," (pub # 02-5952-7629).

Horizontal Dual Timebase Windowing: Allows user to zoom in on portions of the waveform using time markers that are displayed on the top half of the screen. An expanded time base is displayed on the lower half of the screen. The window time base can be set to provide as much as a 20:1 expansion ratio.

Waveform measurements are performed only on the the dual time base window information when windowing is turned on.

Delay Between Channels: Difference in delay between channels can be nulled out to compensate for differences in input cables or probe length. Use "time null cal," found in the Probe Cal menu (see UTIL key).

Reference Location: The reference point can be located at the left edge, center, or right edge of the display. The reference point is defined as the trigger point plus the delay time.

Trigger Modes Edge Trigger: Positive or negative edge can be selected for trigger on channels 1 and 2 or on the external trigger input.

Pattern Trigger: A pattern can be specified using channels 1, 2 and the external trigger input. Each of the inputs can be specified as a *high*, *low*, or *don't care* with respect to the level setting in the edge trigger menu. Trigger can be selected to occur on the last edge to enter the specified pattern or the first edge to exit the specified pattern.

Time Qualified Pattern Trigger: A trigger will occur on the first edge to exit a pattern only if it meets the specified time criteria. The available time qualified modes are:

- pattern present < [time]
- pattern present > [time]
- range: pattern present > [time1] and < [time2]

The time settings are adjustable from 20 ns to 160 ms ($\pm 3\%$ ± 2 ns). The time filter recovery time is ≤ 12 ns. In the "pattern present < [time]" mode, the pattern must be present > 1.75 ns, repetitive mode, (14 ns for the real-time mode) for the trigger to respond.

Glitch Trigger: Use "pattern present < [time]" with [time] selected such that it is just less than the nominal pulse width of the signal you are analyzing. The minimum glitch width is 1.75 ns, repetitive mode, (14 ns for the real-time mode,) and 2.8 ns for external trigger.

State Trigger: A pattern is specified on any two of the three inputs with the third input used as clock. A trigger will occur on the rising or falling edge of the input specified as the clock when the pattern is present or not present. Setup time for the pattern with respect to the clock is ≤ 10 ns; hold time is zero.

Delayed Trigger

Event-delayed mode: The trigger can be qualified by an edge, pattern, time qualified pattern or state. The delay can be specified as a number of occurrences of a rising or falling edge of any of the three inputs. After the delay, an occurrence of a rising or falling edge of any of the three inputs will generate the trigger. The trigger occurrence value is selectable from 1 to 16 000 000. The maximum edge counting rate is 70 MHz.

Time-delayed Mode: The trigger can be qualified by an edge, pattern, or state. The delay is selectable from 30 ns to 160 ms. After the delay, an occurrence of a rising or falling edge of any of the three inputs will generate the trigger. The trigger occurrence value is selectable from 1 to 16 000 000. The maximum edge counting rate is 70 MHz.

TV Trigger

60 Hz / 525 lines: Source is selected to be any one of the three inputs. Trigger level is adjustable for the selected source. Polarity is selected for positive or negative synchronizing pulses. A trigger occurs on the selected line and field of a 2/1 interlaced composite video signal. Line

numbering is 1 to 263 for field 1 and 1 to 262 for field 2. This TV trigger mode is compatible with broadcast standard M.

50 Hz / 625 lines: Same as 60 Hz / 525 lines except that line numbering is 1 to 313 for field 1 and 314 to 625 for field 2. This TV trigger mode is compatible with broadcast standards B, C, D, G, H, I, K, K1, L and N.

User-defined mode: Source is selected to be any one of the three inputs. Trigger level is adjustable for the selected source. The trigger is qualified with a high or low pulse that meets a select-able time range. The trigger is an occurrence of a rising or falling edge of the source after the qualifying pulse. The time settings for the qualifier are selectable from 20 ns to 160 ms. The trigger occurrence value is selectable from 1 to 16 000 000.

NOTE: All TV trigger modes require a clamped video signal for stable triggering. Use the HP 1133A TV/Video Sync Pod to provide clamped video output that can be used in conjunction with the TV triggering capabilities.

Trigger Holdoff: Trigger can be held off either by time or events over the ranges:

- time: 40 ns - 320 ms
- events: 2 - 16 000 000

An event is defined as the specified trigger condition. A separate holdoff setting (time or events) is available for each trigger mode except delayed trigger, which is set to 40 ns.

Noise Reject Trigger: Provides improved triggering on noisy signals by increasing trigger hysteresis (internal trigger only).

Display

Data Display Resolution: 451 points horizontally by 256 points vertically.

Number of Screens: 1 or 2 screens can be selected. This can provide overlapping channels or memories for comparison, or separate displays on a split viewing area.

Display Modes

Averaging: The number of averages can be specified in powers of 2, up to 2048. On each acquisition, $1/n$ times the new data is added to $(n-1)/n$ of the previous value at each time coordinate. Averaging

operates continuously, except for the HP-IB digitize command, for which averaging terminates at the specified number of averages.

Envelope: Provides a display of the running maximum and minimum voltage levels at each horizontal time position.

Graticules: The user may choose full grid, axes, frame, or no graticule.

Connect-the-dots: Provides a continuous display, connecting the sample points with straight lines. Connect-the-dots is operative for modes in which a single-valued waveform can be connected, including average, envelope, single, and minimum-persistence modes. Connect-the-dots is not available in scroll mode or in real time infinite persistence mode.

Scroll Mode: The 54504A automatically selects scroll mode at time-per-division settings from 200 ms/div to 5 s/div if the scope is in Auto triggered mode, or, if the scope is in Triggered mode and has no pre-trigger data displayed (i.e. no negative time on screen). Scroll mode updates each data point on the displayed waveform as the data is acquired.

Time Base in Repetitive Mode.

Minimum Persistence: One waveform data value is displayed in each horizontal time position of the display. The waveform is updated as new data is acquired for a particular horizontal time position.

Variable Persistence: The time that each data point is retained on the display can be varied from 500 ms to 10 seconds, or the points can be displayed indefinitely.

Time Base in Real-time Mode.

Single Persistence: One waveform data value is displayed in each horizontal time position. The entire waveform is replaced with each new acquisition.

Infinite Persistence: Waveform data is allowed to continuously accumulate on the screen, and remains until display is cleared.

Display: Normal mode sets record length to 501 points. Extended mode sets record length to 2001 points.

Filter: At time-per-division settings between 500 ns/div and 5 s/div, a digital reconstruction filter can be switched ON or OFF as desired.

At time-per-division settings between 200 ns/div and 1 ns/div, a reconstruction algorithm is used to improve display of the waveform. The filter on/off menu is not available at these time/div settings. To look at data without the effect of this algorithm, change the time-per-division range to 500 ns/div, switch the filter OFF, stop the acquisition, clear the display, and press the SINGLE key. Using the time base window feature, you can now zero in on and expand sampled data.

Delta-t / Delta-V **Markers:** Dual voltage markers and dual time markers are available. Voltage markers can be independently assigned to channels, memories, or functions.

Waveform Math Two independent functions are provided for waveform math. The operators are +, -, x, vs, invert, and only. The vertical channels or any of the waveform memories can be used as operands for waveform math. Sensitivity and offset for these functions can be adjusted independently.

Waveform Save Four non-volatile waveform memories and two volatile pixel memories are provided. Waveform memories store single-valued waveforms, such as an averaged waveform. If an envelope waveform is stored to a waveform memory, it will automatically be stored with the upper waveform in one waveform memory and the lower waveform in another. Pixel memories store an entire screen of waveform data. They are very useful for storing multiple overlapping waveforms and infinite persistence waveforms. Automatic measurements may be performed on the four non-volatile waveform memories but not on the volatile pixel memories.

Automatic Pulse Parameter Measurements: Sixteen automatic pulse parameter measurements are offered via the front panel and additional measurements via HP-IB including All, Overshoot and Preshoot. The standard measurements are performed with 10%, 50% and 90% voltage thresholds, as defined by IEEE standard 194-1977, "IEEE Standard Pulse Terms and Definitions."

Automatic measurements available from the front panel:

Risetime	Pulse Width +	Volts amp	Volts avg	Preshoot
Falltime	Pulse width -	Volts base	Volts max	(HP-IB only)
Frequency	Duty Cycle	Volts top	Volts min	Overshoot
Period	Delay	Volts p-p	Volts RMS	(HP-IB only)

User-definable Measurement Thresholds

User defined thresholds can be set from the front panel for automatic measurements. Both the upper and lower thresholds can be set from 25% to 125%, as long as the upper threshold value is always greater than or equal to the lower threshold. The middle threshold is always equal to the mid-value between the upper and lower threshold.

Continuous Measurements: Can be turned on or off. With continuous measurements off, the voltage and time markers are placed on the waveform to indicate where the last measurement was taken.

Measurement Statistics: The maximum, minimum and average of continuously updated measurements are calculated and displayed. Any three measurements can be selected for simultaneous display.

Measurement Limit Test: Maximum and minimum limits can be set for any three of the front-panel automatic measurements. These continuously updated measurements are compared to the maximum and minimum limits. If the measurements are found to be outside the defined limits, the waveform can be stored to a memory or the screen can be sent to a printer. In addition, the HP-IB Service Request line can be set to flag the controller. Measurement limit test can be set to stop after test limits have been exceeded, or to continue testing.

Setup Aids

Auto-scale: Pressing the Auto-scale button automatically adjusts the vertical and horizontal deflection factors, and the trigger level for a display appropriate to the signals applied to the inputs. The Auto-scale feature requires a signal with a duty cycle greater than 0.5% and a frequency greater than 50 Hz. Auto-scale is operative only for relatively stable input signals.

Save/Recall: Four front panel setups (1-4) may be saved in non-volatile memory.

Recall Clear: Pressing the RECALL key followed by the CLEAR key resets the HP 54504A to its factory default settings.

Recall 0: If Auto-Scale, ECL or TTL preset, or recall setup are inadvertently selected, recall 0 restores the instrument to its last state prior to selection.

Show: Displays instrument status, including volts/div, offset, and trigger condition.

Hardcopy The CRT display, including menus and measurement answers, can be transferred directly to an HP-IB raster graphics printer or plotter, including the HP 2225A ThinkJet, HP 2227B QuietJet, other compatible printers, HP 7440A, HP 7470A, HP 7475A, and HP 7550A.

Full HP-IB Programmability The HP 54504A is fully programmable. Instrument settings and operating modes, including automatic measurements, may be remotely programmed via HP-IB (IEEE-488). HP-IB programming complies with IEEE 488.2-1988 "Standard Codes, Formats, Protocols, and Common Commands."

Data Acquisition and Transfer Rate: A 500-point data record can be acquired and transferred to a computer at a rate of approximately 10 times per second, as tested with an HP 9000, Series 200 Controller. The acquired data was type normal, completion criteria 100%, with the oscilloscope at a time/division setting of 5 s/div.

Data Transfer Rate: Approx. 120 Kbytes per second.

Probe Compensation, ac Calibrator Output: A 500 Hz (approx.) square wave is provided for probe compensation. A probe-to-BNC adapter is used to connect the probe to the rear panel Probe Compensation BNC output. During instrument self-calibration, this output is used to provide other calibration signals, as described in the Service Manual.

This same BNC connector is used for trigger output. The utility menu allows the user to switch the BNC from probe compensation and calibration signals to a trigger output pulse. The rising edge, with amplitude from approximately -400 mV to 0 V (when terminated into 50 Ω), is synchronous with system trigger. The falling edge of this pulse occurs approximately at the end of holdoff. The rising edge should be used as the edge synchronous with trigger.

dc Calibrator Output: This output is used for vertical calibration of the HP 54504A, as described in the Service Manual.

Product Support

Built-in Self test and Calibration Routines: Internal self test capabilities provide a 90% confidence the instrument is operating properly. External test procedures in the service manual provide a 100% confidence. Self-calibration routines, also selected through the front panel "utility" menu, ensure that the instrument is operating with its greatest accuracy and requires no external test equipment.

Low Cost of Ownership: The HP 54504A has a three year warranty. HP's board exchange program assures economical and timely repair of units, reducing cost-of-ownership.

Solutions: HP's System Engineering Organization can help you configure an HP-IB system and provide software support for your application, developing solutions to meet your measurement needs. Contact your Hewlett-Packard sales and service office for more information.

General Characteristics

Environmental Conditions

Temperature

Operating: 0°C to +55°C

Non-operating: -40°C to +70°C

Humidity

Operating: up to 95% relative humidity (non-condensing) at +40°C

Non-operating: up to 90% relative humidity at +65°C.

Altitude

Operating: up to 4600 meters (15 000 ft).

Non-operating: up to 15 300 meters (50 000 ft).

Vibration

Operating: Random vibration 5-500 Hz, 10 minute per axis, 0.3 G_{rms}.

Non-operating: Random vibration 5-500 Hz, 10 minute per axis, 2.41 G_{rms}; Resonant search 5 to 500 Hz swept sine, 1 Octave/minute sweep rate, (0.75G), 5 minute resonant dwell @ 4 resonances per axis.

HP 54504A
Front-Panel Reference

Specifications and Characteristics
B-13

Power Requirements Voltage: 115/230 V ac, -25% to +15%, 48-66 Hz.
Power: 350 VA maximum.

Weight Net: approximately 10 kg (22 lb).
Shipping: approximately 20 kg (44 lb).

Dimensions Refer to outline drawings below.

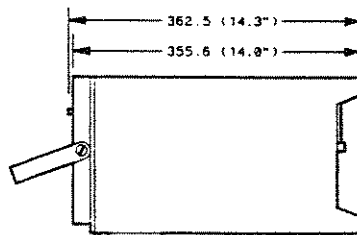
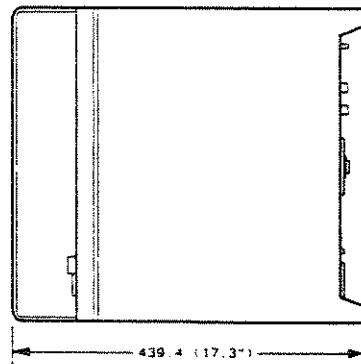

34501E13

NOTES

1. Dimensions are for general information only. If dimensions are required for building special enclosures, contact your HP field engineer.
2. Dimension are in millimetres and (inches).

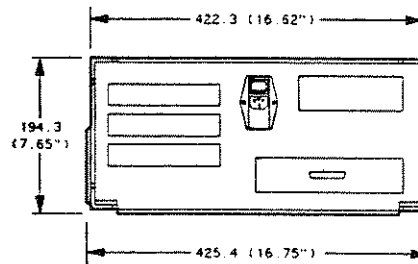

Specifications and Characteristics
B-14

HP 54504A
Front-Panel Reference

Index

!

+ width, A-4
- width, A-5

A

abort Key, 12-6, 12-8, 12-11
acquisition test, 12-5
acquisition, realtime, 4-5
acquisition, regular, 4-2
acquisition, repetitive, 4-5
acquisition, scroll mode, 4-2
add to memory Key, 10-3
addressed, 12-2
addressed menu, 12-2
after save Key, 11-8
Air Flow Requirements, 2-7
Algorithms, A-1
Altitude, 2-2
applying power, 2-1
attenuation menu, 12-7
auto triggered scroll, 4-2
auto-trigger, 3-2
Automatic measurements, 1-1
Automatic Top-Base, A-2
AUTOSCALE Key, 3-5
Available, 2-2
Available Accessories, 2-2

awaiting trigger, 3-2
axes, 7-6

C

cal select Key, 12-10
Calibration Procedure, 12-12
calibration protect, 2-3
Carrying Case, 2-2
chan/mem Key, 9-3
Channel coupling, SHOW, 3-6
CHANNEL Key, 5-1, 12-8, 12-11
Channel Menu, 5-1
Channel offset, SHOW, 3-6
Channel scaling, SHOW, 3-6
CLEAR DISPLAY Key, 3-3
CLEAR key, 3-9
clear memory Key, 10-3
clicker Key, 12-12
clock Key, 6-15
CLR MEAS key, 11-2
Condensation, 2-2
connect dots Key, 7-7
connect the dots, autoscaled, 3-5
Connecting External Equipment, 2-8
Contents of Shipment, 2-1
continue Key, 12-8, 12-11
continuous Key, 11-3
coupling Key, 5-3

HP 54502A
Front-Panel Reference

Index-1

D

D[delta]t markers, 8-3
D[delta]V markersDV markers, 8-2
damage, 2-1
data acquisition, 3-3
default conditions, 3-11
Define Measure Menu, 11-1
delay Key, 4-3, 6-22
Delay Trigger Exercise, 6-23
Delay Trigger Mode, 6-20
delayed sweep, 4-4
Display Intensity, 2-7
display Key, 9-2, 10-2 / 10-3
Display Menu, 7-1
Display Mode Key, 7-3
display record, autoscaled, 3-5
display section, 3-10
duty cycle, A-5

E

ECL/TTL presets, 3-5
Edge Definition, A-3
Edge Trigger Exercise, 6-4
edge Trigger Mode, 6-2
Entry, 3-8
Entry device section, 3-8
EOI Key, 12-3
Exercise
 Waveform Save, 10-4
 Delay Trigger, 6-23
 Edge Trigger, 6-4
 Pattern Trigger, 6-10
 State Trigger, 6-16
 tv Trigger, 6-29
 Window, 4-6

Index-2

Exercise, Waveform Math, 9-6
exit menu Key, 12-3, 12-6, 12-8, 12-11
External Equipment
 Connecting, 2-8

F

fail if, 11-8
falltime, A-5
falltime measurements, A-1
field Key, 6-28
filter, autoscaled, 3-5
FINE key, 3-8
FINE key, effect on timebase, 4-1
firmware revision, 12-1
form feed Key, 12-3
frame, 7-6
frequency, A-5
Front Panel Overview, 3-1
function display, 3-10
Function Key, 9-2
functional sections of front panel, 3-1

G

Gain cal, 12-10
grid, 7-6

H

hard reset, 3-11
HARDCOPY Key, 3-3
holdoff Key, 6-3, 6-10, 6-16, 6-28
holdoff, autoscaled, 3-5
HP-IB interface, 3-3
HP-IB menu, 12-2
Humidity, 2-2

HP 54502A
Front-Panel Reference

I

Input, 3-9
Instrument Reset, 3-11
Intensity Control, 2-7

K

key

CLR MEAS, 11-2
continuous, 11-3
EOI, 12-3
form feed, 12-3
or if, 11-8
RUN/STOP, 3-2
save after, 11-8
save to, 11-8
standard/user defined, 11-4
abort, 12-8, 12-11
add to memory, 10-3
AUTOSCALE, 3-5
cal select, 12-10
chan/mem, 9-3
channel, 12-11
Clear Display, 3-3
clear memory, 10-3
clock, 6-15
connect dots, 7-7
continue, 12-8, 12-11
coupling, 5-3
Delay, 4-3, 6-22
display, 10-2/ 10-3
Display Mode, 7-3
ECL, 5-5
exit menu, 12-3, 12-6, 12-8, 12-11
fail if, 11-8
field, 6-28

FINE, 3-9
Function, 9-2
Hardcopy, 3-3
holdoff, 6-3, 6-10, 6-16, 6-28
level, 6-3
level/polarity, 6-28
line, 6-28
Local, 3-3
meas/meas def/meas limit, 11-3
nonvolatile, 10-2
#, 7-5
off/frame/axes/grid, 7-6
offset, 5-2, 9-4
operand, 9-3
operator, 9-3
paper length, 12-3
pattern, 6-9
position, 4-5
present, 6-16
probe, 5-4
qualify on, 6-20
RECALL, 3-5
reference, 4-3
repetitive/realtime, 4-5
SAVE, 3-6
sensitivity, 9-4
set, 11-8
SHOW, 3-6
single, 3-3
slope, 6-3
source, 6-3, 6-27, 10-2
start cal, 12-8, 12-11
start test, 12-6
statistics, 11-3
store, 10-2
test, 11-7
thresholds/measurements, 11-4
Time/Div, 4-1
timebase, 4-5
trigger on, 6-23
TTL, 5-5
Vertical Sensitivity, 5-2

HP 54502A
Front-Panel Reference

Index-3

volatile, 10-3
waveform/pixel, 10-1
when, 6-9, 6-15
window, 4-4
Key-down power up, 3-11
knob, 3-8 / 3-9

L

level Key, 6-3
level/polarity Key, 6-28
line Key, 6-28
Line Switch, 2-5
line voltage selector, 2-4
List of Accessories, 2-2
LOCAL Key, 3-3
loop Test, 12-6

M

Making Measurements, A-1
markers, autoscaled, 3-5
Math function offset, SHOW, 3-6
Math function operation, SHOW, 3-6
Math function scaling, SHOW, 3-6
Maximum Vertical Sensitivity, 1-1
meas Sub-menu, 11-3
meas/meas def/meas limit Key, 11-3
Measure Define, 11-4
Measure Limit, 11-7
measurement limit tset, autoscaled, 3-5
Measurement Selection, 11-2
Measurement Setup, A-1
measurements, autoscaled, 3-5
Memories, SHOW, 3-6
Memory 0, 3-5
menu
 channel, 5-1

Index-4

Menus, 3-7
Menus section, 3-7
Mini Probe Socket, horizontal, 2-2
Mini Probe Socket, vertical, 2-2
Minimum Vertical Sensitivity, 1-1

N

negative delay, 4-3
noise reject Key, 6-3
nonvolatile Key, 10-2
nonvolatile memory, 10-2

 of screens Key, 7-5
numeric keypad, 3-8

O

offset Key, 5-2, 9-4
Offset, hysteresis, trigger cal, 12-10
1
 /delta t, 8-3
Operating Environment, 2-2
Operator Key, 9-3
optional accessories, 2-2
or if Key, 11-8

P

paper length Key, 12-3
pattern Key, 6-9
Pattern Trigger Exercise, 6-10
pattern Trigger Mode, 6-8
period, A-5
persistence, autoscaled, 3-5
pixel Menu, 10-3
position Key, 4-5

HP 54502A
Front-Panel Reference

positive delay, 4-3
Power Cord, 2-5
power input, 2-3
power requirements, 2-1, 2-3
power switch, 2-3
present Key, 6-16
probe attenuation, 5-4
probe attenuation failure, 12-8
Probe attenuation, SHOW, 3-6
probe cal menu, 12-7

Q

qualify on Key, 6-20

R

Rack Mount Kit, 2-2
ram Test, 12-5
range, 6-10
realtime acquisition, 4-5
Rear Panel Layout, 2-3
RECALL 0, 3-5
RECALL CLEAR, 3-6, 3-11
RECALL Key, 3-5
reference Key, 4-3
repetitive acquisition, 4-5
Repetitive Bandwidth, 1-1
repetitive/realtime Key, 4-5
reset, 3-11
risetime, A-5
risetime measurements, A-1
rom Test, 12-5
RUN/STOP Key, 3-2 / 3-3
running, 3-2

S

Sample Rate, 1-1
SAVE Key, 3-6
save to Key, 11-8
screen, autoscaled, 3-5
scroll indicator, 4-2
Selecting Line Voltage, 2-4
Self Cal menu, 12-10
selftest menu, 12-4
sensitivity Key, 9-4
service menu, 12-11
set Key, 11-8
settings, autoscaled, 3-5
Setup, 3-4
SETUP section, 3-4
Shipping, 2-2
SHOW Key, 3-6
SHOW screen, 3-11
SINGLE Key, 3-3
slope Key, 6-3
slope, autoscaled, 3-5
soft reset, 3-5, 3-11
softkeys, 3-10
source Key, 6-3, 6-27, 10-2
standard + width, A-4
standard - width, A-5
standard/user defined Key, 11-4
start cal Key, 12-8, 12-11
start marker, 8-3
start test Key, 12-6
State Trigger Exercise, 6-16
state Trigger Mode, 6-15
statistics Key, 11-3
statistics, autoscaled, 3-5
stop marker, 8-3
Stopped mode, 3-3
Storage, 2-2
store Key, 10-2

HP 54502A
Front-Panel Reference

Index-5

- submenu
 - attenuation, 12-8
 - time null, 12-9
- sweep speed, autoscaled, 3-5
- sweep speed, time/division function, 4-1
- System Control, 3-2
- SYSTEM CONTROL keys, 3-2

T

- talk only, 12-2
- talk only menu, 12-2
- Temperature, 2-2
- Test
 - loop, 12-6
- Test Clip, 2-2
- test Key, 11-7
- Testmobile, 2-2
- threshold, 6-1
- thresholds/measurements Key, 11-4
- timbase of windowed waveform, 4-4
- time Key, 12-9
- time null submenu, 12-9
- Time/Div Key, 4-1
- time/division, function, 4-1
- timebase Key, 4-5
- Timebase Menu, 4-1
- timebase window, 9-3
- timebase window, autoscaled, 3-5
- Trig'd/auto Key, 6-3
- trigger
 - delay, 6-1, 6-20
 - edge, 6-1 / 6-2
 - pattern, 6-1, 6-8
 - state, 6-1, 6-15
 - tv, 6-1, 6-27
- trigger edge mode, autoscaled, 3-5
- trigger level, 6-1
- trigger level, autoscaled, 3-5
- Trigger level, SHOW, 3-6

Index-6

- Trigger Menu, 6-1
- trigger on Key, 6-23
- Trigger source, SHOW, 3-6
- triggered acquisitions, 4-2
- triggered scroll, 4-2
- TTL Key, 5-5
- tv Trigger Exercise, 6-29
- tv Trigger Mode, 6-27
- TV/Video Sync Pod, 2-2

U

- unpacking, 2-1
- user-defined + width, A-5
- Utility Menu, 12-1

V

- Vamp, A-6
- Vavg, A-6
- Vbase, A-6
- Verifying the Fuse, 2-5
- vertical position, 5-2
- Vertical Resolution, 1-1
- Vertical Sensitivity Key, 5-2
- vertical sensitivity, autoscaled, 3-5
- vertical offset, autoscaled, 3-5
- Vmarker 1, 8-2
- Vmarker 2, 8-2
- Vmax, A-5
- Vmin, A-5
- volatile Key, 10-3
- voltage selector module, 2-3
- Vp-p, A-5
- Vrms, A-6
- Vtop, A-6

HP 54502A
Front-Panel Reference

W :

- Waveform Math Exercise, 9-6
- waveform math functions, autoscaled, 3-5
- Waveform Math Menu, 9-1
- waveform Menu, 10-2
- Waveform Save Exercise, 10-4
- Waveform Save Menu, 10-1
- waveform/pixel Key, 10-1
- waveform/pixel memory display, autoscaled, 3-5
 - when entered, 6-9
 - when exited, 6-10
 - when Key, 6-9, 6-15
 - when present, 6-10
- window Key, 4-4
- Window position, 4-4
- Window timebase, 4-4

Free Manuals Download Website

<http://myh66.com>

<http://usermanuals.us>

<http://www.somanuals.com>

<http://www.4manuals.cc>

<http://www.manual-lib.com>

<http://www.404manual.com>

<http://www.luxmanual.com>

<http://aubethermostatmanual.com>

Golf course search by state

<http://golfingnear.com>

Email search by domain

<http://emailbydomain.com>

Auto manuals search

<http://auto.somanuals.com>

TV manuals search

<http://tv.somanuals.com>