



**HEWLETT
PACKARD**

OPERATION AND SERVICE MANUAL

MODEL 4192A
LF IMPEDANCE ANALYZER

SERIAL NUMBERS

**This manual applies to instruments with
serial numbers prefixed 2150J- and above.**

**© COPYRIGHT: YOKOGAWA-HEWLETT-PACKARD, LTD., 1983
9-1, TAKAKURA-CHO, HACHIOJI-SHI, TOKYO, JAPAN**

**Manual Part No. 04192-90001
Microfiche Part No. 04192-90050**

Printed: APR. 1984

SECTION I GENERAL INFORMATION

1-1. INTRODUCTION

1-2. This operating manual contains the information required to install, operate, and test the Hewlett-Packard Model 4192A LF Impedance Analyzer. Figure 1-1 shows the instrument and supplied accessories. This section covers specifications, instrument identification, description, options, accessories, and other basic information.

1-3. Listed on the title page of this manual is a microfiche part number. This number can be used to order 4 X 6 inch microfilm transparencies of the manual. Each microfiche contains up to 60 photo-duplicates of the manual pages. The microfiche package also includes the latest manual changes supplement as well as all pertinent service notes. To order an additional manual, use the part number listed on the title page of this manual.

1-4. DESCRIPTION

1-5. The HP Model 4192A LF Impedance Analyzer is a fully automatic, high performance test instrument designed to measure a wide range of impedance parameters as well as gain, phase, and group delay. The 4192A improves efficiency and quality in the development and production of many types of complex components, semiconductors, and materials. Complete network analysis of devices such as filters, crystals and audio/video equipment, plus evaluation of the impedance characteristics of their circuit components, can be performed. These tests can be performed using test signals equivalent to those found under actual operating conditions. The two measurement display sections, DISPLAY A and DISPLAY B, provide direct readout of the selected meas-

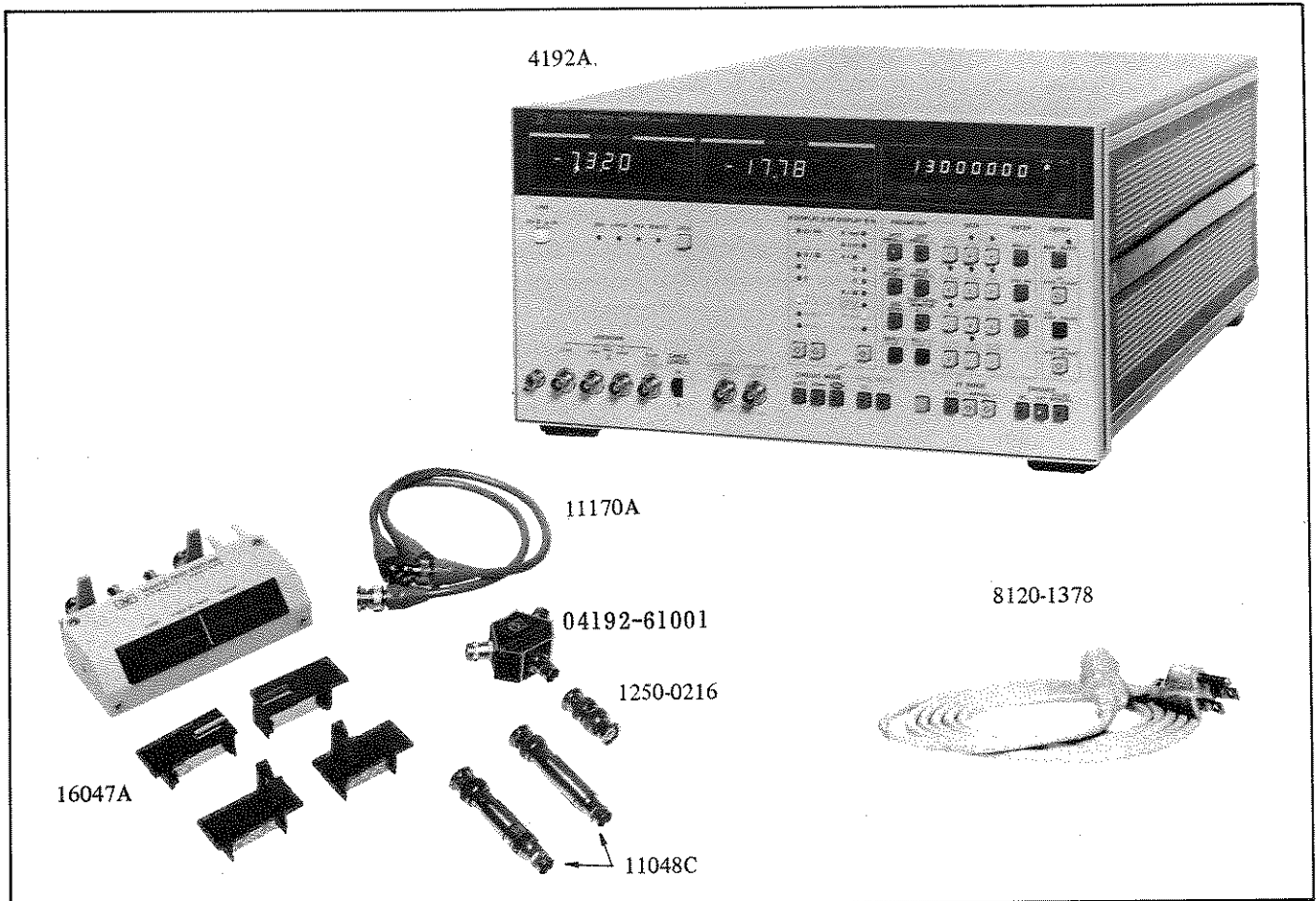

Figure 1-1. Model 4192A and Accessories

urement parameters with $4\frac{1}{2}$ digit resolution along with the appropriate units. In NORMAL mode operation, the 4192A performs approximately five measurements per second. The 4192A also provides an AVERAGE measurement mode (approximately one measurement per second) to obtain measurement data of higher resolution and repeatability than is possible in NORMAL measurement mode, and a HIGH SPEED measurement mode to perform approximately ten measurements per second.

1-6. The 4192A can provide measuring frequency, OSC level, and dc bias voltage (impedance measurements only) equivalent to actual operating conditions. The sweep capability of the built-in frequency synthesizer and dc bias source permits quick and accurate measurements. The built-in frequency synthesizer can be set to measuring frequency within the range from 5.000Hz to 13.00000MHz with 1mHz maximum resolution. OSC level is variable from 5mV to 1.1Vrms with 1mV resolution (5mV for levels higher than 100mV). The internal dc bias voltage source (impedance measurements only) provides $\pm 35V$ in 10mV increments. Measuring frequency or dc bias voltage can be automatically or manually swept in either direction. OSC level can be manually swept in either direction in 1mV increments (5mV for levels above 100mV). Actual test voltage across- or test signal current through the device under test is also measured. Thus the 4192A can evaluate components and circuits under a wide variety of measurement conditions. For example, video frequency characteristics of a VTR head, dc bias voltage characteristics of a semiconductor or ceramic device, at circuit level as well as component level, can be accurately evaluated. For measurements on high Q ($\approx 10^6$) devices or for impedance measurements that require a test signal that is more stable than that provided by the 4192A, an external frequency synthesizer can be connected to the 4192A EXT VCO input connector. Using this technique, a frequency resolution of 1mHz over the full frequency range, from 5Hz to 13MHz, can be obtained. In addition, a high stability reference (1MHz or 10MHz) can be connected to the 4192A so that even more-stable test signals are obtained.

1-7. In amplitude/phase measurements, the 4192A can measure four transmission parameters – gain/loss (B–A), level (A, B), phase (θ), and group delay. Measurement range of B–A is $-100dB$ to $+100dB$ with 0.001dB maximum resolution and 0.02dB to 0.09dB basic accuracy; measurement range of A/B is $+0.8dBV$ to $-100dBV$, $+13.8dBm$ to $-87dBm$ with 0.001dB maximum resolution and 0.4dB basic accuracy; measurement range of θ is -180° to $+180^\circ$ with 0.01° resolution and 0.1° to 0.2° basic accuracy; measurement range of group

delay is 0.1ns to 19.999s with a resolution of $4\frac{1}{2}$ digits. These features make accurate measurement of transmission characteristics easier than ever before. For example, 0.001dB changes in insertion loss and ripple in the pass band of a BPF (Band Pass Filter), caused by temperature changes, can be resolved. Moreover, the ability of the 4192A to measure group delay helps in the design and construction of filters that must accurately transmit phase information.

1-8. In impedance measurements, the 4192A can measure eleven impedance parameters – absolute value of impedance ($|Z|$), absolute value of admittance ($|Y|$), phase angle (θ), resistance (R), reactance (X), conductance (G), susceptance (B), inductance (L), capacitance (C), dissipation factor (D) and quality factor (Q). Measurement range of $|Z|/R/X$ is $0.1m\Omega$ to $1.2999M\Omega$. $|Y|/G/B$ is 1 ns to 12.999s; θ is -180.00° to $+180.00^\circ$; L is 0.01mH to 1.000kH; C is 0.1pF to 100.0mF; D is 0.0001 to 19.999; Q is 0.1 to 1999.9. All have a basic accuracy of 0.1% and a resolution of $4\frac{1}{2}$ digits (number of display digits depends on measuring frequency and OSC level setting). Moreover, the unique circuitry of the 4192A provides direct and accurate impedance measurements of both grounded and floated devices.

1-9. The 4192A employs certain functions which make the best use of the intelligence capability of its microprocessor. This microprocessor-based design of the hardware makes operation of the 4192A simple, yet improves performance to realize the accurate measuring capabilities. Desired test parameters are fully programmable through the front-panel control keys or via HP-IB control, a standard capability of the 4192A. The deviation measurement function eliminates the need for tedious deviation calculations. Deviation measurement can be performed on all measuring parameters and is displayed as either the deviation (Δ) from a stored reference value or percent deviation ($\Delta\%$). This feature is useful for environmental tests such as temperature characteristics measurement of filter loss, and gain vs. frequency for amplifiers. The self test function augments the high reliability design of the 4192A. Convenient introspective testing is possible by pressing the SELF TEST key and confirms the functional operation of the instrument. The zero offset adjustment function measures the residual impedance and stray admittance inherent to the test fixture used, and offsets the effects of these parasitic parameters to zero with respect to the measured values. The save/recall function can store (SAVE key) five completely different front-panel settings, including both parameter selection and sweep controls, and recall them at any time (RECALL key). This feature

improves efficiency in production applications where repetitive measurements are made. This feature can also be used to measure the same parameter on one component under (five) different sets of test conditions. The standard memory of the 4192A preserves stored data even when the instrument is off.

1-10. The 4192A provides HP-IB interface capability for complete remote control of all front-panel control key settings and test parameter settings. This feature makes it possible to integrate the 4192A into a measurement system which reduces cost by improving DUT throughput, improving circuit design efficiency, and shortening the component development period. The 4192A is also equipped with X-Y recorder outputs and pen lift control. Clear and accurate copies of characteristics curves resulting from swept measurements can be obtained easily with this capability, without an external HP-IB controller.

1-11. The versatility and operability of the 4192A are maximized by the availability of versatile test fixtures. Because components and networks are not of uniform shape and size, the 4192A has several test fixtures that can be used to best meet different measurement requirements.

1-12. SPECIFICATIONS

1-13. Complete specifications of the Model 4192A LF Impedance Analyzer are given in Table 1-1. These specifications are the performance standards or limits against which the instrument is tested. The test procedures for the specifications are covered in Section IV, Performance Tests. Table 1-2 lists supplemental performance characteristics. Supplemental performance characteristics are not specifications but are typical characteristics included as additional information for the operator. When the 4192A LF Impedance Analyzer is shipped from the factory, it meets the specifications listed in Table 1-1.

1-14. SAFETY CONSIDERATIONS

1-15. The Model 4192A LF Impedance Analyzer has been designed to conform to the safety requirements of an IEC (International Electromechanical Committee) Safety Class I instrument and is shipped from the factory in a safe condition.

1-16. This operating and service manual contains information, cautions, and warnings which must be followed by the user to ensure safe operation and to maintain the instrument in a safe condition.

1-17. INSTRUMENTS COVERED BY MANUAL

1-18. Hewlett-Packard uses a two-section nine character serial number which is stamped on the serial number plate (Figure 1-2) attached to the instrument's rear-panel. The first four digits and the letter are the serial prefix and the last five digits are the suffix. The letter placed between the two sections identifies the country where the instrument was manufactured. The prefix is the same for all identical instruments; it changes only when a change is made to the instrument. The suffix, however, is assigned sequentially and is different for each instrument. The contents of this manual apply to instruments with the serial number prefix(es) listed under SERIAL NUMBERS on the title page.

1-19. An instrument manufactured after the printing of this manual may have a serial number prefix that is not listed on the title page. This unlisted serial number prefix indicates the instrument is different from those described in this manual. The manual for this new instrument may be accompanied by a yellow Manual Changes supplement or have a different manual part number. This supplement contains "change information" that explains how to adapt the manual to the newer instrument.

1-20. In addition to change information, the supplement may contain information for correcting errors (called Errata) in the manual. To keep this manual as current and accurate as possible, Hewlett-Packard recommends that you periodically request the latest Manual Changes supplement. The supplement for this manual is identified with this manual's print date and part number, both of which appear on the manual's title page. Complimentary copies of the supplement are available from Hewlett-Packard. If the serial prefix or number of an instrument is lower than that on the title page of this manual, see Section VII, Manual Changes.

1-21. For information concerning a serial number prefix that is not listed on the title page or in the Manual Change supplement, contact the nearest Hewlett-Packard office.

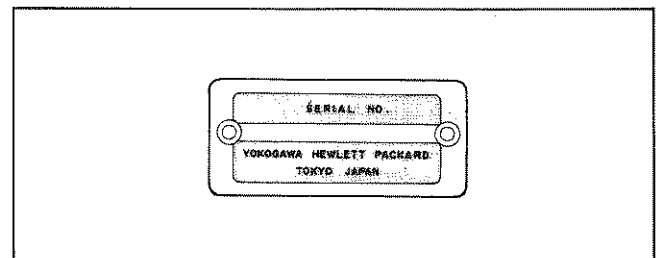

Figure 1-2. Serial Number Plate

Table 1-1. Specifications (Sheet 1 of 12)

COMMON SPECIFICATIONS

(Amplitude-Phase and Impedance Measurements)

- INTERNAL SYNTHESIZER :** Output from OSC OUTPUT (H_{CUR}) terminal
- Frequency Range :** 5.000Hz to 13.000000MHz
- Frequency Resolution :** 1mHz (5Hz to 10kHz), 10mHz (10kHz to 100kHz), 100mHz (100kHz to 1MHz), 1Hz (1MHz to 13MHz)
- Frequency Accuracy :** ± 50 ppm ($23^{\circ}\text{C} \pm 5^{\circ}\text{C}$)
- OSC Level Range :** Variable from 5mVrms to 1.1Vrms (when terminated by 50Ω in amplitude-phase measurements or UNKNOWN terminals are open in impedance measurements).
- OSC Level Resolution :** 1mV (5mV to 100mV), 5mV (100mV to 1.1V)
- OSC Level Accuracy :**

| Measuring Frequency | OSC Level | |
|---------------------|------------------------------|-------------------------------|
| | $\leq 100\text{mV}$ | $> 100\text{mV}$ |
| 5Hz ~ 1MHz | $(5 + 10/f) \% + 2\text{mV}$ | $(5 + 10/f) \% + 10\text{mV}$ |
| 1MHz ~ 13MHz | $(4 + 1.5F) \% + 2\text{mV}$ | $(4 + 1.5F) \% + 10\text{mV}$ |

f : measuring frequency (Hz), F : measuring frequency (MHz).

- Output Resistance :** 50Ω (amplitude/phase measurements), 100Ω (impedance measurements, $\geq 38\text{kHz}$) 100Ω to $10\text{k}\Omega$ (impedance measurements, $< 38\text{kHz}$, depends on measuring range), dc coupling.
- Level Monitor (impedance measurement) :** Measures and displays the voltage across- or current through the device under test.
- Frequency and Level Control :** Set via the front-panel numeric keys or HP-IB; auto sweep (except for level) or manual sweep.

- EXTERNAL SYNTHESIZER :** Connected to the VCO INPUT connector on the rear-panel (HP3325A Synthesizer or equivalent is recommended).
- Frequency Range :** 40.000005MHz to 53MHz (measuring frequency is equal to the frequency of the external synthesizer minus 40MHz [5Hz to 13MHz]).
- Required Signal Level :** 0dBm to 3dBm

Note: Frequency of the 4192A internal synthesizer should be set to the frequency of the external synthesizer minus 40MHz, and the internal and external synthesizers should be phase-locked.

Table 1-1. Specifications (Sheet 2 of 12)

| | |
|---|--|
| EXT REFERENCE INPUT CONNECTOR : | Can be connected to a 1MHz/10MHz high stability reference signal (-1 dBm to +5 dBm) to improve the stability of the internal synthesizer. |
| Input Resistance : | Approximately 50Ω |
| MEASURING MODE : | |
| Spot Measurement : | At specific frequency (or dc bias*) |
| Swept Measurement : | Between START and STOP frequencies (or dc bias*). Sweep can be automatic or manual. |
| Sweep Mode : | Linear sweep mode (sweeps at specified step) and logarithmic sweep mode (20 measurement points per frequency decade). |
| X10 STEP : | Multiplies the specified frequency/dc bias* step by 10 in linear manual sweeps. |
| PAUSE Key : | Temporarily stops swept measurements. |
| SWEEP ABORT Key : | Makes sweep cancellation. |
| | * : DC bias sweeps can be made for impedance measurements only. |
| RECORDER OUTPUT : | DC outputs proportional to measured values of DISPLAY A, DISPLAY B, and measuring frequency or dc bias. PEN LIFT output and X-Y recorder scaling outputs are provided. |
| Maximum Output : | ±1 V |
| Output Voltage Accuracy : | ± (0.5% of output voltage + 20 mV). |
| FIVE NONVOLATILE STORAGE REGISTERS : | Memorize five complete instrument measurement configurations. Measurement configurations can be set from the front-panel, from the HP-IB, or both. |
| HP-IB INTERFACE : | Data output and remote control via the HP-IB (based on IEEE-Std-488 and ANSI-MC1-1. |
| Interface Capability : | SH1, AH1, T5, L4, SR1, RL1, DC1, DT1. |
| Remote Control Function : | All front-panel functions except LINE ON/OFF switch and X10 STEP key. |
| Data Output : | Measured values of DISPLAY A, DISPLAY B, and measuring frequency or dc bias. |
| SELF TEST : | Performs the 4192A basic operation checks and displays the test results when power is turned on or when the SELF TEST mode is set by the SELF TEST key or via HP-IB. |
| TRIGGER : | Internal, External, Hold/Manual, or HP-IB remote control. |

Table 1-1. Specifications (Sheet 3 of 12)

AMPLITUDE/PHASE MEASUREMENTS

PARAMETERS MEASURED : Measures DISPLAY A parameters and DISPLAY B parameters simultaneously in the parameter combination listed below. Deviation measurement (Δ) and percent deviation measurement ($\Delta\%$) can be performed for all measurement parameters.

| DISPLAY A Function | DISPLAY B Function |
|---|---------------------------------------|
| B - A (dB) : Amplitude ratio | Group delay (s) |
| | θ (deg/rad) : Phase Difference |
| A (dBm/dBV) : Absolute amplitude of Reference Input | / |
| B (dBm/dBV) : Absolute amplitude of Test Input | |

REFERENCE AMPLITUDE : 0dBv = 1Vrms, 0dBm = 1mV (into 50 Ω)

OSC OUTPUT CONNECTOR OUTPUT IMPEDANCE : 50 Ω + 5% - 8% (at 50Hz to 5MHz), 50 Ω \pm 10% (at 5Hz to 13MHz).

CHANNEL A AND B :

Input Impedance : 1M Ω \pm 2%, shunt capacitance 25pF \pm 5pF

Maximum Input Voltage : 2Vrms/ \pm 35V DC Max.

DISPLAY RANGE AND RESOLUTION : In NORMAL or AVERAGE measurement mode (Measuring resolution decreases one digit in HIGH SPEED measurement mode.

B - A : 0 to \pm 100dB, 0.001dB (0 ~ 20dB), 0.01dB (20 ~ 100dB) resolution

θ : 0 to \pm 180 $^\circ$ (0 to \pm π radian), 0.01 $^\circ$ resolution

Group Delay (τ_g) : 0.1ns to 19.999s, 0.1ns maximum resolution

A, B : +0.8dBV to -100dBV, +13.8dBm to -87dBm, 0.001dB ($>$ -20dB), 0.01dB (\leq -20dB) resolution

Table 1-1. Specifications (Sheet 4 of 12)

MEASURING ACCURACY : Specified at measuring terminals when the following conditions are satisfied:

- (1) **Warmup Time :** > 30 minutes
- (2) **Ambient Temperature :** 23°C ± 5°C (error limits double for 0°C to 55°C temperature range).
- (3) **Measuring Speed :** NORMAL or AVERAGE mode.

Note: Additional errors due to the power splitter, feedthrough termination, etc., are to be added to specifications given here.

The measurement accuracy of each parameter is given below. The accuracy depends on input absolute level of each channel and the measuring frequency.

B-A and θ Measurements Accuracies : Accuracies are the sum of each channel accuracy given in the table below. For example, when the frequency is 1kHz, A channel is -15dBV and B channel is -25dBV; the uncertainty contributed by each channel to the B-A error is 0.01dB/0.05° and 0.05dB/0.15°, respectively. Therefore, the final accuracy of 0.06dB/0.2° is given by the accuracy of both channels.

Group Delay Measurements Accuracy : Accuracy is derived from the following equation (phase accuracy $\Delta\theta_A$ and $\Delta\theta_B$ are read from the table below):

$$\text{group delay accuracy} = \frac{\Delta\theta_A + \Delta\theta_B}{720 \times \Delta F} \text{ (s)}$$

where, $\Delta\theta_A$: Channel A phase accuracy (degree)
 $\Delta\theta_B$: Channel B phase accuracy (degree)
 ΔF : Step Frequency (Hz)

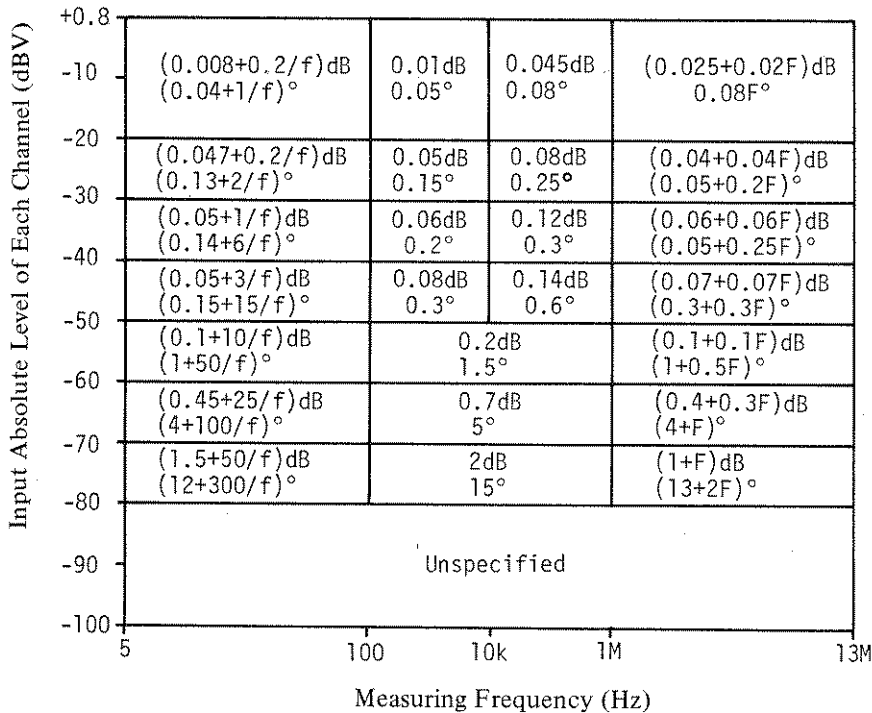

f : measuring frequency (Hz)
 F : measuring frequency (MHz)

Equations in table represent:

| |
|-------------------|
| A, B accuracy |
| θ accuracy |

Note

When calculating accuracy for points along a horizontal or vertical line, or at the intersection of two lines, use the narrowest accuracy equation.

Table 1-1. Specifications (Sheet 5 of 12)

Absolute Amplitude (A, B) Accuracy : Accuracy is given in the table below.

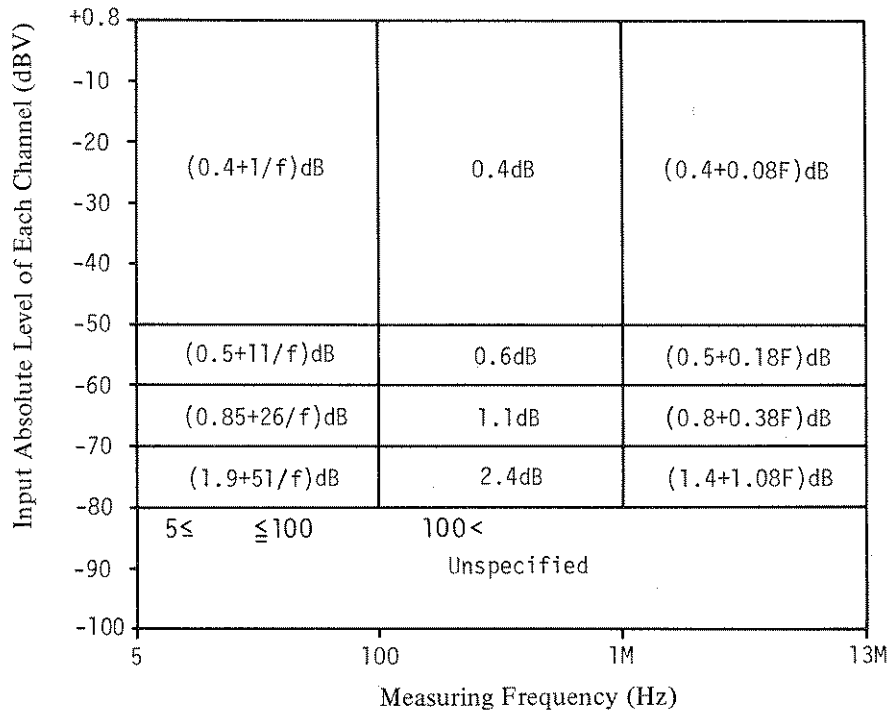

f : measuring frequency (Hz)
F : measuring frequency (MHz)

Note

When calculating accuracy for points along a horizontal or vertical line, or at the intersection of two lines, use the narrowest accuracy equation.

Table 1-1. Specifications (Sheet 6 of 12)







| IMPEDANCE MEASUREMENTS | | | | | | | | | | | | | | | | |
|--------------------------------------|---|--------------------|--------------------|-------------------------------------|----------------------------------|--------------------------------------|----------------|---------------|-----------------|-----------------|----------------|--------------------|------------------------|-----------------|----------------|-----------------|
| PARAMETERS MEASURED : | Measures DISPLAY A parameters and DISPLAY B parameters simultaneously in the parameter combinations listed below. Deviation measurement (Δ) and percent deviation measurement ($\Delta\%$) can be performed for all measurement parameters. | | | | | | | | | | | | | | | |
| | <table border="1" style="width: 100%; border-collapse: collapse;"> <thead> <tr> <th style="width: 50%; text-align: center;">DISPLAY A Function</th> <th style="width: 50%; text-align: center;">DISPLAY B Function</th> </tr> </thead> <tbody> <tr> <td>Z : Absolute Value of Impedance</td> <td rowspan="2" style="text-align: center;">θ (deg/rad) : Phase Angle</td> </tr> <tr> <td>Y : Absolute Value of Admittance</td> </tr> <tr> <td>R : Resistance</td> <td>X : Reactance</td> </tr> <tr> <td>G : Conductance</td> <td>B : Susceptance</td> </tr> <tr> <td rowspan="2">L : Inductance</td> <td>Q : Quality Factor</td> </tr> <tr> <td>D : Dissipation Factor</td> </tr> <tr> <td rowspan="2">C : Capacitance</td> <td>R : Resistance</td> </tr> <tr> <td>G : Conductance</td> </tr> </tbody> </table> | DISPLAY A Function | DISPLAY B Function | $ Z $: Absolute Value of Impedance | θ (deg/rad) : Phase Angle | $ Y $: Absolute Value of Admittance | R : Resistance | X : Reactance | G : Conductance | B : Susceptance | L : Inductance | Q : Quality Factor | D : Dissipation Factor | C : Capacitance | R : Resistance | G : Conductance |
| DISPLAY A Function | DISPLAY B Function | | | | | | | | | | | | | | | |
| $ Z $: Absolute Value of Impedance | θ (deg/rad) : Phase Angle | | | | | | | | | | | | | | | |
| $ Y $: Absolute Value of Admittance | | | | | | | | | | | | | | | | |
| R : Resistance | X : Reactance | | | | | | | | | | | | | | | |
| G : Conductance | B : Susceptance | | | | | | | | | | | | | | | |
| L : Inductance | Q : Quality Factor | | | | | | | | | | | | | | | |
| | D : Dissipation Factor | | | | | | | | | | | | | | | |
| C : Capacitance | R : Resistance | | | | | | | | | | | | | | | |
| | G : Conductance | | | | | | | | | | | | | | | |
| EQUIVALENT CIRCUIT MODE : | Auto,  (Series), and  (Parallel). $ Z $, R, and X are measured in  mode; and $ Y $, G, and B in  mode. | | | | | | | | | | | | | | | |
| DISPLAY : | Maximum 4-1/2 digits in NORMAL or AVERAGE measurement mode, maximum 3-1/2 digits in HIGH SPEED measurement mode; 19999 full-scale display for L and C measurement, 12999 for other parameters. Number of display digits depends on OSC level, measurement range, and test frequency. (Refer to Para. 3-17) | | | | | | | | | | | | | | | |
| RANGING : | AUTO or MANUAL for impedance ($ Z $)/admittance ($ Y $) measured value. | | | | | | | | | | | | | | | |
| MEASUREMENT TERMINAL : | 4-terminal pair configuration | | | | | | | | | | | | | | | |
| AUTOMATIC ZERO ADJUSTMENT : | Residual impedance ($R + jX$) and stray admittance ($G + jB$) of the test fixture are measured at a frequency selected by the operator. These values are then stored and used as offset data for subsequent measurements. The stored offset values are converted and applied to other measurement frequencies (refer to paragraph 3-79). | | | | | | | | | | | | | | | |

Table 1-1. Specifications (Sheet 7 of 12)

MEASURING RANGE AND RESOLUTION : Accuracy is specified at UNKNOWN terminals under the following conditions:

- (1) Warmup Time : ≥ 30 minutes
- (2) In Floating Measurements : (see Table 1-2 for specifics on low-grounded measurements)
- (3) Measuring Frequency : At the frequency of the zero offset adjustment
- (4) Ambient Temperature : $23^{\circ}\text{C} \pm 5^{\circ}\text{C}$ (error limits double for temperature range of 0°C to 55°C)
- (5) CABLE LENGTH : At 0 position
- (6) Measuring Speed : NORMAL or AVERAGE mode
- (7) In the tables,  area : Reference data (accuracy is not guaranteed.)

 area : Measurement can not mode but accuracy is not specified.
 0.0001 to $1.2999\text{M}\Omega$ $100\Omega_{\mu}$ -180.00° to $+180.00^{\circ}$

$$B = 1 + \frac{0.02}{\gamma} : \text{use the left graph (below)}$$

$$C = \frac{1}{\gamma} : \text{use the right graph (below)}$$

where γ : OSC LEVEL (V)

f : Measuring frequency (Hz)

F : Measuring frequency (MHz)

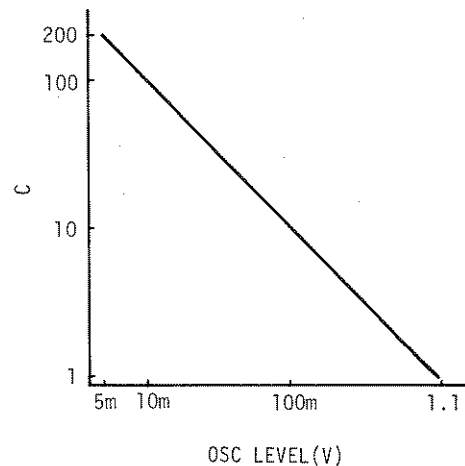
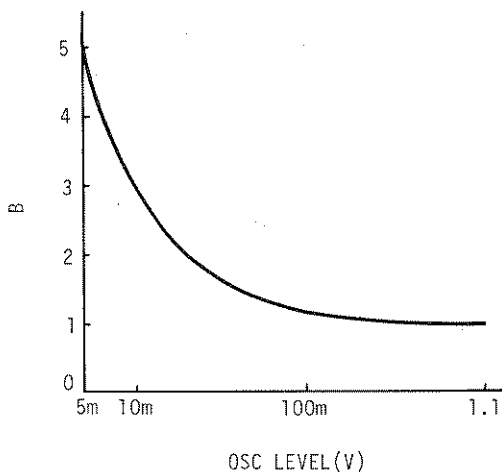

Table 1-1. Specifications (Sheet 8 of 12)

|Z| - θ and R-X Measurements :

Measuring Range :

| Parameter | Measuring Range | Maximum Resolution |
|------------|----------------------|--------------------|
| Z · R · X | 0.0001Ω to 1.2999MΩ | 100μΩ |
| θ | -180.00° to +180.00° | 0.01° |

Measurement Accuracy : Refer to the table below (specified by ZY RANGE). However, R and X accuracy depends on the value of D as follows:

| | D < 1 | 1 ≤ D < 10 | 10 ≤ D |
|---|---|---|-------------|
| R | Accuracy of R is equal to the accuracy of X, in number of counts, as calculated from the table below. | Two times % error given in the table below. | Table below |
| X | Table below. | Accuracy of X is equal to the accuracy of R, in number of counts, as calculated from the table below. | |

| Z Range (Ω) | D < 1 | | 1 ≤ D < 10 | |
|--------------|---|--|--|------------|
| | Accuracy | Resolution | Accuracy | Resolution |
| 1M | $\left\{ (0.2 + A)B + \frac{5}{F} (1 + 2.4A \cdot C) \right\} \% + 1$ $\left\{ (0.1 + 0.5A)B + \frac{3}{F} (1 + 2.4A \cdot C) \right\}^\circ$ | $(0.2 + A)B\% + 1$ $(0.1 + 0.5A)B^\circ$ | $(0.2F + A)B\% + 1$ $(0.12F + 0.5A)B^\circ$ | |
| 100k | $\left[(0.1 + 0.2A)B + \frac{5}{F} \{ 1 + 0.03 (1 + 10A)C \} \right] \% + 1$ $\left[(0.05 + 0.1A)B + \frac{3}{F} \{ 1 + 0.03 (1 + 10A)C \} \right]^\circ$ | | $(0.2F + 0.2A)B\% + 1$ $(0.12F + 0.1A)B^\circ$ | |
| 10k | $\left[(0.1 + 0.2A)B + \frac{5}{F} \{ 1 + 0.02 (1 + 10A)C \} \right] \% + 1$ $\left[(0.05 + 0.1A)B + \frac{3}{F} \{ 1 + 0.02 (1 + 10A)C \} \right]^\circ$ | $(0.1 + 0.2A)B\% + 1$ $(0.05 + 0.1A)B^\circ$ | $(0.15F + 0.2A)B\% + 1$ $(0.09F + 0.1A)B^\circ$ | |
| 1k | $\left[(0.1 + 0.2A)B + \frac{5}{F} \{ 1 + 0.04 (1 + 6A)C \} \right] \% + 1$ $\left[(0.05 + 0.1A)B + \frac{3}{F} \{ 1 + 0.04 (1 + 6A)C \} \right]^\circ$ | | $(0.1 + 0.2A + 0.02F + 0.024F^2)B\% + 1$ $(0.05 + 0.1A + 0.01F + 0.014F^2)B^\circ$ | |
| 100 | $\left[0.1B + \frac{5}{F} \{ 1 + 0.04 (1 + \frac{2}{A})C \} \right] \% + 3$ $\left[(0.05 + \frac{0.01}{A})B + \frac{3}{F} \{ 1 + 0.04 (1 + \frac{2}{A})C \} \right]^\circ$ | $0.1B\% + 3$ $(0.05 + \frac{0.01}{A})B^\circ$ | $(0.1 + 0.02F + 0.024F^2)B\% + 3$ $(0.05 + \frac{0.01}{A} + 0.01F + 0.014F^2)B^\circ$ | |
| 10 | $\left[0.2B + \frac{5}{F} \{ 1 + 0.04 (1 + \frac{2}{A})C \} \right] \% + 5$ $\left[(0.1 + \frac{0.02}{A})B + \frac{3}{F} \{ 1 + 0.04 (1 + \frac{2}{A})C \} \right]^\circ$ | $0.2B\% + 5$ $(0.1 + \frac{0.02}{A})B^\circ$ | $(0.2 + 0.03F + 0.032F^2)B\% + 5$ $(0.1 + \frac{0.02}{A} + 0.06F + 0.064F^2)(0.2 + \frac{0.1}{A})B^\circ$ | |
| 1 | $\left[0.5B + \frac{5}{F} \{ 1 + 0.04 (1 + \frac{20}{A})C \} \right] \% + 5$ $\left[(0.3 + \frac{0.1}{A})B + \frac{3}{F} \{ 1 + 0.04 (1 + \frac{20}{A})C \} \right]^\circ$ | $0.5B\% + 5$ $(0.3 + \frac{0.1}{A})B^\circ$ | | |

(1) $A = \frac{\text{Displayed } |Z|, R \text{ or } X (\Omega)}{|Z| \text{ Range full scale } (\Omega)}$ in the table.

(2) Equations in table represent :

|Z|, R, X accuracy [± (% of reading + number of counts)]
θ accuracy [± (absolute value)]

Table 1-1. Specifications (Sheet 9 of 12)

$|Y| - \theta$ and G-B Measurements :

Measuring Range :

| Parameter | Measuring Range | Maximum Resolution |
|-------------|-------------------------|--------------------|
| $ Y , G, B$ | 0.001 μ S ~ 12.999S | 1nS |
| θ | -180.00° ~ +180.00° | 0.01° |

Measurement Accuracy : Refer to the table below (specified by ZY RANGE). However, G and B accuracy depends on the value of D as follows:

| | $D \leq 0.1$ | $0.1 < D \leq 1$ | $1 < D$ |
|---|---|---|---|
| G | Accuracy of G is equal to the accuracy of B, in number of counts, as calculated from the table below. | | Table below |
| B | Table below | Two times % error given in the table below. | Accuracy of B is equal to the accuracy of G, in number of counts, as calculated from the table below. |

| $ Y $ Range (S) | Accuracy | | |
|-----------------|--|--|--|
| | $D \leq 0.1$ | $0.1 < D \leq 1$ | $1 < D$ |
| 10 μ | $\left\{ 0.2B + \frac{5}{F} \left(1 + \frac{0.24C}{A} \right) \right\} \% + 3$ $\left\{ \left(0.1 + \frac{0.05}{A} \right) B + \frac{3}{F} \left(1 + \frac{0.24C}{A} \right) \right\} ^\circ$ | $0.2B\% + 3$ $\left(0.1 + \frac{0.05}{A} \right) B^\circ$ | $0.2F \cdot B\% + 3$ $\left(0.12F + \frac{0.05}{A} \right) B^\circ$ |
| 100 μ | $\left[0.1B + \frac{5}{F} \left\{ 1 + 0.03 \left(1 + \frac{1}{A} \right) C \right\} \right] \% + 3$ $\left[0.05 + \frac{0.01}{A} \right] B + \frac{3}{F} \left\{ 1 + 0.03 \left(1 + \frac{1}{A} \right) C \right\} ^\circ$ | $0.1B\% + 3$ $\left(0.05 + \frac{0.01}{A} \right) B^\circ$ | $0.2F \cdot B\% + 3$ $\left(0.12F + \frac{0.01}{A} \right) B^\circ$ |
| 1m | $\left[0.1B + \frac{5}{F} \left\{ 1 + 0.02 \left(1 + \frac{1}{A} \right) C \right\} \right] \% + 3$ $\left[\left(0.05 + \frac{0.01}{A} \right) B + \frac{3}{F} \left\{ 1 + 0.02 \left(1 + \frac{1}{A} \right) C \right\} \right] ^\circ$ | | $0.15F \cdot B\% + 3$ $\left(0.09F + \frac{0.01}{A} \right) B^\circ$ |
| 10m | $\left[0.1B + \frac{5}{F} \left\{ 1 + 0.04 \left(1 + \frac{0.6}{A} \right) C \right\} \right] \% + 3$ $\left[\left(0.05 + \frac{0.01}{A} \right) B + \frac{3}{F} \left\{ 1 + 0.04 \left(1 + \frac{0.6}{A} \right) C \right\} \right] ^\circ$ | $(0.1 + 0.2A)B\% + 1$ $(0.05 + 0.1A)B^\circ$ | $(0.1 + 0.02F + 0.024F^2)B\% + 3$ $\left(0.05 + \frac{0.01}{A} + 0.01F + 0.014F^2 \right) B^\circ$ |
| 100m | $\left[(0.1 + 0.2A)B + \frac{5}{F} \left\{ 1 + 0.04 \left(1 + 2A \right) C \right\} \right] \% + 1$ $\left[(0.05 + 0.1A)B + \frac{3}{F} \left\{ 1 + 0.04 \left(1 + 2A \right) C \right\} \right] ^\circ$ | | $(0.1 + 0.2A + 0.02F + 0.024F^2)B\% + 1$ $\left(0.05 + 0.1A + 0.01F + 0.014F^2 \right) B^\circ$ |
| 1 | $\left[(0.2 + 0.5A)B + \frac{5}{F} \left\{ 1 + 0.04 \left(1 + 20A \right) C \right\} \right] \% + 1$ $\left[(0.1 + 0.2A)B + \frac{3}{F} \left\{ 1 + 0.04 \left(1 + 20A \right) C \right\} \right] ^\circ$ | $(0.2 + 0.5A)B\% + 1$ $(0.1 + 0.2A)B^\circ$ | |
| 10 | | $(0.5 + 2A)B\% + 1$ $(0.3 + A)B^\circ$ | |

Measuring Frequency (Hz)

(1) $A = \frac{\text{Displayed } |Y|, G \text{ or } B (S)}{|Y| \text{ Range full scale } (S)}$ in the table.

(2) Equations in table represent :

$|Y|, G, B$ accuracy: $[\pm (\% \text{ of reading} + \text{number of counts})]$
 θ accuracy: $[\pm (\text{absolute value})]$

Table 1-1. Specifications (Sheet 10 of 12)

L-Q, D, R, G Measurements : Refer to R/X or G/B measurements for R and G accuracy.

Measuring Range :

| Parameter | Measuring Range | Maximum Resolution |
|-----------|---------------------|--------------------|
| L* | 0.01 nH ~ 1.0000 kH | 10pH |
| D | 0.0001 ~ 19.999 | 0.0001 |
| Q | 0.1 ~ 1999.9 | 0.1 |

* : Depends on ZY RANGE and measuring frequency (refer to paragraph 3-71).

Measuring Accuracy :

Refer to the table below (specified by ZY RANGE).

To determine which |Z| range is selected for L measurements, change the DISPLAY A function to |Z| / |Y|.

| Z Range (Ω) | Accuracy Formula | | Resolution |
|--------------|---|---|--|
| | Accuracy Formula 1 | Accuracy Formula 2 | |
| 1M | $\{(1 + 2A)B + \frac{5}{F} (1 + 2.4A \cdot C)\} \% + 1$ $(0.01 + 0.02A)B + \frac{0.05}{F} (1 + 2.4A \cdot C)$ | $(1 + 2A)B\% + 1$ $(0.01 + 0.02A)B$ | |
| 100k | $[(0.2 + 0.3A)B + \frac{5}{F} \{1 + 0.03 (1 + 10A)C\}] \% + 1$ $(0.002 + 0.003A)B + \frac{0.05}{F} \{1 + 0.03 (1 + 10A)C\}$ | $(0.2 + 0.3A)B\% + 1$ $(0.002 + 0.003A)B$ | $(0.3F + 0.3A)B\% + 1$ $(0.003F + 0.003A)B$ |
| 10k | $[(0.2 + 0.3A)B + \frac{5}{F} \{1 + 0.002 (1 + 10A)C\}] \% + 1$ $(0.002 + 0.003A)B + \frac{0.05}{F} \{1 + 0.03 (1 + 10A)C\}$ | | $(0.2F + 0.3A)B\% + 1$ $(0.002F + 0.003A)B$ |
| 1k | $[(0.2 + 0.3A)B + \frac{5}{F} \{1 + 0.04 (1 + 6A)C\}] \% + 1$ $(0.002 + 0.003A)B + \frac{0.05}{F} \{1 + 0.02 (1 + 10A)C\}$ | | $\{(0.2 + 0.3A + 0.03F + 0.032F^2)B\% + 1$ $(0.002 + 0.003A + 0.0003F + 0.0004F^2)B$ |
| 100 | $[0.2B + \frac{5}{F} \{1 + 0.04 (1 + \frac{0.2}{A})C\}] \% + 3$ $(0.002 + \frac{0.0003}{A})B + \frac{0.05}{F} \{1 + 0.04 (1 + \frac{0.2}{A})C\}$ | $0.2B\% + 3$ $(0.002 + \frac{0.0003}{A})B$ | $(0.2 + 0.03F + 0.032F^2)B\% + 3$ $(0.002 + \frac{0.0003}{A} + 0.0003F + 0.0004F^2)B$ |
| 10 | $[0.3B + \frac{5}{F} \{1 + 0.04 (1 + \frac{2}{A})C\}]1\% + 5$ $(0.003 + \frac{0.0004}{A})B + \frac{0.05}{F} \{1 + 0.04 (1 + \frac{2}{A})C\}$ | $0.3B\% + 5$ $(0.003 + \frac{0.0004}{A})B$ | $(0.3 + 0.04F + 0.048F^2)B\% + 5$ $(0.003 + \frac{0.0004}{A} + 0.0004F + 0.0006F^2)B$ |
| 1 | $[0.7B + \frac{5}{F} \{1 + 0.04 (1 + \frac{20}{A})C\}] \% + \alpha$ $(0.007 + \frac{0.002}{A})B + \frac{0.05}{F} \{1 + 0.04 (1 + \frac{20}{A})C\}$ | $0.7B\% + 5$ $(0.007 + \frac{0.002}{A})B$ | |

Measuring Frequency (Hz): 5, 400, 16k, 1M, 2M, 13M

(1) $A = \frac{2\pi \times \text{Measuring frequency (Hz)} \times \text{Displayed L (H)}}{|Z| \text{ Range full scale } (\Omega)}$ in the table.

(2) Equations in table represent (at $D \leq 0.1$) :

L accuracy: $[\pm (\% \text{ of reading} + \text{number of counts})]$
D accuracy: $[\pm (\text{absolute value})]$

(3) If $0.1 < D \leq 1$, double the % error for all values of L.

(4) If $D > 0.1$, multiply error of D by $(1 + D)^2$.

(5) $\alpha = \frac{5}{2\pi f \times 10^\beta} \text{ (H)}$ in the table.

Where β : number of digits displayed when the DISPLAY A function is changed to $|Z| / |Y|$.

Table 1-1. Specifications (Sheet 11 of 12)

C-Q, D, R, G Measurements : Refer to R/X or G/B measurements for R and G accuracy.

Measuring Range :

| Parameter | Measurement Range | Maximum Resolution |
|-----------|---------------------|--------------------|
| C* | 0.0001pF ~ 100.00mF | 0.1fF |
| D | 0.0001 ~ 19.999 | 0.0001 |
| Q | 0.1 ~ 1999.9 | 0.1 |

* : Depends on ZY RANGE and measuring frequency (refer to paragraph 3-71).

Measurement Accuracy : Refer to the table below (specified by ZY RANGE).
To determine which |Z| range is selected for L measurements, change the DISPLAY A function to |Z|/|Y|.

| Y Range (S) | 5 | | 400 | | 16k | | 1M | | 2M | | 13M | |
|--------------|--|--|---------|----------|---------|----------|---------|----------|---------|----------|---------|----------|
| | Formula | Accuracy | Formula | Accuracy | Formula | Accuracy | Formula | Accuracy | Formula | Accuracy | Formula | Accuracy |
| 10H | $\{0.2B + \frac{5}{F} (1 + \frac{0.24C}{A})\} \% + \alpha$ $(0.002 + \frac{0.001}{A})B + \frac{0.05}{F} (1 + \frac{0.24C}{A})$ | 0.28% + 3 $(0.002 + \frac{0.001}{A})B$ | | | | | | | | | | |
| 100H | $[0.1B + \frac{5}{F} \{1 + 0.03 (1 + \frac{1}{A})C\}] \% + 3$ $(0.0009 + \frac{0.0002}{A})B + \frac{0.05}{F} \{1 + 0.03 (1 + \frac{1}{A})C\}$ | 0.18% + 3 $(0.0009 + \frac{0.0002}{A})B$ | | | | | | | | | | |
| 1m | $[0.1B + \frac{5}{F} \{1 + 0.02 (1 + \frac{1}{A})C\}] \% + 3$ $(0.0009 + \frac{0.0002}{A})B + \frac{0.05}{F} \{1 + 0.04 (1 + \frac{0.6}{A})C\}$ | | | | | | | | | | | |
| 10m | $[0.1B + \frac{5}{F} \{1 + 0.04 (1 + \frac{0.6}{A})C\}] \% + 3$ $(0.0009 + \frac{0.0002}{A})B + \frac{0.05}{F} \{1 + 0.04 (1 + 2A)C\}$ | | | | | | | | | | | |
| 100m | $[(0.1 + 0.2A)B + \frac{5}{F} \{1 + 0.04 (1 + 2A)C\}] \% + 1$ $(0.0009 + \frac{0.0002}{A})B + \frac{0.05}{F} \{1 + 0.04 (1 + 2A)C\}$ | $(0.1 + 0.2A)B \% + 1$ $(0.0009 + \frac{0.0002}{A})B$ | | | | | | | | | | |
| 1 | $[(0.2 + 0.5A)B + \frac{5}{F} \{1 + 0.04 (1 + 20A)C\}] \% + 1$ $(0.002 + 0.004A)B + \frac{0.05}{F} \{1 + 0.04 (1 + 20A)C\}$ | $(0.2 + 0.5A)B \% + 1$ $(0.002 + 0.004A)B$ | | | | | | | | | | |
| 10 | | $(0.5 + 2A)B \% + 1$ $(0.005 + 0.02A)B$ | | | | | | | | | | |

$$(1) A = \frac{2\pi \times \text{Measuring frequency (Hz)} \times \text{Displayed C (F)}}{|Y| \text{ Range full scale}}$$

(2) Equations in table represent (at $D \leq 0.1$) :

C accuracy: [± (% of reading + number of counts)]
D accuracy: [± (absolute value)]

(3) If $0.1 < D \leq 1$, double the % error for all values of C.

(4) If $D > 0.1$, multiply error of D by $(1 + D)^2$.

$$(5) \alpha = \frac{3}{2\pi f \times 10^{\beta+5}} (F) \text{ in the table.}$$

Where β : number of digits displayed when the DISPLAY A function is changed to |Z|/|Y|.

Table 1-1. Specifications (Sheet 12 of 12)

| | |
|---|--|
| DC BIAS : | Valid for impedance measurements only. |
| Voltage Range : | -35 V to +35 V, 10 mV steps |
| Setting Accuracy (at 23°C ± 5°C) : | ± (0.5% of setting + 5 mV) |
| Output Resistance : | 110Ω to 11 kΩ ± 10% (depends on measuring range) |
| Maximum Output Current : | Varies with measuring frequency and range. |
| | Floating measurements - 20 mA max. |
| | Low-grounded measurements - 5 mA max. |
| Control : | Front-panel numeric keys or HP-IB remote control |

GENERAL

| | |
|--|---|
| OPERATING TEMPERATURE : | 0°C to 55°C |
| RELATIVE HUMIDITY : | ≤ 95% at 40°C |
| POWER : | 100, 120, 220 V ± 10%, 240 V + 5% - 10%, 48 Hz to 66 Hz, power consumption 150 VA maximum. |
| DIMENSIONS : | 425.5 mm (W) × 235 mm (H) × 615 mm (D) |
| WEIGHT : | Approximately 19 kg |
| FURNISHED ACCESSORIES AND PARTS : | 16047A Test Fixture, 11048C 50Ω Feedthrough Termination (2 ea.), Splitter (HP Part No.: 04192-61001, Nominal 50Ω), Power Cord (HP Part No.: 8120-1378). |

OPTIONS

| | |
|---------------------|--|
| OPTION 907 : | Front Handle Kit (HP Part No.: 5061-0091) |
| OPTION 908 : | Rack Flange Kit (HP Part No.: 5061-0079) |
| OPTION 909 : | Rack and Handle Kit (HP Part No.: 5061-0085) |
| OPTION 910 : | Extra Manual |

Table 1-2. General Information (Sheet 1 of 2)

GENERAL INFORMATION

(The following information is reference data and not guaranteed specifications.)

TYPICAL MEASUREMENT ACCURACY :

Impedance Measurement (Floating) :

Accuracy when CABLE LENGTH is 1 m : 2.5 times percent error for frequencies above 1 MHz.

L · C accuracy for $D > 1$: $(1 + D^2)$ times accuracy specifications

Low Grounded Impedance Measurement Accuracy :

To obtain low grounded measurement accuracy, add the accuracy for floating impedance measurements, given in the preceding tables, to the additional error given in the figure below. Compensation for residual impedance ($\leq 9\text{pF}$ at $\leq 600\text{kHz}$ or approximately $20\text{k}\Omega$ at $\geq 600\text{kHz}$) must also be made using the 4192A's zero offset adjustment function.

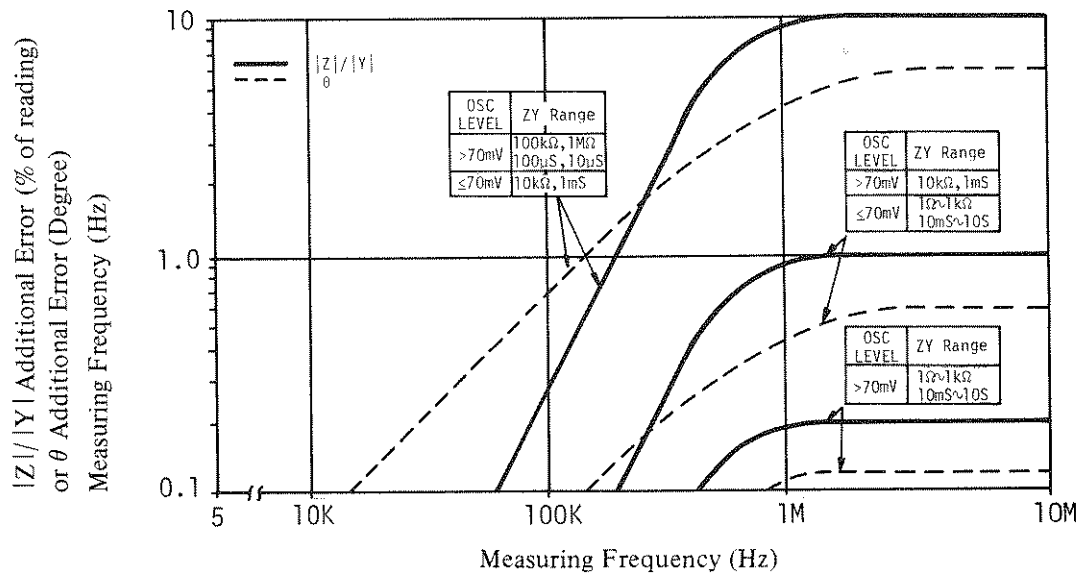

MEASURING SPEED :

Refer to the figure below (at fixed measuring frequency, measurement range and OSC level for impedance measurement). Specific information is provided in paragraph 3-55 for amplitude/phase measurements and in paragraph 3-89 for impedance measurements. Speed in AVERAGE mode is approximately 7 times that for NORMAL mode.

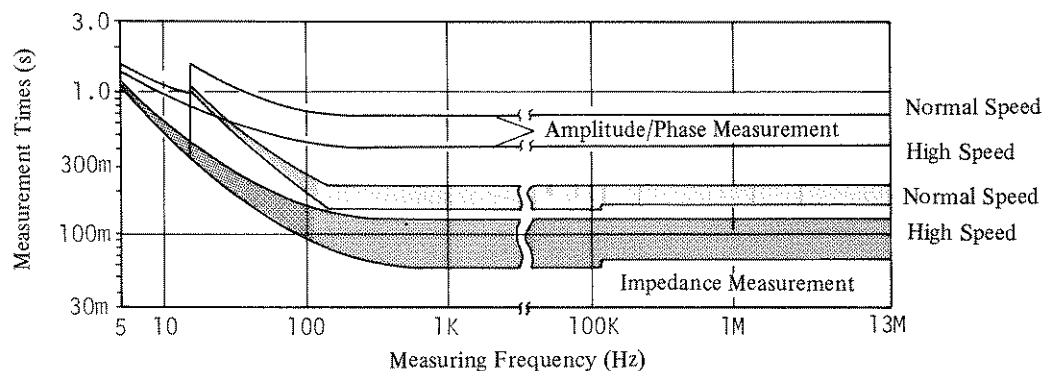

Table 1-2. General Information (Sheet 2 of 2)

FREQUENCY SWITCHING TIME : Approximately 50ms to 65ms

ZY RANGE SWITCHING TIME : Approximately 35ms to 50ms per range (at > 400Hz)

OSC LEVEL SWITCHING TIME : Approximately 65ms

DC BIAS VOLTAGE SETTling TIME : Approximately $(0.4 \times \Delta V + 10)$ ms where ΔV is the voltage change (V).

LEVEL MONITOR RANGE AND ACCURACY : At $23^{\circ}\text{C} \pm 5^{\circ}\text{C}$

| | Range | Accuracy (% of reading + count) |
|--|------------------------|---|
| Voltage | 5mV ~ 1.1V | $\leq 100\text{Hz} : (4 + 10/f) \% + 1$ |
| Current | 1 μA ~ 11mA | 100Hz to 1MHz : 4% + 1 |
| | | $\geq 1\text{MHz} : (4 + 0.8F) \% + 1$ |
| where f : measuring frequency (Hz), F : measuring frequency (MHz). | | |

TIME REQUIRED FOR LEVEL MONITOR : Approximately 120ms

1MHz REFERENCE OUTPUT : Square wave, $\geq 1.6\text{V}_{\text{p-p}}$

Output Resistance : Approximately 50Ω

1-22. OPTIONS

1-23. Options are modifications to the standard instrument that implement the user's special requirements for minor functional changes. The 4192A has four options as listed in Table 1-3.

Table 1-3. Available Options

| Option Number | Description |
|---------------|-----------------------------------|
| 907 | Front Handle Kit. |
| 908 | Rack Flange Kit. |
| 909 | Rack Flange and Front Handle Kit. |
| 910 | Extra Manual |

1-24. The following options provide the mechanical parts necessary for rack mounting and hand carrying:

Option 907: Front Handle Kit. Furnishes carrying handles for both ends of front-panel.

Option 908: Rack Flange Kit. Furnishes flanges for rack mounting for both ends of front-panel.

Option 909: Rack Flange and Front Handle Kit. Furnishes both front handles and rack flanges for instrument.

Installation procedures for these options are detailed in Section II.

1-25. Option 910 adds an extra copy of the Operation and Service Manual.

1-26. ACCESSORIES SUPPLIED

1-27. The HP Model 4192A LF Impedance Analyzer, along with its furnished accessories, is shown in Figure 1-1. The furnished accessories are also listed below.

- 16047A Test Fixture
- 11048C 50Ω Feedthrough (2 ea.)
- Power Splitter (HP Part No.: 04192-61001)
- BNC Adapter (HP Part No.: 1250-0216)
- 11170A BNC Cable (2 ea.)
- Power Cable (HP Part No.: 8120-1378)
- Additional Fuses for A1F1 (2ea. PN: 2110-0650)

1-28. ACCESSORIES AVAILABLE

1-29. For certain measurements and for convenience in connecting samples, ten types of accessories are available. Each accessory is designed to meet the various measurement requirements and types of DUT. All accessories were developed with careful consideration to accuracy, reliability, and ease of measurement. A brief description and photo of each available accessory is given in Table 1-4.

Table 1-4. Accessories Available (Sheet 1 of 4)

| Model | Description |
|---|---|
| <p data-bbox="267 283 406 315">HP 16047A</p>  | <p data-bbox="868 283 1429 315">16047A Direct Coupled Test Fixture (furnished):</p> <p data-bbox="868 315 1526 409">Test Fixture (direct attachment type) for general measurement of both axial and radial lead components. Three kinds of contact inserts are furnished:</p> <ul style="list-style-type: none"> <li data-bbox="868 420 1331 483">① For axial lead components, (HP P/N 16061-70022). <li data-bbox="868 493 1331 556">② For general radial lead components, (HP P/N 16061-70021). <li data-bbox="868 567 1347 640">③ For radial short lead components, (HP P/N 16047-65001). <p data-bbox="868 651 1266 682">DC bias up to $\pm 35V$ can be applied.</p> |
| <p data-bbox="267 724 406 756">HP 16047B</p>  | <p data-bbox="868 724 1315 756">16047B Test Fixture with Safe Guard:</p> <p data-bbox="868 756 1526 882">Test Fixture (cable connection type) for general measurement of both axial and radial lead components at frequencies below 2MHz. Three kinds of contact inserts are furnished (same as those for the 16047A Test Fixture).</p> <p data-bbox="868 903 1526 976">DC bias up to $\pm 35V$ can be applied with using the 4192A (a protective cover provides for operator safety).</p> <p data-bbox="868 987 1266 1018">Cable length: approximately 40 cm</p> |
| <p data-bbox="276 1260 414 1291">HP 16047C</p>  | <p data-bbox="868 1260 1315 1291">16047C High Frequency Test Fixture:</p> <p data-bbox="868 1291 1534 1449">Test Fixture (direct attachment type) especially appropriate for high frequency measurements requiring high accuracy. Two screw knobs facilitate and ensure optimum contact of electrodes and sample leads. Maximum applied dc bias voltage is $\pm 35V$.</p> |

Table 1-4. Accessories Available (Sheet 2 of 4)

| Model | Description |
|---|---|
| <p data-bbox="235 279 370 306">HP 16048A</p>  | <p data-bbox="829 279 1308 306">16048A Test Leads with BNC Connector:</p> <p data-bbox="829 310 1487 375">Test Leads (four terminal pair) with BNC connectors for connecting user-fabricated test fixtures.</p> <p data-bbox="829 401 1487 466">Maximum applied dc bias voltage is $\pm 200\text{V}$ (refer to Figure 3-34).</p> <p data-bbox="829 470 1029 497">Cable length: 1m</p> |
| <p data-bbox="235 646 370 674">HP 16048B</p>  | <p data-bbox="829 646 1414 674">16048B Test Leads with RF Miniature Connectors:</p> <p data-bbox="829 678 1487 772">Test Lead (four terminal pair) with miniature RF connectors suitable for connecting user-fabricated test fixtures in systems applications.</p> <p data-bbox="829 798 1487 863">Maximum applied dc bias voltage is $\pm 200\text{V}$ (refer to Figure 3-34).</p> <p data-bbox="829 867 1029 894">Cable length: 1m</p> |
| <p data-bbox="235 1024 370 1052">HP 16048C</p>  | <p data-bbox="829 1024 1292 1052">16048C Test Leads with Alligator Clips:</p> <p data-bbox="829 1056 1487 1157">Test Leads with dual alligator clips for testing components of various shapes and sizes at frequencies below 100kHz. Applicable measurement ranges:</p> <p data-bbox="899 1167 1179 1194">Capacitance $> 1000\text{pF}$</p> <p data-bbox="899 1199 1170 1226">Inductance $> 100\mu\text{H}$</p> <p data-bbox="829 1245 1305 1272">Maximum applied dc bias voltage is $\pm 35\text{V}$.</p> <p data-bbox="829 1276 1029 1304">Cable length: 1m</p> |
| <p data-bbox="235 1409 370 1436">HP 16034B</p>  | <p data-bbox="829 1409 1333 1436">16034B Test Fixture for Chip Components:</p> <p data-bbox="829 1440 1487 1570">Test Fixture (tweezer type) for measurement of miniature, leadless components such as chip capacitors. Employs a three terminal configuration tweezer probe suitable for high impedance component measurements (above 50Ω).</p> <p data-bbox="829 1589 1305 1617">Maximum applied dc bias voltage is $\pm 35\text{V}$.</p> <p data-bbox="829 1621 1029 1648">Cable length: 1m</p> |

Table 1-4. Accessories Available (Sheet 3 of 4)

| Model | Description | | | | | | | | | | |
|--|--|------|-------------|--------------------------------|-------------|---------------------------|-------------|--------------------|-------------|------------------------|-------------|
| <p data-bbox="261 296 394 321">HP 16095A</p>  <p>The image shows the HP 16095A Probe Fixture, a rectangular metal box with two probe ports on top. It is connected to a long, flexible probe cable with a loop at the end. Several other accessories are shown, including a BNC adapter, an alligator clip, and ground pins.</p> | <p data-bbox="852 296 1159 321">HP 16095A Probe Fixture:</p> <p data-bbox="852 327 1511 485">For probe impedance measurements on board-mounted components or entire circuits. Low lead can be floated or grounded. OSC OUTPUT connector is provided for amplitude-phase measurements. Following data is specified when BNC adapter is used:</p> <p data-bbox="922 512 1304 604"> Stray capacitance : $\leq 15\text{pF}$ Residual inductance : $\leq 40\text{nH}$ Residual resistance : $\leq 100\text{m}\Omega$ </p> <p data-bbox="852 632 1187 657">Following parts are furnished.</p> <table border="1" data-bbox="867 680 1523 995"> <thead> <tr> <th>Part</th> <th>HP Part No.</th> </tr> </thead> <tbody> <tr> <td>Center pins for probe (10 ea.)</td> <td>16095-60012</td> </tr> <tr> <td>Alligator clip for ground</td> <td>16095-61611</td> </tr> <tr> <td>BNC (male) adapter</td> <td>16095-60011</td> </tr> <tr> <td>Alligator clip adapter</td> <td>16095-61612</td> </tr> </tbody> </table> <p data-bbox="889 926 1503 984">Ground pins (5 ea., HP Part No. 16095-65001) are also available (not furnished).</p> | Part | HP Part No. | Center pins for probe (10 ea.) | 16095-60012 | Alligator clip for ground | 16095-61611 | BNC (male) adapter | 16095-60011 | Alligator clip adapter | 16095-61612 |
| Part | HP Part No. | | | | | | | | | | |
| Center pins for probe (10 ea.) | 16095-60012 | | | | | | | | | | |
| Alligator clip for ground | 16095-61611 | | | | | | | | | | |
| BNC (male) adapter | 16095-60011 | | | | | | | | | | |
| Alligator clip adapter | 16095-61612 | | | | | | | | | | |
| <p data-bbox="264 1045 355 1071">16097A</p>  <p>The image shows the 16097A Accessory Kit, which includes a carrying case containing various test equipment. Outside the case, several items are laid out, including BNC cables of different lengths, scope probes, test fixtures, and test leads.</p> | <p data-bbox="855 1045 1354 1071">16097A Accessory Kit (with carrying case):</p> <p data-bbox="855 1077 1528 1102">Contains the following accessories for circuit measurements:</p> <p data-bbox="924 1129 1359 1425"> 11094B 75Ω Feedthrough (2 ea.) 11095A 600Ω Feedthrough (2 ea.) 11070B 60cm BNC cable (2 ea.) 11170C 120cm BNC cable (2 ea.) 10013A 10 : 1 Scope probe (2 ea.) 10007B 1 : 1 Scope probe (2 ea.) 16047C Test Fixture 16048C Test Leads 16095A Probe Fixture </p> | | | | | | | | | | |

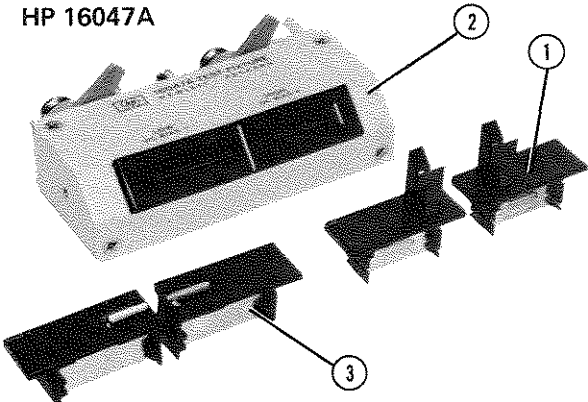
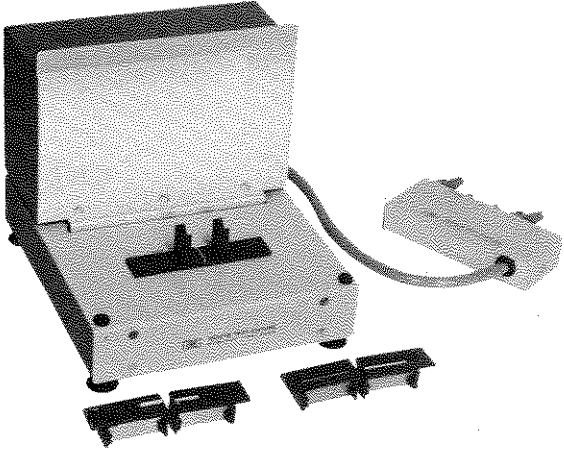
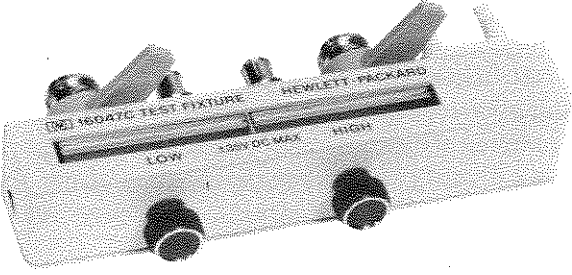
Table 1-4. Accessories Available (Sheet 4 of 4)

| Model | Description | | | | | | | | | | | | | | |
|--|---|------|-------------|-----------------------------------|-------------|---|------------------------|-------------------------|------------------------|-------------------------------------|-------------|--|-------------|---------------|-----------|
| <p data-bbox="219 304 316 331">16096A</p>  | <p data-bbox="812 298 1063 325">16096A Test Fixture:</p> <p data-bbox="812 329 1469 426">To alternately make amplitude/phase measurements and input impedance measurements on two-port devices. Following data is specified at BNC connectors:</p> <p data-bbox="812 451 1388 483">Residual Impedances (after zero offset adjustment):</p> <p data-bbox="885 489 1258 520">Stray capacitance : $\leq 0.01\text{pF}$</p> <p data-bbox="885 520 1372 552">Residual Inductance : $\leq (100 + 0.5F^2)\text{nH}$</p> <p data-bbox="885 552 1347 583">Residual resistance : $\leq (50 + 5F^2)\text{m}\Omega$</p> <p data-bbox="812 609 1469 672">Error in amplitude/phase measurements (after cable compensation):</p> <p data-bbox="885 682 1128 714">B–A error : $\pm 0.1\text{ dB}$</p> <p data-bbox="885 714 1104 745">Phase error : $\pm 0.1^\circ$</p> <p data-bbox="885 745 1266 777">A, B error : $\pm (0.1 + 0.06F^2)\text{ dB}$</p> <p data-bbox="812 802 1469 865">Input impedance of CHANNEL A/B : $1\text{ M}\Omega$ shunted by less than 15pF.</p> <p data-bbox="812 890 1153 921">Following parts are furnished:</p> <table border="1" data-bbox="828 940 1453 1350"> <thead> <tr> <th data-bbox="828 940 1291 982">Part</th> <th data-bbox="1291 940 1453 982">HP Part No.</th> </tr> </thead> <tbody> <tr> <td data-bbox="828 982 1291 1035">Textool® Grid zip test socket kit</td> <td data-bbox="1291 982 1453 1035">16096-65001</td> </tr> <tr> <td data-bbox="828 1035 1291 1108">BNC (male) to dual alligator clip cable</td> <td data-bbox="1291 1035 1453 1108">16096-61614 (4 ea.)</td> </tr> <tr> <td data-bbox="828 1108 1291 1182">BNC (male) to SMC cable</td> <td data-bbox="1291 1108 1453 1182">16096-61611 (4 ea.)</td> </tr> <tr> <td data-bbox="828 1182 1291 1234">Banana plug to alligator clip cable</td> <td data-bbox="1291 1182 1453 1234">16096-61613</td> </tr> <tr> <td data-bbox="828 1234 1291 1308">BNC (male) – BNC (male) cable (90 cm)</td> <td data-bbox="1291 1234 1453 1308">16096-61615</td> </tr> <tr> <td data-bbox="828 1308 1291 1350">BNC T adapter</td> <td data-bbox="1291 1308 1453 1350">1250-0781</td> </tr> </tbody> </table> | Part | HP Part No. | Textool® Grid zip test socket kit | 16096-65001 | BNC (male) to dual alligator clip cable | 16096-61614 (4 ea.) | BNC (male) to SMC cable | 16096-61611 (4 ea.) | Banana plug to alligator clip cable | 16096-61613 | BNC (male) – BNC (male) cable (90 cm) | 16096-61615 | BNC T adapter | 1250-0781 |
| Part | HP Part No. | | | | | | | | | | | | | | |
| Textool® Grid zip test socket kit | 16096-65001 | | | | | | | | | | | | | | |
| BNC (male) to dual alligator clip cable | 16096-61614 (4 ea.) | | | | | | | | | | | | | | |
| BNC (male) to SMC cable | 16096-61611 (4 ea.) | | | | | | | | | | | | | | |
| Banana plug to alligator clip cable | 16096-61613 | | | | | | | | | | | | | | |
| BNC (male) – BNC (male) cable (90 cm) | 16096-61615 | | | | | | | | | | | | | | |
| BNC T adapter | 1250-0781 | | | | | | | | | | | | | | |

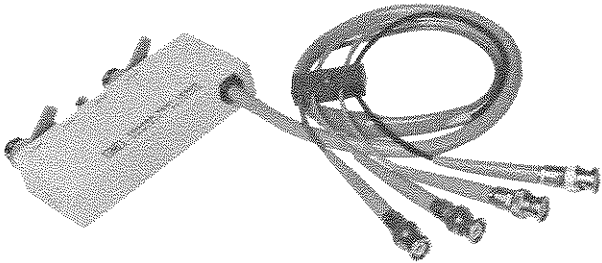
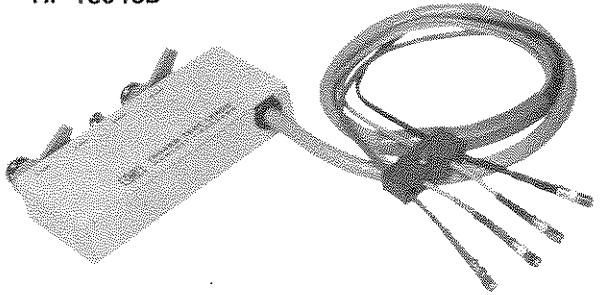
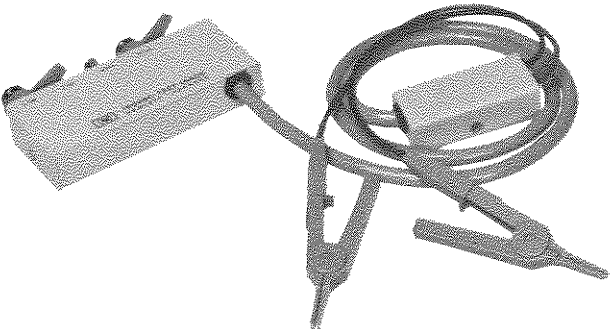
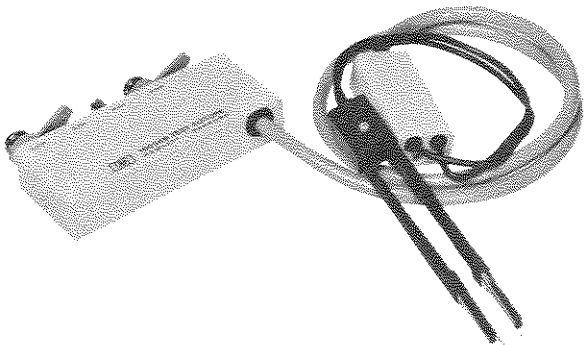
SECTION II INSTALLATION

2-1. INTRODUCTION

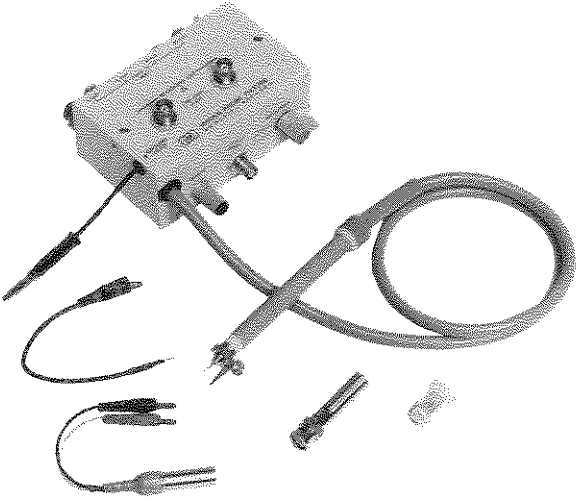
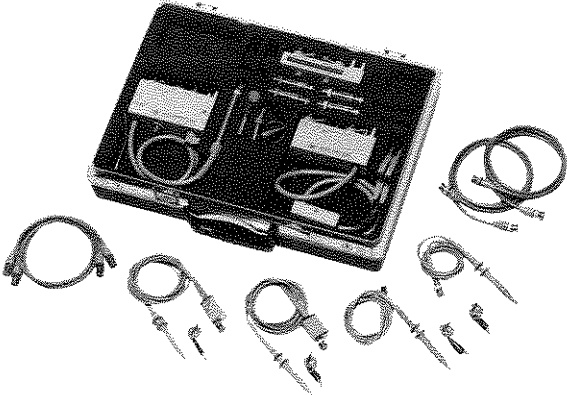
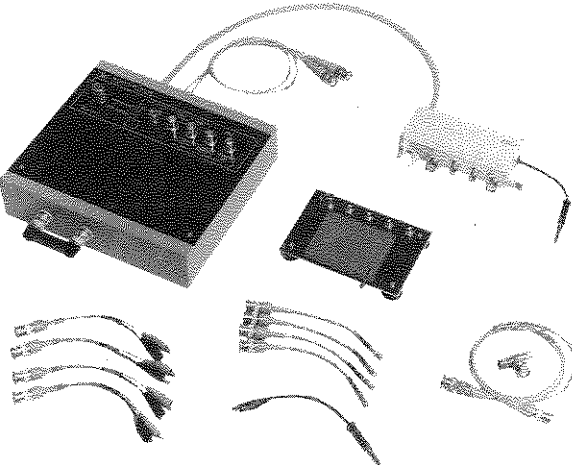
2-2. This section provides installation instructions for the Model 4192A Impedance Analyzer. The section also includes information on initial inspection and damage claims, preparation for using the 4192A, packaging, storage, and shipment.

2-3. INITIAL INSPECTION

2-4. The 4192A Impedance Analyzer, as shipped from the factory, meets all the specifications listed in Table 1-1. Upon receipt, inspect the shipping container for damage. If the shipping container or cushioning material is damaged, it should be kept until the contents of the shipment have been checked for completeness and the instrument has been checked mechanically and electrically. The contents of the shipment should be as shown in Figure 1-1. The procedures for checking electrical performance are given in Section III, paragraph 3-7, Self Test and in Section IV, Performance Tests. If the shipment is incomplete, if the instrument is damaged in any way, or if the instrument does not pass the Performance Tests, notify the nearest Hewlett-Packard office. If the shipping container is damaged, notify the carrier as well as Hewlett-Packard. Keep the shipping materials for the carrier's inspection. The HP office will arrange for repair or replacement without waiting for claim settlement.

2-5. PREPARATION FOR USE

2-6. Power Requirements

2-7. The 4192A requires a power source of 100, 120, 220 Volts ac $\pm 10\%$, or 240 Volts ac $+5\% - 10\%$, 48 to 66Hz single phase; power consumption is 150VA maximum.

WARNING

THIS IS A SAFETY CLASS I PRODUCT (PROVIDED WITH A PROTECTIVE EARTH TERMINAL). AN UNINTERRUPTIBLE SAFETY EARTH GROUND MUST BE PROVIDED FROM THE MAIN POWER SOURCE TO THE INSTRUMENT'S INPUT WIRING TERMINALS, POWER CORD, OR SUPPLIED POWER CORD SET. WHENEVER THE SAFETY EARTH GROUND HAS BEEN IMPAIRED, THE INSTRUMENT MUST BE MADE INOPERATIVE AND BE SECURED AGAINST ANY UNINTENDED OPERATION. IF THIS INSTRUMENT IS TO BE ENERGIZED VIA AN AUTOTRANSFORMER FOR VOLTAGE REDUCTION, MAKE SURE THAT THE COMMON TERMINAL IS CONNECTED TO THE EARTH POLE OF THE POWER SOURCE.

2-8. Line Voltage and Fuse Selection

CAUTION

BEFORE CONNECTING THE INSTRUMENT TO THE POWER SOURCE, make sure that the correct fuse has been installed and that the line voltage selection switch is set to the correct voltage.

2-9. Figure 2-1 provides instructions for line voltage and fuse selection. The line voltage selection switch and the proper fuse are factory installed for 100 or 120 volts ac operation. Current ratings for the fuse are printed under the fuseholder on the instrument's rear-panel and are listed, with HP part numbers, in Figure 2-1.

CAUTION

Use the proper fuse for the line voltage selected. Make sure that only fuses for the required rated current and of the specified type are used for replacement. The use of mended fuses or short-circuited fuse-holders must be avoided.

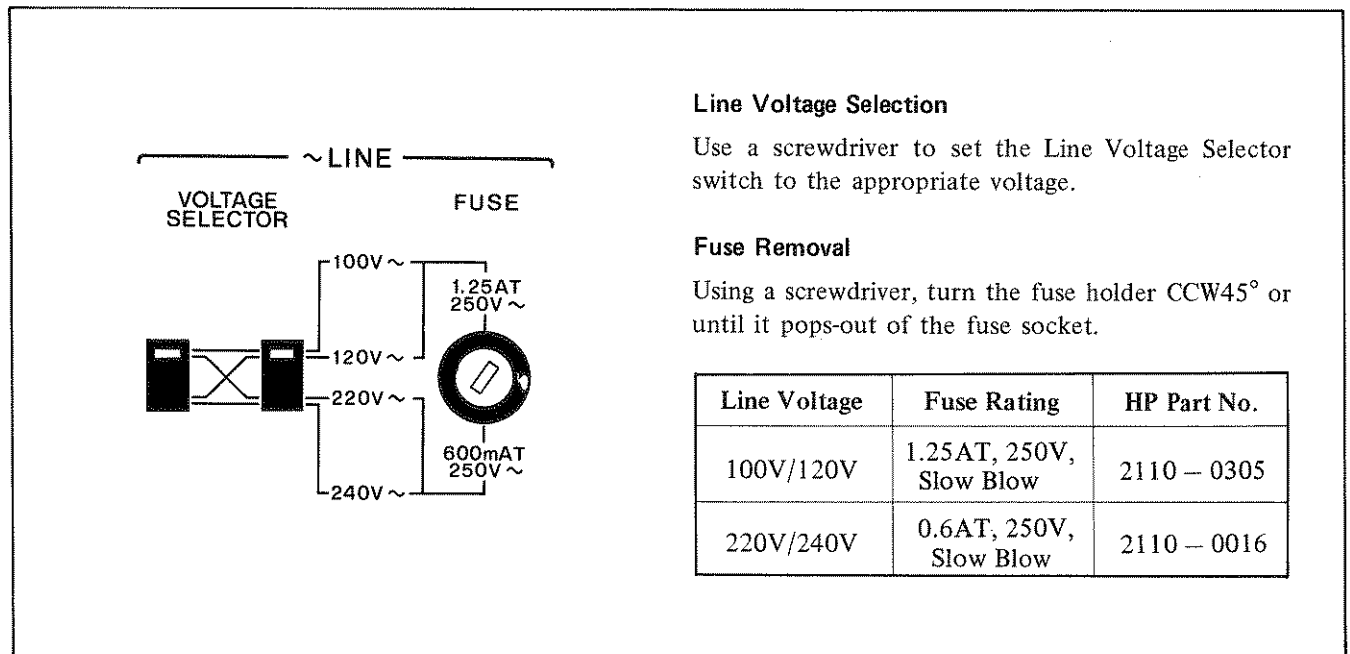

Figure 2-1. Line Voltage and Fuse Selection.

2-10. POWER CABLE

2-11. To protect operating personnel, the National Electrical Manufacturer's Association (NEMA) recommends that the instrument panel and cabinet be grounded. The Model 4192A is equipped with a three-conductor power cable which, when plugged into an appropriate ac power receptacle, grounds the instrument. The offset pin on the power cable is the ground wire.

2-12. To preserve the protection feature when operating the instrument from a two contact outlet, use a three prong to two prong adapter (HP Part No. 1251-8196) and connect the green pigtail on the adapter to power line ground.

CAUTION

The mains plug must only be inserted in a socket outlet provided with a protective earth contact. The protective action must not be negated by the use of an extension cord (POWER CABLE) without protective conductor (GROUNDING).

2-13. Figure 2-2 shows the available power cords which may be used in various countries. Also shown is the standard power cord furnished with the instrument. HP Part numbers, applicable standards for power plug, power cord color, electrical characteristics and countries using each power cord are listed in the figure. If assistance is

Line Voltage Selection

Use a screwdriver to set the Line Voltage Selector switch to the appropriate voltage.

Fuse Removal

Using a screwdriver, turn the fuse holder CCW45° or until it pops-out of the fuse socket.

| Line Voltage | Fuse Rating | HP Part No. |
|--------------|-------------------------|-------------|
| 100V/120V | 1.25AT, 250V, Slow Blow | 2110 - 0305 |
| 220V/240V | 0.6AT, 250V, Slow Blow | 2110 - 0016 |

needed for selecting the correct power cable, contact the nearest Hewlett-Packard office.

2-14. Interconnections

2-15. To interconnect the 4192A to an external controller or peripheral device using the HP-IB interface capability (IEEE Std. 488/ANSI-MC1.1), connect the HP-IB interface cable between the HP-IB connector on the rear panel of the 4192A and the HP-IB connector on the peripheral device. Refer to paragraph 3-109 for details on the HP-IB.

When an external frequency synthesizer is used, remove the cable connected between the VCO OUTPUT and EXT VCO connectors (located on the 4192A's rear panel), connect the OUTPUT of the external frequency synthesizer to the EXT VCO connector, and connect the 1MHz or 10MHz REFERENCE OUTPUT of the external frequency synthesizer to the 4192A's EXT REFERENCE connector. Refer to paragraph 3-131 for details on using an external frequency synthesizer.

When an X-Y recorder is used, connect the RECORDER OUTPUTS connectors (located on the 4192A's rear panel) to the X and Y axes connectors of the X-Y recorder. If the X-Y recorder is equipped with remote TTL pen lift control, connect the 4192A's PEN LIFT connector to the X-Y recorder's pen lift terminal. Refer to paragraph 3-137 for details on using an X-Y recorder.

| | |
|--|---|
| <p>OPTION 900 United Kingdom</p>  <p>Plug : BS 1363A, 250V Cable : HP 8120-1351</p> | <p>OPTION 901 Australia/New Zealand</p>  <p>Plug : NZSS 198/AS C112, 250V Cable : HP 8120-1369</p> |
| <p>OPTION 902 European Continent</p>  <p>Plug : CEE-VII, 250V Cable : HP 8120-1689</p> | <p>OPTION 903 U.S./Canada</p>  <p>Plug : NEMA 5-15P, 125V, 15A Cable : HP 8120-1378</p> |
| <p>OPTION 905** Any country</p>  <p>Plug : CEE 22-VI, 250V Cable : HP 8120-1396</p> | <p>OPTION 906 Switzerland</p>  <p>Plug : SEV 1011.1959-24507 Type 12, 250V Cable : HP 8120-2104</p> |
| <p>OPTION 912 Denmark</p>  <p>Plug : DHCR 107, 220V Cable : HP 8120-2956</p> | <p>** Plug option 905 is frequently used for interconnecting system components and peripherals.</p> |
| <p>NOTE : Each option number includes a ' family ' of cords and connectors of various materials and plug body configurations (straight, 90 ° etc.).</p> | |

Figure 2-2. Power Cables Supplied.

2-16. Operating Environment

2-17. Temperature. The instrument may be operated in environments with ambient temperatures from 0°C to +55°C.

2-18. Humidity. The instrument may be operated in environments with relative humidities to 95% at 40°C. However, the instrument should be protected from temperature extremes which cause condensation within the instrument.

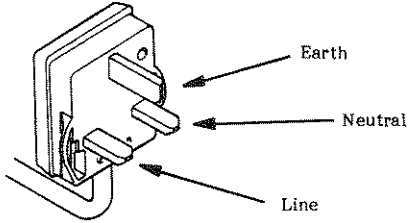
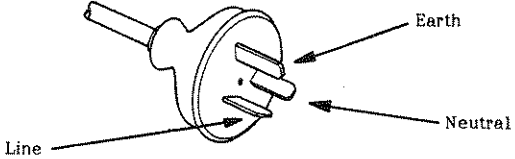
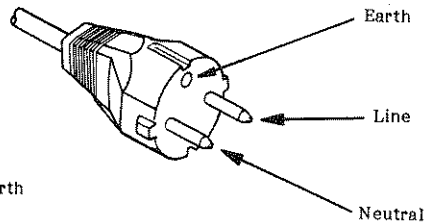
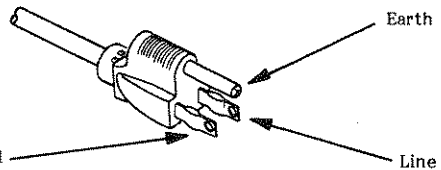
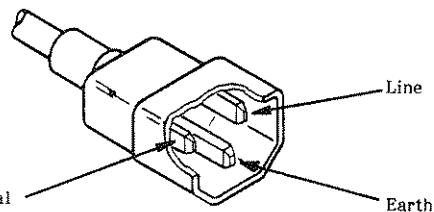
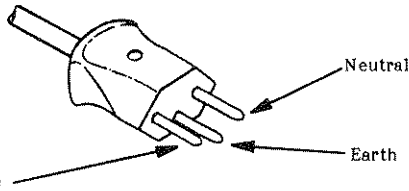
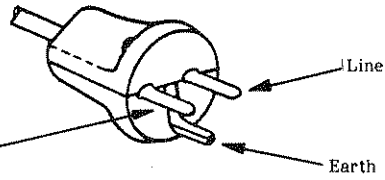
2-19. INSTALLATION INSTRUCTIONS

2-20. The 4192A can be operated on a bench or can be rack-mounted. The 4192A is ready for bench operation as shipped from the factory. For bench operation, the instrument is equipped with two retractable legs that are located on the bottom cover. They are extended by pulling them away from the bottom cover.

2-21. Installation of Options 907, 908 and 909

2-22. The 4192A can be rack-mounted and operated as part of a measurement system. Rack mounting information for the 4192A is given in Figure 2-3.

| Option | Kit Part Number | Parts Included | Part Number | Q'ty | Remarks |
|--------|--|---|---|-------------|-----------|
| 907 | Handle Kit 5061-0091 | Front Handle Trim Strip # 8-32 x 3/8 Screw | ③ 5060-9901 ④ 5060-8898 2510-0195 | 2 2 6 | 9.525 mm |
| 908 | Rack Flange Kit 5061-0079 | Rack Mount Flange # 8-32 x 3/8 Screw | ② 5020-8864 2510-0193 | 2 6 | 9.525 mm |
| 909 | Rack Flange & Handle Kit 5061-0085 | Front Handle Rack Mount Flange # 8-32 x 5/8 Screw | ③ 5060-9901 ⑤ 5020-8876 2510-0194 | 2 2 6 | 15.875 mm |

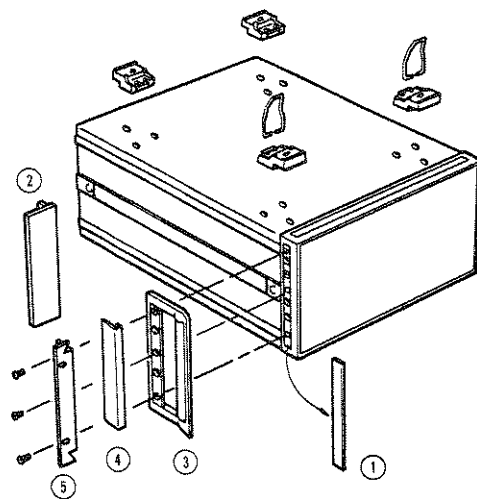

1. Remove the adhesive-backed trim strip ① from both sides of the front-panel frame.
2. HANDLE INSTALLATION: Attach the handles ③ to both sides of the front-panel frame with the screws provided, and attach trim ④.
3. RACK MOUNTING: Attach rack mount flange ② to both sides of the front-panel frame with the screws provided.
4. HANDLE AND RACK MOUNTING: Attach front handle ③ and rack mount flange ⑤ to both sides of the front-panel frame with screws provided.
5. When rack mounting (3 and 4 above), remove the four instrument feet (lift tab, and slide the foot in the direction of the tab).

Figure 2-3. Rack Mount Kits.

2-23. STORAGE AND SHIPMENT**2-24. Environment**

2-25. The instrument should be stored in a clean, dry environment. The following environmental limitations apply to both storage and shipment:

Temperature -55°C to +75°C
Humidity to 95% (at 40°C)

The instrument should be protected from temperature extremes which cause condensation inside the instrument.

2-26. Packaging

2-27. Original Packaging. Containers and materials identical to those used in factory packaging are available through Hewlett-Packard offices. If the instrument is being returned to Hewlett-Packard for servicing, attach a tag indicating the type of service required, return address, model number, and full serial number. Also mark the container FRAGILE to assure careful handling. In any correspondence, refer to the instrument by model number and full serial number.

2-28. Other Packaging. The following general instructions should be used for repackaging with commercially available materials:

- a. Wrap instrument in heavy paper or plastic. If shipping to Hewlett-Packard office or service center, attach tag indicating type of service required, return address, model number, and full serial number.
- b. Use strong shipping container. A double-walled carton made of 350 pound test material is adequate.
- c. Use enough shock absorbing material (3 to 4 inch layer) around all sides of the instrument to provide a firm cushion and prevent movement inside container. Protect front-panel with cardboard.
- d. Seal shipping container securely.
- e. Mark shipping container FRAGILE to ensure careful handling.
- f. In any correspondence, refer to instrument by model number and full serial number.

SECTION III OPERATION

3-1. INTRODUCTION

3-2. This section provides all the information necessary to operate the Model 4192A LF Impedance Analyzer. Included are descriptions of the front- and rear-panel controls, displays, lamps, and connectors; discussions on operating procedures and measuring techniques for various applications; and instructions on the instrument's SELF TEST function. A break-down of the contents of this section is given in Figure 3-1. Warnings, Cautions, and Notes are given throughout; they should be carefully observed to secure the safety of the operator and the serviceability of the instrument.

ALL PROTECTIVE EARTH TERMINALS, EXTENSION CORDS, AUTO-TRANSFORMERS AND DEVICES CONNECTED TO IT SHOULD BE CONNECTED TO A PROTECTIVE EARTH GROUNDED SOCKET. ANY INTERRUPTION OF THE PROTECTIVE EARTH GROUNDING WILL CAUSE A POTENTIAL SHOCK HAZARD THAT COULD RESULT IN PERSONAL INJURY.

ONLY FUSES WITH THE REQUIRED RATED CURRENT AND OF THE SPECIFIED TYPE SHOULD BE USED. DO NOT USE REPAIRED FUSES OR SHORT CIRCUITED FUSEHOLDERS. TO DO SO COULD CAUSE A SHOCK OR FIRE HAZARD.

WARNING

BEFORE THE INSTRUMENT IS SWITCHED ON,

Caution: Before the instrument is switched on, it must be set to the voltage of the power source, or damage to the instrument may result.

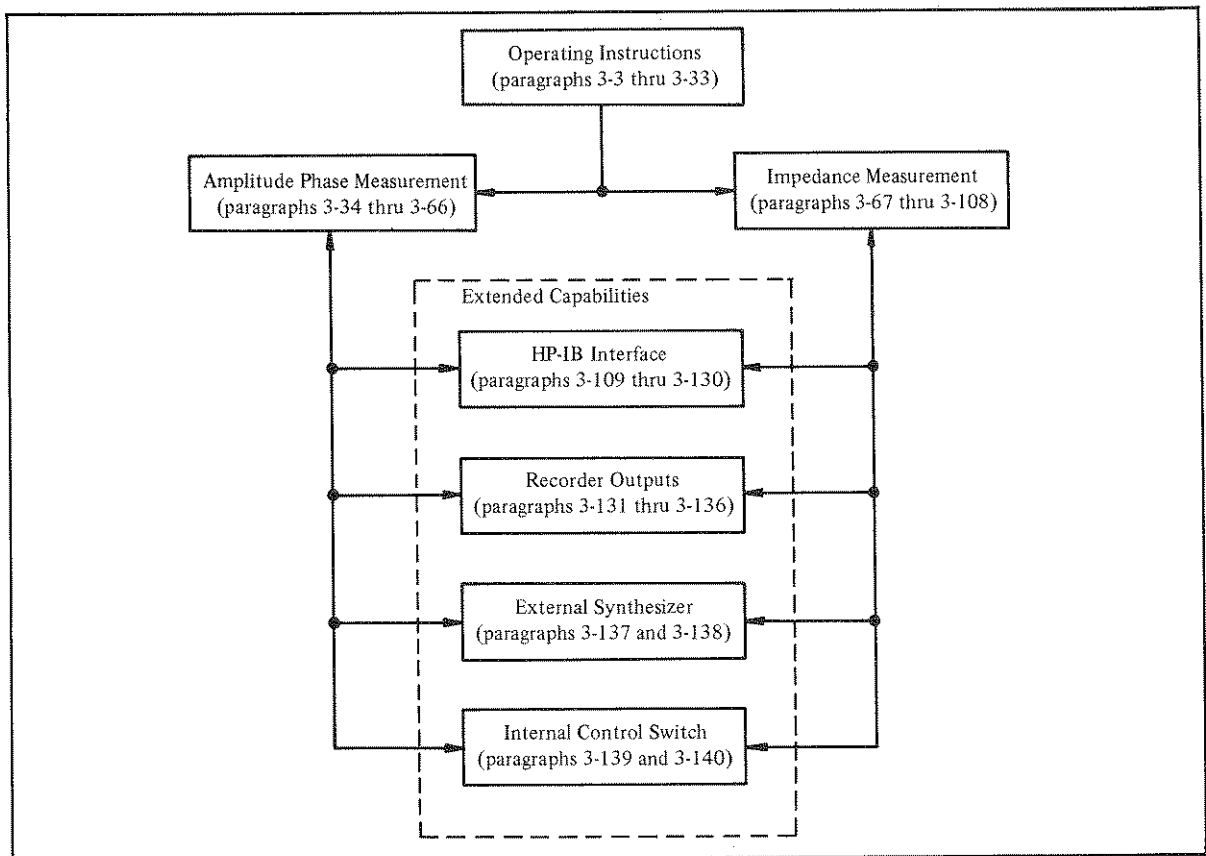

Figure 3-1. Contents of Section III

3-3. OPERATING INSTRUCTIONS

3-4. Operating instructions for the instrument's basic capabilities are given in paragraphs 3-5 through 3-33. Operating instructions for extended capabilities (remote operation via the HP-IB, X-Y Recorder Outputs, External Synthesizer, and Internal Control Switches) are covered in paragraphs 3-109 through 3-140.

3-5. Panel Features

3-6. Front- and rear-panel features are described in Figures 3-2 and 3-3, respectively. More detailed information on the panel displays and controls is given starting in paragraph 3-7.

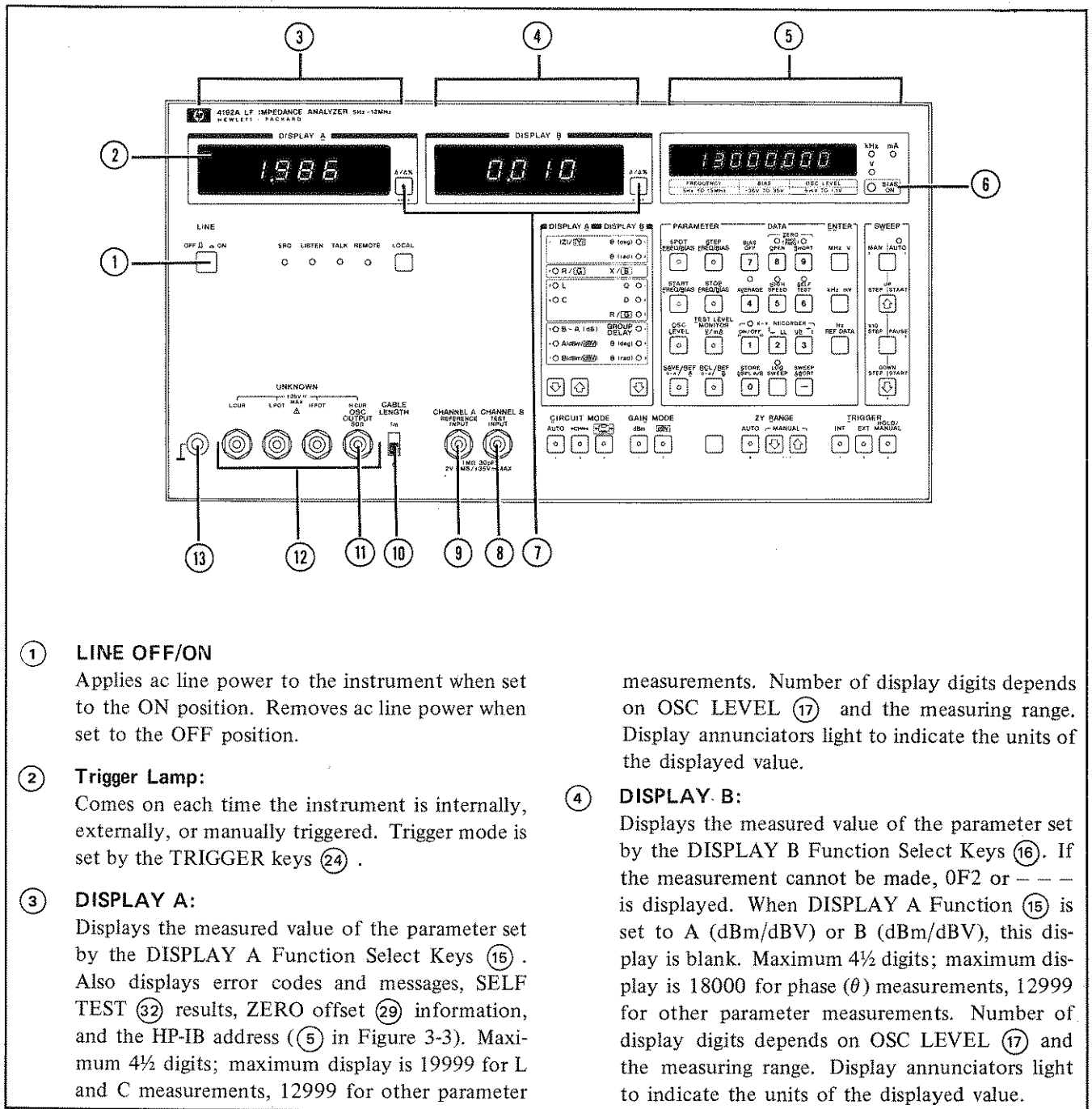

- ① **LINE OFF/ON**
 Applies ac line power to the instrument when set to the ON position. Removes ac line power when set to the OFF position.
- ② **Trigger Lamp:**
 Comes on each time the instrument is internally, externally, or manually triggered. Trigger mode is set by the TRIGGER keys (24).
- ③ **DISPLAY A:**
 Displays the measured value of the parameter set by the DISPLAY A Function Select Keys (15). Also displays error codes and messages, SELF TEST (32) results, ZERO offset (29) information, and the HP-IB address ((5) in Figure 3-3). Maximum 4½ digits; maximum display is 19999 for L and C measurements, 12999 for other parameter

- ④ **DISPLAY B:**
 Displays the measured value of the parameter set by the DISPLAY B Function Select Keys (16). If the measurement cannot be made, 0F2 or --- is displayed. When DISPLAY A Function (15) is set to A (dBm/dBV) or B (dBm/dBV), this display is blank. Maximum 4½ digits; maximum display is 18000 for phase (θ) measurements, 12999 for other parameter measurements. Number of display digits depends on OSC LEVEL (17) and the measuring range. Display annunciators light to indicate the units of the displayed value.

Figure 3-2. Front Panel Features (Sheet 1 of 10)

- 5 Test Parameter Data Display (DISPLAY C):**
Displays test parameter values (FREQ. BIAS, and OSC LEVEL). Test parameters are set by the test PARAMETER Select keys (17). Maximum 7½ digits for frequency; 4½ digits for OSC LEVEL and DC BIAS. Annunciator lamps, located to the right of the display, light to indicate the units of the displayed value. Also displays error codes, overflow annunciation, and information related to the SAVE function.
- 6 BIAS ON Indicator:**
Comes on when dc bias is applied to the DUT; goes off when the BIAS OFF key (28) is pressed.
- 7 $\Delta/\Delta\%$ Keys and Indicators:**
These keys – one for DISPLAY A and one for DISPLAY B – are used for deviation (Δ) or percent deviation ($\Delta\%$) measurement. For percent deviation ($\Delta\%$), the **Blue** key (37) must be pressed before the $\Delta/\Delta\%$ key.
 Δ (Delta): The difference between the measured value of the DUT and a previously stored reference value is displayed by pressing this key. The formula used to calculate the deviation is
- $$A - B$$
- where A is the measured value of the DUT and B is the stored reference value
- $\Delta\%$: The difference between the measured value of the DUT and a previously stored reference value is displayed as a percentage of the reference value. The formula used to calculate the percent deviation is
- $$\frac{A - B}{B} \times 100 (\%)$$
- where A is the measured value of the DUT and B is the stored reference value.
- 8 CHANNEL B (TEST INPUT) Connector:**
Used in conjunction with CHANNEL A (9) and OSC OUTPUT (11) in transmission characteristics measurements, i.e., gain/loss (B–A), level (A or B), phase, group delay. Output port of the network under test is connected to this connector. Input impedance is $1 \text{ M}\Omega \pm 2\%$, shunted by $25 \text{ pF} \pm 5 \text{ pF}$. Maximum input voltage is AC 2 Vrms and DC $\pm 35\text{V}$.
- 9 CHANNEL A (REFERENCE INPUT) Connector:**
Used in conjunction with CHANNEL B (8) and OSC OUTPUT (11) in transmission characteristics measurements, i.e., gain/loss (B–A), level (A or B), phase, group delay. The 5 Hz – 13 MHz signal from OSC OUTPUT (11) is simultaneously applied to the input port of the network under test and this connector. Input impedance, shunt capacitance, and maximum input voltage of CHANNEL A are the same as those of CHANNEL B (8).
- 10 CABLE LENGTH Switch:**
This switch has meaning in impedance measurements only. It facilitates balancing of the measuring bridge circuit and minimizes measurement errors when the standard 1 meter test leads are used.
1m: Set the switch to this position when using the standard 1 meter test leads. Appropriate compensation is made for propagation delay and phase error caused by the test leads in high frequency measurements.
0: Set the switch to this position when using a direct attachment type test fixture (connects to the UNKNOWN terminals (12)).
- 11 OSC OUTPUT Connector:**
Used in conjunction with CHANNEL A (9) and CHANNEL B (8) in transmission characteristics measurements, i.e., gain/loss (B–A), level (A or B), phase, group delay. Provides a 5 Hz to 13 MHz stimulus signal for the network under test (output of network is connected to CHANNEL B (8) and the reference signal for CHANNEL A (9)). Output impedance is approximately 50Ω .
- 12 UNKNOWN Terminals:**
Used for impedance/phase measurements – $|Z|$, $|Y|$, R, G, L, C, X, B, phase – these four BNC connectors provide the means to connect DUT's – components or networks – in a four terminal pair configuration: High current terminal (H_{CUR}), High potential terminal (H_{POT}), Low current terminal (L_{CUR}), and Low potential terminal (L_{POT}). Four terminal pair test fixture attaches directly to these terminals.
- 13 GROUND Terminal:**
This terminal is tied to the instrument's chassis ground and can be used in measurements that require guarding.

Figure 3-2. Front Panel Features (Sheet 2 of 10)

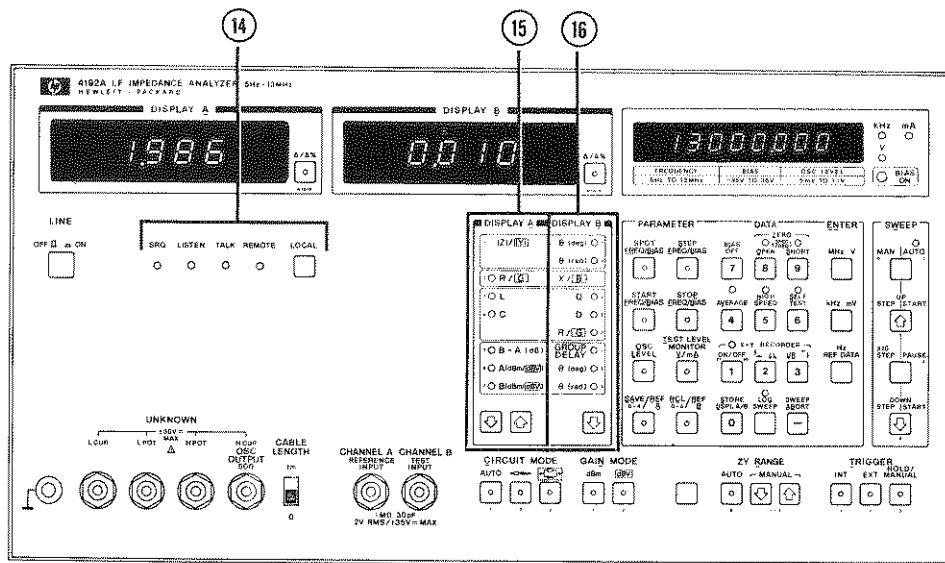

14 HP-IB Status Indicators and LOCAL key:

These four LED lamps – SRQ, LISTEN, TALK, and REMOTE – indicate the status of the 4192A when it is interfaced with a controller via the HP-IB.

The LOCAL key, when pressed, releases the instrument from REMOTE (HP-IB) control and enables front-panel control. The LOCAL key does not function when the instrument is set to local lockout by the controller.

15 DISPLAY A Function Select Keys and Indicators:

These keys – \downarrow and \uparrow – are used in conjunction with the CIRCUIT MODE keys (27) to select the primary measurement parameter for display on DISPLAY A. The selectable parameters are $|Z|/|Y|$, R/G, L, C, B-A (dB), A (dBm/dBV), or B (dBm/dBV). The selected parameter is indicated by the corresponding LED lamp. Pressing either of these keys shifts the selected parameter in the indicated direction (\downarrow , \uparrow).

$|Z|/|Y|$: When CIRCUIT MODE (27) is set to AUTO or --- , the instrument measures $|Z|$ (absolute value of the DUT's impedance) and θ (phase angle) in degrees or radians (depends on DISPLAY A Function (16) setting); the results are displayed on DISPLAY A ($|Z|$) and DISPLAY B (θ) to provide a polar representation ($|Z|/\theta$) of the DUT's impedance. When CIRCUIT

MODE (27) is set to --- , the instrument measures $|Y|$ (absolute value of the DUT's admittance) and θ (phase angle) in degrees or radians; the results are displayed on DISPLAY A ($|Y|$) and DISPLAY B (θ) to provide a polar representation ($|Y|/\theta$) of the DUT's admittance.

R/G: When CIRCUIT MODE (27) is set to --- , the instrument measures R (resistance of the DUT) and X (reactance of the DUT); the results are displayed on DISPLAY A (R) and DISPLAY B (X) to provide a rectangular (Cartesian) representation ($R \pm jX$) of the DUT's impedance.

When CIRCUIT MODE (27) is set to --- , the instrument measures G (conductance) and B (susceptance); the results are displayed on DISPLAY A (G) and DISPLAY B (B) to provide a rectangular (Cartesian) representation ($G \pm jB$) of the DUT's admittance.

L: Measures inductance and – depending on the setting of DISPLAY B Function (16) – Q (quality factor), D (dissipation factor), or R/G (equivalent series resistance or equivalent parallel conductance [to measure G, CIRCUIT MODE (27) must be set to ---]);

Figure 3-2. Front Panel Features (Sheet 3 of 10)



| | |
|--|---|
| <p>the results are displayed on DISPLAY A and DISPLAY B, respectively.</p> <p>C : Measures capacitance and— depending on the setting of DISPLAY B Function (16) — Q (quality factor), D (dissipation factor, or R/G (equivalent series resistance or equivalent parallel conductance [to measure G, CIRCUIT MODE (27) must be set to ]); the results are displayed on DISPLAY A (3) and DISPLAY B (4), respectively.</p> <p>B-A (dB) : Measures the relative amplitude of the reference input (CHANNEL A (9)) and the test input (CHANNEL B (8)). The result is displayed on DISPLAY A (3). Also measures group delay or phase in degrees or radians (selected by DISPLAY B Function (16)). The value displayed on DISPLAY A (3) is the gain or loss of the network under test. Group delay or phase is displayed on DISPLAY B (4).</p> <p>A (dBm/dBV) : Measures the absolute amplitude of the reference input (CHANNEL A (9)) in dBm or dBV (selected by GAIN MODE Select key (26)). Amplitude is displayed on DISPLAY A (3). When this parameter is selected, DISPLAY B Function (16) has no selectable parameters and DISPLAY B (4) is blank.</p> <p>B (dBm/dBV) : Measures the absolute amplitude of the test input (CHANNEL B (8)); identical to A (dBm/dBV) in all other respects.</p> | <p>The selected parameter is indicated by the corresponding LED lamp. Pressing this key shifts the selected parameter in the indicated direction ().</p> <p>θ (deg) : Measures, in degrees, the phase angle of Z (absolute impedance of the DUT) or Y (absolute admittance of the DUT).</p> <p>θ (rad) : Measures, in radians, the phase angle of Z (absolute impedance of the DUT) or Y (absolute admittance of the DUT).</p> <p>X/B : These parameters are automatically selected when DISPLAY A Function (15) is set to R/G. X is the reactance of DUT's impedance; B is the susceptance of the DUT's admittance.</p> <p>Q : Measures the quality factor of the DUT. DISPLAY A Function (15) must be set to L (inductance) or C (capacitance).</p> <p>D : Measures the dissipation factor of the DUT. DISPLAY A Function (15) must be set to L (inductance) or C (capacitance).</p> <p>R/G : Measures the resistance or conductance of the DUT. DISPLAY A Function (15) must be set to L (inductance) or C (capacitance). CIRCUIT MODE keys (27) determine which of the two parameters (R or G) is selected.</p> <p>GROUP DELAY : Measures the group delay between the reference input (CHANNEL A (9)) and test input (CHANNEL B (8)). Can only be selected when DISPLAY A Function (15) is set to B-A (dB).</p> |
| <p>(16) DISPLAY B Function Select Key and Indicators: This key,  , is used in conjunction with the CIRCUIT MODE keys (27) to select the secondary measurement parameter for display on DISPLAY B (4). Selectable parameters are θ (phase), Q (quality factor), D (dissipation factor), R/G (equivalent series resistance or equivalent parallel conductance), and GROUP DELAY. Phase (θ) can only be selected when DISPLAY A Function (15) is set to Z / Y or B-A (dB); Q, D, and R/G, only when DISPLAY A Function is set to L or C; GROUP DELAY, only when DISPLAY A Function is set to B-A (dB).</p> | <p>θ (deg) : Measures, in degrees, the phase difference between the reference input (CHANNEL A (9)) and test input (CHANNEL B (8)). Can only be selected when DISPLAY A Function (15) is set to B-A (dB).</p> <p>θ (rad) : Measures, in radians, the phase difference between the reference input (CHANNEL A (9)) and test input (CHANNEL B (8)). Can only be selected when DISPLAY A Function (15) is set to B-A (dB).</p> |

Figure 3-2. Front Panel Features (Sheet 4 of 10)



①⑦ **Test PARAMETER Select Keys and Indicators:**
 These keys are used in conjunction with the DATA input keys ①⑨, ENTER keys ②①, and the BLUE key ③⑦ to assign values to the various test parameters; to monitor the test parameters; to save and recall front-panel control settings; and to input reference data for deviation and percent deviation ($\Delta/\Delta\%$ ⑦) measurements. Pressing a test parameter key will cause the value of the selected test parameter to be displayed on the Test Parameter Data Display ⑤. Lighted indicator lamp (center of each key) indicates selected test parameter. Only one test parameter can be selected. Test parameters labelled in blue are accessible by first pressing the BLUE key ③⑦.

SPOT FREQ/BIAS:

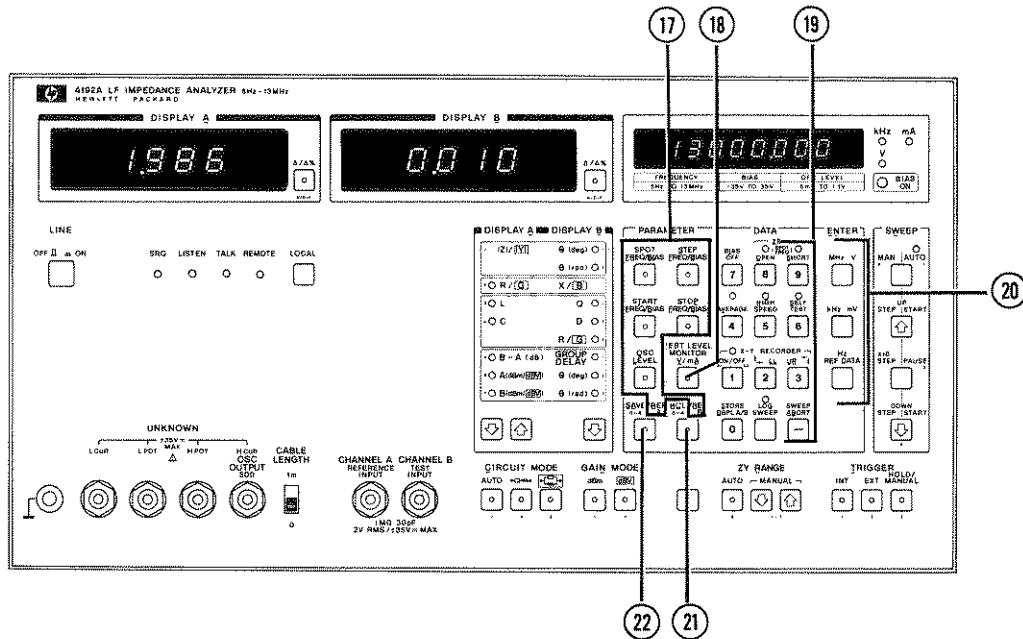
For single point measurements. Sets the spot frequency and spot bias.
 When spot bias is set, BIAS ON Indicator ⑥ lights.

STEP FREQ/BIAS:

For swept measurements. Sets the step (increment) frequency and step (increment) bias.

START FREQ/BIAS :

For swept measurements. Sets the start frequency and start bias.

STOP FREQ/BIAS :

For swept measurements. Sets the stop frequency and stop bias.

OSC LEVEL :

Sets the voltage (rms) of the internal frequency synthesizer.

REF A :

For deviation and percent deviation ($\Delta/\Delta\%$ ⑦) measurements. Sets the reference value for DISPLAY A.

REF B :

For deviation and percent deviation ($\Delta/\Delta\%$ ⑦) measurements. Sets the reference value for DISPLAY B.

Figure 3-2. Front Panel Features (Sheet 5 of 10)

- 18 TEST LEVEL MONITOR Key and Indicator:**
Pressing this key displays the level of the test signal applied to the DUT or, if the BLUE key (37) is first pressed, the current through the DUT on the Test Parameter Data Display (5). The appropriate annunciator lamp will light.
- 19 DATA Input Keys:**
These keys (0 thru 9, decimal point, and minus sign) are used to input test parameter values, register numbers for SAVE (22) and RCL (21) functions, and reference data for DISPLAY A (REF A) and DISPLAY B (REF B) deviation measurements ($\Delta/\Delta\%$ (7)). Data is displayed on the Test Parameter Data Display (5) as it is input. Each key has a control function – labelled in blue above the key – which is accessible via the BLUE key (37). These control functions are explained individually in (28) thru (36).
- 20 ENTER Keys:**
These keys instruct the instrument to read the test parameter data and reference data set by the PARAMETER Select keys (17) and DATA Input keys (19). Data are not input until one of these keys is pressed.
- MHz, V : Enters the value input from the DATA Input keys (19) in MHz for frequency parameters or V for bias parameters.
- kHz, mV : Enters the value input from the DATA Input keys (19) in kHz for frequency parameters or mV for bias parameters.
- Hz, REF DATA:
Enters the value input from the DATA Input key (19) in Hz for frequency parameters or as reference data for deviation measurements.
- 21 RCL (Recall) Key:**
This key is used to return the instrument to the front-panel control settings, test parameter values, calibration data (ZERO OPEN/SHORT (29)), and reference data saved by the SAVE key (22). DATA Input keys (19) 0 thru 4 are used to select the desired register. For example, to return the instrument to the control settings stored in register 0, press $\overset{\text{RCL/REF}}{\square}$ and \square 0 .
- 22 SAVE Key:**
This key is used to save (store) front-panel control settings, test parameter values, calibration data (ZERO OPEN/SHORT (29)), and reference data. There are five registers (0 thru 4), so five sets of control settings can be saved. And because the registers are nonvolatile, saved control settings can be recalled (RCL key (21)) even if the instrument has been turned off. To store existing control settings, press $\overset{\text{SAVE/REF}}{\square}$ and enter the register number from the DATA Input keys (19) .

Figure 3-2. Front Panel Features (Sheet 6 of 10)

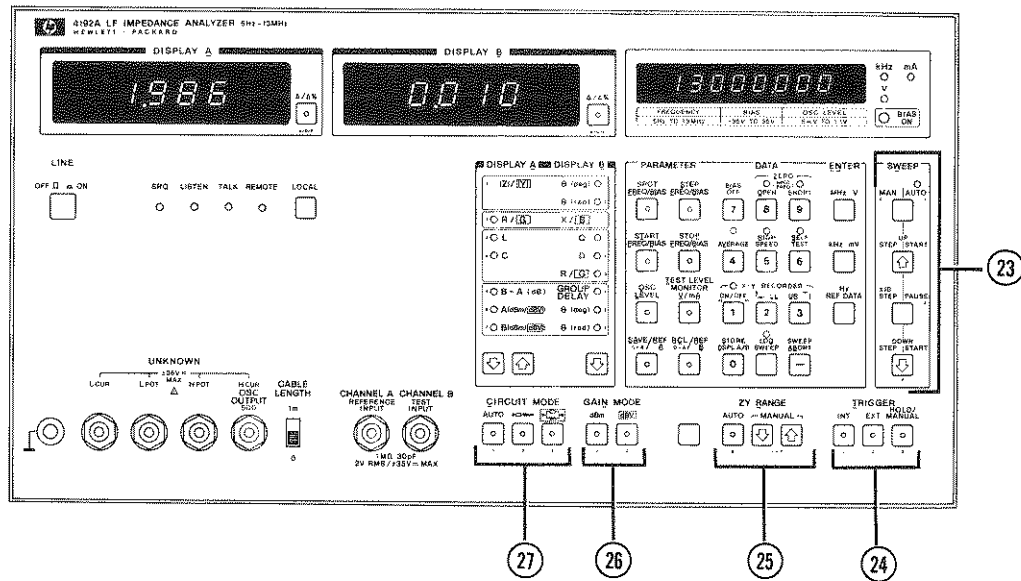

23 SWEEP Control Keys and Indicator:

These keys control the instrument's sweep function. Frequency, bias voltage, and oscillator level can be swept. (Oscillator level can be swept in MAN. mode only.) BIAS ON Indicator (6) must be on for bias voltage sweep; off for frequency sweep. The MAN AUTO key controls the sweep mode. Indicator comes on in AUTO mode. The functions of the other keys are described below for each mode. For log sweep, press the LOG SWEEP key (35).

AUTO

START UP :

Starts the frequency or bias voltage sweep from the value set by the START FREQ./BIAS test parameter key (17). Sweeps up at the increment (step) set by the STEP FREQ./BIAS test parameter key (17).

Also restarts the sweep after a PAUSE.

PAUSE : Temporarily stops the sweep to allow

the sweep step or sweep direction to be changed. Sweep is restarted by pressing the START UP or START DOWN key.

START DOWN :

Starts the frequency or bias voltage sweep from the value set by the STOP FREQ./BIAS test parameter key (17). Sweeps down at the increment (step) set by the STEP FREQ./BIAS test parameter key (17). Also restarts the sweep after a PAUSE.



MAN.

STEP UP : Each time this key is pressed, the frequency or bias voltage is incremented by the value set by the STEP FREQ./BIAS test parameter key (17). If the OSC LEVEL or TEST LEVEL MONITOR key is pressed, oscillator level will be incremented by 1mV (when level is less than 100mV) or 5mV

Figure 3-2. Front Panel Features (Sheet 7 of 10)

(when level is greater than 100mV) each time this key is pressed. Sweep becomes continuous when this key is pressed and held.

X10 STEP :

This key is used with the STEP UP  or STEP DOWN  key. Holding this key down while pressing STEP UP or STEP DOWN increases the sweep step value by a factor of ten.

STEP DOWN :

Each time this key is pressed, the frequency or bias voltage is decremented by the value set by the STEP FREQ./BIAS test parameter key (17). If the OSC LEVEL key or TEST LEVEL MONITOR key is pressed, oscillator level will be decremented by 1mV (when level is less than 100mV) or 5mV (when level is greater than 100mV) each time this key is pressed. Sweep becomes continuous when this key is pressed and held.

(24) TRIGGER:

These keys select the trigger mode for triggering measurement (Internal, External or Hold/Manual):

INT : Internal trigger signal enables instrument to make repeated automatic measurements. Measurement speed varies depending on the type of measurement, oscillator frequency, and whether normal, average, or high speed is selected.

EXT : Measurement is triggered by external trigger signal through rear panel EXT TRIGGER input connector (7) in Figure 3-3).

HOLD/MANUAL :

Measurement is triggered each time this key is pushed. Measurement data is held until the next time the key is pressed.



(25) ZY RANGE Select Keys and Indicator:



In impedance measurements, these keys select the measurement range and ranging method of the absolute value of impedance ($|Z|$: 1 Ω ~ 1 M Ω) or admittance ($|Y|$: 10 μ S ~ 10 M μ S).

AUTO (when indicator is lit) :

Optimum range for the sample value is automatically selected.

MANUAL (when indicator is not lit) :

Measurement range is fixed (even when the sample is changed). Manual ranging is done by pressing adjacent DOWN () or UP () key.

Note: Pressing DOWN () or UP () key sets the ranging mode to Manual even if the ranging mode was set to AUTO.

(26) GAIN MODE Selector Key:





In amplitude/phase measurements, these keys select the appropriate unit for A (absolute amplitude of reference input) and B (absolute amplitude of test input).

dBm : Displays absolute amplitude in dBm ($=20 \log_{10} V + 13.01$).

dBV : Displays absolute amplitude in dBV ($=20 \log_{10} V$).

(27) CIRCUIT MODE Selector Key:

These keys select desired measurement circuit mode to be used for R/G, C, or L measurement.

AUTO : Automatically selects appropriate parallel or series equivalent circuit for the sample value. When ZY RANGE (25) up-ranges from the 1k Ω (10ms) range to 10k Ω (1ms) range, circuit mode changes from  to . When ZY RANGE (25) down-ranges from the 100 Ω (100ms) range to 10 Ω (1s) range, circuit mode changes from  to .

 : Selects equivalent series circuit.

 : Selects equivalent parallel circuit.



Note: In $|Z|/|Y|$ measurements, ranging does not affect the measurement circuit mode. CIRCUIT MODE keys are used to select $|Z|$ or $|Y|$. When the circuit mode is set to AUTO or  , $|Z|$ is selected; when the circuit mode is set to  , $|Y|$ is selected.

Figure 3-2. Front Panel Features (Sheet 8 of 10)



Note: The nine secondary functions, (28) thru (36) of the DATA Input keys (19) are accessible by first pressing the BLUE key (37).

(28) BIAS OFF Key:

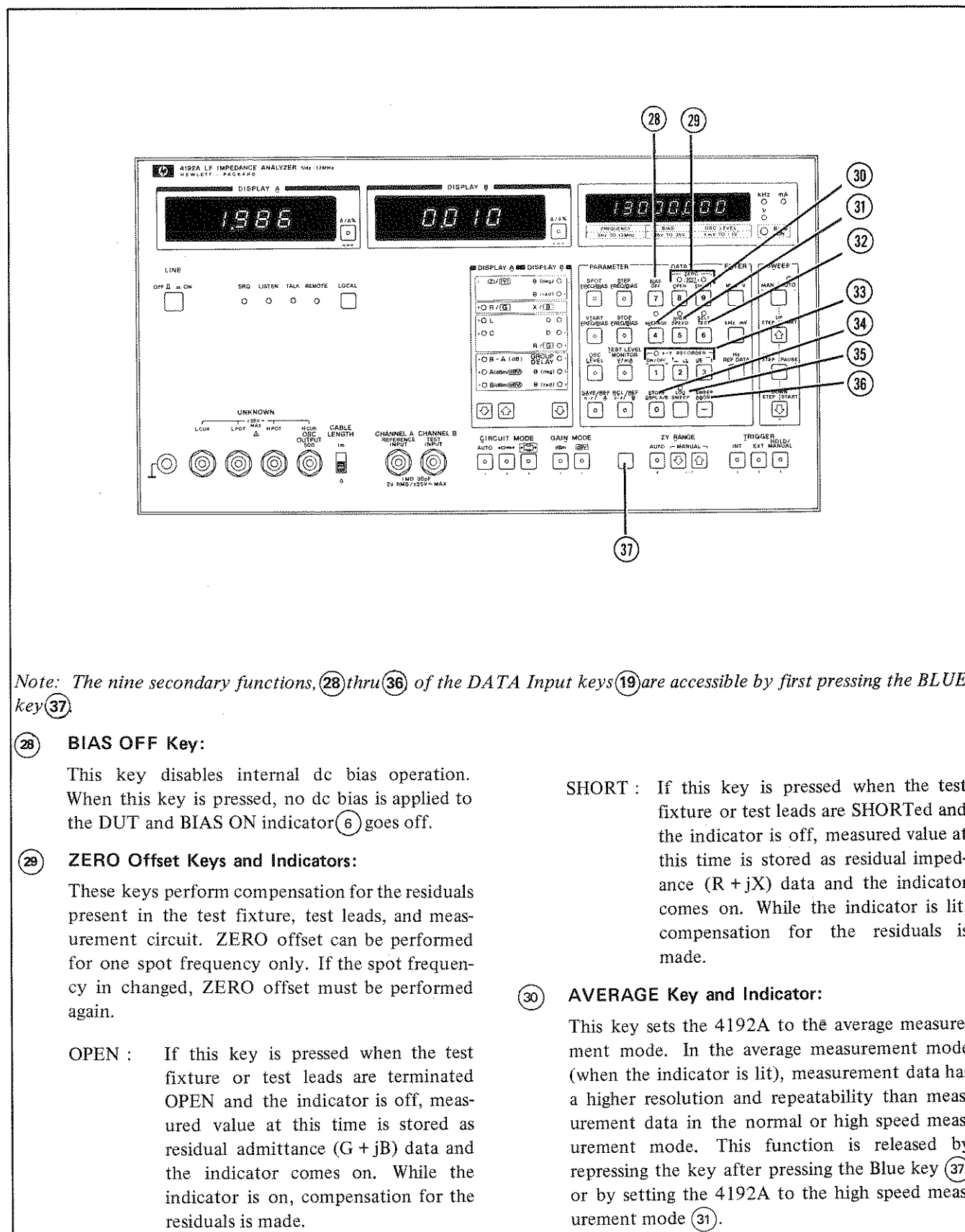
This key disables internal dc bias operation. When this key is pressed, no dc bias is applied to the DUT and BIAS ON indicator (6) goes off.

(29) ZERO Offset Keys and Indicators:

These keys perform compensation for the residuals present in the test fixture, test leads, and measurement circuit. ZERO offset can be performed for one spot frequency only. If the spot frequency in changed, ZERO offset must be performed again.

OPEN : If this key is pressed when the test fixture or test leads are terminated OPEN and the indicator is off, measured value at this time is stored as residual admittance ($G + jB$) data and the indicator comes on. While the indicator is on, compensation for the residuals is made.

SHORT : If this key is pressed when the test fixture or test leads are SHORTed and the indicator is off, measured value at this time is stored as residual impedance ($R + jX$) data and the indicator comes on. While the indicator is lit, compensation for the residuals is made.

(30) AVERAGE Key and Indicator:

This key sets the 4192A to the average measurement mode. In the average measurement mode (when the indicator is lit), measurement data has a higher resolution and repeatability than measurement data in the normal or high speed measurement mode. This function is released by repressing the key after pressing the Blue key (37) or by setting the 4192A to the high speed measurement mode (31).

Figure 3-2. Front Panel Features (Sheet 9 of 10)

| | |
|--|--|
| <p>31 HIGH SPEED Key and Indicator:</p> <p>This key sets the 4192A to the high speed measurement mode. In the high speed measurement mode (when the indicator is lit), measurement time is shorter (approximately ½) than the measurement time in the normal measurement mode. This function is released by repressing the key after pressing the BLUE key (37) or by setting the 4192A to the average measurement mode.</p> | <p>UR \rightarrow↑ : Provides a reference voltage (1V) from each rear-panel RECORDER OUTPUT. Used for full-scale adjustment of the X-Y Recorder. When this key is pushed, the recorder pen will be positioned at the upper-right (X and Y are maximum) of the plot area.</p> |
| <p>32 SELF TEST Key and Indicator:</p> <p>This key initiates the instrument's SELF TEST function. During SELF TEST (when the indicator is on), six tests, which check the basic functional operation of the instrument, are automatically performed. The results (Pass or Fail) are displayed on DISPLAY A (3). When the SELF TEST is completed, this mode is released automatically and normal measurement mode (indicator is off) is set.</p> | <p>34 STORE DSPL A/B Key:</p> <p>This key simultaneously memorizes the measured values displayed on DISPLAY A (3) and DISPLAY B (4) as reference values for deviation measurement.</p> |
| <p>33 X-Y RECORDER Function Keys and Indicator:</p> <p>These keys control the instrument's analog output capability. Voltage proportional to the measurement results is output from the X-Y RECORD OUTPUT connectors (see (11) in Figure 3-3) located on the instrument's rear-panel. Graphs can be plotted with this capability.</p> <p>ON : Analog data representing the measurement results and test parameter value (frequency/bias) are output from the DISPLAY A, DISPLAY B, and FREQ./BIAS RECORDER OUTPUTS on the rear-panel. Indicator lamp is on in this state.</p> <p>OFF : No analog data is output, and X-Y Recorder zero- and full-scale adjustments can be made. Indicator lamp is off in this state.</p> <p>↓← LL : Provides a reference voltage (0V) from each rear-panel RECORDER OUTPUT. Used for zero-scale adjustment of the X-Y Recorder. When this key is pushed, the recorder pen will be positioned at the lower-left (X and Y are zero) of the plot area.</p> | <p>35 LOG SWEEP Key and Indicator:</p> <p>This key sets the log sweep mode. In the log sweep mode (when the indicator is on), the frequency is swept at 20 steps/decade. The steps are automatically selected at logarithmic regular intervals between the decade of the START frequency and the decade of the STOP frequency. STEP. FREQ. has no meaning in log sweep. This function is released by repressing the key (after pressing the BLUE key (37)).</p> <p>36 SWEEP ABORT Key:</p> <p>This key releases sweep frequency (bias voltage) measurement and activates a spot frequency measurement at the frequency (voltage) point where the sweep is aborted.</p> <p>37 BLUE Key:</p> <p>This key is pressed prior to pressing a blue label function key to interchange a normal key function with a blue label function.</p> <p>This key is pressed to access and release the functions and test parameters labeled in blue on the Test PARAMETER keys (17), DATA Input keys (19), and the $\Delta/\Delta\%$ keys (7).</p> |

Figure 3-2. Front Panel Features (Sheet 10 of 10)

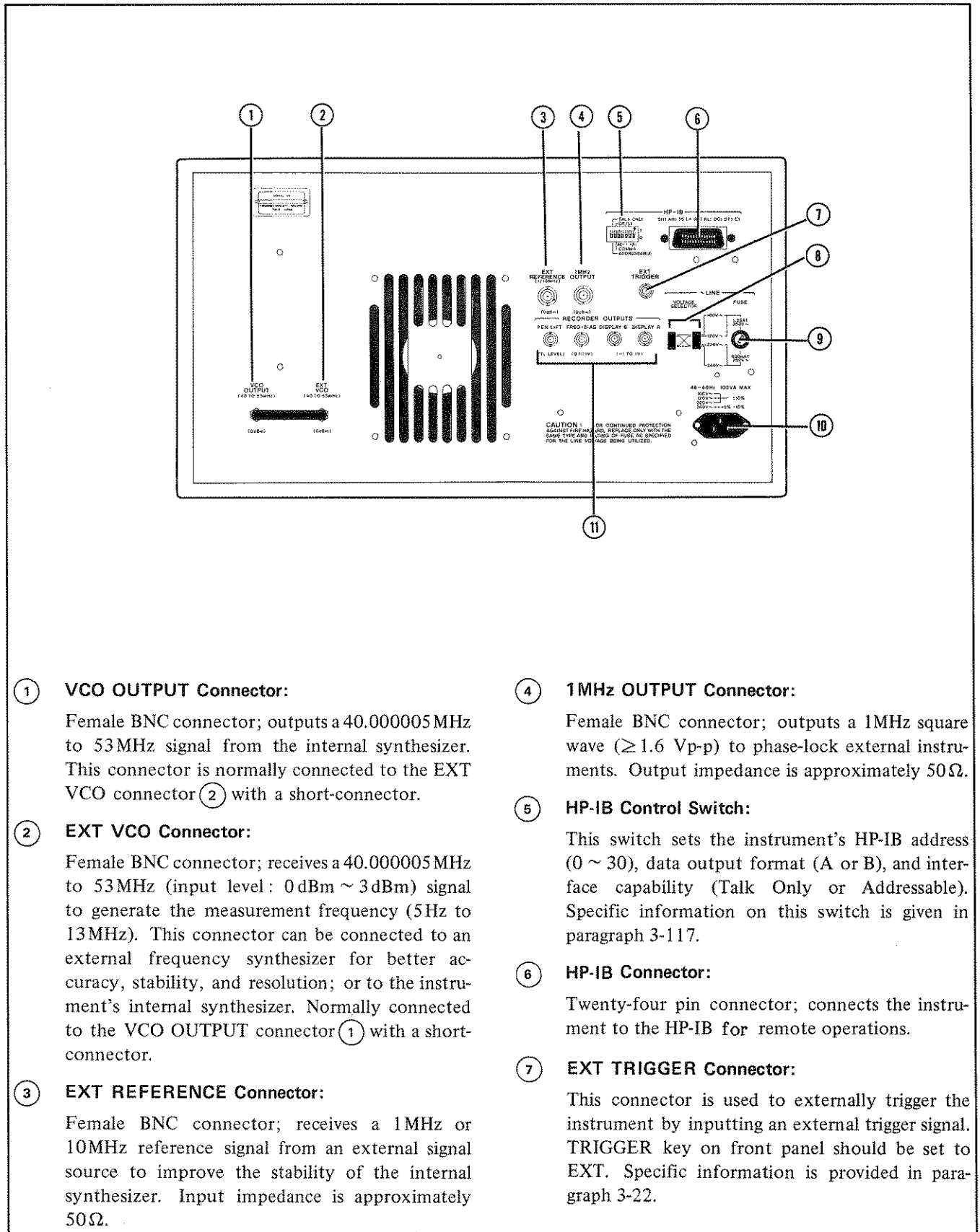

- ① **VCO OUTPUT Connector:**
Female BNC connector; outputs a 40.000005 MHz to 53 MHz signal from the internal synthesizer. This connector is normally connected to the EXT VCO connector ② with a short-connector.
- ② **EXT VCO Connector:**
Female BNC connector; receives a 40.000005 MHz to 53 MHz (input level: 0 dBm ~ 3 dBm) signal to generate the measurement frequency (5 Hz to 13 MHz). This connector can be connected to an external frequency synthesizer for better accuracy, stability, and resolution; or to the instrument's internal synthesizer. Normally connected to the VCO OUTPUT connector ① with a short-connector.
- ③ **EXT REFERENCE Connector:**
Female BNC connector; receives a 1 MHz or 10 MHz reference signal from an external signal source to improve the stability of the internal synthesizer. Input impedance is approximately 50 Ω.
- ④ **1 MHz OUTPUT Connector:**
Female BNC connector; outputs a 1 MHz square wave (≥ 1.6 V_{p-p}) to phase-lock external instruments. Output impedance is approximately 50 Ω.
- ⑤ **HP-IB Control Switch:**
This switch sets the instrument's HP-IB address (0 ~ 30), data output format (A or B), and interface capability (Talk Only or Addressable). Specific information on this switch is given in paragraph 3-117.
- ⑥ **HP-IB Connector:**
Twenty-four pin connector; connects the instrument to the HP-IB for remote operations.
- ⑦ **EXT TRIGGER Connector:**
This connector is used to externally trigger the instrument by inputting an external trigger signal. TRIGGER key on front panel should be set to EXT. Specific information is provided in paragraph 3-22.

Figure 3-3. Rear Panel Features (Sheet 1 of 2)

8 ~ LINE VOLTAGE SELECTOR Switch:

These switches select the appropriate ac operating voltage. Selectable voltages are 100V/120V $\pm 10\%$ and 220V $\pm 10\%$ /240V $\pm 5\%$ -10% (48 ~ 66Hz). Refer to paragraph 2-8.

9 ~ LINE FUSE Holder:

Instrument's power-line fuse is installed in this holder.

100V/120V operation : 1.25AT, 250V
(HP P/N: 2110-0305)

220V/240V operation : 0.6AT, 250V
(HP P/N: 2110-0016)

Refer to paragraph 2-8.

10 ~ LINE Input Receptacle:

AC power cord is connected to this receptacle. Refer to paragraph 2-10.

11 RECORDER OUTPUTS Connectors:

These connectors output dc voltages proportional to the measurement display outputs and test frequency (or internal dc bias voltage), and a pen control signal for the X-Y recorder. Results of swept (frequency of bias) measurements can be plotted by connecting an X-Y recorder to these connectors.

PEN LIFT connector :

Outputs pen up/down control signal. When the 4192A is set as follows, this connector outputs a LOW level TTL signal (pen down).

- (1) X-Y RECORDER key on the front-panel is set to ON.
- (2) START UP key or START DOWN key is pressed when X-Y RECORDER and SWEEP MAN/AUTO keys on the front-panel are set to ON.

At other times, this connector outputs a HIGH level TTL signal (pen up).

FREQ/BIAS connector :

Outputs voltage proportional to the test frequency or internal dc bias voltage (from 0V at START frequency/voltage to 1V at STOP frequency/voltage). The output voltage is proportional to the logarithm of the frequency when LOG SWEEP is set to ON.

DISPLAY B connector :

Outputs voltage proportional to the value displayed on DISPLAY B. Normalized value is 1V (max.).

DISPLAY A connector :

Outputs voltage proportional to the value displayed on DISPLAY A. Normalized value is 1V (max.).

Refer to paragraph 3-121 for specifics.

Figure 3-3. Rear Panel Features (Sheet 2 of 2)

3-7. SELF TEST

3-8. The 4192A is equipped with an automatic self-diagnostic function that can be initiated at any time to confirm normal operation of the instrument's basic functions. The SELF TEST can be initiated from the front-panel by pressing the BLUE key and the SELF TEST key, or via HP-IB remote control (program code S1). When the SELF TEST is initiated (indicator lamp is on), the six tests listed in Table 3-1 are automatically performed and the results (pass code or one of the error codes listed in the table) are displayed on DISPLAY A. If no errors are detected, PASS is displayed on DISPLAY A and the instrument is returned to normal measurement mode (SELF TEST indicator is off). If an error is detected, the corresponding error code is displayed on DISPLAY A and the SELF TEST stops. If the instrument fails the SELF TEST, contact the nearest Hewlett-Packard Service Office (see list at back of this manual).

Note: An abbreviated SELF TEST, which includes test 1 (one second only), 2, 3, and 6 (at 100 kHz only) of the standard SELF TEST, is performed each time the instrument is turned on. During this abbreviated SELF TEST, only error codes are displayed.

3-9. Initial Control Settings

3-10. To facilitate operation, the instrument is automatically set to the following initial control settings each time it is turned on:

Panel Controls :

- DISPLAY A |Z|
- DISPLAY B θ (deg)
- Test Parameter Data Display .. SPOT FREQ
- BIAS OFF
- ZERO OPEN OFF
- ZERO SHORT OFF
- AVERAGE OFF
- HIGH SPEED OFF
- SELF TEST OFF
- X-Y RECORDER OFF
- LOG SWEEP OFF
- SWEEP OFF
- CIRCUIT MODE AUTO ()
- GAIN MODE dBm
- ZY RANGE AUTO
- TRIGGER INT
- $\Delta/\Delta\%$ OFF

Table 3-1. 4192A SELF TEST

| Test Number | Description | Display | |
|-------------|--|---------|------------------|
| | | Pass | Fail |
| 1 | All numerical displays and indicator lamps on the front-panel come on and remain on as long as the SELF TEST key is being pressed. Check that all displays and indicator lamps are on. | P-01 * | |
| 2 | Checks four RAM's (Random Access Memory). | P-02 | E-20, E-21 |
| 3 | Checks fourteen ROM's (Read Only Memory). | P-03 | E-30 ~ E-43 |
| 4 | Checks that the interrupt signal is present and that it is of the correct frequency. | P-04 | E-50, E-51 |
| 5 | Checks the integrator in the VRD (Vector Raito Detector) circuit. | P-05 | E-61, E-62 |
| 6 | Checks that the frequency setting of the internal synthesizer is normally done at each decade. | P-06 | E-70, E-71, E-72 |

*P-01 indicates that test 1 has been completed. It does not mean that the instrument has passed test 1. The operator must determine whether the instrument has passed or failed this test.

Test Parameters :

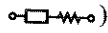
| | |
|------------------|--------|
| SPOT FREQ | 100kHz |
| STEP FREQ | 1kHz |
| STOP FREQ | 13MHz |
| START FREQ | 5 Hz |
| OSC LEVEL | 1Vrms |
| SPOT BIAS | 0V |
| STEP BIAS | 1V |
| START BIAS | -35 V |
| STOP BIAS | +35V |
| REF A | 0 |
| REF B | 0 |

3-11. Displays

3-12. The 4192A has three display sections: DISPLAY A, DISPLAY B, and a Test Parameter Data Display (hereinafter called DISPLAY C). DISPLAY A and DISPLAY B are the primary displays; they are described in paragraphs 3-13 and 3-14, respectively. DISPLAY C is described in paragraph 3-15. The BIAS ON Indicator is described in paragraph 3-16.

3-13. DISPLAY A provides direct readout of the primary measurement parameter in amplitude/phase measurements and impedance measurements.

In impedance measurements, DISPLAY A displays the absolute value of the vector impedance, $|Z|$; the absolute value of the vector admittance, $|Y|$; resistance, R; conductance, G; inductance, L; or capacitance, C. In amplitude/phase measurements, DISPLAY A displays the measured value of B-A (dB), the gain or loss between CHANNEL A and CHANNEL B; A (dBm/dBV), the amplitude of the signal input to CHANNEL A; or B (dBm/dBV), the amplitude of the signal input to CHANNEL B.

All values are displayed with a maximum of 4½ digits. The actual number of display digits depends on the setting of other control functions such as OSC LEVEL, ZY RANGE, etc. Maximum display is 19999 for inductance and capacitance measurements; 12999, for all other parameters. Decimal point and the appropriate unit annunciator (e.g., pF, mH, μ S, M Ω) are also displayed. If the selected measurement cannot be made, because the value of the DUT is outside the instrument's measurement range or because the front-panel controls are incorrectly set, one of the following will be displayed.

| | |
|-----|------|
| OF1 | --- |
| OF2 | E-06 |
| UCL | E-07 |

Refer to Tables 3-2 and 3-3 for the meaning of each of

these annunciations. When a SHORT or OPEN ZERO offset adjustment is being made, CAL is displayed. DISPLAY A also displays the pass- and error-codes (P-01 through P-06 and E-20 through E-73) related to the instrument's SELF TEST function. Refer to Table 3-4 for the meanings of SELF TEST error-codes E-20 through E-73.

3-14. DISPLAY B provides direct readout of the secondary measurement parameter in amplitude-phase measurements and impedance measurements. This display is blank when DISPLAY A function is set to A (dBm/dBV) or B (dBm/dBV).

In impedance measurements, DISPLAY B displays the value of the impedance/admittance; phase angle, θ (degrees or radians); reactance, X; susceptance, B; quality factor, Q; dissipation factor, D; resistance, R; or conductance, G.

In amplitude/phase measurements, DISPLAY B displays either group delay or phase difference, θ (degrees or radians).

Refer to paragraph 3-13 for specifics on number of digits, maximum display, unit annunciators, etc.

If the selected measurement cannot be made, OF2 or --- is displayed. Refer to Table 3-3 for the meaning of these annunciations.

3-15. DISPLAY C displays all test parameter data — SPOT FREQ/BIAS, STEP FREQ/BIAS, START FREQ/BIAS, STOP FREQ/BIAS, OSC LEVEL, TEST LEVEL, and REF A or REF B value. Frequency is displayed with a maximum of 7½ digits; BIAS, OSC LEVEL, and TEST LEVEL are displayed with a maximum of 4 digits; and REF A and REF B values are displayed with a maximum of 4½ digits. Error-codes displayed on DISPLAY C are discussed in paragraph 3-17.

3-16. The BIAS ON Indicator comes on to warn the operator that the instrument is applying a dc bias voltage across the DUT.

3-17. Error-codes and annunciations related to operator error and out-of-range measurement are listed and described in Tables 3-2 and 3-3, respectively. Error-codes for errors detected during SELF TEST are listed and described in Table 3-4. If the instrument fails the SELF TEST, i.e., if one of the error-codes listed in Table 3-4 is displayed on DISPLAY A, contact the nearest Hewlett-Packard Sales/Service Office.

Table 3-2. Operational Error-codes

| Error-code | Meaning |
|------------|---|
| E-01 | An attempt was made to input a test parameter value or reference value that is out-of-range. |
| E-02 | AUTO SWEEP was attempted when the selected test parameter was REF A, REF B, OSC LEVEL, or TEST LEVEL MONITOR; or MAN SWEEP was attempted when the selected test parameter was REF A or REF B. |
| E-03 | AUTO or MAN SWEEP was attempted when the STOP FREQ. (or BIAS) is lower than the START FREQ. (or BIAS). |
| E-04 | MAN SWEEP was attempted when the SPOT FREQ. (or BIAS) is lower than the START FREQ. (or BIAS) or higher than the STOP FREQ. (or BIAS). |
| E-05 | The STORE DSPL A/B key was pressed when DISPLAY A and/or DISPLAY B is set to $\Delta/\Delta\%$ measurement or is displaying OF1, OF2, UCL, or ---. |
| E06 | REF A, REF B, Δ , or $\Delta\%$ key was pressed when no reference data for the deviation measurement is stored. |
| E07 | ZERO OPEN or ZERO SHORT operation could not be properly performed. |
| E-08 | SAVE 5~9 or RCL (Recall) 5~9 was attempted (only memory locations 0~4 are available). |
| E-09 | RCL (Recall) was attempted on an empty memory. |
| E-10 | In swept frequency measurements of Group Delay, STEP FREQ. is too low for the START FREQ./STOP FREQ. sweep range. |

Table 3-3. Annunciations (Sheet 1 of 2)

| DISPLAY | | Meanings | |
|-------------------|-------------------|--|---|
| A | B | DISPLAY A | DISPLAY B |
| OF1 | --- | Measured value of Z or Y exceeds 130% of full scale of the ZY RANGE. | Measurement cannot be performed. |
| OF2 | Significant value | Measured value exceeds 200% of full scale of display range. | Measurement is performed correctly. |
| Significant value | OF2 | Measurement is performed correctly. | Measured value exceeds 200% of full scale of display range. |
| OF2 | OF2 | Measured value exceeds 200% of full scale of display range. | Measured value exceeds 200% of full scale of display range. |
| UCL *1 | --- | The instrument's internal measurement circuit is saturated. | Measurement cannot be performed. |

Table 3-3. Annunciations (Sheet 2 of 2)

| DISPLAY | | Meanings | |
|---|-------|--|--|
| A | B | DISPLAY A | DISPLAY B |
| Significant value | --- | Measurement is performed correctly. | Measurement cannot be performed because: ① When function is set to θ , Q, or D, the measured value of Z or Y is less than 5% of full scale of the ZY RANGE. ② When GROUP DELAY measurement is being performed, the test frequency to be automatically selected next is outside the selectable test frequency range (5 Hz and 13 MHz). |
| --- | --- | Auto ranging of ZY RANGE is being performed. | |
| Significant value | Blank | Measurement is performed correctly. | DISPLAY B function is blank when DISPLAY A function is set to A (dBm/dBV) or B (dBm/dBV). |
| CAL | Blank | ZERO offset adjustment is being performed. | |
| *1. When the measuring frequency is set to 10MHz or above and ZY RANGE is held, measured values output 500ms after DISPLAY A indicates "UCL" are invalid. *2. Specific information on GROUP DELAY measurement is provided in paragraph 3-63. | | | |

Table 3-4. SELF TEST Error-codes

| Display | Meaning |
|------------------|--|
| E-20, E-21 | One of the four RAM's (Random Access Memory) is not functioning properly. |
| E-30 ~ E-43 | One of the fourteen ROM's (Read Only Memory) is not functioning properly. |
| E-50, E-51 | The line frequency detection circuit is not functioning properly. |
| E-61, E-62 | Integrator in the VRD (Vector Ratio Detector) is not functioning properly. |
| E-70, E-71, E-72 | Internal synthesizer is not functioning properly. |

3-18. Test Signal

3-19. The internal frequency synthesizer provides a sinusoidal wave test signal that has an accuracy of 55 ppm. The frequency range is from 5 Hz to 13 MHz, and signal level is 5mVrms to 1.1Vrms. The test signal is output from the OSC OUTPUT connector (H_{CUR} of the UNKNOWN terminals) on the front-panel. Test frequency and test level range, resolution, and accuracy are given in Table 3-5.

Note: Test signal accuracy, stability, and resolution can be improved by connecting an external frequency synthesizer to the EXT VCO connector on the rear-panel. Specific information on measurements using an external synthesizer is given in paragraph 3-137.

Note: In impedance measurements, the level of the test signal across the DUT depends on the impedance of the DUT. To monitor the actual level of test signal across the DUT, press the TEST LEVEL MONITOR key. (Refer to paragraph 3-91 for specifics.)

3-20. Measurement Modes

3-21. The 4192A has three selectable measurement modes: NORMAL, HIGH SPEED, and AVERAGE.

- (1) **NORMAL Measurement Mode:**
 This mode is automatically set each time the instrument is turned on. In this mode, the integration time of the instrument's A/D converter is equal to the period of the line frequency. Line frequency ripple on the dc voltage used for integration is rejected (filtered).
- (2) **HIGH SPEED Measurement Mode:**
 This mode is set by pressing the HIGH SPEED key. Measurement speed in this mode is approximately twice that of the NORMAL mode; however, resolution is reduced and accuracy is not specified. Integration time is 2.5ms. Line frequency ripple is not rejected (filtered).
- (3) **AVERAGE Measurement Mode:**
 This mode is set by pressing the AVERAGE key. Resolution, accuracy, and repeatability in this mode are much better than in NORMAL mode or HIGH SPEED mode. The displayed measurement value is the average of seven measurements. Integration time is 10 times the period of the line frequency. Line frequency ripple is rejected (filtered).

Note: Measurement times for each mode at each DISPLAY A/B function setting are given in paragraph 3-55 for amplitude/phase measurements and in paragraph 3-89 for impedance measurements.

Table 3-5. Frequency and Output Level of Test Signal

| | Setting Range | Resolution | Setting Accuracy* ¹ |
|--------------------------------|----------------------|------------|--|
| Measurement Frequency | 5 Hz ~ 10 kHz | 1 mHz | Setting Value ±50ppm. |
| | 10 Hz ~ 100 kHz | 10 mHz | |
| | 100 kHz ~ 1 MHz | 100 mHz | |
| | 1 MHz ~ 13 MHz | 1 Hz | |
| OSC Output Level* ² | 5 mVrms ~ 100 mVrms | 1 mVrms | 5 Hz ~ 1 MHz: (5 + 10/f)% + 2mV 1 MHz ~ 13 MHz: (4 + 1.5f)% + 2mV |
| | 100 mVrms ~ 1.1 Vrms | 5 mVrms | 5 Hz ~ 1 MHz: (5 + 10/f)% + 10mV 1 MHz ~ 13 MHz: (4 + 1.5F)% + 10mV |

*¹ : At 23°C ± 5°C.

*² : UNKNOWN terminals open (impedance measurements) or terminated with 50Ω (amplitude/phase measurement), f: measurement frequency (Hz), F: measurement frequency (MHz).

3-22. Trigger Modes

3-23. The 4192A has three selectable trigger modes: INTERNAL, EXTERNAL, and HOLD/MANUAL.

(1) INTERNAL Trigger Mode:

In this mode, measurement is automatically and repeatedly triggered. Trigger speed depends on the type of measurement, test frequency, and measurement mode.

(2) EXTERNAL Trigger Mode:

Measurement is triggered by applying a TTL level pulse to the EXT TRIGGER connector on the rear-panel. Refer to Figure 3-4 for specifics.

(3) HOLD/MANUAL Trigger Mode:

Measurement is triggered each time the HOLD/MANUAL key is pressed. Measurement data is held until the next time the key is pressed.

Note: Measurement can also be triggered via the HP-IB. Refer to Figure 3-38.

Note: Triggering in EXT and HOLD/MANUAL modes must be slow enough to allow the instrument to complete each measurement. If a trigger signal is received before measurement is completed, it is ignored.

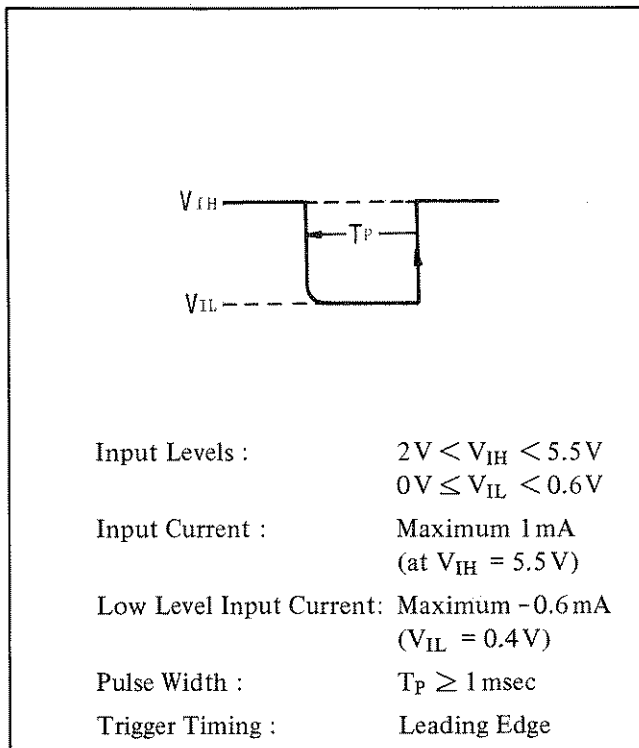

Figure 3-4. External Trigger Pulse

3-24. Setting Test Parameters

3-25. The 4192A provides eleven test parameters. They are listed, along with range and resolution, in Table 3-6. Use the following procedure to set the value of these parameters:

- (1) Press the desired PARAMETER key.
- (2) Set the desired value with the DATA keys. The set value will be displayed on DISPLAY C.
- (3) Press the appropriate ENTER key to enter this value.

Note: Parameter values can also be set via the HP-IB. Refer to paragraph 3-123 for specifics.

Note: If the parameter value is out-of-range (see Table 3-6), E-01 will be displayed on DISPLAY C for approximately one second and the previous value is retained.

3-26. Deviation Measurement

3-27. When many components of similar value are to be tested, it may be more practical to measure the difference between the value of the component and a predetermined, or ideal, reference value than measuring the DUT value itself. When the purpose of the measurement is to observe the change of a component's value versus changes in temperature, frequency, bias, etc., a direct measurement of this change (deviation) makes examination more meaningful and easier.

3-28. Deviation measurements can be made for either or both DISPLAY A and/or DISPLAY B parameter measurements. There are two methods of inputting reference values for deviation measurements: 1) input the reference value using the DATA keys, or 2) input the measured value of the reference component by pressing the STORE DSPL A/B key. Deviation is displayed as either the deviation (Δ) from the reference value or the percent deviation ($\Delta\%$).

(1) Deviation Measurement Δ (Delta):

The difference between the measured value of the DUT and a previously stored reference value (REF A or REF B) is displayed. The formula used to calculate the deviation is

$$A - B$$

where A is the measured value of the DUT and B is the stored reference value.

Table 3-6. Test Parameters

| Parameter | Description | Range |
|------------|--|---|
| SPOT FREQ | The spot frequency | Range : 5 Hz ~ 13 MHz Resolution : 1 mHz at 5 Hz ~ 10 kHz; 10 mHz at 10 kHz ~ 100 kHz; 100 mHz at 100 kHz ~ 1 MHz; 1 Hz at 1 MHz ~ 13 MHz |
| START FREQ | The start frequency for swept frequency measurements | |
| STOP FREQ | The stop frequency for swept frequency measurements | |
| STEP FREQ | The step frequency for swept frequency measurements | Range: 1 mHz ~ 13 MHz Resolution: 1 mHz at 1 mHz ~ 10 kHz; 10 mHz at 10 kHz ~ 100 kHz; 100 mHz at 100 kHz ~ 1 MHz; 1 Hz at 1 MHz ~ 13 MHz |
| SPOT BIAS | The spot bias voltage. | Range: -35 V ~ +35 V. Resolution: 10 mV. |
| START BIAS | The start voltage for swept voltage measurements | |
| STOP BIAS | The stop voltage for swept voltage measurements | |
| STEP BIAS | The step voltage for swept voltage measurements | Range: 10 mV ~ 35 V. Resolution: 10 mV. |
| OSC LEVEL | The level (rms) of the signal output by the internal synthesizer | Range: 5 mV ~ 1.1 V. Resolution: 1 mV at 5 mV ~ 100 mV; 5 mV at 100 mV ~ 1.1 V |
| REF A | The reference value for DISPLAY A deviation measurements | Range and resolution are the same as those of the DISPLAY A/B parameter. |
| REF B | The reference value for DISPLAY B deviation measurements | |

- (2) Percent Deviation Measurement $\Delta\%$ (Delta Percent):

The difference between the measured value of the DUT and a previously stored reference value (REF A or REF B) is displayed as a percentage of the reference value. The formula used to calculate the percent deviation is

$$\frac{A - B}{B} \times 100 (\%)$$

where A is the measured value of the DUT and B is the stored reference value.

- 3-29. Use the following procedure to perform deviation measurements:

- (1) Set the front-panel controls for normal amplitude-phase or impedance measurement. (Basic procedure for amplitude-phase measurement is given in Figure 3-10, and in Figure 3-30 for impedance measurements.)
- (2) Press the BLUE key and the REF A or REF B key. At this time, the previously stored reference value or E-06 will be displayed on DISPLAY C. E-06 simply means there is no reference data for

the selected display function; ignore it and proceed to step 3.

- (3) Enter the desired reference value using the numeric DATA keys. (E-06 annunciation will disappear.) This value will be displayed on DISPLAY C.
- (4) Press the ENTER key labeled REF DATA. This stores the value displayed on DISPLAY C as the reference value.

Note: To store the measured (displayed) value of a reference sample (DUT) as reference data, use the following procedure:

- (a) *Connect the sample to the instrument and make one measurement.*
 - (b) *Press the BLUE key and the STORE DSPL A/B key. The values displayed on DISPLAY A and DISPLAY B will be stored as REF A and REF B data, respectively.*
- (5) Press the $\Delta/\Delta\%$ key on DISPLAY A and/or DISPLAY B. The value displayed on the display (A or B) is the difference (deviation) between the stored reference value and the measured value. For percent deviation measurement, press the BLUE key before pressing the $\Delta/\Delta\%$ key.

Note: Reference data stored for one measurement function cannot be used for another measurement function; that is, reference data stored for an impedance measurement cannot be used for a resistance measurement.

3-30. Continuous Memorization of Control Settings (SAVE and RCL Functions)

3-31. The 4192A is equipped with five non-volatile

storage registers. These registers are used to store five different, frequently used front-panel control settings. Stored control settings are preserved (not erased) in the registers even when the instrument is turned off.

Frequently used control settings can be saved and then recalled instead of having to reenter the measurement conditions each time. This feature improves efficiency in applications where repetitive measurements are made.

Almost all front-panel control settings and test parameter settings, including reference data and zero calibration data, can be saved. Exceptions are listed below.

HP-IB status
DISPLAY A/B measurement data
LINE OFF/ON
CABLE LENGTH
BIAS ON
SPOT BIAS

3-32. Use the following procedure to save and recall a measurement condition:

- (1) Set the front-panel controls and test parameters as desired.
- (2) Press the SAVE key and the register number (0-4). All front-panel control settings and test parameter settings are now saved, or memorized, in the specified register.
- (3) To restore the instrument to the control settings and test parameters saved in step (2), press the RCL key and the register number.

3-33. The instrument is equipped with two rechargeable batteries that provide power for the storage registers when the instrument is turned off. They are automatically recharged while the instrument is turned on. Specifications are given below.

Operating time: 7500 hours (typical) after full charge.
Recharge time: Time required to fully recharge the batteries is 200 hours.
Lifetime: 5 years (at 25°C).

3-34. AMPLITUDE/PHASE MEASUREMENT

3-35. The Model 4192A LF Impedance Analyzer can accurately measure the gain/loss, phase, group delay and level of many types of circuits. It displays all measured parameters with 4½ digit numeric displays. The built-in frequency synthesizer can be set to any test frequency between 5.000Hz and 13.000000MHz, and can be swept within that frequency range with 1mHz (maximum) resolution. Instructions for amplitude/phase measurements are given in paragraph 3-34 to 3-66.

3-36. Measurement Functions

3-37. Most amplitude-gain measurements are based on relative measurements where the signals at the input and output ports of a network are compared to determine how the network behaves as a signal processor. The 4192A simultaneously measures two independent, complementary parameters in each measurement cycle. These measurement functions are classified, for display purpose, into two groups: DISPLAY A and DISPLAY B functions, as given in Table 3-7. Measurement results can be displayed as deviation or percent deviation from stored reference values. Deviation measurements are described in paragraph 3-26.

3-38. Measurement Ranges

3-39. The 4192A can measure transmission parameters, gain/loss (B-A), level (A/B), phase (θ) and group delay, over the measurement ranges listed in Table 3-8. Measurement resolution, also listed in the table, are for NORMAL and AVERAGE measurement modes. Resolution in HIGH SPEED measurement mode is one digit lower than these values.

Table 3-8. Measurement Range for Amplitude-Phase Measurements

| Measurement Function | Measurement Range | Resolution |
|----------------------|-----------------------|------------|
| B-A | 0dB ~ ± 20dB | 0.001dB |
| | ± (20dB ~ 100dB) | 0.01dB |
| A/B (dBm) | + 13.8dBm ~ - 20dBm | 0.001dBm |
| | - 20dBm ~ - 87dBm | 0.01dBm |
| A/B (dBV) | + 0.8dBV ~ - 20dBV | 0.001dBV |
| | - 20dBV ~ - 100dBV | 0.01dBV |
| GROUP DELAY*1 | 0.0001 μs ~ 1.9999 μs | 100ps |
| | 0.001 μs ~ 19.999 μs | 1ns |
| | 0.01 μs ~ 199.99 μs | 10ns |
| | 0.0001 ms ~ 1.9999 ms | 100ns |
| | 0.001 ms ~ 19.999 ms | 1 μs |
| | 0.01 ms ~ 199.99 ms | 10 μs |
| | 0.0001 s ~ 1.9999 s | 100 μs |
| 0.001 s ~ 19.999 s | 1ms | |
| θ (deg) | 0° ~ ± 180° | 0.01° |
| θ (rad) | - π ~ - 1.000 | 0.001 |
| | - 1.0000 ~ + 1.0000 | 0.0001 |
| | + 1.000 ~ + π | 0.001 |

*1: Measurement range at GROUP DELAY is determined automatically by ΔF (STEP FREQ \times 2) and $\Delta\theta$. Specific information on GROUP DELAY measurements is provided in paragraphs 3-63 to 3-66.

Table 3-7. DISPLAY A/B Functions for Amplitude/Phase Measurements

| DISPLAY A Function | | DISPLAY B Function | |
|--------------------|--|--------------------|-----------------------------|
| B - A (dB) | Relative Amplitude of the Reference Input and the Test Input | GROUP DELAY | Group Delay in seconds |
| | | θ (deg) | Phase Difference in degrees |
| | | θ (rad) | Phase Difference in radians |
| A (dBm/dBV) | Absolute Amplitude of the Reference Input | | |
| B (dBm/dBV) | Absolute Amplitude of the Test Input | | |

3-40. OSC OUTPUT

3-41. In amplitude/phase measurements, the output signal from the OSC OUTPUT terminal is applied to a power splitter (HP Part No.: 04192-61001, furnished with the 4192A) to produce two output signals that are in phase and of equal amplitude. One of these signals is applied to CHANNEL A and is used as the reference input; the other signal is applied to input port of the network under test. The output port of the network is then connected to CHANNEL B. Figure 3-5 shows the equivalent circuit for the OSC OUTPUT. The circuit consists of a low (zero) impedance source in series with a 50Ω resistor which determines the output impedance. The output signal level is variable from 5mV to 1.1Vrms when terminated with 50Ω . Specific information on the internal synthesizer is provided in paragraph 3-18.

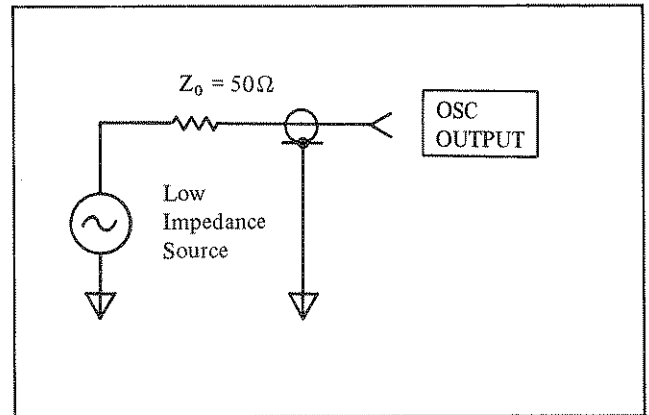

Figure 3-5. Equivalent Output Circuit

3-42. CHANNEL A/B

3-43. For basic amplitude/phase measurements, the reference input is obtained by connecting one of the output signals from the power splitter connected to the OSC OUTPUT. The test input is obtained by inserting the network to be tested between the power splitter and CHANNEL B. Since the signals divided by the power splitter are identical, the signal applied to CHANNEL A represents the input to the network while the signal applied to CHANNEL B is the output of the network. By comparing these two signals, the 4192A measures the gain or loss, phase shift and group delay introduced by the network. When the frequency is swept over the band of interest with amplitude, phase and group delay, measurement data represent the amplitude and phase response of the transfer function in the frequency domain.

3-44. For production testing, it is often necessary to compare a newly manufactured network to a production standard. The 4192A, being a dual channel instrument, lends itself well to this application. When comparing two networks, the standard network is connected between the power splitter and CHANNEL A to obtain the reference. The network to be tested is then connected between the power splitter and CHANNEL B. In this case, the 4192A compares the output signals of the two networks and any differences between the networks are reflected as deviation from 0dB (B-A amplitude), 0 degrees (phase) or 0s (group delay).

3-45. Figure 3-6 shows the equivalent circuit for the CHANNEL A/B. The resistor, R_{in} , represents the $1M\Omega$ input resistance; the capacitor, C_s , represents the $25pF \pm 5pF$ shunt capacitance. This high input impedance has a minimum loading effect on the input signal and allows the 4192A to be used for characterizing networks having output impedances other than 50Ω . Figure 3-7 shows the input impedance, Z_t , as a function of frequency. At low frequencies, the reactance of C_s is very high, making Z_t nearly equal to R_{in} . As frequency increases, the decreasing reactance of C_s becomes more and more significant, causing Z_t to decrease. At high frequencies, R_{in} is no longer significant and Z_t is slightly less than the reactance of C_s (approximately 500Ω at 13MHz).

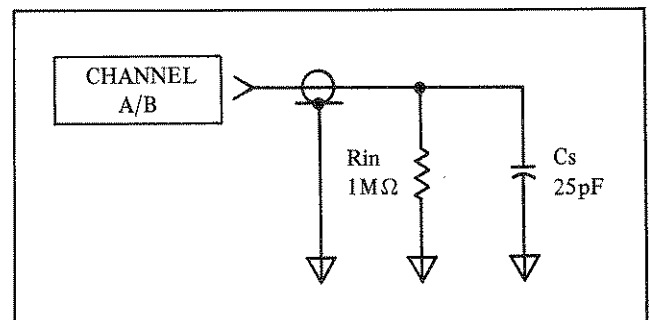

Figure 3-6. Equivalent Input-Circuit

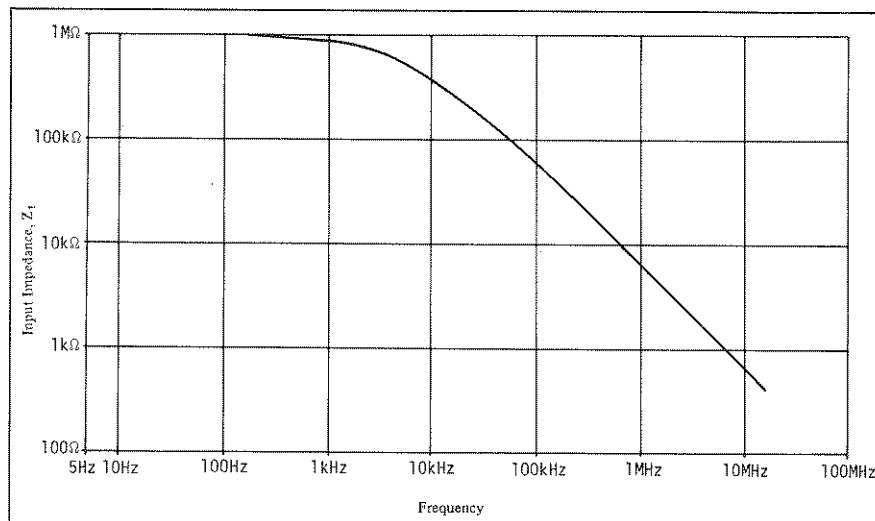

Figure 3-7. Z_i vs Frequency

3-46. Input Configurations

3-47. Figure 3-8 illustrates and describes the basic input configurations for various types of measurements. Connections of these input configurations should be made using double-shielded cables with BNC connectors as listed in Table 3-9. When making input connections, observe the following guidelines:

- (1) Keep input cables as short as possible.
- (2) Make the total cable length in each channel equal. This is particularly important when measuring phase (or group delay) at high frequencies.
- (3) When impedance terminations are required, use shielded terminations equipped with suitable RF connectors as listed in Table 3-10. Place terminations at the end of the transmission line.

Note: When making a relative gain/loss (B-A) measurement with either the 4192A or a Network Analyzer using the input configurations shown in Figure 3-8, the measurement results are the same but those of an absolute amplitude (A/B) measurement may differ. This is because the 4192A uses a passive (2-resistor) power splitter and the Network Analyzer uses an active power splitter.

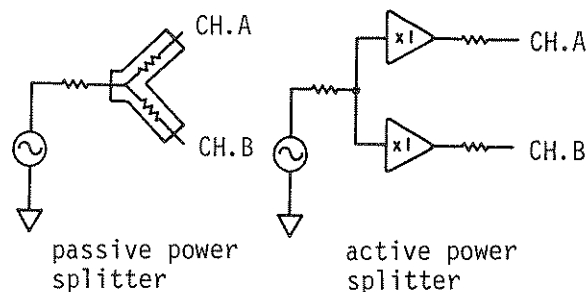

Table 3-9. BNC Cables

| Model No. | Cable |
|-----------|--|
| 11170A | 30 cm BNC (male) – BNC (male) Double – Shield Cable (two 11170A's are furnished with the 4192A) |
| 11170B | 60 cm BNC (male) – BNC (male) Double – Shield Cable (two 11170B's are furnished with the 16097A Accessory Kit) |
| 11170C | 120 cm BNC (male) – BNC (male) Double – Shield Cable (two 11170C's are furnished with the 4192A) |

Table 3-10. Impedance Terminations

| Model No. | Termination |
|-----------|---|
| 11048C | 50Ω Feedthrough (two 11048C's are furnished with the 4192A) |
| 11094B | 75Ω Feedthrough (two 11094B's are furnished with the 11097A) |
| 11095A | 600Ω Feedthrough (two 16097A's are furnished with the 16-97A) |

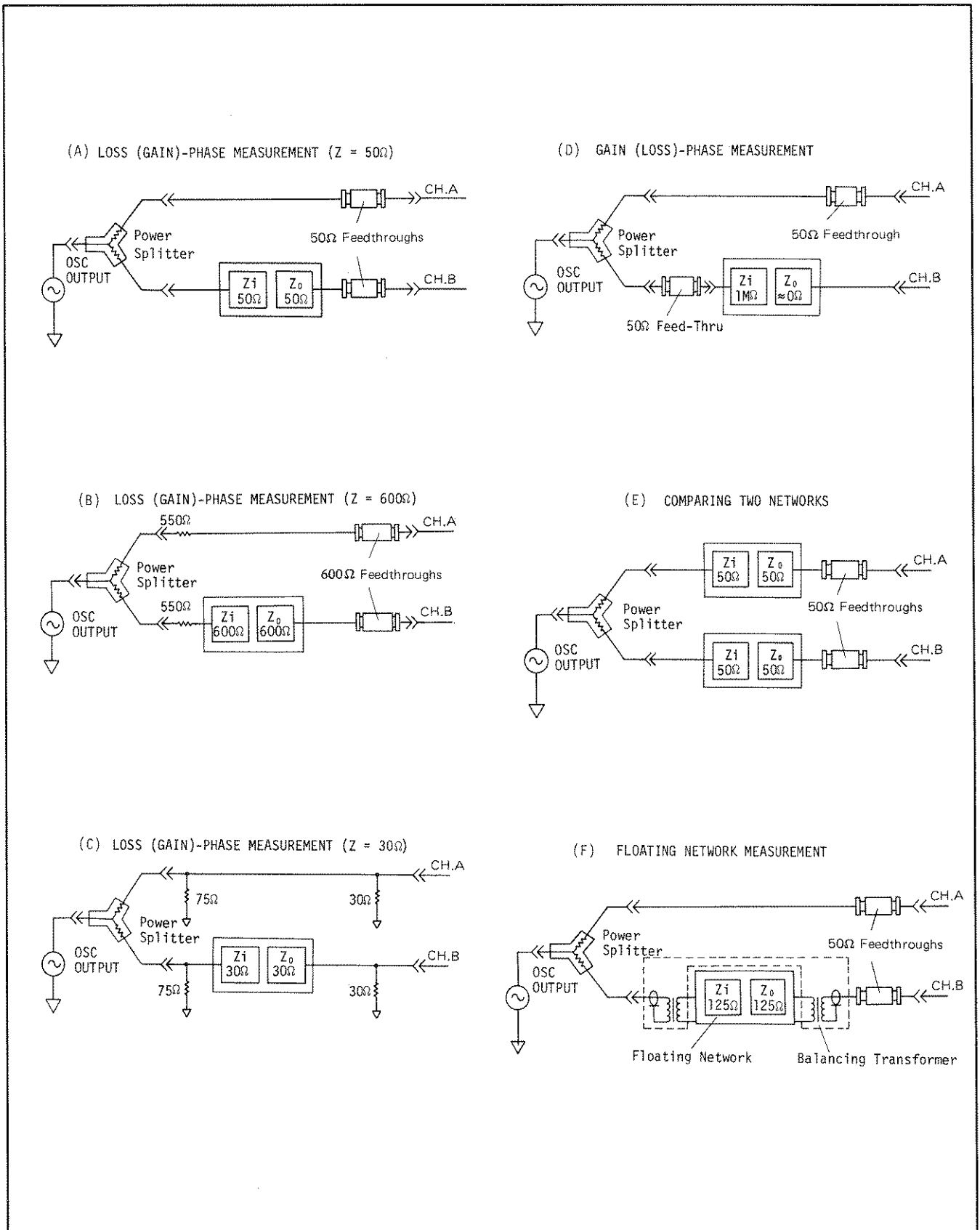

Figure 3-8. Input Configurations

3-48. Impedance Matching

3-49. In most measurement applications the network under test must be driven and terminated in its characteristic impedance. If the characteristic impedance of the network matches the 50Ω output impedance of the 4192A OSC OUTPUT, the network can be connected directly to the OSC OUTPUT through the power splitter as shown in Figure 3-8 (A). In this case, both the reference input and test input should be terminated with a 50Ω Feedthrough and connected to CHANNEL A and CHANNEL B, respectively.

3-50. If the characteristic impedance of the network is greater than 50Ω, a compensating resistor can be added in series with the OSC OUTPUT between the power splitter and the network to obtain the required output impedance. For example, if the input impedance of the network is 600Ω, a 550Ω resistor can be added in series with the 50Ω output to obtain the required 600Ω as shown in Figure 3-8 (B). Note that the reference input shown in Figure 3-8 (B) also has a compensating resistor to maintain identical impedances in both channels. In this case, both the reference input and test input should be terminated with a 600Ω Feedthrough and connected to CHANNEL A and CHANNEL B respectively.

3-51. If the characteristic impedance of the network is lower than 50Ω, connect a shunting resistor between the power splitter and network to be tested, as across the OSC OUTPUT, to obtain the required output impedance. Otherwise, a shunt resistance of the same value can be connected to CHANNEL A to obtain the same output impedance. The value of shunt resistance is calculated from the following formula:

$$R_s = \frac{50 \times Z}{50 - Z} \quad (\Omega)$$

where : R_s = shunt resistance
 Z = required output impedance

For example, if the input impedance of the network is 30Ω, a 75Ω shunt resistor can be added in parallel with a 50Ω output to obtain 30Ω as shown in Figure 3-8 (C). Note that the reference input shown in Figure 3-8 (C) also has a shunting resistor to maintain identical impedances in both channels. In this case, both the reference input and test input should be terminated with the 30Ω shunt resistor and connected to CHANNEL A and CHANNEL B, respectively. When driving an impedance lower than 50Ω, a certain amount of insertion loss will be encountered. The amount of loss depends on the type of impedance matching network used and on the various impedance ratios. Whenever a loss is encountered, an equal loss should be introduced in CHANNEL A so that the reference input accurately represents the input of the network. This can be accomplished by placing identical shunt resistances and identical terminations in both channels.

3-52. When the network to be tested has a high input impedance (1MHz) and low output impedance ($\approx 0\Omega$), each channel should be terminated with a 50Ω Feedthrough and then the network can be connected to CHANNEL B as shown in Figure 3-8 (D).

3-53. Deviation measurement from reference network can be performed by inserting the standard network between the power splitter and CHANNEL B. Figure 3-8 (E) shows an input configuration of networks which have 50Ω characteristic impedance. In this case, both the

Table 3-11. Balancing Transformers

| Model No. | Impedance | | Connectors | |
|-----------|------------|----------|------------|----------------------|
| | Unbalanced | Balanced | Unbalanced | Balanced |
| 11473A | 50Ω or 75Ω | 600Ω | BNC | WECO 310 |
| 11473B | | | | Simence 9REL STP-6AC |
| 11474A | | 135Ω | | WECO 241 |
| 11475A | | 150Ω | | Simence 9REL STP-6AC |
| 11476A | | 124Ω | | WECO 408A |

reference input and test input should be terminated by 50Ω Feedthroughs and connected to CHANNEL A and CHANNEL B, respectively.

input and test input should be terminated by 50Ω Feedthroughs and connected to CHANNEL A and CHANNEL B, respectively.

3-54. Floating networks can be measured by floating from the measuring circuit using one of the balancing transformers listed in Table 3-11. Figure 3-8 (F) shows the input configuration of a network which has 125Ω characteristic impedance. In this case, both the reference

3-55. Measurement Time

3-56. Table 3-12 shows the measurement times of the 4192A amplitude/phase measurements.

Table 3-12. Measurement Time for Amplitude/Phase Measurements

| Measurement Function | Measurement Mode | Measurement Frequency (Hz) | | | |
|-----------------------|------------------|--|--|-----------|-----------|
| | | 5 ~ 15 | 15 ~ 150 | 150 ~ 400 | 400 ~ 13M |
| (B-A) - θ | HIGH SPEED | $\frac{5000}{f} + 100.5 \sim \frac{5000}{f} + 114.5$ | | | 113 ~ 127 |
| | NORMAL | $\frac{5000}{f} + 102 \sim \frac{5000}{f} + 116$ | $\frac{15000}{f} + 102 \sim \frac{15000}{f} + 116$ | 202 ~ 216 | |
| | AVERAGE | $\frac{15000}{f} + 102 \sim \frac{15000}{f} + 116$ | 1102 ~ 1116 | | |
| (B-A) - GROUP DELAY*1 | HIGH SPEED | $\frac{5000}{f} + 412.5$ | | | 425 |
| | NORMAL | $\frac{5000}{f} + 592$ | $\frac{15000}{f} + 592$ | 692 | |
| | AVERAGE | $\frac{15000}{f} + 2399$ | 3399 | | |
| A/B (dBm) | HIGH SPEED | $\frac{5000}{f} + 77.5$ | | | 90 |
| | NORMAL | $\frac{5000}{f} + 79$ | $\frac{15000}{f} + 79$ | 179 | |
| | AVERAGE | $\frac{15000}{f} + 80$ | 1080 | | |
| A/B (dBV) | HIGH SPEED | $\frac{5000}{f} + 75.5$ | | | 88 |
| | NORMAL | $\frac{5000}{f} + 77$ | $\frac{15000}{f} + 77$ | 177 | |
| | AVERAGE | $\frac{15000}{f} + 78$ | 1078 | | |
| (B - A)*2 | HIGH SPEED | $\frac{5000}{f} + 90.5$ | | | 103 |
| | NORMAL | $\frac{5000}{f} + 92$ | $\frac{15000}{f} + 92$ | 192 | |
| | AVERAGE | $\frac{15000}{f} + 92$ | 1092 | | |

Measurement times are typical values in ms, f: measuring frequency (Hz).

*1: At spot frequency measurement (refer to paragraph 3-63).

*2: Measurement time for B - A measurements can be shortened by changing the setting of an internal control switch (refer to paragraph 3-139).

3-57. Test Fixture Characteristics

3-58. Compensation for the error-causing parasitic elements of the test fixtures used in amplitude/phase measurements is described in Figure 3-9. Additional error introduced into amplitude/phase measurements by the 16096A test fixture after compensation is as follows:

- B - A error : ± 0.1 dB
- Phase error : $\pm 0.1^\circ$
- A, B error : $\pm (0.1 + 0.06F^2)$ dB

where F is the Frequency of the test signal in MHz.

Input impedance of CHANNEL A and CHANNEL B is $1\text{M}\Omega$, shunted by 30pF.

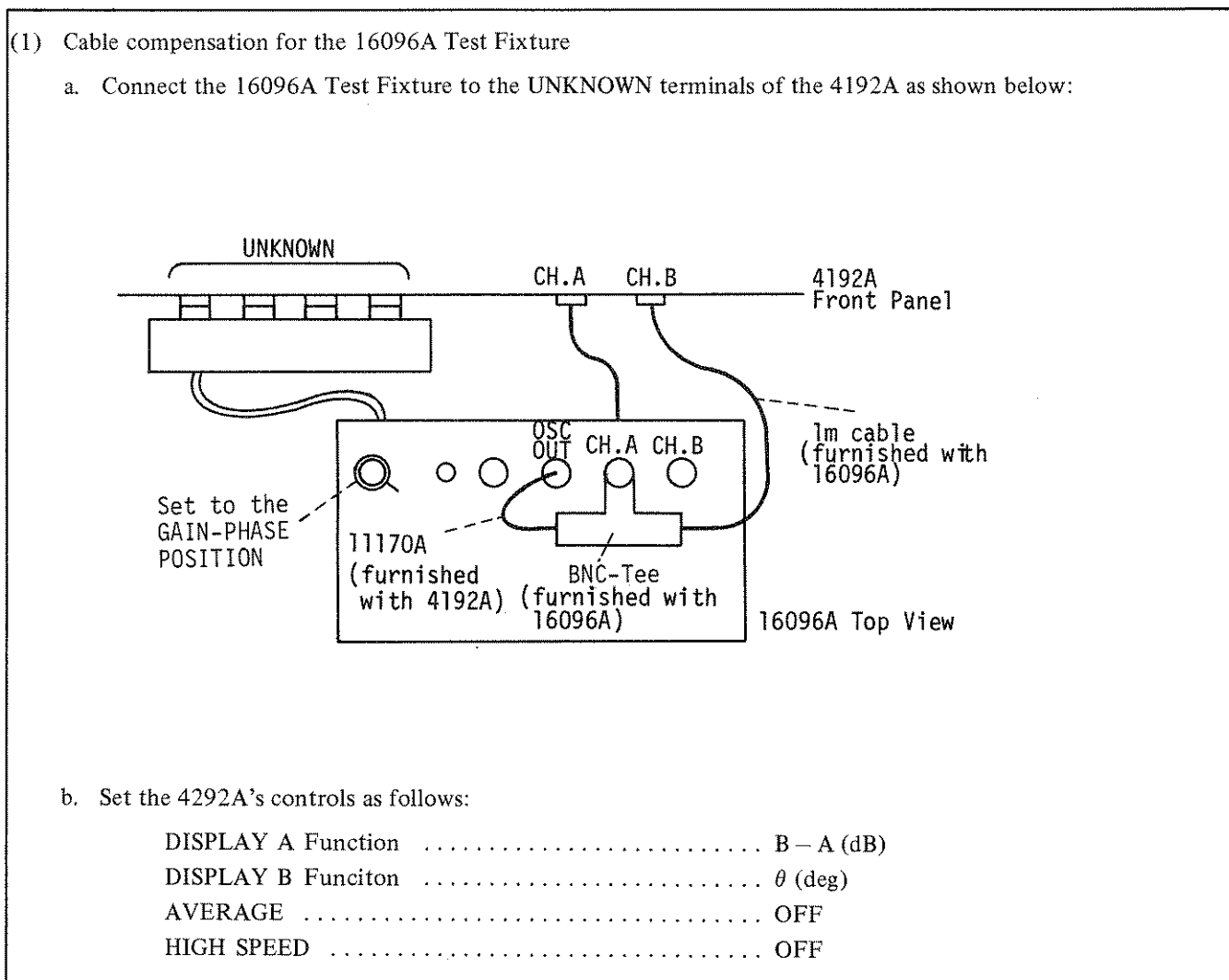
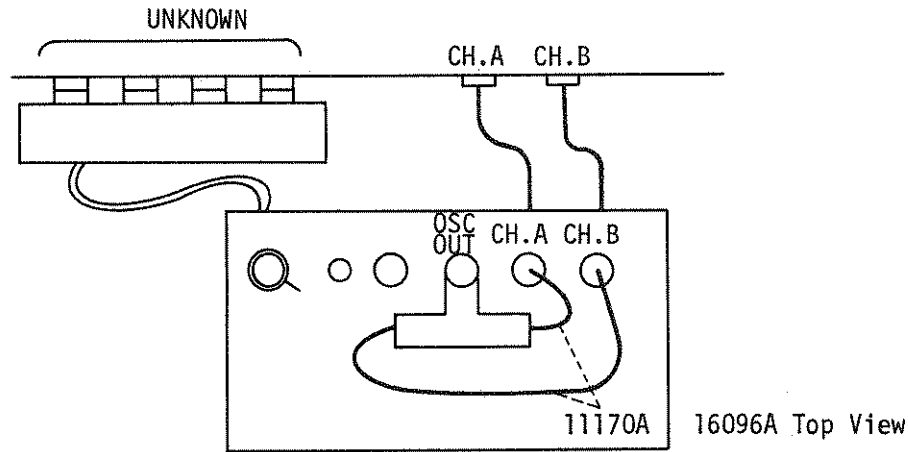

Figure 3-9. Cable Compensation (Sheet 1 of 4)

SELF TEST OFF
 SWEEP MANUAL
 TRIGGER INT
 $\Delta/\Delta\%$ OFF
 SPOT FREQ 1 kHz
 OSC LEVEL 0.6 V

- c. Set the selector switch on the 16096A to the GAIN-PHASE position.
- d. The value displayed on DISPLAY A should be 20 dBV \pm 0.02 dBV.
- e. Set the SPOT FREQ to 1 MHz.
- f. Adjust CHANNEL A CABLE COMP on the 16096A until the value displayed on DISPLAY A is 20 dBV \pm 0.1 dBV.
- g. Reconnect the 16096A as shown below:



- h. Set the SPOT FREQ to 1 kHz.
- i. The value displayed on DISPLAY A should be 0 dBV \pm 0.04 dBV.
- j. Set the SPOT FREQ to 1 MHz.
- k. Adjust CHANNEL B CABLE COMP on the 16096A until the value displayed on DISPLAY A is 0 dBV \pm 0.1 dBV.
- l. Set the SPOT FREQ to 15 kHz.
- m. The values displayed on DISPLAY A and DISPLAY B should be 0 dBV \pm 0.1 dBV and 0° \pm 0.5°, respectively.

Figure 3-9. Cable Compensation (Sheet 2 of 4)

(2) Compensation procedure for the 10013A 10 : 1 Scope Probe

- a. Connect the 11048C 50Ω Feedthrough termination to the OSC OUTPUT terminal of the 4192A.
- b. Connect the two 11013A scope probes to CHANNEL A and B and to the 50Ω feedthrough as shown in below.

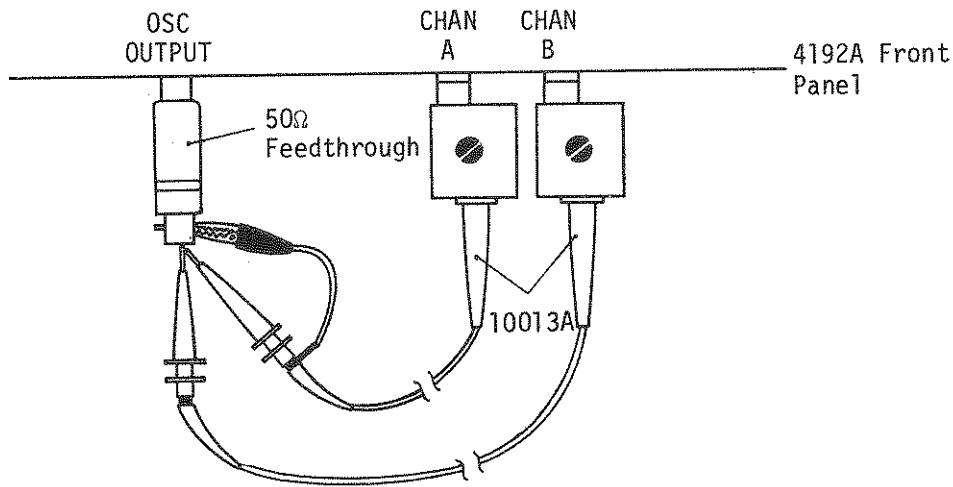

- c. Set the 4192A's controls as follows:

| | |
|--------------------------|-------------|
| DISPLAY A Function | A (dBm/dBV) |
| AVERAGE | OFF |
| HIGH SPEED | OFF |
| SELF TEST | OFF |
| SWEEP | MANUAL |
| GAIN MODE | dBV |
| TRIGGER | INT |
| $\Delta/\Delta\%$ | OFF |
| SPOT FREQ | 1 kHz |
| OSC LEVEL | 1 V |

- d. Press the BLUE key and the STORE DSPL A/B key.
- e. Press DISPLAY A's $\Delta/\Delta\%$ key.
- f. Set the SPOT FREQ to 1MHz.
- g. Adjust the cable compensation of the scope probe connected to CHANNEL A until the deviation, displayed on DISPLAY A, is 0.00dBV.

Figure 3-9. Cable Compensation (Sheet 3 of 4)

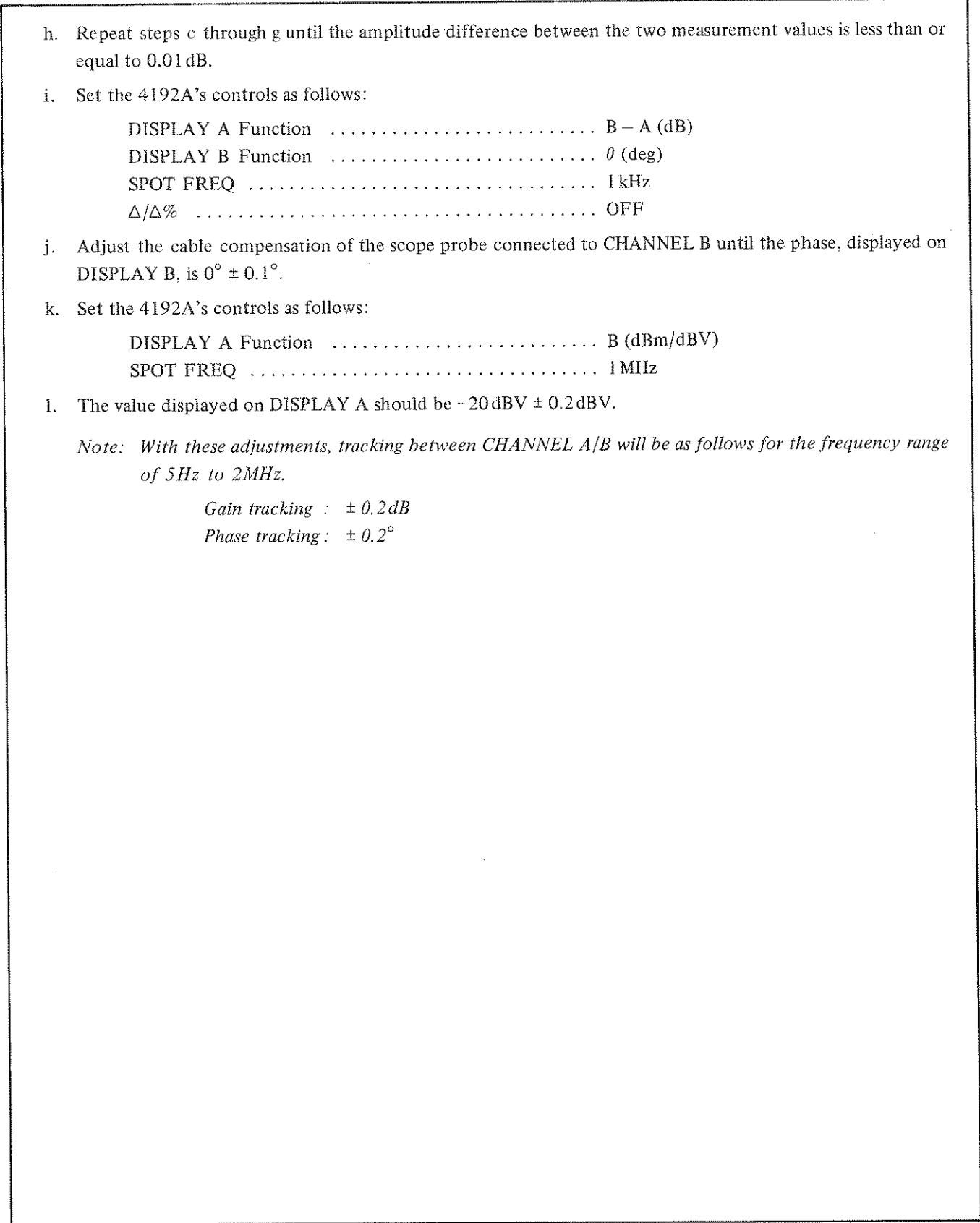

Figure 3-9. Cable Compensation (Sheet 4 of 4)

3-59. Amplitude/Phase Measurement Operating Instructions

3-60. Basic operating instructions for amplitude/phase measurements are given in Figure 3-10.

(1) Turn On

- a. Press the LINE ON/OFF key to turn the 4192A on.
- b. Following turn on, the instrument will perform the following operations in the order listed.
 - ① Initial operational check is performed (refer to paragraph 3-7).
 - ② HP-IB address, set by the HP-IB control switch on rear panel (refer to paragraph 3-117), is displayed on DISPLAY A (e.g. H-17).
 - ③ Initial control setting is performed (refer to paragraph 3-9).
- c. Confirm that 4192A trigger lamp begins to flash.
- d. Press the BLUE key and then the SELF TEST key to check the basic operation of the instrument. Refer to paragraph 3-7 for details on the SELF TEST.



Note: The 4192A requires a one-hour warm up period to satisfy all specifications listed in Table 1-1.

(2) Test Fixture Connection

Connect the desired test fixture. Refer to paragraphs 3-46 and 3-48 for Input Configuration and Impedance Matching, respectively.

Note: When the 16096A Test Fixture or 10013A 10 : 1 Scope Probe is used, error compensation, described in Figure 3-9, must be performed.

(3) Setting Measurement Condition

- a. Select the desired DISPLAY A parameter by pressing the  or  (up-down) key. The indicator lamp adjacent to the selected parameter will come on (refer to paragraph 3-38).
- b. If necessary, select the desired DISPLAY B parameter (compatible with the DISPLAY A parameter selected in step a by pressing the  key (refer to paragraph 3-38).
- c. When DISPLAY A function is set to A (dBm/dBV) or B (dBm/dBV), select the desired GAIN MODE: dBm or dBV.

Note: GAIN MODE, dBm or dBV, is specified from the following equations:

$$\text{dBm} = 20 \log_{10} V + 13.01$$

$$\text{dBV} = 20 \log_{10} V$$

The relationship between input voltage (V_{rms}) and dBm/dBV is shown in the graph below.

Figure 3-10. Operating Instructions for Amplitude – Phase Measurements (Sheet 1 of 2)

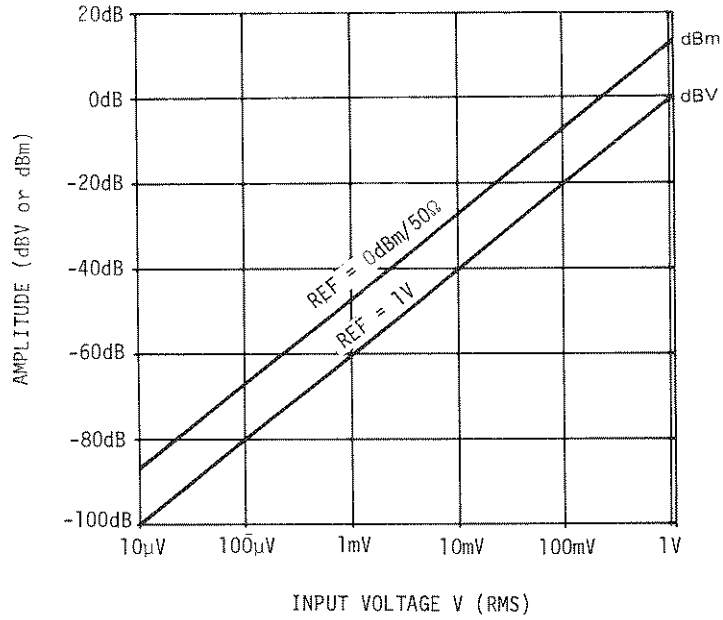

d. Press SPOT FREQ key.

Set the desired spot frequency (initial setting value is 100kHz) with the DATA input keys (refer to paragraph 3-29) and press the appropriate ENTER key.

(Example) Spot frequency = 7.5 MHz

Key strokes :

The spot frequency setting, 7500.000kHz, is displayed on DISPLAY C (Test Parameter Data Display).

e. Press the OSC LEVEL key.

Set the desired measuring signal level (initial setting value is 1 V) with the DATA input keys (refer to paragraph 3-24) and press the appropriate ENTER key.

(Example) OSC level = 750 mV

Key strokes :

The OSC level setting, 0.750 V, is displayed on DISPLAY C.

(4) Connecting a Network

a. Connect the network to be tested between CHANNEL B and the power splitter with the test fixture.

Note: When comparing two networks, the reference network should be connected between the power splitter and CHANNEL A.

b. The 4192A will automatically display the measured values of the network to be tested in accordance with the measurement conditions.

Figure 3-10. Operating Instructions for Amplitude – Phase Measurements (Sheet 2 of 2)

CAUTION

When making amplitude/phase measurements on an active circuit (e.g., amplifier, active filter, etc.), DO NOT allow a dc bias voltage exceeding $\pm 10V$ to be applied to the OSC OUTPUT terminal. To do so may damage the instrument. When the dc bias voltage of the circuit under test is higher than $\pm 10V$, but not more than $\pm 35V$, connect a $2.2\mu F$ (or less) capacitor in series with the OSC OUTPUT terminal to block the dc bias voltage. This blocking capacitor can be connected to the SHORT/EXTERNAL CAP terminal of the 16096A Test Fixture instead of the short-connector. When the blocking capacitor is used, however, the output impedance of the OSC OUTPUT is increased at low test frequencies, as shown graphically below, and the oscillator level is reduced. If a suitable capacitor is not available from conventional sources, order HP Part No.: 0160-0128; $2.2\mu F$, 50V.

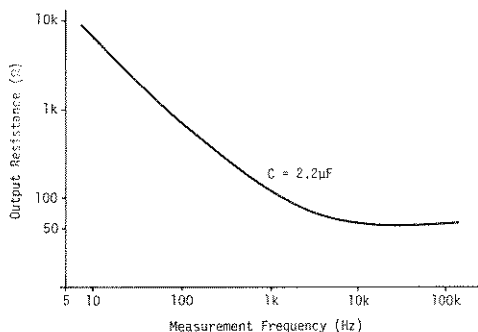

NEVER apply a dc voltage exceeding $\pm 35V$ to the OSC OUTPUT terminal, even if the blocking capacitor is used.

Figure 3-10. Operating Instructions for Amplitude – Phase Measurement (Sheet 3 of 3)

3-61. Swept Frequency Measurements

3-62. Basic operating instructions for swept-frequency amplitude/phase measurements are given in Figure 3-11.

Note: Before proceeding with the procedure given below set the 4192A's controls as necessary for an amplitude/phase measurement. Refer to Figure 3-10.

(1) Setting Sweep Parameters

- a. Press the START FREQ key. Set the start (lower limit) frequency (initial setting is 5Hz) of the desired sweep frequency range with the DATA input keys (refer to paragraph 3-24) and press the appropriate ENTER key.

(Example) Start frequency = 10kHz

Key strokes :

The start frequency setting, 10.00000kHz, is displayed on DISPLAY C (Test Parameter Data Display).

Figure 3-11. Operating Instructions for Swept – Frequency Amplitude – Phase Measurements (Sheet 1 of 4)

- b. Press the STOP FREQ key. Set the stop (upper limit) frequency (initial setting is 13MHz) of the desired sweep frequency range with the DATA input keys (refer to paragraph 3-24) and press the appropriate ENTER key.

(Example) Stop frequency = 1MHz

Key strokes :

The stop frequency setting, 1000.000kHz, is displayed on DISPLAY C.

Note: The stop frequency should be set to a value higher than the start frequency. If not, error-code E-03 will be displayed on DISPLAY C when swept measurement is attempted and measurement will be not performed.

- c. Press the STEP FREQ key. Set the desired step frequency (initial setting is 1kHz) with the DATA input keys (refer to paragraph 3-24) and press the appropriate ENTER key.

(Example) Step frequency = 1kHz

Key strokes :

The step frequency setting, 1.000000kHz, is displayed on DISPLAY C.

Note: In LOG SWEEP measurement applications, STEP FREQ. has no meaning. To set the instrument to logarithmic sweep mode, press the BLUE key and the LOG SWEEP key; the indicator lamp will come on. In this mode, automatic or manual sweeps are made at twenty frequency steps per decade. Each step is calculated from the following formula:

$$F \times 10^{0.05N}$$

where F is the start frequency (5Hz, 10Hz, 100Hz, 1kHz, 10kHz, 100kHz, 1MHz, or 10MHz) and N is an integer that represents the step number. For example, if the start frequency is 100kHz and the stop frequency is 1MHz, the sweep will be as follows:

| | | | | | | | |
|---|-------------|----|-------------|----|-------------|----|-------------|
| 1 | 112.2018kHz | 6 | 199.5262kHz | 11 | 354.8133kHz | 16 | 630.9573kHz |
| 2 | 125.8925kHz | 7 | 223.8721kHz | 12 | 398.1071kHz | 17 | 707.9457kHz |
| 3 | 141.2537kHz | 8 | 251.1886kHz | 13 | 446.6835kHz | 18 | 794.3282kHz |
| 4 | 158.4893kHz | 9 | 281.8382kHz | 14 | 501.1872kHz | 19 | 891.2509kHz |
| 5 | 177.8279kHz | 10 | 316.2277kHz | 15 | 562.3413kHz | 20 | 1000.000kHz |

The start and stop frequencies, which determine the sweep range, are limited to decade values (10, 100, 1k, 10k, 100k, 1M, 10M). If, for example, the start frequency is set to 50kHz and the stop frequency is set to 800kHz, the instrument automatically sets the sweep range as 10kHz to 1MHz. There are, however, two exceptions: (1) when the start frequency is set to a value below 10Hz and (2) when the stop frequency is set to a value above 10MHz. In such cases, the instrument automatically assumes a start frequency of 5Hz and a stop frequency of 13MHz.

Figure 3-11. Operating Instructions for Swept – Frequency Amplitude – Phase Measurements (Sheet 2 of 4)

(2) Manual Sweep



In manual sweeps, the sweep begins at the spot frequency, and the sweep range is determined by the start and stop frequencies.

- a. Set the desired spot frequency (initial setting is 100kHz) with the DATA input keys (refer to paragraph 3-24) and press the appropriate ENTER key.

(Example) Spot frequency = 10kHz





Key strokes :    

The spot frequency, 10.00000kHz, will be displayed on DISPLAY C.;



- b. Press the STEP UP  key or STEP DOWN  key to shift the frequency one step (determined by the step frequency setting) in the indicated direction.

Notes: 1. In logarithmic sweep mode, the measurement frequency is automatically shifted to the nearest frequency that satisfies the equation $F \times 10^{0.05N} = F_m$; where F is the start frequency, F_m is the measurement frequency, and N is an integer that represents the step number.



2. If the spot frequency is set to a value that is greater than the stop frequency or less than the start frequency, error-code E-04 will be displayed on DISPLAY C and the measurement will not be performed.



- c. Pressing and holding the STEP UP () key or STEP DOWN () key continuously advances swept frequency measurement.
- d. When X10 STEP key is pressed simultaneously with the STEP UP () or STEP DOWN () key, the step frequency increases by a factor of ten. (This is for linear sweeps only.)

(3) Auto Sweep

- a. Press MAN/AUTO key to set to auto sweep mode (the indicator lamp comes on.)
- b. ① Pressing the START UP () key starts the frequency sweep from the programmed start frequency. The frequency sweep ends at the stop frequency.
- ② Pressing the START DOWN () key starts the frequency sweep from the stop frequency. The frequency sweep ends at the start frequency.

Note: Swept test frequency is displayed on DISPLAY C.

- c. To temporarily stop a swept frequency measurement, press the PAUSE key. Start frequency, stop frequency, step frequency, sweep direction, and sweep mode (linear or logarithmic, auto or manual) can be changed when the PAUSE function is set. To restart the sweep, press the START UP () key or START DOWN () key.
- d. Auto sweep measurement mode is automatically released when the swept measurement ends (reaches the stop frequency or start frequency). To stop the sweep before the measurement is completed, press BLUE key and then press the SWEEP ABORT key.

Key strokes :  

To return to normal spot frequency measurement, press the SWEEP AUTO key (indicator lamp goes off).

Figure 3-11. Operating Instructions for Swept – Frequency Amplitude – Phase Measurements (Sheet 3 of 4)

Note: When a swept frequency measurement is made, if the sweep comes to a frequency band which has lower frequency resolution than the STEP FREQ., this STEP FREQ. automatically changes to the next higher resolution frequency, and the sweep continues. In special cases for group delay measurement, E-10 appears on DISPLAY C and the sweep stops.

Figure 3-11. Operating Instructions for Swept – Frequency Amplitude – Phase Measurements (Sheet 3 of 4)

3-63. Group Delay Measurement

3-64. The 4192A can measure group delay at a spot frequency or swept frequency. Figure 3-12 shows a group delay measurement at a spot frequency.

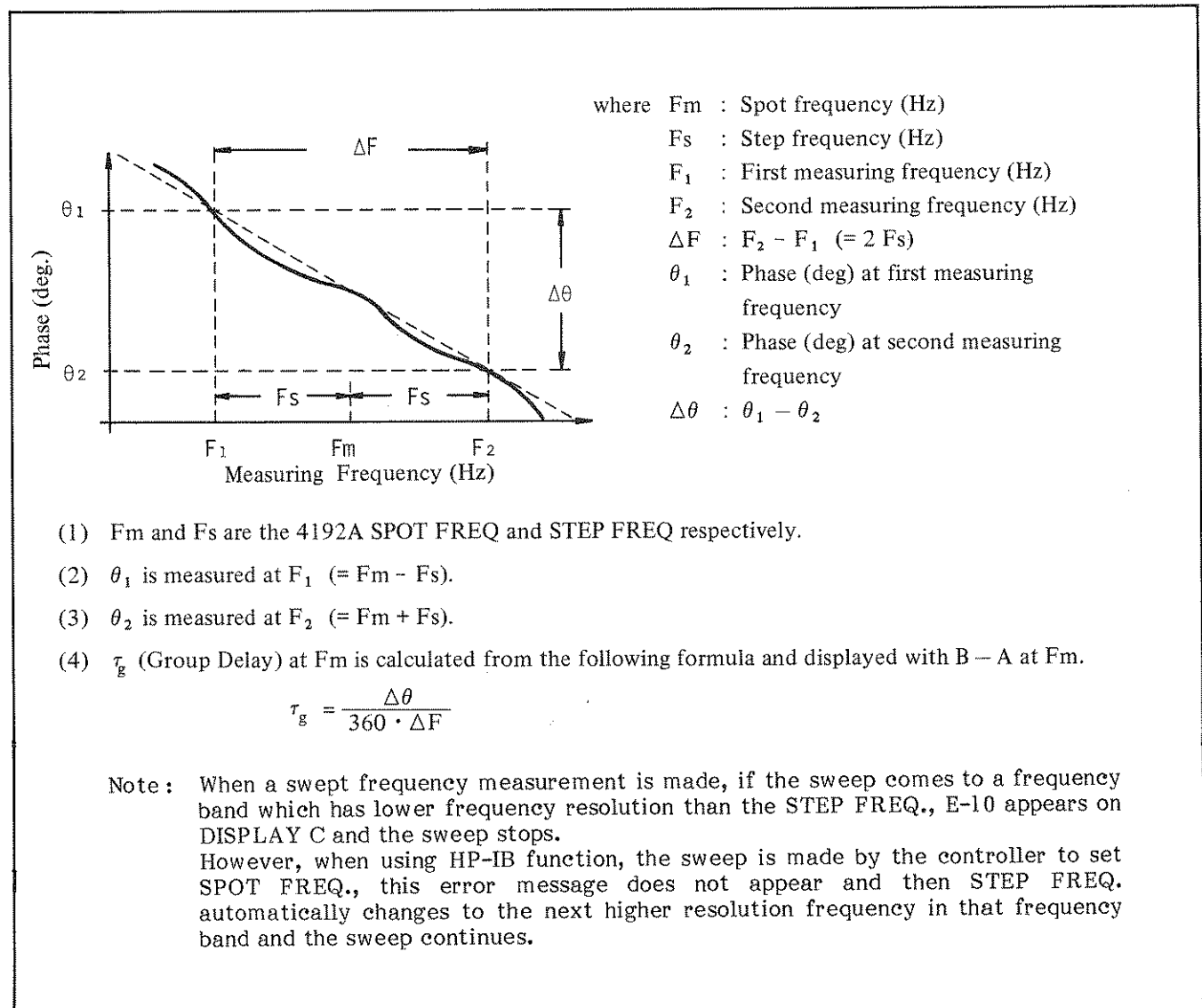

Figure 3-12. Group Delay Measurement at Spot Frequency

3-65. Figure 3-13 shows a swept group delay measurement.

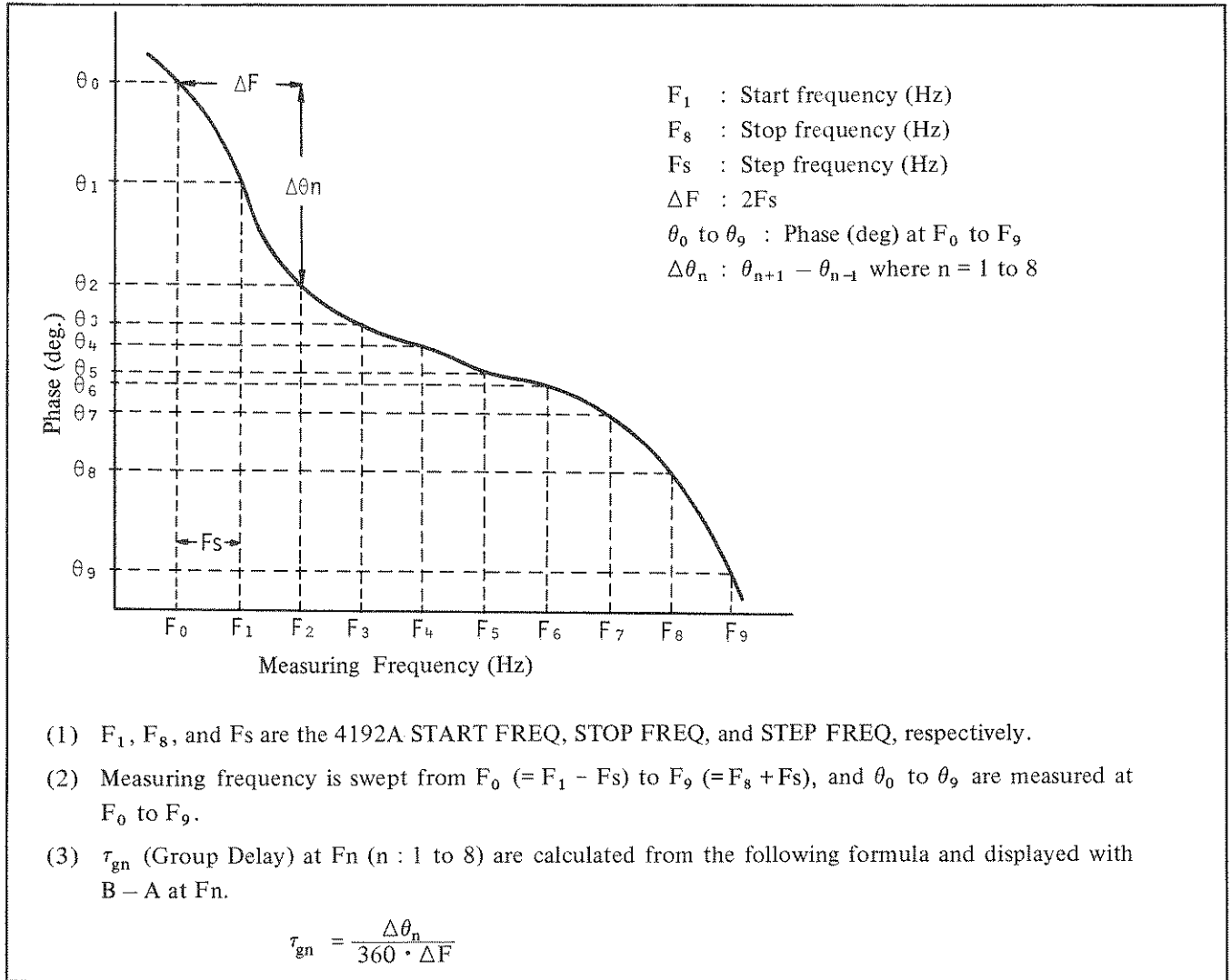

Figure 3-13. Group Delay Measurement on Swept Frequency

3-66. Measurement ranges and resolution of the group delay measurements are determined automatically by ΔF (STEP FREQ $\times 2$) and $\Delta\theta$.

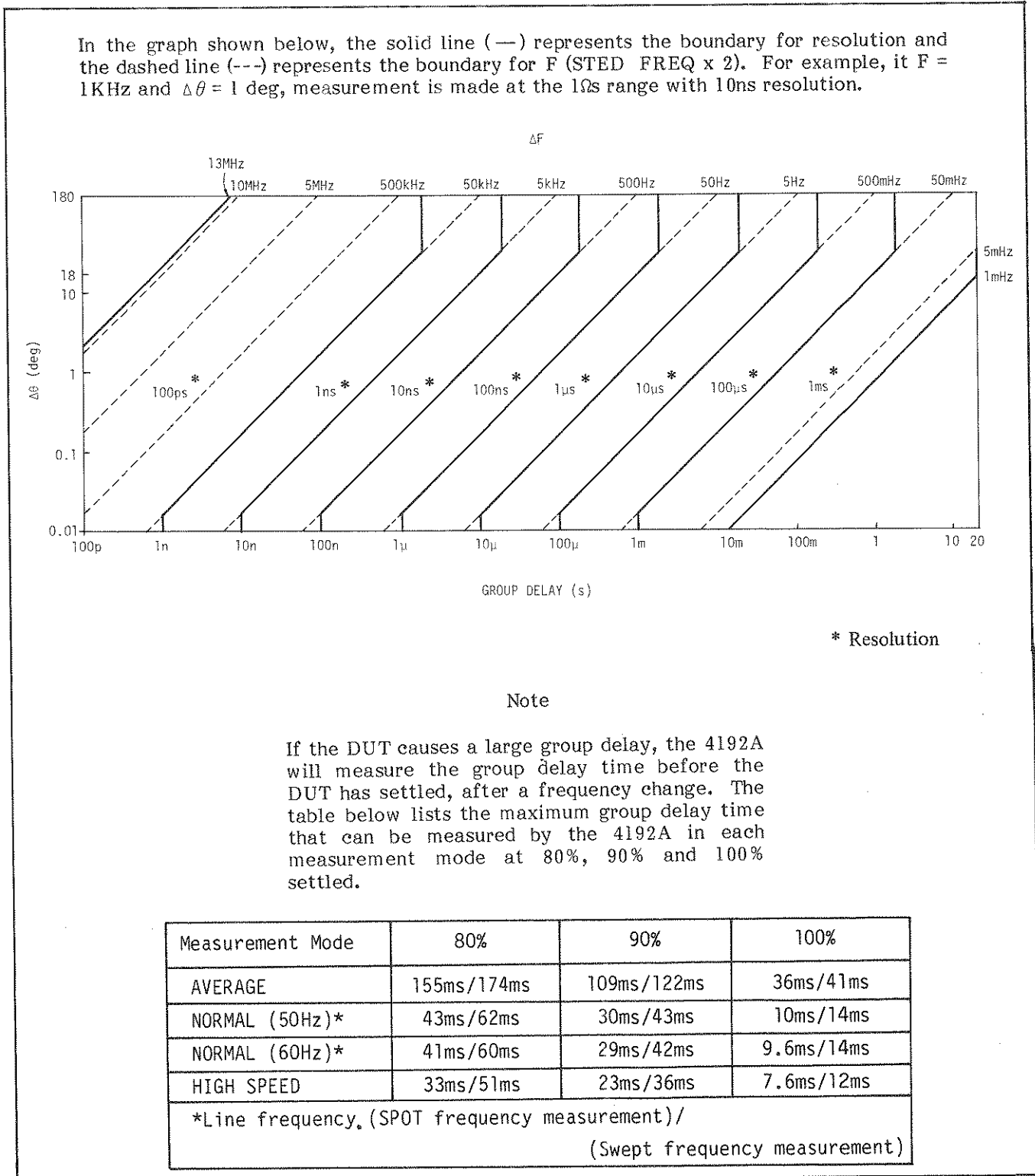

Figure 3-14. Measurement Ranges and Resolution of the Group Delay Measurements

3-67. IMPEDANCE MEASUREMENT

3-68. The 4192A can accurately measure the impedance parameters of a component or circuit at the frequency, test signal level, and dc bias level found in actual-real world-operation.

- (1) Measuring Frequency : 5Hz to 13MHz
- (2) OSC Level : 5 mVrms to 1.1 Vrms
- (3) DC bias voltage : -35V to +35V

Frequency and bias can be automatically or manually swept, full range, in either direction. OSC level can also be swept (manual only) at 1mV steps (5mV steps at levels above 100mV). The actual test signal voltage across the DUT, or the test signal current through the DUT can be measured.

Instructions for impedance measurements are given in paragraphs 3-69 through 3-108.

3-69. Measurement Functions



3-70. The 4192A simultaneously measures two independent, complementary impedance parameters in each measurement cycle. This combination of measurement parameters represents both the resistive and reactive

characteristics of the sample. A total of fourteen measurement parameters (two are duplicates) make up the twelve selectable parameter combinations. These measurement functions are classified, for display purpose, into two groups: DISPLAY A and DISPLAY B functions, as given in Table 3-13. DISPLAY A function group comprises the primary measurement parameters and measured values are displayed on DISPLAY A. DISPLAY B functions include a group of subordinate parameters, the availability of which are partially dependent on the primary function. Selected and measured values are displayed on DISPLAY B. Selectable combinations of DISPLAY A and DISPLAY B functions are listed in Table 3-13. Measurement parameters separated by a slash (/) in Table 3-13 are for equivalent series circuit (⊖—□—⊕) (left of slash) or equivalent parallel circuit (⊖—□—⊕) (right of slash). Refer to paragraph 3-73 for details. The 4192A measures $R + jX$ (impedance) in equivalent series circuit mode and $G + jB$ (admittance) in equivalent parallel circuit mode. Other impedance parameters are calculated from $R + jX$ or $G + jB$ with the equations given in Table 3-14. Measurement results can be displayed as either deviation or percent deviation from stored reference values. Deviation measurements are described in paragraph 3-26.

Table 3-13. DISPLAY A/B Functions for Impedance Measurements

| DISPLAY A Function | | DISPLAY B Function | |
|--------------------|--|--------------------|------------------------|
| Z / Y | Absolute Impedance/Absolute Admittance | θ (deg) | Phase Angle in degrees |
| | | θ (rad) | Phase Angle in radians |
| R/G | Resistance/Conductance | X/B | Reactance/Susceptance |
| L | Inductance Capacitance | Q | Quality Factor |
| C | | D | Dissipation Factor |
| | | R/G | Resistance/Conductance |

Table 3-14. Measurement Parameter Formulas for Impedance Measurement

| Measurement Parameter | Measurement Equivalent Circuit | |
|-----------------------|---|---|
| |  |  |
| Z | $\sqrt{R^2 + X^2}$ | / |
| Y | | |
| θ | $\tan^{-1} \left(\frac{X}{R} \right)$ | $\tan^{-1} \left(\frac{B}{G} \right)$ |
| L | $\frac{X}{\omega}$ | $-\frac{1}{\omega B}$ |
| C | $-\frac{1}{\omega X}$ | $\frac{B}{\omega}$ |
| Q | $\frac{ X }{R}$ | $\frac{ B }{G}$ |
| D | $\frac{R}{ X }$ | $\frac{G}{ B }$ |

3-71. Measurement Range

3-72. The 4192A has two measurement range modes: AUTO and MANUAL. The mode is set by the ZY RANGE keys on the front-panel. When DISPLAY A function is set to |Z|/|Y| in AUTO range mode, ranging depends on the impedance, |Z|, or the admittance, |Y|, of the DUT. When L or C is selected, ranging depends on the displayed value. |Z| and |Y| ranges and resolution are listed in Table 3-15.

When ZY RANGE is set to AUTO, the optimum range is automatically selected. If the internal measurement circuit is saturated or the measured value exceeds the upper limit of the range (130% of full scale), the next higher range is automatically selected. If the measured value is less than the range's lower limit (11% of full scale), the next lower range is automatically selected.



When ZY RANGE is set to MANUAL, the measurement range will not change even if the measured value of the DUT changes. If the ZY RANGE down () key or up () key is pressed, the measurement range is changed one decade in the indicated direction. If the

Table 3-15. ZY RANGE

| ZY RANGE | Z | | Y | |
|-------------|--------------------|------------|--------------------|------------|
| | Measurement Range | Resolution | Measurement Range | Resolution |
| 1Ω/10S | 0.0001Ω ~1.2999Ω | 0.1 mΩ | 0.01S ~12.99S | 10mS |
| 10Ω/1S | 0.001Ω ~12.999Ω | 1mΩ | 0.0001S ~1.2999S | 100μS |
| 100Ω/100mS | 0.01Ω ~129.99Ω | 10mΩ | 0.01mS ~129.99mS | 10μS |
| 1kΩ/10mS | 0.0001kΩ ~1.2999kΩ | 100mΩ | 0.001mS ~12.999mS | 1μS |
| 10kΩ/1mS | 0.001kΩ ~12.999kΩ | 1Ω | 0.0001mS ~1.2999mS | 100nS |
| 100kΩ/100μS | 0.01kΩ ~129.99kΩ | 10Ω | 0.01μS ~129.99μS | 10nS |
| 1MΩ/10μS | 0.0001MΩ ~1.2999MΩ | 100Ω | 0.001μS ~12.999μS | 1nS |

internal measurement circuit is saturated, UCL will be displayed on DISPLAY A; if the measured value exceeds the upper limit of the range (130% of full scale), OF1 will be displayed on DISPLAY A.

The time required for a range change is between 35 ms and 40 ms at frequencies above 400 Hz. Figure 3-15 shows the number of display digits for $|Z|$ and $|Y|$ measurements. (The number of display digits depends on the test frequency, OSC level, and ZY RANGE.) Measurement range for each of the other parameters is discussed below.

(1) R/G/X/B:

The measurement ranges, resolution, and number of display digits for R (resistance) and X (reactance) are the same as those for $|Z|$ and are given in Table 3-15 and Figure 3-15. Likewise, measurement ranges, resolution, and number of display digits for G (conductance) and B (susceptance) are the same as those for $|Y|$. However, the upper limit of X/B and DISPLAY B R/G is 200% of full scale and the lower limit is 18% of full scale.

(2) L/C:

The measurement ranges, resolution, and number of display digits for L (inductance) and C (capacitance) depends on the test frequency and the ZY RANGE (see Figure 3-16). The upper limit for L and C is 200% of full scale and the lower limit is 18% of full scale.

(3) $\theta/Q/D$:

The measurement ranges and resolution for θ (phase angle), Q (quality factor) and D (dissipation factor) are given in Table 3-16. Number of display digits for θ , Q, and D are the same as that for $|Z|$ and $|Y|$ (see Figure 3-15). When the measured value of $|Z|$ or $|Y|$ is less than 5% of full scale, θ , Q, and D measurement cannot be made and --- is displayed on DISPLAY B.

The measurement ranges for these parameters are selected automatically. If the measured value exceeds the limit of the display, OF2 will be displayed on the corresponding display.

Table 3-16. Measurement Range of $\theta/Q/D$

| Measurement Parameter | Measurement Range | Resolution |
|-----------------------|------------------------------|------------|
| θ (deg) | $0^\circ \sim \pm 180^\circ$ | 0.01° |
| θ (rad) | $-\pi \sim -1.000$ | 0.001 |
| | $-1.0000 \sim +1.0000$ | 0.0001 |
| | $+1.000 \sim +\pi$ | 0.001 |
| Q | 0 ~ 1999.9 | 0.1 |
| D | 0 ~ 1.9999 | 0.0001 |
| | 2.000 ~ 19.999 | 0.001 |

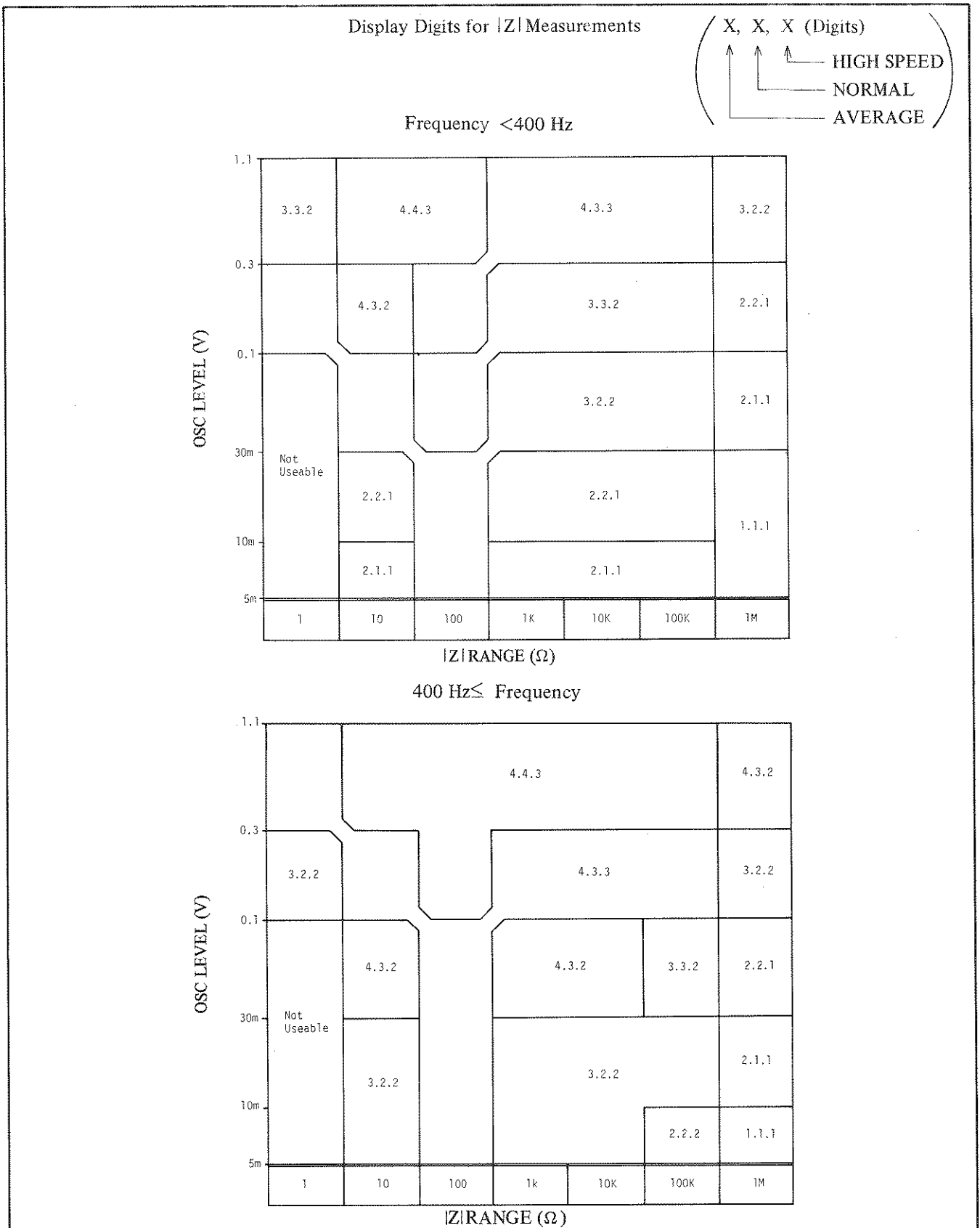

Figure 3-15. Display Digits for |Z|/|Y| Measurements (sheet 1 of 2)

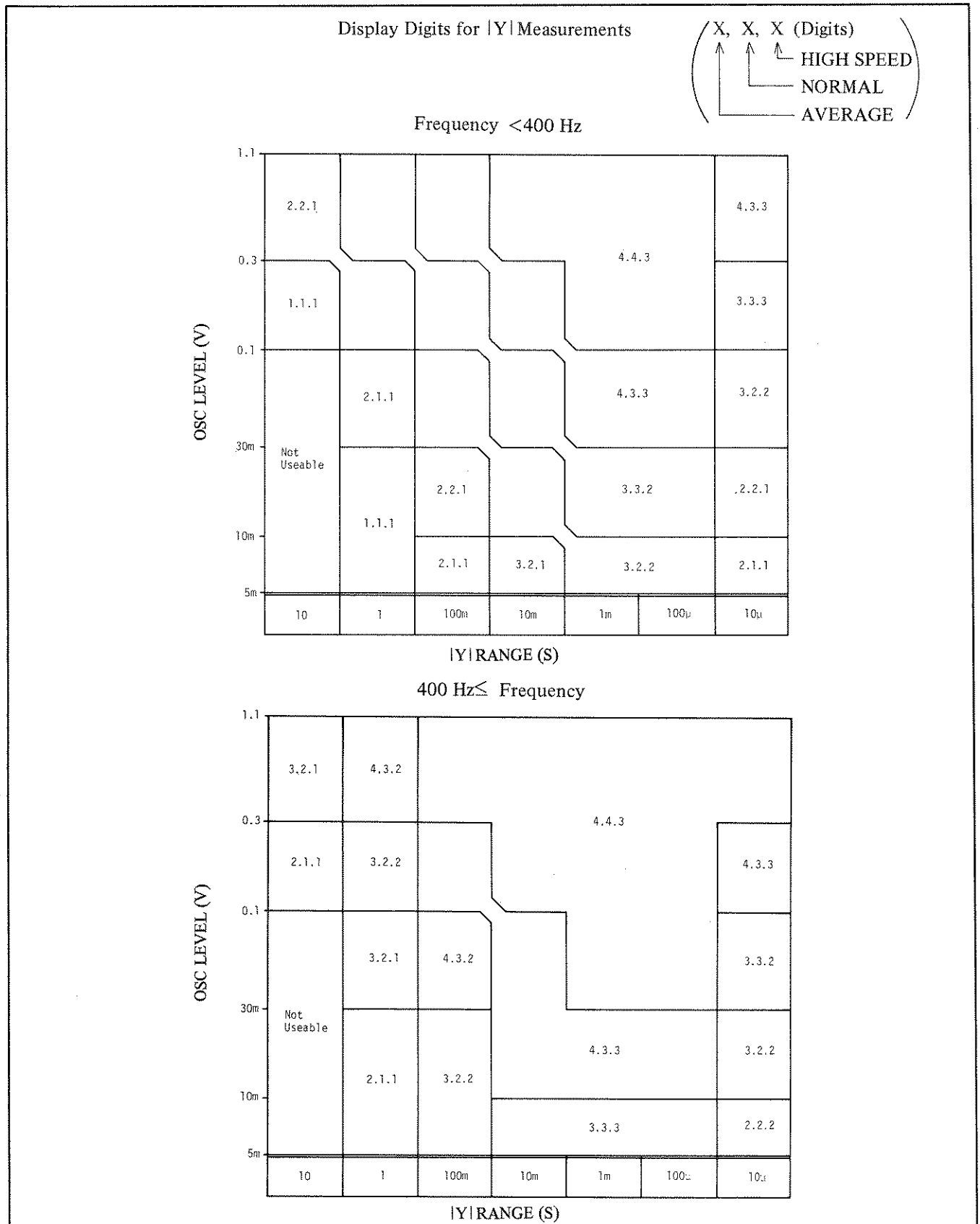
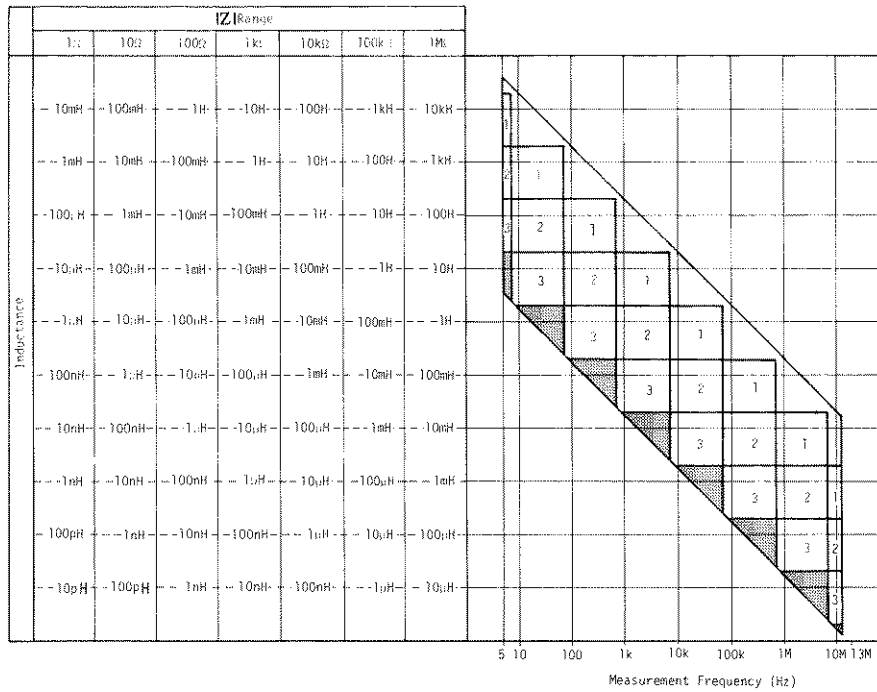
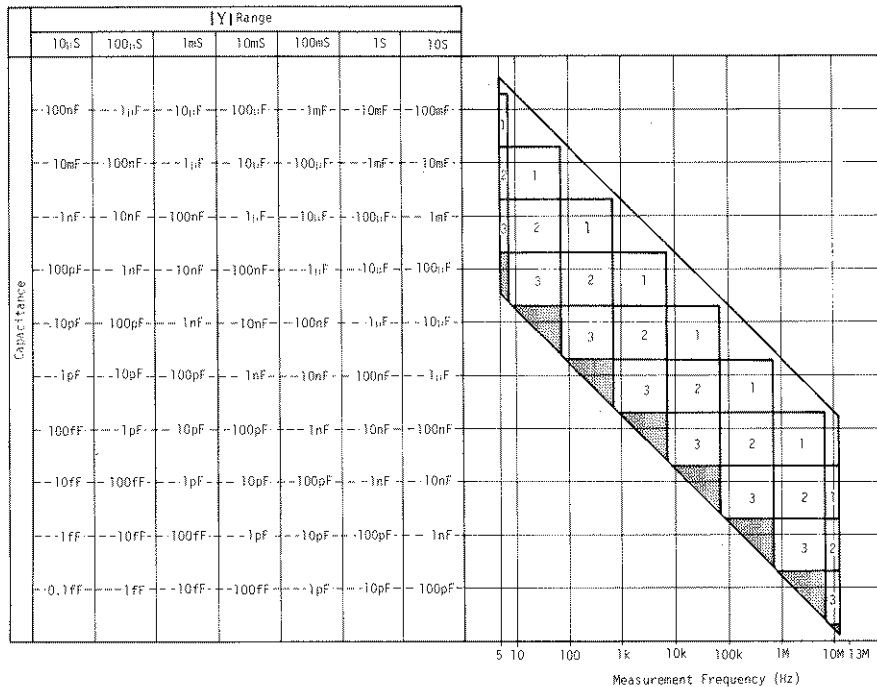

Figure 3-15. Display Digits for |Z|/|Y| Measurements (sheet 2 of 2)

Measurement Ranges, Resolution, and Display Digits for L Measurements (Specified by |Z| RANGE).







Measurement Ranges, Resolution, and Display Digits for C Measurements (Specified by |Y| RANGE).

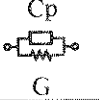

Note: Display digits for L/C = Display digit of |Z|/|Y| in Figure 3-15 – Number in above figure. Shaded areas indicate that measurement cannot be performed.

Figure 3-16. Measurement Ranges, Resolution and Display Digits for L/C Measurements.

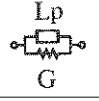
Table 3-17. Dissipation Factor Equations

| Circuit Mode | | Dissipation Factor | Conversion to Other Modes |
|--------------|---|--|--|
| C |  | $D = \frac{G}{\omega C_p} = \frac{1}{Q}$ | $C_s = (1 + D^2) C_p, R = \frac{D^2}{1 + D^2} \cdot \frac{1}{G}$ |
| |  | $D = \omega C_s R = \frac{1}{Q}$ | $C_p = \frac{1}{1 + D^2} C_s, G = \frac{D^2}{1 + D^2} \cdot \frac{1}{R}$ |
| L |  | $D = \omega L_p G = \frac{1}{Q}$ | $L_s = \frac{1}{1 + D^2} L_p, R = \frac{D^2}{1 + D^2} \cdot \frac{1}{G}$ |
| |  | $D = \frac{R}{\omega L_s} = \frac{1}{Q}$ | $L_p = (1 + D^2) L_s, G = \frac{D^2}{1 + D^2} \cdot \frac{1}{R}$ |

value at a given frequency for both parallel and series equivalents.

In ordinary LCR measuring instruments, the measurement circuit is set (automatically or manually) to a predetermined equivalent circuit with respect to either the selected range or to the dissipation factor value of the sample. The wider circuit mode selection capability of the 4192A, which is free from these restrictions, permits taking measurements in the desired circuit mode and of comparing such measured values directly with those obtained by another instrument. This obviates the inconvenience and necessity of employing instruments capable of taking measurements with the same equivalent circuit to assure measurement result correspondence.

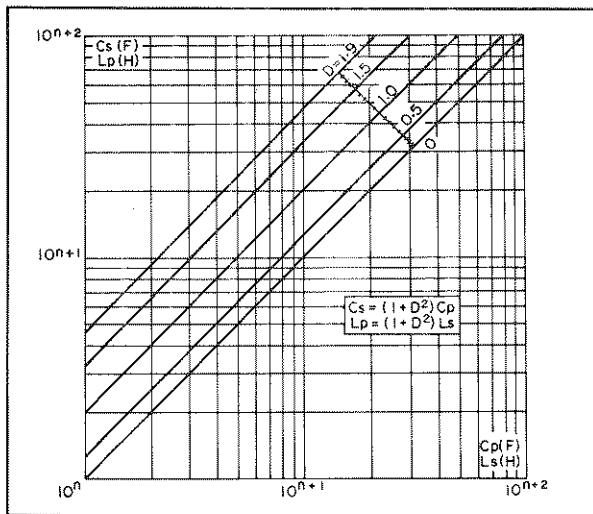

Figure 3-18. Parallel and Series Parameter Relationship

3-75. Unknown Terminals

3-76. For connecting the sample to be tested, the 4192A employs measurement terminals in a four terminal pair configuration, which has a significant measuring advantage for component parameter measurements requiring high accuracy in the high frequency region. Generally, any mutual inductance, interference of the measurement signals, and unwanted residual factors in the connection method which are incidental to ordinary terminal methods significantly affect the measurement at a high frequency. The four terminal pair configuration measurement permits easy, stable and accurate measurements and avoids the measurement limitations inherent in such effects. To construct this terminal architecture, connection of a sample to the instrument requires the use of a test fixture or test leads in a four terminal pair configuration design.

The UNKNOWN terminals consist of four connectors: High current (H_{CUR}), High potential (H_{POT}), Low potential (L_{POT}) and Low current (L_{CUR}). The purpose of the current terminals is to cause a measurement signal current to flow through the sample. The potential terminals are for detecting the voltage drop across the sample. The high side signifies the drive potential (referenced to low side potential) drawn from the internal measurement signal source. To compose a measurement circuit loop in a four terminal pair configuration, the H_{CUR} and H_{POT}, L_{POT} and L_{CUR} terminals must be respectively connected together and, in addition, the shields of all conductors must be connected together (as shown in Figure 3-19). Principle of the four terminal configuration measurement is illustrated in Figure 3-20. At first glance, the arrangement appears to be an expanded four terminal

method with a built-in guard structure. This is true. Thus, the four terminal pair method combines the advantages of the four terminal method in low impedance measurements while providing the shielding required for high impedance measurements. The distinctive feature of the four terminal pair configuration is that the outer shield conductor works as the return path for the measurement signal current. The same current flows through both the center conductors and the outer shield conductors (in opposite directions) yet no external magnetic fields are generated around the conductors (the magnetic fields produced by the inner and outer currents completely cancel each other). Because the measurement signal current does not develop an inductive magnetic field, the test leads do not contribute additional measurement errors due to self-or mutual-inductance between the individual leads. Hence, the four terminal pair method enables measurements with best accuracy while minimizing any stray capacitance and residual inductance in the test leads or test fixture.

Note: If residual inductance does exist in test leads, it affects measurements and the resultant additional measurement error increases in capacitance measurements in proportion to the square of the measurement frequency.

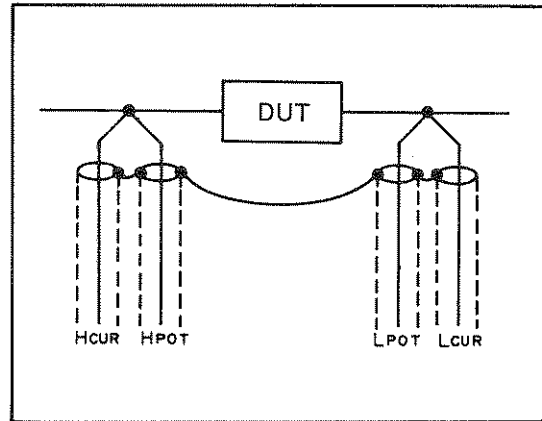

Figure 3-19. Four Terminal Pair DUT Connections

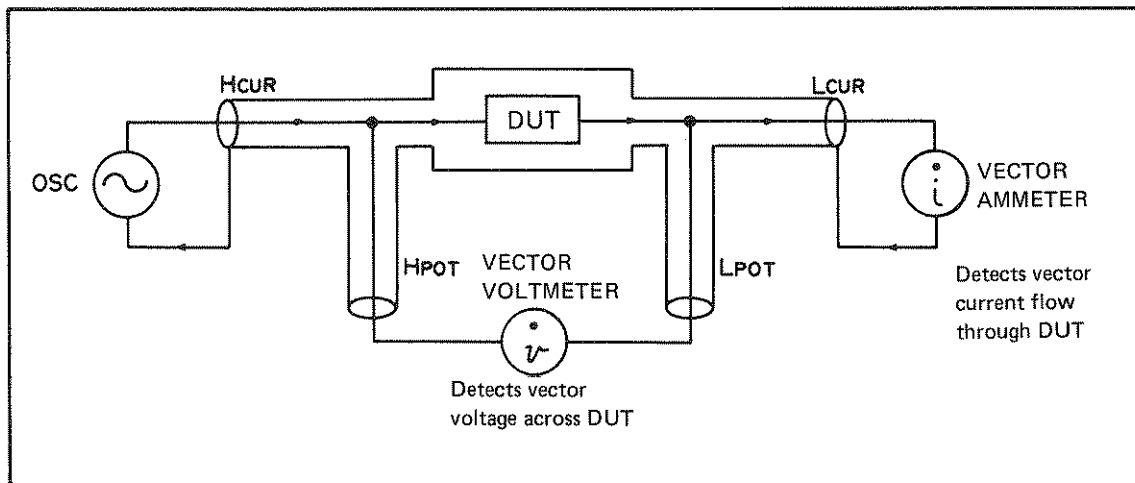

Figure 3-20. Four Terminal Pair Measurement Principle

3-77. Selection of Test Cable Length

3-78. The propagation signal in a transmission line will develop a change in phase between two points on the line as illustrated in Figure 3-21. The difference in phase corresponds to the ratio of the distance between the two points to the wavelength of the propagating signal. Consequently, owing to their length, test cables for connecting a sample will cause a phase shift and a propagation loss of the test signal. For example, the wavelength of a 13MHz test signal is 23 meters which is 23 times as long as the 1m standard test cables. Here, the phase of the test signal at the end of the test cable will have been shifted by about 15.6 degrees ($360^\circ \div 23$) as referenced to the phase at the other end of the cable. Since the effect of test cables on measurements and the resultant measurement error increase in proportion to the test frequency, cable length must be taken into consideration in high frequency measurements. The CABLE LENGTH switch selects measuring circuitry for the 1m standard test cables or for a test fixture attached directly to the UNKNOWN terminals. When standard 1m test cables are used for measurements, the CABLE LENGTH switch is set to the 1m position to properly adapt measuring circuit for the test cables and to minimize additional measurement errors. The 0 position is selected for direct attachment type test fixtures.

Notes:

1. When the HP16047B Test Fixture is used with the 4192A, set CABLE LENGTH switch to 1m position.
2. If test cable is longer or shorter than the standard 1m test cable, the additional error contributed is proportional to the square of the frequency. As the characteristic impedance of the test cable is also a

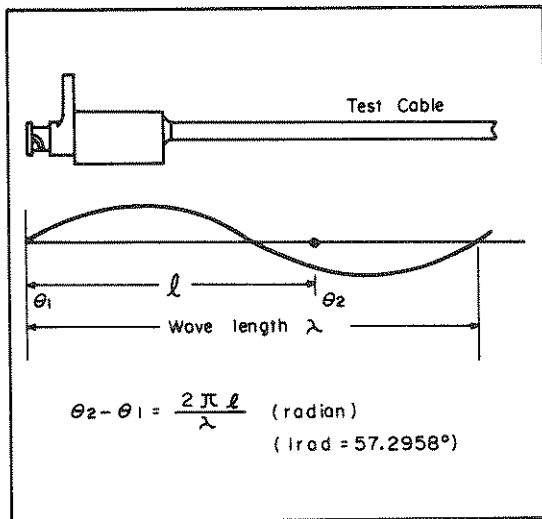
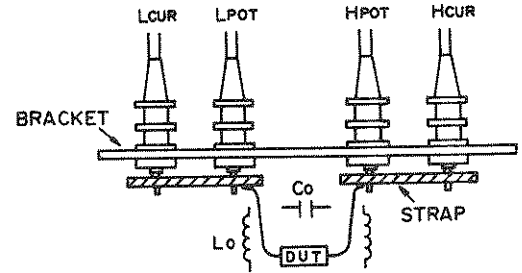

Figure 3-21. Test Signal Phase on Test Cables

factor in the propagation loss and phase shift (and of resultant measurement error), using different type test cables must be avoided. Be sure to use the standard test cables available from Hewlett-Packard.

3. To minimize incremental measurement errors at frequencies above 4MHz, convert four terminal pair to three terminal configuration at cable ends by connecting High and Low side cables, respectively, with low impedance straps as illustrated (do not extend cables of four terminal pair). The residual error factors, L_o and C_o , are shown in the figure.



3-79. ZERO Offset Adjustment

3-80. There is no perfect test fixture. They all have parasitic elements that affect measurement accuracy. This is also true of the measurement circuit. To minimize the effect these parasitic elements have on measurements, the 4192A is equipped with an automatic ZERO offset adjustment capability. Refer to Figure 3-30 for the ZERO offset procedure.

3-81. The 4192A measures $R \pm jX$ (impedance) in equivalent series circuit mode and $G \pm jB$ (admittance) in equivalent parallel circuit mode. All other impedance parameters are calculated from $R \pm jX$ or $G \pm jB$ (refer to paragraph 3-69). When one of the other impedance parameters is measured (after offset adjustment), compensation is made on the raw measurement data ($R \pm jX$ or $G \pm jB$) before conversion into the selected parameter.

(1) ZERO SHORT

All measurement errors are represented as two series residual parameters $R + jX$ as shown in Figure 3-22 and measured values are compensated with following equations.

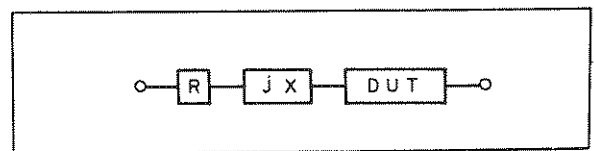

Figure 3-22. Residual Impedance

$$R_d = R_m - R_s$$

$$X_d = X_m - X_s$$

where R_d, X_d : Displayed values.
 R_m, X_m : Measured values.
 R_s, X_s : ZERO SHORT offset data

The 4192A calculates ZERO SHORT offset data at other frequencies using the ZERO SHORT offset data at a particular frequency as shown in

Table 3-18 and compensates measured values at other frequencies.

(2) ZERO OPEN

All measurement errors are represented as two parallel stray parameters, $G + jB$, as shown in Figure 3-23, and measured values are compensated with following equations.

Table 3-18. ZERO Offset Adjustments

| Measurement (Hz) | ZERO Offset Adjustments | |
|---|---|---|
| | SHORT | OPEN* |
| 5 ~ 500 | ZERO offset adjustment must be performed at each spot frequency. For example, offset adjustment at 5 Hz is not valid at 6 Hz. | |
| 500 ~ 100k | ZERO SHORT offset at 100kHz is valid for all frequencies from 500Hz to 100kHz. | ZERO OPEN offset data is automatically recalculated for each frequency within a given frequency range if ZERO OPEN offset is performed at 1 MHz. The equations used for this are as follows: |
| 100k ~ 1M | <p>ZERO SHORT offset data is automatically recalculated for each frequency within a given frequency range if ZERO SHORT offset is performed at the maximum frequency of that range. The equations used for this are as follows:</p> $R_c = R_s \times \frac{1 \times \sqrt{F_m}}{1 \times \sqrt{F_s}}$ $X_c = X_s \times \frac{F_m}{F_s}$ $R_D = R_m - R_c \quad X_D = X_m - X_c$ | $G_c = G_o$ $B_c = B_o \times \frac{F_m}{F_o}$ $G_D = G_m - G_c \quad B_D = B_m - B_c$ |
| 1M ~ 10M | | ZERO OPEN offset data is automatically recalculated for each frequency within a given frequency range if ZERO OPEN offset is performed at the maximum frequency of that range. The equations used for this are the same as those used in the 500Hz to 1MHz range. |
| 10M ~ 13M | ZERO SHORT offset data is automatically recalculated for each frequency within a given frequency range if ZERO SHORT offset is performed at 10MHz. The equations used for this are the same as those used in the 100kHz to 10MHz range. | ZERO OPEN offset data is automatically recalculated for each frequency within a given frequency range if ZERO OPEN offset is performed at 10MHz. The equations used for this are the same as those used in the 500Hz to 1MHz range. |
| <p>F_m : Measuring frequency (MHz) F_s : Frequency at which ZERO SHORT offset adjustment is performed (MHz). F_o : Frequency at which ZERO OPEN offset adjustment is performed (MHz). R_c, X_c, G_c, B_c : Recalculated offset data R_s, X_s : ZERO SHORT offset data G_o, B_o : ZERO OPEN offset data R_D, X_D, G_D, B_D : Displayed value of DUT R_m, X_m, G_m, B_m : Value measured by the 4192A includes offset error. * : The ZERO OPEN offset adjustment should be performed at each measuring frequency in measurements on grounded devices.</p> | | |

$$G_d = G_m - G_o$$

$$B_d = G_m - B_o$$

where G_d, B_d : Displayed Values.
 G_m, B_m : Measured Values.
 G_o, B_o : ZERO OPEN offset data

The 4192A calculates ZERO OPEN offset data at other frequencies using the ZERO OPEN offset data at a particular frequency as shown in Table 3-18 and compensates measured values at the other frequencies.

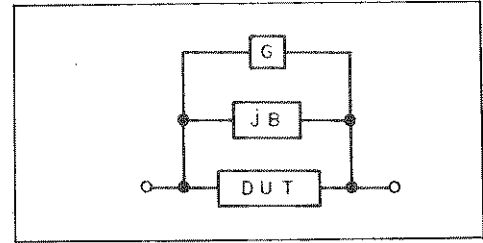

Figure 3-23. Stray Admittance

3-82. Actual Measurement Equivalent Circuit

3-83. The measuring circuit used to connect a test sample to the UNKNOWN terminals actually becomes part of the sample which the instrument measures. The four terminal pair configuration measurement employed in the 4192A offers minimum residual impedance in the measuring circuit. However, the four terminal pair measurement system must be converted to a two terminal configuration at/near to the sample because ordinary components have two terminal leads. Moreover, additional stray capacitance appears in the measuring circuit when a sample is connected to the test fixture. Figure 3-24 illustrates such stray capacitances present around the component leads.

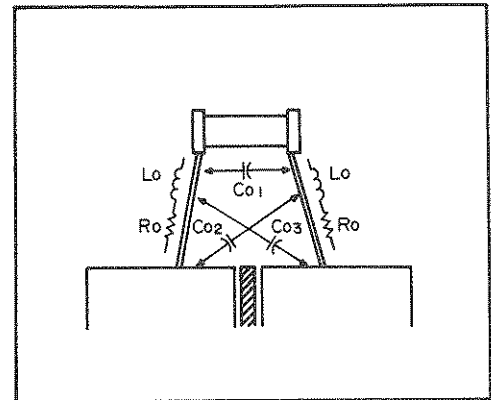

Figure 3-24. Parasitic Elements Incident to DUT Connections

3-84. Diverse parasitic elements existing in the measuring circuit between the unknown device and the measurement terminals will affect measurement results. These undesired parasitic elements are present as resistive and reactive factors in series and conductive and suscep-

tive factors in parallel with the test component. Figure 3-25 shows an equivalent circuit model of the measuring circuit which includes the parasitic elements (usually

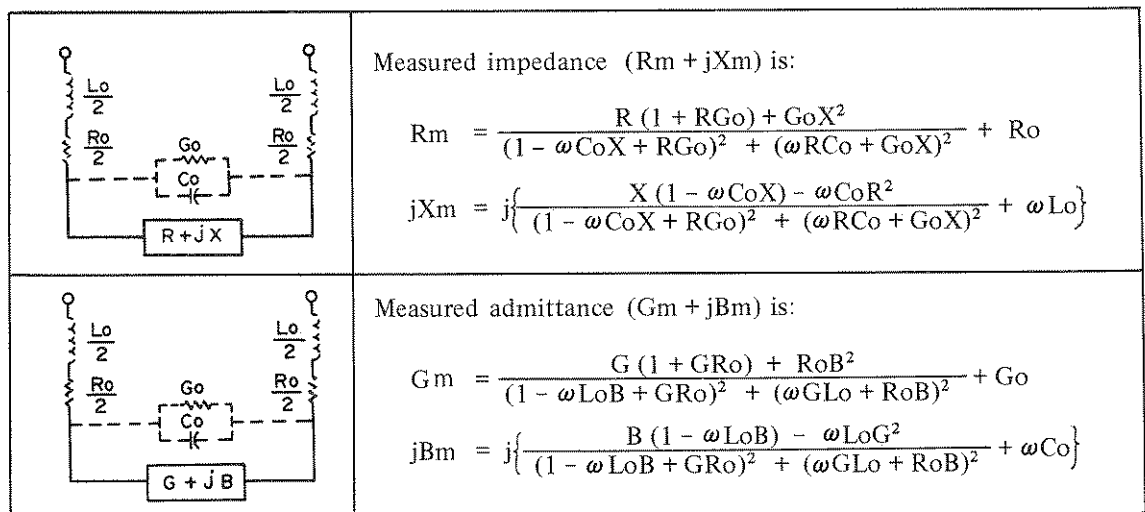

Figure 3-25. Equivalent Circuits Including Residual Impedance

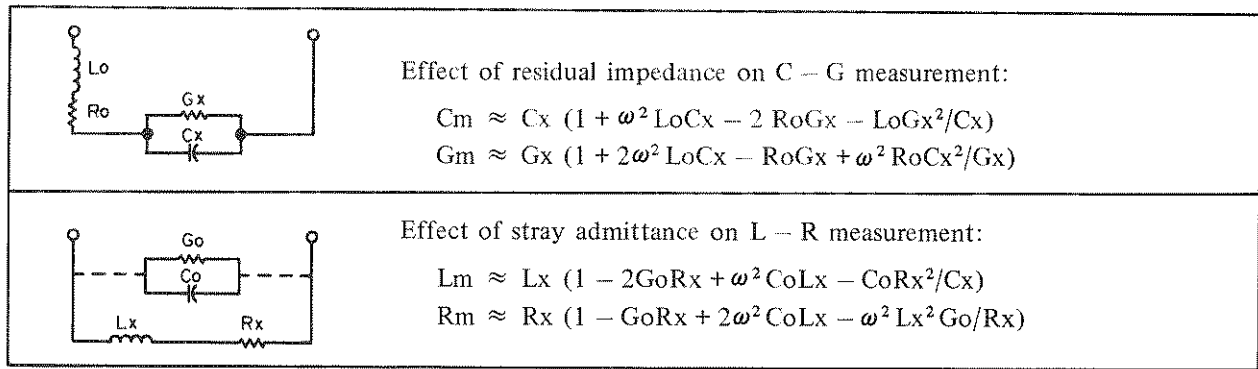

Figure 3-26. Effects of Residual Impedance

called residual parameters). In the equivalent measuring circuit (Figure 3-25), L_o represents residual inductances in test component leads, R_o is lead resistance. G_o is conductance between the leads, and C_o is the stray capacitance illustrated in Figure 3-24. Reactive factors in the residual impedance and susceptive factors in the stray admittance have a greater effect on measurement at higher frequencies.

test fixture used). This is because L_o and C_o are peculiar to the component being measured. Their values depend on component lead length and on the distance between the sample and test fixture. The measurement results, then, are substantially the sample values including the parasitic impedances present under the conditions necessary to connect and hold the sample.

3-85. Figure 3-26 shows the effect of residual impedance on C – G measurement and the effect of stray admittance on L – R measurement. Generally, L_o resonates with the capacitance of the sample (series resonance) and C_o resonates with the inductance of the sample (parallel resonance), respectively, at a specific high frequency. Thus, the impedance of the test sample will have a minimum value corresponding to resonant peaks, as shown in Figure 3-27. The presence of L_o and C_o causes measurement errors, as the phase of the test signal current varies over a broad frequency region around the resonant frequencies. Additional errors, due to the resonance, increase in proportion to the square of the measurement frequency (below resonant frequency) and can be theoretically approximated as follows:

$$C_{\text{ERROR}} \approx \omega^2 L_o C_x \cdot 100 (\%)$$

$$L_{\text{ERROR}} \approx \omega^2 C_o L_x \cdot 100 (\%)$$

where, $\omega = 2\pi f$ (f : test frequency)
 C_x = Capacitance value of sample.
 L_x = Inductance value of sample.

At low frequencies, L_o and C_o affect the measured inductance and capacitance values, respectively, as simple additive errors. These measurement errors cannot be fully eliminated by the ZERO offset adjustment (which permits compensating for residual factors inherent in the

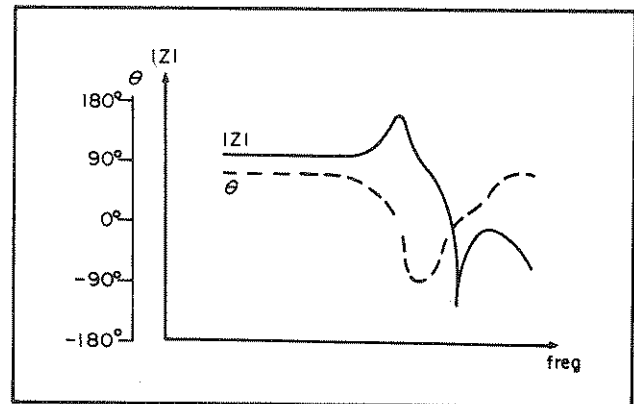

Figure 3-27. Effect of Resonance in Sample (Example)

3-86. Measured Values and Behavior of Components

3-87. Measured resistive and reactive (conductive or susceptive) parameter values of a component are not always close to their respective nominal values. In addition, certain electrical effects can cause the measurement to vary widely. Measured sample values include factors which vary such values because of electromagnetic effects such as the well-known skin effect of a conductor, the general characteristics of ferromagnetic inductor cores, and effects of dielectric materials in capacitors. Here, we'll discuss only the effects which result from the interaction of the reactive (susceptive) parameter elements (L, C, etc.) of a component.

3-88. The impedance of a component can be expressed in vector representation by a complex number as shown in Figure 3-28. In such representation, the effective resistance and effective reactance correspond to the projections of the impedance vector $|Z| < \theta$, that is, the real (R) axis and the imaginary (jX) axis, respectively.

When phase angle, θ , changes, both Re and X change in accordance with the definitions above. As component measurement parameters L, C, R, D, etc., are also representations of components related to the impedance

vector, phase angle, θ , dominates their values. Consider, for example, the inductance and the loss of an inductive component at frequencies around its self-resonant frequency. Figure 3-29 shows the equivalent circuit of the inductor. The inductance L_x resonates with the distributed capacitance C_o at frequency f_o . The phase angle (θ) of the impedance vector approaches 0 degrees (the vector approaches the R axis) when the operating frequency is close to the resonant frequency. Thus, the inductance of this component decreases while, on the other hand, the resistive factor (loss) increases. At the resonant frequency, f_o , this component is purely resistive. The effective resistance increases at resonance even if the inductor has (ideally) no resistance at dc. Consequently, the loss factor varies sharply at frequencies around the resonance point.

3-89. Measurement Time

3-90. Table 3-19 shows the measurement times for impedance measurements made with the 4192A.

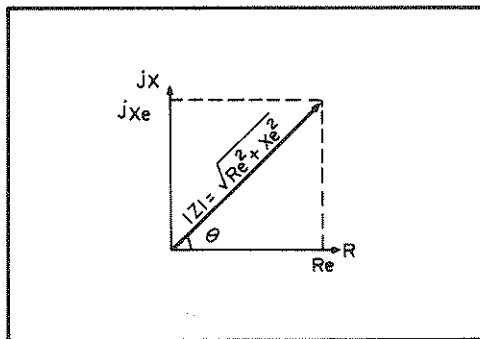

Figure 3-28. Impedance Vector Representation

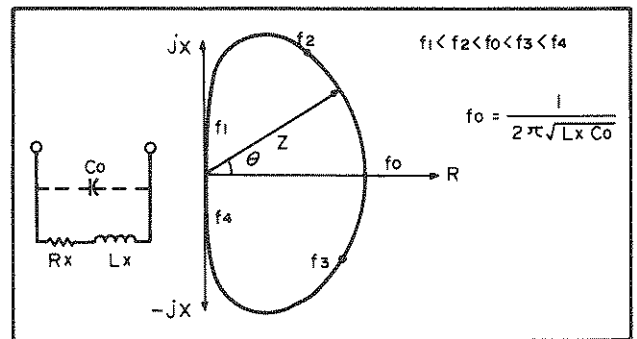

Figure 3-29. Typical Impedance Locus of an Inductor

Table 3-19. Measurement Time for Impedance Measurement

| Measurement Function | Measurement Mode | Measurement Frequency (Hz) | | | | |
|----------------------|------------------|--|--|-----------|-------------|-------------|
| | | 5 ~ 15 | 15 ~ 150 | 150 ~ 400 | 400 ~ 116k | 116k ~ 13M |
| Z / Y - θ | HIGH SPEED | $\frac{5000}{f} + 57.5 \sim \frac{5000}{f} + 71.5$ | | | 70 ~ 84 | 77 ~ 91 |
| | NORMAL | $\frac{5000}{f} + 59 \sim \frac{5000}{f} + 72$ | $\frac{15000}{f} + 59 \sim \frac{15000}{f} + 72$ | 159 ~ 172 | | 166 ~ 179 |
| | AVERAGE | $\frac{15000}{f} + 60 \sim \frac{15000}{f} + 73$ | | | 1060 ~ 1073 | |
| R/G - X/B | HIGH SPEED | $\frac{5000}{f} + 45.5$ | | | 58 | 65 |
| | NORMAL | $\frac{5000}{f} + 47$ | $\frac{15000}{f} + 47$ | 147 | | 154 |
| | AVERAGE | $\frac{15000}{f} + 48$ | 1048 | | | 1055 |
| L/C - D/Q/R/G | HIGH SPEED | $\frac{5000}{f} + 60.5 \sim \frac{5000}{f} + 64.5$ | | | 63 ~ 67 | 70 ~ 74 |
| | NORMAL | $\frac{5000}{f} + 52 \sim \frac{5000}{f} + 55$ | $\frac{15000}{f} + 52 \sim \frac{15000}{f} + 55$ | 152 ~ 155 | | 159 ~ 162 |
| | AVERAGE | $\frac{15000}{f} + 52 \sim \frac{15000}{f} + 55$ | 1052 ~ 1055 | | | 1059 ~ 1062 |
| Z / Y * | HIGH SPEED | $\frac{5000}{f} + 47.5$ | | | 60 | 67 |
| | NORMAL | $\frac{5000}{f} + 49$ | $\frac{15000}{f} + 49$ | 149 | | 156 |
| | AVERAGE | $\frac{15000}{f} + 50$ | 1050 | | | 1057 |
| R/X* | HIGH SPEED | $\frac{5000}{f} + 41.5$ | | | 54 | 61 |
| | NORMAL | $\frac{5000}{f} + 41$ | $\frac{15000}{f} + 41$ | 141 | | 148 |
| | AVERAGE | $\frac{15000}{f} + 43$ | 1043 | | | 1050 |
| L/C* | HIGH SPEED | $\frac{15000}{f} + 44.5$ | | | 57 | 64 |
| | NORMAL | $\frac{5000}{f} + 45$ | $\frac{15000}{f} + 45$ | 145 | | 152 |
| | AVERAGE | $\frac{15000}{f} + 46$ | 1046 | | | 1053 |

Measurement times are typical values in ms; f : measuring frequency (Hz).

* : Measurement times for |Z|/|Y|, R/X and L/C are times at single measurements by setting an internal switch (refer to paragraph 3-139).

3-95. Impedance Measurement Operating Instructions

3-96. Basic operating instructions for impedance measurements are given in Figure 3-30.

(1) Turn On and Test Fixture Connection

- a. Press the LINE ON/OFF key to turn the 4192A on.
- b. Following turn on, the instrument will perform the following operations in the order listed.
 - 1 Initial operational check is performed (refer to paragraph 3-7).
 - 2 HP-IB address, set by the HP-IB control switch on rear-panel (refer to paragraph 3-117), is displayed on DISPLAY A (e.g., H-17).
 - 3 Initial control setting is performed (refer to paragraph 3-9).
- c. Confirm that 4192A trigger lamp begins to flash.
- d. Press the BLUE key and then the SELF TEST key to check the basic operation of the instrument. Refer to paragraph 3-7 for details on the SELF TEST.







Note: The 4192A requires a one hour warm up time to satisfy all specifications listed in Table 1-1.

- e. Set the CABLE LENGTH switch to the 0 position.





Note: Set the CABLE LENGTH switch to appropriate position when other test fixtures are used. Guard terminal is sometimes used in high impedance measurements.

- f. Connect the 16047A Test Fixture to the UNKNOWN terminals.

(2) Setting Measurement Conditions

- a. Select the desired DISPLAY A parameter by pressing the  or  (up-down) key. The indicator lamp adjacent to the selected parameter will come on (refer to paragraph 3-69).
- b. Select the desired DISPLAY B parameter (compatible with the DISPLAY A parameter selected in step a) by pressing the  key (refer to paragraph 3-69).
- c. Select the desired equivalent circuit mode, series () or parallel (), by pressing CIRCUIT MODE keys for selected DISPLAY A function (refer to paragraph 3-73).
- d. Select the desired ZY RANGE by pressing the  or  (up-down) key (refer to paragraph 3-71).
- e. Press SPOT FREQ key. Set the desired spot frequency (initial setting is 100kHz) with the DATA input keys (refer to paragraph 3-29) and press the appropriate ENTER key.

(Example) Spot frequency = 7.5MHz

Key strokes :     

The spot frequency setting, 7500.000 kHz, is displayed on DISPLAY C (Test Parameter Data Display).

Figure 3-30. Operating Instructions for Impedance Measurements (Sheet 1 of 3)

- f. Press the OSC LEVEL key. Set the desired measuring signal level (initial setting value is 1 V) with the DATA input keys (refer to paragraph 3-24) and press the appropriate ENTER key.

(Example) OSC level = 750mV

Key strokes : 

The OSC level setting, 0.750 V, is displayed on DISPLAY C.

(3) ZERO Offset Adjustments

Note: When the 16047B Test Fixture is used, close the protective cover to enable measurement. Closing the cover electrically connects the instrument's UNKNOWN terminals to the fixture; opening the cover disconnects the fixture from terminals.

- a. Insert a low impedance shorting-bar to the Test Fixture to short-circuit the UNKNOWN terminals to 0Ω (0H).
- b. Press the BLUE key and then the ZERO SHORT key. Indicator lamp will come on and R (resistance) and X (reactance) offset adjustments are automatically performed at the spot frequency displayed on DISPLAY C (refer to paragraph 3-79). CAL (calibration) is displayed on DISPLAY A and will remain until the offset adjustment is completed; a value of approximately zero will then be displayed.

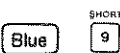
Key strokes : 

- c. Remove the shorting-bar from the test fixture.
- d. Set the circuit mode to 
- e. Press the BLUE key and the ZERO OPEN key. Indicator lamp will come on and G (conductance) and B (susceptance) offset adjustments are automatically performed at the spot measuring frequency displayed on DISPLAY C (refer to paragraph 3-79). CAL (calibration) is displayed on DISPLAY A and will remain until the offset adjustment is completed; a value of approximately zero will then be displayed.

Key strokes : 

(4) Connecting a DUT (Device Under Test)

- a. Connect a DUT to Test Fixture.

Note: To accurately set the test signal level, use the TEST LEVEL MONITOR key to monitor the actual test signal level applied to the DUT (voltage or current) (refer to paragraph 3-91). If necessary, reset OSC LEVEL at step (3)-(f).

- b. The 4192A will automatically display the measured values of the DUT in accordance with the measurement conditions.

Figure 3-30. Operating Instructions for Impedance Measurements (Sheet 2 of 3)

3-91. Test Signal Level Monitor

3-92. The 4192A can measure the actual test signal voltage (V) across the DUT or test signal current (mA) through the DUT by using TEST LEVEL MONITOR key. The measured value is displayed on the Test Parameter Data Display.

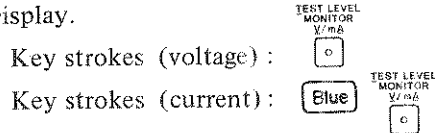

Accuracy for the test signal voltage and current is given in Table 3-20. The accuracies listed in the table are not specifications; they are typical values. The read out of test signal voltage will normally be close to the setting of the OSC LEVEL. However, when a low impedance com-

ponent (less than approximately 1kΩ) is connected to the UNKNOWN terminals as a DUT, the test signal voltage decreases because of internal loading. Actual test signal voltage is, thus, lower than the OSC LEVEL setting. The displayed value, nevertheless, is the correct voltage/current readout for the test signal level actually being used in the measurement.

When test cables are used in high frequency measurements, accuracy of the displayed test voltage is reduced. This is because the propagation loss in the test cables decreases the level of the test signal applied to the sample. The typical accuracies at frequencies above 1MHz, given in Table 3-20, apply only when a direct attachment type test fixture is used.

Table 3-20. Test Signal Level Monitor Accuracy

| Measurement Mode | Measurement Range | Resolution | Measuring Frequency | Accuracy* |
|------------------|-------------------|------------|---------------------|------------------------------------|
| Voltage | 5 mV ~ 1.1V | 1 mV | ≤ 100Hz | ± ((4 + 10/f) % of reading + 1 mV) |
| | | | 100Hz ~ 1MHz | ± (4% of reading + 1 mV) |
| | | | ≥ 1 MHz | ± ((4 + 0.8F) % of reading + 1 mV) |
| Current | 1 μA ~ 11 mV | 1 μA | ≤ 100Hz | ± ((4 + 10/f) % of reading + 1 μA) |
| | | | 100Hz ~ 1MHz | ± (4% of reading + 1 μA) |
| | | | ≥ 1 MHz | ± ((4 + 0.8F) % of reading + 1 μA) |

* : at 23°C ± 5°C, f : measuring frequency (Hz), F : measuring frequency (MHz).

3-93. Characteristics of Test Fixtures

3-94. Characteristics and applicable measurement ranges of HP test fixtures and test leads for the 4192A are summarized in Table 3-21. To facilitate measurement and to minimize measurement errors, a test fixture appropriate for the measurement should be chosen from among HP's standard accessories. Select the test fixture or leads that have the desired performance characteristics.

Table 3-21. Typical Characteristics of Test Fixtures and Leads

| Model No. | Residual Parameter Value | % of Reading Error (All Parameters)*1 | Offset Value in D |
|---|--|---|---|
| 16047A | / | $\pm 5 \times \left(\frac{f}{10}\right)^2 \%$ | $\pm 0.02 \times \left(\frac{f}{10}\right)^2$ |
| 16047B*2 | | / | |
| 16047C | | $\pm 1 \times \left(\frac{f}{10}\right)^2 \%$ | $\pm 0.01 \times \left(\frac{f}{10}\right)^2$ |
| 16048A | | $\pm 5 \times \left(\frac{f}{10}\right)^2 \%$ | $\pm 0.02 \times \left(\frac{f}{10}\right)^2$ |
| 16048B | | | |
| 16048C*3 | C < 5pF, L < 200nH, R < 10mΩ | / | |
| 16034B*4 | C < 0.02pF, L < 30 nH, R < 30mΩ | $\pm 5 \times \left(\frac{f}{10}\right)^2 \%$ | $\pm 0.02 \times \left(\frac{f}{10}\right)^2$ |
| 16095A*5 | C ≤ 15pF, L ≤ 40 nH, R ≤ 100mΩ | / | |
| 16096A*6 | C ≤ 0.01pF, L ≤ (100 + 0.5f ²) nH, R ≤ (50 + 5f ²) mΩ | | |
| f : frequency (MHz) *1 : The incremental errors calculated from the equations in the table for measurements at frequencies above 1 MHz are additive. *2 : The 16047B is useable only at frequencies below 2 MHz. *3 : The 16048C is useable with C (> 1000pF) and L (> 100μH) DUT's at frequencies below 100kHz. *4 : The 16034B is useable for measurements on high impedance DUT's (Z > 50Ω). *5 : When BNC adapter is used. *6 : At BNC connector after zero offset. | | | |

CAUTIONS

- 1) Do not apply voltage to the L_{CUR} or L_{POT} terminals. To do so may damage the instrument.
- 2) The 4192A can be used to measure charged capacitors; however, charge voltage is limited. If the limit is exceeded, i.e., if the charge voltage is too high, the instrument may be damaged. The limit depends on whether the 4192A's internal dc bias source is ON or OFF and the capacitance of the capacitor being measured. Refer to the graph below. Also, when the bias source is ON, output voltage should be set to 0V.
- 3) When making impedance measurements on an active circuit (e.g., voltage source, battery, etc.), DO NOT allow a dc voltage exceeding ±10V to be applied to the H_{CUR} terminal. To do so may damage the instrument. Also, in these measurements, the 4192A becomes part of the load (parallel) on the dc voltage present in the circuit under test. Refer to the table below. When the dc bias voltage of the circuit is higher than ±10V, connect a 2.2μF (or less) capacitor in series with the H_{CUR} terminal to block the dc bias voltage. If a suitable capacitor is not available from conventional sources, order HP Part No.: 0160-0128; 2.2μF, 50V.

The 16095A Probe Fixture is equipped with this blocking capacitor; the 16096A, however, is not. When the 16096A is used, connect the blocking capacitor to the SHORT/EXTERNAL CAP terminals instead of the short-connector. With the blocking capacitor connected, the output impedance of the test signal source is increased and, thus, the signal level is reduced. Consequently, accurate impedance measurements on active circuits are possible only above a specified frequency for a given |Z| range. Refer to the graph below. For example, if the impedance of the DUT is 9kΩ, the 4192A automatically selects the 10kΩ range. On this range, with the 2.2μF capacitor connected, the lowest useable frequency is approximately 80Hz. At frequencies below 80Hz, accuracy of measurement results decreases. For measurements at lower frequencies, a higher value blocking capacitor must be used. To measure the 9kΩ DUT mentioned above at 10Hz, for example, a blocking capacitor of approximately 12μF must be used.

To change the value of the blocking capacitor in the 16095A, an external capacitor must be connected to the EXT CAPACITOR terminals. The value of this capacitor must be equal to the desired blocking capacitor value (determined from the graph) minus 2.2μF (the value of the blocking capacitor in the 16095A). When the value of the blocking capacitor is higher than 2.2μF, the maximum allowable dc bias voltage is ±10V. NEVER apply a dc voltage exceeding ±35V to the H_{CUR} terminal.

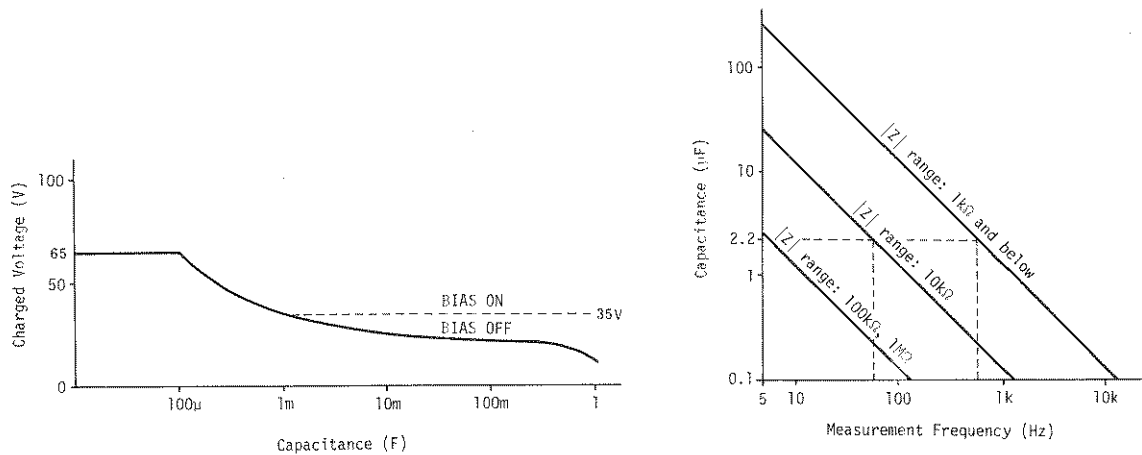

| Measurement Frequency | @ < 38kHz | | | @ ≥ 38kHz | |
|-----------------------|-----------|------|---------|-----------|--------|
| | ≤ 1kΩ | 10kΩ | ≥ 100kΩ | ≤ 1kΩ | ≥ 10kΩ |
| DC Load | 140Ω | 980Ω | 8.4kΩ | 140Ω | 160Ω |

Figure 3-30. Operating Instructions for Impedance Measurements (Sheet 3 of 3)

3-97. Swept Frequency Measurements

3-98. Basic operating instructions for swept-frequency impedance measurements are given in Figure 3-31.

Notes: 1. Before proceeding with the procedure given below, set the 4192A's controls as necessary for an impedance measurement. Refer to Figure 3-30.

2. The 4192A has a ZERO offset adjustment function to eliminate the residual impedance and stray admittance of the test fixture and test leads. ZERO offset adjustment should be performed at each spot (measuring) frequency. However, the 4192A calculates ZERO offset data (SHORT and OPEN) at other frequencies using the ZERO offset data taken at a particular frequency as shown in Table 3-18 and compensates measured values at other frequencies. When a swept-frequency measurement is performed, ZERO offset adjustment should be performed at the appropriate frequency in accordance with Table 3-18. In this procedure (Example START FREQ = 100kHz and STOP FREQ = 1MHz), ZERO offset adjustment (SHORT and OPEN) should be performed at 1MHz.

(1) Setting Sweep Parameters

- a. Press the START FREQ key. Set the start (lower limit) frequency (initial setting value is 5Hz) of the desired sweep frequency range with the DATA input keys (refer to paragraph 3-24) and press the appropriate ENTER key.



(Example) Start frequency = 100kHz

Key strokes :    

The start frequency setting, 100.0000kHz, is displayed on DISPLAY C (Test Parameter Data Display).

- b. Press the STOP FREQ key. Set the stop (upper limit) frequency (initial setting is 13MHz) of the desired sweep frequency range with the DATA input keys (refer to paragraph 3-24) and press the appropriate ENTER key.

(Example) Stop frequency = 1 MHz



Key strokes :   

The stop frequency setting, 1000.000kHz, is displayed on DISPLAY C.

Note: The stop frequency should be higher than the start frequency. If not, error-code E-03 will be displayed on DISPLAY C when swept measurement is attempted and measurement will be not performed.

- c. Press the STEP FREQ key. Set the desired step frequency (initial setting is 1kHz) with the DATA input keys (refer to paragraph 3-24) and press the appropriate ENTER key.

(Example) Step frequency = 1 kHz

Key strokes :   

The step frequency setting, 1.000000kHz, is displayed on DISPLAY C.

Figure 3-31. Operating Instructions for Swept-Frequency Impedance Measurements (Sheet 1 of 3)

Note: In LOG SWEEP measurement applications, STEP FREQ. has no meaning. To set the instrument to logarithmic sweep mode, press the BLUE key and the LOG SWEEP key; the indicator lamp will come on. In this mode, automatic or manual sweeps are made at twenty frequency steps per decade. Each step is calculated from the following formula:

$$F \times 10^{0.05N}$$

where F is the start frequency (5Hz, 10Hz, 100Hz, 1kHz, 10kHz, 100kHz, 1MHz, or 10MHz) and N is an integer that represents the step number. For example, if the start frequency is 100kHz and the stop frequency is 1MHz, the sweep will be as follows:

| | | | | | | | |
|---|-------------|----|-------------|----|-------------|----|-------------|
| 1 | 112.2018kHz | 6 | 199.5262kHz | 11 | 354.8133kHz | 16 | 630.9573kHz |
| 2 | 125.8925kHz | 7 | 223.8721kHz | 12 | 398.1071kHz | 17 | 707.9457kHz |
| 3 | 141.2537kHz | 8 | 251.1886kHz | 13 | 446.6835kHz | 18 | 794.3282kHz |
| 4 | 158.4893kHz | 9 | 281.8382kHz | 14 | 501.1872kHz | 19 | 891.2509kHz |
| 5 | 177.8279kHz | 10 | 316.2277kHz | 15 | 562.3413kHz | 20 | 1000.000kHz |

The start and stop frequencies, which determine the sweep range, are limited to decade values (10, 100 k, 10k, 100k, 1M, 10M). If, for example, the start frequency is set to 50kHz and the stop frequency is set to 800kHz, the instrument automatically sets the sweep range to 10kHz to 1MHz. There are, however, two exceptions to this: (1) when the start frequency is set to a value below 10Hz and (2) when the stop frequency is set to a value above 10MHz. In such cases, the instrument automatically assumes a start frequency of 5Hz and a stop frequency of 13MHz, respectively.

(2) Manual Sweep

In manual sweeps, the sweep begins at the spot frequency and the sweep range is determined by the start and stop frequencies.

- a. Set the desired spot frequency (initial setting is 100kHz) with the DATA input keys (refer to paragraph 3-24) and press the appropriate ENTER key.

(Example) Spot frequency = 100kHz

Key strokes : SPOT 1 0 0 KHz mv

The spot frequency, 100.0000kHz, is displayed on DISPLAY C.

- b. Press the STEP UP ↑ key or STEP DOWN ↓ key to shift the frequency one step (determined by the step frequency setting) in the indicated direction.



Notes: 1. In logarithmic sweep mode, the measurement frequency is automatically shifted to the nearest frequency that satisfies the equation $F \times 10^{0.05N} = F_m$; where F is the start frequency, F_m is the measurement frequency, and N is an integer that represents the step number.

2. If the spot frequency is higher than the stop frequency or less than the start frequency, error-cord E-04 will be displayed on DISPLAY C and the measurement will not be performed.



- c. Pressing and holding the STEP UP (↑) key or STEP DOWN (↓) key continuously advances swept frequency measurement.
- d. When X10 STEP key is pressed simultaneously with the STEP UP (↑) or STEP DOWN (↓) key, the step frequency is increased by a factor of ten. (This is for linear sweeps only.)



Figure 3-31. Operating Instructions for Swept-Frequency Impedance Measurements (Sheet 2 of 3)

(3) Auto Sweep

- a. Press MAN/AUTO key to set to auto sweep mode (indicator lamp comes on).
- b. 1 Pressing the START UP () key starts the frequency sweep from the programmed start frequency. The frequency sweep ends at the stop frequency.
2 Pressing the START DOWN () key starts the frequency sweep from the stop frequency. The frequency sweep ends at the start frequency.

Note: 1) Swept test frequency is displayed on DISPLAY C.
2) ZY RANGE is automatically set to AUTO when auto sweep is started.

- c. To temporarily stop a swept frequency measurement, press the PAUSE key. Start frequency, stop frequency, step frequency, sweep direction, and sweep mode (linear or logarithmic, auto or manual) can be changed when the PAUSE function is set. To restart the sweep, press the START UP () key or START DOWN () key.
- d. AUTO sweep measurement mode is automatically released when the swept measurement ends (reaches the stop frequency or start frequency). To stop the sweep before the measurement is completed, press blue key and then press the SWEEP ABORT key.



Key Strokes :  

To return to normal spot frequency measurement, press the SWEEP AUTO key (indicator lamp goes off).

- Notes:
- 1) When a swept frequency measurement is made, if the sweep comes to a frequency band which has lower frequency resolution than the STEP FREQ., this STEP FREQ. automatically changes to the higher resolution frequency, and the sweep is continued.
 - 2) When the swept frequency crosses 38kHz, an additional 50msec is required for measurement circuit stabilization.

Figure 3-31. Operating Instructions for Swept-Frequency Impedance Measurements (Sheet 3 of 3)

3-99. Swept OSC Level Measurements

3-100. The OSC level can be manually swept in 1 mVrms (5 mVrms at 100mVS) steps by pressing the STEP UP () key or STEP DOWN () key. In impedance measurements, the OSC level can be swept while monitoring the actual test signal voltage across- or the current through the device under test (DUT) using the TEST LEVEL MONITOR function (refer to paragraph 3-91). Therefore, accurate test signal level characteristics of the DUT can be obtained easily.

3-101. Internal DC Bias Supply

3-102. The 4192A is equipped with an internal, programmable dc bias supply controllable from 0.00V to $\pm 35.00V$ (for impedance measurements only). This provides step bias voltage control in 10mV increments over the entire controllable range as well as providing an accurate voltage setting capability ($\pm 0.5\%$ of setting +5mV) to facilitate up-to-date use in applications requiring precision bias voltage control such as analysis of material properties and semiconductor testing. The bias can be programmed and bias parameters memorized, further enhancing utility of the internal bias supply. Operating instructions on measurements using the internal dc bias supply are provided in Figure 3-32.

Notes: 1. Before proceeding with the procedure given below, set the 4192A's controls for an impedance measurement. Refer to Figure 3-30.

2. Test frequency can be swept while using the internal dc bias set to desired (spot) voltage.

To apply a stationary (fixed) bias voltage to the sample, set the desired bias voltage using the following procedure:

- (1) Press the BLUE key and SPOT BIAS key. Set the desired spot bias voltage (initial setting is 0V) with the DATA input keys (refer to paragraph 3-29) and press the appropriate ENTER key.

(Example) Spot bias voltage = - 3.5 V

Key strokes : Blue SPOT
FBCH/BIAS - 3 . 5 MHz V

The spot bias voltage setting, -3.50V, is displayed on DISPLAY C (Test Parameter Data Display).

Note: The internal dc bias voltage is applied to the sample just after the bias voltage value is set by the front-panel control keys (requires no trigger signal).

WARNING

WHEN THE INTERNAL DC BIAS VOLTAGE IS APPLIED TO THE SAMPLE, THE "BIAS-ON" INDICATOR COMES ON. WHILE THE BIAS ON INDICATOR IS ON, REMEMBER THAT THE 4192A IS OUTPUTTING A DC BIAS VOLTAGE FROM THE UNKNOWN TERMINALS, EVEN IF DISPLAY C IS NOT DISPLAYING THE BIAS VOLTAGE.

- (2) Press the BLUE key and the BIAS OFF key to stop output of the internal dc bias voltage. The BIAS ON indicator lamp will go off.

Key strokes : Blue BIAS
OFF 7

WARNING

WHEN A DC BIAS VOLTAGE EXCEEDING ±5V IS BEING OUTPUT AND THE BIAS OFF KEY IS PRESSED, THE BIAS ON INDICATOR LAMP GOES OFF BUT THE OUTPUT VOLTAGE DOES NOT IMMEDIATELY RETURN TO 0V. IT DECREASES LINEARLY (as shown graphically below) UNTIL IT REACHES ±5V. THE TRANSITION FROM ±5V TO 0V IS INSTANTANEOUS. THE DISCHARGE TIME IS CALCULATED AS FOLLOWS:

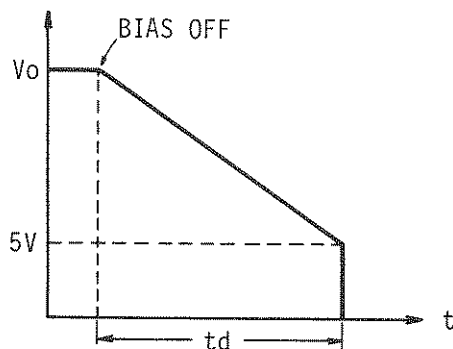

$$t_d = \frac{(|V_o| - 5) \times C_x}{I_d} \text{ (s)}$$

Where, t_d : Discharge Time (s)
 V_o : Output Voltage (V)
 C_x : DUT's Capacitance (F)
 I_d : Discharge Current (0.025A constant)

(ex.) $V_o = 35V, C_x = 1mF$

$$t_d = \frac{30 \times 0.001}{0.025} = 1.2 \text{ (s)}$$

Figure 3-32. Operating Instructions for Internal DC Bias Supply

3-103. Swept Bias Voltage Measurements

3-104. Basic operating instructions for swept-bias voltage impedance measurements are given in Figure 3-33.

Note: Before proceeding with the procedure given below, set the 4192A's controls as necessary for an impedance measurement. Refer to Figure 3-30.

(1) Setting Sweep Parameters

- a. Press the BLUE key and START BIAS key. Set the start (lower limit) voltage (initial setting is $-35V$) of the desired sweep bias voltage range with the DATA input keys (refer to paragraph 3-24) and press the appropriate ENTER key.

(Example) Start bias voltage = $-5V$

Key strokes : 

The start bias voltage setting, $-5.00V$, is displayed on DISPLAY C (Test Parameter Data Display).

- b. Press the BLUE key and STOP BIAS key. Set the stop (upper limit) voltage (initial setting is $35V$) of the desired sweep bias voltage range with the DATA input keys (refer to paragraph 3-24) and press the appropriate ENTER key.

(Example) Stop bias voltage = $8.5V$

Key strokes : 

The stop bias voltage setting, $8.50V$, is displayed on DISPLAY C.

Note: The stop bias voltage should be higher than the start bias voltage. If not, error-code E-03 will be displayed on DISPLAY C when swept measurement is attempted and measurement will be not performed.

- c. Press the BLUE key and STEP BIAS key. Set the desired step bias voltage (initial setting is $1V$) with the DATA input keys (refer to paragraph 3-24) and press the appropriate ENTER key.

(Example) Step bias voltage = $0.1V$

Key strokes : 

The step bias voltage setting, $0.10V$, is displayed on DISPLAY C.

Note: The LOG SWEEP cannot be performed for swept bias voltage measurements.

(2) Manual Sweep

In manual sweeps, the sweep begins at the spot bias voltage and the sweep range is determined by the start and stop bias voltages.

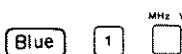

- a. Set the desired spot bias voltage (initial setting is $0V$) with the DATA input keys (refer to paragraph 3-24) and press the appropriate ENTER key.

(Example) Spot bias voltage = $1V$





Key strokes : 

The spot bias voltage, $1.00V$, is displayed on DISPLAY C.



Figure 3-33. Operating instructions for Swept Bias Voltage Impedance Measurements (Sheet 1 of 2)

- b. Press the STEP UP  key or STEP DOWN  key to shift the bias voltage one step (determined by the step bias voltage setting) in the indicated direction.



Note: If the spot bias voltage is higher than the stop bias voltage or less than the start bias voltage, error-code E-04 will be displayed on DISPLAY C and the measurement will not be performed.



- c. Pressing and holding the STEP UP () key or STEP DOWN () key continuously advances swept bias voltage measurement.
- d. When X10 STEP key is pressed simultaneously with the STEP UP () or STEP DOWN () key, the step bias voltage is increased by a factor of ten. (This is for linear sweeps only.)

(3) Auto Sweep

- a. Press MAN/AUTO key to set to auto sweep mode (indicator lamp comes on).
- b. ① Pressing the START UP () key starts the bias voltage sweep from the programmed start bias voltage. The bias voltage sweep ends at the stop bias voltage.
- ② Pressing the START DOWN () key starts the bias voltage sweep from the stop bias voltage. The bias voltage sweep ends at the start bias voltage.

Note: Swept bias voltage is displayed on DISPLAY C.

- c. To temporarily stop a swept bias voltage measurement, press the PAUSE key. Start bias voltage, stop bias voltage, step bias voltage, sweep direction, and sweep mode (linear or logarithmic, auto or manual) can be changed when the PAUSE function is set. To restart the sweep, press the START UP () key or START DOWN () key.
- d. AUTO sweep measurement mode is automatically released when the swept measurement ends (reaches the stop bias voltage or start bias voltage). To stop the sweep before the measurement is completed, press BLUE key and then press the SWEEP ABORT key.

Key strokes :  

To return to normal spot bias voltage measurement, press the SWEEP AUTO key (indicator lamp goes off).

Figure 3-33. Operating Instructions for Swept-Bias Voltage Impedance Measurements (Sheet 2 of 2)

3-105. Measurement of Grounded Devices

3-106. The unique measuring circuitry of the 4192A provides direct, accurate impedance measurements of not only floated and but also grounded devices. Such measurement conditions are, for example, the distributed capacitance measurement of a coaxial cable with a grounded shield conductor or the input/output impedance measurement of a single ended amplifier. Low grounded measurement accuracy is unspecified, but typical measurement accuracy is provided in Table 1-21.

3-107. External DC Bias

3-108. The special biasing circuits and procedures for using external voltage or current bias, as needed for capacitance or inductance measurements, are provided in Figure 3-34. The figure shows sample circuits appropriate for 4192A applications. The biasing circuits prevent dc current from flowing into the 4192A, as dc current increases the measurement error and because the excess current may damage instrument. When applying a dc voltage to capacitors, be sure the applied voltage does not exceed the maximum specified voltage of the capacitor and that the capacitor is connected with correct polarity.

(1) External DC Bias Voltage ($\leq 200V$)

- a. Press the LINE ON/OFF key to turn the 4192A off.
- b. Connect the external dc bias source to the 4192A as shown in the figure below:

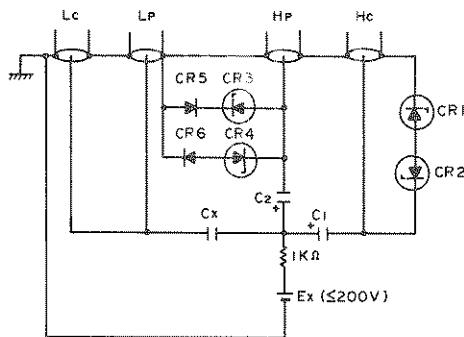

Figure A. Floating Measurement

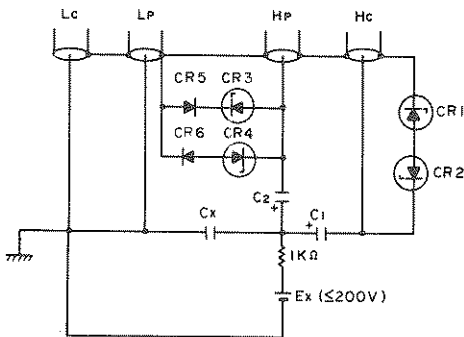

Figure B. Low-grounded Measurement

- where C_x : Sample capacitor
 E_x : External dc bias voltage ($\leq 200V$)
 C_1 : Blocking capacitor
 Capacitance Value :

$$C_1 \geq \frac{1}{10\pi \cdot f}$$
 (f : measuring frequency (Hz))
 DC Withstand Voltage : $> E_x$.
 C_2 : Blocking capacitor
 Capacitance Value : $1\mu F$
 DC Withstand Voltage : $> E_x$.

- CR_1, CR_2 : HP Part No. : 1902-0176
 Diode-Zener, 47V5%, 1W
 CR_3, CR_4 : HP Part No. : 1902-1299
 Diode-Zener, 33V5%, 1W
 CR_5, CR_6 : HP Part No. : 1901-0646
 Diode-Zener, 3.3V5%, 1W

- Cautions:**
1. Never apply an external dc bias voltage of over 200V and never connect the H_{POT} terminal to the L_{CUR} or L_{POT} terminal. To do so may damage instrument. Make sure that the sample capacitor is not defective.
 2. When a positive bias voltage is used, positive poles of electrolytic capacitors (C_x , C_1 , and C_2) must be connected to the positive (+) terminal of the external dc bias source as shown in the figures above. A negative bias voltage can also be applied. In this arrangement, the negative poles of C_x , C_1 , and C_2 must be connected to the negative (-) terminal of the external dc bias source.

Note: Ripple or noise on external dc bias source should be as low as possible.

- c. Set the 4192A's controls as necessary for an impedance measurement. Refer to Figure 3-30, but following settings should be made.

DISPLAY A Function C
 BIAS OFF
 CIRCUIT MODE

- d. Apply desired dc bias voltage to the sample capacitor with the external dc bias source.
- e. Read the capacitance value – on DISPLAY A – after allowing time for bias voltage to settle.

Figure 3-34. External DC Voltage Supply (Sheet 1 of 2)

(2) External DC Bias Current

- a. Press the LINE ON/OFF key to turn the 4192A off.
- b. Connect the external dc bias source to the 4192A as shown in the figure below:

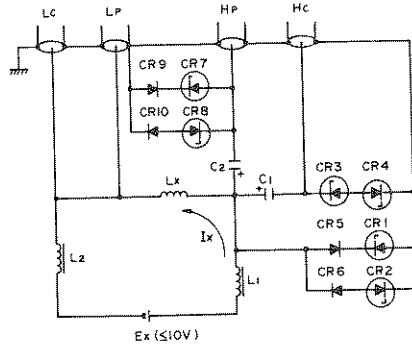

Figure C. Floating Measurement

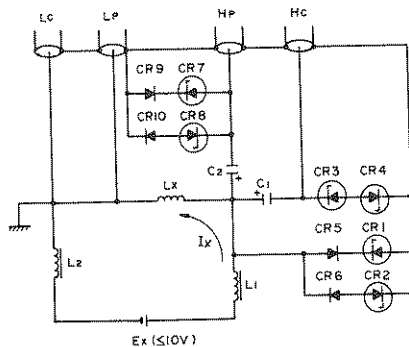

Figure D. Low-grounded Measurement

where Lx : Sample inductor
L1 : (50 ~ 250) × Lx
L2 : ≈ L1

Ex : External dc bias voltage (≤ 10V)
Ix : External dc bias current
Current Value:

$$I_x = \frac{E_x}{\text{Output Resistance of } E_x + \text{ESR of } L_1 + \text{ESR of } L_2}$$

C1 : Blocking capacitor

Capacitance Value :

$$C_1 \geq \frac{1}{10\pi \cdot f} \text{ (f : measuring frequency (Hz))}$$

DC Withstand Voltage : > Ex.

C2 : Blocking capacitor

Capacitance Value : 1μF

DC Withstand Voltage : > Ex.

- CR1, CR2 : HP Part No. : 1902-0202 Diode-Zener, 15V5%, 1W
- CR3, CR4 : HP Part No. : 1902-0176 Diode-Zener, 47V5%, 1W
- CR5, CR6 : HP Part No. : 1901-0646 Diode-Power, 200V, 1A
- CR7, CR8 : HP Part No. : 1902-1299 Diode Zener, 3.3V5%, 1W
- CR9, CR10 : HP Part No. : 1901-0646 Diode-Power, 200V, 1A

CAUTION

NEVER apply an external dc bias current of over 1A and NEVER remove the DUT when a dc current of over 25mA is flowing. To do so may damage the instrument.

- c. Set the 4192A's controls as necessary for an impedance measurement. Refer to Figure 3-30, but following settings should be made.

DISPLAY A Function L
BIAS OFF

- d. Apply desired dc bias current to the sample inductor with external dc bias source.
- e. Read the inductance value — on DISPLAY A — after allowing time for bias voltage to settle.

Figure 3-34. External DC Voltage Supply (Sheet 2 of 2)

3-109. HP-IB INTERFACE

3-110. The 4192A can be remotely controlled via the HP-IB, a carefully defined instrument interface which simplifies integration of instruments and a calculator or computer into a system.

Note: HP-IB is Hewlett-Packard's implementation of IEEE Std. 488, Standard Digital Interface for Programmable Instrumentation.

3-111. Connection to HP-IB

3-112. The 4192A can be connected into an HP-IB bus configuration with or without a controller (i.e., with or without an HP calculator). In an HP-IB system without a controller, the instrument functions as a "talk only" device (refer to paragraph 3-117.)

3-113. HP-IB Status Indicators

3-114. The HP-IB Status Indicators are four LED lamps located on the front panel. When lit, these lamps show the existing status of the 4192A in the HP-IB system as follows:

- SRQ: SRQ signal from the 4192A to the controller is on the HP-IB line. Refer to paragraph 3-127.
- LISTEN: The 4192A is set to listener.
- TALK: The 4192A is set to talker.
- REMOTE: The 4192A is remotely controlled.

3-115. LOCAL Key

3-116. The LOCAL key releases the 4192A from HP-IB remote control and allows measurement conditions to be set from the front-panel. The REMOTE lamp will go off when this key is pressed. LOCAL control is not available when the 4192A is set to "local lockout" status by the controller.

3-117. HP-IB Control Switch

3-118. The HP-IB Control Switch, located on the rear panel, has seven bit switches as shown in Figure 3-35. Each bit switch has two settings: logical 0 (down position) and logical 1 (up position).

The left-most bit switch, bit 7, determines whether the instrument will be addressed by the controller in a multi-device system, or will function as a "talk only" device to output measurement data and/or instructions to an external "listener" e.g., printer. When bit switch

7 is set to 0, the instrument is in ADDRESSABLE mode and bit switches 1 through 5 determine the instrument address; when this bit switch is set to 1, the instrument is in TALK ONLY mode.

Bit switch 6 determines the output data delimiter. When this bit switch is set to 0, the delimiter is a comma (,); when set to 1, the delimiter is a carriage return and line feed (CR/LF). Refer to Figure 3-36 for the function of each delimiter.

Bit switches 1 through 5 are used to set the HP-IB address, in binary, of the 4192A when bit switch 7 is set to ADDRESSABLE.

Note: The HP-IB Control Switch, as set at the factory, is shown in Figure 3-35.

When the 4192A is turned on, the HP-IB address is displayed, in decimal, on DISPLAY A. For example, the factory-set address is displayed as "H-17".

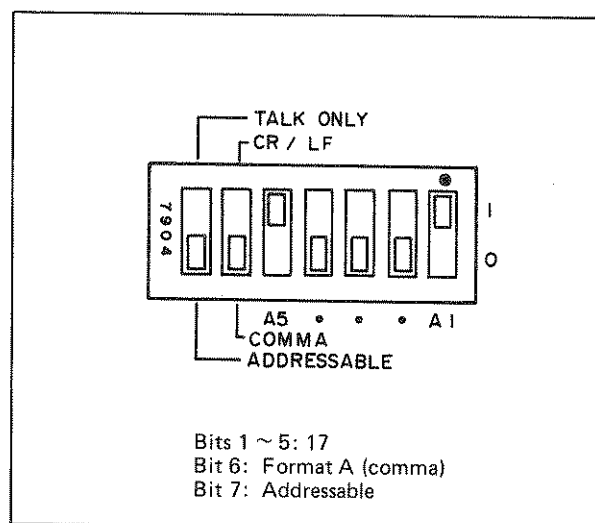

Figure 3-35. HP-IB Control Switch

3-119. HP-IB Interface Capabilities

3-120. The 4192A has eight HP-IB interface functions, as listed in Table 3-22.

3-121. Remote Program Code

3-122. Remote program codes for the 4192A are listed in Table 3-23.

Table 3-22. HP-IB Interface Capabilities

| Code | Interface Function* (HP-IB Capabilities) |
|-------|--|
| SH1** | Source Handshake |
| AH1 | Acceptor Handshake |
| T5 | Talker (basic talker, serial poll, talk only mode, unaddress to talk if addressed to listen) |
| L4 | Listener (basic listener, unaddress to listen if addressed to talk) |
| SR1 | Service Request |
| RL1 | Remote/local (with local lockout) |
| DC1 | Device Clear |
| DT1 | Device Trigger |

* Interface functions provide the means for a device to receive, process, and transmit messages over the bus.

** The suffix number of the interface code indicates the limitation of the function capability as defined in Appendix C of IEEE Std. 488.

Table 3-23. Remote Program Code (Sheet 1 of 3)

| Item | Control | Program Code | Description | | | | | | | | | | | | | | | | | | | | | | | | | | | | | | | | |
|-------------------------------------|---|---|--|-------|---|---|---|---|------------------|------------------|--|---|------------|--|--|---|-------|-------|---------|---|-------|-------|---------|---|--------------------------|----------------------|----------------------|---|--------------|--|--|---|--------------|--|--|
| Deviation Measurement for DISPLAY A | OFF Δ Δ% | AN ^{*1} AD AP | | | | | | | | | | | | | | | | | | | | | | | | | | | | | | | | | |
| Deviation Measurement for DISPLAY B | OFF Δ Δ% | BN ^{*1} BD BP | | | | | | | | | | | | | | | | | | | | | | | | | | | | | | | | | |
| DISPLAY A Function | Z / Y R/G L C B-A (dB) A(dBm/dBV) B(dBm/dBV) | A1 ^{*1} A2 A3 A4 A5 A6 A7 | Combinations of A and B are listed in the table below: <table border="1" style="margin: 10px auto;"> <thead> <tr> <th>A \ B</th> <th>1</th> <th>2</th> <th>3</th> </tr> </thead> <tbody> <tr> <td>1</td> <td> Z / Y - θ (deg)</td> <td> Z / Y - θ (rad)</td> <td></td> </tr> <tr> <td>2</td> <td colspan="3">R/G - X/B*</td> </tr> <tr> <td>3</td> <td>L - Q</td> <td>L - D</td> <td>L - R/G</td> </tr> <tr> <td>4</td> <td>C - Q</td> <td>C - D</td> <td>C - R/G</td> </tr> <tr> <td>5</td> <td>B - A (dB) - GROUP DELAY</td> <td>B - A (dB) - θ (deg)</td> <td>B - A (dB) - θ (rad)</td> </tr> <tr> <td>6</td> <td colspan="3">A(dBm/dBV) *</td> </tr> <tr> <td>7</td> <td colspan="3">B(dBm/dBV) *</td> </tr> </tbody> </table> | A \ B | 1 | 2 | 3 | 1 | Z / Y - θ (deg) | Z / Y - θ (rad) | | 2 | R/G - X/B* | | | 3 | L - Q | L - D | L - R/G | 4 | C - Q | C - D | C - R/G | 5 | B - A (dB) - GROUP DELAY | B - A (dB) - θ (deg) | B - A (dB) - θ (rad) | 6 | A(dBm/dBV) * | | | 7 | B(dBm/dBV) * | | |
| A \ B | 1 | 2 | | 3 | | | | | | | | | | | | | | | | | | | | | | | | | | | | | | | |
| 1 | Z / Y - θ (deg) | Z / Y - θ (rad) | | | | | | | | | | | | | | | | | | | | | | | | | | | | | | | | | |
| 2 | R/G - X/B* | | | | | | | | | | | | | | | | | | | | | | | | | | | | | | | | | | |
| 3 | L - Q | L - D | L - R/G | | | | | | | | | | | | | | | | | | | | | | | | | | | | | | | | |
| 4 | C - Q | C - D | C - R/G | | | | | | | | | | | | | | | | | | | | | | | | | | | | | | | | |
| 5 | B - A (dB) - GROUP DELAY | B - A (dB) - θ (deg) | B - A (dB) - θ (rad) | | | | | | | | | | | | | | | | | | | | | | | | | | | | | | | | |
| 6 | A(dBm/dBV) * | | | | | | | | | | | | | | | | | | | | | | | | | | | | | | | | | | |
| 7 | B(dBm/dBV) * | | | | | | | | | | | | | | | | | | | | | | | | | | | | | | | | | | |
| DISPLAY B Function | θ (deg) θ (rad) X/B Q D R/G GROUP DELAY θ (deg) θ (rad) | B1 ^{*1} B2 B1 ~ B3 B1 B2 B3 B1 B2 B3 | | | | | | | | | | | | | | | | | | | | | | | | | | | | | | | | | |

* Program code for DISPLAY B IS not necessary.

Table 3-23. Remote Program Code (Sheet 2 of 3)

| Item | Control | Program Code | Description |
|-------------------------------------|---|---|--|
| Recall Parameter | SPOT FREQ. STEP FREQ. START FREQ. STOP FREQ. SPOT BIAS STEP BIAS START BIAS STOP BIAS OSC LEVEL REF A REF B | FRR* ¹ SFR TFR PFR BIR SBR TBR PBR OLR RAR RBR | |
| TEST LEVEL MONITOR* ² | V mA | TV TA | |
| Key Status Save (Memory) | SAVE 0 SAVE 1 SAVE 2 SAVE 3 SAVE 4 | SA0 SA1 SA2 SA3 SA4 | |
| Saved Key Status Recall | RCL 0 RCL 1 RCL 2 RCL 3 RCL 4 | RC0 RC1 RC2 RC3 RC4 | |
| DC BIAS* ² | OFF | I0* ¹ | |
| ZERO OPEN* ² | OFF ON | ZO0* ¹ ZO1 | |
| ZERO SHORT* ² | OFF ON | ZS0* ¹ ZS1 | |
| AVERAGE | OFF ON | V0* ¹ V1 | |
| HIGH SPEED | OFF ON | H0* ¹ H1 | |
| SELF TEST | ON | S1 | |
| X-Y RECORDER | OFF ON Lower Left Upper Right | X0* ¹ X1 LL UR | "LL" and "UR" cannot be used when the X-Y Recorder function is set to ON (X1). |

Table 3-23. Remote Program Code (Sheet 3 of 3)

| Item | Control | Program Code | Description |
|--|---|--|---|
| STORE DISPLAY A/B | | SD | |
| LOG SWEEP | OFF ON | G0* ¹ G1 | |
| SWEEP ABORT | | AB | |
| SWEEP | MANUAL AUTO | W0* ¹ W1 | |
| MANUAL SWEEP | STEP UP STEP DOWN | W2 W4 | W2 and W4 act as STEP UP and STEP DOWN when the SWEEP mode is set to MANUAL (W0). |
| AUTO SWEEP | START UP PAUSE START DOWN | W2 W3 W4 | W2 and W4 act as START UP and START DOWN when the SWEEP mode is set to AUTO (W1). |
| CIRCUIT MODE* ² | AUTO Series Parallel | C1* ¹ C2 C3 | |
| GAIN MODE | dBm dBV | N1 N2 | These programming codes cannot be used when DISPLAY A function is set to A1, A2, A3, or A4. |
| ZY RANGE* ² | 1Ω/10S 10Ω/1S 100Ω/100mS 1kΩ/10mS 10kΩ/1mS 100kΩ/100μS 1MΩ/10μS AUTO | R1 R2 R3 R4 R5 R6 R7 R8* ¹ | Remote programming code R1 cannot be used with some SPOT FREQ/OSC LEVEL settings. |
| TRIGGER | INT EXT HOLD/MANUAL | T1* ¹ T2 T3 | These code only set the TRIGGER mode; they do not trigger the instrument. |
| Data Ready | OFF ON | D0* ¹ D1 | If Data Ready is set to ON, an SRQ signal is output when the measurement is completed. |
| Output Data Format | Displays A/B Displays A/B/C | F0* ¹ F1 | Refer to paragraph 3-125 and Figure 3-36. |
| Execute | | EX | This code is used to trigger the instrument. |
| *1 : Default code. | | | |
| *2 : These programming codes cannot be used when DISPLAY A function is set to A5, A6, or A7. | | | |

3-123. Parameter Setting

3-124. The 4192A can be set to eleven parameters (refer to Table 3-24) by remote programming as follows:

$\underline{XX \pm NNNN.NNNNEN}$
 (1) (2) (3)

- (1) Program code for parameter setting (refer to Table 3-24).
- (2) Setting value (numeric or space). 8 digits, lesser digits are ignored.
- (3) Enter. Unit is kHz for SPOT FREQ, START FREQ, STEP FREQ, and STOP FREQ; V for SPOT BIAS, STEP BIAS, STOP BIAS, and OSC LEVEL. (REF A, REF B).

3-125. Data Output

3-126. The 4192A outputs measurement and status data to external devices in bit parallel, byte serial format via the eight DIO signal lines of the HP-IB. These data include status data, key status (function) data, deviation measurement mode data, and measurement data (including range) for DISPLAY A and DISPLAY B. When program code "F1" is used, DISPLAY C data (unit and value) are output with DISPLAY A and DISPLAY B data. The output format is shown in Figure 3-36. All characters are coded in accordance with ASCII coding conventions. To output DISPLAY A/B/C data without an HP-IB controller, internal Control Switch (A6S2 bit 4) must be set to 1. Refer to paragraph 3-139 and Table 3-28.

Table 3-24. Program Codes for Parameter Setting

| Parameters | Program Code | Setting Value |
|----------------|--------------|---|
| SPOT FREQ | FR | Setting Range: 0.005000kHz ~ 13000.000kHz. Resolution: 0.000001kHz (0.005000kHz ~ 9.999999kHz), 0.00001kHz (10.00000kHz ~ 99.99999kHz), 0.0001kHz (100.0000kHz ~ 999.9999kHz), 0.001kHz (1000.000kHz ~ 13000.000kHz). |
| START FREQ | TF | |
| STOP FREQ | PF | |
| STEP FREQ | SF | Setting Range: 0.000001kHz ~ 13000.000kHz. Resolution: 0.000001kHz (0.000001kHz ~ 9.999999kHz), 0.00001kHz (10.00000kHz ~ 99.99999kHz), 0.0001kHz (100.0000kHz ~ 999.9999kHz), 0.001kHz (1000.000kHz ~ 13000.000kHz). |
| SPOT BIAS | BI | Setting Range: -35.00V ~ +35.00V Resolution: 0.01V |
| START BIAS | TB | |
| STOP BIAS | PB | |
| STEP BIAS | SB | Setting Range: 0.01V ~ 35.00V Resolution: 0.01V |
| OSC LEVEL | OL | Setting Range: 0.005V ~ 1.100V Resolution: 0.001V (0.005V ~ 0.100V), 0.005V (0.100V ~ 1.100V). |
| REF A REF B | RA RB | Setting Range: -19999 ~ +19999. Resolution: The position of the decimal point depends on the value displayed on the corresponding display. For example, if the value displayed on DISPLAY A is 1.9999, any value between 0.0001 and 1.9999 can be entered as the REF A (RA) value. |

① DISPLAY A/B (Default mode or set using HP-IB remote program code "F0")

$\frac{X X X X \pm N N N . N N E \pm N N , X X X X \pm N N N . N N E \pm N N}{(1) (2) (3) \quad (4) \quad (5) (6)(7) (8) (9) \quad (10) \quad (11) \quad (12) \quad \text{CR LF}}$

② DISPLAY A/B/C (Set using HP-IB remote program code "F1")

$\frac{X X X X \pm N N N . N N E \pm N N , X X X X \pm N N N . N N E \pm N N , X \pm N N N N N . N N N}{(1) (2) (3) \quad (4) \quad (5) (6)(7) (8) (9) \quad (10) \quad (11) (6)(13) \quad (14) \quad (12) \quad \text{CR LF}}$

- (1) Status of DISPLAY A
- (2) Function of DISPLAY A
- (3) Deviation measurement mode of DISPLAY A
- (4) Value of DISPLAY A (position of decimal point is coincident with display)
- (5) Unit of DISPLAY A
- (6) Comma (data delimiter)
- (7) Status of DISPLAY B
- (8) Function of DISPLAY B
- (9) Deviation measurement mode of DISPLAY B
- (10) Value of DISPLAY B (position of decimal point is coincident with display)
- (11) Unit of DISPLAY B
- (12) Data Terminator
- (13) Unit of DISPLAY C (Test Parameter Data Display)
- (14) Value of DISPLAY C

Notes: 1. The data delimiter, bit switch 6 on the HP-IB Control Switch (Figure 3-30), is set at the factory to comma (.). This causes the 4192A to output all data (DISPLAY A data, DISPLAY B data, and, if program code F1 is used, DISPLAY C data) as a continuous string. When the data delimiter is set to CR/LF, a carriage return and line feed signal is output after each field. This is useful when outputting data to certain peripherals, such as a printer.



2. Status, function, and deviation measurement mode data of DISPLAY A and DISPLAY B, and the units of DISPLAY C are output as one or two alphabetic characters, as listed in Table 3-25.

3. Ranges of DISPLAY A and DISPLAY B are expressed as an exponent as follows:

| | | |
|-----------------------|-------|------|
| 10 ⁻¹² (p) | | E-12 |
| 10 ⁻⁹ (n) | | E-09 |
| 10 ⁻⁶ (μ) | | E-06 |
| 10 ⁻³ (m) | | E-03 |
| 10 ⁰ | | E+00 |
| 10 ³ (k) | | E+03 |
| 10 ⁶ (M) | | E+06 |

Figure 3-36. Data Output Format for the 4192A

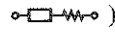
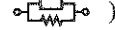
Table 3-25. Data Output Codes

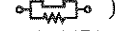
| Item | Information | Code |
|---|--|--|
| Data Status of DISPLAY A/B | Normal Overflow Uncalibration | N O U |
| Function of DISPLAY A | Z Y R G L () L () C () C () B - A (dB) A (dBV) B (dBV) A (dBm) B (dBm) | ZF YF RF GF LS LP CS CP BA AV BV AM BM |
| Deviation Measurement Mode of DISPLAY A/B | Normal Measurement Deviation Measurement Deviation Measurement in Percent | N D P |
| Function of DISPLAY B | θ (deg) θ (rad) X B Q D R G GROUP DELAY Unmeasure | TD TR XF BF QF DF RF GF GD UM |
| Unit of DISPLAY C | kHz V mA Reference Data | K V M R |

3-127. Service Request Status Byte

3-128. The 4192A outputs an RQS (Request Service) signal whenever bit 1, 2, 3, 4, or 6 of Service Request Status Byte is set. The make-up of the Status Byte is shown in Figure 3-37.

| | | | | | | | | |
|-------------|---|-----|-----|-----|-----|-----|-----|-----|
| Bit | 8 | 7 | 6 | 5 | 4 | 3 | 2 | 1 |
| Information | 0 | 0/1 | 0/1 | 0/1 | 0/1 | 0/1 | 0/1 | 0/1 |

Bit 7 (RQS) indicates whether or not a service request exists. Bit 8 is always zero (0). Bits 1 thru 4 and 6 identify the type of service request. Following are the service request states of the 4192A.

- Bit 1: ① If Data Ready is set to ON, this bit is set when measurement data is provided.
 ② If Self Test is set to ON, this bit is set when the instrument passes the Self Test.

Bit 2: This bit is set when the 4192A receives an erroneous remote program code.

Bit 3: This bit is set when the 4192A receives an illegal front-panel control setting via the program.

Bit 4: This bit is set when the 4192A receives a trigger signal before the last measurement is completed.

- Bit 6: ① This bit is set when the 4192A has a hardware error.
 ② If Self Test is set to ON, this bit is set when the instrument fails the Self Test.

Bit 5 is independent of bit 7 (RQS signal). This bit is set when auto sweep measurement, self test, or zero offset adjustment is being performed and is reset when the next trigger comes.

Figure 3-37. Status Byte for the 4192A

3-129. Programming Guide for 4192A

3-130. Sample programs for HP Model 9825A/9835A Desktop Computers are provided in Figures 3-38 and 3-39. These programs are listed in Table 3-26.

Notes:

1. Specific information for HP-IB programming with the 9825A or 9835A are provided in the 9825A or 9835A programming manual.

2. Equipment required for these sample programs includes:

- 4192A LF Impedance Analyzer
- 98034A HP-IB Interface Card
- 9825A Desktop Computer with 98210A String-Advanced Programming ROM 98213A General I/O + Extended I/O ROM.

or

- 9835A Desktop Computer with 98332A General I/O ROM

Table 3-26. Sample Program using 9825A/9835A

| Sample Program | Figure | Description |
|----------------|--------|---|
| 1 | 3-38 | Remote control and data output in spot measurement. |
| 2 | 3-39 | Remote control and data output in auto sweep measurement. |

Sample Program 1

Description:

This program is a remote control, data output program for spot measurements.

The program has three capabilities:

- (1) Control of the 4192A via HP-IB
- (2) Trigger of the 4192A via HP-IB
- (3) Data output from the 4192A in spot measurement via HP-IB

9825A Program

```

0: flt4
1: wrt717, "A1BIT3 F1"
      (1)(2) (3)
2: wrt717, "FR10EN"
      (4) (5)
3: wrt717, "EX"
      (6)
4: red717, A, B, C
5: dspA, B, C
6: prtA, B, C
7: end
    
```

9835A Program

```

10 FLOAT4
20 OUTPUT717; "A1BIT3 F1"
      (1)(2) (3)
30 OUTPUT717; "FR10EN"
      (4) (5)
40 OUTPUT717; "EX"
      (6)
50 ENTER717; A, B, C
60 DISP A, B, C
70 PRINT A, B, C
80 END
    
```

- (1) Select Code of 98034A.
- (2) Address of 4192A.
- (3) Program codes of the 4192A (refer to Table 3-23).
- (4) Program codes for parameter setting of the 4192A (refer to Table 3-24).
- (5) Parameter terminator of the 4192A (refer to paragraph 3-123).
- (6) This is equivalent to

```

9825A: trg717
9835A: TRIGGER717
    
```

By using string variables, complete output information from the 4192A is stored by the following programs:

9825A Program:

```

0: clr 717
1: dimA$[50]
2: wrt717, "A1BIT3 F1"
3: wrt717, "FR10EN"
4: wrt717, "EX"
5: red717, A$
6: dspA$
7: prtA$
8: end
    
```

9835A Program:

```

5 CLEAR 717
10 DIMA$[50]
20 OUTPUT717; "A1BIT3 F1"
30 OUTPUT717; "FR10EN"
40 OUTPUT717; "EX"
50 ENTER717; A$
60 DISP A$
70 PRINT A$
80 END
    
```

Figure 3-38. Sample Program 1 Using 9825A/9835A

Sample Program 2**Description:**

This program is a remote control, data output program for auto sweep measurements.

The program has three capabilities:

- (1) Control of auto sweep measurement of the 4192A via HP-IB
- (2) Auto sweep of the 4192A via HP-IB
- (3) Data output from the 4192A via HP-IB

9825A Program:

```

0 : dim A $ [ 100,50 ]
           (1)
1 : wrt 717, "A1BIT3 F1"
2 : wrt 717, "SF1ENTF1ENPF100EN"
3 : wrt 717, "W1 W 2 "
4 : 0 → I
5 : I+1 → I
6 : wrt 717, "EX"
7 : rds (717) → A
           (2)
8 : if bit (4, A) ≠ 1; goto 12
           (3)
9 : red 717, A$(I)
10 : dsp A$(I)
11 : goto 5
12 : end

```

9835A Program:

```

10 DIM A $ ( 100 ) [ 50 ]
           (1)
20 OUTPUT 717; "A1BIT3 F1"
30 OUTPUT 717; "SF1ENTF1ENPF100EN"
40 OUTPUT 717; "W1 W 2 "
50 I = 0
60 I = I + 1
70 OUTPUT 717; "EX"
80 STATUS 717; A
           (2)
90 IF BIT (A, 4) ≠ 1 THEN 130
           (3)
100 ENTER 717; A$(I)
110 DISP A$(I)
120 GOTO 60
130 END

```

- (1) Dimensions a string variable array that has more elements than the number of measurement points.
- (2) Inputs 4192A SRQ Status Byte to variable A.
- (3) When AUTO SWEEP is being performed, bit 4 of variable A (bit 5 of the SRQ Status Byte) is set to "1" (refer to Figure 3-37).

Note: If the 9835A program is used with high speed controller, wait command should be put between lines 70 and 80.

Figure 3-39. Sample Program 2 Using 9825A/9835A

3-131. X-Y RECORDER OUTPUT

3-132. The 4192A is equipped with three analog RECORDER OUTPUT connectors on the rear-panel. These connectors output accurate voltages for recording measured sample values as functions of frequency or bias. A PEN LIFT connector is also provided on the rear-panel to control the X-Y recorder's pen. The procedures for using the 4192A's X-Y recorder capability are given in Figure 3-40.

3-133. Analog Outputs

3-134. The analog output voltage of DISPLAY A, DISPLAY B, and FREQ/BIAS are provided in the following manner. The output accuracy is $\pm 0.5\%$ of output voltage $\pm 20\text{mV}$.

(1) DISPLAY A connector

Outputs voltage proportional to the value displayed on DISPLAY A. Normalized value is 1V (depends on function as follows):

- ① Z, Y, R and G : (Full Scale Value of Display Range) $\times 1.3$
- ② L and C : (Full Scale Value of Display Range) $\times 2.0$
- ③ B - A, A and B : 100dB
- ④ $\Delta\%$: 100%
- ⑤ Δ : Full Scale Value of Setting Function Range

(2) DISPLAY B connector

Outputs voltage proportional to the value displayed on DISPLAY B. Normalized value is 1V (depends of function as follows):

- ① θ (deg) : 180°
- ② θ (rad) : π
- ③ X and B : (Full Scale Value of Display Range) $\times 1.3$
- ④ D, Q, R, G and GROUP DELAY : (Full Scale Value of Display Range) $\times 2.0$
- ⑤ $\Delta\%$: 100%
- ⑥ Δ : Full Scale Value of Setting Function Range

Note: When OF1, OF2, UCL, or - - - is displayed on DISPLAY A or DISPLAY B, 1V is output from the corresponding RECORDER OUTPUT connector on the rear-panel.

(3) FREQ/BIAS connector

Outputs voltage proportional to the test frequency or internal dc bias voltage and normalized by following equations (1Vmax):

① Bias Voltage:

$$\frac{\text{SPOT BIAS} - \text{START BIAS}}{\text{STOP BIAS} - \text{START BIAS}}$$

② Measuring Frequency (Linear Sweep):

$$\frac{\text{SPOT FREQ} - \text{START FREQ}}{\text{STOP FREQ} - \text{START FREQ}}$$

③ Measuring Frequency (Logarithmic Sweep):

$$\frac{1 \log (\text{SPOT FREQ} - 10^{m-1})}{1 \log (10^n - 10^{m-1})}$$

where $10^{m-1} \leq \text{START FREQ} < 10^m$,
 $10^{n-1} \leq \text{STOP FREQ} < 10^n$.

Notes:

1. When the parameter displayed on the Test Parameter Data Display is not the measuring frequency or internal dc bias voltage, the output voltage from the FREQ/BIAS connector does not change.
2. Figure 3-41 shows the plot areas for all parameter settings of DISPLAY A, DISPLAY B and FREQ/BIAS connectors.

3-135. Control Capabilities for Analog Output

3-136. The X-Y RECORDER OUTPUTS function of the 4192A provides the following control capabilities to plot the characteristics curve of the sample easily, quickly and clearly.

(1) Control of Pen Position on the X-Y Recorder

Zero adjustment and sensitivity adjustment of the X-Y recorder can be performed using the following control keys on the front-panel of the 4192A.

- ① $\downarrow \leftarrow$ LL : DISPLAY A, DISPLAY B and FREQ/BIAS connectors output 0V.
- ② UR $\rightarrow \uparrow$: DISPLAY A, DISPLAY B and FREQ/BIAS connectors output 1V.

Notes:

1. The X-Y RECORDER ON/OFF key should be set to OFF (indicator lamp off) when the X-Y recorder zero adjustment or sensitivity adjustment is performed. In this case, $\downarrow\leftarrow LL$ is set automatically.
2. Figure 3-41 shows the positions of $\downarrow\leftarrow LL$ and $UR \rightarrow\uparrow$ in the plot areas for all parameter settings of DISPLAY A, DISPLAY B, and FREQ/BIAS connectors.

(2) Control Signals for X-Y Recorder Pen Lift TTL Controls

When the X-Y recorder is equipped with pen lift TTL controls, pen lift can be done automatically by the TTL level output from the PEN lift connector on the 4192A's rear-panel. When the pen lift signal is LOW (TTL), the X-Y recorder pen is down. When the pen lift signal is HIGH (TTL), the X-Y recorder pen is up.

Note: When the SWEEP ABORT, $\downarrow\leftarrow LL$ or $UR \rightarrow\uparrow$ key is pressed, the X-Y recorder pen is up.

(3) Interpolation

The X-Y recorder function of the 4192A provides automatic interpolation of all three RECORDER OUTPUTS to ensure distortion free, accurate plots on the X-Y recorder. Maximum interpolation time, the time required for the three RECORDER OUTPUTS to go from 0V ($\downarrow\leftarrow LL$) to 1V ($UR \rightarrow\uparrow$), is approximately 30 seconds.

Note: Interpolation is performed for all three RECORDER OUTPUTS, even though only two are connected to the X-Y recorder. Actual interpolation time is determined by the largest change among the three outputs. Consequently, if the unconnected RECORDER OUTPUT has the largest change, interpolation time is determined by this RECORDER OUTPUT, not the other two, whose change may be very small.

EQUIPMENT:

X-Y Recorder HP7046A
BNC (Male) – Dual Banana Plug Cable HP11001A (3 ea.)

PROCEDURE:

- (1) Turn the 4192A and X-Y recorder off.
- (2) Connect the X-axis connector and Y-axis connector (Y1-axis and Y2-axis for two-pen X-Y recorders) of the X-Y recorder to the appropriate RECORDER OUTPUT connectors on the 4192A rear-panel with the BNC (Male) – Dual Banana Plug Cable. Refer to Table 3-27 for cabling method of the RECORDER OUTPUTS.
- (3) When X-Y recorder is provided with pen lift TTL controls, connect PEN LIFT connector on the 4192A rear-panel to the X-Y recorder connector.
- (4) Set the 4192A's controls for the desired swept measurement in accordance with the procedures given in the following figures:
 - Figure 3-11. Operating Instructions for Swept-frequency Amplitude-phase Measurements
 - Figure 3-31. Operating Instructions for Swept-frequency Impedance Measurement
 - Figure 3-33. Operating Instructions for Swept-bias Voltage Impedance Measurement
- (5) Turn the 4192A and X-Y recorder on.
- (6) Place recording paper on X-Y recorder platen and set the paper hold down function (if provided).

Figure 3-40. X-Y Recorder Output (Sheet 1 of 2)

- (7) Confirm that the 4192A X-Y RECORDER OUTPUT function is set to off (X-Y RECORDER ON/OFF indicator on the front-panel should be off). If it is set to on (indicator lamp on), turn it off by pressing the BLUE key and X-Y RECORDER ON/OFF key.
- (8) Select the appropriate plot area for parameters to be recorded from illustrations in Figure 3-41 (refer to Table 3-27).
- (9) Press the BLUE key and the LL key on the front-Panel of the 4192A.
- (10) Adjust X-Y recorder zero adjustment controls for X and Y channels so that the recorder pen is positioned just above the chart paper coordinates denoted by the black spot () in the illustration.
- (11) Press the BLUE key and the UR key on the front-panel of the 4192A.
- (12) Adjust the X-Y recorder controls for the X and Y channels so the the recorder pen is positioned just above the chart paper coordinates denoted by circle (A) in the illustration.

Note: X-Y recorder zero adjustment and sensitivity adjustment may be interactive. So, repeat steps (9) (12) to satisfy both adjustments.
- (13) Perform an auto sweep measurement with the X-Y RECORDER OUTPUT function off. Note the frequency (or bias voltage) at which the measured value displayed on DISPLAY A is highest.

Note: Step (13) is not necessary when making a manual sweep.
- (14) Set the SPOT FREQ (or SPOT BIAS) to the value noted in step (13). (For manual sweep, set the SPOT value to the START value.)

Note: Steps (13) and (14) insure that the DISPLAY A X-Y RECORDER OUTPUT is correctly scaled for the highest DISPLAY A range that will be used during the auto sweep measurement. When the AUTO SWEEP START key is pressed, DISPLAY A ranging (Z-Y RANGE) is automatically set to AUTO mode, even if MANUAL mode is selected before pressing the AUTO SWEEP START key. The DISPLAY A range will change in accordance with the measured values. Scaling of the DISPLAY A X-Y RECORDER OUTPUT, however, will not change when the DISPLAY A range changes. It is automatically set to the DISPLAY A range in effect when the AUTO SWEEP function is turned on. If steps (13) and (14) are not performed, it may be impossible obtain an accurate plot of the measured values.
- (15) Press the BLUE key and the X-Y RECORDER ON/OFF key to set the X-Y RECORDER OUTPUT function to on (the indicator lamp will come on).
- (16) Press the AUTO SWEEP key. If the recorder is equipped with remote pen-lift control, go to step (17). If not, set the SPOT FREQ (BIAS) to the sweep START FREQ (BIAS) and then manually lower the pen onto the paper.
- (17) Perform the swept measurement in accordance with the procedure given in the figure selected in step (4).
- (18) When the sweep is completed and the X-Y recorder stops, manually lift the pen from the paper. If the recorder is equipped with remote pen-lift control, the pen is raised automatically when the sweep is completed (or when the X-Y RECORDER OUTPUT function is turned off after a manual sweep).
- (19) To repeat the measurement, repeat steps (14) through (18).

Figure 3-40. X-Y Recorder Output (Sheet 2 of 2)

Table 3-27. Connections of Recorder Output

| FREQ/BIAS | RECORDER OUTPUTS | | Plot Area*1 |
|--|------------------|------------|-------------|
| | DISPLAY B | DISPLAY A | |
| Measurement Frequency/ Bias Voltage | | Z / Y /R/G | ① |
| | | L/C | ② |
| | θ (deg) | | ③ |
| | θ (rad) | | ④ |
| | X/B | | ⑤ |
| | Q/D | | ② |
| | R/G | | ① |
| | X/B | R/G | ⑥ |
| Measurement Frequency | | B - A (dB) | ⑦ |
| | | A/B (dBm) | ⑧ |
| | | A/B (dBV) | ⑨ |
| | θ (deg) | | ③ |
| | θ (rad) | | ④ |
| | GROUP DELAY | | ② |
| Measurement Frequency/ Bias Voltage | | Δ | ⑩ |
| | | $\Delta\%$ | ⑪ |
| | Δ | | ⑩ |
| | $\Delta\%$ | | ⑪ |

* : These numbers match the numbers of the illustrations in Figure 3-41.

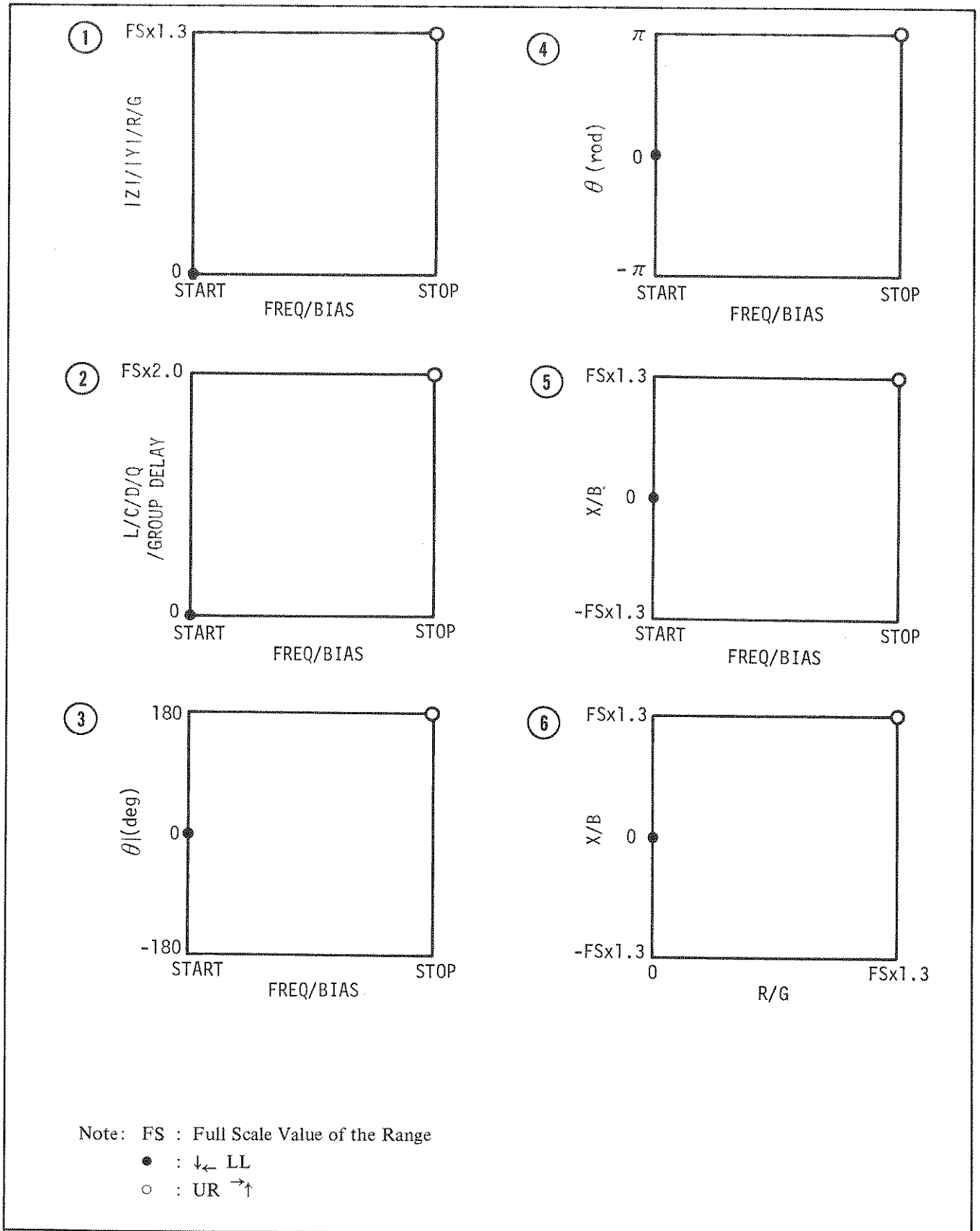

Figure 3-41. Plot Areas of RECORDER OUTPUTS (sheet 1 of 2)

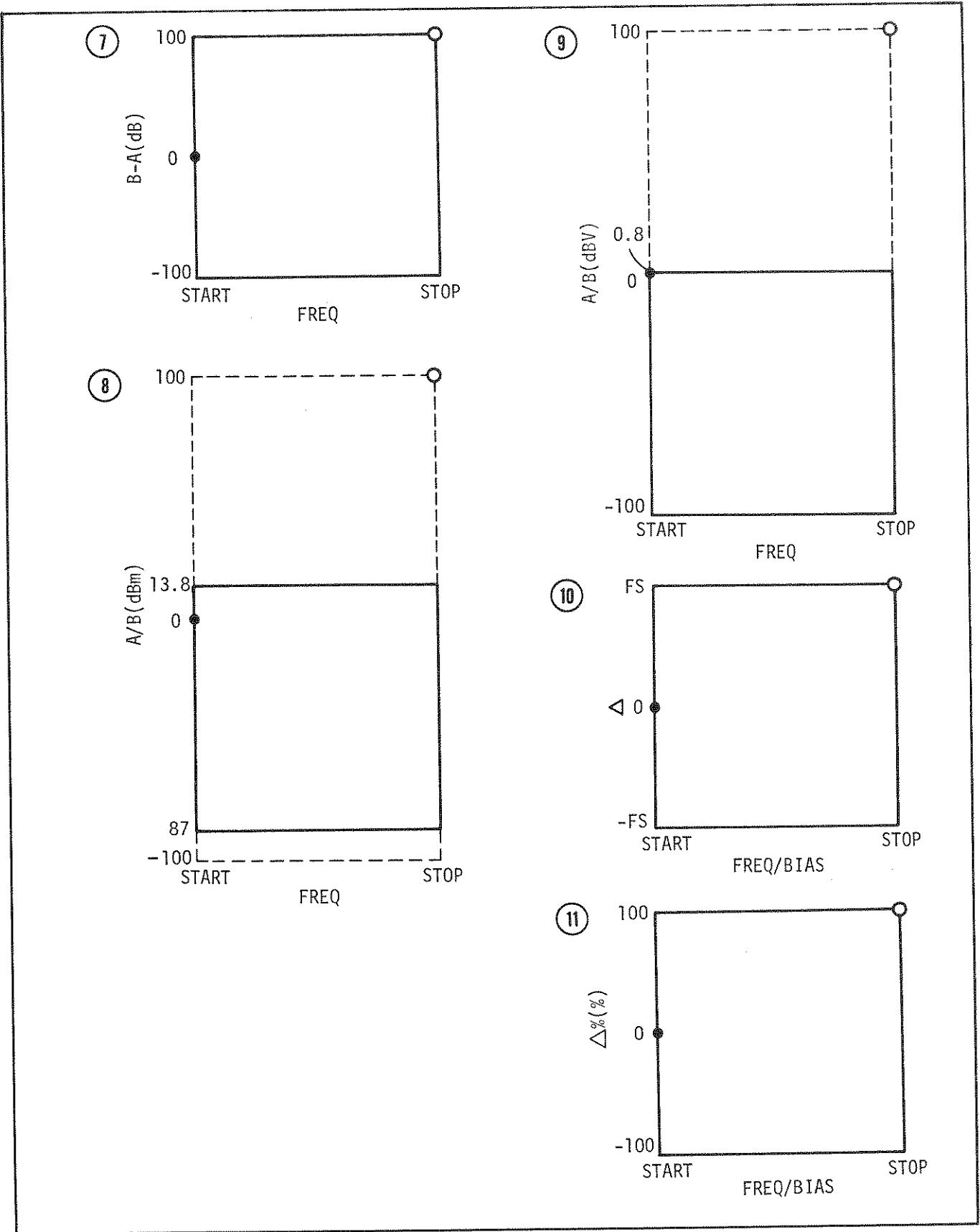

Figure 3-41. Plot Areas of RECORDER OUTPUTS (sheet 2 of 2)

3-137. EXTERNAL SYNTHESIZER

3-138. The 4192A can be connected to an external frequency synthesizer via the EXT VCO connector on the rear-panel instead of built-in frequency synthesizer to obtain a more accurate, stable test signal. Using this technique, a frequency resolution of 1mHz over the full frequency range, from 5Hz to 13MHz, can be obtained. In addition, a high stability reference (1MHz or 10MHz) can be connected to EXT REFERENCE connector on the rear-panel to obtain an even more stable test signal. This capability permits stable measurements of the intrinsic characteristics of high Q devices. Such devices include crystals whose impedance change drastically with changes in frequency of only a few Hz.

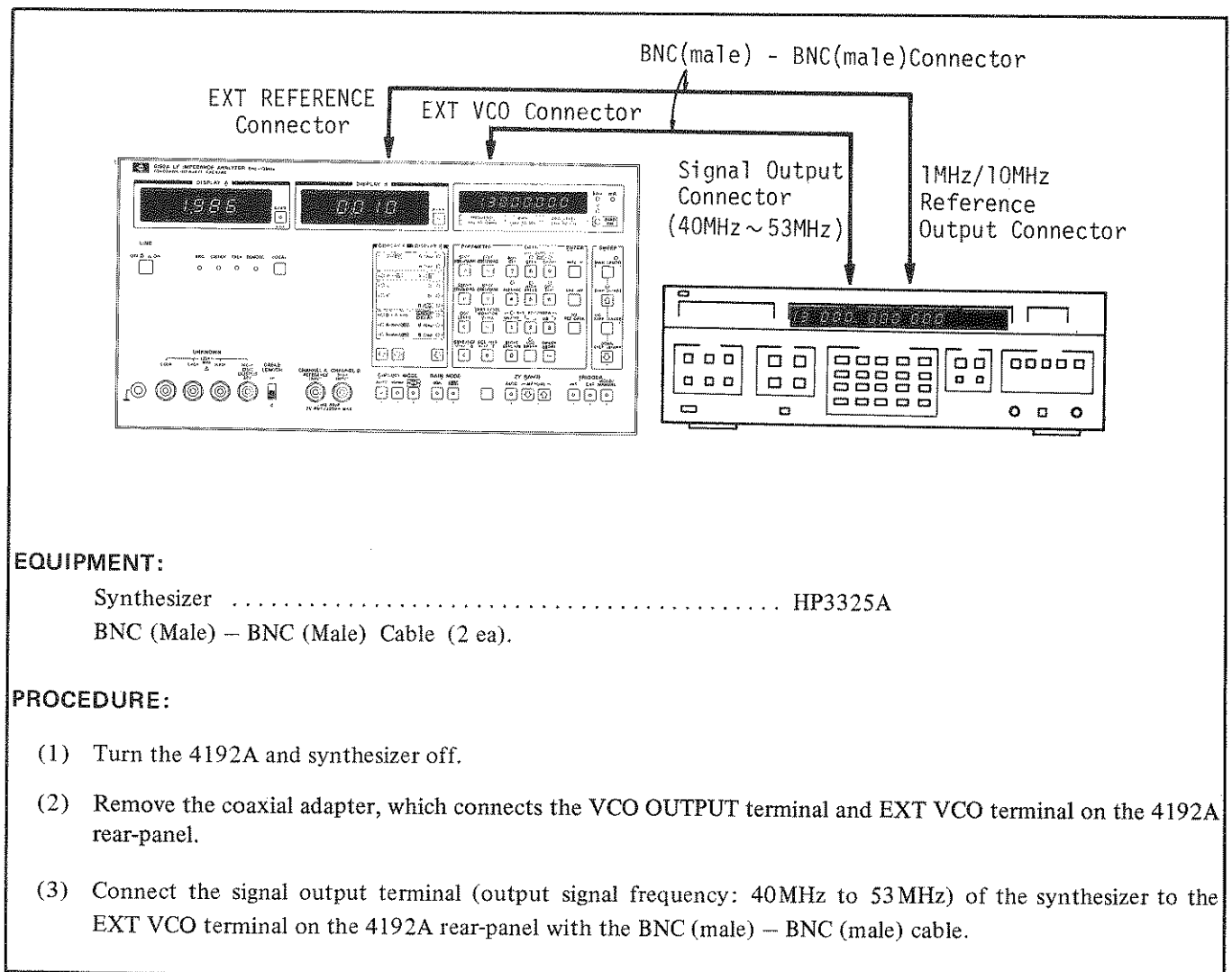

Figure 3-42. External Synthesizer (Sheet 1 of 2)

- (4) Connect the 1MHz (or 10MHz) reference signal output terminal of the synthesizer to the EXT REFERENCE terminal on the 4192A rear-panel with the BNC (male) – BNC (male) cable.
- (5) Set 4192A's controls for the desired measurement in accordance with procedures provided in the following figures:
 - Figure 3-10. Basic Operating Instructions of the Amplitude-phase Measurements
 - Figure 3-30. Basic Operating Instructions of the Impedance Measurements
- (6) Turn on the synthesizer.
- (7) Set the output signal of the synthesizer to 40MHz + desired measuring frequency.
- (8) Set the SPOT FREQ of the 4192A to the desired measuring frequency.

Notes: 1. Resolution of the test signal at the OSC OUTPUT terminal of the 4192A is 1mHz (at 5Hz to 10kHz), 10mHz (at 10kHz to 100kHz), 100mHz (at 100kHz to 1MHz), and 1Hz (at 1MHz to 13MHz). However, when an external synthesizer is used, resolution is 1mHz at all frequencies. Thus, to set a test frequency with a resolution higher than is normally possible (without external synthesizer), set the 4192A's SPOT FREQ as near to the desired frequency as possible. For example, for a test signal frequency of 50.000001kHz, set the external synthesizer to 50.000001kHz +40MHz and set the 4192A's SPOT FREQ to 50.00000kHz. The frequency of the test signal of the OSC OUTPUT terminal will be the frequency of the external synthesizer; however, the SPOT FREQ setting is used to calculate measurement parameter values (L, C, etc.), offset adjustment data, etc.

- 2. Values displayed on the 4192A's displays will fluctuate when measurement is made at frequencies set with 1mHz resolution at 10kHz to 78.125kHz.*

Figure 3-42. External Synthesizer (Sheet 2 of 2)

3-139. INTERNAL CONTROL SWITCH

3-140. Basic operation of the 4192A can be altered by changing the bit-switch settings of the internal control switch, A6S2. Refer to Table 3-28 for a description of the function of each bit-switch. Use the following procedure to gain access to the internal control switch:

- (1) Turn off the instrument and disconnect the power cable.
- (2) Remove the two plastic instrument-feet located at the upper corners of the rear-panel.
- (3) Fully loosen the top cover retaining screw located at the rear of the top cover.
- (4) Slide the top cover towards the rear and lift off.

WARNING

POTENTIAL SHCOK HAZARD! DO NOT TOUCH ANY OF THE EXPOSED COMPONENTS! CAPACITORS MAY STILL BE CHARGED WITH HAZARDOUS VOLTAGE LEVELS, EVEN THOUGH POWER IS REMOVED FROM THE INSTRUMENT.

- (5) With the top cover removed, the A7, A8, and A10 board assemblies are visible. These boards are on a single mounting-plate which opens much like the hood of an automobile. The A6 board assembly, upon which the internal control switch is located, is mounted on the underside of this mounting-plate. To raise the mounting-plate, remove the six retaining screws and pull up the two plastic fasteners located toward the front of the mounting plate.
- (6) Raise the mounting plate until it comes to rest at the rear of the instrument. Be sure that the safety catch locks in place.
- (7) The internal control switch is located as shown in Figure 3-43. All bit-switches of A6S2 are normally set to 0. Set the switch as desired. Refer to Table 3-28.

Note: Don't change the setting of A6S1. This switch is used for cable length compensation.

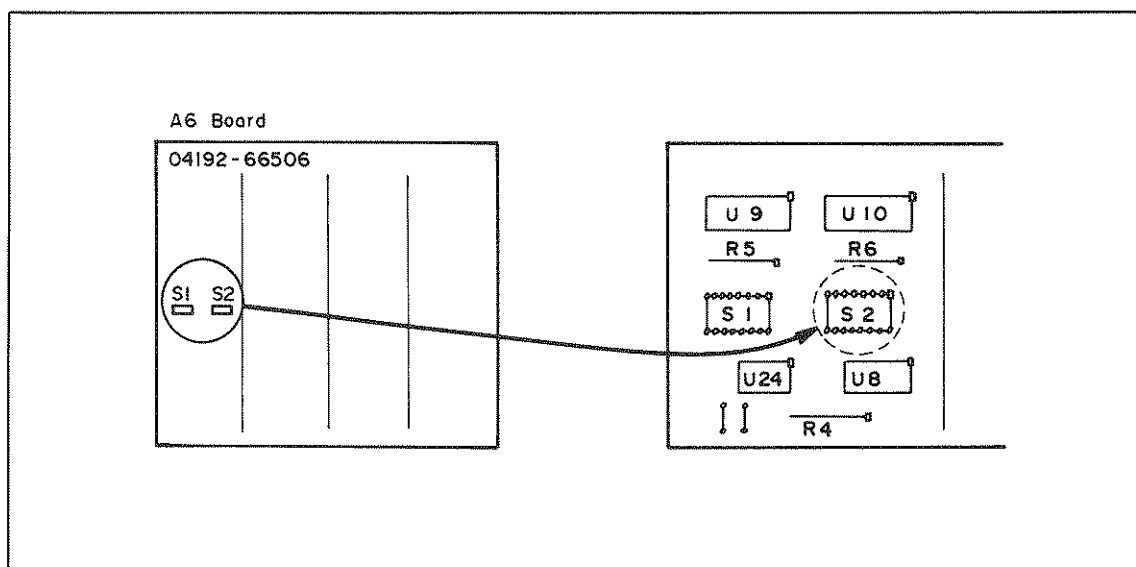

Figure 3-43. A6S2 Internal Control Switch

Table 3-28. Internal Control Switch

| Bit | Description |
|---|---|
| 0 | This bit-switch is related to the operation of the multi-slope integrator; it should be always set to 0. |
| 1 | When this bit is set to 1, DISPLAY B function is inhibited and measuring speed is increased. Measuring speed in this mode is given in paragraph 3-55 for amplitude/phase measurements and in paragraph 3-89 for impedance measurements. |
| 2 | This bit-switch is related to the operation of the multi-slope integrator; it should be always set to 0. |
| 3 | An HP-IB system, without controller, can be configured by connecting the 4192A to a (HP-IB control switch must be set to TALK ONLY and CR/LF*) printer (HP-IB control switch must be set to LISTEN ONLY), e.g., HP5150A Thermal Printer, with an HP-IB cable (refer to paragraph 3-117). When this bit is set to 1, the 4192A is triggered by the operation of the printer. |
| 4 | This bit is used to change the data output format from DISPLAY A/B to DISPLAY A/B/C, in the HP-IB system without controller (refer to paragraph 3-125). When this bit is set to 1 (4192A must be turned off and then back on after setting this bit-switch), data output format is set to DISPLAY A/B/C. |
| 5, 6 | These bit-switches are not used. |
| 7 | In normal operation, the number of display digits depends on the selected measurement function, measurement range, measurement frequency, OSC level, etc. When this bit is set to 1, however, all measured values are displayed with the maximum number of digits. |
| * After changing the setting of the HP-IB control switch, turn the instrument off and then back on. | |

Free Manuals Download Website

<http://myh66.com>

<http://usermanuals.us>

<http://www.somanuals.com>

<http://www.4manuals.cc>

<http://www.manual-lib.com>

<http://www.404manual.com>

<http://www.luxmanual.com>

<http://aubethermostatmanual.com>

Golf course search by state

<http://golfingnear.com>

Email search by domain

<http://emailbydomain.com>

Auto manuals search

<http://auto.somanuals.com>

TV manuals search

<http://tv.somanuals.com>