

4140B pA METER/DC VOLTAGE SOURCE

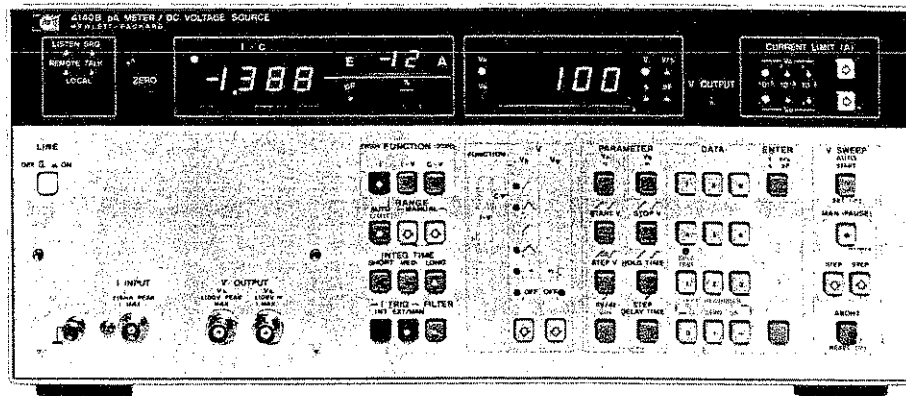











TABLE OF CONTENTS

Section	Title	Page	Section	Title	Page
I	GENERAL INFORMATION	1-1	3-33.	VS Section	
	1-1. Introduction	1-1		Operating Parameters ...	3-15
	1-4. Description	1-1	3-35.	Voltage Output	
	1-9. Specification	1-2		and Display of VS	3-15
	1-11. Safety Considerations	1-2	3-37.	Output Voltage Range	3-19
	1-14. Instruments		3-39.	Current Limit	3-19
	Covered by Manual	1-3	3-41.	VS Section	
	1-19. Options	1-13		Operating Instructions .	3-19
	1-21. Option 907, 908 or 909 ...	1-13	3-43.	I-V Measurement	3-22
	1-23. Option 910 Extra Manual ..	1-13	3-45.	I-V Measurement	
	1-25. Accessories Supplied	1-13		Data Output	3-22
	1-27. Accessories Available	1-13	3-47.	I-V Measurement	
				Operating Instructions .	3-25
II	INSTALLATION	2-1	3-49.	C-V Measurement	3-25
	2-1. Introduction	2-1	3-51.	C-V Measurement	
	2-3. Initial Inspection	2-1		Data Output	3-29
	2-5. Preparation for Use	2-1	3-53.	C-V Measurement Range ...	3-29
	2-6. Power Requirements	2-1	3-55.	C-V Measurement	
	2-8. Line Voltage and Fuse			Zero Offset	3-32
	Selection	2-1	3-57.	C-V Measurement	
	2-10. Power Cable	2-3		in Percent	3-33
	2-12. Operating Environment	2-3	3-59.	C-V Measurement	
	2-15. Installation Instructions .	2-3		Operating Instructions .	3-33
	2-17. Installation of		3-61.	DUT Connection	3-4
	Options 907, 908 and 909.	2-3	3-63.	DUT Connection Using	
	2-19. Storage and Shipment	2-4		the Wafer Prober	3-44
	2-20. Environment	2-4	3-65.	Annunciations	3-47
	2-22. Packaging	2-4	3-67.	Analog Output	3-4
			3-69.	Control Capabilities for	
III	OPERATION	3-1		Analog Output	3-49
	3-1. Introduction	3-1	3-71.	HP-IB Interface	3-52
	3-3. Panel Features	3-1	3-73.	Connection to HP-IB	3-5
	3-5. Self Test	3-1	3-75.	HP-IB Status Indicators ..	3-5
	3-8. Initial Control Settings	3-8	3-77.	Local Key	3-52
	3-10. Measurement Function	3-8	3-79.	HP-IB Control Switch	3-52
	3-12. pA (Pico-Ampere) Meter		3-81.	HP-IB Interface	
	Section	3-9		Capabilities of 4140B ..	3-50
	3-14. pA Meter Display	3-9	3-83.	Remote Program Code	3-53
	3-16. Current Measurement Ranges.	3-9	3-85.	Parameter Setting	3-5
	3-18. Integration Time		3-87.	Data Output	3-5
	and Data Output	3-10	3-89.	I-C Measurement Value and	
	3-21. External Triggering	3-10		VA Output Voltage	3-56
	3-23. Zero Offset for		3-91.	Parameter Output	3-5
	Current Measurement	3-11	3-93.	Key Status Data	3-5
	3-25. pA Meter		3-95.	Service Request	
	Operating Instructions .	3-11		Statu Byte	3-58
	3-27. VS (Voltage Source) Section.	3-14	3-97.	High Speed I (HSI)	
	3-29. VS Section Display	3-14		Function	3-5
	3-31. VS Section Output Modes ..	3-14	3-99.	Programming Guide	
				for 4140B	3-50

LIST OF TABLES

Number	Title	Page
1-1.	Specifications	1-4
1-2.	General Information	1-11
1-3.	Available Options	1-13
1-4.	Accessories Available	1-14
1-5.	Application Ranges of Accessories	1-13
3-1.	Automatic Control Settings	3-8
3-2.	Current Measurement Integration Time	3-10
3-3.	VS Section Output Modes	3-14
3-4.	VS Section Operating Parameters	3-15
3-5.	Inhibition of Controls and Operating Parameters (when VS Section is Operating) ..	3-16
3-6.	C-V Measurement Accuracy	3-33
3-7.	4140B Annunciations	3-47
3-8.	Analog Output Data at I/C OUTPUT Connector	3-49
3-9.	Analog Output Data at VA OUTPUT Connector	3-49
3-10.	X-Y Recorder Pen Position Control	3-50
3-11.	HP-IB Interface Capabilities ..	3-53
3-12.	Remote Program Code	3-53
3-13.	Program Code for Parameter Setting	3-56
3-14.	Accuracy and Data Output Interval in HSI Function	3-59
3-15.	Sample Program Using HP 9825A or 9835A Calculator	3-60
4-1.	Recommended Test Equipment	4-2
4-2.	Auto Setting Modes for Performance Tests and Adjustment	4-3
4-3.	Output Voltage Accuracy Test ...	4-5
4-4.	Current Measurement Accuracy Test	4-7

LIST OF ILLUSTRATIONS

Page	Number	Title	Page	Number	Title	Page
4-1	1-1.	Model 4140B and Supplied Accessories	1-1	3-18.	Relationship between C-V Measurement and Displays for  (Single Ramp Wave)	3-30
14	2-1.	Line Voltage and Fuse Selection	2-1	3-19.	Relationship between C-V Measurement and Displays for  (Double Ramp Wave)	3-30
14	2-2.	Power Cables Supplied	2-2	3-20.	Relationship between Calculated Capacitance Value and Current Measurement Range	3-31
16	2-3.	Rack Mount Kit	2-3	3-21.	Suitable Current Measurement Range for C-V Measurement ...	3-32
9	3-1.	Front Panel Features	3-2	3-22.	C-V Measurement Accuracy	3-34
9	3-2.	Rear Panel Features	3-6	3-23.	C-V Function Operating Instructions	3-38
1	3-3.	Octal Codes of Control Keys	3-8	3-24.	Effects of Leakage Current and External Noise	3-41
1	3-4.	Less Significant Zero	3-9	3-25.	Effects of the Low-Guard Method	3-41
3	3-5.	Integration Time and Data Output (when I TRIG is Set to INT) .	3-11	3-26.	DUT Connections with Each Accessory	3-42
	3-6.	pA Meter Section Operating Instructions (when FUNCTION is Set to I)	3-12	3-27.	DUT Connection Examples	3-43
	3-7.	Relationship between Output Voltage and Display for  (Single Staircase Wave) ...	3-17	3-28.	DUT Connections on Wafers at the Prober Station	3-45
	3-8.	Relationship between Output Voltage and Display for  (Double Staircase Wave) ...	3-17	3-29.	Analog Output Operating Instructions	3-50
	3-9.	Relationship between Output Voltage and Display for  (Single Ramp Wave)	3-18	3-30.	HP-IB Control Switch	3-52
	3-10.	Relationship between Output Voltage and Display for  (Double Ramp Wave)	3-18	3-31.	Status Bytes of the 4140B	3-58
	3-11.	Output Voltage Range of Staircase Wave	3-19	3-32.	Data Output Format of the HSI (High Speed I) Function	3-59
	3-12.	VS Section Operating Instructions (when FUNCTION is Set to I)	3-20	3-33.	Sample Program 1 Using 9825A/9835A	3-61
	3-13.	Relationship between I-V Measurement and Displays for  (Single Staircase Wave) ...	3-23	3-34.	Sample Program 2 Using 9825A/9835A	3-62
	3-14.	Relationship between I-V Measurement and Displays for  (Double Staircase Wave) ...	3-23	3-35.	Sample Program 3 Using 9825A/9835A	3-63
	3-15.	Relationship between I-V Measurement and Displays for  (Single Ramp Wave)	3-24	3-36.	Sample Program 4 Using 9825A/9835A	3-64
	3-16.	Relationship between I-V Measurement and Displays for  (Double Ramp Wave)	3-24	3-37.	Sample Program 5 Using 9825A/9835A	3-65
	3-17.	I-V Function Operating Instructions	3-25	4-1.	Voltage Output Accuracy Test Setup	4-4
				4-2.	Current Measurement Accuracy Test Setup	4-6

SECTION I

GENERAL INFORMATION

1-1. INTRODUCTION

1-2. This Operating Manual contains the information required to install, operate and test the Hewlett-Packard Model 4140B pA Meter/DC Voltage Source. Figure 1-1 shows the instrument and supplied accessories. This section covers the instrument identification, description, options, accessories, specifications and other basic information. To order an additional manual, use the part number listed on manual title page.

1-3. Also listed on the title page is a microfiche part number. This number can be used to order 4 x 6 inch microfilm transparencies of the manual. Each microfiche contains up to 98 photo-duplicates of the manual pages. The microfiche package also includes the latest Manual Changes supplement as well as pertinent Service Notes.

1-4. DESCRIPTION.

1-5. The HP Model 4140B pA Meter/DC Voltage Source comprises a high stability pA Meter with 10^{-15} A (max.) resolution coupled with two programmable DC voltage sources to ensure useability in many application areas. The pA meter has a basic accuracy of 0.5% over wide measurement ranges ($\pm 0.001 \times 10^{-12}$ A \sim $\pm 1.999 \times 10^{-2}$ A) enabling stable pA current measurement at 10^{-15} A (± 1 count). This is achieved by employing a new unique, variable, digital, integration method. This stable and fast (less than 35ms at 1nA) measurement technique is very useful, not only for the measurement of the small leakage currents of semiconductor devices and the static characteristics of FET's, but also for making insulation resistance/leakage, current/absorption measurements/analyses of capacitance and insulation materials. One of the two program-

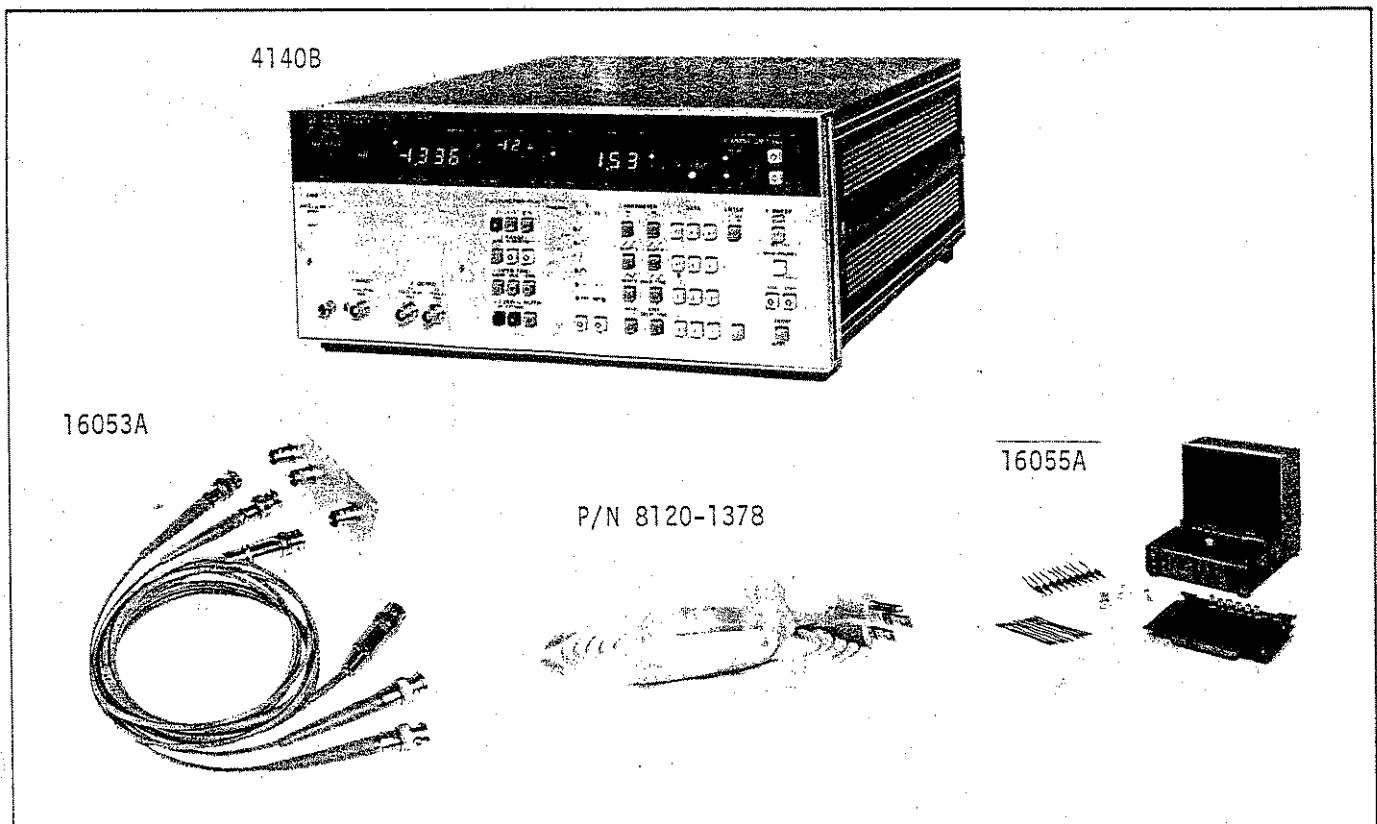







Figure 1-1. Model 4140B and Supplied Accessories.

mable DC voltage sources (VA) can operate not only as a programmable DC voltage source, but also as a unique staircase ( , ) and accurate ramp ( , ) generator. The DC Voltage Source has an output range of $\pm 100V$ in 100mV steps or $\pm 10V$ in 10mV steps, and the ramp rate can be set from 0.001V/s to 1V/s at 0.001V/s resolution. The sweeps of the staircase and ramp functions operate, both in the AUTO sweep mode with a pause key (for changing step voltage and sweep direction during measurement) and in the MANUAL sweep mode with down () and up () keys. Each programmable DC voltage source (VA and VB) has a current limiter to avoid damaging the DUT by excessive current.

1-6. A key capability of the 4140A is its ability to make accurate I-V/C-V measurements. Measurement timing can be automatically synchronized between the DC Voltage Source and the pA Meter section. The start, stop and step voltages can be set from -100V to +100V at 100mV resolution (from -10V to +10V at 10mV resolution). The hold/step delay time can also easily be set depending upon the characteristics of the material being tested. All these capabilities are featured in the HP 4140B itself which, up to now, has required an extensive instrument system. Static characteristics of semiconductors, diodes and FET's, the analysis of MIS construction, and the measurement of the threshold voltages of FET's in addition to 1 minute value measurements for insulation resistances (resistance values of approximately $0.5\Omega \sim 10^{17}\Omega$ can be calculated from the I-V measured values) can be made easily, quickly, and efficiently with the 4140B. With the 4140B it is especially easy to make a quasi-static C-V measurement (a capacitance measurement utilizing a ramp-wave) which is usually employed as one of the measurements when trying to improve semiconductor quality. The 4140A measures capacitance value by the following formula:

$$C = \frac{I \text{ (measured current value)}}{dV/dt \text{ (ramp rate)}}$$

This is possible with the 4140B because both the desired setting of the ramp voltage and the capacitance measurement are completely synchronized, and the calculated capacitance value (0.0 ~ 1999pF) or percent change (0.0% ~ 199.9%) VS Cox (the capacitance of oxide film) and the appropriate ramp voltage value are simultaneously displayed.

1-7. The 4140B employs certain particular functions which make the best use of the intelligence capability of its microprocessor. For example, its zero offset current capability cancels leakage current of test leads, fixtures, and its zero offset capacitance capability cancels stray capacitances of test leads and fixtures for accurate current capacitance measurements. The self-test capability checks ROM's, RAM's, displays, indicators and control keys of the 4140B automatically when the 4140B is turned ON or SELF TEST front panel key is pushed. Measurement parameters of the 4140B (VA = VB =, START V, STOP V, STEP V, HOLD TIME, dt, STEP DELAY TIME and Cox) are stored in the 4140B memory and can be used repeatedly.

1-8. The 4140B provides Analog Output which can be used to output analog data to an X Recorder and to trace I-V/C-V curves. The 4140B also provides HP-IB Interface for remote control and data output via the HP- In addition, four unique accessories are available for making a wide range of universal measurements.

1-9. SPECIFICATIONS

1-10. Complete specifications of the 4140B pA Meter/DC Voltage Source are given in Table 1-1. These specifications are the performance standards or limits against which the instrument is tested. The test procedure for the specifications are covered in Section IV, Performance Test. Table 1-2 lists general information. General information not specifications but is typical characteristics included as additional information for the operator. When the 4140B pA Meter/Voltage Source is shipped from the factory it meets the specifications listed in Table 1-1.

1-11. SAFETY CONSIDERATIONS

1-12. The Model 4140B pA Meter/DC Voltage Source has been designed to conform to safety requirements of an IEC (International Electromechanical Committee) Safety Class instrument (provided with a protective ear terminal), and is shipped from the factory in a safe condition.

1-13. This operating manual contains information, cautions, and warnings which must be followed by the user to ensure safe operation and to maintain the instrument in a safe condition.

1-14. INSTRUMENTS COVERED BY MANUAL.

1-15. A serial number plate is attached to the rear of the instrument. The serial number is in the form: xxxxJxxxx. It is in two parts, the first four digits and the letter are the serial prefix and the last five digits are the suffix. The prefix is the same for all identical instruments; it changes only when a change is made to the instrument. The suffix however, is assigned sequentially and is different for each instrument. The contents of this manual apply to instruments with the serial number prefix(es) listed under SERIAL NUMBERS on the title page.

1-16. An instrument manufactured after the printing of this manual may have a serial number prefix that is not listed on the title page. This unlisted serial number prefix indicates that the instrument is different from those described in this manual. The manual

for this newer instrument is accompanied by a yellow Manual Changes supplement. This supplement contains "change information" that explains how to adapt the manual to the newer instrument.

1-17. In addition to change information, the supplement may contain information for correcting errors in the manual. To keep this manual as current and accurate as possible, Hewlett-Packard recommends that you periodically request the latest Manual Changes supplement. The supplement for this manual is identified with the manual print date and part number, both of which appear on the manual title page. Complimentary copies of the supplement are available from Hewlett-Packard.

1-18. For information concerning a serial number prefix that is not listed on the title page or in the Manual Changes supplement, contact your nearest Hewlett-Packard office.











Table 1-1. Specifications(sheet 1 of 7).

Measurement Functions: I-V, C-V and I

- I: For independent operations as universal pA Meter/Programmable Voltage Source
- I-V: I-V characteristic measurement using staircase/ramp wave
- C-V: Quasi-Static C-V characteristic measurement using ramp wave

Voltage Source: Two separate sources (VA and VB)

- VA: $\pm 100V$, function generator/programmable source
- VB: $\pm 100V$, programmable DC voltage source

Function	VA	VB
I-V	 ,  ,  , 	==
C-V	 , 	
I	 ,  ,  ,  , 	

Voltage Sweep: Auto (pause available)/Manual

Warm-up Time: ≥ 1 hour

GENERAL

Operating Temperature: $0^{\circ}C$ to $40^{\circ}C$

Relative Humidity: $\leq 70\%$ at $40^{\circ}C$

Power: 100/120/220V $\pm 10\%$, 240V-10%+5%, 50Hz/60Hz $\pm 5\%$, max. 135VA with any option.

Dimensions: 426mmW x 177mmH x 498mmD

Weight: Approx. 14.4kg

Accessory Furnished: 16053A Test Leads (1 set), 16055A Test Fixture.

Table 1-1. Specifications(sheet 2 of 7).

CURRENT MEASUREMENT

Display: 3-1/2 digit, 99.9% overrange.

Measurement Range: $\pm 0.001 \times 10^{-12} \text{A} \sim \pm 1.999 \times 10^{-2} \text{A}$, 11 ranges, auto/manual range selection.

Measurement Accuracy/Integration Time:

Range(A)	Measurement Accuracy*	Integration Time(ms)**		
		SHORT	MED	LONG
$10^{-2} \sim 10^{-9}$	$\pm (0.5 + 2)$	20	80	320
10^{-10}	$\pm (2 + 2)$			
10^{-11}	$\pm (5 + 3)$	80	320	1280
10^{-12}^{***}	$\pm (5 + 8)$	160	640	2560

* \pm (% of rdg + counts), $23^\circ\text{C} \pm 5^\circ\text{C}$, $\leq 70\%$ humidity, integration time...LONG, filter...ON.

** at 50Hz line frequency (x 5/6 at 60Hz operation).

*** Zero offset is performed.

Voltage Burden: $\leq 10\mu\text{V}$ at full scale.Internal Electromotive Force: $\leq 100\mu\text{V}$ at $23^\circ\text{C} \pm 5^\circ\text{C}$.

Maximum Input:

Hi-Lo (peak value): $\pm 2\text{V}$ at $10^{-2} \sim 10^{-3} \text{A}$ range.
 $\pm 30\text{V}$ at $10^{-4} \sim 10^{-5} \text{A}$ range.
 $\pm 120\text{V}$ at $10^{-6} \sim 10^{-12} \text{A}$ range.

Lo-Guard: $\pm 200\text{V}$.

Zero Offset: Cancels leakage current of test leads/fixtures.

Offset Ranges: $0 \sim \pm 100\text{fA}$.

Trigger: INT/EXT or MAN.







High Speed I Data Output: Outputs current measurement data with max. 4ms intervals. (Refer to reference data for accuracy).

Input Terminal: Triaxial BNC (HP Part No.: 1250-0687).

Table 1-1. Specifications(sheet 3 of 7).

DC VOLTAGE SOURCE (VA AND VB)

Output Mode:

VA: , , , , , OFF
VB: , OFF

Voltage Range: 0 ~ ±10.00V, 0 ~ ±100.0V, 2 ranges (autoranging only).

Max. Current Capacity: 10mA.

Sweep Control: Auto (pause available)/man., up/down manually available in hold.

Operating Parameters Setting Ranges:

Start/Stop/DC Voltage: 0 ~ ±10.00V in 0.01V steps, 0 ~ ±100.0V in 0.1V steps



Step Voltage: ±0.01V ~ ±10.00V in 0.01V steps (0.1V step at 10V of absolute value of output voltage)

Hold Time: 0 ~ 199.9s in 0.1s steps, 0 ~ 1999s in 1s steps.

Step Delay Time: 0 ~ 10.00s in 0.01s steps, 0 ~ 100.0s in 0.1s steps.

Ramp Rate (dV/dt): 0.001V/s ~ 1.000V/s in 0.001V/s steps.

Accuracy: at (23°C ± 5°C)

Output Voltage (, , ):

±10V: ±(0.07% + 11mV).

±100V: ±(0.09% + 110mV).

Accuracy of Ramp Voltage* :

Ramp Rate: ±(0.2% + 10_μV/s) - $\frac{10^{-5} \times \text{START Voltage (V)}}{\text{HOLD TIME (s)} + 2\text{s}}$

±(0.2% + 80_μV/s) - $\frac{10^{-5} \times \text{START Voltage (V)}}{\text{HOLD TIME (s)} + 2\text{s}}$

- - if absolute setting value for START or STOP Voltage > 10V.

Linearity:

±{0.1% + $\frac{0.0003\text{V/s}}{\text{RAMP RATE (V/s)}}$ } - $\frac{0.001 \times \text{START Voltage (V)}}{\text{RAMP RATE (V/s)} \times (\text{HOLD TIME (s)} + 2\text{s})}$ %

±{0.2% + $\frac{0.003\text{V/s}}{\text{RAMP RATE (V/s)}}$ } - $\frac{0.001 \times \text{START Voltage (V)}}{\text{RAMP RATE (V/s)} \times (\text{HOLD TIME (s)} + 2\text{s})}$ %

- - if absolute setting value for START or STOP voltage > 10V.

- * : 1. Temperature Change: ≤ 3.6°C/hour.
2. Time after start of ramp ≥ 2s.

Table 1-1. Specifications(sheet 4 of 7).

Start Stop Voltage (only for \int , \wedge): $\pm 20\text{mV}$
($\pm 200\text{mV} \dots \geq 10\text{V}$ of absolute setting value for START or STOP voltage).

→ Display of Output Voltage (only for \int , \wedge): $\pm(0.07\% + 16\text{mV})$
($\pm 0.09\% + 160\text{mV}$) $\geq 10\text{V}$ of absolute setting value for START or STOP voltage).

Step Delay/Hold Time: Accuracy is dependent on accuracy of line frequency
(50Hz or 60Hz).

Current Limit: 10^{-4}A , 10^{-3}A or $10^{-2}\text{A} \pm 10\%$.

Output Terminals: .BNC, L-GND.

C-V MEASUREMENT

Calculation Equation $C(F) = \text{measured current value (A)}/\text{ramp rate (V/s)}$

Measurement Range: $0.0\text{pF} \sim 199.9\text{pF}$, $200\text{pF} \sim 1999\text{pF}$, 2 ranges of Auto range.

% change Display: Capacitance change is displayed as a % of the initial setting value of C_{ox} (100%).

% Display Range: $0.0\% \sim 199.9\%$.

C_{ox} Setting Range: $0.1\text{pF} \sim 199.9\text{pF}$, $200\text{pF} \sim 1999\text{pF}$.

Capacitance Calculation Accuracy: Depends on accuracies of both current measurement and linearity of ramp wave
(refer to paragraph 3-53).

Zero Offset: Cancels stray capacitances of test leads/fixtures.

Offset range: $0 \sim 100\text{pF}$.

Table 1-1. Specifications(sheet 5 of 7).

OTHER

Analog Output:

Output Data: VA, I and C

Output Voltage:

Output Data	Output Voltage (Resolution)
VA ±10V ±10.1V ~ ±100V	0 ~ ±1.000V (1mV/count) ±1.01 ~ ±10.00V (10mV/count)
I Full Scale	±5V (5mV/count)
C Full Scale 100pF 1000pF 100% (% Display)	0.5V (0.5mV/count) 5V (5mV/count) 5V (5mV/count)

Accuracy: ±(0.5% + 20mV)

Low Pass Filter: OFF, 0.22s ± 20% and 1s ± 20% applied to both VA and I/C Data Output

Pen Lift Output: TTL low level (≤0.8V) during sweep period in I-V/C-V function

Recorder Scale Output: Upper right/lower left scale output for location adjustment of recorder

Key	VA output	I/C output
U.R. (Upper Right)	Either maximum voltage value of START or STOP voltages.	Full scale value of (+) plus sign.
L.L. (Lower Left)	Either minimum voltage value of START or STOP voltages.	Full scale value of (-) minus sign. 0V (0pF) for C-V measurement.
ZERO	0V	0V

HP-IB Interface: IEEE 488-1975, ANSI. STANDARD MC 1.1

Interface Functions: SHI AHI T5 L4 SR1 RL1 DC1 DT1

Remotely Controllable Functions: Measurement Function, Current Range, Lower Limit of Auto Mode, Integration Time, I Trig, Filter, Voltage Sweep Control, Current Limit, Voltage of VA/VB, Setting Times and Self Test.

Data Output: Measured Data (I, C and VA),
Voltage Settings (VA, VB),
Setting Times,
Setting Value of Cox and,
Front Panel Key Status.

Table 1-1. Specifications(sheet 6 of 7).

OPTIONS

- Option 907: Front Handle Kit (5061-0090).
 Option 908: Rack Flange Kit (5061-0078).
 Option 909: Rack and Handle Kit (5061-0084).
 Option 910: Extra Manual.

ACCESSORIES AVAILABLE

16053A: Test Leads (furnished with the 4140B)

One triaxial (male) - triaxial (male) cable, two BNC (male) - BNC (male) cables, and connection plate with female connectors (one triaxial and two BNC) are furnished. Each cable is 1 meter long. Useful for connecting user designed prober station/measurement fixture.

16054A: Connection Selectors

Selects connection of low lead for pA Meter section as in following figure. Used in conjunction with the 16053A.

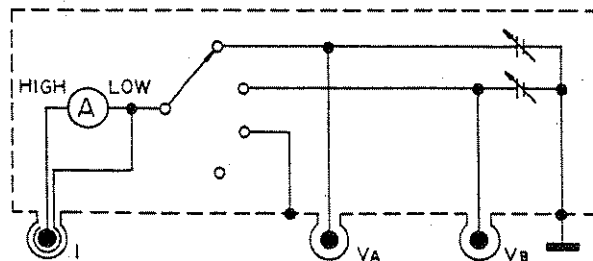

16055A: Test Fixture for General Device Measurements (furnished with the 4140B)

For stable pA current measurements with electrostatic/light shielded hood. Alligator clips/T0-5 socket with connection plates for easy connection to actual devices.

16056A: Current Divider (10:1)

Extends 10^{-2} A range to 10^{-1} A (use only on 10^{-2} A range).

Table 1-1. Specifications(sheet 7 of 7).

Other Accessories/Recommended Stock Parts:

Descriptions	HP Model/Part Number
HP-IB Cable 0.5m 1m 2m 4m	10631D 10631A 10631B 10631C
Triaxial Connector Female Male {	1250-0687 1250-1413 16053-24001 16053-24002
BNC Connector Female Male	1250-1279 1250-0408
16055A Accessories Connection Plate with Alligator Clip Connection Plate with T0-5 Socket (10pins) Alligator Clips (5ea) Connection Leads for T0-5 Socket (5ea) T0-5 Socket (8pins) T0-5 Socket (10pins) T0-5 Socket (12pins)	16055-65001 16055-65002 16055-65003 16055-65004 1200-0238 1200-0239 1200-0240
Triaxial Cable (approx 1m)	16053-61002
BNC-BNC Cable (approx 1m)	16053-61003
Connection Plate for the 16053A	16053-61001

Table 1-2. General Information (sheet 1 of 3).

CURRENT MEASUREMENT

Typical Response time: 0 ~ 90%, FILTER...OFF.

Measurement Range (A)	Response Time		Measurement Range (A)	Response Time	
	C ≤ 2pF	C = 2nF		C ≤ 2pF	C = 2nF
10 ⁻² ~ 10 ⁻⁵	≤1ms		10 ⁻¹⁰ , 10 ⁻¹¹	≤50ms	≤200ms
10 ⁻⁶ , 10 ⁻⁷	≤3ms			10 ⁻¹²	≤600ms
10 ⁻⁸ , 10 ⁻⁹	≤15ms				

"C" = capacitance value of test leads/fixtures.
When FILTER is ON, add 60ms (at 50Hz) or 50ms (at 60Hz).

Common Mode Rejection Ratio: ≥120dB (≤2 counts).

Current Measurement Accuracy*:

I RANGE (A)	FILTER	INTEGRATION TIME			High Speed I Data Out
		SHORT	MEDIUM	LONG	
10 ⁻² ~ 10 ⁻⁸	ON	±(0.5+3)	±(0.5+2)	±(0.5+2)	/
	OFF	±(0.5+4)	±(0.5+3)	±(0.5+2)	
10 ⁻⁹	ON	±(0.5+3)	±(0.5+3)	±(0.5+2)	/
	OFF	±(0.5+10)	±(0.5+7)	±(0.5+3)	
10 ⁻¹⁰	ON	±(2+4)	±(2+3)	±(2+2)	/
	OFF	±(2+10)	±(2+7)	±(2+3)	
10 ⁻¹¹	ON	±(5+10)	±(5+4)	±(5+3)	/
	OFF	±(5+30)	±(5+15)	±(5+10)	
10 ^{-12**}	ON	±(5+20)	±(5+10)	±(5+8)	/
	OFF	±(5+30)	±(5+15)	±(5+10)	

* ±(% of reading + counts) at 23°C ± 5°C, ≤70% humidity.
** Zero offset is performed.

Minimum Data Output Trigger Cycle:



VA	C-V	I-V
		25ms
		50ms

Table 1-2. General Information (sheet 2 of 3).

I Data Output Trigger:

TRIGGER	I Function	High Speed I Data Output
INT.	approx. 200ms	approx. 10ms*
EXT.**	≥Integration Time + 3ms	≥4ms
MAN.***		_____

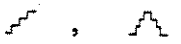
* At 50Hz line frequency (x5/6 at 60Hz operation).

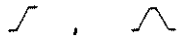
** Triggered when the logic signal (≥1μs) goes to "0" (short or ≤100Ω of resistance) from "1".

*** Triggered by HOLD/MAN. key.

Current Measurement Ranging Time (ms):

Start Range (A)	Optimum Range (A)										
	10 ⁻²	10 ⁻³	10 ⁻⁴	10 ⁻⁵	10 ⁻⁶	10 ⁻⁷	10 ⁻⁸	10 ⁻⁹	10 ⁻¹⁰	10 ⁻¹¹	10 ⁻¹²
10 ⁻²		340	960	1300	1920	2260	3080	3420	4940	5280	7760
10 ⁻³	20 340		620	960	1580	1920	2740	3080	4600	4940	7420
10 ⁻⁴	320 640	300 620		340	960	1300	2120	2460	3980	4320	6800
10 ⁻⁵	340 660	320 640	20 340		620	960	1780	2120	3640	3980	6460
10 ⁻⁶	640 960	620 940	320 640	300 620		340	1160	1500	3020	3360	5840
10 ⁻⁷	660 980	640 960	340 660	320 640	20 340		820	1160	2680	3020	5500
10 ⁻⁸	960 1280	940 1260	640 960	620 940	320 640	300 620		340	1860	2200	4680
10 ⁻⁹	980 1300	960 1280	660 980	640 960	340 660	320 640	20 340		1520	1860	4340
10 ⁻¹⁰	1480 1800	1460 1780	1160 1480	1140 1460	840 1160	820 1140	520 840	500 820		340	2820
10 ⁻¹¹	1500 1820	1480 1800	1180 1500	1160 1480	860 1180	840 1160	540 860	520 840	20 1300		2480
10 ⁻¹²	2700 3020	2680 3000	2380 2700	2360 2680	2060 2380	2040 2360	1740 2060	1720 2040	1220 2500	1200 3760	

Each value is the ranging time, from the start range to the optimum range. All values are in milliseconds. Times to the right of the diagonal line are downward ranging times. Times to the left of the diagonal line are upward ranging times (the upper values are ranging times when the internal current measurement circuit is saturated, and the lower values are when it isn't saturated).

Table 1-2. General Information (sheet 3 of 3).

DC VOLTAGE SOURCE
Output Resistance: $\leq 1\Omega$.
Output Impedance: $\leq 1\Omega$ at 10Hz, $\leq 100\Omega$ at 100Hz.
Program Speed (, ,): Approx. 2.5ms(1V/ms through rate)
Ranging: approx. 30ms.

1-19. OPTIONS.

1-20. Available Options for the Model 4140B are listed in Table 1-3.

Table 1-3. Available Options.

Option	Description
907	Front Handle Kit
908	Rack Flange Kit
909	Rack Flange and Front Handle Kit
910	Extra Manual

1-21. Option 907, 908 or 909.

1-22. Option 907, 908 or 909 provides the mechanical parts necessary for rack mounting. Installation procedures for these options are detailed in Section II.

1-23. Option 910 Extra Manual.

1-24. Option 910, Extra Manual, provides an extra copy of the Operating and Service Manual.

1-25. ACCESSORIES SUPPLIED.

1-26. Figure 1-1 shows the HP Model 4140B pA Meter/DC Voltage Source, Model 16053A Test Lead, Model 16055A Test Fixture and power cord (HP Part No. 8120-1378). The 16053A, the 16055A and the power cord are furnished accessories.

1-27. ACCESSORIES AVAILABLE.

1-28. For convenience and ease of measurement, four styles of accessories are available. Photos and descriptions of accessories are given in Table 1-4 and application ranges of accessories are given in Table 1-5.

⚠ WARNING

DO NOT USE 16055A TEST FIXTURE WITH 16054A CONNECTION SELECTOR. HAZARDOUS VOLTAGE MAY EXIST ON LOW LEAD TERMINAL EVEN IF 16055A LOW LEAD CONNECTION SELECT SWITCH IS SET TO GND POSITION WHEN 16054A LOW LEAD CONNECTION SELECT SWITCH IS SET TO VA OR VB POSITION.

Table 1-5. Application Ranges of Accessories.

Model	Current Range	In Combination
16053A	All ranges: $10^{-12}A \sim 10^{-2}A$	
16054A		
16055A		
16056A	$10^{-2}A$ range	

Table 1-4. Accessories Available (Sheet 1 of 2).

Model	Description
	<p>16053A Test Lead (Furnished with the 4140B) Triaxial Cable (1), BNC Cable (2), and Connection Plate.</p> <p>Triaxial Cable (HP P/N 16053-61002): Triaxial cable with triaxial male connectors. 1m length.</p> <p>BNC cable (HP P/N 16053-61003): Coaxial cable with BNC male connectors. 1m length.</p> <p>Connection Plate (HP P/N 16053-61001): Connection Plate with triaxial (1) and BNC (2) female connectors.</p> <p>Useful for connecting prober station, measurement fixture designed by user and other 4140B accessories.</p>
	<p>16054A Connection Selector Selects connection of low lead for 4140B pA Meter section. Used in conjunction with the 16053A. Internal connections are approximately as follows:</p> 

Table 1-4. Accessories Available (Sheet 2 of 2).

Model	Description																
	<p>16055A Test Fixture (Furnished with the 4140B) Used for general device measurements. For stable pA current measurements with electrostatic/light shielded hood. Furnished accessories, used in conjunction with the 16053A, include the following:</p> <table border="1" data-bbox="781 646 1468 1031"> <thead> <tr> <th data-bbox="781 646 1279 699">Descriptions</th> <th data-bbox="1279 646 1468 699">HP P/N</th> </tr> </thead> <tbody> <tr> <td data-bbox="781 699 1279 772">Connection plate with alligator clip</td> <td data-bbox="1279 699 1468 772">16055-65001</td> </tr> <tr> <td data-bbox="781 772 1279 804">Alligator clips (5ea)</td> <td data-bbox="1279 772 1468 804">16055-65003</td> </tr> <tr> <td data-bbox="781 804 1279 863">Connection plate with TO-5 socket</td> <td data-bbox="1279 804 1468 863">16055-65002</td> </tr> <tr> <td data-bbox="781 863 1279 921">Connection leads for TO-5 socket (5ea)</td> <td data-bbox="1279 863 1468 921">16055-65004</td> </tr> <tr> <td data-bbox="781 921 1279 953">TO-5 Socket (8 pins)</td> <td data-bbox="1279 921 1468 953">1200-0238</td> </tr> <tr> <td data-bbox="781 953 1279 984">TO-5 Socket (10 pins)</td> <td data-bbox="1279 953 1468 984">1200-0239</td> </tr> <tr> <td data-bbox="781 984 1279 1016">TO-5 Socket (12 pins)</td> <td data-bbox="1279 984 1468 1016">1200-0240</td> </tr> </tbody> </table>	Descriptions	HP P/N	Connection plate with alligator clip	16055-65001	Alligator clips (5ea)	16055-65003	Connection plate with TO-5 socket	16055-65002	Connection leads for TO-5 socket (5ea)	16055-65004	TO-5 Socket (8 pins)	1200-0238	TO-5 Socket (10 pins)	1200-0239	TO-5 Socket (12 pins)	1200-0240
Descriptions	HP P/N																
Connection plate with alligator clip	16055-65001																
Alligator clips (5ea)	16055-65003																
Connection plate with TO-5 socket	16055-65002																
Connection leads for TO-5 socket (5ea)	16055-65004																
TO-5 Socket (8 pins)	1200-0238																
TO-5 Socket (10 pins)	1200-0239																
TO-5 Socket (12 pins)	1200-0240																
	<p>16056A Current Divider Extends 10^{-2}A range to 10^{-1}A. Useable only on 10^{-2}A range.</p>																

SECTION II INSTALLATION

2-1. INTRODUCTION

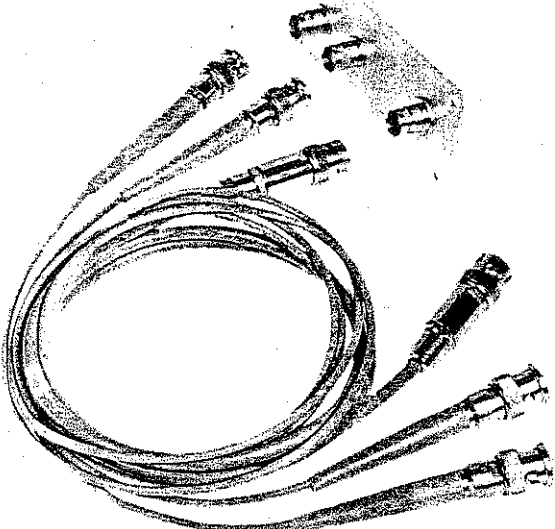
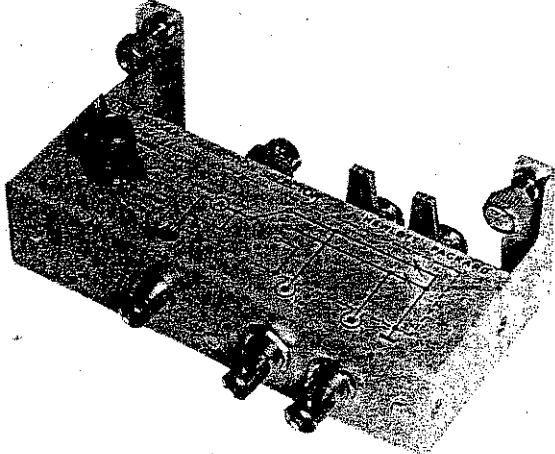
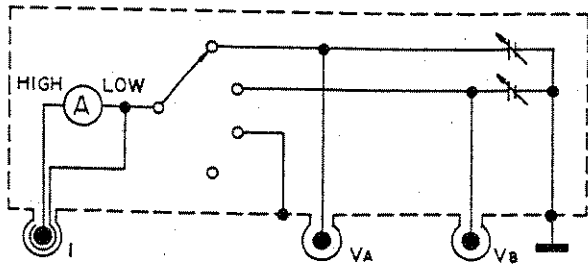
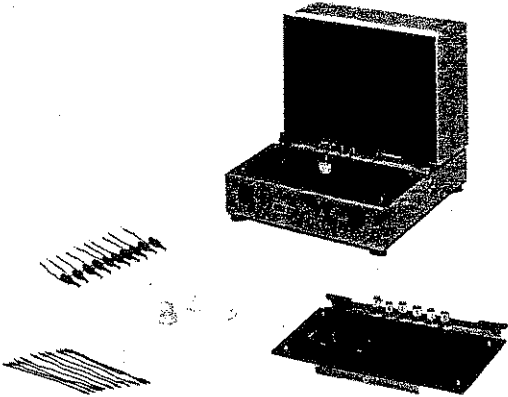
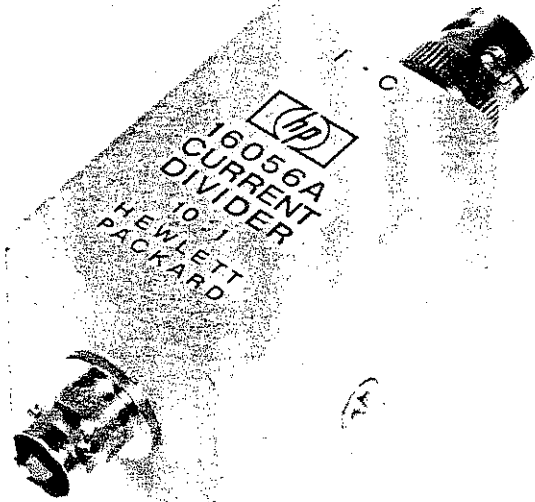
2-2. This section provides installation instructions for the Model 4140B pA Meter/DC Voltage Source and its accessories. This section also includes information for initial inspection and damage claims, preparations for using the 4140B and packaging, storage and shipment.

2-3. INITIAL INSPECTION

2-4. Inspect the shipping container for damage. If the shipping container or cushioning material is damaged, it should be kept until the contents of the shipment have been checked for completeness and the instrument has been checked mechanically and electrically. The contents of the shipment should be as shown in Figure 1-1; procedures for checking electrical performance are given in Section IV. If the contents are incomplete, if there is mechanical damage or defects, or if the 4140B does not pass the Performance Tests, notify the nearest Hewlett-Packard office. If the shipping container is damaged, or the cushioning material shows signs of stress, notify the carrier as well as your Hewlett-Packard office. Keep the shipping

materials for carrier's inspection. The HP office will arrange for repair or replacement, at HP option, without waiting for claim settlement.

WARNING

TO AVOID HAZARDOUS ELECTRICAL SHOCK,
DO NOT PERFORM ELECTRICAL TESTS WHEN
THERE ARE SIGNS OF SHIPPING DAMAGE TO
ANY PORTION OF THE OUTER ENCLOSURE
(COVERS, PANELS, OR METERS).

2-5. PREPARATION FOR USE

2-6. Power Requirements.

2-7. The 4140A requires a power source of 100, 120, 220Vac $\pm 10\%$, or 240Vac $+5\% -10\%$, 50, 60Hz $\pm 5\%$ single phase. Power consumption is less than 135VA.

2-8. Line Voltage and Fuse Selection.

2-9. Figure 2-1 provides instructions for line voltage and fuse selection. The line voltage selection switch and the proper fuse are factory installed for 100 or 120Vac operation.

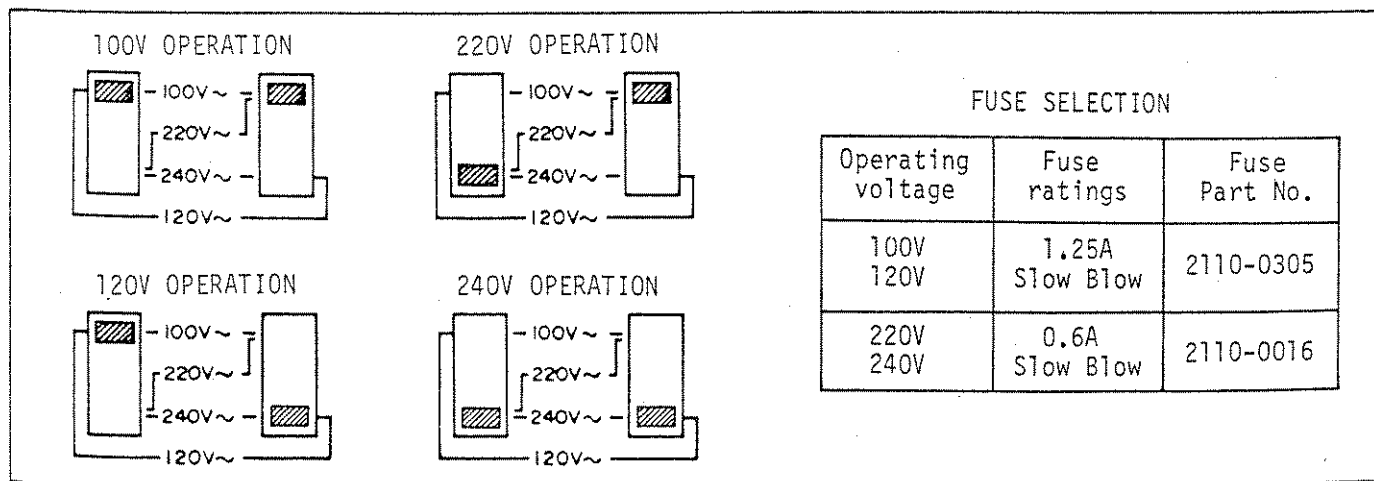

Figure 2-1. Line Voltage and Fuse Selection.

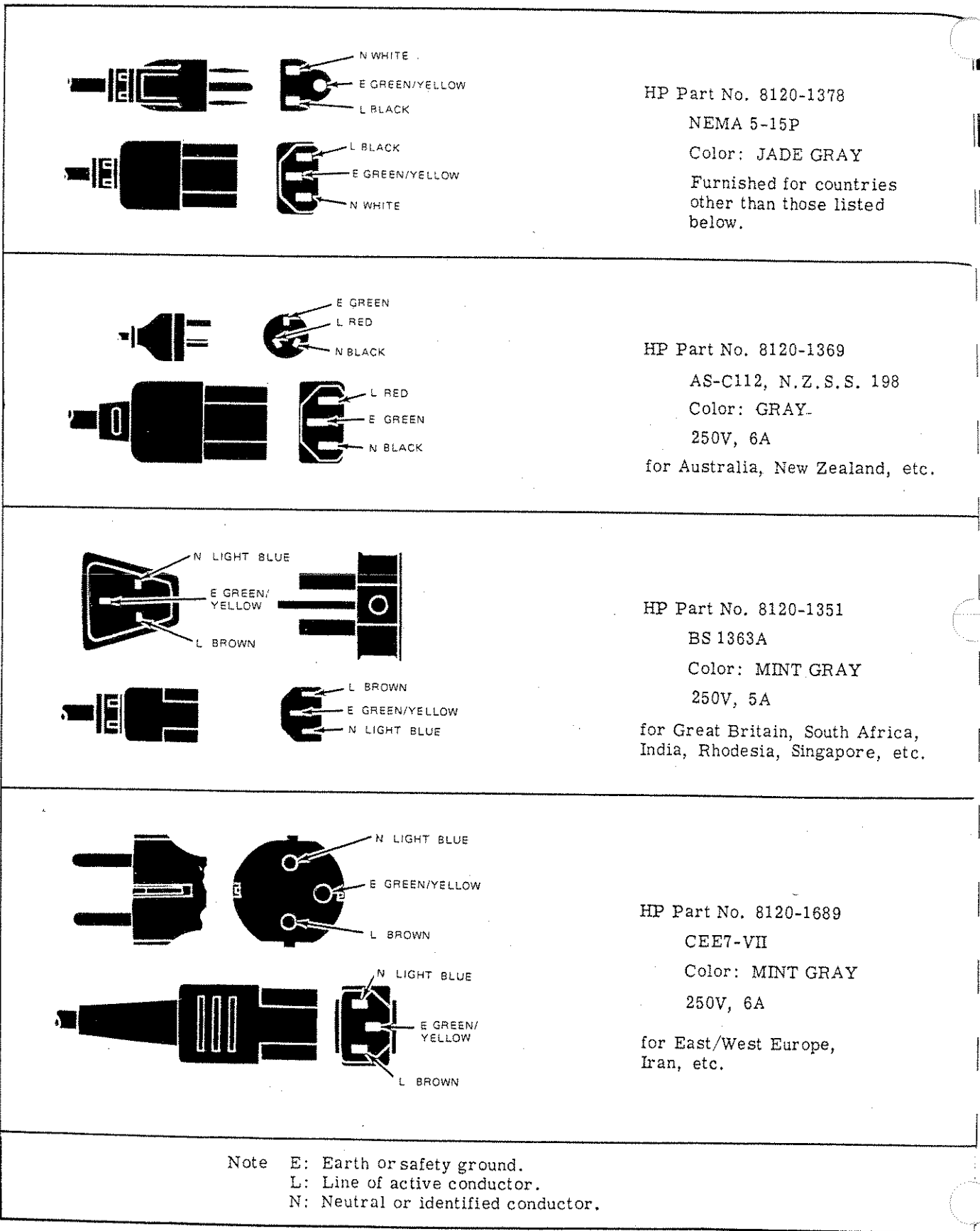

Figure 2-2. Power Cables Supplied.

2-10. Power Cable.

2-11. This instrument is equipped with a three-wire power cable. When connected to an appropriate ac power receptacle, this cable grounds the instrument cabinet. The type of power cable plug shipped with each instrument depends on the country of destination. Refer to Figure 2-2 for power cable part numbers and plug configurations available.

Note

Check local electrical codes for proper plug (attachment cap) selection for your area.

2-12. Operating Environment.

2-13. Temperature. The instrument may be operated at temperatures from 0°C to ±40°C.

2-14. Humidity. The instrument may be operated in environments with humidities up to 70% at 40°C. However, the instrument should be protected from temperature extremes which cause condensation within the instrument.

2-15. Installation Instructions.

2-16. The HP Model 4140B can be operated on the bench or in a rack mount. The 4140B is ready for bench operation as shipped from the factory. For bench operation, a two-leg instrument stand is used. For use, the instrument stands are designed to be pulled towards the front of instrument.

2-17. Installation of Options 907, 908 and 909.

2-18. The 4140B can be installed in a rack and be operated as a component of a measurement system. Rack mounting information for the 4140B is presented in Figure 2-3.

Option	Kit Part Number	Parts Included	Part Number	Q'ty	Remarks
907	Handle Kit 5061-0090	Front Handle Trim Strip #8-32 x 3/8 Screw	5060-9900 5060-8897 2510-0195	2 2 8	9.525mm
908	Rack Flange Kit 5061-0078	Rack Mount Flange #8-32 x 3/8 Screw	5020-8863 2510-0193	2 8	9.525mm
909	Rack Flange & Handle Kit 5061-0084	Front Handle Rack Mount Flange #8-32 x 3/8 Screw	5060-9900 5020-8875 2510-0194	2 2 8	15.875mm

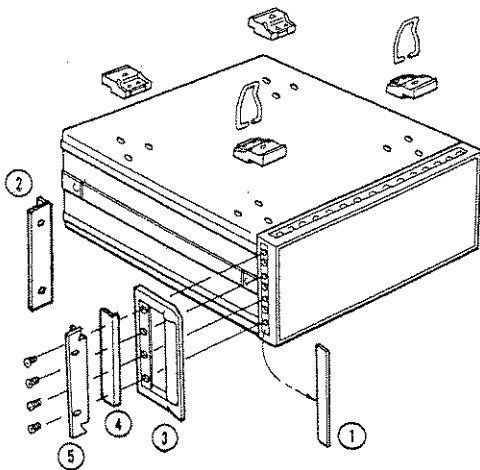

1. Remove adhesive-backed trim strips ① from sides at right and left front of instrument.
2. HANDLE INSTALLATION: Attach front handle ③ to sides at right and left front of instrument with screws provided and attach trim strip ④ to handle.
3. RACK MOUNTING: Attach rack mount flange ② to sides at right and left front of instrument with screws provided.
4. HANDLE AND RACK MOUNTING: Attach front handle ③ and rack mount flange ⑤ together to sides at right and left front of instrument with screws provided.
5. When rack mounting (3 and 4 above), remove all four feet.

Figure 2-3. Rack Mount Kit.

2-19. STORAGE AND SHIPMENT

2-20. Environment.

2-21. The instrument may be stored or shipped in environments within the following limits:

Temperature -40°C to +75°C
Humidity Up to 95% at +45°C

The instrument should also be protected from temperature extremes which could cause condensation within the instrument.

2-22. Packaging.

2-23. Original Packaging. Containers and materials identical to those used in factory packaging are available through Hewlett-Packard offices. If the instrument is being returned to Hewlett-Packard for servicing, attach a tag indicating the type of service required, return address, model number, and full serial number. Also, mark the container FRAGILE to ensure careful handling. In any correspondence, refer to the instrument by model number and full serial number.

2-24. Other Packaging. The following general instructions should be used for re-packing with commercially available materials:

- a. Wrap instrument in heavy paper or plastic. (If shipping to Hewlett-Packard office or service center, attach tag indicating type of service required, return address, model number and full serial number.)
- b. Use strong shipping container. A double-wall carton made of 350-pound test material is adequate.
- c. Use a layer of shock-absorbing material 70 to 100mm (3 to 4 inches) thick around all sides of the instrument to provide firm cushioning and to prevent shifting inside container. Protect control panel with cardboard.
- d. Seal shipping container securely.
- e. Mark shipping container FRAGILE to ensure careful handling.
- f. In any correspondence, refer to instrument by model number and full serial number.

SECTION III OPERATION

3-1. INTRODUCTION.

3-2. This section provides the operating instructions for acquainting the user with the Model 4140B pA Meter/DC Voltage Source. Instructions for panel controls, measurement functions, operating procedures, self test, and option information are included in this section. Operating precautions given throughout the text should be carefully observed.

WARNING

BEFORE THE INSTRUMENT IS SWITCHED ON, ALL PROTECTIVE EARTH TERMINALS, EXTENSION CORDS, AUTO-TRANSFORMERS AND DEVICES CONNECTED TO IT SHOULD BE CONNECTED TO A PROTECTIVE EARTH GROUNDED SOCKET. ANY INTERRUPTION OF THE PROTECTIVE EARTH GROUNDING WILL CAUSE A POTENTIAL SHOCK HAZARD THAT COULD RESULT IN PERSONAL INJURY. ONLY FUSES OF THE SPECIFIED TYPE AND OF THE REQUIRED RATED CURRENT SHOULD BE USED. DO NOT USE REPAIRED FUSES OR SHORT CIRCUITED FUSEHOLDERS. TO DO SO COULD CAUSE A SHOCK OR FIRE HAZARD.

CAUTION

BEFORE THE INSTRUMENT IS SWITCHED ON, THE LINE VOLTAGE SWITCH ON THE REAR PANEL MUST BE SET FOR THE VOLTAGE OF THE POWER SOURCE OR DAMAGE TO THE INSTRUMENT MAY RESULT.

3-3. PANEL FEATURES.

3-4. Front and rear panel features are described in Figures 3-1 and 3-2. Description numbers match the numbers on the illustration. Other detailed information for panel displays and controls is covered starting in paragraph 3-5.

3-5. SELF TEST.

3-6. The 4140B has the following self test functions:

- (1) A Program Memory Test
- (2) pA Meter Test
- (3) A Display Test

These tests are automatically performed each time the LINE button is pushed to turn the instrument on. In addition, these tests are enabled when SELF TEST key is pushed. Under this latter condition, the tests are performed repeatedly while SELF TEST lamp is lit. These tests can also be enabled by a remote program via the HP-IB.

(1) Program Memory Test.

During the Self Test mode, the instrument checks the internal program memory. If an abnormality is detected, the instrument displays one of nine error messages (E-1 ~ E-9). Seven of the error messages (E-1 ~ E-7) indicate an abnormality in the ROM (Read Only Memory) and the other two error messages (E-8 or E-9) indicate an abnormality in the RAM (Random Access Memory). Suffix numbers are the same as those for ROM or RAM.

(2) pA Meter Test.

This test verifies basic operation of the instruments pA Meter section. If an abnormality is detected, the instrument will display an error message (E-P) on the I-C DISPLAY.

(3) Display Test.

During the Self Test mode, all front panel indicator lamps and all segments of numeric and character displays are illuminated. When the instrument is turned on, the current setting of the HP-IB address switches is displayed on the I-C DISPLAY for approximately 1 second.

3-7. When 4140B is set to Self Test mode by the SELF TEST key, the 4140B has an additional Self Test function (a Control Key Test). If each control key is normal, the I-C DISPLAY displays an octal code as shown in Figure 3-3, when a control key is pushed.

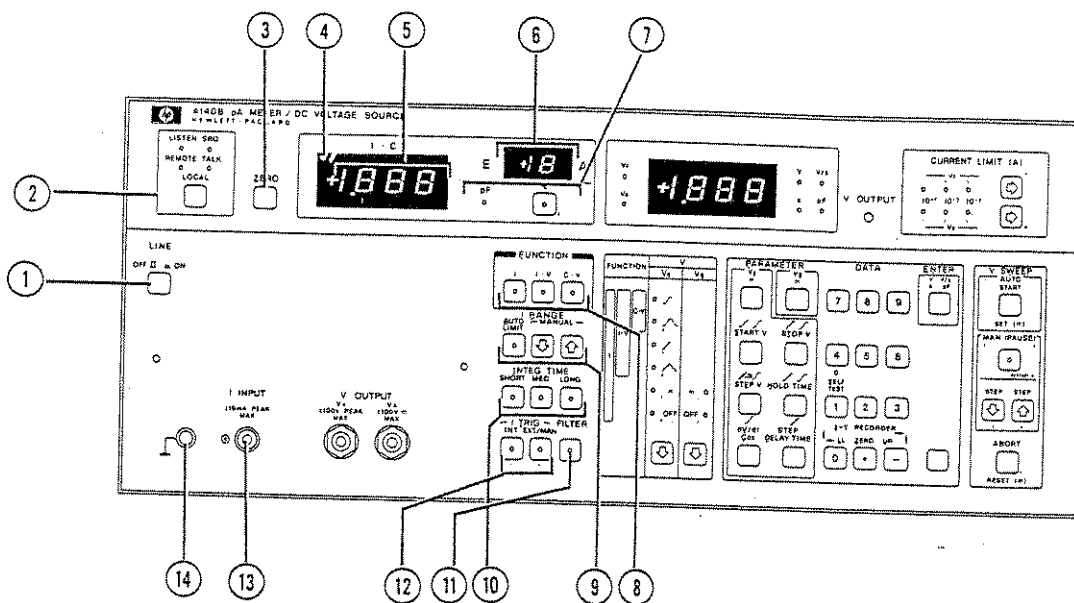

- ① LINE ON/OFF Switch: Turns instrument on and readies instrument for measurement.
- ② HP-IB Status Indicator and LOCAL Key: LED lamps for SRQ, LISTEN, TALK, and REMOTE indicate status of interface between the 4140B and HP-IB controller. LOCAL key enables front panel control instead of remote control from HP-IB line. Refer to paragraphs 3-71 thru 3-100.
- ③ ZERO Offset Key: This key is used to compensate for pA Meter offset errors. Current or capacitance value on I·C display ⑤ is stored when button is pressed. The stored offset value is subtracted from subsequent measurement values. Refer to the paragraph 3-23.
- ④ Trigger Lamp: Turns on in synchronization with measurement or data output on I·C DISPLAY ⑤. When FUNCTION ⑧ is set to I and I TRIG ⑫ is set to INT, the lamp flashes repeatedly at approximately 200ms.
- ⑤ I·C Display: Current or capacitance value, including decimal point and sign is displayed as a maximum 3-1/2 digit decimal number from 0000 to 1999. If the measurement value exceeds full count on the selected range, an overflow annunciation appears.
- ⑥ Exponential Display for Current Measurement: Current measurement exponential ($-2 \sim -12$ in eleven ranges) is displayed when FUNCTION ⑧ is set to I or I-V.
- ⑦ Capacitance Measurement or Percent Key: Unit Indicator: "pF" indicator is illuminated in general C-V measurements. When percent key is pushed, percent indicator is illuminated and I·C DISPLAY ⑤ is in percent.
- ⑧ FUNCTION Select Key: These keys select measurement functions as follows.
 - I: For independent operations as universal pA meter and DC voltage source.
 - I-V: I-V characteristics measurement using staircase or ramp wave.
 - C-V: Quasi-Static C-V characteristics measurement using ramp wave.

Figure 3-1. Front Panel Features (sheet 1 of 5).

⑨ I RANGE Select Key: These keys select the current measurement ranging method. In AUTO mode (when LED lamp is lit), optimum range for the current value is automatically selected. In MANUAL mode (when LED lamp is not lit), measurement range remains the same even when the current value is changed. Manual ranging is done by pressing adjacent DOWN (Ⓜ) or UP (Ⓨ) key. Also, pressing LIMIT key after pressing the Blue key (24) sets the lower limit of AUTO mode I RANGE. When a lower limit other than $10^{-12}A$ is set, the LED lamp will flash. Refer to paragraph 3-16.

Note

Pressing DOWN (Ⓜ) or UP (Ⓨ) key sets the ranging mode to Manual even if the ranging mode was set to AUTO.

⑩ INTEGRATION TIME Select Key: These keys select digital integration time in accordance with the following table for the various measuring conditions:

Range(A)	Integration Time (ms)*		
	Short	Medium	Long
$10^{-2} \sim 10^{-10}$	20(16.7)	80(66.7)	320(266.7)
10^{-11}	80(66.7)	320(266.7)	1280(1066.7)
10^{-12}	160(133.3)	640(533.3)	2569(2133.3)

*Note: at 50 (60)Hz line frequency.

⑪ FILTER Key: An internal filter for rejecting ac noise can be set to ON/OFF by pressing this key. When the filter is OFF, LED lamp is flashing.

⑫ I TRIG Select Key: These keys select trigger mode for triggering measurement or I Data Output when FUNCTION is set to I as follows:

INT: This key provides internal trigger which enables instrument to output current data measurement repeated at 200ms (approximate) rate.

EXT/MAN: In external/manual trigger mode, a trigger signal is provided by not only applying to EXT TRIGGER input on rear panel, but also by pressing this key.

Note

A 4140B can be triggered by a trigger command (GET), regardless of mode setting of I TRIG.

⑬ I INPUT Connector: This connector is a triaxial female connector for connecting unknown current source, test lead, or test fixture.

⑭ GROUND Terminal: This terminal is connected to chassis ground of instrument and can be used as ground terminal in measurements which specifically require use of a guard.

Figure 3-1. Front Panel Features (sheet 2 of 5).

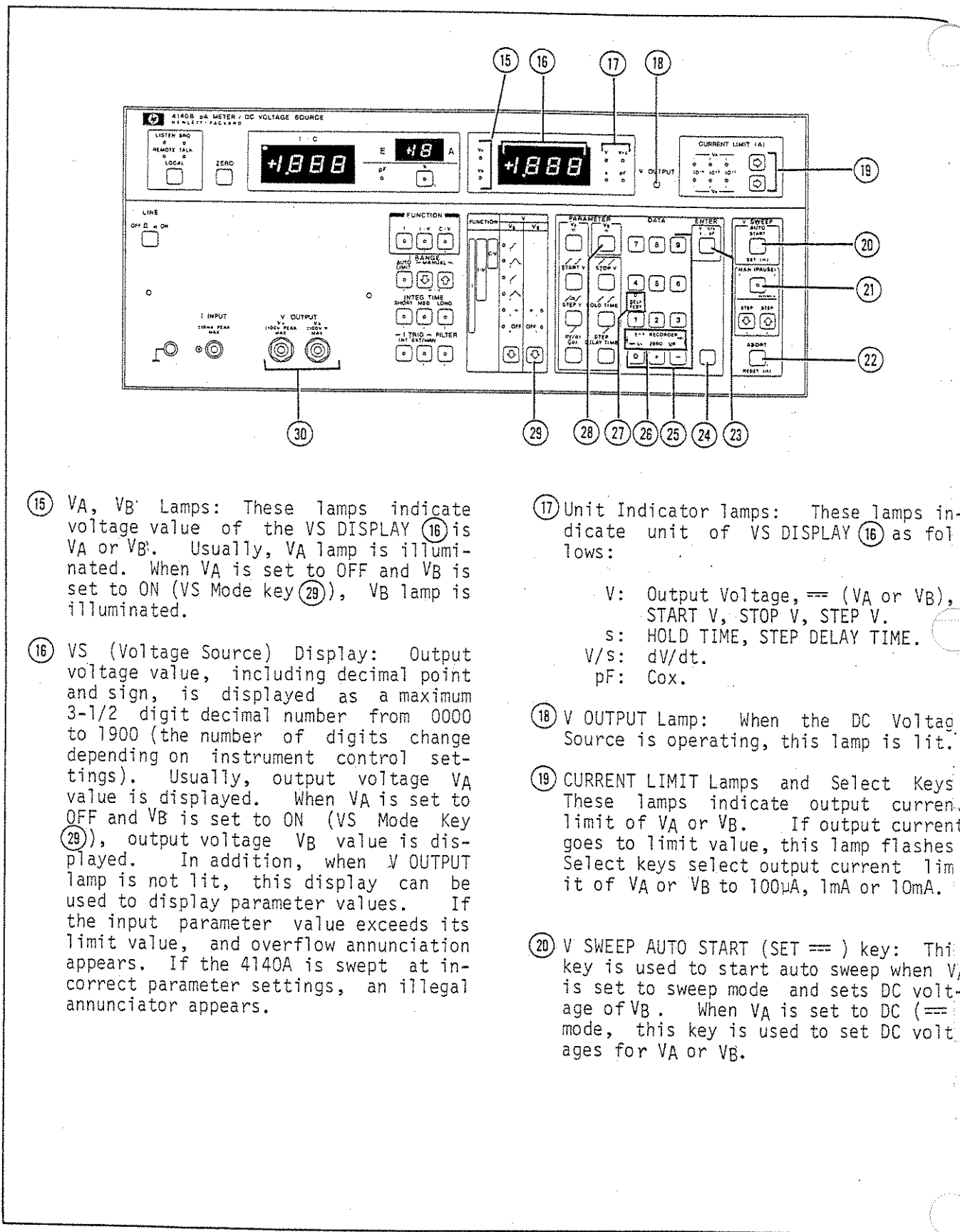

⑮ VA, VB Lamps: These lamps indicate voltage value of the VS DISPLAY ⑮ is VA or VB. Usually, VA lamp is illuminated. When VA is set to OFF and VB is set to ON (VS Mode key ⑳), VB lamp is illuminated.

⑯ VS (Voltage Source) Display: Output voltage value, including decimal point and sign, is displayed as a maximum 3-1/2 digit decimal number from 0000 to 1900 (the number of digits change depending on instrument control settings). Usually, output voltage VA value is displayed. When VA is set to OFF and VB is set to ON (VS Mode Key ⑳), output voltage VB value is displayed. In addition, when V OUTPUT lamp is not lit, this display can be used to display parameter values. If the input parameter value exceeds its limit value, and overflow annunciation appears. If the 4140A is swept at incorrect parameter settings, an illegal annunciator appears.

⑰ Unit Indicator Lamps: These lamps indicate unit of VS DISPLAY ⑮ as follows:

- V: Output Voltage, == (VA or VB), START V, STOP V, STEP V.
- s: HOLD TIME, STEP DELAY TIME.
- V/s: dV/dt.
- pF: Cox.

⑱ V OUTPUT Lamp: When the DC Voltage Source is operating, this lamp is lit.

⑲ CURRENT LIMIT Lamps and Select Keys: These lamps indicate output current limit of VA or VB. If output current goes to limit value, this lamp flashes. Select keys select output current limit of VA or VB to 100µA, 1mA or 10mA.

⑳ V SWEEP AUTO START (SET ==) key: This key is used to start auto sweep when V_i is set to sweep mode and sets DC voltage of VB. When VA is set to DC (==) mode, this key is used to set DC voltages for VA or VB.

Figure 3-1. Front Panel Features (sheet 3 of 5).

⑳ V SWEEP MAN (PAUSE), STEP DOWN (Ⓜ) and STEP UP (Ⓜ) Keys: MAN (PAUSE) key is usually used to start manual sweep. When VA is operating in auto sweep mode, this key is used as the auto sweep pause control. The key can change the sweep from auto (when LED lamp is not lit) to manual mode (when LED lamp is lit) or from manual to auto. The STEP DOWN and STEP UP keys are used for manual sweep.

㉑ V SWEEP ABORT (RESET ≡) Key: This key is used to abort all operations of the DC Voltage Source.

㉒ ENTER Key: When this key is pushed after the value of the parameter is set with the PARAMETER select (28) and DATA (25) keys, the set value is stored in the 4140A. The VS DISPLAY (16) indication flashes once when this key is pushed.

㉓ Blue Key: Functions in blue letters (Cox, SELF TEST, X-Y RECORDER) are effective after this key is pushed.

㉔ DATA Keys: These keys are used to input parameter values. They are made up of numeric (0~9), decimal and minus keys.

㉕ X-Y RECORDER Control Keys: These keys are used to control pen position of the X-Y recorder connected to ANALOG OUTPUT connectors on rear panel and include:

- LL: Moves pen position to lower left of sweep area.
- ZERO: Sets both outputs to 0V.
- UR: Moves pen position to upper right of sweep area.

These control keys are effective after Blue key is pushed.

㉖ SELF TEST Key and Lamp: This key is used to set 4140B to Self Test mode. Lamp is lit during Self Test mode operation. This key is effective after the Blue key (24) is pushed. Refer to paragraph 3-5.

㉗ PARAMETER Select Keys: These keys are used to set and monitor measurement parameters for DC Voltage Source. When V OUTPUT Lamp (18) is lit, Parameters can not be set. Parameters can be monitored when these keys are pushed:

• VA Mode

- ≡ : DC Voltage (V) of no sweep mode.
- START V: Start voltage (V) of sweep mode.
- STOP V: Stop voltage (V) of sweep mode.
- STEP V: Step voltage (V) of sweep mode.
- HOLD TIME: Hold time (s) of start and stop voltages of the sweep mode.
- dV/dt: Rate of change of ramp wave voltage.

Cox: Reference capacitance value (C oxide) (pF) of a C-V measurement in percent. This key is effective after Blue key (24) is pushed.

STEP DELAY

TIME: Delay time(s) of each step of staircase wave.

• VB Mode

≡ : DC Voltage (V).

Figure 3-1. Front Panel Features (sheet 4 of 5).

29 VS (Voltage Source) Mode Lamps and Select Keys: These lamps indicate VS mode settings as follows:

•VA Mode

∩ (Single Ramp Wave): Output voltage is changing continuously (dv/dt) from start voltage to stop voltage.

∧ (Double Ramp Wave): Output voltage is changing continuously (dv/dt) from start voltage to stop voltage. Successively, output voltage is returned to start voltage at same ramp rate.

⌋ (Single Staircase Wave): Output voltage is changed step-by-step in step voltage fashion from start to stop voltage.

∧ (Double Staircase Wave): Output voltage is changed in step-by-step voltage fashion from start to stop voltage. Successively, output voltage is returned to start voltage by same step voltage.

≡ (DC): DC voltage is outputted.

OFF: VA is not operating.

•VB Mode

≡ (DC): DC voltage is outputted.

OFF: VB is not operating.

Select keys select VA and VB mode in accord with following table:

FUNCTION	VA						VB	
	∩	∧	⌋	∧	≡	OFF	≡	OFF
I	○	○	⊙	○	○	○	○	⊙
I-V	○	○	⊙	○	x	x	○	○
C-V	⊙	○	x	x	x	x	○	○

x: This mode is not used.

⊙: Initial Settings.

30 V OUTPUT Connectors: These connectors are BNC female connectors to connect unknown samples, test leads or test fixtures.

Figure 3-1. Front Panel Features (sheet 5 of 5).

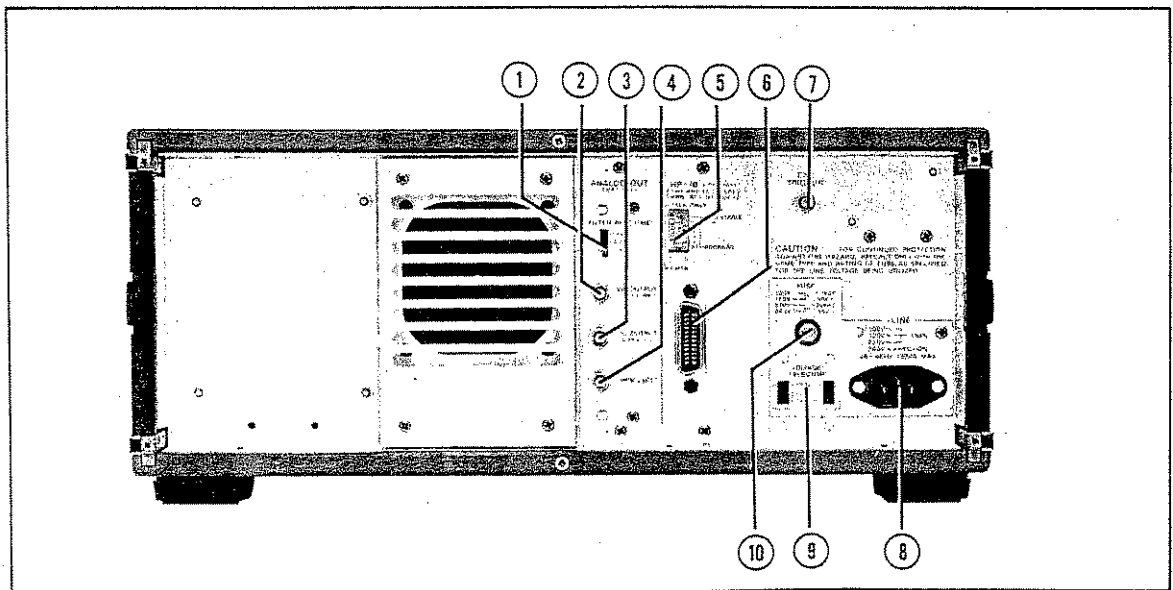

Figure 3-2. Rear Panel Features (sheet 1 of 2).

① FILTER TIME CONST Select Switch: This switch selects filter rise time (OFF, 0.22s or 1s) for optimizing analog output.

② VA OUTPUT Connector: Analog output data of 4140B VA OUTPUT is output from this connector in accordance with the following table:

VA (V)	VA OUTPUT (V)	RESOLUTION
0.00 ~±10.00	0.000 ~±1.000	1mV/count
±10.1 ~±100.0	±1.01 ~±10.00	10mV/count

③ I/C OUTPUT Connector: Analog output data of 4140B I.C DISPLAY is output from this connector in accordance with the following table:

I DISPLAY	I OUTPUT (V)	RESOLUTION
0 ~±1999	0.000 ~ ±9.995	5mV/count

C DISPLAY	C OUTPUT (V)	RESOLUTION
0.0 ~ 199.9	0.0000 ~ 0.9995	500µV/count
200 ~ 1999	1.000 ~ 9.995	5mV/count

% DISPLAY	% OUTPUT (V)	RESOLUTION
0.0 ~ 199.9	0.000 ~ 9.995	5mV/count

④ PEN LIFT Connector: PEN LIFT control signal for an X-Y recorder connected to the 4140B, is output from this connector. When VA OUTPUT and I/C OUTPUT connectors are outputting analog output data, this connector outputs a LOW level TTL signal (PEN DOWN). At other times, this connector outputs a HIGH level TTL signal (PEN UP).

⑤ HP-IB Control Switch: This switch selects HP-IB address, data output format, and interface capability. Refer to paragraph 3-79.

⑥ HP-IB Connector: An HP-IB cable can be connected for intercommunication with other HP-IB devices through the bus line cable.

⑦ EXT TRIGGER Connector: This connector is used for externally triggering pA Meter by inputting an external trigger signal when FUNCTION is set to I. TRIGGER switch on front panel should be set to EXT. Refer to paragraph 3-21.

⑧ LINE Input Receptacle: AC power cord is connected to this receptacle and to AC power line.

⑨ VOLTAGE SELECTOR Switch: These switches select the appropriate operating power voltage (100, 120, 220V ±10% or 240V +5% -10%, 48 ~ 66Hz). Refer to paragraph 2-8.

⑩ FUSE Holder: Instrument power line fuse is installed in this holder. Refer to paragraph 2-8.

Figure 3-2. Rear Panel Features (sheet 2 of 2).

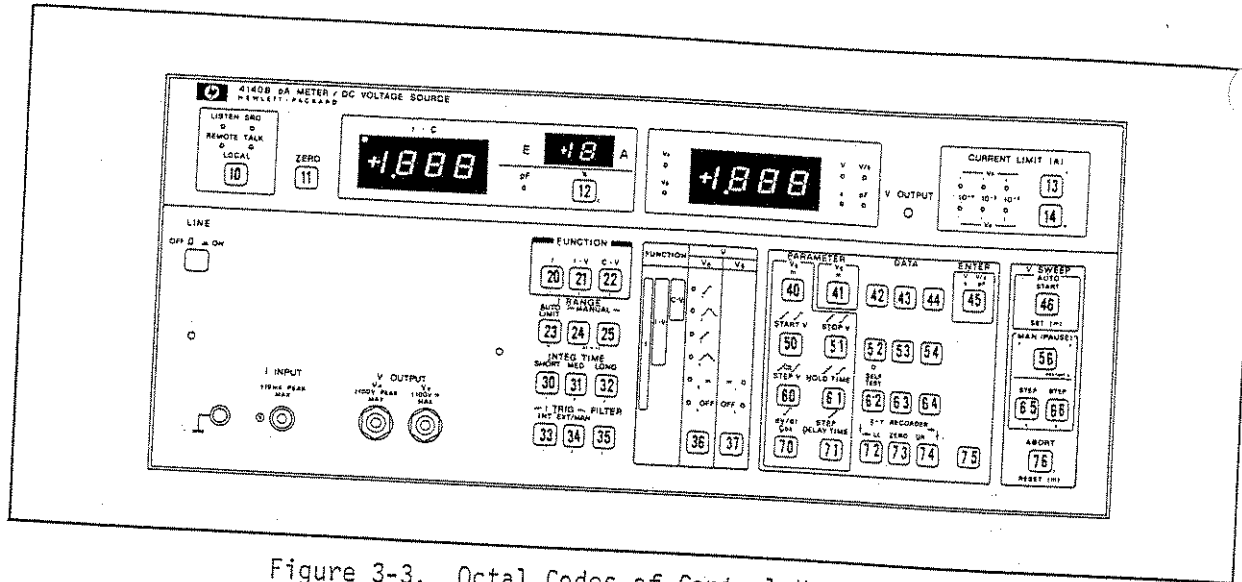

Figure 3-3. Octal Codes of Control Keys.

3-8. INITIAL CONTROL SETTINGS.

3-9. One of the convenient functions which facilitate ease of operation is the automatic initial control setting performed after the instrument is turned on. Initial panel control functions are automatically set as follows:

- FUNCTION I
- I RANGE AUTO
- Lower Limit of AUTO Mode 10^{-12} A
- INTEG TIME LONG
- FILTER ON
- I TRIG INT
- VA OFF
- VB OFF
- PARAMETERS all parameters are 0
- SELF TEST OFF
- I ZERO OFFSET 0
- C ZERO OFFSET 0
- CURRENT LIMIT 100 μ A

Additionally, when FUNCTION is changed, panel control functions are automatically set as in Table 3-1.

Table 3-1. Automatic Control Settings.

CONTROLS	FUNCTION		
	I	I-V	C-V*
I TRIG	INT	OFF	OFF
VA			

* C measurement Unit indicator is set to pA.

3-10. MEASUREMENT FUNCTION.

3-11. The 4140B has three measurement functions which are:

- I: For independent operations as a universal pA Meter and DC Voltage Source.
- I-V: I-V characteristics measurement using Staircase and Ramp wave.
- C-V: Quasi-Static C-V characteristic measurement using Ramp wave.

The paragraphs that follow give basic information on the pA Meter and DC Voltage Source when FUNCTION is set for I, I-V and C-V measurement.

3-12. pA (PICO-AMPERE) METER SECTION.

3-13. The pA Meter section operates as an independent, highly stable universal pA Meter (10^{-15} A max) when FUNCTION is set to I. When FUNCTION is set to I-V, accurate current-voltage measurements can be made with the staircase or ramp wave of the DC Voltage Source - the timing between the pA Meter and DC Voltage Source can be automatically synchronized. When FUNCTION is set to C-V, accurate I-V measurements are made using the ramp wave, and capacitance is calculated from the measured current value and the ramp rate (dV/dt); the result is displayed on the I·C DISPLAY. Independent operation as a universal pA Meter is described in paragraphs 3-12 thru 3-26. These paragraphs should be read even if only I-V or C-V measurements are to be made. Instructions for I-V measurements are given in paragraphs 3-43 thru 3-48. For C-V measurements, paragraphs 3-49 thru 3-60 should be read.

3-14. pA Meter Display.

3-15. The primary display, sub-display and two LED lamps provide visual data outputs of current measurement result or the result of capacitance calculations. The primary display (I·C DISPLAY) provides a readout of current measurement value, calculated capacitance value or the capacitance value as a percent of the reference value (C_{ox}) as a maximum 4 digit decimal number with decimal point. If measurement overflows, an alphabetic annunciation (either O-F; COF or POF) is displayed (refer to paragraph 3-65). The sub-display provides the exponent of the current measurement (-2 to -12 in eleven ranges) when FUNCTION is set to I or I-V. Two LED lamps serve as the unit indicators for the capacitance measurement. These lamps indicate that the value of the I·C DISPLAY is the calculated capacitance (pF) or the capacitance value in percent referenced to a capacitance value (C_{ox}). In a C-V measurement, lesser significant digit data of the calculated capacitance is displayed when the current measurement data has few significant digits. In an I·C DISPLAY, the lesser significant digit data is represented by a small zero (□) figure to differentiate it from a more significant digit which is represented by a large zero (■) as shown in Figure 3-3.

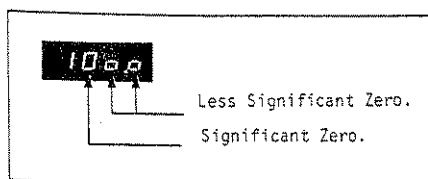

Figure 3-4. Less Significant Zero.

The display for the pA Meter displays the following parameter values in like manner (to those described above):

Measuring Current $\pm 0.001 \times 10^{-12}$ A
 $\sim \pm 1.999 \times 10^{-2}$ A.

Calculated Capacitance .. 0.0pF \sim 199.9pF,
 200pF \sim 1999pF.

Capacitance in Percent .. 0.0% \sim 199.9%.

3-16. Current Measurement Ranges.

3-17. The pA Meter of the 4140B can measure currents from 10^{-12} A to 10^{-2} A in 11 ranges. Each range allows a 99.9% overrange of the 1000 full scale count (maximum 1999 counts). The 4140B has two range modes, AUTO and MANUAL, to select the optimum range for the various current measurements. When I RANGE is set to AUTO, an optimum range is automatically selected for each measurement. If the internal measurement circuit is saturated or the I·C DISPLAY count (refer to paragraph 3-18) exceeds 1999, the measurement range is automatically changed up. If the I·C DISPLAY count is less than 150, the measurement range is changed down by the AUTO ranging system. Also, using the following procedure, a lower limit for AUTO range can be set:

- (1) Select the desired lower limit using the DOWN (ⓐ) or UP (ⓑ) key.
- (2) Press the Blue key and then press AUTO. This sets the present I RANGE as the lower limit of the AUTO range mode.

At lower limit, the measurement range will not change down even if the I·C DISPLAY count is less than 150.

Note

When range mode is set to AUTO, the LED lamp in the AUTO key will be lit. If a lower limit other than 10^{-12} A is set, this LED lamp will flash.

When the I RANGE is set to MANUAL, the measurement range will not change even if the measured current changes. If the DOWN (ⓐ) or UP (ⓑ) key is pressed while I RANGE is set to AUTO, the I RANGE will change to MANUAL and the measurement range will change accordingly. If the internal measurement circuit is saturated when I RANGE is set to MANUAL, UCL will be displayed on the I·C DISPLAY, or if the measured value is over 1999 counts, O-F will be displayed on the I·C DISPLAY. Ranging times, the time the instruments takes to change from one range to another, are given in Table 1-2.

3-18. Integration Time and Data Output.

3-19. The raw current measurement of the 4140B pA Meter section is made by making successive approximations between the reference voltage (using a high speed D-A converter) and a voltage proportional to the measured current. This raw current measurement is synchronized with the line frequency. Thus, the raw current measurement interval of the 4140B is 10(8.3)ms at 50(60)Hz line frequency and this measurement continues from the time the 4140B is turned ON until it is turned OFF. These raw current measurement data are digitally integrated and this result is output to the I·C DISPLAY. The number of the raw current measurement data selected for digital integration (2 ~ 256) is fixed by the INTEG TIME select key on the front panel. The integration time of the 4140B pA Meter section is the product of the number of raw current measurement data selected for digital integration and the current measurement interval. The 4140B has nine integration times as given in Table 3-2 which are selected by measurement range and unknown condition.

Table 3-2. Current Measurement Integration Times.

Range(A)	Integration Time (ms)*		
	Short	Medium	Long
$10^{-2} \sim 10^{-10}$	20(16.7)	80(66.7)	320(266.7)
10^{-11}	80(66.7)	320(266.7)	1280(1066.7)
10^{-12}	160(133.3)	640(533.3)	2560(2133.3)

*Note: at 50 (60)Hz line frequency.

3-20. When FUNCTION is set to I and I TRIG is set to INT, digital integration is made using raw current measurement data already available when the I Trigger is received as shown in Figure 3-5. Therefore, I data output is completed as soon as the I Trigger is received. The I Trigger interval requires only 10(8.3)ms which is the raw current measurement interval and is not related to integration time. The relationship between integration time and the data output when FUNCTION is set to I-V or C-V is described in paragraph 3-47 or 3-53.

Note

When the I TRIG is set to EXT/MAN, digital integration is made using the raw current measurement data after the trigger signal is received. Therefore, in this case, the measurement time (from receiving the trigger signal to outputting current measurement data) is the sum of the integration time and data processing time (approximately 3ms).

3-21. External Triggering.

3-22. The 4140B pA Meter section can be triggered by an external trigger signal for current measurement. To trigger the 4140B externally, set 4140B front-panel controls as follows:

FUNCTION I
 I DATA OUTPUT TRIGGER EXT/MAN

The external triggering device should be connected to EXT TRIGGER connector (BNC female type) on rear panel. The 4140B can be triggered by a TTL level signal that changes from HIGH (+5V) to LOW (0V). Trigger pulse width must be greater than 1μs. Triggering can also be done by alternately shorting (or with resistance lower than 100Ω) and opening the center conductor of the EXT TRIGGER connector to ground (chassis).

Note

The center conductor of the EXT TRIGGER connector is normally HIGH (no input).

Note

Triggering can be also done by trigger command (GET) or remote program code "E" via the HP-IB. Refer to Figure 3-33.

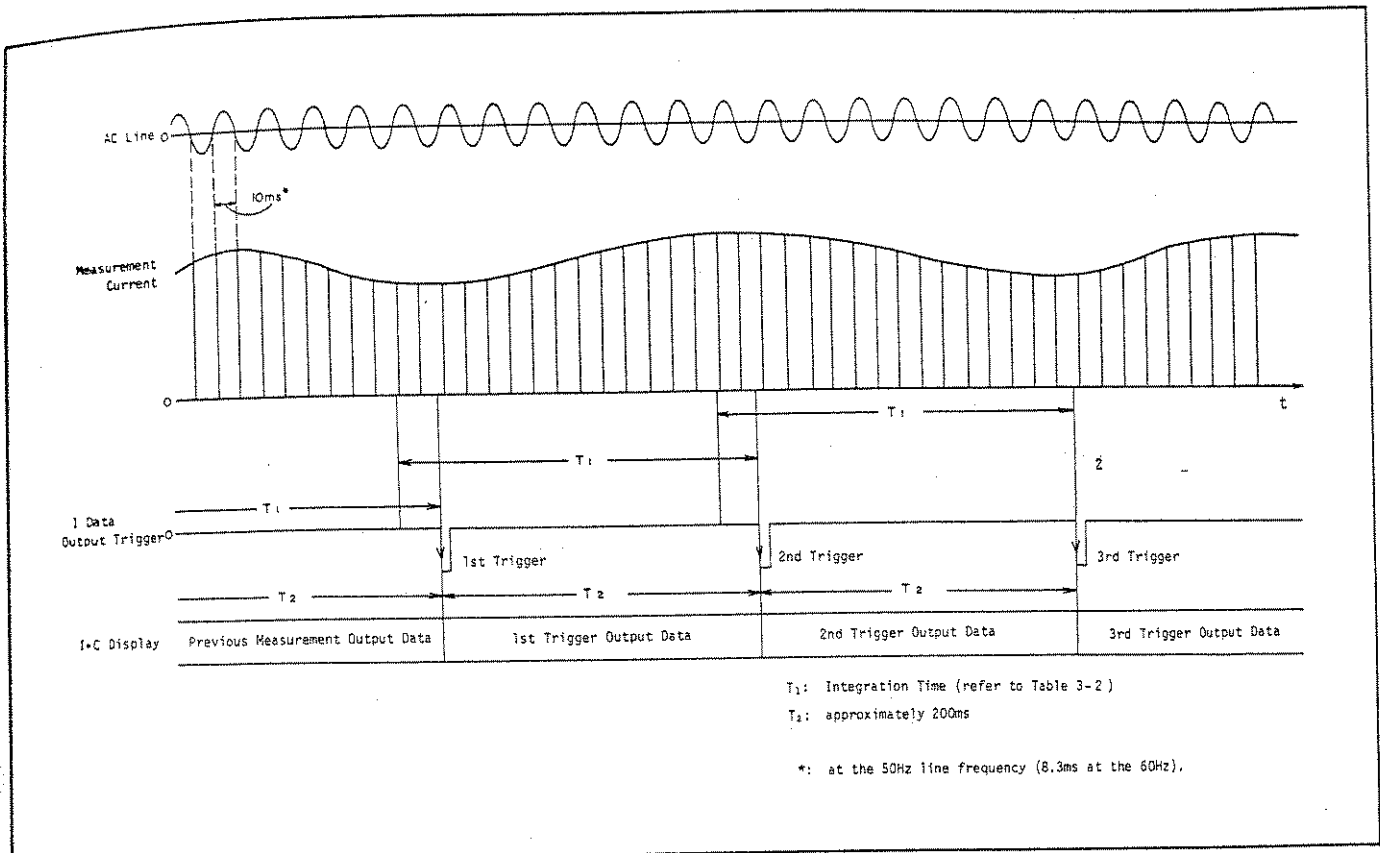

Figure 3-5. Integration Time and Data Output (When I TRIG is Set to INT).

3-23. Zero Offset for Current Measurement.

3-24. The 4140B has a zero offset function which can be used to cancel the offset error of an undesired input current (e.g. leakage current of test leads/test fixtures) to minimize measurement error. How to perform zero offset is described in Figure 3-6. The current measurement offset limit is $0 \sim 100\text{fA}$ and the zero offset function can be used only at the 10^{-12}A range. If ZERO OFFSET key is pushed when measurement range is other than 10^{-12}A , this action is ignored. The zero offset value is set to 0fA when the 4140B is turned ON. When the ZERO offset key is pushed, the value of the I-C DISPLAY adds to zero offset value.

Note

The zero offset can also be done by remote program code "Z" via the HP-IB.

3-25. pA Meter Operating Instructions (when FUNCTION is set to I).

3-26. Instructions for operating the pA Meter of the 4140B (when FUNCTION is set to I) are given in Figure 3-6.

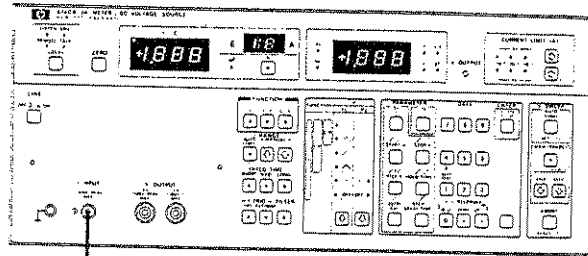

triaxial (male) - triaxial (male) cable
To DUT

PROCEDURE:

- (1) Turn 4140B OFF.
- (2) Connect test lead or test fixture (e.g. triaxial (male) - triaxial (male) cable of 16053A Test Lead (HP Part No. : 16053-61002)) to INPUT
- (3) Turn 4140B ON.
- (4) At turn-on, Self Test of 4140B is performed automatically (refer to paragraph 3-5).

Note

The 4140B requires a one hour warm up time to satisfy all specifications listed in Table 1-1.

- (5) The pA Meter section of 4140B is automatically set as follows:

FUNCTION I
 I RANGE AUTO
 Lower Limit of AUTO Mode $10^{-12}A$
 INTEG TIME LONG
 FILTER ON
 I TRIG INT
 I ZERO OFFSET 0 fA

- (6) Confirm that the I·C Data Output Trigger lamp is flashing.
- (7) Select desired integration time with the INTEG TIME key on front panel (refer to paragraph 3-18).
- (8) Connect nothing to test leads or to test fixture (open).
- (9) When using the $10^{-12}A$ measurement range, set I·C DISPLAY to $0.00 \pm 10^{-12}A$ with ZERO offset key (refer to paragraph 3-23).

Note

The measured current at the $10^{-12}A$ range is a very small value ($10^{-12}A \sim 10^{-15}A$). Therefore, any leakage current generated by changing test lead connection, test fixture or unknown current source, increases the error of the measurement at the $10^{-12}A$ range. To avoid this condition, do a zero offset after the I·C DISPLAY has settled (allow more than five minutes).

Figure 3-6. pA Meter Section Operating Instructions (when FUNCTION is set to I)(sheet 1 of 2).

- (10) Connect unknown current source to the test lead or test fixture.

Note

Specific information on DUT connection is described in paragraph 3-61.

- (11) The pA Meter of 4140B will automatically display measured value of unknown.

Note

The display value of a measurement on the 10^{-12} A range may be unstable immediately after connecting unknown current source because of the leakage currents described above.

Note

If the approximate value of the unknown current source is known, the ranging time can be eliminated from the measurement time by setting the current measurement range to hold on the desired range by using the DOWN (\downarrow) or UP (\uparrow) keys. Measurement time can also be reduced by setting the lower limit of AUTO mode to prevent changing down to unnecessary lower ranges.

Note

When the 4140B is turned ON, an internal FILTER for rejecting ac noise is set to ON. As shown in Table 1-2, when this FILTER is ON, response time and ranging time are 60ms (for 50Hz line frequency) or 50ms (at the 60Hz) longer than when the FILTER is OFF. To reduce response time and ranging time, turn the FILTER OFF. When the FILTER is OFF, the LED lamp of the selected INTEG TIME key will flash.

The equivalent circuit of the pA Meter section in the 4140B is shown below:

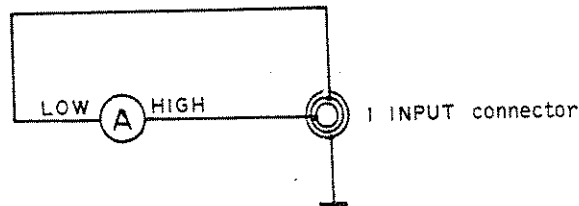

Figure 3-6. pA Meter Section Operating Instructions
(when FUNCTION is set to I) (sheet 2 of 2).

3-27. VS (VOLTAGE SOURCE) SECTION.

3-28. The VS section of the Model 4140B operates as two independent programmable voltage sources: VA and VB. One of the programmable DC voltage sources, VA, can operate, not only as a programmable DC voltage source, but also as a unique staircase (staircase) or accurate ramp (ramp) generator. In addition, accurate I-V measurements, with the staircase or ramp waves (the timing of either of which can be automatically synchronized between the pA Meter section and the DC Voltage Source section), can be done in the I-V section. In the C-V function, accurate C-V measurements using the ramp wave and calculating the capacitance from the current measurement value and ramp rate (dV/dt), can be done. Paragraphs 3-27 thru 3-42 describe independent operation as two programmable voltage sources. These paragraphs should be read even if only an I-V or C-V measurement is to be made. Instructions for I-V measurements are given in paragraphs 3-43 thru 3-48. For C-V measurements, paragraphs 3-49 thru 3-60 should be read.

3-29. VS Section Display.

3-30. A numeric display and thirteen indicator lamps provide visual data outputs of output voltages and operating parameters. The VS DISPLAY provides a readout of output voltages or operating parameters as a maximum 3-1





/2 digit decimal number with decimal. If the input parameter value exceeds its maximum limit value, an overflow annunciator (O-F) appears. If the 4140B is swept at correct parameter settings, an illegal association (ILLE) appears. VA, VB lamps indicate voltage value if the VS DISPLAY is VA, VB. Unit indicator lamps indicate unit of measured values. VA OUTPUT lamp is lit if the VS section is operating. CURRENT LIMIT lamps indicate output current limit of VA. If output current goes to limit value, this lamp flashes. The display for the VS section displays the following values in the manner (to those described above):

Output Voltage 0.00V ~ ±100.0
 Operating Parameters
 START V/STOP V/ == (DC) . 0.00V ~ ±10.0
 STEP V 0.01V ~ 10.0u
 HOLD TIME 0.0s ~ 1999
 STEP DELAY TIME 0.00s ~ 100.
 dV/dt (Ramp Rate) ... 0.001V/s ~ 1.00V
 CURRENT LIMIT 10⁻⁴A, 10⁻³A, 10⁻²A

3-31. VS Section Output Modes.

3-32. The VS section of the 4140B provides two voltage sources, VA (programmable Voltage Source/Function Generator) and VB (programmable DC Voltage Source). Each of the voltage sources provide output modes given in Table 3-3.

Table 3-3. VS Section Output Modes.

VS	Mode	Description
VA		Simple ramp wave. Output voltage changes continuously (dV/dt) from start voltage to stop voltage.
		Double ramp wave. Output voltage changes continuously (dV/dt) from start voltage to stop voltage. Successively, output voltage is returned to start voltage at same ramp rate (dV/dt).
		Single staircase wave. Output voltage changes step-by-step from start voltage to stop voltage.
		Double staircase wave. Output voltage changes step-by-step from start voltage to stop voltage. Successively, output voltage is returned to start voltage by same step voltage.
	==	DC voltage is output.
	OFF	VA is not operating.
VB	==	DC voltage is output.
	OFF	VB is not operating.

3-33. VS Section Operating Parameters.

3-34. The VS section of the 4140B provides eight operating parameters as given in Table 3-4. Values of these parameters can be input using the following procedure:

- (1) Press desired PARAMETER key.
- (2) Set desired value with DATA keys. VS DISPLAY displays setting value.
- (3) Input displays parameter value with ENTER key. Displayed parameter value is flashed.

Note

Parameter values can be set via HP-IB (refer to paragraph 3-85).

Note

If setting parameter value exceeds the setting limit listed in Table 3-4, VS DISPLAY displays (**0-E**) and this value is not input.

3-35. Voltage Output and Display of VS.

3-36. The 4140B VS section outputs a voltage and provides for its display by one of the following methods depending on the VS output mode:

Note

When the VS section is operating (when V OUTPUT lamp is lit), no controls or operating parameters can be changed as noted in Table 3-5.



(1) DC (==):

The V_A DC voltage, whose value is set with the V_A (PARAMETER) key, is output from the V_A OUTPUT connector with the SET (==) key. Output voltage value is displayed on the VS DISPLAY. V_A can be cancelled and set to 0V with RESET (==) key.

Table 3-4. VS Section Operating Parameters.

Parameter	Description	Setting Limits
V_A ==	DC Voltage.	10V range: -10.00V ~ +10.00V
START V	Start voltage of staircase or ramp wave.	100V range: -100.0V ~ +100.0V
STOP V	Stop voltage of staircase or ramp wave.	
STEP V*	Step voltage of staircase or ramp wave.	-10.00V ~ +10.00V
HOLD TIME	Hold time for start and stop voltages of staircase or ramp wave.	0.0s ~ 1999s
dV/dt	Ramp rate.	0.001V/s ~ 1.000V/s
STEP DELAY TIME	Delay time for each voltage of staircase wave.	0.00s ~ 100.0s
V_B ==	DC Voltage.	10V range: -10.00V ~ +10.00V 100V range: -100.0V ~ +100.0V



* Step voltage of the ramp wave means displayed step voltage of VS DISPLAY. (STEP V)/(dV/dt) must be more than 50ms. Step voltage value automatically rises to 0.1V resolution when absolute value of output voltage is over 10 volts.

(2) Staircase Wave ( , ):
The V_A output voltage is swept with set operating parameters (START V, STOP V, STEP V, HOLD TIME, and STEP DELAY TIME). There are two sweep control methods: auto sweep and manual sweep:

① Auto Sweep:



The V_A output voltage is swept automatically according to the set operating parameters when the AUTO START key is pushed. The relation between output voltage and its display is given in Figures 3-7 and 3-8. The V_A output sweep can be stopped halfway and the operating parameters (except for START V/STOP V and integration time) can be changed. When the V_A output sweep is completed, V_A is automatically set to 0V. The V_A output sweep can be cancelled and set to 0V at the halfway point with the ABORT key.

② Manual Sweep:

The V_A output voltage is set to manual sweep mode with MAN key. The V_A output voltage is swept at its operating parameters (except for HOLD TIME/STEP DELAY TIME) in this mode using Step Down () and Step Up () keys. Output voltage is displayed on VS DISPLAY.

Note

The MAN (PAUSE) key changes the sweep mode from auto (LED lamp is not lit) to manual (LED lamp is lit) or from manual to auto.

(3) Ramp Wave ( , ):
The V_A output voltage is swept automatically at its operating parameters (START V, STOP V, STEP V, HOLD TIME and dV/dt) when the AUTO START key is pushed. The relationship between output voltage and its display is given in Figures 3-9 and 3-10. The V_A output sweep can be stopped halfway, at which time its operating parameters (except for START V/STOP V) can be changed. When the V_A output sweep is complete V_A is automatically set to 0V. The V_A output sweep can be cancelled and set to 0V at the halfway point with the ABORT key.

Note

The V_A output voltage can be set to START V and initially held at this voltage with the PAUSE key. After the desired "wait" time, V_A output sweep can be restarted.

Note

VS DISPLAY will display V_A output voltage during the time that VS section is outputting voltage (except when V_A is set to OFF). But when V_B is set to ∞ , both V_A and V_B sources are outputting voltages at the same time. V_B output voltage can be monitored with V_B key.

Table 3-5. Inhibition of Controls and Operating Parameters
(When VS Section is Operating).

VS Sweep Mode	Controls				Operating Parameters								
	FUNCTION	INTEG. TIME	V _A	V _B	CO	V _A *	START V	STOP V	STEP V	HOLD TIME	dV/dt	STEP DELAY TIME	V _B *
AUTO, ∞ (DC)	x	△	x	x	x	x	x	x	x	x	x	x	x
MANUAL (PAUSE)	x	△	x	x	○	○	x	x	○	○	○	○	○

○: Can be changed.
△: Can not be changed during ramp wave.
x: Can not be changed.

If the changed value is to be used after restarting, press PAUSE after pressing SET (∞).

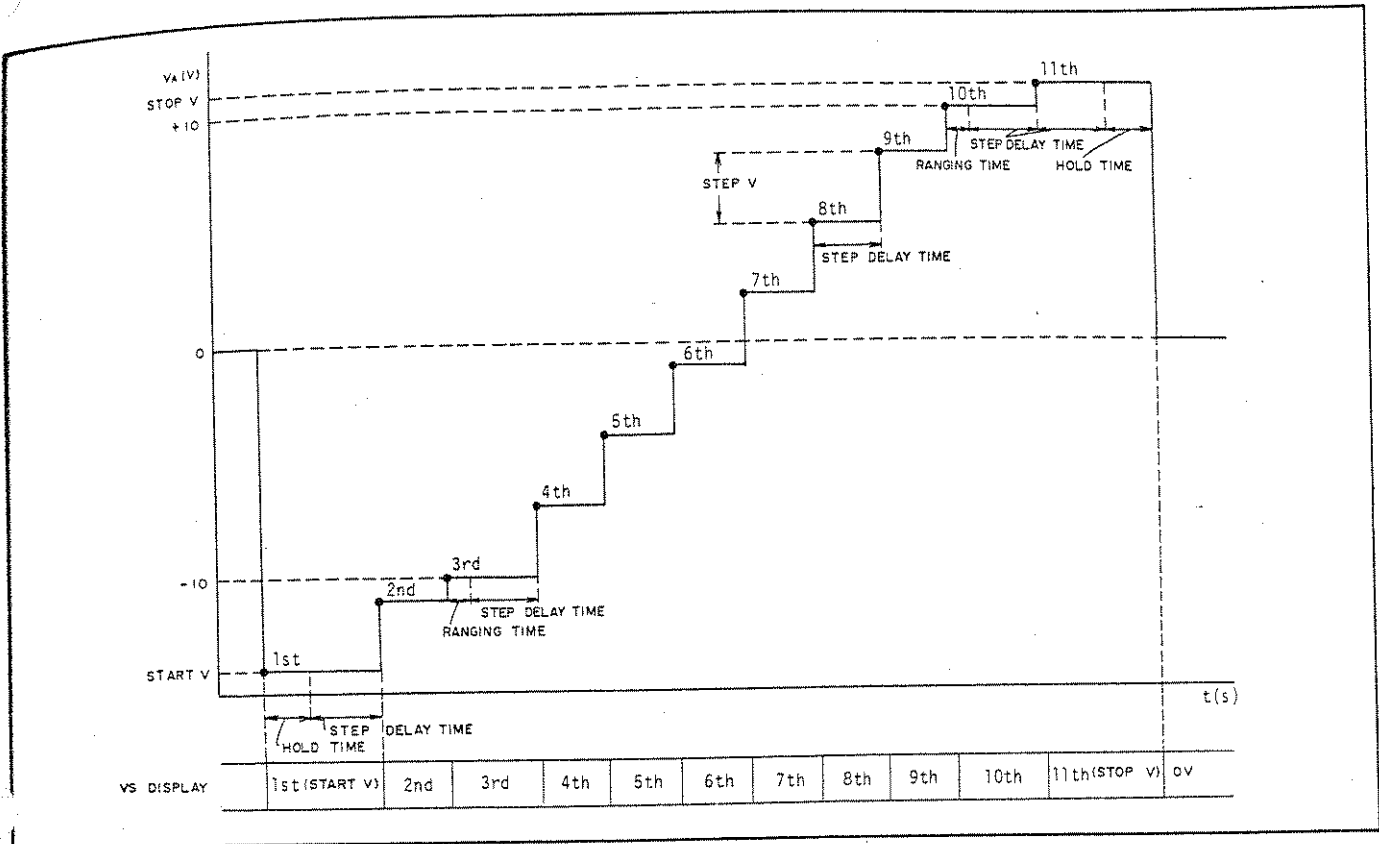

Figure 3-7 Relationship between Output Voltage and Display for \square (Single Staircase Wave).

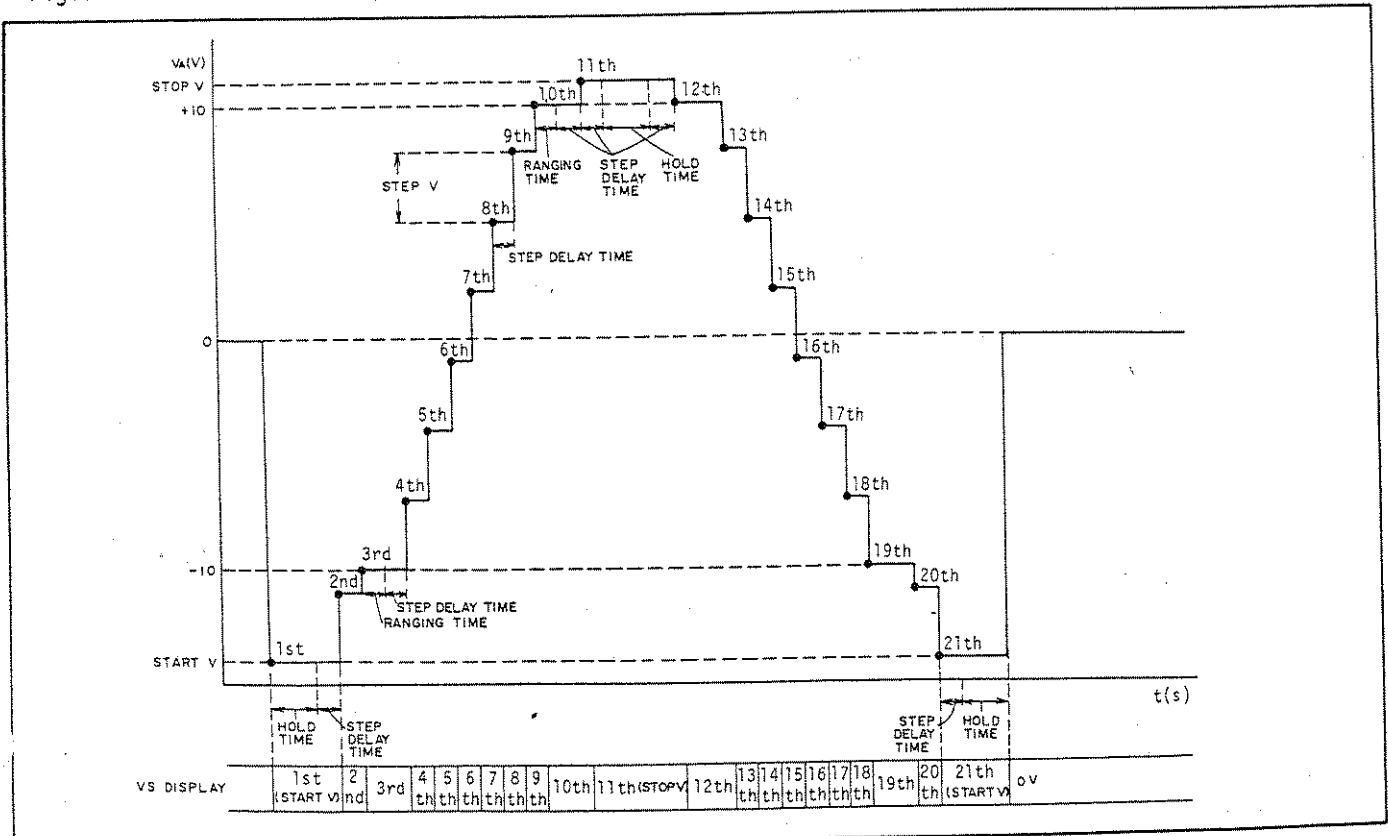

Figure 3-8. Relationship between Output Voltage and Display for \square (Double Staircase Wave).

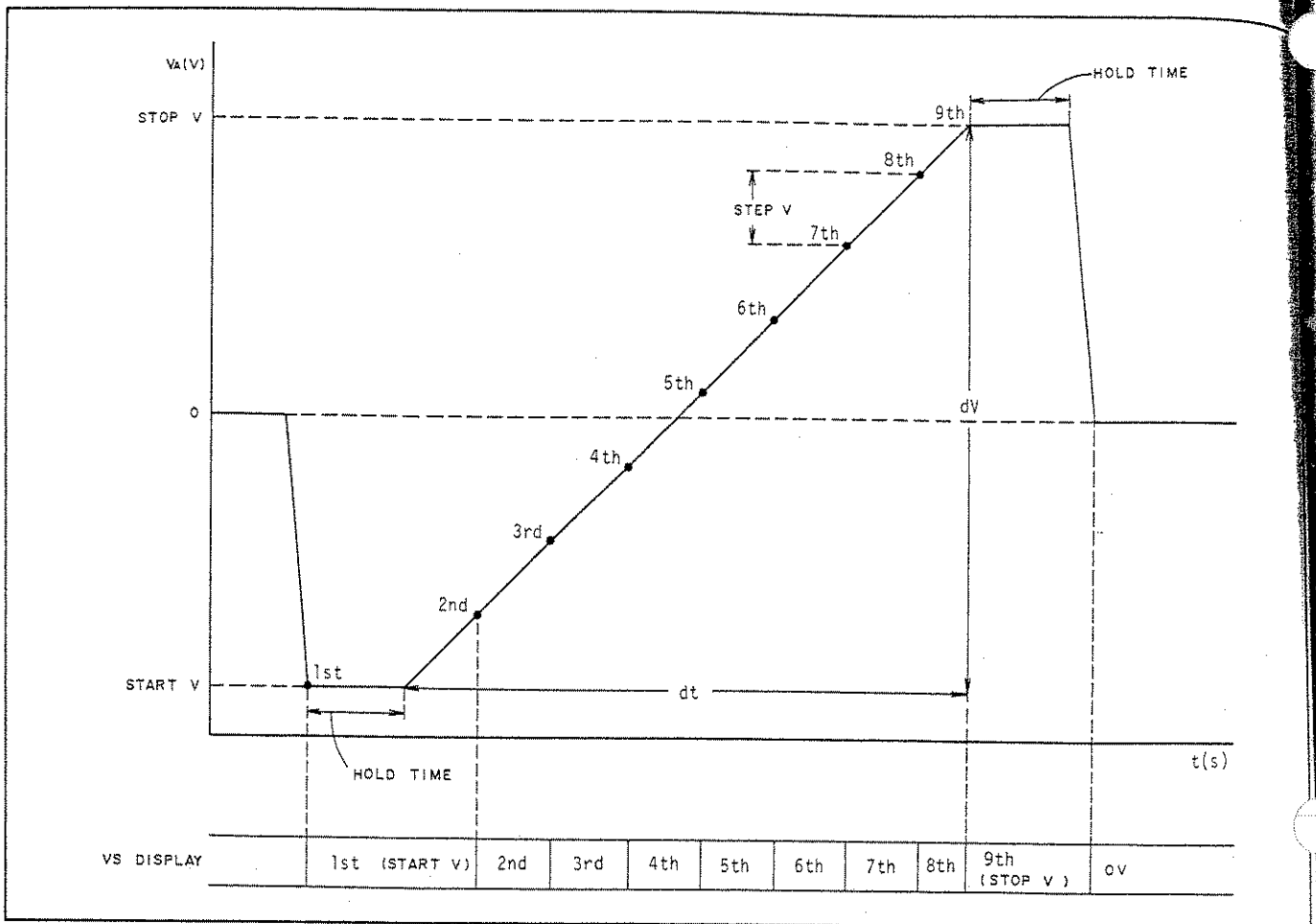

Figure 3-9. Relationship between Output Voltage and Display for \nearrow (Single Ramp Wave).

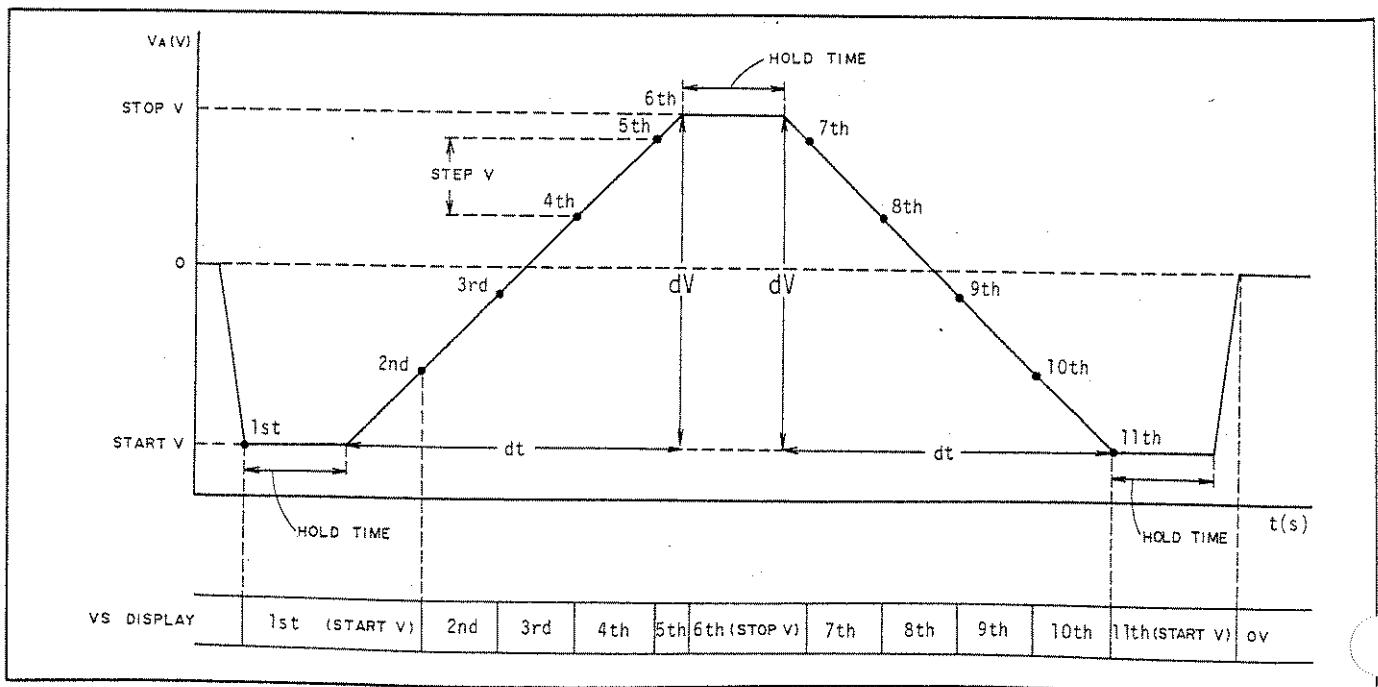

Figure 3-10. Relationship between Output Voltage and Display for \wedge (Double Ramp Wave).

3-37. Output Voltage Range.

3-38. The VS section of the 4140B provides two output voltage ranges: a x1 range (0.00V ~ 10.00V at the 0.01V step) and a x10 range (0.0V ~ 100.0V in 0.1V steps). Range changing is done automatically by the following methods (depending on VS output mode):

(1) DC (VA and VB):

Output voltage range is individually selected depending on the value of the parameter (VA or VB). The x1 range is selected when VA (VB) is 0.00V ~ 10.00V. The x10 range is selected when VA (VB) is -100.0V ~ -10.1V or +10.1V ~ +100.0V.

(2) Staircase Wave (,):

Output voltage range changes automatically from x1 range to x10 range or from x10 range to x1 range at 10.00V. If STEP V is set to 0.01V resolution, step voltage value is raised automatically to 0.1V resolution on x10 range.

Note

When output voltage range is changed from x1 range to x10 range or from x10 range to x1 range, output voltage is always set to +10.00V (or -10.00V) as shown in Figure 3-11. The ranging time needed is approximately 20ms (refer to Figures 3-7 and 3-8).

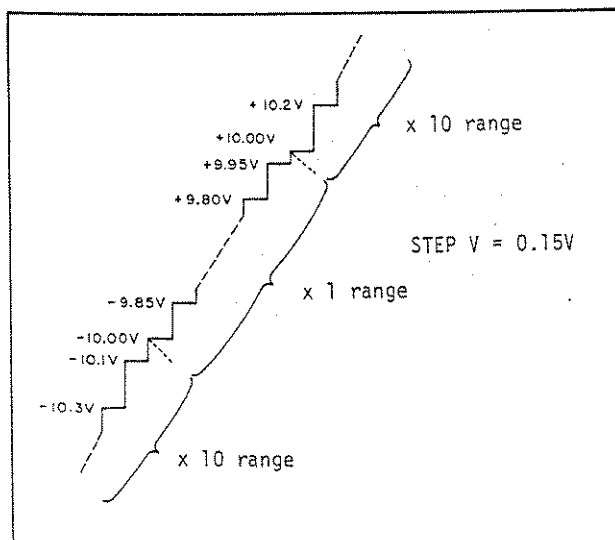

Figure 3-11. Output Voltage Range of Staircase Wave.

(3) Ramp Wave (,):

Output voltage range is selected depending on parameter values (START V and STOP V). The x1 range is selected with absolute values of START V and STOP V up to 10 volts. The x10 range is selected when absolute values of START V or STOP V exceeds 10 volts.

3-39. Current Limit.

3-40. The VS section of the 4140B can be used not only as independently programmable DC voltage sources/function generator, but also as a function generator synchronized to the pA Meter section for I-V/C-V measurements. I-V/C-V measurements are generally used to make characteristic measurements and analyses of semiconductor devices (e.g. diodes, FET's, etc.) or of electronic devices (e.g. capacitors, pc boards, cables, etc.). Some of these devices may be damaged by excessive current. Each of the programmable DC voltage sources (VA and VB) has a current limiter to avoid damaging the DUT by excessive current. The individual current limiters can be set for the current limit value ($10^{-4}A$, $10^{-3}A$ or $10^{-2}A$). If the output current goes to the limit value, an LED lamp on the front panel flashes and the voltage source (VA or VB) outputs current only at this maximum value. Output voltage value of the VS DISPLAY is then invalid.

3-41. VS Section Operating Instructions.

3-42. Instructions for operating the VS section of the 4140B (when FUNCTION is set to I) are given in Figure 3-12.

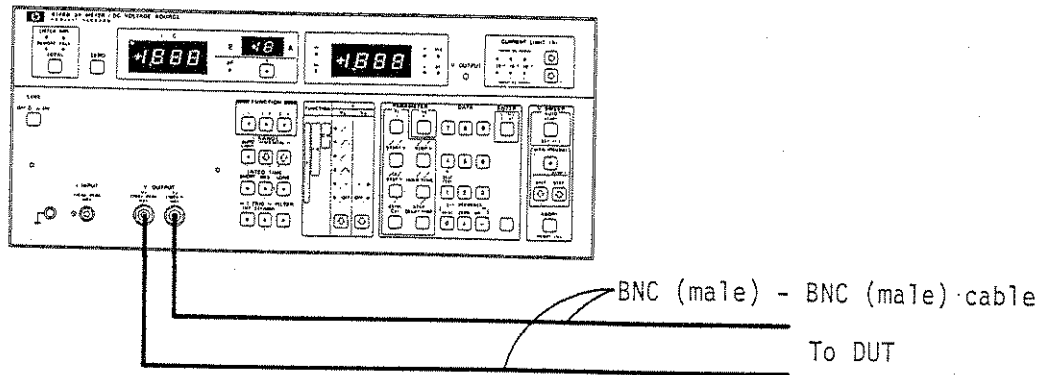

PROCEDURE

- (1) Turn 4140B OFF.
- (2) Connect test leads or test fixture (e.g. BNC (male) - BNC (male) cables of 16053A Test Lead (HP Parts No.: 16053-61003)) to V OUTPUT connectors of 4140B.
- (3) Turn 4140B ON.
- (4) At turn-on, Self Test of 4140B is performed automatically (refer to paragraph 3-5).

Note

The 4140B requires a one hour warm up time to satisfy all specifications listed in Table 1-1.

- (5) The VS section of 4140B is set automatically as follows:

```

FUNCTION ..... I
VA ..... 
VB ..... OFF
PARAMETER ..... all parameters are 0
VA CURRENT LIMIT ..... 10-4A
VB CURRENT LIMIT ..... 10-4A
    
```

- (6) Select desired VA and VB output modes with VS Mode Select keys on front panel (refer to paragraph 3-31).
- (7) Input values for VA operating parameters depend on selected VA output modes as follows (refer to paragraph 3-33):

```

 : VA == .
 ,  : START V, STOP V, STEP V, HOLD TIME, STEP DELAY TIME.
 ,  : START V, STOP V, STEP V, HOLD TIME, dV/dt.
    
```

- (8) Input value for VB == when VB will also be used.
- (9) Set current limit values for VA and VB with CURRENT LIMIT Select keys (refer to paragraph 3-39).

Figure 3-12. VS Section Operating Instructions (when FUNCTION is set to I) (sheet 1 of 2).

(10) Start voltage output with following keys for each VA setting (refer to paragraph 3-35):

Auto Sweep	<input type="checkbox"/>
Manual Sweep	<input type="checkbox"/>



(11) During the time that VS section is outputting voltage, the V OUTPUT lamp is lit.

Note

VS DISPLAY will display VA output voltage during the time that VS section is outputting voltage (except when VA is set to OFF). But when VB is set to \equiv , both VA and VB sources are outputting voltages at the same time. VB output voltage can be monitored with VB \equiv key.

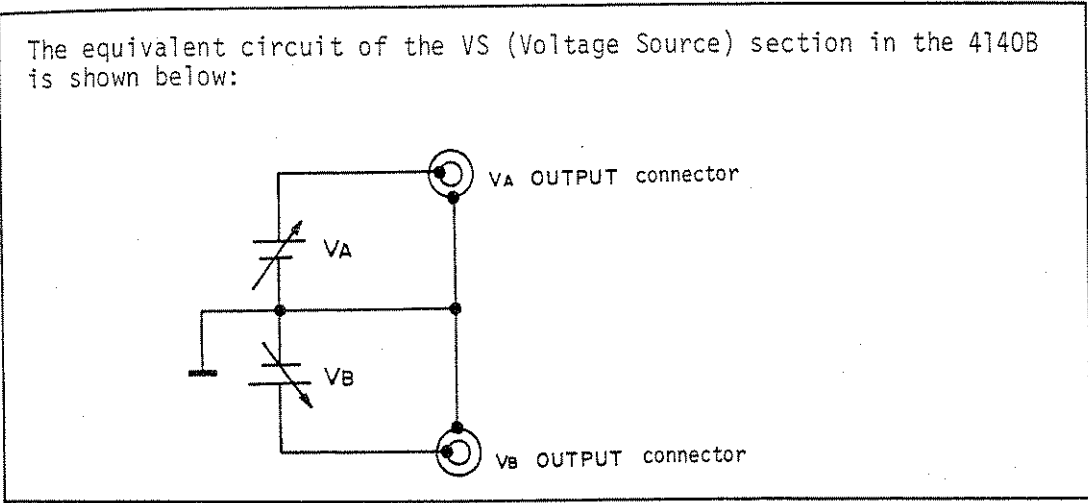

WARNING

100V MAX MAY EXIST ON THE CENTER CONDUCTOR OF BNC (FEMALE) CONNECTORS OF VA AND VB.





(12) If VA is set to Auto Sweep, VA and VB are automatically set to abort condition (OV) when auto sweep is completed. When VA is set to Manual Sweep or \equiv , VA and VB can be set to abort condition (OV) with ABORT (RESET) key.

Note

VA auto sweep can be stopped at the halfway point with the ABORT key.

Figure 3-12. VS Section Operating Instructions (when FUNCTION is set to I) (sheet 2 of 2).

3-43. I-V MEASUREMENT

3-44. The Model 4140B can automatically synchronize measurement timing between the pA Meter section and the VS (Voltage Source) section when the FUNCTION is set to I-V. Accurate I-V measurements with the staircase (, ) or ramp (, ) waves can be made by taking advantage of the variable digital integration (moving average method) which is described in paragraph 3-18. Operations of the I-V measurement are described in paragraphs 3-43 thru 3-48. For basic operational instructions of the pA Meter section, refer to paragraphs 3-12 thru 3-26 and for the VS section refer to paragraphs 3-27 thru 3-42.

3-45. I-V Measurement Data Output.

3-46. Measurement timing is automatically synchronized between the pA Meter section and the VS section in I-V measurements to assure that the measurement is taken at the correct timing. The methods for taking raw current measurement data for digital integration of the pA Meter section changes dependent on the output modes of the VS section as follows:

(1) Staircase wave (,):

Digital integration (refer to paragraph 3-18) or each step measurement is done, using the raw current measurement data, after VA goes to its step voltage. Therefore, the relationship between the I-V measurement and its data output (to the I·C DISPLAY and VS DISPLAY for a staircase wave will be as shown in Figures 3-13 and 3-14.

Note

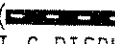
When FUNCTION is changed to I-V, the invalid data annunciation () is displayed on the I·C DISPLAY.

(2) Ramp wave (,):

Output voltage of the ramp wave changes continuously at a specific ramp rate (dV/dt) so that digital integration (for each voltage step) is done using the raw current measurement data before and after VA goes to its step voltage (in equal periods above and below the step voltage as fixed by the integration time). Therefore, the relationship between the I-V measurement and its data output (to the I·C DISPLAY and VS DISPLAY) for a ramp wave will be as shown in Figures 3-15 and 3-16.

Note

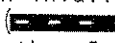
When raw current measurement data for digital integration is short, an invalid data annunciation () is displayed on the I·C DISPLAY. This annunciation always appears just after changing FUNCTION or after a parameter(s) is changed, or at the START V. If the STEP V is set to a small value when the ramp rate (dV/dt) is set to a fast value and the integration time is set to LONG, this annunciation also appears at several step voltage just after START V.

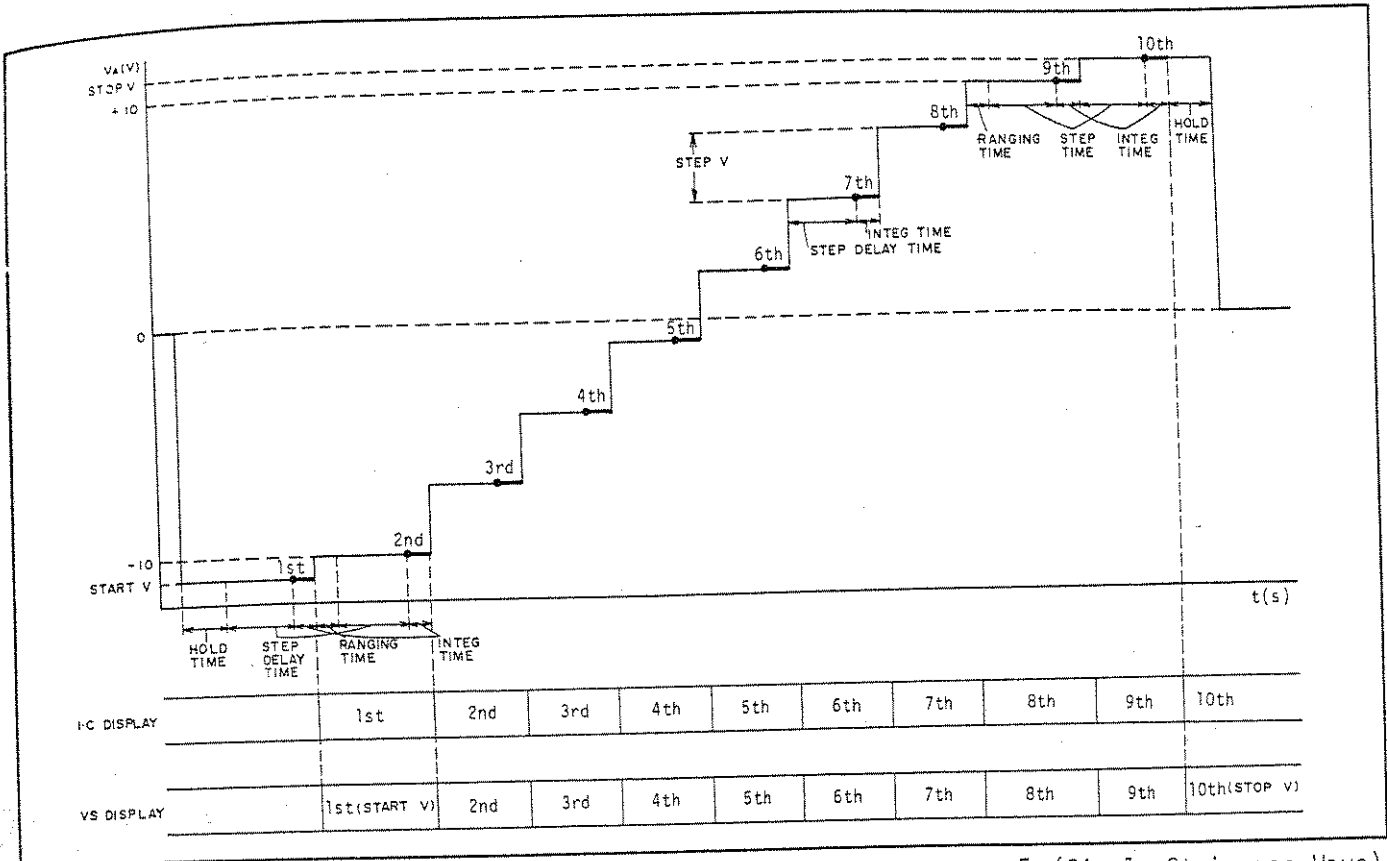

Figure 3-13. Relationship between I-V Measurement and Displays for \square (Single Staircase Wave).

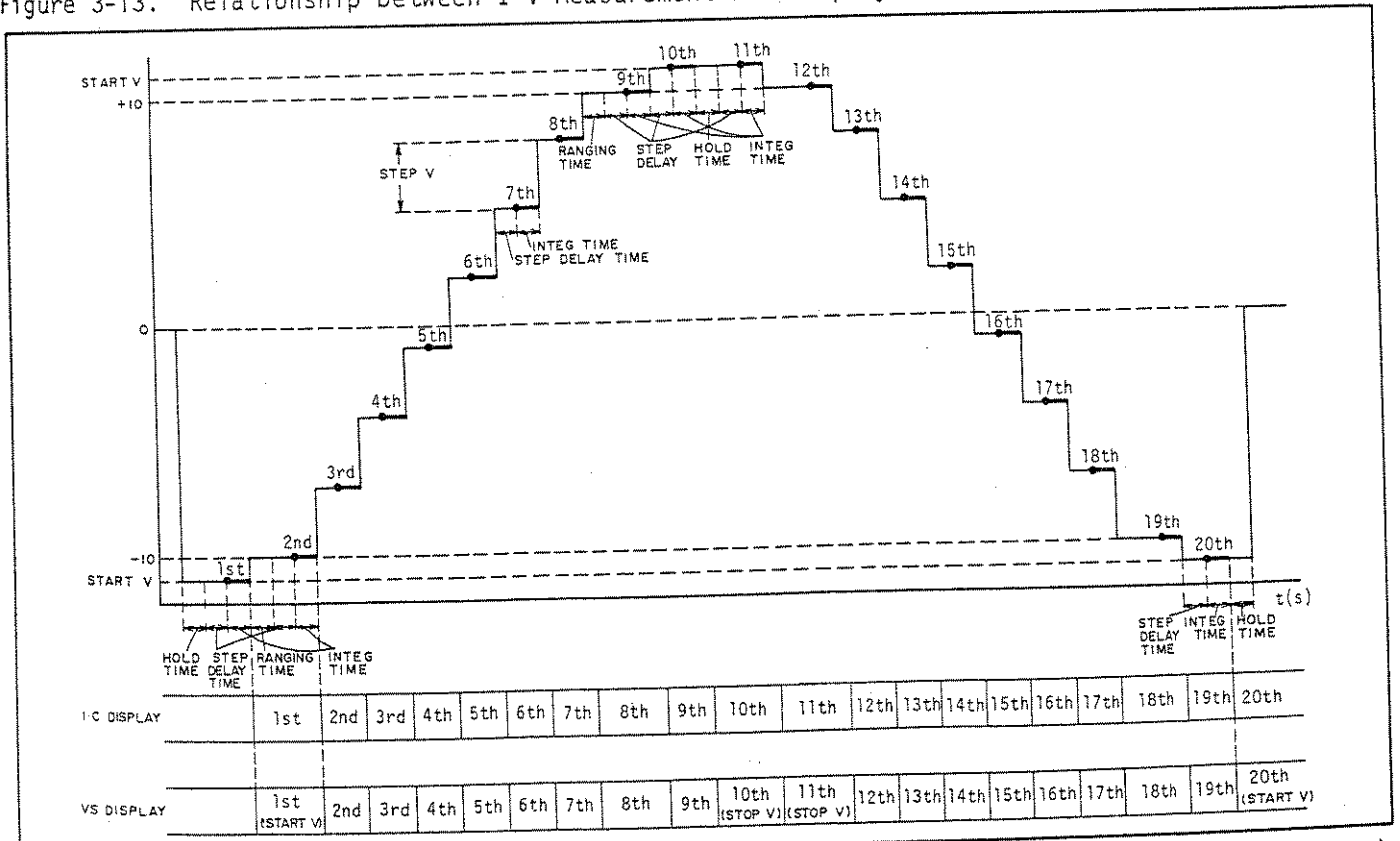

Figure 3-14. Relationship between I-V Measurement and Displays for \square (Double Staircase Wave).

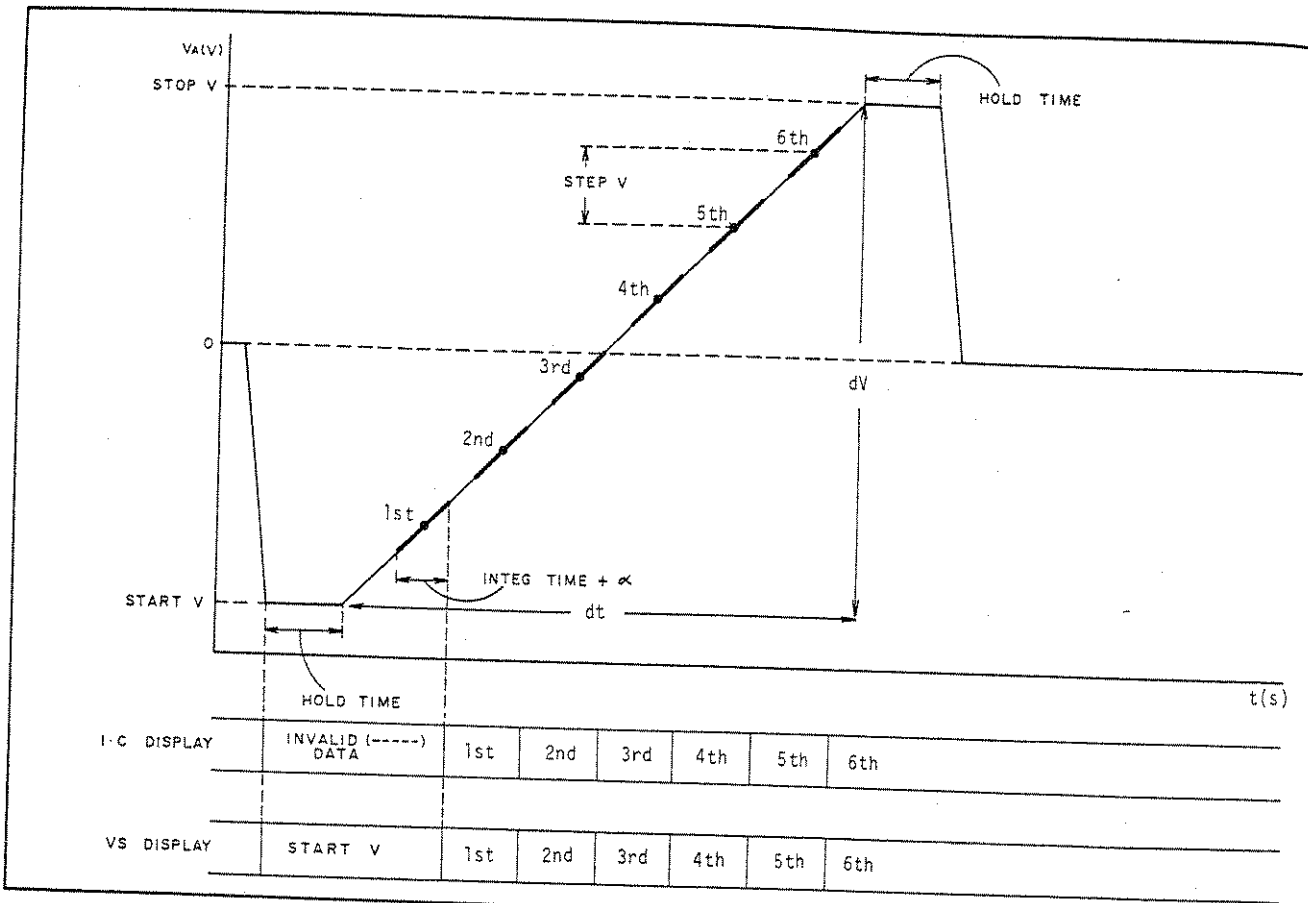

Figure 3-15. Relationship between I-V Measurement and Displays for \nearrow (Single Ramp Wave).

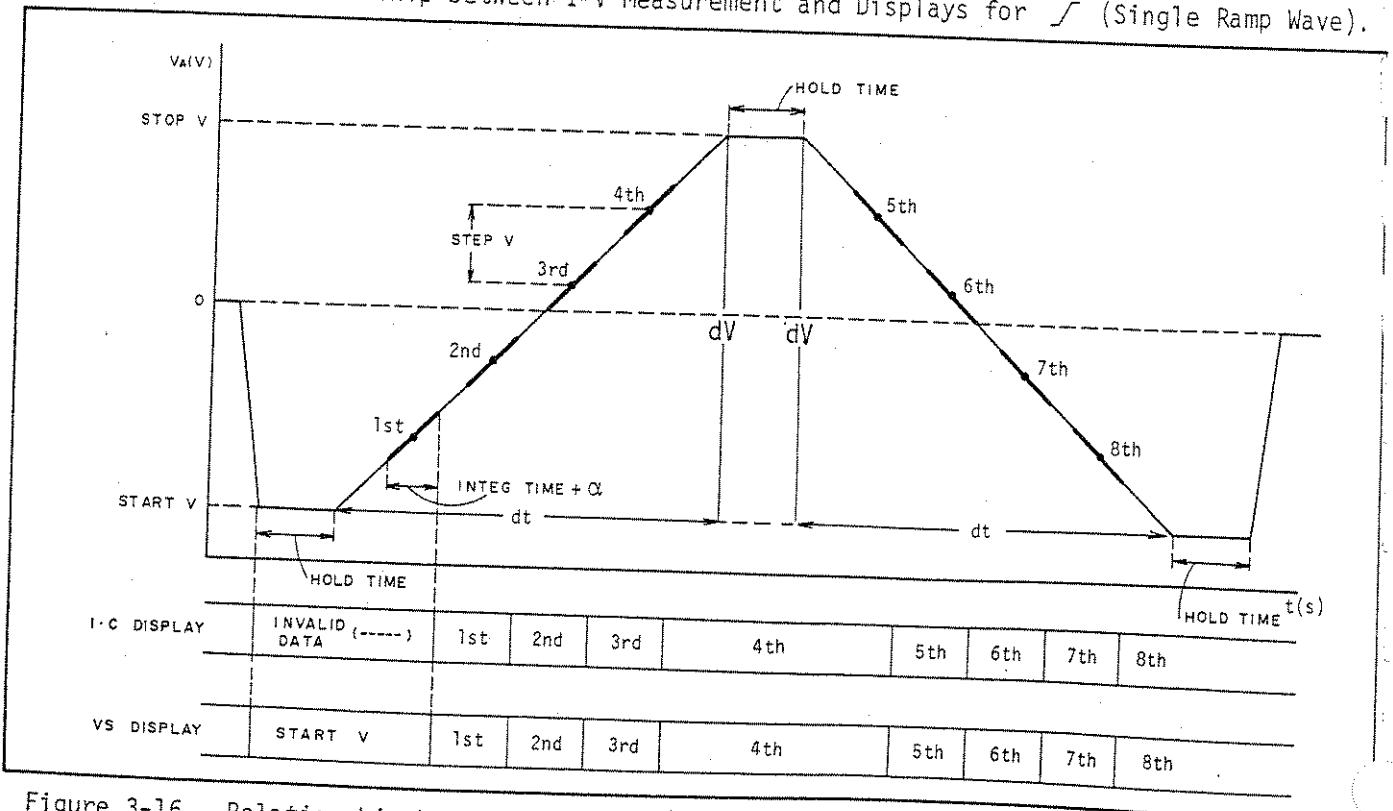

Figure 3-16. Relationship between I-V Measurement and Displays for \wedge (Double Ramp Wave).

- 3-47. I-V Measurement Operating Instructions.
- 3-48. Operating instructions for taking an I-V measurement are given in Figure 3-17.

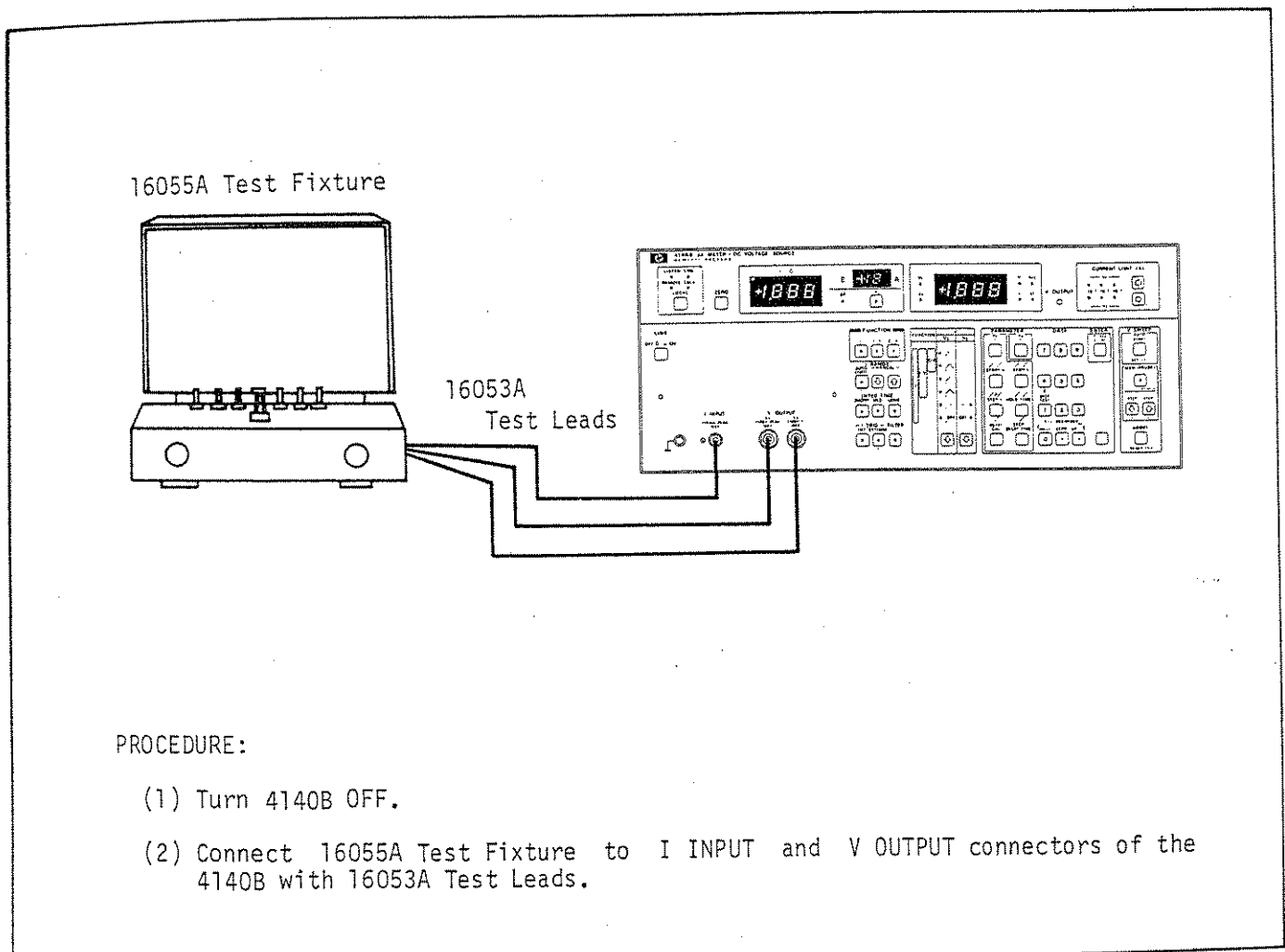

Figure 3-17. I-V Function Operating Instructions (sheet 1 of 4).

16055A Test Fixture

The 16055A can be used for stable pA current measurements of general devices with the electrostatic/light-shielded hood. DUT can be connected easily with alligator-clips or with the T0-5 type sockets which are furnished accessories of the 16055A (refer to Table 1-4 for photos and part numbers of accessories).

LOW lead connection of pA Meter section in the 4140B is selected with 16055A LOW LEAD CONNECTION select switch as follows:

◦ V_A , V_B :

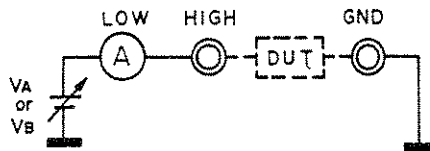

◦ GND :

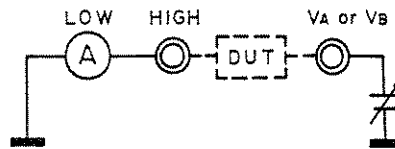

CAUTION

FOR SAFETY, THE 16055A SETS VOLTAGE SOURCES (V_A , V_B AND EXTERNAL) TO OFF BY A MICRO-SWITCH WHEN THE HOOD IS OPENED (AS ILLUSTRATED IN FIGURE AT RIGHT). MICRO-SWITCH CONTACTS ARE LOW RESISTANCE CONTACTS. HOWEVER, THIS RESISTANCE INCREASES WITH TIME. TO CLEAN CONTACT, DRIVE A CURRENT OF 0.1 TO 1A THROUGH CONTACT. OPEN AND CLOSE CONTACTS ONCE OR TWICE. THE HEAT AND ARCING WILL CLEAN CONTACTS.

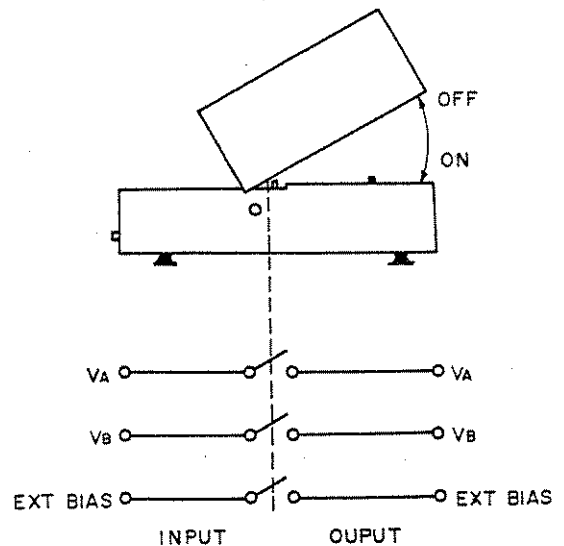

⚠ WARNING

DO NOT USE 16055A WITH HP MODEL 16054A CONNECTION SELECTOR. A HAZARDOUS VOLTAGE MAY EXIST ON LOW LEAD TERMINAL EVEN IF 16055A LOW LEAD CONNECTION SELECT SWITCH IS SET TO GND POSITION WHEN 16054A LOW LEAD SELECT SWITCH IS SET TO V_A OR V_B POSITION.

Figure 3-17. I-V Function Operating Instructions (sheet 2 of 4).

- (3) Turn 4140B ON.
- (4) At turn-on, Self Test of 4140B is performed automatically (refer to paragraph 3-5).

Note

The 4140B requires a one hour warm up time to satisfy all specifications listed in Table 1-1.

- (5) The 4140B is automatically set as follows:

FUNCTION	I
I RANGE	AUTO
Lower Limit of AUTO Mode	$10^{-12}A$
INTEG TIME	INT
FILTER	ON
I TRIG	INT
VA	
VB	OFF
PARAMETER	all parameters are 0
I ZERO OFFSET	0 fA
C ZERO OFFSET	0 pF
VA CURRENT LIMIT	$10^{-4}A$
VB CURRENT LIMIT	$10^{-4}A$

- (6) Confirm that the I·C Data Output Trigger lamp is flashing.
- (7) Select desired integration time with the INTEG TIME keys on front panel (refer to paragraph 3-18).
- (8) Connect nothing to 16055A (Open).
- (9) When using the $10^{-12}A$ measurement range, set I·C DISPLAY to $0.00 \times 10^{-12}A$ with ZERO offset key (refer to paragraph 3-23).
- (10) Set FUNCTION to I-V.
- (11) Select desired current measurement range with I RANGE keys (refer to paragraph 3-16).
- (12) Select desired VA and VB output modes with VS Mode Select keys on front panel (refer to paragraph 3-31).
- (13) Input values for VA operating parameters depending on selected VA output mode as follows (refer to paragraph 3-33):





	, 	: START V, STOP V, STEP V, HOLD TIME, STEP DELAY TIME.
	, 	: START V, STOP V, STEP V, HOLD TIME, dv/dt.
- (14) Input value for VB \equiv (when VB is also to be used).
- (15) Select current limit values of VA and VB with CURRENT LIMIT Select keys (refer to paragraph 3-39).
- (16) Select Low lead connection of pA Meter-section in the 4140A with 16055A LOW LEAD CONNECTION Select switch depending on kind of measurement.

Figure 3-17. I-V Function Operating Instructions (sheet 3 of 4).

- (17) Connect DUT to 16055A with alligator clips or T0-5 socket depending on kind of measurement.
- (18) Start C-V measurement with following keys for each VA setting (refer to paragraph 3-35):

Auto Sweep AUTO START
 SET (H)

Manual Sweep MAN (PAUSE)

Connections for typical applications for I-V measurements are given below:

1. I-V Characteristic Measurement of FET:

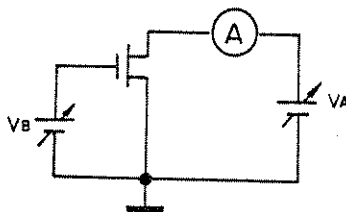

2. Breakdown Voltage Measurement of Diode:

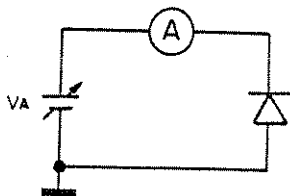

3. Threshold Voltage Measurement of FET:

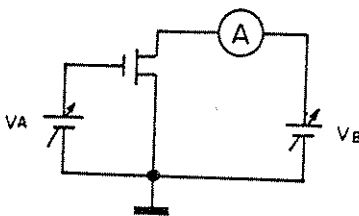

Note

Specific information on DUT connection is described in paragraph 3-61.

Figure 3-17. I-V Function Operating Instructions (sheet 4 of 4).

Model 4140B

3-49. C-V MEASUREMENT.

3-50. The Model 4140B can automatically synchronize measurement timing between the pA Meter section and the VS (Voltage Source) section to make Quasi-Static C-V characteristics measurements when the FUNCTION is set to C-V. Accurate C-V measurements, using the precise ramp (/ , \) waves and the high stability pA Meter with its 10⁻¹⁵A max. resolution, can be made by taking advantage of the instruments' variable digital integration (moving average method) described in paragraph 3-18. The capacitance value is calculated from the following formula:

$$C = \frac{I \text{ (measured current value)}}{dV/dt \text{ (ramp rate)}}$$

C-V measurement operations are described in paragraphs 3-49 thru 3-60. For basic operational instructions of the pA Meter section, refer to paragraphs 3-12 thru 3-26 and for operation of the VS section refer to paragraphs 3-27 thru 3-42.

3-51. C-V Measurement Data Output

3-52. Timing in C-V measurements is automatically synchronized between the pA Meter and the accurate ramp wave (/ , \) by the VS section to assure that the measurements are taken at the correct times. Output voltage of the ramp wave changes continuously at a specific ramp rate (dV/dt) so that digital integration (for each voltage step) is done using the raw current measurement data before and after VA goes to its step voltage (in equal periods above and below the step voltage as fixed by the integration time). Therefore, the relationship between the C-V measurement and its data output (to the I·C DISPLAY and VS DISPLAY) will be as shown in Figures 3-18 and 3-19.

Note

When the raw current measurement data for digital integration is short, an invalid data annunciation (~~-----~~) is displayed on the I·C DISPLAY. This annunciation always appears just after changing FUNCTION, after a parameter(s) is changed, or at the START V. If the STEP V is set to a small value when the ramp rate (dV/dt) is set to a fast value and the integration time is set to LONG, this annunciation also appears at several

step voltages just after START V. In a C-V measurement, lesser significant digit data of the calculated capacitance is displayed when the number of significant digits for the current measurement data is less than the total digits of the calculated capacitance. (refer to Figure 3-20). In an I·C DISPLAY, the lesser significant digit data is represented by a small zero figure (0) to differentiate it from the more significant digit which is represented by a large zero (0) as shown in Figure 3-4.

3-53. C-V Measurement Range

3-54. For a C-V measurement, the 4140A provides two measurement ranges, 0.0pF~199.9pF in 0.1pF steps and 200pF~1999pF in 1pF steps. Range changing is done automatically. In addition, a current measurement range, which is an actual measurement range, is provided as in I or I-V measurements (refer to paragraph 3-16). If the I·C DISPLAY count is over 1999 counts when the current measurement range is held, the I·C DISPLAY displays an (~~0-A~~) annunciation as in I or I-V measurements. If the calculated capacitance value is over 1999 pF, the I·C DISPLAY displays an (~~LOF~~) annunciation. If the calculated capacitance value in percent is over 199.9% when the I·C DISPLAY is set to percent display, the I·C DISPLAY displays an (~~POF~~) annunciation. The relationship between the calculated capacitance value and current measurement ranges are shown in Figure 3-20. To make C-V measurements on the most suitable current measurement range, use the following procedures:

- (1) Set the 4140B for C-V measurement (refer to Figure 3-23).
- (2) Set FUNCTION to I-V.
- (3) At this time, the 4140B panel control functions are automatically set as follows (refer to paragraph 3-8):
VA 
- (4) Set I RANGE to AUTO.
- (5) Select desired VA output mode with VA Mode Select key.
- (6) Make an I-V measurement.
- (7) Set current measurement range to maximum range for an I-V measurement.

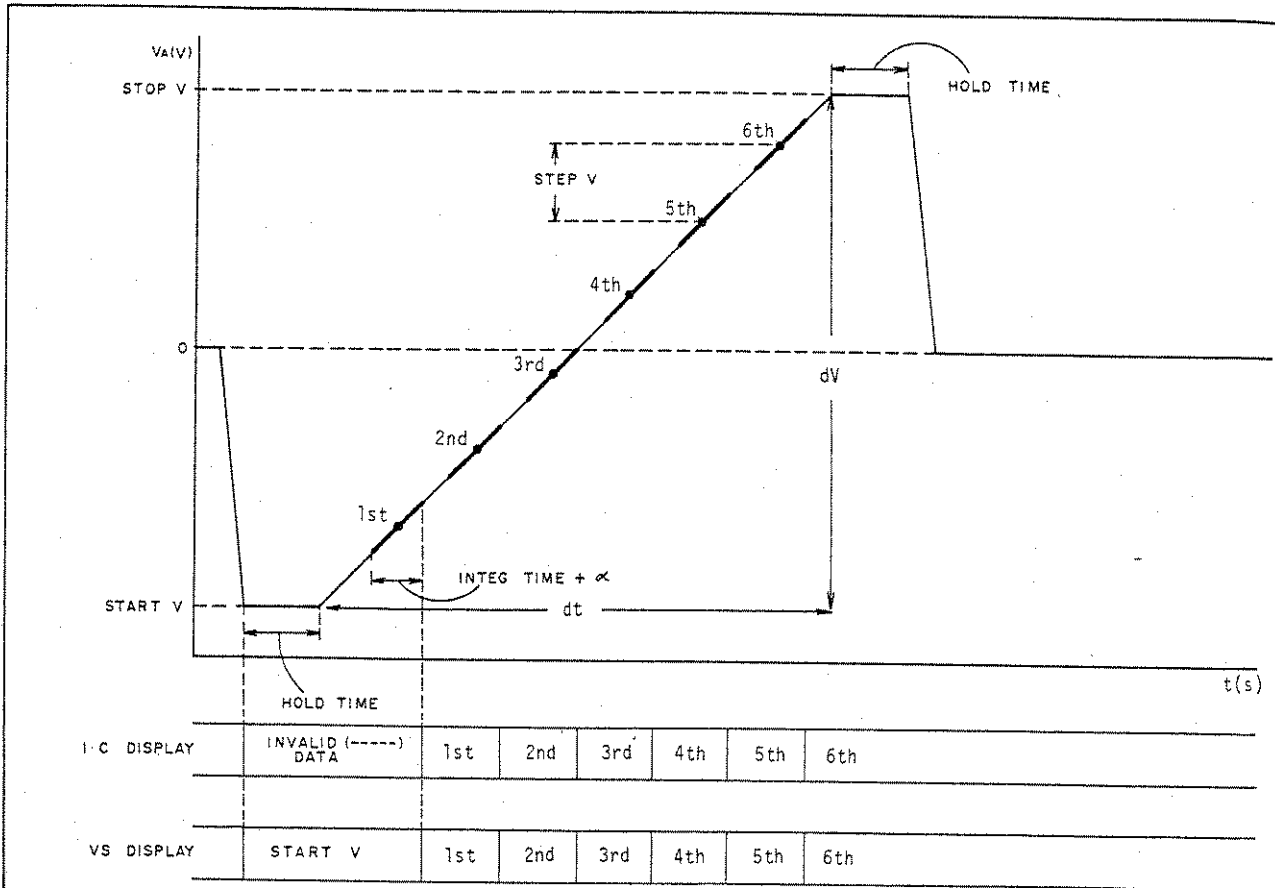

Figure 3-18. Relationship between C-V Measurement and Displays for \nearrow (Single Ramp Wave).

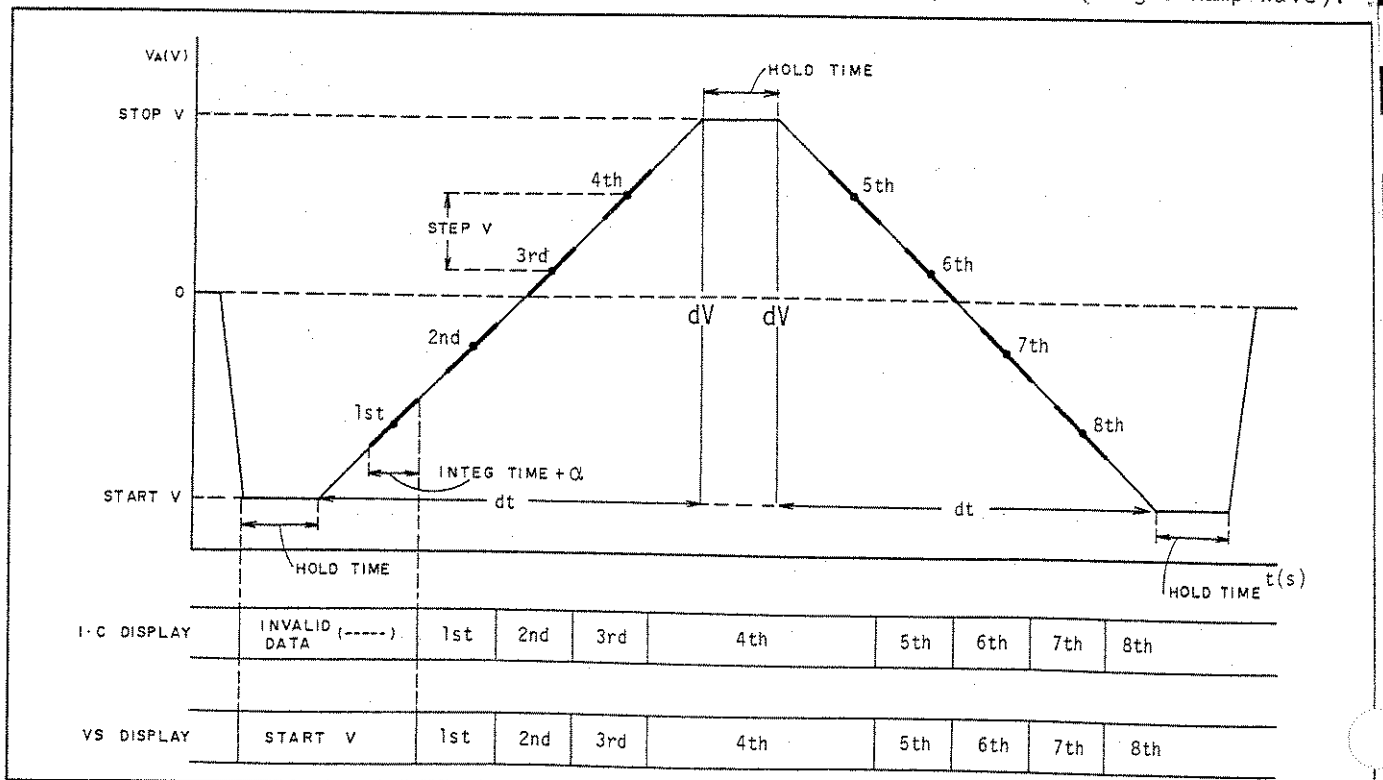
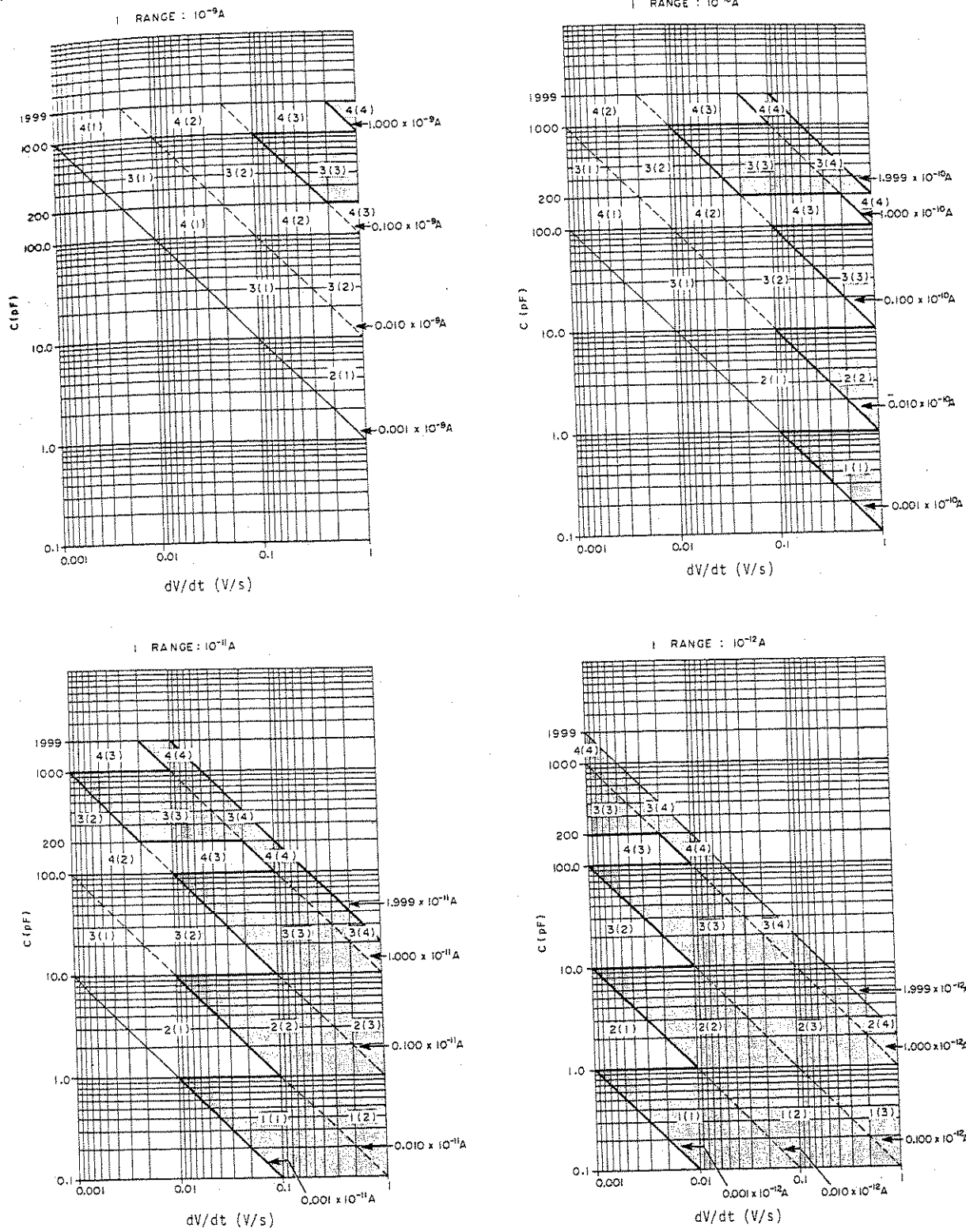

Figure 3-19. Relationship between C-V Measurement and Displays for \wedge (Double Ramp Wave).



(Note 1) Accuracies are specified in shaded areas only.
 (Note 2) Numerics in each area mean digits of capacitance (current).

Figure 3-20. Relationship between Calculated Capacitance Value and Current Measurement Range.

- (8) Set FUNCTION to C-V.
- (9) At this time, the 4140B panel control functions are automatically set as follows (refer to paragraph 3-8):

VA ✓
 C measurement
 unit indicator pF

- (10) If calculated capacitance value is to be displayed in percent, set displayed value of I·C DISPLAY to percent change with Percent key.
- (11) Select desired VA output mode with VA Mode Select Key.
- (12) Start C-V measurement with AUTO START key.

Note

These procedures are the most effective methods for setting up the most suitable current measurement range for C-V measurement. However, this method may take a relatively long time when the ramp rate (dV/dt) is set to a slow value. If the approximate capacitance value of the DUT is known, the most suitable current range for a C-V measurement can be selected by using Figure 3-21.

The accuracy of the 4140B C-V measurement is determined by the accuracy of the pA Meter current measurement and of the ramp rate (dV/dt) accuracy of the ramp wave (from the above equation). Calculated accuracies for C-V measurements are given in Table 3-6 and Figure 3-22, as reference data (not as specifications).

3-55. C-V Measurement Zero Offset

3-56. In a C-V measurement, the 4140B has a zero offset function for capacitance which is independent of the zero offset function for a current measurement (refer to paragraph 3-23). To minimize measurement error, the zero offset for C-V measurement can be used to cancel the offset error caused by stray capacitance in the test leads/test fixture. The method for doing a zero offset is described in Figure 3-23. Offset limit for a C-V measurement is 0.0 ~ 100.0pF. The zero offset value is set to 0pF when the 4140B is turned to ON. When the ZERO offset key is pushed, the value of the I·C DISPLAY adds to the zero offset value.

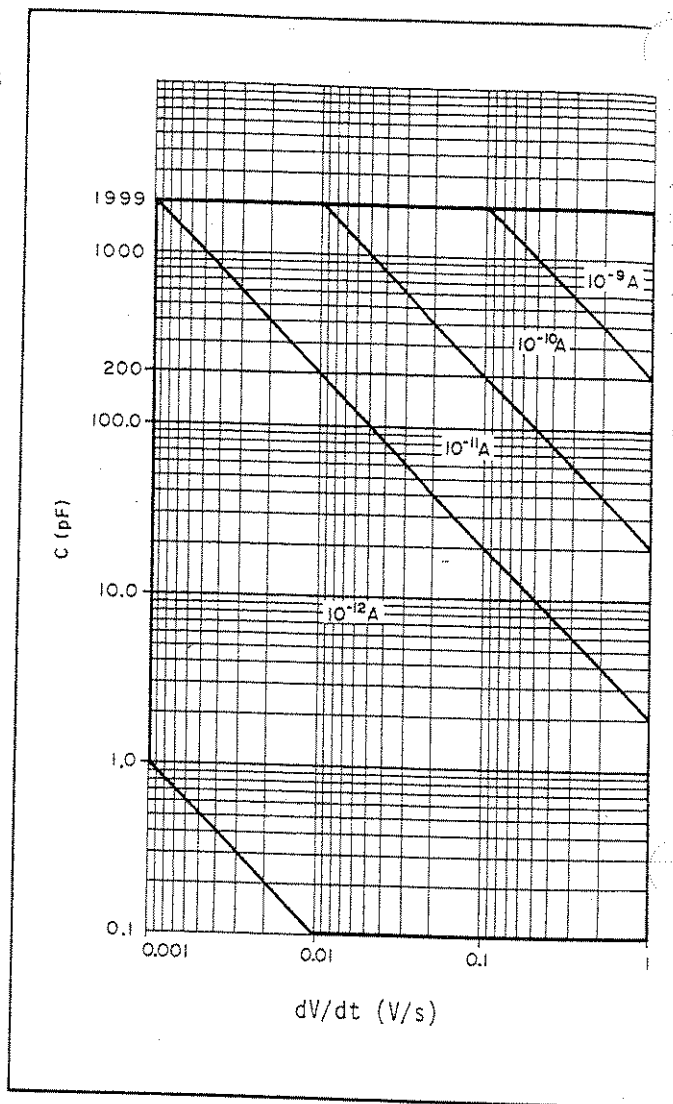

Figure 3-21. Suitable Current Measurement Ranges for C-V Measurements.

Note

A zero offset can also be done by remote program code "Z" via the HP-IB.

Table 3-6. C-V Measurement Accuracy.

Output Voltage Range (V)	Capacitance Measurement Range (pF)	Current Measurement Range (A)	dV/dt (V/s)		
			0.001 ~ 0.01	0.01 ~ 0.1	0.1 ~ 1
± 10	100.0	10 ⁻¹⁰			$\pm((2.2 + \frac{0.001}{dV/dt}) + \frac{2}{dV/dt})$
		10 ⁻¹¹	$\pm((5.2 + \frac{0.001}{dV/dt}) + \frac{0.3}{dV/dt})$		
		10 ⁻¹²	$\pm((5.2 + \frac{0.001}{dV/dt}) + \frac{0.08}{dV/dt})$		
	1000	10 ⁻⁹			$\pm((0.7 + \frac{0.001}{dV/dt}) + \frac{2}{dV/dt})$
		10 ⁻¹⁰	$\pm((2.2 + \frac{0.001}{dV/dt}) + \frac{0.2}{dV/dt})$		
		10 ⁻¹¹	$\pm((5.2 + \frac{0.001}{dV/dt}) + \frac{0.03}{dV/dt})$		
		10 ⁻¹²	$\pm((5.2 + \frac{0.001}{dV/dt}) + \frac{0.008}{dV/dt})$		
± 100	100.0	10 ⁻¹⁰			$\pm((2.2 + \frac{0.008}{dV/dt}) + \frac{2}{dV/dt})$
		10 ⁻¹¹	$\pm((5.2 + \frac{0.008}{dV/dt}) + \frac{0.3}{dV/dt})$		
		10 ⁻¹²	$\pm((5.2 + \frac{0.008}{dV/dt}) + \frac{0.08}{dV/dt})$		
	1000	10 ⁻⁹			$\pm((0.7 + \frac{0.008}{dV/dt}) + \frac{2}{dV/dt})$
		10 ⁻¹⁰	$\pm((2.2 + \frac{0.008}{dV/dt}) + \frac{0.2}{dV/dt})$		
		10 ⁻¹¹	$\pm((5.2 + \frac{0.008}{dV/dt}) + \frac{0.03}{dV/dt})$		
		10 ⁻¹²	$\pm((5.2 + \frac{0.008}{dV/dt}) + \frac{0.008}{dV/dt})$		

Note 1. = (% of reading + counts) at 23°C±5° C, ≤ 70 % humidity.
 Note 2. Accuracies can be specified only in shaded areas of Figure 3-20.
 Note 3. Leakage current through resistance of DUT and test leads contributes additional error.

3-57. C-V Measurement in Percent

3-58. The C-V measurement of the 4140B can be displayed as percent change VS Cox (the reference capacitance value). Display range in percent is 0.0%~189.9% in 0.1% steps. Cox is the capacitance of an oxide film of MIS construction. Percent change VS Cox is the most suitable display method for normalizing and analyzing C-V characteristics of MIS construction. The Setting limit for Cox is 0.1 pF~189.9pF in 0.1pF steps and 190pF~1900pF in 1pF steps.

Note

The Cox value can be set via the HP-IB (refer to paragraph 3-85).

Note

If setting of Cox value exceeds the setting limit described above, the VS DISPLAY displays an annunciation (U-F) and the Cox value selected is not input.

3-59. C-V Measurement Operating Instructions.

3-60. Operating instructions for a C-V measurement are given in Figure 3-23.

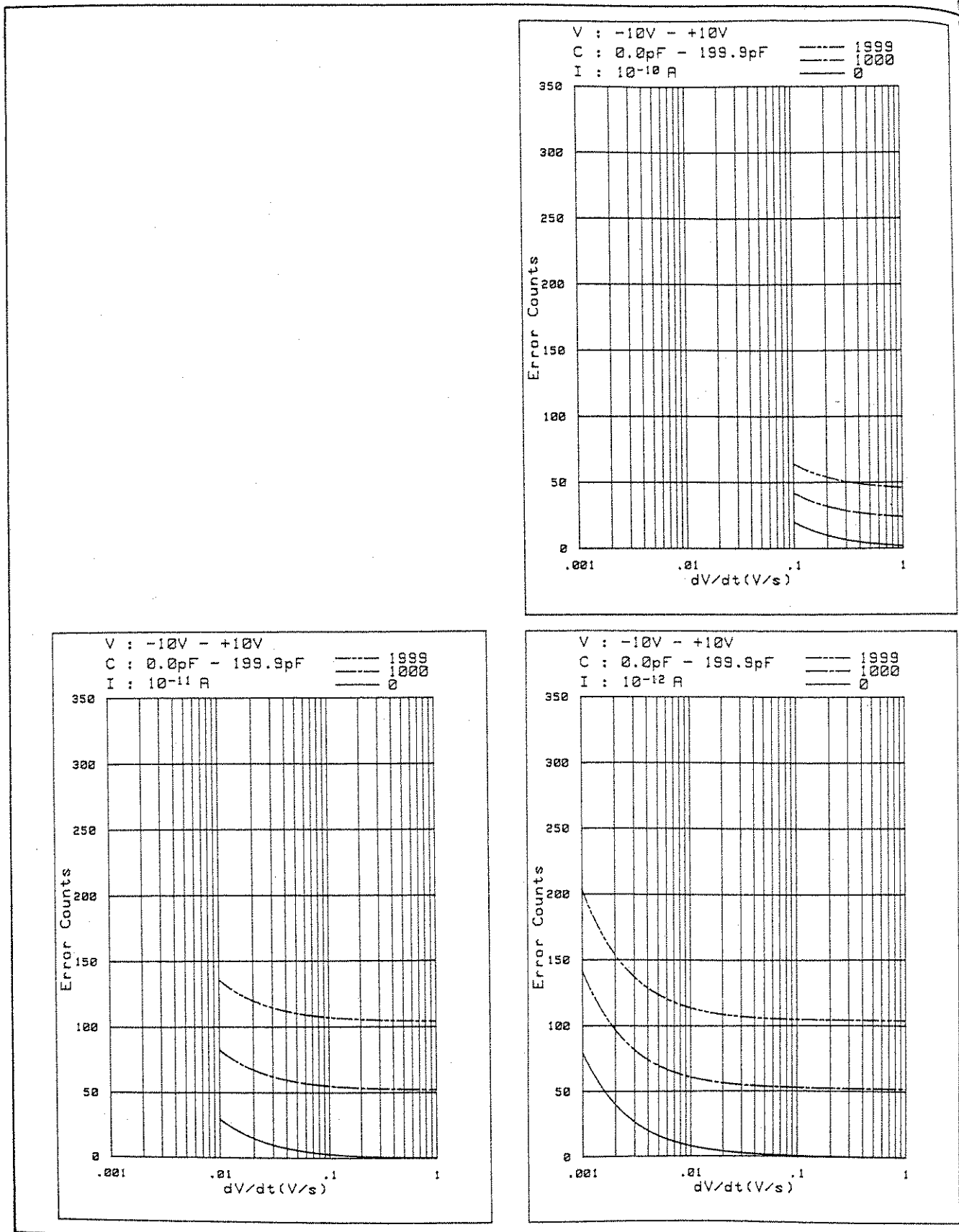

Figure 3-22. C-V Measurement Accuracy (Sheet 1 of 4).

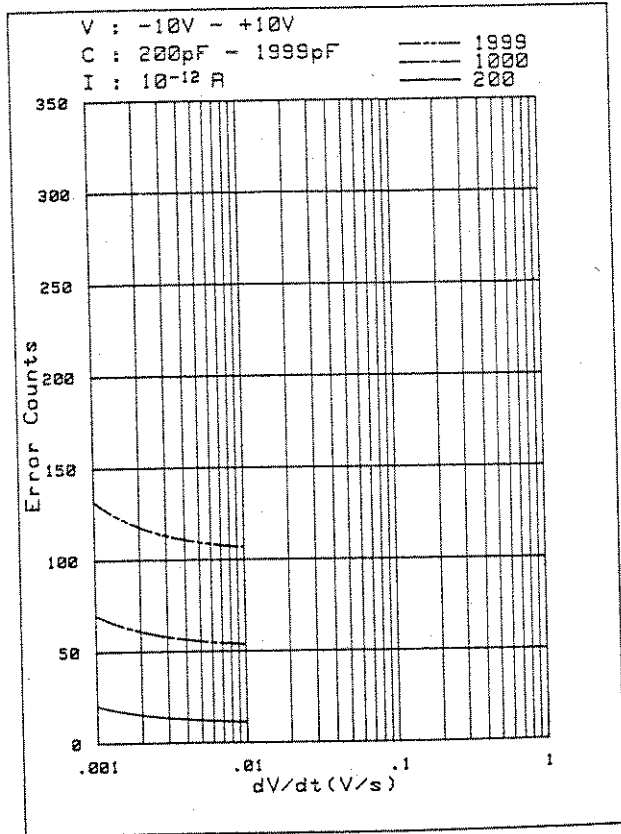
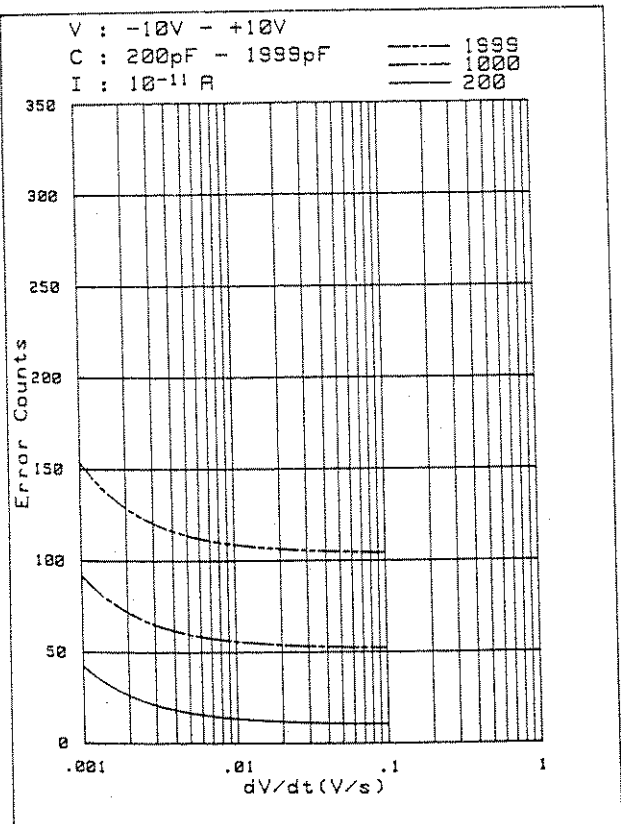
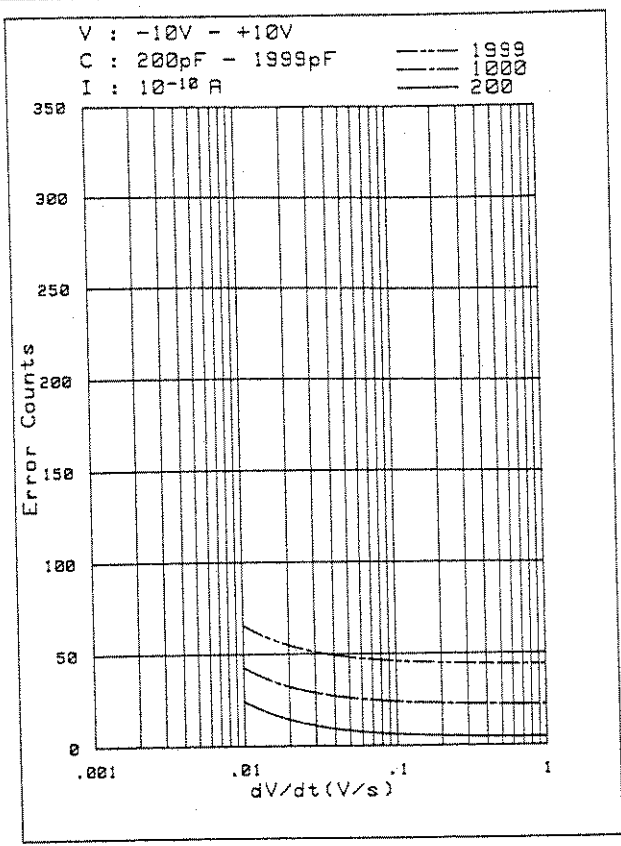
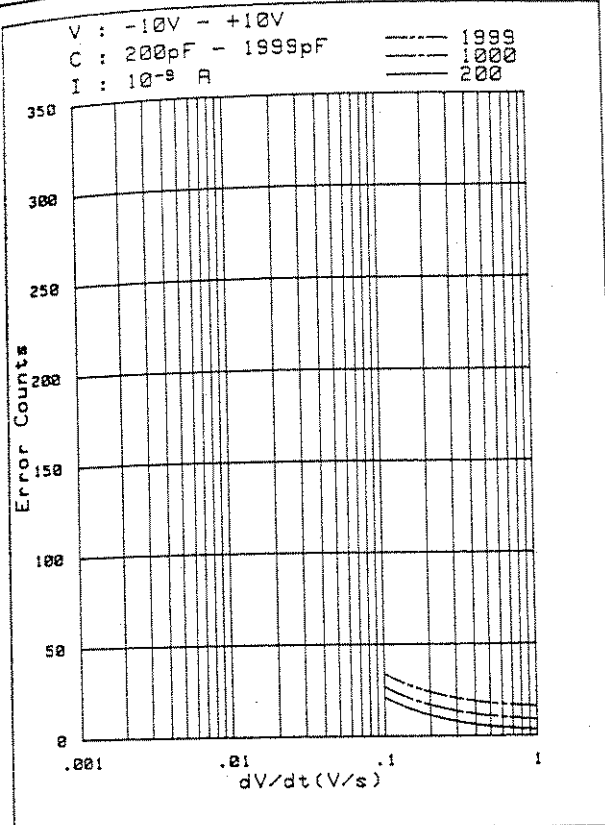

Figure 3-22. C-V Measurement Accuracy (Sheet 2 of 4).

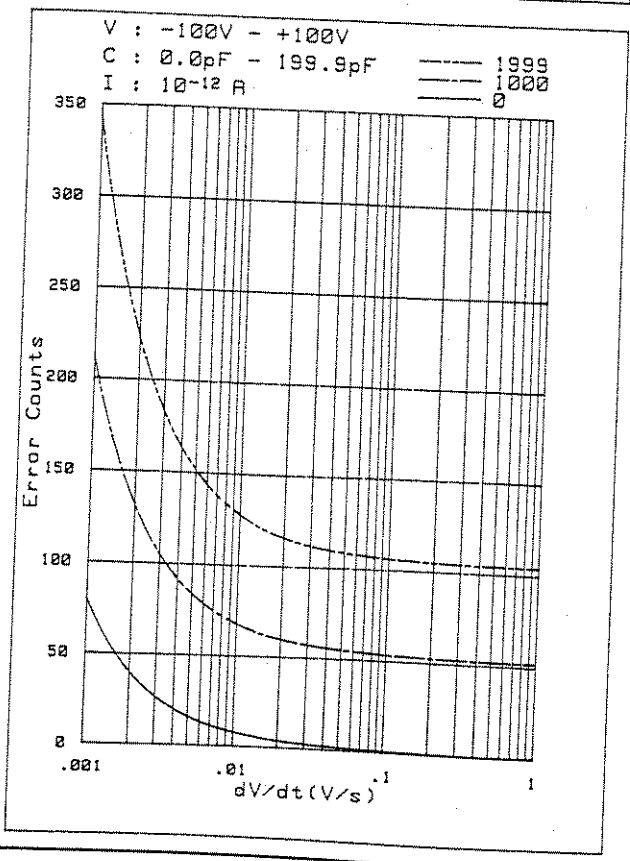
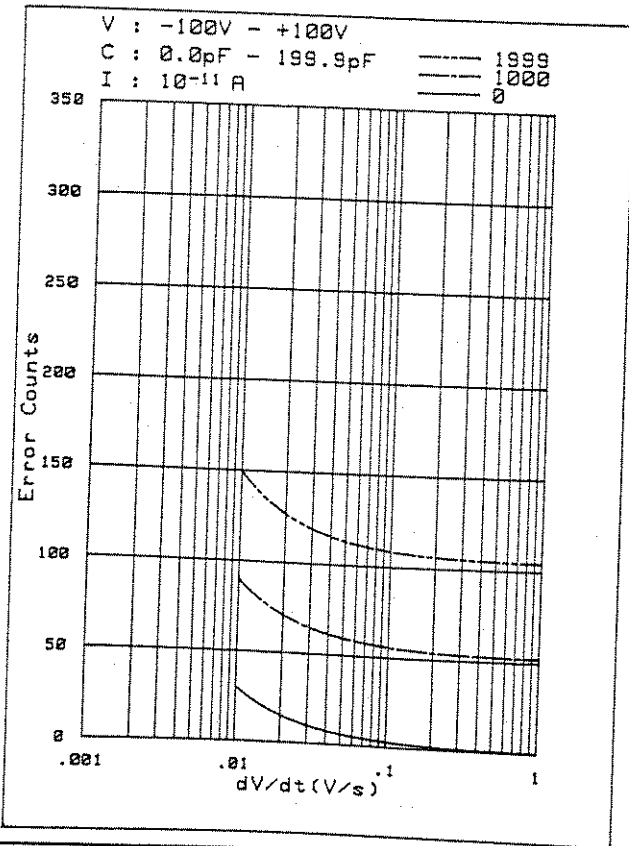
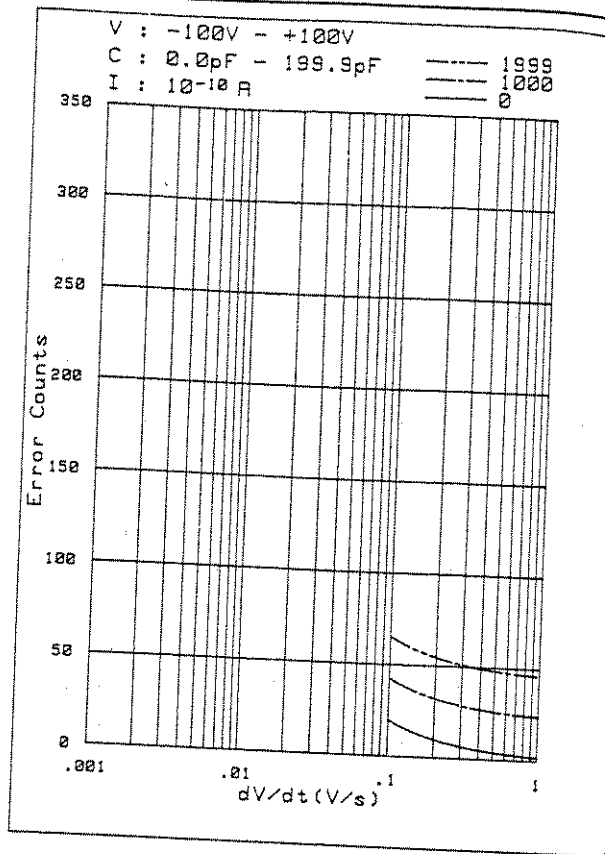

Figure 3-22. C-V Measurement Accuracy (Sheet 3 of 4).

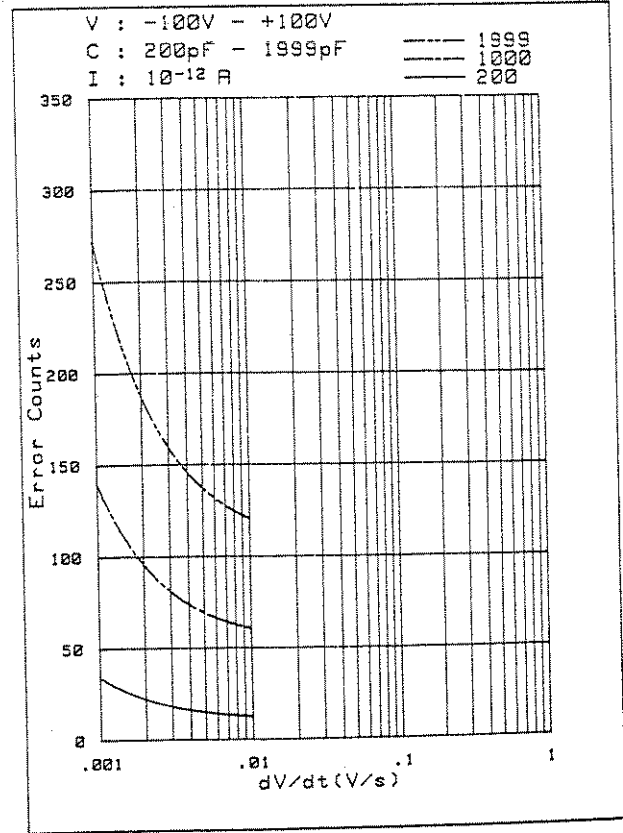
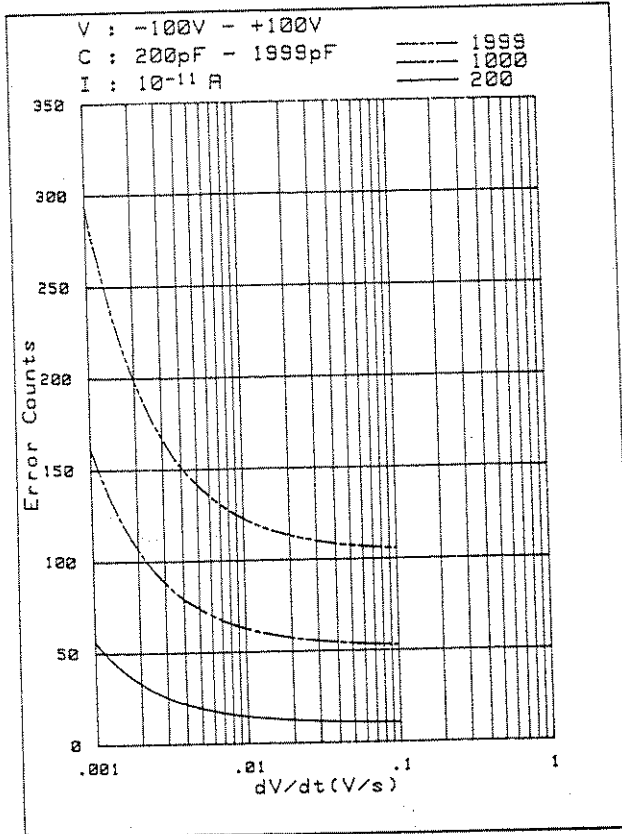
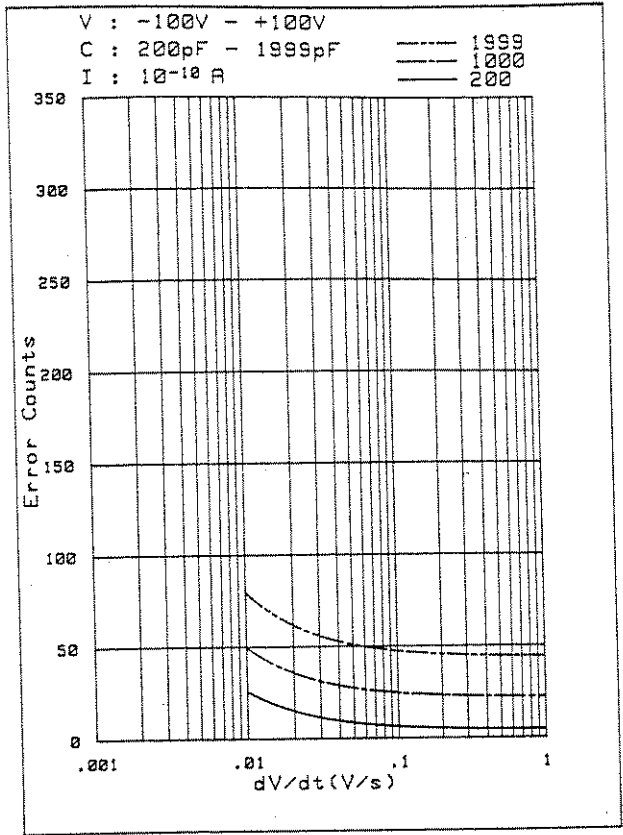
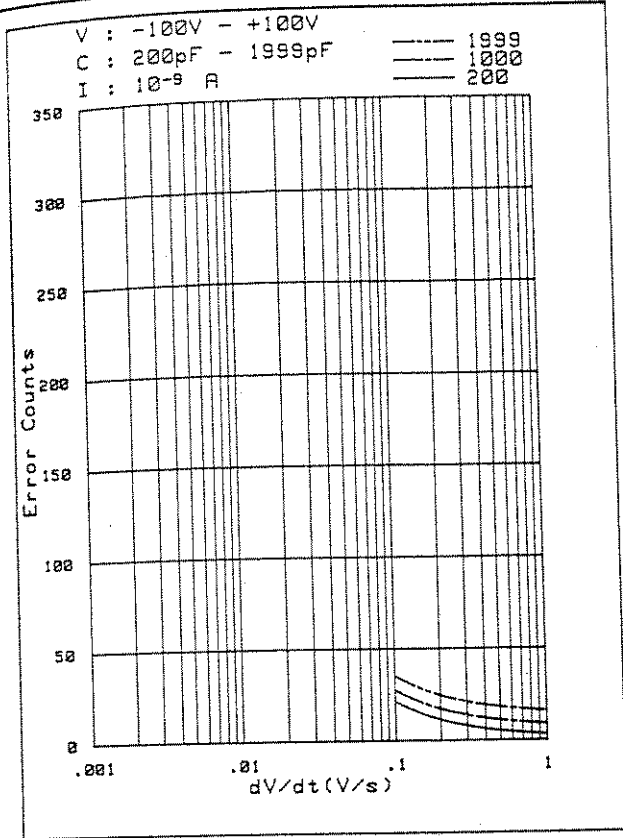
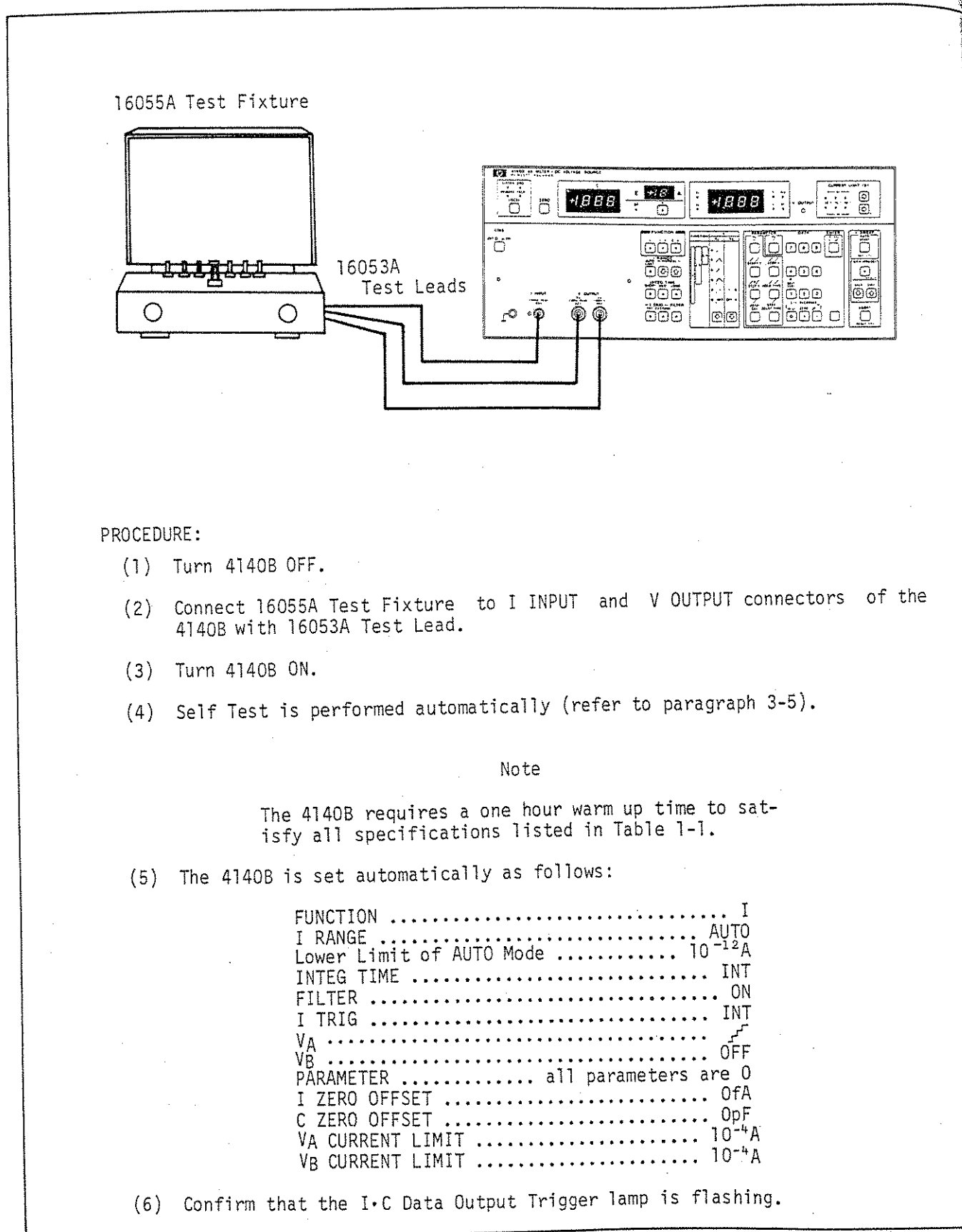

Figure 3-22. C-V Measurement Accuracy (Sheet 4 of 4).



PROCEDURE:

- (1) Turn 4140B OFF.
- (2) Connect 16055A Test Fixture to I INPUT and V OUTPUT connectors of the 4140B with 16053A Test Lead.
- (3) Turn 4140B ON.
- (4) Self Test is performed automatically (refer to paragraph 3-5).

Note

The 4140B requires a one hour warm up time to satisfy all specifications listed in Table 1-1.

- (5) The 4140B is set automatically as follows:

FUNCTION	I
I RANGE	AUTO
Lower Limit of AUTO Mode	$10^{-12}A$
INTEG TIME	INT
FILTER	ON
I TRIG	INT
VA	OFF
VB	OFF
PARAMETER	all parameters are 0
I ZERO OFFSET	0fA
C ZERO OFFSET	0pF
VA CURRENT LIMIT	$10^{-4}A$
VB CURRENT LIMIT	$10^{-4}A$

- (6) Confirm that the I·C Data Output Trigger lamp is flashing.

Figure 3-23. C-V Function Operating Instructions (sheet 1 of 3).

- (7) Select desired current measurement range with I RANGE keys (refer to paragraph 3-53).
- (8) Select desired integration time with the INTEG TIME keys (refer to paragraph 3-18).
- (9) Set FUNCTION to C-V.
- (10) VA output mode is automatically set to \surd .
- (11) Select desired VA and VB output modes with VS Mode Select keys (refer to paragraph 3-31).
- (12) Input values for VA operating parameters (START V, STOP V, STEP V, HOLD TIME and dV/dt) (refer to paragraph 3-33).
- (13) When calculated capacitance value is to be displayed in percent, input value for Cox (refer to paragraph 3-57).
- (14) If VB is to be used, input value for VB = .
- (15) Select current limit values of VA and VB with CURRENT LIMIT Select keys (refer to paragraph 3-39).
- (16) Select low lead connection of pA Meter section in the 4140B with 16055A LOW LEAD CONNECTION Select switch (depending on kind of measurement).
- (17) Connect nothing to 16055A (Open).
- (18) Start C-V measurement with AUTO START key on front panel.
- (19) Set I·C DISPLAY to 0.0pF with ZERO offset key (refer to paragraph 3-55).

Note

Any residual capacitance which exists on test leads or test fixture increases the error of the C-V measurement. To avoid this condition, do a ZERO offset under the same conditions as for an actual measurement.

- (20) When calculated capacitance value is to be displayed in percent, set displayed value of I·C DISPLAY to percent change with percent key.
- (21) Connect DUT to 16055A with alligator clips or T0-5 socket depending on kind of measurement.
- (22) Start C-V measurement with AUTO START key.

Figure 3-23. C-V Function Operating Instructions (sheet 2 of 3).

Connection for Quasi-Static C-V characteristic measurement are given below:

MOS Diode:

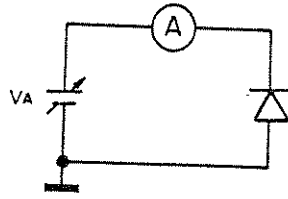

Note

Specific information on DUT connection is described in paragraph 3-61.

Figure 3-23. C-V Function Operating Instructions (sheet 3 of 3).

3-61. DUT CONNECTION.

3-62. The 4140B pA Meter/DC Voltage Source has the following features that make pA current measurements reliable and efficient.

- (1) Integration times suitable to the current measurement range and UNKNOWN conditions can be selected via front panel controls or HP-IB programming.
- (2) AC noise can be reduced by digital integration (moving average technique) using the even raw current measurement data synchronized with the line frequency.
- (3) AC noise can also be reduced by the internal filter circuit.
- (4) The 16055A Test Fixture, with electrostatic/light-shielded hood, is provided for measuring general devices.

However, to realize stable low-current measurements at 10^{-9} A down to 10^{-12} A, care must be observed in DUT connection to minimize the effects of leakage current in the measurement system, external noise, light, etc. Figure 3-24 shows measurement errors caused by leakage current i_L and external noise i_n . The errors can be reduced by employing a LOW-guard method where the HIGH terminal (the center conductor of the I INPUT connector) of the pA meter is guarded by the LOW terminal (the inner braid of the I INPUT connector) as shown in Figure 3-25. The effects of externally generated noise and light can also be reduced by measuring the DUT in the electrostatic/light-shielded box. Figure 3-26 shows the connection methods using the 16053A + 16055A, 16053A + shielded box, 16053A + 16054A + shielded box. When using the 16053A + 16055A, shielding is accomplished using the hood of the 16055A. Also, LOW lead connection can be changed easily via the LOW LEAD CONNECTION switch on the 16055A, refer to Figure 3-17. Figure 3-27 shows a typical DUT connection using the 16053A + 16054A + shielded box. Note the position of the LOW LEAD CONNECTION switch on the 16054A. The dotted lines show the connection method when the 16054A is not used.

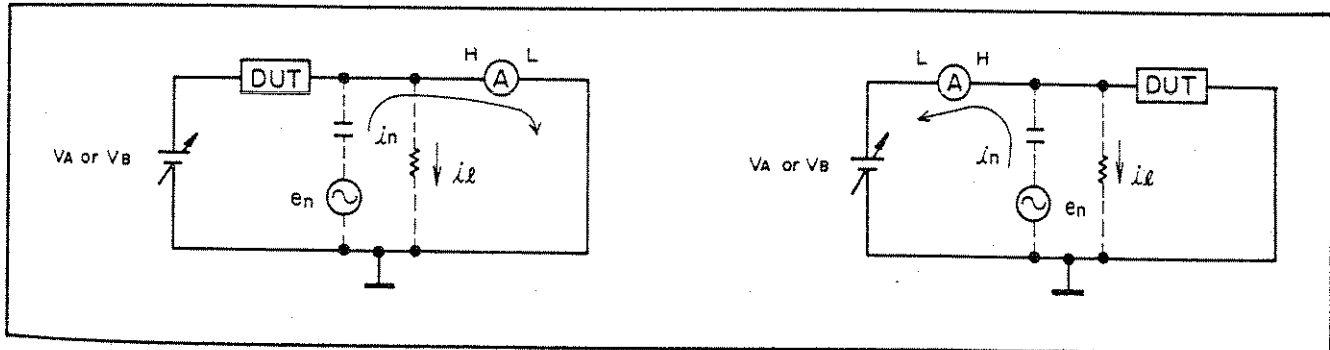

Figure 3-24. Effects of Leakage Current and External Noise.

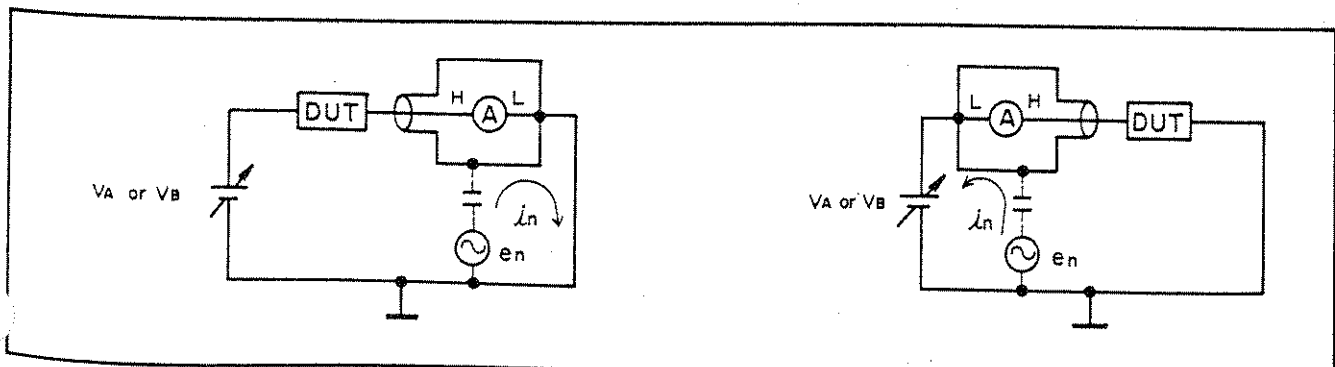

Figure 3-25. Effects of the LOW-Guard Method.

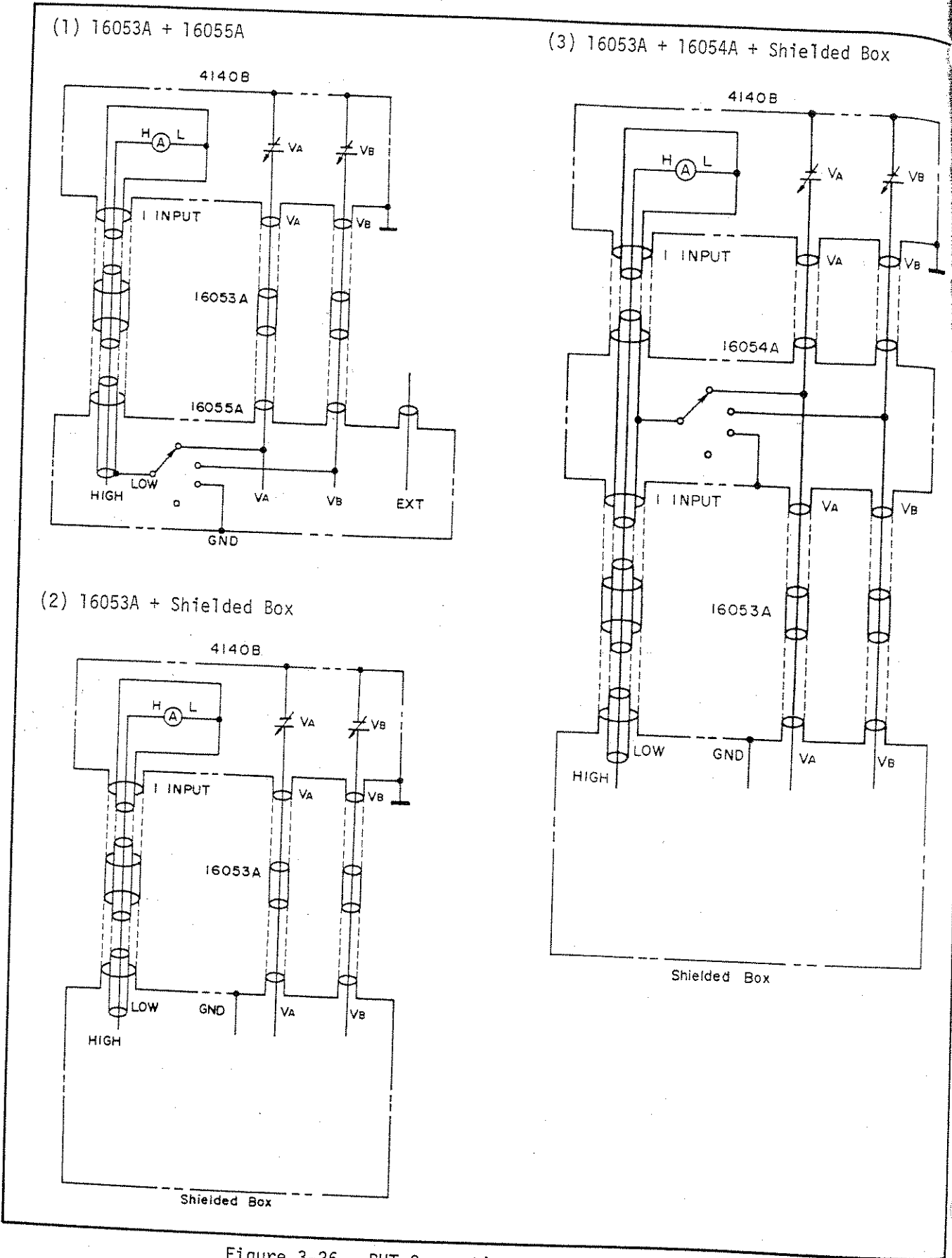
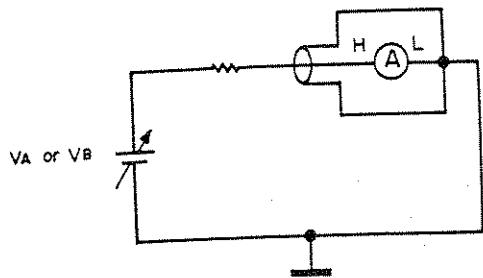

Figure 3-26. DUT Connections with Each Accessory.

(a) Ungrounded DUT Measurement

Measurement Example: High resistance measurement of the insulating materials, Condensers, etc.

Connection:



Wiring:

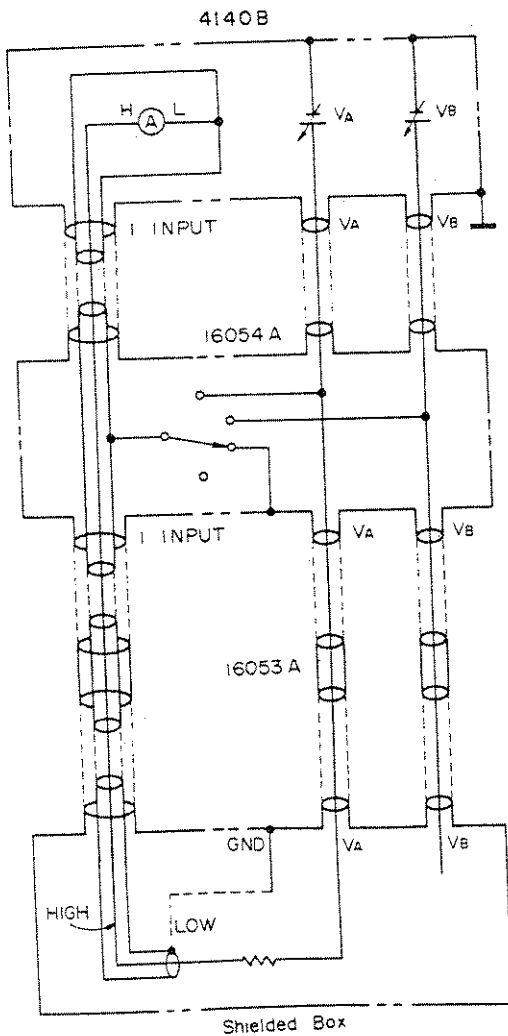

(b) Grounded DUT Measurement

Measurement Example: Breakdown voltage measurement of diode, Quasi-Static C-V characteristics measurement of MOS diode, etc.

Connection:

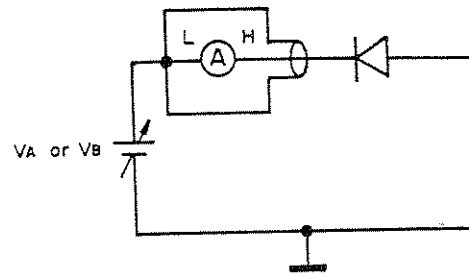

Wiring:

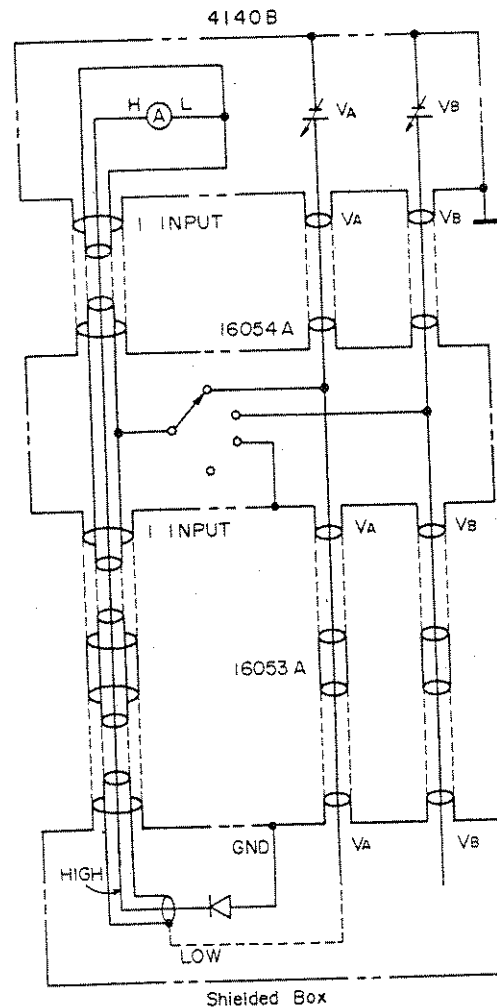
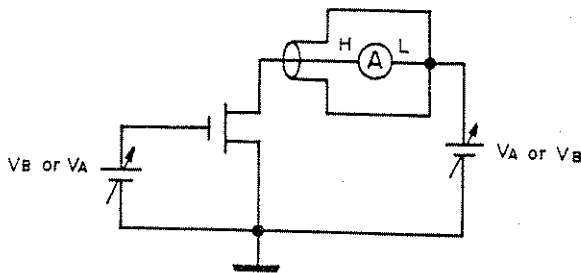

Figure 3-27. DUT Connection Examples (sheet 1 of 2).

(c) Three Terminal DUT Measurement

Measurement Example: I-V characteristics or threshold voltage measurement of an FET.

Connection:



Wiring:

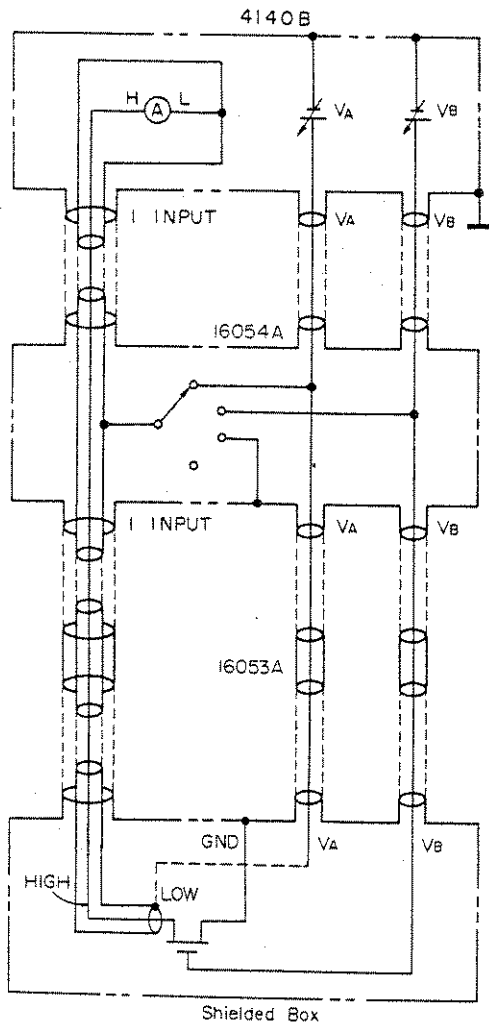

Figure 3-27. DUT Connection Examples
 (sheet 2 of 2).

3-63. DUT Connection Using the Wafer Prober

3-64. The following rules must be observed when making pA measurements on wafers at the prober station with the 4140B.

- (1) The entire prober station should be housed in a shielded box (made from copper plate, etc.) and the outer braids from the 4140B (both I INPUT and V OUTPUT) should be connected to the shielded box to increase the shielding effect.
- (2) The HIGH terminal of the pA Meter should be guarded by the LOW terminal at a point near the DUT.
- (3) The HIGH terminal of the pA Meter on the wafer at the prober station should be sufficiently isolated.

Figure 3-28 shows various connection methods for wafers at the prober station.

(1) Both measurement terminals are on the Wafer Surface.

(1-a) Ungrounded DUT Measurement

Connection:

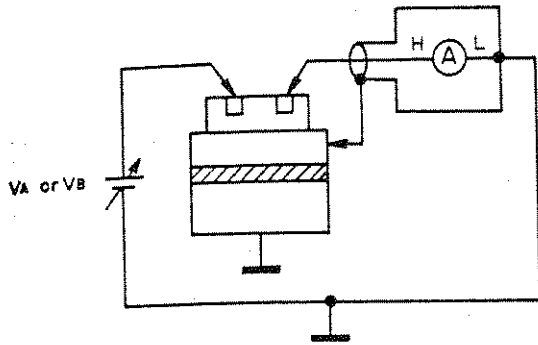

(1-b) Grounded DUT Measurement

Connection:

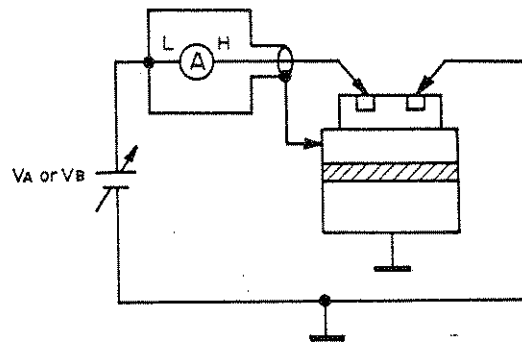

Wiring:

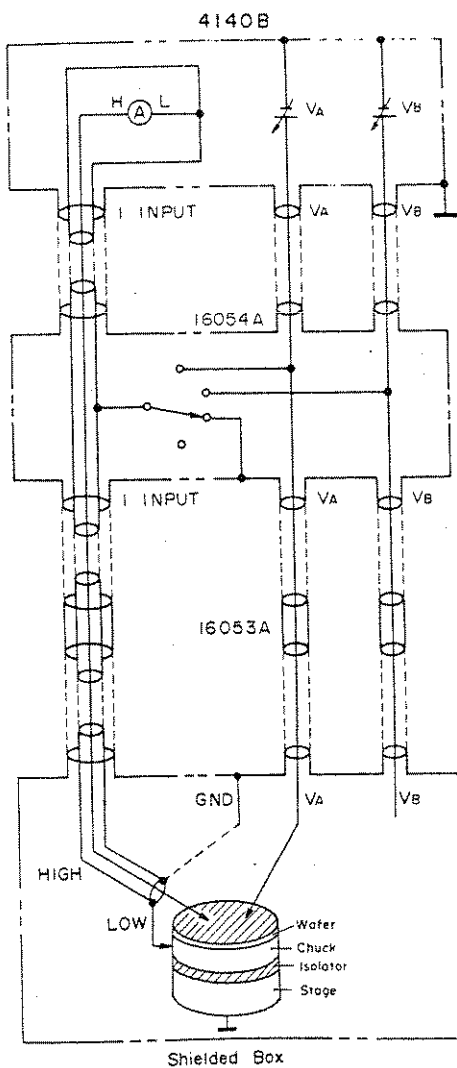

Wiring:

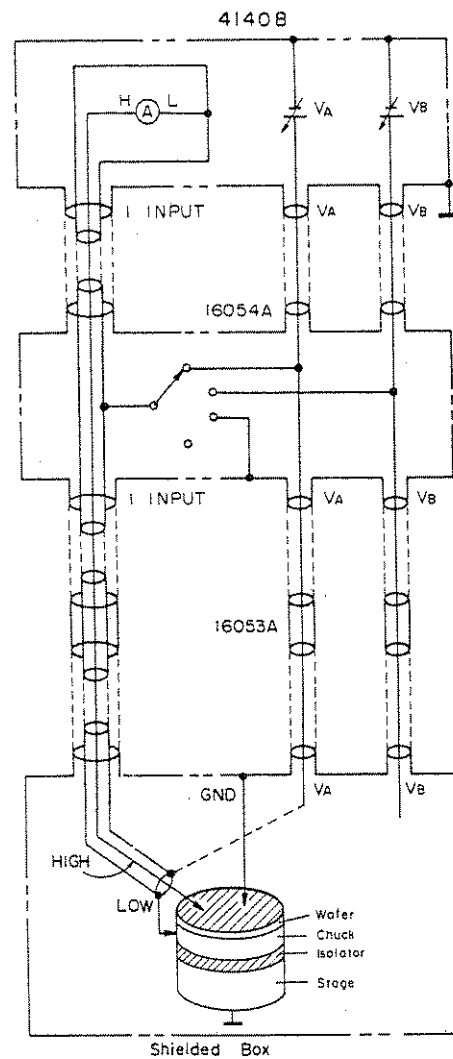
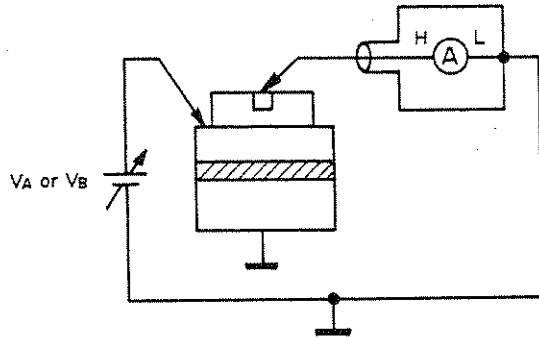

Figure 3-28. DUT Connections on Wafers at the Prober Station (sheet 1 of 2).

(2) One of the measurement terminals is on the Substrate.

(2-a) Ungrounded DUT Measurement

Connection:



Wiring:

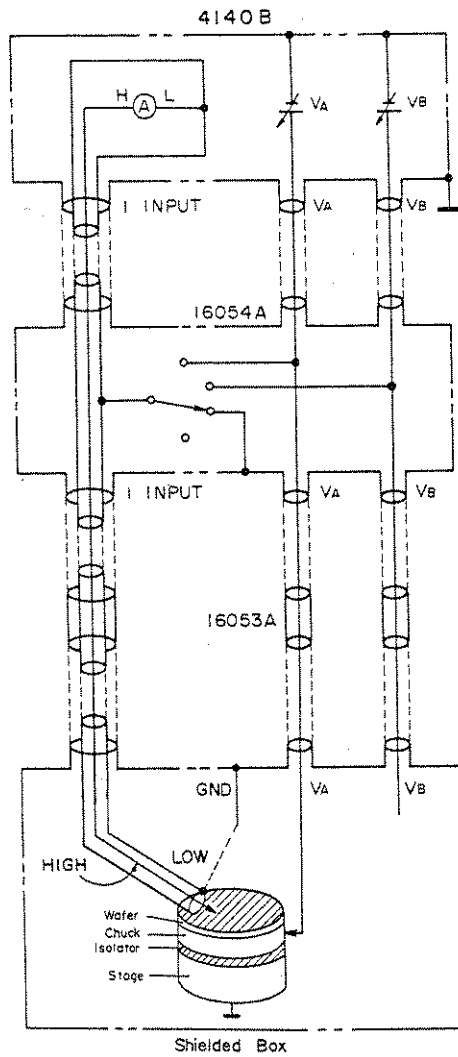

(2-b) Grounded DUT Measurement

Connection:

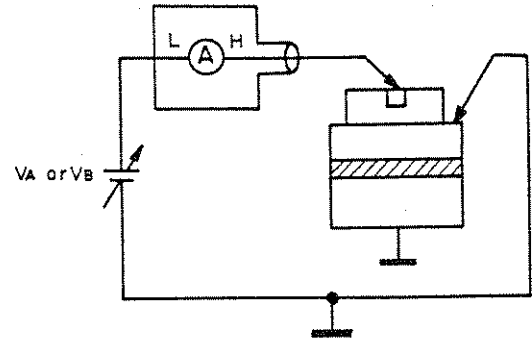

Wiring:

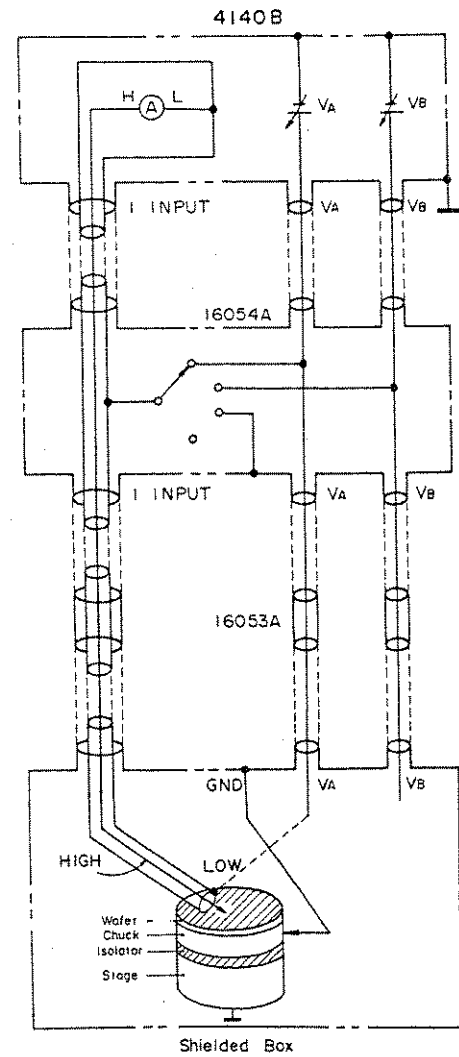

Figure 3-28. DUT Connections on Wafers at the Prober Station (sheet 2 of 2).

3-65. ANNUNCIATIONS

3-66. If control key parameters are set incorrectly or when the measured current value exceeds the upper range limit, the 4140A displays one of the annunciators given in Table 3-7. If one of these annunciators is displayed, follow the correction procedures described in Table 3-7. In addition, if one of the DC voltage sources, VA or VB, exceeds its current limit, its CURRENT LIMIT lamp will flash.

Table 3-7. 4140B Annunciators (Sheet 1 of 2).

① I-C DISPLAY Annunciators		
Annunciators	Indicated Condition and Control Settings	CORRECTION PROCEDURE
Q-F	<p>Indicated Condition:</p> <p>Measured current value exceeds upper range limit.</p> <p>Control Settings:</p> <p>(1) FUNCTION ... I or I-V I RANGE MANUAL</p> <p>(2) FUNCTION C-V I RANGE MANUAL</p> <p>(3) I RANGE AUTO</p>	<p>(1-1) Set I RANGE to AUTO.</p> <p>(1-2) If a range "hold" measurement is being made, set maximum range for auto range measurement as in step (1-1) above.</p> <p>(2-1) Set I RANGE to AUTO.</p> <p>(2-2) If a range "hold" measurement is being made, refer to paragraph 3-53.</p> <p>(3-1) Change measurement condition.</p>
UCL	The internal measurement circuit of the pA Meter section is saturated.	Perform the same correction procedure used for Q-F .
COF	<p>Indicated Condition:</p> <p>Calculated capacitance value exceeds the upper limit (1999pF).</p>	Change measurement condition (ex.set dV/dt to lower value).
POF	<p>Indicated Condition:</p> <p>Calculated capacitance value in percent exceeds its upper limit (199.9%).</p>	Increase the value of Cox.

Table 3-7. 4140B Annunciations (Sheet 1 of 2).

② VS DISPLAY Annunciations		
Annunciations	Indicated Condition	Correction Procedure
O-F	Parameter value exceeds upper limit.	Reset parameter value. Refer to Table 3-4.
ILLE	VA is swept when parameters are incorrectly set.	Reset parameter values. Refer to Table 3-4.

J. ANALOG OUTPUT.

3-68. The Analog Output can be used to output analog data of the pA Meter and DC Voltage Source as given in Tables 3-8 and 3-9. When the 4140B is connected to an X-Y Recorder (e.g. HP Model 7047A), the system can be used to trace I-V/C-V curves. The procedures for using the 4140B and an X-Y Recorder are given in Figure 3-29.

3-69. Control Capabilities for Analog Output.

3-70. The Analog Output has three capabilities for more easily, quickly and clearly tracing I-V/C-V curves. These capabilities are:

- (1) Control of pen position on the X-Y Recorder.

With control keys LL, ZERO and UR, the 4140B is able to control the X-Y recorder pen position as in Table 3-10.

Note

Control of the pen position can be done by remote control via the HP-IB. Refer to paragraphs 3-71 thru 3-100 for more specific information on the HP-IB.

- (2) Control signals for X-Y Recorder pen-lift TTL controls.

When the X-Y Recorder is provided with pen lift TTL controls, pen lift can be done automatically by TTL signals output from the PEN LIFT connector on the rear of the 4140B. This TTL signal is High (PEN UP) when V OUTPUT lamp is lit, and Low (PEN DOWN) when V OUTPUT lamp is not lit.

Table 3-8. Analog Output Data at I/C OUTPUT Connector.

Function	Value of I·C DISPLAY	Analog Output Data (V)	Resolution
I	0 ~ ±1999	0.000 ~ ±9.995	5mV/count
C	0.0 ~ 199.9	0.0000 ~ 0.9995	500µV/count
	200 ~ 1999	1.000 ~ 9.995	5mV/count
%	0.0 ~ 199.9	0.000 ~ 9.995	5mV/count

Table 3-9. Analog Output Data at VA OUTPUT Connector.

Outputted VA Voltage (V)	Analog Output Data (V)	Resolution
0.00 ~ ±10.00	0.000 ~ ±1.000	1mV/count
±10.1 ~ ±100.0	±1.01 ~ ±10.00	10mV/count

- (3) Low-pass filter for reducing noise on Analog Output data.

If the analog data output includes considerable noise and the I-V/C-V curves are strong curves, the low-pass filters provided in the Analog Output circuitry,

can be used to reduce the noise, allowing I-V/C-V curves to be tracked smoothly. The filters apply to both I/C OUTPUT data. Filter rise time can be changed with FILTER TIME CONSTANT switch on the rear panel.

Table 3-10. X-Y Recorder Pen Position Control.

Key	Voltage Output from VA OUTPUT Connector	Voltage Output from I/C OUTPUT Connector
UR (Upper Right)	Greater voltage (START V or STOP V).	Voltage at plus full scale of I.C DISPLAY (+5V).
LL (Lower Left)	Lesser voltage (START V or STOP V).	I-V: -5V (Voltage at minus full scale). C-V: 0V.
ZERO	0V.	0V.

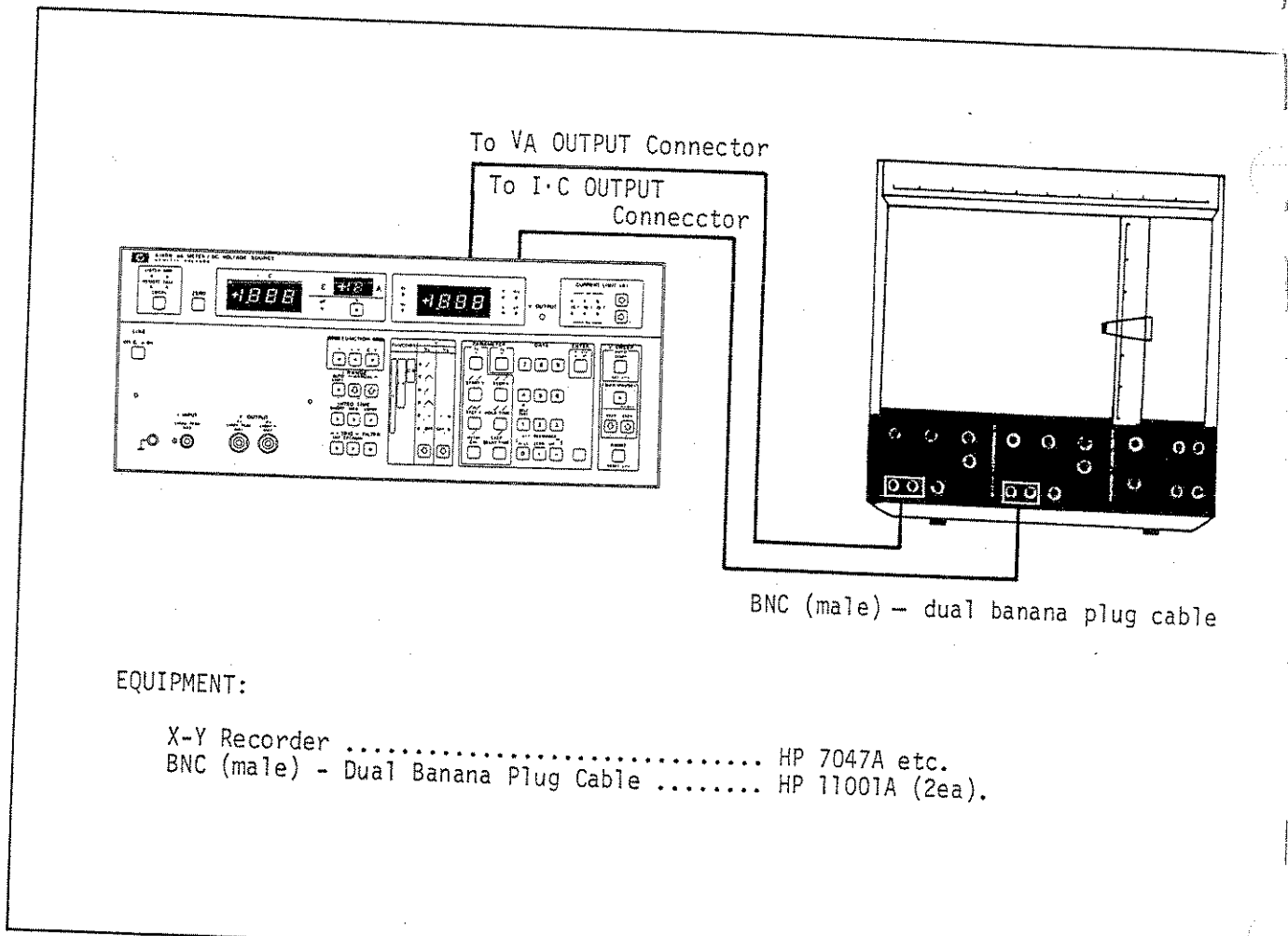

EQUIPMENT:

- X-Y Recorder HP 7047A etc.
- BNC (male) - Dual Banana Plug Cable HP 11001A (2ea).

Figure 3-29. Analog Output Operating Instructions (sheet 1 of 2).

PROCEDURE:

- (1) Turn 4140B and X-Y Recorder OFF.
- (2) Connect I/C OUTPUT connector on rear panel of 4140B to Y axis input terminals of X-Y Recorder and VA OUTPUT connector to X axis input terminals with BNC (male) - dual banana plug cables.
- (3) When X-Y Recorder is provided with pen lift TTL controls, connect PEN LIFT connector on rear panel of 4140B to X-Y Recorder connector.
- (4) Connect test leads or fixture (ex. 16053A Test Lead) to 4140B.
- (5) Turn 4140B and X-Y Recorder ON.
- (6) Set front panel controls and parameters. Refer to Figure 3-17 for I-V measurement or Figure 3-23 for C-V measurement.

Note

The 4140B HOLD TIME parameter should be set after considering the relationship between the pen position as the 4140B starts its sweep measurement and the slewing speed/acceleration of the X-Y Recorder.

- (7) Place chart paper on recorder platen.
- (8) Install disposable pen in X-Y Recorder.
- (9) Adjust zero position of X-Y Recorder.

Note

Voltages output from the VA and I/C OUTPUT connectors are set to 0V by the ZERO key on 4140B front panel.

- (10) Set input ranges of X and Y axis for X-Y Recorder.

Note

When setting input ranges, check amplitude of I-V or C-V curve by using control keys, LL (Lower Left) and UR (Upper Right).

- (11) Connect DUT to test leads or test fixture connected to the 4140B.
- (12) Lower X-Y Recorder pen onto chart paper. If X-Y Recorder is provided with pen lift TTL controls, pen is lowered automatically when sweep measurement is started (when V OUTPUT lamp is lit).
- (13) Start 4140B I-V or C-V measurement and make X-Y Recorder trace of I-V or C-V curve.
- (14) Lift X-Y Recorder pen from the chart paper when measurement is complete and X-Y Recorder stops. If X-Y Recorder is provided with pen lift TTL controls, pen is raised automatically when measurement is complete (when V OUTPUT lamp is extinguished).

Figure 3-29. Analog Output Operating Instructions (sheet 2 of 2).

3-71. HP-IB INTERFACE.

3-72. The Model 4140B can be remotely controlled by means of the HP-IB. The HP-IB is a carefully defined instrumentation interfacing method that simplifies the integration of instruments and a calculator, or computer, into a system.

Note

HP-IB is Hewlett-Packard's implementation of IEEE Std. 488-1975 Standard Digital Interface for Programmable Instrumentation.

3-73. Connection to HP-IB.

3-74. A 4140B may be connected into an HP-IB bus configuration with or without a controller (e.g. with or without an HP calculator). In an HP-IB system without a controller, the 4140B can function as a Talk Only unit (refer to paragraph 3-79).

3-75. HP-IB Status Indicators.

3-76. The HP-IB Status Indicators are four LED lamps on the front panel. These lamps show the status of the 4140A in an HP-IB system as follows:

- SRQ: SRQ signal on HP-IB line from 4140B (refer to paragraph 3-95).
- LISTEN: The 4140B is set to be listener.
- TALK: The 4140B is set to be talker.
- REMOTE: The 4140B is remotely controlled.

3-77. LOCAL Key.

3-78. The LOCAL key disables remote control from HP-IB control and enables setting measurement conditions at front panel controls (pushbutton keys). REMOTE HP-IB status indicator lamp turns off when LOCAL key is depressed. This function can not be used when the 4140B is set to local lockout status by controller.

3-79. HP-IB Control Switch.

3-80. The HP-IB Control Switch on the rear panel controls seven digits and three capabilities as follows:

- (1) Bit 1~5: The HP-IB address is established by these five digits of the control switch.

- (2) Bit 6 (delimiter form bit): This bit determines delimiter format of output data as follows:

- 0: Format A (comma).
- 1: Format B (carriage return, line feed).

- (3) Bit 7 (talk only bit): This bit determines instrument capabilities which are:

- 0: Addressable
- 1: Talk Only

Note

The 4140B is set at the factory as shown in Figure 3-30.

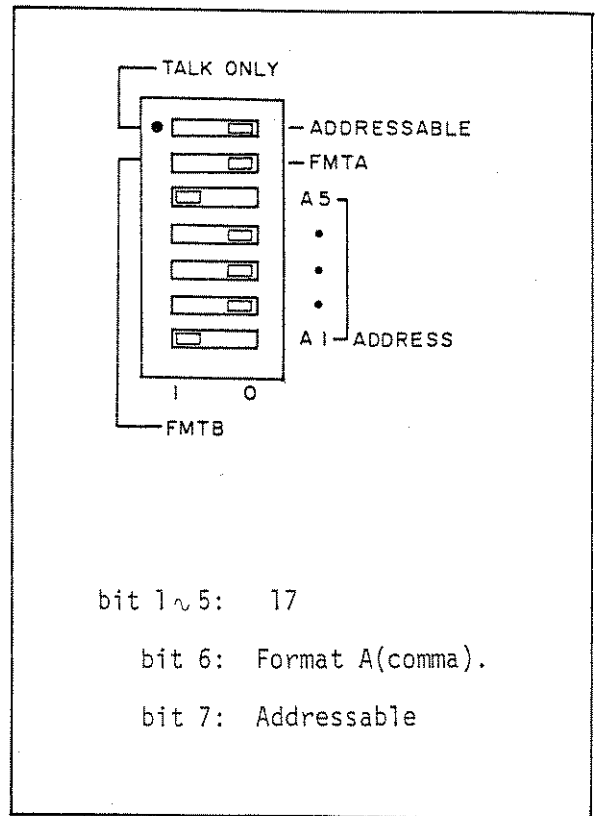

Figure 3-30. HP-IB Control Switch.

3-81. HP-IB Interface Capabilities of 4140B.

3-82. The interface of a device connected to the HP-IB is specified by the interface functions built into the device. The 4140B has eight HP-IB interface functions as given in Table 3-11.

3-83. Remote Program Code.

3-84. Remote program codes for the 4140B are listed in Table 3-12.

Table 3-11. HP-IB Interface Capabilities.

Code	Interface Function* (HP-IB Capabilities)
SH1**	Source Handshake.
AH1	Acceptor Handshake.
T5	Talker (basic talker, serial poll, talk only mode, unaddress to talk if addressed to listen).
L4	Listener (basic listener, unaddress to listen if addressed to talk).
SR1	Service Request.
RL1	Remote/Local (with local lockout).
DC1	Device Clear.
DT1	Device Trigger.

* Interface functions provide the means for a device to receive, process and transmit messages over the bus.

** The suffix number of the interface code indicates the limitation of the function capability as defined in Appendix C of IEEE Std. 488-1975.

Table 3-12. Remote Program Code (sheet 1 of 3).

FUNCTION	Control	Program Code	Description
FUNCTION	I	F1*	Description of HSI (high speed I function) is provided in paragraph 3-97.
	I-V	F2	
	C-V	F3	
	HSI	F4	
RANGE	HOLD	RA0	
	AUTO	RA1*	
	$10^{-2}A \sim 10^{-12}A$	RO2 ~ R12	
LIMIT AUTO RANGE	$10^{-2}A \sim 10^{-12}A$	HO2 ~ H12 *	

Table 3-12. Remote Program Code (sheet 2 of 3).











	Control	Program Code	Description
INTEGRATION TIME	SHORT	I1	
	MEDIUM	I2	
	LONG	I3*	
FILTER	OFF	J0	
	ON	J1 *	
I TRIG	INT	T1*	These codes are used only to set and not for triggering. When FUNCTION is set to F1 (I) or F4 (HSI), T1 is automatically set.
	EXT/MAN	T2	
C% Enable	pF	C0	When FUNCTION is set to F3 (C-V), C0 is automatically set.
	%	C1	
SWEEP CONTROL		W1	W4 is used when 4140B is set to AUTO SWEEP Mode. W2, W5 and W6 are used when 4140B is set to MANUAL SWEEP Mode.
	MANUAL	W2	
	PAUSE	W3	
	RESTART	W4	
		W5	
		W6	
		W7	
VA MODE		A1	When FUNCTION is set to F1 (I), F2 (I-V) or F4 (HSI), A3 is automatically set.
		A2	
		A3*	When FUNCTION is set to F3 (C-V), A1 is automatically set.
		A4	
		A5	
	OFF	A6	
	VB MODE		
OFF		B2*	
VA I LIMIT	100µA	L1*	
	1mA	L2	
	10mA	L3	

Table 3-12. Remote Program Code (sheet 3 of 3).

	Control	Program Code	Description
VB I LIMIT	100 μ A	M1*	
	1mA	M2	
	10mA	M3	
ZERO SET		Z	
SELF TEST	OFF	S0*	
	ON	S1	
SRQ MASK	OFF	D0*	<p>These program codes are used to control bits 1 thru 3 of SRQ Status Byte as follows:</p> <p>Bit 1: DATA READY Bit 2: CURRENT LIMITER Bit 3: AUTO SWEEP or SELF TEST END</p> <p>Refer to Figure 3-31. for more specific information on SRQ Status Byte.</p>
	ON (1)	D1	
	ON (2)	D2	
	ON (1, 2)	D3	
	ON (3)	D4	
	ON (1, 3)	D5	
	ON (2, 3)	D6	
ON (All)	D7		
TRIGGER		E	
KEY STATUS		K	
RECORDER	LL	XL	
	ZERO	XZ	
	UR	XR	

* : power ON

3-85. Parameter Setting.

3-86. A 4140B can be set to nine parameters (refer to Table 3-13) by remote programming as follows:

$\frac{XX}{(1)} \pm \frac{NNNN}{(2)}. \frac{NNX}{(3)} \text{ (CR) (LF) } \frac{N}{(4)}$

- (1) Program Code for Parameter Setting (refer to Table 3-13).
- (2) Setting Value (numeric or space).
- (3) Delimiter: ; (semi-colon)
, (comma)
N
- (4) Terminator

Table 3-13. Program Code for Parameter Setting.

Parameter	Program Code	Setting Value
VA == (V)	PA	-10.00 ~ 10.00 -100.0 ~ 100.0
START V (V)	PS	-10.00 ~ 10.00 -100.0 ~ 100.0
STOP V (V)	PT	-10.00 ~ 10.00 -100.0 ~ 100.0
STEP V (V)	PE	-10.00 ~ 10.00
HOLD/TIME (s)	PH	0.1 ~ 1999
dV/dt (V/s)	PV	-1.000 ~ 1.000
Cox (pF)	PC	0.1 ~ 1999
STEP DELAY TIME (s)	PD	0.01 ~ 100.0
VB == (V)	PB	-10.00 ~ 10.00 -100.0 ~ 100.0

3-87. Data Output.

3-88. Data output by the Model 4140B consists of:

- (1) I·C Measurement Value and VA Output Voltage.
- (2) Setting Parameter Output.
- (3) Key Status.
- (4) Service Request Status Byte.

In the following several paragraphs, each output data form is described.

3-89. I·C Measurement Value and VA Output Voltage.

3-90. Two output formats are possible with the 4140B:

a. Format A

To output either the I·C measurement value or VA output voltage in a continuous string, the delimiter form bit (HP-IB control switch Bit 6) on the rear panel is set to 0 (see paragraph 3-79). In this mode, data is output in the following format:

$\frac{XX}{(1)(2)(3)} \pm \frac{N}{(4)}. \frac{NNNE}{(5)(6)} - \frac{NN}{(7)} \text{ (CR) (LF) } \frac{N}{(8)}$

Note

The 4140B is set at the factory for output Format A.

b. Format B

To break the data into two groups (limits line length) for output to certain peripherals, such as the HP Model 5150A Thermal Printer, the delimiter form bit on the rear panel is set to 1 (see paragraph 3-79). All data is then output in the following format:

$\frac{XX}{(1)(2)(3)} \pm \frac{N}{(4)}. \frac{NNNE}{(5)(6)} - \frac{NN}{(7)} \text{ (CR) (LF) } \frac{N}{(8)}$
 $\frac{A}{(6)} = \frac{NNN}{(7)}. \frac{NN}{(8)} \text{ (CR) (LF) } \frac{N}{(8)}$

- (1) Space
- (2) Data Status

N ... Normal Data
 O ... Over Flow
 X ... No Data (only measurements using ramp wave)
 L ... Last Data (only in Auto Sweep Mode)

- (3) I and C Measurement Functions

I ... Current Measurement
 C ... Capacitance Measurement (pF Display)
 % ... Capacitance Measurement (% Display)

- (4) Value of I-C Measurement
- (5) Comma
- (6) Symbol of V_A Output Voltage
- (7) Value of V_A Output Voltage
- (8) Data Terminator

Note

The 4140B sets EOI (End or Identify) line in the HP-IB to "1" when "LF" is output.

I Each data.
 I-V/C-V Only last data.

3-91. Parameter Output.

3-92. Nine parameters can be set in the 4140B as given in Table 3-13 (refer to paragraph 3-85). Setting values of parameters can be output in the following format by using their program codes (refer to Figure 3-34).

XX±NNNN.NNN (CR) (LF)
 (1)(2) (3) (4)

- (1) Space
- (2) Program codes for 4140B parameter
- (3) Setting value of 4140B parameter
- (4) Data Terminator

3-93. Key Status Data.

3-94. This data is output from the 4140B when program code "K" is used (refer to Figure 3-36). The data is output in the following format:

FNRNNINTNCNANBNLNMNDNSNHNNJN (CR) (LF)
 (1)(2) (3) (4)(5)(6)(7)(8)(9)(10)(11)(12)(13)(14) (15)

- (1) Space
- (2) F1 ~ F4: FUNCTION
- (3) RAO, RA1, RO2 ~ R12: RANGE
- (4) I1 ~ I3: INTEGRATION TIME
- (5) T1 ~ T3: I TRIGGER MODE
- (6) C0, C1: C% Enable
- (7) A1 ~ A6: V_A MODE
- (8) B1, B2: V_B MODE
- (9) L1 ~ L3: V_A I LIMIT
- (10) M1 ~ M3: V_B I LIMIT
- (11) D0 ~ D7: SRQ MASK
- (12) S0: SELF TEST (OFF)
- (13) H02 ~ H12: LIMIT AUTO RANGE
- (14) J0, J1: FILTER
- (15) Data Terminator

3-95. Service Request Status Byte.

3-96. The 4140B sends an RQS (Request Service) signal whenever one of bits 1 thru 4, 6 or 8 is set. Figure 3-31 shows the Status Byte makeup of 4140B.

3-97. High Speed I (HSI) Function.

3-98. The 4140B has not only I, I-V and C-V functions but also has a High Speed I (HSI) function. This facilitates high speed data output of the current measurement. This function can be set only by remote program.

Bit	8	7	6	5	4	3	2	1
Information	0/1	0/1	0/1	0/1	0/1	0/1	0/1	0/1

Signal bit 7 (RQS signal) establishes whether or not a service request exists. Signal bits 1 thru 4, 6 or 8 identify the character of the service request states. Service request states of the 4140B are:

- (1) Bit 1: If Data Ready is set to ON, this state is set when measurement data is provided.
- (2) Bit 2: When CURRENT LIMIT is operating (when LED lamp on front panel is lit), this state is set.
- (3) Bit 3: When SELF TEST or Auto-Sweep Measurement is completed, this state is set.

Note

Bits 1 thru 3 are set when SRQ MASK (refer to Table 3-12) is set to ON.

- (4) Bit 4:
 - ① When the 4140B receives an erroneous remote program code, this state is set.
 - ② If the 4140B receives an illegal program when DC Voltage Source is operating (when V OUTPUT lamp on front panel is lit), this state is set.
 - ③ When parameter is set to a value over its setting limit (when VS DISPLAY on front panel displays "O-F"), this state is set.
 - ④ If V_A is swept when parameters are not set correctly (when VS DISPLAY on front panel displays "ILLE"), this state is set.
 - ⑤ If the 4140B receives trigger command when the FUNCTION is set to I-V or C-V, this state is set.
- (5) Bit 6: If Self Test is faulty, this state is set.
- (6) Bit 8:
 - ① When the 4140B receives a trigger signal before the last measurement is completed, this state is set.
 - ② When the 4140B provides measurement data while the last measurement data is being output, this state is set.

Signal bit 5 is independent of bit 7 (RQS Signal). When DC Voltage Source is operating (when V OUTPUT lamp on front panel is lit), this state is set.

Figure 3-31. Status Bytes of the 4140B.

Je (F4), and can not be set by front panel controls. When the 4140B is set to HSI function, the I·C DISPLAY on the front panel displays "H-I". The 4140B outputs current measurement data via HP-IB as in Figure 3-32 when 4140B is set to HSI function. This output data is the raw current measurement value before it is digitally integrated (refer to paragraph 3-18). This permits the 4140B in its HSI function to output data at a higher speed than in its general I function. Accuracy and data output intervals for the HSI function are shown in Table 3-14. Sample program for HSI function using an HP Desktop Computer 9825A/9835A is given in Figure 3-37.

Table 3-14. Accuracy and Data Output Interval in HSI Function.

Range (A)	Accuracy*	Data Output Interval (ms)	
		Internal	External
$10^{-2} \sim 10^{-8}$	$\pm(0.5+6)$	10(8.3)**	≥ 4
10^{-9}	$\pm(0.5+10)$		
10^{-10}	$\pm(2+10)$		
$10^{-11} \sim 10^{-12}$	$\pm(5+100)$		

* \pm (% of reading + counts) at 23°C \pm 5°C, \leq 70 humidity.
** at 50(60)Hz line frequency.

HSI(HIGH SPEED I) FUNCTION

Program code "F4" for the 4140B establishes not only the HSI (High Speed I) function, but also starts data output from 4140B. When 4140B receives "F4" from controller, the 4140B output is zero. Next, the 4140B sends an invalid byte (32 in decimal, space in ASCII) as the first byte. Beginning with the second byte, 4140B current measurement data in binary code is transmitted. Each transmission of current measurement data is made up of three bytes, which are:

***** (1) ***** (2) ***** (3) ***** (4) ***** (5)

- (1) Space: Invalid data (00100000).
- (2) Range: Range of the first measurement. 2(00000010) ~ 12(00001100).
- (3), (4) Counts: Counts of the first measurement. Typical -3600 ~ +3800. This data is made up of two bytes (sixteen bits) and sent in 2's complement.
- (5) Range: Range of the second measurement. Subsequently, each measurement data transmission is made up of three bytes sent in the same format as in (2) thru (4) above.

Note

When set to the HSI function, the 4140B does not send a data terminator (e.g. CR LF) nor does it set EOI (End or Identify) line in the HP-IB to "1". Therefore, the 4140B is sending current measurement data during the time the 4140B is set to HSI function. If 4140B is set to another function, HSI function is aborted and stops data output. A sample program for using HSI function is given in Figure 3-37.

Figure 3-32. Data Output Format of the HSI (High Speed I) Function.

3-99. Programming Guide for 4140B.

3-100. Sample Programs for HP Model 9825A/9835A Desktop Computer are provided in Figure 3-33 thru 3-37. These programs are listed in Table 3-15.

Note

Specific information for HP-IB programming with the 9825A or 9835A are provided in the 9825A or 9835A programming manuals.

Note

The equipment required for these sample programs include:

1. 4140B pA Meter/DC Voltage Source.
 2. 98034A HP-IB Interface Card.
 3. 9825A Desktop Computer with
 98210A String-Advanced Programming ROM.
 98213A General I/O Extended I/O ROM.
- or
- 9835A Desktop Computer with
 98332A General I/O ROM.

Table 3-15. Sample Program Using HP 9825A or 9835A Calculators

No.	Figure	Description
1	3-33	Remote control of pA section and data output when 4140B is set to I function.
2	3-34	Remote control of VS section and parameter output when 4140B.
3	3-35	Remote control and data output when 4140B is set to I-V or C-V function.
4	3-36	How to use remote programming code "K". -
5	3-37	Remote control and data processing when 4140B is set to High Speed I (HSI) function.

Sample Program 1

Description:

This program enables remote control of the pA Meter section and provides a data output program when the 4140B is set to I function. The program has three capabilities:

- (1) Control of the 4140B pA section via HP-IB.
- (2) Trigger of the 4140B pA section via HP-IB.
- (3) Data output from the 4140A via HP-IB.

9825A Program:

```
0: flt3
1: wrt717,"F1RA1I3T2"
   (1)(2) (3) (4)
2: wrt717,"E"
   (5)
3: red717,A,B
4: dspA,B;prtA,B
5: end
```

9835A Program:

```
10: FLOAT3
20: OUTPUT717;"F1RA1I3T2"
   (1)(2) (3) (4)
30: OUTPUT717;"E"
   (5)
40: ENTER717;A,B
50: DISP A,B
60: PRINT A,B
70: END
```

- (1) Select code of 98034A.
- (2) Address code of 4140B.
- (3) Sets 4140B to I function.
- (4) Program codes for pA section of the 4140B (refer to Table 3-12).
- (5) This line is equivalent to:

```
9825A: trg717
9835A: TRIGGER717
```

By using string variables, complete output information from the 4140B is stored by the following program:

9825A Program:

```
0: dimA$[30]
1: wrt717,"F1RA1I3T2"
2: wrt717,"E"
3: red717,A$
4: dspA$;prtA$
5: end
```

9835A Program:

```
10: DIM A$[30]
20: OUTPUT717;"F1RA1I3T2"
30: OUTPUT717;"E"
40: ENTER717;A$
50: DISP A$
60: PRINT A$
70: END
```

Figure 3-33. Sample Program 1 Using 9825A/9835A.

Sample Program 2.

Description:

This program enables remote control of the VS section and provides parameter output when the 4140B is set to I function. The program has three capabilities:

- (1) Control of the 4140B VS section via HP-IB.
- (2) Auto sweep of the 4140B VS section via HP-IB.
- (3) Parameter output from the 4140B via HP-IB.

9825A Program:

```

0: dimA$[30]
1: wrt717,"F1A4B1L2M3"
      (1) (2)
2: wrt717,"PS-10,PT10,PE1NPH2;PD.5,PB-50"
      (3) (4) (3) (4)(3)(4)(3)(4) (3) (4) (3)
3: wrt717,"PS"
      (5)
4: red717,A$
      (5)
5: dspA$,prtA$
6: wrt717,"W1"
      (6)
7: end
    
```

9835A Program:

```

10: DIM A$[30]
20: OUTPUT717;"F1A4B1L2M3"
      (1) (2)
30: OUTPUT717;"PS-10;PT10,PE1NPH2;PD.5,PB-50"
      (3) (4) (3)(4)(3)(4)(3)(4) (3) (4) (3)
40: OUTPUT717;"PS"
      (5)
50: ENTER717;A$
      (5)
60: DISP A$
70: PRINT A$
80: OUTPUT717;"W1"
      (6)
90: END
    
```

- (1) Sets 4140B to I function.
- (2) Program codes for the VS section of the 4140B (refer to Table 3-12).
- (3) Program codes for parameter setting of the 4140B (refer to Table 3-13).
- (4) Parameter terminators for the 4140B.
- (5) Statements on lines 3 and 4 (or 40 and 50) are used to output setting value of the parameter for 4140B. These statements should be continuously programmed.
- (6) Statement for AUTO START of V SWEEP.

Figure 3-34. Sample Program 2 Using 9825A/9835A.

Sample Program 3.

Description:

This program enables remote control and provides a data output program when the 4140B is set to I-V or C-V function. The program has three capabilities:

- (1) Control of I-V or C-V measurement of the 4140B via HP-IB.
- (2) Auto sweep of I-V or C-V measurement of the 4140B via HP-IB.
- (3) Data output from the 4140B via HP-IB.

9825A Program:

```

0: dim A$((1)100,30]
1: wrt 717,"F3RA1I2A1B1L2M3"
2: wrt 717,"PS-1.1;PT1.1,PE.1NPH1;PVI,PB-50"
3: wrt 717,"W1"
4: I→I
5: red 717,A$[I]
6: if A$[I,2,2]="L";I+1→I;jmp -1
(2)
7: for J=1 to I
8: prt A$[J]
9: next J
10: end

```

9835A Program:

```

10: DIM A$((1)100)[30]
20: OUTPUT 717;"F3RA1I2A1B1L2M3"
30: OUTPUT 717;"PS-1.1;PT1.1,PE.1NPH1;PVI,PB-50"
40: OUTPUT 717;"W1"
50: I→0
60: I=I+1
70: ENTER 717;A$(I)
80: IF A$(I)[2,2]≠"L" THEN 60
(2)
90: FOR J=1 TO I
100: PRINT A$(J)
110: NEXT J
120: END

```

- (1) Dimensions a string variable array that is larger than the number of measurement points.
- (2) When the 4140B is set to AUTO SWEEP, the second byte of last data is "L" (refer to paragraph 3-89).

Figure 3-35. Sample Program 3 Using 9825A/9835A (sheet 1 of 2).

The same results can be obtained by using the following program. Lines 1 and 6 (or 20 and 80) have been altered to allow use of the SRQ Status Byte.

9825A Program:

```

:
1: wrt 717, "F3RA1I2A1B1L2M3D4"
:
6: if bit (2, rds (717) ) = 0; I + 1 → I; jmp-1
:
    
```

9835A Program:

```

:
20: OUTPUT 717; "F3RA1I2A1B1L2M3D4"
:
75: STATUS 717; A
80: IF BIT (A, 2) = 0 THEN 60
:
    
```

First bit of the 4140B output data (space), just after the SRQ Status Byte is output to the controller, may be lost. Also, the Status Byte is cleared within 10ms after it is output to the controller. Therefore, if the Status Byte is output within 10ms after the last output, the last state may remain.

Figure 3-35. Sample Program 3 Using 9825A/9835A (sheet 2 of 2).

Sample Program 4.

Description:

The remote programming code "K" can be used to recognize 4140B key settings. This program shows how to use "K".

Note

When the I RANGE is set to "RA1 (AUTO)", key setting information for the I RANGE using "K" is "RA1". Therefore, the I RANGE should be set to "RA0 (MANUAL)" to recognize the true I measuring range.

9825A Program:

```

0: dim A$[30]
1: wrt 717,"K"
2: red 717,A$
3: dsp A$;prt A$
4: end
    
```

9835A Program:

```

10: DIM A$[30]
20: OUTPUT 717;"K"
30: ENTER 717;A$
40: DISP A$
50: PRINT A$
60: END
    
```

Note

The statements on lines 1 and 2 (or 20 and 30) should be continuously programmed.

Note

The remote program code "K" can not be used while the self test is performed. Besides, if "K" is used when the measurement data is provided, this data will be lost.

Figure 3-36. Sample Program 4 Using 9825A/9835A.

Sample Program 5.

Description:

This program enables remote control and is a data output program when the 4140B is set to HSI (High Speed I) function. This program has three capabilities:

- (1) Control of the 4140B HSI function via HP-IB.
- (2) High speed I/O control between the 4140B and controller via HP-IB.
- (3) Data processing for the 4140B HSI function via HP-IB.

Note

Data output interval of the HSI function is quite short (2.5 to 10ms). Therefore, general I/O programming (9825A: wrt, red, 9835A: OUTPUT, ENTER) can not be used. Only high speed I/O programming can be used for the HSI function. High speed I/O programming with the 9825A and 9835A is slightly different. A sample program for HSI is given below. More specific information for high speed I/O programming with the 9825A or 9835A is provided in the 9825A or 9835A programming manuals.

9825A Program:

```

0: ent "Number ? ",N
      (1)
1: buf "4140B",3N+1,3
      (2)
2: wrt 717,"F4"
      (3)
3: tfr 717,"4140B",3N+1
      (4)
4: rdb("4140B")→S
      (5)
5: fmt 1,f6.3,c2,f2.0,c1
6: for I=1 to N
7: rdb("4140B")→R
      (6)
8: rdb("4140B")→H
      (7)
9: rdb("4140B")→L
      (8)
10: ior(shf(H,-8),L)→C
      (9)
11: wrt 16.1,C/1000,"E-",R,"A"
12: next I
13: end

```

Figure 3-37. Sample Program 5 Using 9825A/9835A (sheet 1 of 2).

9835A Program:

```
10: OPTION BASE 1
20: INPUT "Number ? ",N
      (1)
30: DIM A$(1000)
      (2)
40: OUTPUT 717;"F4"
      (3)
50: ENTER 717 BFHS 3*N+1 NO FORMAT;A$
      (4)
60: S=NUM(A$[1,1])
      (5)
70: IMAGE D.DDD,AA,DD
80: FOR I=1 TO N
90: R=NUM(A$[3*(I-1)+2,3*(I-1)+2])
      (6)
100: H=NUM(A$[3*(I-1)+3,3*(I-1)+3])
      (7)
110: L=NUM(A$[3*(I-1)+4,3*(I-1)+4])
      (8)
120: C=BINIOR(SHIFT(H,-8),L)
      (9)
130: PRINT USING 70;C/1000,"E-",R
140: NEXT I
150: END
```

(1) N: Number of data sent.

(2) 9825A: Sets name (4140B), size (3N+1) and type (high speed read/write buffer) of the buffer for high speed I/O.

9835A: Sets name (A\$) and size ($\geq 3N+1$) of string variable for high speed I/O.

(3) Sets 4140B to HSI.

(4) Sends measurement data from 4140B to controller.

(5) Inputs first byte of measurement data from buffer to variable S.

(6) R: Range of first measurement.

(7) H: High byte of count of first measurement.

(8) L: Low byte of count of first measurement.

(9) C: 16 data count bits make up H and C.

Figure 3-37. Sample Program 5 Using 9825A/9835A (sheet 2 of 2)

Free Manuals Download Website

<http://myh66.com>

<http://usermanuals.us>

<http://www.somanuals.com>

<http://www.4manuals.cc>

<http://www.manual-lib.com>

<http://www.404manual.com>

<http://www.luxmanual.com>

<http://aubethermostatmanual.com>

Golf course search by state

<http://golfingnear.com>

Email search by domain

<http://emailbydomain.com>

Auto manuals search

<http://auto.somanuals.com>

TV manuals search

<http://tv.somanuals.com>