



## OPERATING AND SERVICE MANUAL

# MODEL 239A OSCILLATOR

**Serial Numbers: 1814A00101 and Greater**

### IMPORTANT NOTICE

This manual applies directly to instruments with the serial numbers shown on this page. If changes have been made in the instrument since this manual was printed, a "Manual Changes" supplement supplied with this manual will define these changes. Backdating information contained in Section VII adapts this manual to instruments having serial numbers lower than those shown on this page.

### **WARNING**

*To help minimize the possibility of electrical fire or shock hazards, do not expose this instrument to rain or excessive moisture.*

**Manual Part No. 00239-90000**

**Microfiche Part No. 00239-90050**

©Copyright Hewlett-Packard Company 1978  
P.O. Box 301, Loveland, Colorado 80537 U.S.A.

**Printed: April 1978**



**HEWLETT  
PACKARD**

#### **CERTIFICATION**

*Hewlett-Packard Company certifies that this product met its published specifications at the time of shipment from the factory. Hewlett-Packard further certifies that its calibration measurements are traceable to the United States National Bureau of Standards, to the extent allowed by the Bureau's calibration facility, and to the calibration facilities of other International Standards Organization members.*

#### **WARRANTY**

This Hewlett-Packard product is warranted against defects in material and workmanship for a period of one year from date of shipment [except that in the case of certain components listed in Section I of this manual, the warranty shall be for the specified period]. During the warranty period, Hewlett-Packard Company will, at its option, either repair or replace products which prove to be defective.

For warranty service or repair, this product must be returned to a service facility designated by -hp-. Buyer shall prepay shipping charges to -hp- and -hp- shall pay shipping charges to return the product to Buyer. However, Buyer shall pay all shipping charges, duties, and taxes for products returned to -hp- from another country.

Hewlett-Packard warrants that its software and firmware designated by -hp- for use with an instrument will execute its programming instructions when properly installed on that instrument. Hewlett-Packard does not warrant that the operation of the instrument, or software, or firmware will be uninterrupted or error free.

#### **LIMITATION OF WARRANTY**

The foregoing warranty shall not apply to defects resulting from improper or inadequate maintenance by Buyer, Buyer-supplied software or interfacing, unauthorized modification or misuse, operation outside of the environmental specifications for the product, or improper site preparation or maintenance.

**NO OTHER WARRANTY IS EXPRESSED OR IMPLIED. HEWLETT-PACKARD SPECIFICALLY DISCLAIMS THE IMPLIED WARRANTIES OF MERCHANTABILITY AND FITNESS FOR A PARTICULAR PURPOSE.**

#### **EXCLUSIVE REMEDIES**

**THE REMEDIES PROVIDED HEREIN ARE BUYER'S SOLE AND EXCLUSIVE REMEDIES. HEWLETT-PACKARD SHALL NOT BE LIABLE FOR ANY DIRECT, INDIRECT, SPECIAL, INCIDENTAL, OR CONSEQUENTIAL DAMAGES, WHETHER BASED ON CONTRACT, TORT, OR ANY OTHER LEGAL THEORY.**

#### **ASSISTANCE**

*Product maintenance agreements and other customer assistance agreements are available for Hewlett-Packard products.*

*For any assistance, contact your nearest Hewlett-Packard Sales and Service Office. Addresses are provided at the back of this manual.*

**TABLE OF CONTENTS**

Section	Page	Section	Page
<b>I. GENERAL INFORMATION.....</b>	<b>1-1</b>	<b>IV. PERFORMANCE TESTS (Cont'd)</b>	
1-1. Introduction .....	1-1	4-5. Test Record.....	4-1
1-4. Specifications .....	1-1	4-7. Calibration Cycle.....	4-1
1-6. Safety Considerations.....	1-1	4-9. Performance Tests.....	4-1
1-8. Instrument and Manual Identification...1-1		4-10. Output Impedance Test.....	4-1
1-12. Description .....	1-2	4-11. Output Level and Flatness Test.....	4-2
1-15. Recommended Test Equipment.....1-2		4-12. Attenuator Accuracy Test.....	4-2
		4-15. Frequency Accuracy Test.....	4-4
		4-16. Total Harmonic Distortion Test.....	4-4
<b>Section</b>	<b>Page</b>	<b>Section</b>	<b>Page</b>
<b>II. INSTALLATION .....</b>	<b>2-1</b>	<b>V. ADJUSTMENTS.....</b>	<b>5-1</b>
2-1. Introduction .....	2-1	5-1. Introduction .....	5-1
2-3. Initial Inspection.....	2-1	5-3. Equipment Required.....	5-1
2-5. Preparation For Use.....	2-1	5-5. Adjustment Locations.....	5-1
2-6. Power Requirements.....	2-1	5-7. Factory Selected Components.....	5-1
2-8. Line Voltage Selection.....	2-1	5-9. Adjustment Procedures.....	5-1
2-10. Power Cable.....	2-2	5-10. Gain Adjustment.....	5-1
2-12. Grounding Requirements.....	2-3	5-11. Frequency Adjustment.....	5-2
2-14. Bench Use.....	2-3	5-12. Output Adjustment.....	5-2
2-16. Rack Mounting.....	2-3		
2-18. Environmental Requirements.....	2-3	<b>Section</b>	<b>Page</b>
2-19. Operating and Storage Temperature...2-4		<b>VI. REPLACEABLE PARTS.....</b>	<b>6-1</b>
2-22. Humidity.....	2-4	6-1. Introduction .....	6-1
2-24. Altitude.....	2-4	6-4. Ordering Information.....	6-1
2-26. Repackaging For Shipment.....	2-4	6-6. Non-Listed Parts.....	6-1
		6-8. Parts Changes.....	6-1
		6-10. Proprietary Parts.....	6-2
<b>Section</b>	<b>Page</b>	<b>Section</b>	<b>Page</b>
<b>III. OPERATION.....</b>	<b>3-1</b>	<b>VII. MANUAL CHANGES.....</b>	<b>7-1/7-2</b>
3-1. Introduction .....	3-1	7-1. Introduction.....	7-1/7-2
3-3. Operating Characteristics.....	3-1		
3-4. General .....	3-1	<b>Section</b>	<b>Page</b>
3-7. Panel Features.....	3-1	<b>VIII. SERVICE .....</b>	<b>8-1</b>
3-9. Operating Instructions.....	3-1	8-1. Introduction .....	8-1
3-10. Turn-On and Warm-Up.....	3-1	8-3. Safety Considerations.....	8-1
3-12. Frequency Selection.....	3-1	8-8. Recommended Test Equipment.....	8-1
3-14. Output Level.....	3-3/3-4	<b>THEORY OF OPERATION</b>	
3-16. Ground Selection.....	3-3/3-4	8-10. General Description.....	8-2
3-18. Operator's Maintenance.....	3-3/3-4	8-15. Circuit Descriptions.....	8-3
3-19. Fuse Replacement.....	3-3/3-4	8-16. Frequency Generation.....	8-3
		8-18. Amplitude Control.....	8-4
<b>Section</b>	<b>Page</b>	8-20. Output Buffer and Attenuator.....	8-5/8-6
<b>IV. PERFORMANCE TESTS.....</b>	<b>4-1</b>		
4-1. Introduction .....	4-1		
4-3. Equipment Required.....	4-1		

**TABLE OF CONTENTS (Cont'd)****LIST OF TABLES**

Table	Page
1-1. Specifications .....	1-2
1-2. Supplemental Characteristics .....	1-3/1-4
1-3. Recommended Test Equipment .....	1-3/1-4
4-1. Output Level Flatness Test .....	4-2
4-2. Frequency Accuracy Test .....	4-5
4-3. Oscillator Total Harmonic Distortion Test .....	4-8
5-1. Factory Selected Components .....	5-3/5-4
5-2. Adjustable Components .....	5-3/5-4
6-1. Standard Abbreviations .....	6-2
6-2. Code List of Manufacturers .....	6-2
6-3. Replaceable Parts .....	6-3

**LIST OF ILLUSTRATIONS**

Figure	Page
2-1. Line Voltage Selection .....	2-2
2-2. Available Power Cables and Plug Configurations .....	2-3
3-1. Control, Connector, and Indicator Descriptions .....	3-2
4-1. Attenuator Accuracy Test .....	4-3
4-2. Total Harmonic Distortion Test .....	4-6
4-3. Logarithmic Addition of Harmonic Components .....	4-7
5-1. Adjustment and Test Point Locations .....	5-3/5-4
8-1. Model 239A Simplified Block Diagram .....	8-2
8-2. Simplified Oscillator Circuitry .....	8-3
8-3. Simplified Amplitude Control Circuit .....	8-4
8-4. Oscillator and Amplitude Control Circuit .....	8-9/8-10
8-5. Output and Power Supply Circuits .....	8-11/8-12



**HEWLETT  
PACKARD**

## **SAFETY SUMMARY**

The following general safety precautions must be observed during all phases of operation, service, and repair of this instrument. Failure to comply with these precautions or with specific warnings elsewhere in this manual violates safety standards of design, manufacture, and intended use of the instrument. Hewlett-Packard Company assumes no liability for the customer's failure to comply with these requirements. This is a Safety Class 1 instrument.

### **GROUND THE INSTRUMENT**

To minimize shock hazard, the instrument chassis and cabinet must be connected to an electrical ground. The instrument is equipped with a three-conductor ac power cable. The power cable must either be plugged into an approved three-contact electrical outlet or used with a three-contact to two-contact adapter with the grounding wire (green) firmly connected to an electrical ground (safety ground) at the power outlet. The power jack and mating plug of the power cable meet International Electrotechnical Commission (IEC) safety standards.

### **DO NOT OPERATE IN AN EXPLOSIVE ATMOSPHERE**

Do not operate the instrument in the presence of flammable gases or fumes. Operation of any electrical instrument in such an environment constitutes a definite safety hazard.

### **KEEP AWAY FROM LIVE CIRCUITS**

Operating personnel must not remove instrument covers. Component replacement and internal adjustments must be made by qualified maintenance personnel. Do not replace components with power cable connected. Under certain conditions, dangerous voltages may exist even with the power cable removed. To avoid injuries, always disconnect power and discharge circuits before touching them.

### **DO NOT SERVICE OR ADJUST ALONE**

Do not attempt internal service or adjustment unless another person, capable of rendering first aid and resuscitation, is present.

### **DO NOT SUBSTITUTE PARTS OR MODIFY INSTRUMENT**

Because of the danger of introducing additional hazards, do not install substitute parts or perform any unauthorized modification to the instrument. Return the instrument to a Hewlett-Packard Sales and Service Office for service and repair to ensure that safety features are maintained.

### **DANGEROUS PROCEDURE WARNINGS**

Warnings, such as the example below, precede potentially dangerous procedures throughout this manual. Instructions contained in the warnings must be followed.

**WARNING**

**Dangerous voltages, capable of causing death, are present in this instrument. Use extreme caution when handling, testing, and adjusting.**

A

## SAFETY SYMBOLS

### General Definitions of Safety Symbols Used On Equipment or In Manuals.



Instruction manual symbol: the product will be marked with this symbol when it is necessary for the user to refer to the instruction manual in order to protect against damage to the instrument.



Indicates dangerous voltage (terminals fed from the interior by voltage exceeding 1000 volts must be so marked).

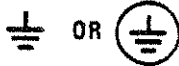

Protective conductor terminal. For protection against electrical shock in case of a fault. Used with field wiring terminals to indicate the terminal which must be connected to ground before operating equipment.



Low-noise or noiseless, clean ground (earth) terminal. Used for a signal common, as well as providing protection against electrical shock in case of a fault. A terminal marked with this symbol must be connected to ground in the manner described in the installation (operating) manual, and before operating the equipment.

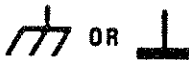

Frame or chassis terminal. A connection to the frame (chassis) of the equipment which normally includes all exposed metal structures.



Alternating current (power line).



Direct current (power line).



Alternating or direct current (power line).

**WARNING**

The **WARNING** sign denotes a hazard. It calls attention to a procedure, practice, condition or the like, which, if not correctly performed or adhered to, could result in injury or death to personnel.

**CAUTION**

The **CAUTION** sign denotes a hazard. It calls attention to an operating procedure, practice, condition or the like, which, if not correctly performed or adhered to, could result in damage to or destruction of part or all of the product.

**NOTE :**

The **NOTE** sign denotes important information. It calls attention to procedure, practice, condition or the like, which is essential to highlight.

## **SECTION I GENERAL INFORMATION**

### **1-1. INTRODUCTION.**

1-2. This Operating and Service Manual contains information necessary to install, operate, test, adjust, and service the Hewlett-packard Model 239A Oscillator.

1-3. This section of the manual contains the performance specifications and general operating characteristics of the Model 239A. This section also lists available options and accessories and includes instrument and manual identification information.

### **1-4. SPECIFICATIONS.**

1-5. Operating Specifications for the Model 239A are listed in Table 1-1. These specifications are the performance standards or limits against which the instrument is tested. Table 1-2 lists supplemental characteristics of the instrument. Supplemental characteristics are not specifications but are typical characteristics included as additional information for the user.

### **1-6. SAFETY CONSIDERATIONS.**

1-7. This product is a Safety Class 1 instrument (provided with a protective earth terminal). The instrument and manual should be reviewed for safety markings and instructions before operation.

### **1-8. INSTRUMENT AND MANUAL IDENTIFICATION.**

1-9. Instrument identification by serial number is located on a plate attached to the rear panel of the instrument. Hewlett-Packard uses a two-section serial number consisting of a four-digit prefix and a five-digit suffix separated by a letter designating the country in which the instrument was manufactured (A = U.S.A.; G = West Germany; J = Japan; U = United Kingdom). The prefix is the same for all identical instruments and changes only when a major instrument change is made. The suffix, however, is assigned sequentially and is unique to each instrument.

1-10. This manual applies to instruments with serial numbers indicated on the title page. If changes have been made in the instrument since the manual was printed, a yellow "Manual Changes" supplement supplied with the manual will define these changes and explain how to adapt the manual to the newer instruments. In addition, backdating information contained in Section VII adapts the manual to older instruments with serial numbers lower than those listed on the title page.

1-11. Part numbers for the manual and the microfiche copy of the manual are listed on the title page.

**1-12. DESCRIPTION.**

1-13. The Model 239A is an ultra-low distortion sinusoidal oscillator designed for application in the audio frequency range. Frequency range of the 239A extends from 10 Hz to 110 kHz in four overlapping decade ranges with two digit resolution. A frequency vernier provides continuous frequency coverage between settings of the second digit control.

1-14. Output level of the 239A is variable from less than 1 mV rms to 3.16 V rms when terminated with a 600 ohm load.

**1-15. RECOMMENDED TEST EQUIPMENT.**

1-16. Equipment required to maintain the Model 239A is listed in Table 1-3. Other equipment may be substituted if it meets the critical requirements listed in the table.

**Table 1-1. Specifications.**

**Frequency Range:**

10 Hz to 110 kHz in 4 overlapping decade ranges with 2 digit resolution. Frequency vernier provides continuous frequency coverage between second digit switch settings.

**Frequency Accuracy:**

± 2% of selected frequency (with FREQUENCY VERNIER in CAL position).

**Output Level:**

Maximum Calibrated Output (1 kHz, 600 Ω load):  
+ 10 dBV (3.16 Vrms) ± .2 dB  
Output variable from < 1 mV to 3.16 V rms into 600 ohms.

**Output Attenuator:**

Range: 60 dB in 10 dB steps  
Accuracy: ± .25 dB/10 dB step. Maximum Accumulative Error ± 1 dB  
Output Vernier: > 10 dB range, continuously variable

**Level Flatness:**

20 Hz to 20 kHz: ≤ ± 0.1 dB  
10 Hz to 110 kHz: ≤ ± 0.2 dB

**Distortion (≥ 600 Ω Load, ≤ 3 V Output):**

10 Hz to 20 kHz: < -95 dB (0.0018%) THD  
20 kHz to 30 kHz: < -85 dB (0.0056%) THD  
30 kHz to 50 kHz: < -80 dB (0.01%) THD  
50 kHz to 110 kHz: < -70 dB (0.032%) THD

**Output Impedance:**

600 Ω ± 5%



**Table 1-2. Supplemental Characteristics.**

<p><b>Operating Environment:</b>  Temperature: 0°C to 50°C (+32°F to +122°F)  Humidity Range: &lt;95%, 0°C to 40°C (+32°F to +104°F)</p> <p><b>Storage Temperature:</b>  -40°C to +75°C (-40°F to +167°F)</p> <p><b>Power:</b>  100/120/220/240 V, +5%, -10%, 48 to 66 Hz, 10 VA max.</p> <p><b>Weight:</b>  Net 2.5 kg (5.5 lbs.); Shipping 3.9 kg (8.5 lbs.)</p> <p><b>Dimension:</b>  106 mm wide × 88 mm high × 269 mm deep (8.4" wide × 3.5" high × 10.6" deep)</p>
--------------------------------------------------------------------------------------------------------------------------------------------------------------------------------------------------------------------------------------------------------------------------------------------------------------------------------------------------------------------------------------------------------------------------------------------------------------------------------------------------

**Table 1-3. Recommended Test Equipment.**

Instrument	Critical Specification	Recommended Model	Use
Spectrum Analyzer	Frequency Range: 10 Hz–330 kHz Frequency Resolution: .1 Hz Input Amplitude: 1 V Dynamic Range: 50 dB Measurement Resolution: ±.1 dB Minimum Bandwidth: 3 Hz	-hp- Model 3044A Spectrum Analyzer	P
True RMS Voltmeter	Frequency Range: 10 Hz–110 kHz Voltage Range: 1 mV–10 V rms Measurement Accuracy: ±.5% Measurement Resolution: .1% of full scale Crest Factor: ≥ 4	-hp- Model 3403C True RMS Voltmeter	P
Tuneable Notch Filter	Frequency Range: 10 Hz–110 kHz Notch Depth: ≥ -80 dB Input Level: 3 V rms	-hp- Model 339A Distortion Measurement Set	P
Electronic Counter	Frequency Range: 10 Hz–110 kHz Measurement Resolution: .1% of reading	-hp- Model 5300A Counter Mainframe -hp- Model 5302A Counter Module	P
Attenuator	Attenuation: 0 to 60 dB Accuracy: ±0.1 dB Input/Output Impedance: 600 Ω Frequency Range: 10 Hz to 110 kHz	-hp- Model 4437A Attenuator	P
DC Digital Voltmeter	Input Range: 15 V dc Measurement Accuracy: ±.1% Resolution: .01% of full scale	-hp- Model 3465A Digital Voltmeter	AT
Oscilloscope	Bandwidth: DC – 500 kHz Sweep Time: .1 μs – .5 sec/div. Sensitivity: .1 V/div.	-hp- Model 1221A Oscilloscope	T
Resistive Load	600 Ω, ±.1%	-hp- Accessory No. 11095A	PA

P = Performance Tests  
A = Adjustment Procedures  
T = Troubleshooting

## SECTION II INSTALLATION

### 2-1. INTRODUCTION.

2-2. This section of the manual contains information and instructions necessary to install the Model 239A Oscillator. This section also includes initial inspection procedures, power and grounding requirements, environmental information, and packaging instructions.

### 2-3. INITIAL INSPECTION.

#### WARNING

*To avoid hazardous electrical shock, do not perform electrical tests when there are signs of shipping damage to any portion of the outer enclosure (covers, panels, meters).*

2-4. This instrument was carefully inspected, both mechanically and electrically, before shipment. It should be free of marks and scratches and in perfect electrical order. The instrument should be inspected upon receipt for damage that might have occurred in transit. If the shipping container or cushioning material is damaged, it should be kept until the contents of the shipment have been checked for completeness and the instrument has been mechanically and electrically inspected. Procedures for testing the electrical performance of the Model 239A are given in Section IV of this manual. If the contents are incomplete, if there is mechanical damage or defect, or if the instrument does not pass the Performance Tests, notify the nearest Hewlett-Packard Office. (A list of the -hp- Sales and Service Offices is presented at the back of this manual.) If the shipping container is damaged, or the cushioning material shows signs of stress, notify the carrier as well as the Hewlett-Packard Office. Save the shipping materials for the carrier's inspection.

### 2-5. PREPARATION FOR USE.

#### 2-6. Power Requirements.

2-7. The Model 239A requires a power source of 100, 120, 220, or 240 V ac (+ 5%, - 10%), 48 Hz to 66 Hz single phase. Maximum power consumption is 10 VA.

#### 2-8. Line Voltage Selection.

2-9. Before connecting ac power to the Model 239A make sure the rear panel line selector switches are set to correspond to the available power line voltage and that the proper fuse is installed (see Figure 2-1). The instrument is normally shipped from the factory with the line voltage and fuse selected for 120 V ac operation.

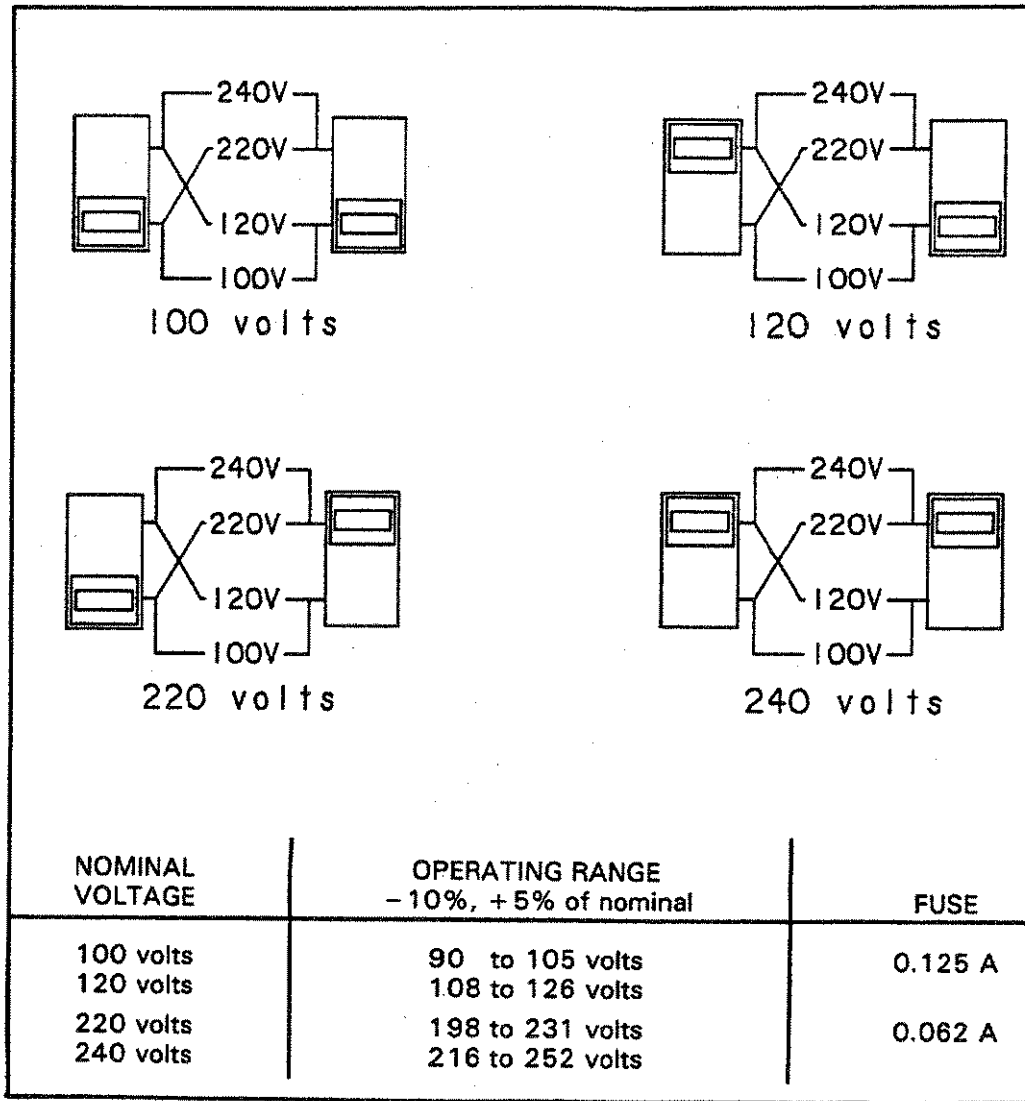
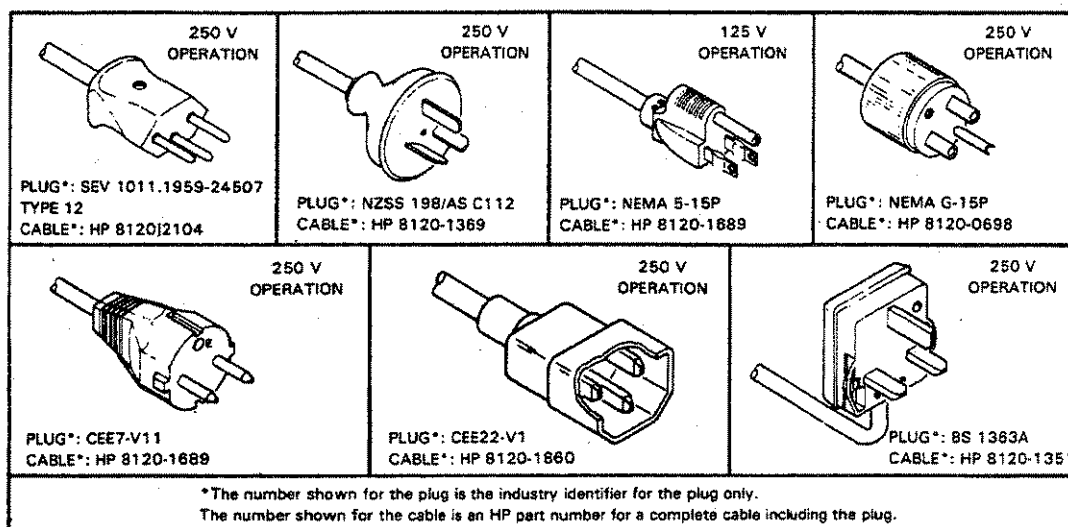

Figure 2-1. Line Voltage Selection.

2-10. Power Cable.

2-11. Figure 2-2 illustrates the standard configurations for -hp- power cables. The number directly below each drawing is the -hp- Part Number for a power cable equipped with a connector of that configuration. If the appropriate power cable is not included with the instrument, notify the nearest -hp- Sales and Service Office and the proper cable will be provided.



**Figure 2-2. Available Power Cables and Plug Configurations.**

**2-12. Grounding Requirements.**

2-13. To protect operating personnel, the National Electrical Manufacturer's Association (NEMA) recommends that the instrument cabinet and front panel be grounded. The Model 239A is equipped with a three-conductor power cable, which, when plugged into an appropriate receptacle, grounds the instrument.

**2-14. Bench Use.**

2-15. The Model 239A is shipped with plastic feet and tilt stands installed and is ready for use as a bench instrument. The plastic feet are shaped to permit "stacking" with other half-module Hewlett-Packard instruments. The tilt stand permits the operator to elevate the front of the instrument for operating and viewing convenience.

**2-16. Rack Mounting.**

2-17. The Model 239A may be rack mounted by adding rack mounting adapter kit -hp- Part Number 5061-0054. This kit contains all necessary hardware and instructions to permit the Model 239A to be mounted in a standard 19 inch rack.

**2-18. ENVIRONMENTAL REQUIREMENTS.**

**WARNING**

*To prevent electrical shock or fire hazard, do not expose the instrument to rain or moisture.*

**2-19. Operating and Storage Temperature.**

2-20. In order to meet the specifications listed in Table 1-1, the instrument should be operated within an ambient temperature range of 0°C to +50°C (+32°F to +122°F).

2-21. The instrument may be stored or shipped where the ambient temperature range does not exceed -40°C to +75°C (-40°F to +167°F). However, the instrument should not be stored or shipped where temperature fluctuations cause condensation within the instrument.

**2-22. Humidity.**

2-23. The instrument may be operated in environments with relative humidity of up to 95%. However, the instrument must be protected from temperature extremes which cause condensation within the instrument.

**2-24. Altitude.**

2-25. The instrument may be operated at altitudes up to 4572 meters (15,000 feet).

**2-26. REPACKAGING FOR SHIPMENT.****NOTE**

*If the instrument is to be shipped to Hewlett-Packard for service or repair, attach a tag to the instrument identifying the owner and indicating the service or repair to be accomplished. Include the model number and full serial number of the instrument. In any correspondence, identify the instrument by model number and full serial number. If you have any questions, contact your nearest -hp-Sales and Service Office.*

2-27. The following is a general guide for repackaging the instrument for shipment. If the original container is available, place the instrument in the container with appropriate packing material and seal well with strong tape or metal bands. If the original container is not available, proceed as follows:

- a. Wrap the instrument in heavy paper or plastic before placing it in an inner container.
- b. Place packing around all sides of the instrument and protect the front panel with cardboard strips or plastic foam.
- c. Place the instrument and inner container in a heavy carton and seal with strong tape or metal bands.
- d. Mark the shipping container "DELICATE INSTRUMENT", "FRAGILE", etc.

## SECTION III OPERATION

### 3-1. INTRODUCTION.

3-2. This section contains information and instructions necessary for operation of the Model 239A Oscillator. Included is a description of the operating characteristics and of the operating controls and connectors.

### 3-3. OPERATING CHARACTERISTICS.

#### 3-4. General.

3-5. The Model 239A is an ultra-low distortion sinusoidal oscillator designed for use in the audio frequency range. Frequency range of 239A extends from 10 Hz to 110 kHz in four overlapping ranges with two digit resolution. A frequency vernier provides continuous frequency coverage between settings of the second digit control.

3-6. Output amplitude of the 239A is variable from 3.16 mV rms to 3.16 V rms in six 10 dBV steps using the LEVEL control. A level vernier provides continuous level control between settings of the LEVEL control. Full output range of the 239A is less than 1 mV rms to 3.16 V rms when terminated by 600 ohms (<2 mV rms to 6.32 V rms open circuit).

### 3-7. PANEL FEATURES.

3-8. Front and rear panel controls and connectors are described in Figure 3-1. The description of each control and connector is keyed to the number shown in the illustration.

### 3-9. OPERATING INSTRUCTIONS.

#### 3-10. Turn-On and Warm-Up.

3-11. Before connecting ac power to the instrument, be certain the rear panel voltage selector switches are set to correspond to the voltage of the available power line and that the proper fuse is installed for the voltage selected. For rated accuracy, the 239A should be allowed to "warm up" for at least 15 minutes.

#### 3-12. Frequency Selection.

3-13. The output frequency is determined by the setting of the FREQUENCY and FREQUENCY VERNIER controls. The units and tenths controls determine the first and second digits of the desired frequency. These numbers are then multiplied by the range selected. As an example—to select a frequency of 6.4 kHz, set the units control to 6, the tenths control to .4, and the multiplier to  $\times 1k$ . (The FREQUENCY VERNIER should be set to the CAL position.) The FREQUENCY VERNIER provides continuous frequency tuning between steps of the tenths control to permit continuous frequency selection from 10 Hz to 110 kHz.

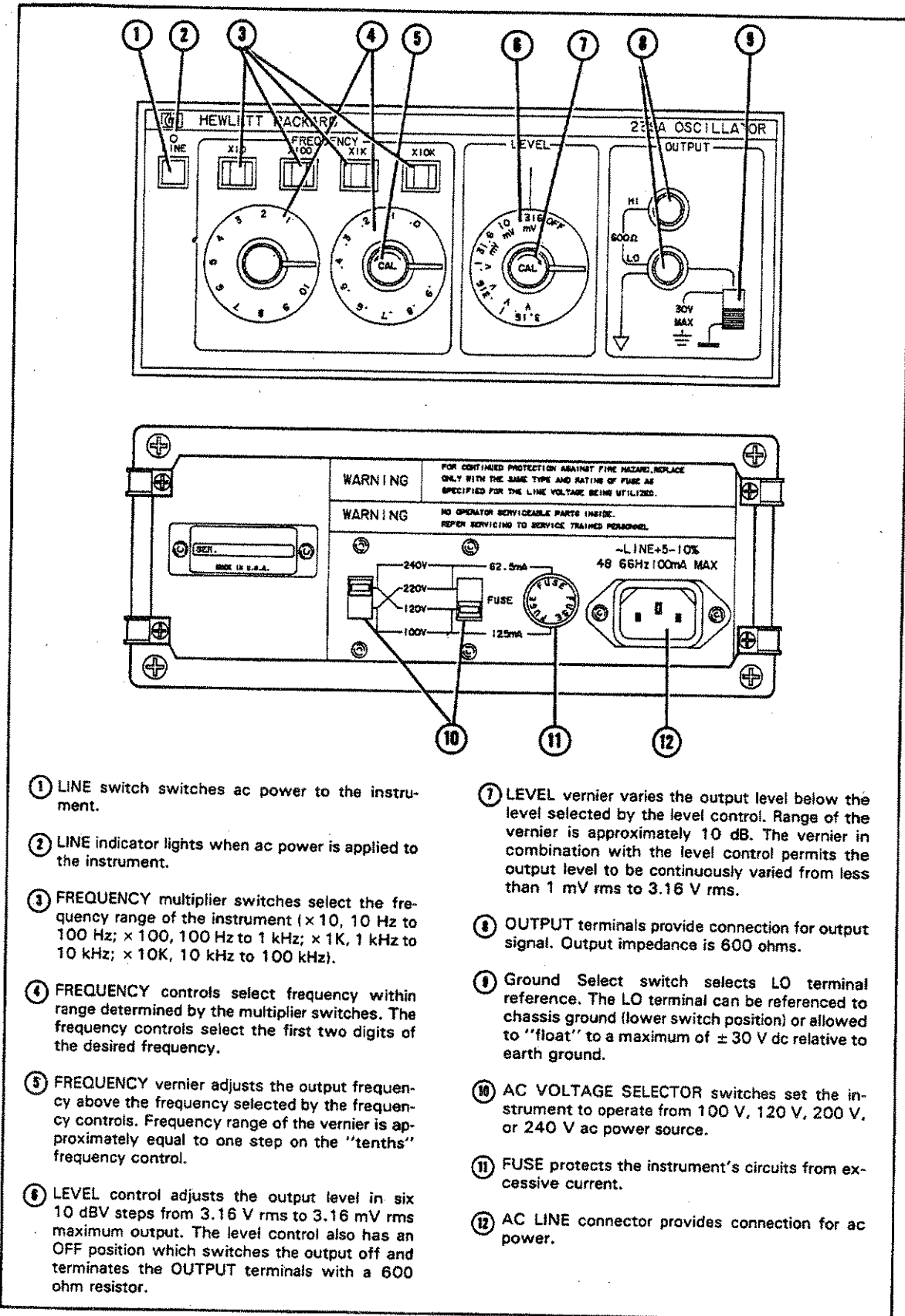

- ① LINE switch switches ac power to the instrument.
- ② LINE indicator lights when ac power is applied to the instrument.
- ③ FREQUENCY multiplier switches select the frequency range of the instrument ( $\times 10$ , 10 Hz to 100 Hz;  $\times 100$ , 100 Hz to 1 kHz;  $\times 1K$ , 1 kHz to 10 kHz;  $\times 10K$ , 10 kHz to 100 kHz).
- ④ FREQUENCY controls select frequency within range determined by the multiplier switches. The frequency controls select the first two digits of the desired frequency.
- ⑤ FREQUENCY vernier adjusts the output frequency above the frequency selected by the frequency controls. Frequency range of the vernier is approximately equal to one step on the "tenths" frequency control.
- ⑥ LEVEL control adjusts the output level in six 10 dB steps from 3.16 V rms to 3.16 mV rms maximum output. The level control also has an OFF position which switches the output off and terminates the OUTPUT terminals with a 600 ohm resistor.
- ⑦ LEVEL vernier varies the output level below the level selected by the level control. Range of the vernier is approximately 10 dB. The vernier in combination with the level control permits the output level to be continuously varied from less than 1 mV rms to 3.16 V rms.
- ⑧ OUTPUT terminals provide connection for output signal. Output impedance is 600 ohms.
- ⑨ Ground Select switch selects LO terminal reference. The LO terminal can be referenced to chassis ground (lower switch position) or allowed to "float" to a maximum of  $\pm 30$  V dc relative to earth ground.
- ⑩ AC VOLTAGE SELECTOR switches set the instrument to operate from 100 V, 120 V, 200 V, or 240 V ac power source.
- ⑪ FUSE protects the instrument's circuits from excessive current.
- ⑫ AC LINE connector provides connection for ac power.

Figure 3-1. Control, Connector, and Indicator Descriptions.

### 3-14. Output Level.

3-15. The output amplitude is controlled by the LEVEL and LEVEL VERNIER controls. The LEVEL control selects output levels from 3.16 V rms full-scale to 3.16 mV rms full-scale in six 10 dBV steps (terminated with 600 ohms). The LEVEL VERNIER provides continuous level selection between settings of the LEVEL control to permit selection of output levels from less than 1 mV rms to 3.16 V rms into 600 ohms (< 2 mV rms to 6.32 V rms open circuit).

### 3-16. Ground Selection.

3-17. A front panel switch allows the user to reference the OUTPUT LO terminal to chassis ground (bottom position) or float the LO terminal to eliminate "ground loops". The 239A chassis ground is connected to safety or power line ground at the rear panel.

### CAUTION

*To prevent damage to the oscillator circuitry, do not float the LO OUTPUT terminal more than  $\pm 30$  V dc relative to earth ground.*

### 3-18. OPERATOR'S MAINTENANCE.

#### 3-19. Fuse Replacement.

3-20. The ac line fuse is located on the rear panel of the instrument. Before checking or replacing the fuse, disconnect the ac line cord from the instrument. Refer to Figure 2-1 for the proper fuse value.

### WARNING

*For continued protection against fire hazard, replace only with the same type and rating of fuse as specified for the line voltage being used.*



## SECTION IV

# PERFORMANCE TESTS

### 4-1. INTRODUCTION.

4-2. This section contains performance test procedures which can be used to verify that the Model 239A Oscillator meets the specifications listed in Table 1-1. All tests can be performed without access to the interior of the instrument.

### 4-3. EQUIPMENT REQUIRED.

4-4. The test equipment required for the performance tests is listed at the beginning of each procedure and in the Recommended Test Equipment Table in Section I. If the recommended equipment is not available, any equipment which meets the critical specifications given in the table may be substituted.

### 4-5. TEST RECORD.

4-6. A Performance Test Record is included at the end of this section for convenience in recording performance data. This record may be removed from the manual and used as a permanent record of the incoming inspection or of a routine performance test. The Performance Test Record may be reproduced without written permission of Hewlett-Packard.

### 4-7. CALIBRATION CYCLE.

4-8. The Model 239A requires periodic verification of performance. The performance should be tested as part of the incoming inspection and at 6 month or 1 year intervals depending upon the environmental conditions and the user's specific accuracy requirements.

### 4-9. PERFORMANCE TESTS.

#### 4-10. Output Impedance Test.

##### Equipment Required:

- True RMS Voltmeter (-hp- Model 3403C)
- 600 ohm Resistive Load (-hp- 11095A)

- a. Set the 239A FREQUENCY controls for an output frequency of 1 kHz ( $1.0 \times 1$  k, frequency vernier to the CAL position) and the OUTPUT LEVEL control to the 3.16 V range.
- b. Set the RMS Voltmeter controls to measure ac volts.
- c. Connect a cable between the 239A OUTPUT terminals and the Voltmeter input connector.

- d. Adjust the 239A LEVEL VERNIER for a voltmeter reading of 6.00 V rms.
- e. Disconnect the cable from the voltmeter and insert the 600 ohm load. The voltmeter must indicate between 2.93 and 3.08 V rms.

#### 4-11. Output Level and Flatness Test.

##### Equipment Required:

True RMS Voltmeter (-hp- Model 3403C)  
600 ohm Resistive Load (-hp- Model 11095A)

- a. Set the 239A controls for an output frequency of 1 kHz ( $1.0 \times 1$  k, vernier to the CAL position) and an output level of 3.16 V (level control to the 3 V range, vernier to the CAL position).
- b. Set the True RMS Voltmeter controls to measure ac volts on the 10 volt range. Connect the 600 ohm load to the Voltmeter input.
- c. Connect the 239A output to the 600 ohm load. The voltmeter should indicate 3.16 V rms  $\pm$  .07 V rms.
- d. Adjust the 239A LEVEL controls for an output of 3.00 V rms.
- e. Set the 239A to each frequency listed in Table 4-1 and verify that the output level is within the limits specified.

**Table 4-1. Output Level Flatness Test.**

Frequency	Test Limits
10 Hz	2.93 - 3.07 V rms
20 Hz 20 kHz	2.97 - 3.03 V rms
109 kHz	2.93 - 3.07 V rms

#### 4-12. Attenuator Accuracy Test.

##### Equipment Required:

True RMS Voltmeter (-hp- Model 3403C)  
Attenuator (-hp- Model 4437A)  
600 ohm Resistive Load (-hp- Model 11095A)

**4-13. Step Accuracy.**

- a. Adjust the 239A controls for a frequency of 1 kHz.
- b. Connect the equipment as shown in Figure 4-1.
- c. Adjust the Attenuator controls for 60.0 dB of attenuation.
- d. Adjust the 239A LEVEL controls for a reading of 3.00 mV on the True RMS Voltmeter.
- e. Down-range the 239A LEVEL control to the next lower range.

**NOTE**

*When changing the LEVEL control, care must be taken to not disturb the setting of the LEVEL Vernier control.*

- f. Decrease the Attenuator setting by 10.0 dB.
- g. The True RMS Voltmeter must indicate between 2.91 and 3.09 mV.
- h. Repeat Steps d through g until each position of the 239A LEVEL control has been checked.
- i. Adjust the 239A controls for an output frequency of 100 kHz.
- j. Repeat Steps c through h.

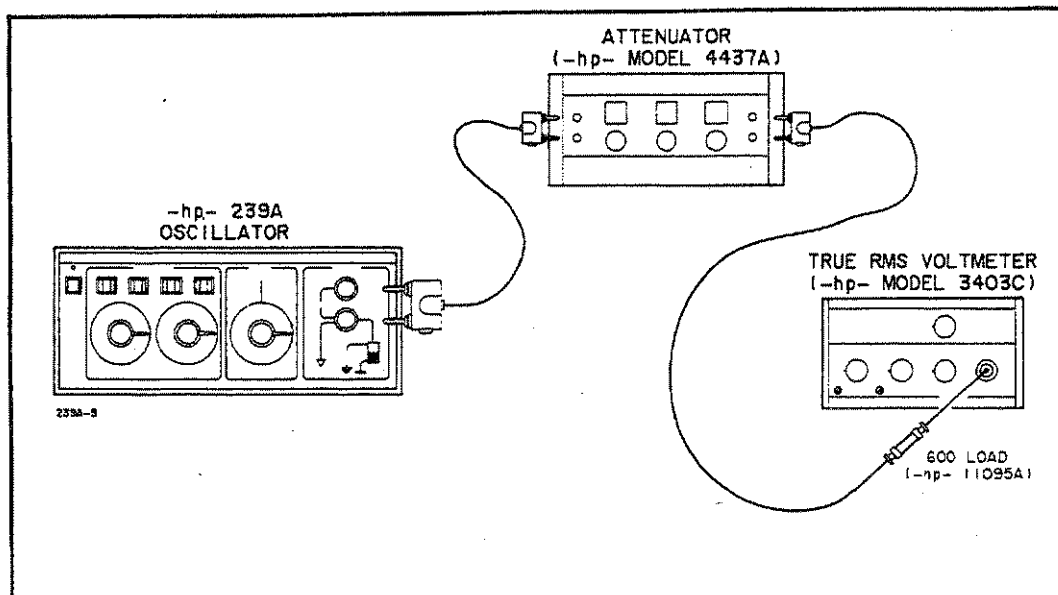

**Figure 4-1. Attenuator Accuracy Test.**

**4-14. Accumulative Error Test.**

- a. Adjust the 239A controls for an output frequency of 1 kHz.
- b. Set the Attenuator controls for 60.0 dB of attenuation.
- c. Connect the equipment as shown in Figure 4-1.
- d. Adjust the 239A controls for a 3.00 mV reading on the True RMS Voltmeter.
- e. Set the 239A LEVEL control to the 31.6 mV range.
- f. Adjust the Attenuator for 20 dB of attenuation. The True RMS Voltmeter reading must be between 2.67 and 3.37 mV.
- g. Set the 239A LEVEL control to the 10 mV range.
- h. Adjust the Attenuator for 10 dB of attenuation. The True RMS Voltmeter reading must be between 2.67 and 3.37 mV.
- i. Set the 239A LEVEL control to the 3.16 mV range.
- j. Adjust the Attenuator for 0 dB of attenuation. The True RMS Voltmeter reading must be between 2.67 and 3.37 mV.

**4-15. Frequency Accuracy Test.****Equipment Required:**

Frequency Counter (-hp- Model 5300A Mainframe, -hp- Model 5302A Frequency Module)

- a. Set the 239A controls for an output frequency of 10 Hz ( $1.0 \times 10$ , frequency vernier to the CAL position) and an output LEVEL of 3 volts.
- b. Adjust the Frequency counter to measure period.
- c. Connect a cable between the 239A OUTPUT terminals and the Frequency counter input connector. The counter indication should be within the limits listed in Table 4-2 for a frequency of 10 Hz.
- d. Verify the 239A frequency accuracy for each frequency listed in Table 4-2.

**4-16. Total Harmonic Distortion Test.****Equipment Required:**

Spectrum Analyzer (-hp- Model 3044A)  
Tunable Notch Filter (-hp- Model 339A)  
600 ohm Resistive Load (-hp- 11095A)

Table 4-2. Frequency Accuracy Test.

Frequency	239A Frequency Range	Test Limits
10 Hz	× 10	102.04 to 98.04 msec
100 Hz	× 100	10.204 to 9.804 msec
1 kHz 1.1 kHz 1.2 kHz 1.3 kHz 1.4 kHz 1.5 kHz 1.6 kHz 1.7 kHz 1.8 kHz 1.9 kHz 2.0 kHz 3.0 kHz 4.0 kHz 5.0 kHz 6.0 kHz 7.0 kHz 8.0 kHz 9.0 kHz 10.0 kHz	× 1K	1020.4 to 980.4 μsec 927.64 to 891.27 μsec 850.34 to 816.99 μsec 784.93 to 754.15 μsec 728.86 to 700.28 μsec 680.27 to 653.59 μsec 637.76 to 612.75 μsec 600.24 to 576.70 μsec 566.89 to 544.66 μsec 537.06 to 516.00 μsec 510.20 to 490.20 μsec 340.14 to 326.80 μsec 255.10 to 245.10 μsec 204.08 to 196.08 μsec 170.07 to 163.40 μsec 145.77 to 140.06 μsec 127.55 to 122.55 μsec 113.38 to 108.93 μsec 102.04 to 98.039 μsec
10 kHz 109 kHz	× 10K	102.04 to 98.039 μsec 9.3615 to 8.9944 μsec

**NOTE**

*If it is only necessary to determine whether the Model 239A meets or exceeds the Total Harmonic Distortion specifications listed in Table 1-1, the measurement can often be made using the Distortion Analyzer alone. Keep in mind, however, the measurement includes noise as well as Harmonic distortion. If satisfactory measurements cannot be obtained with the Distortion Analyzer alone or if accurate measurement of the 239A total harmonic distortion is required, the following procedure should be used.*

- a. Set the 239A controls for an output frequency of 10 Hz ( $1.0 \times 10$ , frequency vernier to the CAL position) at an output level of 3 volts.

- b. Connect the equipment as shown in Figure 4-2.
- c. Set the Spectrum Analyzer measurement reference to the level of the 239A fundamental frequency as follows:
  1. Set the Distortion Analyzer to the voltmeter function and adjust the input range control as necessary to obtain an on-scale meter reading as near full-scale as possible.
  2. Tune the Spectrum Analyzer to the exact frequency of the fundamental frequency (indicated by a maximum level reading on the Spectrum Analyzer).
  3. Use the level indicated as the measurement reference level.

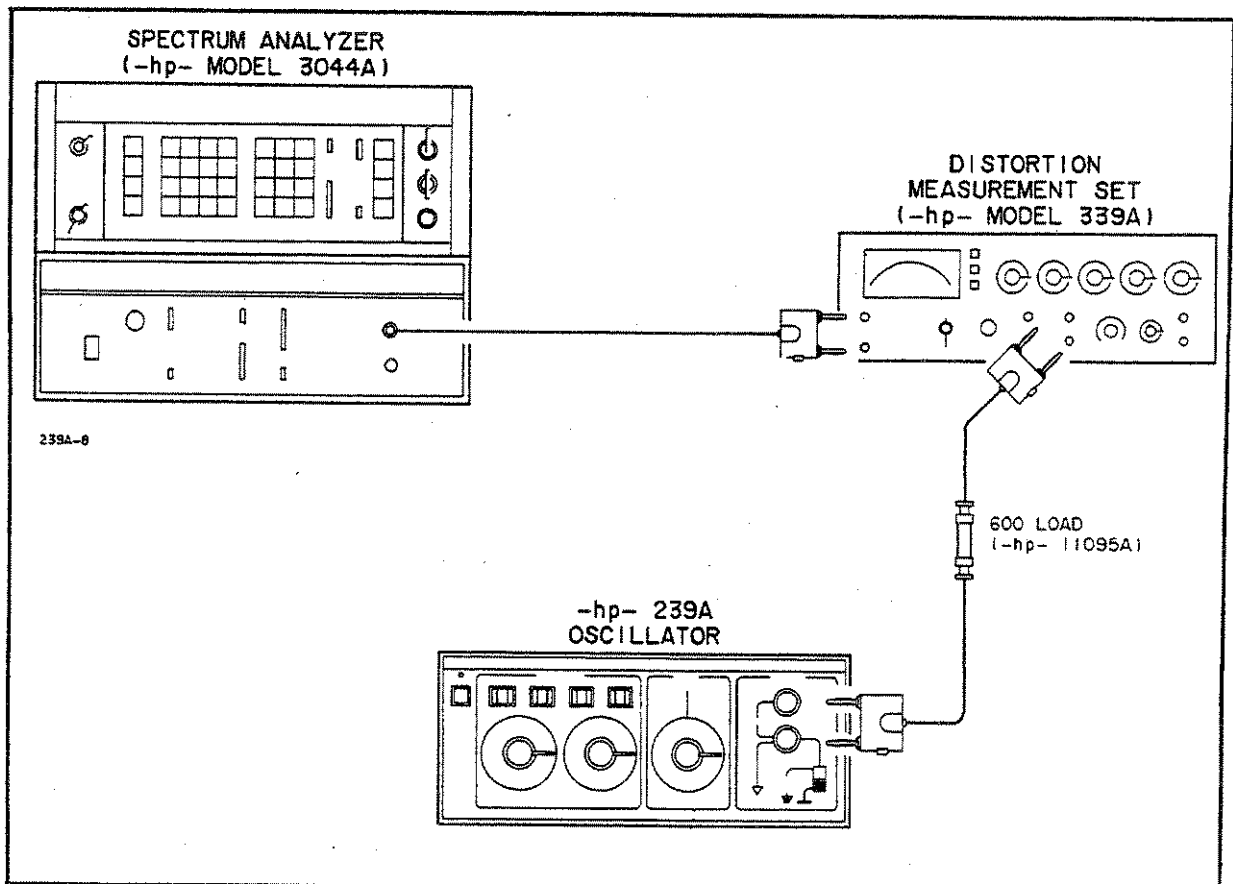

Figure 4-2. Total Harmonic Distortion Test.

d. Adjust the Distortion Analyzer controls as necessary to make a distortion measurement. (The purpose of this step is to null the fundamental frequency of the 239A output. This puts the distortion products within the dynamic range of the Spectrum Analyzer.)

e. Adjust the Spectrum Analyzer to measure the amplitude of the second harmonic frequency. The amplitude of the second harmonic, relative to the fundamental frequency, is determined by adding the Spectrum Analyzer reading and the distortion range setting of the Distortion Analyzer. (As an example—If the distortion range setting of the Distortion Analyzer is  $-80$  dB and the Spectrum Analyzer indicates  $-23$  dB the amplitude of the second harmonic is  $-103$  dB, relative to the fundamental.) Record the amplitude reading of the second harmonic.

f. Adjust the Spectrum Analyzer controls to measure the amplitude of the third harmonic. Determine the relative amplitude of the third harmonic by adding the Spectrum Analyzer indication and the distortion range setting of the Distortion Analyzer. Record the amplitude reading of the third harmonic.

g. Calculate the Total Harmonic Distortion using the graph shown in Figure 4-3. As an example—If the amplitude of the second harmonic is  $-110$  dB and the third harmonic amplitude is  $-114$  dB the dB difference between the two is  $-4$  dB. Locate this number on the horizontal axis of the graph. The  $-4$  line intersects the curve at approximately the  $+1.5$  level on the vertical axis. The total harmonic distortion is therefore the amplitude of the largest harmonic (second harmonic) plus the number determined on the vertical axis ( $-110$  dB  $+1.5$  dB =  $-108.5$  dB).

h. The 239A should meet the 10 Hz THD specifications listed in Table 4-3.

i. Repeat Steps c through g for each frequency listed in Table 4-3.

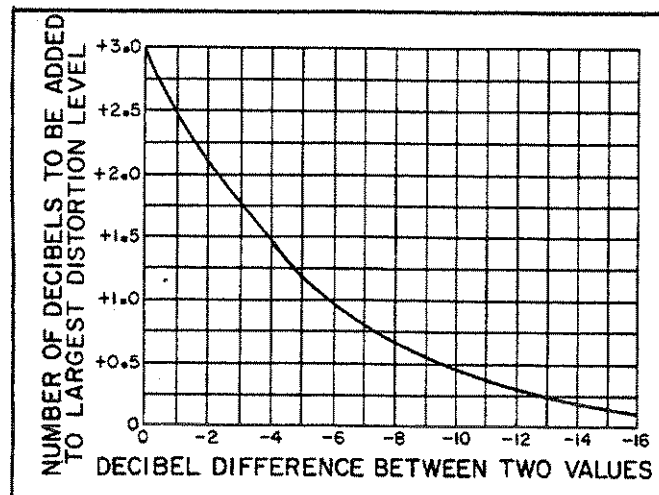

Figure 4-3. Logarithmic Addition of Harmonic Components.

**Table 4-3. Oscillator Total Harmonic Distortion Test.**

339A Frequency	THD Specification
10 Hz	> -95 dB
100 Hz	> -95 dB
1 kHz	> -95 dB
10 kHz	> -95 dB
20 kHz	> -95 dB
30 kHz	> -85 dB
50 kHz	> -80 dB
109 kHz	> -70 dB



## **WARNING**

*These servicing instructions are for use by trained service personnel only. To avoid electrical shock, do not perform any servicing other than that contained in the operating instructions unless you are qualified to do so.*

## SECTION V ADJUSTMENTS

### 5-1. INTRODUCTION.

5-2. This section contains complete adjustment procedures for the Model 239A Oscillator. After the instrument has been adjusted according to the procedures given in this section, it should meet the accuracy specified in Table 1-1.

### 5-3. EQUIPMENT REQUIRED.

5-4. The test equipment required to perform the adjustments is listed at the beginning of each adjustment procedure and in the Recommended Test Equipment Table in Section I. If the recommended equipment is not available, substitute equipment which meets the critical specifications listed in the table may be used.

### 5-5. ADJUSTMENT LOCATIONS.

5-6. The location of all adjustments is shown in Figure 5-1 at the back of this section. The function of each adjustment is listed in Table 5-2.

### 5-7. FACTORY SELECTED COMPONENTS.

5-8. Certain components in the Model 239A are individually selected to compensate for varying circuit parameters. These components are noted on the schematics and in the material list by an asterisk (\*). The value listed in the material list and on the schematic is the typical value of the selected component. The function of the factory selected components and their value ranges are listed in Table 5-1.

### 5-9. ADJUSTMENT PROCEDURES.

#### 5-10. Gain Adjustment.

Equipment Required: Digital Voltmeter (-hp- Model 3465A)

a. Set the 239A controls for an output frequency of 100 Hz ( $1.0 \times 100$ , vernier in the CAL position).

b. Set the DVM controls to measure DC volts (2 volt range). Connect the DVM's high input to TP5 and the low input to the GND test point.

c. Adjust R56 (GAIN ADJUST) for a DVM reading of  $-0.4 \text{ V dc} \pm 0.1 \text{ V dc}$ .

- d. Set the 239A to the  $\times 10$  range.
- e. The DVM reading should be more negative than  $-0.4$  V dc; if not, readjust R56 for  $-0.4$  V dc  $\pm 0.1$  V dc.

#### 5-11. Frequency Adjustment.

Equipment Required: Electronic Counter (-hp- Model 5300A Mainframe, Model 5302A Universal Counter Module)

- a. Set the 239A controls for an output frequency of 10 kHz ( $1.0 \times 10$  k, vernier in the CAL position) and an output level of 3 volts.
- b. Connect the 239A output to the counter input.
- c. Adjust C5 (10 kHz FREQUENCY ADJUST) for a counter indication of 10 kHz  $\pm 10$  Hz.
- d. Adjust 239A FREQUENCY controls for a frequency of 100 kHz ( $10.0 \times 10$  k).
- e. Verify that the counter indicates 100 kHz  $\pm 1$  kHz. If not, readjust C5 until both the 10 kHz and 100 kHz readings are within the specified limits.

#### 5-12. Output Adjustment.

Equipment Required: True RMS Voltmeter (-hp- Model 3403C)

- a. Set the 239A controls for an output frequency of 1 kHz ( $1.0 \times 1$  k, vernier in the CAL position) and an output level of 3.16 volts (LEVEL control to 3.16 V range and level vernier to the CAL position).
- b. Set the True RMS Voltmeter controls to measure ac volts. Connect the 239A output to the voltmeter input.
- c. Adjust R30 (OUTPUT LVL CAL) for a voltmeter indication of 3.16 volts rms.

## PERFORMANCE TEST RECORD

Hewlett-Packard Model 239A

Tests Performed By: \_\_\_\_\_

Oscillator

Date: \_\_\_\_\_

Serial No. \_\_\_\_\_

### Output Impedance Test:

With an unloaded output level of 6.00 V rms, the output level into a 600  $\Omega$  load = \_\_\_\_\_  
 (Test limits, 2.93 to 3.08 V rms).

### Output Level and Flatness Test:

Full output at 1 kHz into 600  $\Omega$  load = \_\_\_\_\_ (Test limits 3.09 to 3.23 V rms).

Output Level at: (referenced to 3.00 V at 1 kHz)	
10 Hz = _____	(2.93 to 3.07 V rms)
20 Hz = _____	(2.97 to 3.03 V rms)
20 kHz = _____	(2.97 to 3.03 V rms)
109 kHz = _____	(2.93 to 3.07 V rms)

### Attenuator Accuracy Test:

#### Step Accuracy

239A Output Level Setting	True RMS Meter Reading	Test Limits
1 V	_____	2.91 to 3.09 mV
.316 V	_____	
.1 V	_____	
3.16 mV	_____	
10 mV	_____	
3.16 mV	_____	

Accumulative Accuracy

239A Output Level Setting	True RMS Meter Reading	Test Limits
10 mV	_____	2.67 to 3.37 mV
3.16 mV	_____	

Frequency Accuracy Test:

239A Frequency	239A Frequency Range	Frequency Counter Indication (Period)	Test Limits
10 Hz	× 10		102.04 to 98.04 msec
100 Hz	× 100		10.204 to 9.804 msec
1.0 kHz	× 1k		1020.4 to 980.4 μsec
1.1 kHz			927.64 to 891.27 μsec
1.2 kHz			850.34 to 816.99 μsec
1.3 kHz			784.93 to 754.15 μsec
1.4 kHz			728.86 to 700.28 μsec
1.5 kHz			680.27 to 653.59 μsec
1.6 kHz			637.76 to 612.75 μsec
1.7 kHz			600.24 to 576.70 μsec
1.8 kHz			566.89 to 544.66 μsec
1.9 kHz			537.06 to 516.00 μsec
2.0 kHz			510.20 to 490.20 μsec
3.0 kHz			340.14 to 326.80 μsec
4.0 kHz			255.10 to 245.10 μsec
5.0 kHz			204.08 to 196.08 μsec
6.0 kHz			170.07 to 163.40 μsec
7.0 kHz			145.77 to 140.06 μsec
8.0 kHz			127.55 to 122.55 μsec
9.0 kHz		113.38 to 108.93 μsec	
10.0 kHz		102.04 to 98.039 μsec	
10 kHz	× 10k		102.04 to 98.039 μsec
109 kHz			9.3615 to 8.9944 μsec

**Total Harmonic Distortion Test:**

239A Output Frequency	Calculated THD	Test Limit
10 Hz		-95 dB
100 Hz		
1 kHz		
10 kHz		
20 kHz		
30 kHz		-85 dB
50 kHz		-80 dB
109 kHz		-70 dB

**Table 5-1. Factory Selected Components.**

Reference Designator	Range of Values	Description
C43	27 pF to 750 pF	Value selected for minimum second harmonic distortion at the output terminals for fundamental frequencies of 20 kHz and greater.
C45	0 to 22 pF	Used to adjust frequency at 100 kHz when the frequency adjustment (Paragraph 5-11) cannot be made. If C45 is necessary the frequency accuracy should be checked at 10 kHz intervals over the entire $\times 10$ k range.

**Table 5-2. Adjustable Components.**

Adjustment Name	Reference Designator	Adjustment Paragraph	Description
10 kHz Frequency Adjust	C5	5-11	Adjusts Oscillator frequency on the $\times 10$ K range.
Output Level Cal.	R30	5-12	Adjust the maximum output level of the oscillator.
Gain Adjust	R56	5-10	Adjusts the gain of the oscillator amplifier.

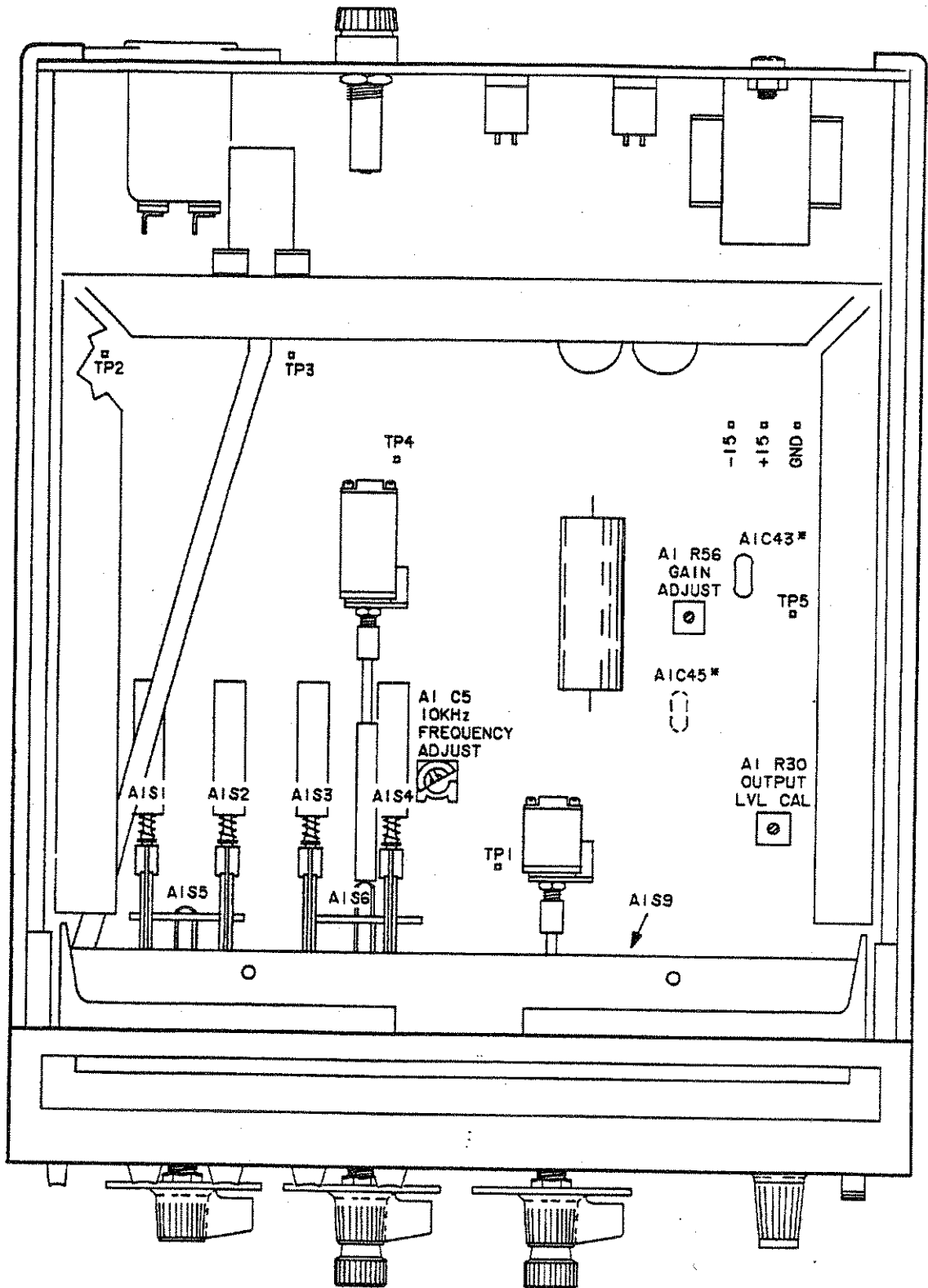

Figure 5-1. Adjustment and Test Point Locations  
5-3/5-



## SECTION VI

# REPLACEABLE PARTS

### 6-1. INTRODUCTION.

6-2. This section contains information for ordering replacement parts. Table 6-3 lists parts in alphabetic order of their reference designators and indicates the description, -hp- Part Number of each part, together with any applicable notes, and provides the following:

a. Total quantity used in the instrument (Qty column). The total quantity of a part is given the first time the part number appears.

b. Description of the part. (See abbreviations listed in Table 6-1.)

c. Typical manufacturer of the part in a five-digit code. (See Table 6-2 for list of manufacturers.)

d. Manufacturer's part number.

6-3. Miscellaneous parts are listed at the end of Table 6-3.

### 6-4. ORDERING INFORMATION.

6-5. To obtain replacement parts, address order or inquiry to your local Hewlett-Packard Field Office. (Field Office locations are listed at the back of the manual.) Identify parts by their Hewlett-Packard part numbers. Include instrument model and serial numbers.

### 6-6. NON-LISTED PARTS.

6-7. To obtain a part that is not listed, include:

- a. Instrument model number.
- b. Instrument serial number.
- c. Description of the part.
- d. Function and location of the part.

### 6-8. PARTS CHANGES.

6-9. Components which have been changed are so marked by one of three symbols; i.e.,  $\Delta$ ,  $\Delta$  with a letter subscript, e.g.,  $\Delta_a$ , or  $\Delta$  with a number subscript, e.g.,  $\Delta_{10}$ . A  $\Delta$  with no subscript indicates the component listed is the preferred replacement for an earlier component. A  $\Delta$  with a letter subscript indicates a change which is explained in a note at the bottom of the page. A  $\Delta$  with a number subscript indicates the related change is discussed in backdating (Section VII). The number of the subscript indicates the number of the change in backdating which should be referred to.

6-10. PROPRIETARY PARTS.

6-11. Items marked by a dagger (†) in the reference designator column are available only for repair and service of Hewlett-Packard instruments.

Table 6-1. Standard Abbreviations.

ABBREVIATIONS							
Ag	silver	Hz	hertz (cycle(s) per second)	NPO	negative positive zero (zero temperature coefficient)	sl	side
Al	aluminum	ID	inside diameter	ns	nanosecond(s) = 10 <sup>-9</sup> seconds	SPDT	single-pole double-throw
A	ampere(s)	impog	impregnated	nsr	not separately replaceable	SPST	single-pole single-throw
Au	gold	incd	incandescent	Ω	ohm(s)	Ta	tantalum
C	capacitor	ins	insulation(ed)	obd	order by description	TC	temperature coefficient
cer	ceramic	kΩ	kiloohm(s) = 10 <sup>3</sup> ohms	OD	outside diameter	TiO <sub>2</sub>	titanium dioxide
coef	coefficient	kHz	kilohertz = 10 <sup>3</sup> hertz	p	peak	tol	tolerance
com	common	L	inductor	pA	picoampere(s)	trim	trimmer
comp	composition	lin	linear taper	pc	printed circuit	TSTR	transistor
conn	connection	log	logarithmic taper	pf	picofarad(s) 10 <sup>-12</sup> farads	V	volt(s)
dep	deposited	mA	milliampere(s) = 10 <sup>-3</sup> amperes	piv	peak inverse voltage	vacw	alternating current working voltage
DPDT	double-pole double-throw	MHz	megahertz = 10 <sup>6</sup> hertz	p/o	part of	var	variable
DPST	double-pole single-throw	MΩ	megohm(s) = 10 <sup>6</sup> ohms	pos	position(s)	vdcw	direct current working voltage
elect	electrolytic	met film	metal film	pot	potentiometer	W	watt(s)
encap	encapsulated	mfr	manufacturer	pp	peak-to-peak	w/	with
F	farad(s)	ms	millisecond	ppm	parts per million	ww	working inverse voltage
FET	field effect transistor	mtg	mounting	prnc	precision (temperature coefficient, long term stability and/or tolerance)	w/o	without
fxd	fixed	mV	millivolt(s) = 10 <sup>-3</sup> volts	R	resistor	ww	wirewound
GaAs	gallium arsenide	μF	microfarad(s)	Rh	rhodium		
GHz	gigahertz = 10 <sup>9</sup> hertz	μs	microsecond(s)	rms	root-mean-square		
gd	guard(ed)	μV	microvolt(s) = 10 <sup>-6</sup> volts	rot	rotary		
Ga	germanium	mv	Mylar <sup>®</sup>	Se	selenium		
gnd	ground(ed)	nA	nanoampere(s) = 10 <sup>-9</sup> amperes	sect	section(s)		
H	henry(ies)	NC	normally closed	Si	silicon		
Hg	mercury	NO	normally open				

DECIMAL MULTIPLIERS					
Prefix	Symbols	Multiplier	Prefix	Symbols	Multiplier
tera	T	10 <sup>12</sup>	canti	c	10 <sup>-2</sup>
giga	G	10 <sup>9</sup>	milli	m	10 <sup>-3</sup>
mega	M or Meg	10 <sup>6</sup>	micro	μ	10 <sup>-6</sup>
kilo	K or k	10 <sup>3</sup>	nano	n	10 <sup>-9</sup>
hecto	h	10 <sup>2</sup>	pico	p	10 <sup>-12</sup>
deka	da	10	femto	f	10 <sup>-15</sup>
deci	d	10 <sup>-1</sup>	atto	a	10 <sup>-18</sup>

DESIGNATORS							
A	assembly	FL	filter	Q	transistor	TS	terminal strip
B	motor	HR	heater	QCR	transistor-diode	U	microcircuit
BT	battery	IC	integrated circuit	R	resistor	V	vacuum tube, neon bulb, photocell, etc.
C	capacitor	J	jack	RT	thermistor	W	wire
CR	diode	K	relay	S	switch	X	socket
DL	delay line	L	inductor	T	transformer	XDS	lampholder
DS	lamp	M	meter	TB	terminal board	XF	fuseholder
E	misc electronic part	MP	mechanical part	TC	thermocouple	Y	crystal
F	fuse	P	plug	TP	test point	Z	network

STD-8-2734

\* optimum value selected at factory, average value shown (part may be omitted)  
 \*\* no standard type number assigned selected or special type

® Dupont de Nemours

Table 6-2. Code List of Manufacturers.

Mfr. No.	Manufacturer Name	Address
01121	Allen-Bradley Co.	Milwaukee, WI 53204
01928	RCA Corp Solid State Div.	Somerville, NJ 08876
04713	Motorola Semiconductor Products	Phoenix, AZ 85062
17856	Siliconix Inc.	Santa Clara, CA 95054
24546	Corning Glass Works (Bradford)	Bradford, PA 16701
27014	National Semiconductor Corp.	Santa Clara, CA 95051
28480	Hewlett-Packard Co. Corporate Hq	Palo Alto, CA 94304
56289	Sprague Electric Co.	North Adams, MA 01247
72136	Electro Motive Corp Sub IEC	Willimantic, CT 06226
74970	Johnson E F Co.	Waseca, MN 56093
75915	Littelfuse Inc.	Des Plaines, IL 60016

Table 6-3. Replaceable Parts.

Reference Designation	HP Part Number	Qty	Description	Mfr Code	Mfr Part Number	
A1	00239-00501 00239-20501	7 3	1 1	PC ASSEMBLY, MOTHER PC BOARD, BLANK	2940U 2940U	00239-00501 00239-20501
A1C1	0100-0590	7	2	CAPACITOR-FXD .050UF +-1% 200VDC	2800U	0100-0590
A1C2	0100-0595	6	2	CAPACITOR-FXD 500PF +-1% 200VDC	2800U	0100-0595
A1C3	0100-0594	5	1	CAPACITOR-FXD 500PF +-1% 200VDC	2800U	0100-0594
A1C4	0100-0100	7	1	CAPACITOR-FXD 30PF +-5% 300VDC MICA	29136	0-415130J0300-V1CR
A1C5	0121-0107	4	1	CAPACITOR-V TYPH-A1K 2-10, 3PF 350V	74070	100-507-5
A1C6	0100-0001	5	1	CAPACITOR-FXD 5.0UF +-1% 200VDC	2800U	0100-0001
A1C7	0100-0000	4	1	CAPACITOR-FXD .50UF +-1% 200VDC	2800U	0100-0000
A1C8	0100-0590	7	2	CAPACITOR-FXD .050UF +-1% 200VDC	2800U	0100-0590
A1C9	0100-0595	6	2	CAPACITOR-FXD 500PF +-1% 200VDC	2800U	0100-0595
A1C10	0100-3022	8	13	CAPACITOR-FXD .1UF +-80-20% 100VDC CER	2800U	0100-3022
A1C11	0100-3022	8		CAPACITOR-FXD .1UF +-80-20% 100VDC CER	2800U	0100-3022
A1C12	0100-3022	8		CAPACITOR-FXD .1UF +-80-20% 100VDC CER	2800U	0100-3022
A1C13	0100-3022	8		CAPACITOR-FXD .1UF +-80-20% 100VDC CER	2800U	0100-3022
A1C14	0100-3022	8		CAPACITOR-FXD .1UF +-80-20% 100VDC CER	2800U	0100-3022
A1C15	0100-3022	8		CAPACITOR-FXD .1UF +-80-20% 100VDC CER	2800U	0100-3022
A1C16- A1C20				UNASSIGNED		
A1C21	0100-2300	3	2	CAPACITOR-FXD 27PF +-5% 300VDC MICA	2800U	0100-2300
A1C22	0100-2200	6	2	CAPACITOR-FXD 3PF +-0.25PF 500VDC CER	2800U	0100-2200
A1C23	0100-0302	7	1	CAPACITOR-FXD 510PF +-5% 300VDC MICA	2800U	0100-0302
A1C24	0100-0303	6	2	CAPACITOR-FXD 620PF +-5% 300VDC MICA	2800U	0100-0303
A1C25- A1C30				UNASSIGNED		
A1C31	0100-2300	3	2	CAPACITOR-FXD 27PF +-5% 300VDC MICA	2800U	0100-2300
A1C32	0100-2200	6	2	CAPACITOR-FXD 3PF +-0.25PF 500VDC CER	2800U	0100-2200
A1C33	0100-2201	9	1	CAPACITOR-FXD 15PF +-5% 500VDC CER +-3%	2800U	0100-2201
A1C34	0100-0303	6	2	CAPACITOR-FXD 620PF +-5% 300VDC MICA	2800U	0100-0303
A1C35	0100-2201	7	1	CAPACITOR-FXD 51PF +-5% 300VDC MICA	2800U	0100-2201
A1C36- A1C39				UNASSIGNED		
A1C40	0100-1735	2	1	CAPACITOR-FXD .22 UF+-10% 35VDC TA	04200	1500224X9035A2
A1C41	0100-0197	8	1	CAPACITOR-FXD 2.2UF+-10% 20VDC TA	50209	1500225X9020A2
A1C42	0100-2200	6	1	CAPACITOR-FXD 2200PF+-10% 10VDC TA	50209	1500227X9010S2
A1C43	0100-2204	8	1	CAPACITOR-FXD 100PF +-5% 300VDC MICA *FACTORY SELECTED PART REFER TO TABLE 5-1.	2800U	0100-2204
A1C44	0100-0100	9	1	CAPACITOR-FXD 80UF+-20% 6VDC TA NORMALLY NOT USED *FACTORY SELECTED PART	50209	1500000X0000S2
A1C45				UNASSIGNED		
A1C46	0100-3022	8		CAPACITOR-FXD .1UF +-80-20% 100VDC CER	2800U	0100-3022
A1C47				UNASSIGNED		
A1C55	0100-3022	8		CAPACITOR-FXD .1UF +-80-20% 100VDC CER	2800U	0100-3022
A1C56- A1C302				UNASSIGNED		
A1C303	0100-3022	8		CAPACITOR-FXD .1UF +-80-20% 100VDC CER	2800U	0100-3022
A1C304	0100-3022	8		CAPACITOR-FXD .1UF +-80-20% 100VDC CER	2800U	0100-3022
A1C305	0100-2035	3	2	CAPACITOR-FXD 1000UF+-50-10% 35VDC AL	2800U	0100-2035
A1C306	0100-2035	3	2	CAPACITOR-FXD 1000UF+-50-10% 35VDC AL	2800U	0100-2035
A1C307	0100-3022	8		CAPACITOR-FXD .1UF +-80-20% 100VDC CER	2800U	0100-3022
A1C308	0100-3022	8		CAPACITOR-FXD .1UF +-80-20% 100VDC CER	2800U	0100-3022
A1C309				UNASSIGNED		
A1C310	0100-0201	3	1	CAPACITOR-FXD 1UF+-10% 35VDC TA	50209	1500105X9035A2
A1C311	0100-2200	5	2	CAPACITOR-FXD 470UF+-10% 20VDC TA	50209	1500470X9020R2
A1C312	0100-2200	5	2	CAPACITOR-FXD 470UF+-10% 20VDC TA	50209	1500470X9020R2
A1C313	0100-3022	8		CAPACITOR-FXD .1UF +-80-20% 100VDC CER	2800U	0100-3022
A1C314	0100-3022	8		CAPACITOR-FXD .1UF +-80-20% 100VDC CER	2800U	0100-3022
A1C315				UNASSIGNED		
A1C316	0100-2020	2	1	CAPACITOR-FXD .03UF +-20% 500VDC CER	2800U	0100-2020
A1C41	1901-0040	1	4	DIODE-SWITCHING 30V 50MA 2MS DD-35	2800U	1901-0040
A1C42	1901-0040	1	4	DIODE-SWITCHING 30V 50MA 2MS DD-35	2800U	1901-0040
A1C43	1901-0514	8	1	DIODE-RECTIFY	2800U	1901-0514
A1C44- A1C420				UNASSIGNED		
A1C421	1901-0040	1	1	DIODE-SWITCHING 30V 50MA 2MS DD-35	2800U	1901-0040
A1C422	1901-0040	1	1	DIODE-SWITCHING 30V 50MA 2MS DD-35	2800U	1901-0040
A1C423- A1C429				UNASSIGNED		
A1C430	1901-0025	2	2	DIODE-GEN PRP 100V 700MA ND-7	2800U	1901-0025
A1C431	1902-0029	6	2	DIODE-ZNR 12.1V 5%	2800U	1902-0029
A1C432	1901-0025	2	2	DIODE-GEN PRP 100V 700MA ND-7	2800U	1901-0025
A1C433	1902-0029	6	2	DIODE-ZNR 12.1V 5%	2800U	1902-0029
A1C434- A1C420				UNASSIGNED		

See introduction to this section for ordering information

Table 6-3. Replaceable Parts (Cont'd).

Reference Designation	HP Part Number	Qty	Description	Mfr Code	Mfr Part Number	
A1CR300	1902-0096	7	1	DYODE-PK BR06 200V 2A	44715	404202
A1CR301				UNASSIGNED		
A1CR302	1902-0033	3	1	DYODE=2NR 1N5170B 50V 5X POW5M IR=500NA	04713	1N5170B
A1F1	2110-0304	0	1	FUSE .062A 125V FAST-BLG .281X.093	20480	2110-0304
A1J1	1251-3192	1	2	CONNECTOR 3-PIN M POST TYPE	20480	1251-3192
A1J2	1251-3018	4	1	CONNECTOR 2-PIN M POST TYPE	20480	1251-3018
A1J3	1251-3195	4	1	CONNECTOR 4-PIN M POST TYPE	20480	1251-3195
A1J4	1251-0513	4	1	CONNECTOR 3-PIN M POST TYPE	20480	1251-0513
A1J5				UNASSIGNED		
A1J6	1251-3192	1		CONNECTOR 3-PIN M POST TYPE	20480	1251-3192
A101	1455-0265	3	1	TRANSISTOR J-PEP NUCMAN D-MODE TO-18 SI	17850	VC2R
A1R1	0699-0025	0	2	RESISTOR 28.42K .25% .125W F TC00+-50	20480	0699-0025
A1R2	0699-0025	0		RESISTOR 28.42K .25% .125W F TC00+-50	20480	0699-0025
A1R3	0699-0026	1	2	RESISTOR 14.21K .25% .125W F TC00+-50	20480	0699-0026
A1R4	0699-0026	1		RESISTOR 14.21K .25% .125W F TC00+-50	20480	0699-0026
A1R5	0699-0027	2	2	RESISTOR 9.474K .25% .125W F TC00+-50	20480	0699-0027
A1R6	0699-0027	2		RESISTOR 9.474K .25% .125W F TC00+-50	20480	0699-0027
A1R7	0699-0028	3	2	RESISTOR 7.105K .25% .125W F TC00+-50	20480	0699-0028
A1R8	0699-0028	3		RESISTOR 7.105K .25% .125W F TC00+-50	20480	0699-0028
A1R9	0699-0040	9	4	RESISTOR 5.684K .25% .125W F TC00+-50	20480	0699-0040
A1R10	0699-0040	9		RESISTOR 5.684K .25% .125W F TC00+-50	20480	0699-0040
A1R11	0699-0040	9		RESISTOR 5.684K .25% .125W F TC00+-50	20480	0699-0040
A1R12	0699-0040	9		RESISTOR 5.684K .25% .125W F TC00+-50	20480	0699-0040
A1R13	0699-0035	2	2	RESISTOR 28.42K .25% .125W F TC00+-50	20480	0699-0035
A1R14	0699-0035	2		RESISTOR 28.42K .25% .125W F TC00+-50	20480	0699-0035
A1R15	0699-0036	3	2	RESISTOR 142.1K .25% .125W F TC00+-50	20480	0699-0036
A1R16	0699-0036	3		RESISTOR 142.1K .25% .125W F TC00+-50	20480	0699-0036
A1R17	0699-0031	0	2	RESISTOR 94.74K .25% .125W F TC00+-50	20480	0699-0031
A1R18	0699-0031	0		RESISTOR 94.74K .25% .125W F TC00+-50	20480	0699-0031
A1R19	0699-0032	9	2	RESISTOR 71.05K .25% .125W F TC00+-50	20480	0699-0032
A1R20	0699-0032	9		RESISTOR 71.05K .25% .125W F TC00+-50	20480	0699-0032
A1R21	0699-0033	0	2	RESISTOR 56.84K .25% .125W F TC00+-50	20480	0699-0033
A1R22	0699-0033	0		RESISTOR 56.84K .25% .125W F TC00+-50	20480	0699-0033
A1R23	0698-4530	8	2	RESISTOR 232K 1% .125W F TC00+-100	24546	C4-1/8-T0-2323-F
A1R24	0698-4530	8		RESISTOR 232K 1% .125W F TC00+-100	24546	C4-1/8-T0-2323-F
A1R25				UNASSIGNED		
A1R26				UNASSIGNED		
A1R27	0698-3918	0	1	RESISTOR 7.32K 1% .125W F TC00+-100	24546	C4-1/8-T0-7321-F
A1R28	0698-3492	9	1	RESISTOR 2.67K 1% .125W F TC00+-100	24546	C4-1/8-T0-2671-F
A1R29	0757-0401	0	4	RESISTOR 100 1% .125W F TC00+-100	24546	C4-1/8-T0-101-F
A1R30	2100-0567	0	2	RESISTOR=TRM 2K 10K C TOP=ADJ 1-TRM	20480	2100-0567
A1R31				UNASSIGNED		
A1R32	0757-0283	6	3	RESISTOR 2K 1% .125W F TC00+-100	24546	C4-1/8-T0-2001-F
A1R33	0698-1279	0	1	RESISTOR 6.99K 1% .125W F TC00+-100	24546	C4-1/8-T0-6991-F
A1R34	0757-0401	0		RESISTOR 100 1% .125W F TC00+-100	24546	C4-1/8-T0-101-F
A1R35				UNASSIGNED		
A1R36				UNASSIGNED		
A1R37	0757-0401	0		RESISTOR 100 1% .125W F TC00+-100	24546	C4-1/8-T0-101-F
A1R38	0757-0442	9	5	RESISTOR 10K 1% .125W F TC00+-100	24546	C4-1/8-T0-1002-F
A1R39	0757-0451	0	1	RESISTOR 24.3K 1% .125W F TC00+-100	24546	C4-1/8-T0-2432-F
A1R40	0698-3215	4	2	RESISTOR 499K 1% .125W F TC00+-100	20480	0698-3215
A1R41	0698-3215	4		RESISTOR 499K 1% .125W F TC00+-100	20480	0698-3215
A1R42				UNASSIGNED		
A1R43	0757-0465	6	3	RESISTOR 100K 1% .125W F TC00+-100	24546	C4-1/8-T0-1003-F
A1R44	0757-0442	9		RESISTOR 10K 1% .125W F TC00+-100	24546	C4-1/8-T0-1002-F
A1R45	0757-0442	9		RESISTOR 10K 1% .125W F TC00+-100	24546	C4-1/8-T0-1002-F
A1R46	0757-0280	6		RESISTOR 1K 1% .125W F TC00+-100	24546	C4-1/8-T0-1001-F
A1R47	0757-0283	3	2	RESISTOR 2K 1% .125W F TC00+-100	24546	C4-1/8-T0-2001-F
A1R48	0757-0442	9		RESISTOR 10K 1% .125W F TC00+-100	24546	C4-1/8-T0-1002-F
A1R49	0757-0280	3		RESISTOR 1K 1% .125W F TC00+-100	24546	C4-1/8-T0-1001-F
A1R50	0757-0442	9		RESISTOR 10K 1% .125W F TC00+-100	24546	C4-1/8-T0-1002-F
A1R51	0757-0280	3		RESISTOR 1K 1% .125W F TC00+-100	24546	C4-1/8-T0-1001-F
A1R52	0757-0283	6		RESISTOR 2K 1% .125W F TC00+-100	24546	C4-1/8-T0-2001-F
A1R53	0757-0283	6		RESISTOR 2K 1% .125W F TC00+-100	24546	C4-1/8-T0-2001-F
A1R54	0757-0401	0		RESISTOR 100 1% .125W F TC00+-100	24546	C4-1/8-T0-101-F
A1R55	0757-0407	6	1	RESISTOR 200 1% .125W F TC00+-100	24546	C4-1/8-T0-201-F
A1R56	2100-0567	0		RESISTOR=TRM 2K 10K C TOP=ADJ 1-TRM	20480	2100-0567
A1R57	0698-4630	5	1	RESISTOR 3.09K 1% .125W F TC00+-100	24546	C4-1/8-T0-3091-F
A1R58				UNASSIGNED		
A1R59				UNASSIGNED		
A1R60	0698-4870	9	2	RESISTOR 694 1% .5W F TC00+-100	20480	0698-4870
A1R61	0698-4892	5	1	RESISTOR 1.87K 1% .5W F TC00+-100	20480	0698-4892
A1R62	0698-3406	5	1	RESISTOR 1.33K 1% .5W F TC00+-100	20480	0698-3406
A1R63	0698-3479	2	5	RESISTOR 1.74K 1% .5W F TC00+-100	20480	0698-3479
A1R64	0698-4886	9	8	RESISTOR 1.18K 1% .5W F TC00+-100	20480	0698-4886

See introduction to this section for ordering information

Table 6-3. Replaceable Parts (Cont'd).

Reference Designation	HP Part Number	Qty	Description	Mfr Code	Mfr Part Number
A1R66	0698-3479	2	RESISTOR 1.74K 1% .5W F TCR0±100	28480	0698-3479
A1R69	0698-4868	9	RESISTOR 1.18K 1% .5W F TCR0±100	28480	0698-4868
A1R70	0698-3479	2	RESISTOR 1.74K 1% .5W F TCR0±100	28480	0698-3479
A1R71	0698-4868	9	RESISTOR 1.18K 1% .5W F TCR0±100	28480	0698-4868
A1R72	0698-3479	2	RESISTOR 1.74K 1% .5W F TCR0±100	28480	0698-3479
A1R73	0698-4868	9	RESISTOR 1.18K 1% .5W F TCR0±100	28480	0698-4868
A1R74	0698-3479	2	RESISTOR 1.74K 1% .5W F TCR0±100	28480	0698-3479
A1R75	0698-3478	1	RESISTOR 80A 1% .5W F TCR0±100	28480	0698-3478
A1R76	0698-4870	9	RESISTOR 80A 1% .5W F TCR0±100	28480	0698-4870
A1R77-					
A1R99			UNASSIGNED		
A1R100	0686-2025	7	1 RESISTOR 2K 5% .5W CC TCR0±047	01121	EB2025
A1R101-					
A1R299			UNASSIGNED		
A1R300	0683-0685	5	2 RESISTOR 0.8 5% .25W FC TCR=000/+500	01121	CR06C5
A1R301	0683-0685	5	RESISTOR 0.8 5% .25W FC TCR=000/+500	01121	CR06C5
A1R302	0757-0442	9	RESISTOR 10K 1% .125W F TCR0±100	24546	CR=1/8-T0=1002-F
A1R303	0757-0442	9	RESISTOR 10K 1% .125W F TCR0±100	24546	CR=1/8-T0=1002-F
A181			PART OF A1SA1		
A182			PART OF A1SA1		
A183			PART OF A1SA1		
A184			PART OF A1SA1		
A185	3100-3422	3	2 SWITCH=RTY, UNITS	28480	3100-3422
A186	3100-3422	3	SWITCH=RTY, TENTHS	28480	3100-3422
A187			UNASSIGNED		
A188			UNASSIGNED		
A189	3130-0551	0	1 SWITCH, ROTARY, LEVEL	28480	3130-0551
A1U1	1826-0487	0	2 IC OP AMP T0-99	28480	1826-0487
A1U2	1826-0139	9	1 IC 1458 OP AMP 8-DIP-P	01928	CA1458F
A1U3	1826-0487	0	IC OP AMP T0-99	28480	1826-0487
A1U4-					
A1U299			UNASSIGNED		
A1U300	1826-0457	0	1 IC V RGLTR T0-100	27014	LW325H
	1205-0050	7	1 HEAT SINK T0=5/T0=39-PKG	28480	1205-0050
			A1 MISCELLANEOUS		
	0380-0478	2	4 SPACER, BUSHING	28480	0380-0478
	00239-01201	8	2 MOUNTING BRACKET, POTENTIOMETER	28480	00239-01201
	2364-0113	2	1 SCREW-PACH #32 .25-14-LG PAN-ND-PDZ	00000	ORDER BY DESCRIPTION
	0380-0741	2	4 STANDOFF	00000	ORDER BY DESCRIPTION
A1SA1	3101-2321	1	1 SWITCH ASSEMBLY, MULTIPLIER	28480	3101-2321
A1SA2	3101-2126	4	SWITCH, PUSHBUTTON	28480	3101-2126

See introduction to this section for ordering information

Table 6-3. Replaceable Parts (Cont'd).

Reference Designation	HP Part Number	Qty	Description	Mfr Code	Mfr Part Number
CHASSIS PARTS					
C301	0100-0349	6	CAPACITOR-PDTHRU 1000PF 50V 500V CER	01121	FA29-102A
C302	0100-0345	6	CAPACITOR-PDTHRU 1000PF 50V 500V CER	01121	FB29-102A
CR100	1990-0465	5	LED-VISIBLE LUM-INTS-AQUUCO IP=30%L-MAX	26480	5062-098A
F1	2110-0027	0	FUSE .125A 250V NORM-BLO 1.25x.25 UL IEC (FOR 110V OPERATION)	26480	2110-0027
F1	2110-0011	0	FUSE .062A 250V NORM-BLO 1.25x.25 UL IEC (FOR 220V OPERATION)	26480	2110-0011
J84	1510-0090	2	BINDING POST ASSY SGL SGL-TUR JGK	26480	1510-0090
J88	1510-0093	3	BINDING POST ASSY SGL SGL-TUR DBP BLK	26480	1510-0093
	2950-0030	1	NUT-HEX-DBL-CHAM 3/8-12-TWO .098-14-TMK	00000	ORDER BY DESCRIPTION
	3050-0067	2	WASHER-FL NTLG 3/16 IN .375-IN-ID	26480	3050-0067
P1	1251-3201	3	CONNECTOR 3-PIN F POST TYPE	26480	1251-3201
P2	1251-3073	7	CONTACT-CONN U/W-POST-TYPE FEM CRP	26480	1251-3073
	1251-3613	1	CONNECTOR 2-PIN F POST TYPE	26480	1251-3613
P3A	1251-3073	7	CONTACT-CONN U/W-POST-TYPE FEM CRP	26480	1251-3073
P3B	1251-3613	1	CONNECTOR 2-PIN F POST TYPE	26480	1251-3613
	1251-3073	7	CONTACT-CONN U/W-POST-TYPE FEM CRP	26480	1251-3073
P4			PART OF CABLE ASSEMBLY, HI		
P5			UNASSIGNED		
P6	1251-3201	3	CONNECTOR 3-PIN F POST TYPE	26480	1251-3201
R25	1251-3073	7	CONTACT-CONN U/W POST-TYPE REM CRP	26480	1251-3073
R31	2100-3738	4	RESISTOR-VARIABLE TWO SECT 5M	26480	2100-3738
S7	2100-3738	3	RESISTOR-VARIABLE 10 K	26480	2100-3738
S8		2	PART OF R25		
S10	3101-1235	4	SWITCH=BL DPDT=NS STD 1.5A 125VAC	26480	3101-1235
S11	3101-2210	3	SWITCH=BL DPDT ALING 4A 250VAC	26480	3101-2210
S12	3101-2042	3	SWITCH=BL DPDT=NS STD 2A 250VAC SLDOR=LUC	26480	3101-2042
S13	3101-2042	3	SWITCH=BL DPDT=NS STD 2A 250VAC SLDOR=LUC	26480	3101-2042
T1	8100-4095	1	TRANSFORMER, POWER	26480	9100-4095
W1	00239-01003	0	CABLE ASSEMBLY, FREQUENCY VERNIER	26480	00239-01003
W1P4A	00140-44702	4	SPACERS, FOAM	26480	00140-44702
W1P4B	1251-0512	3	CONNECTOR 5-PIN F POST TYPE	26480	1251-0512
	1251-3073	1	CONTACT-CONN U/W-POST-TYPE FEM CRP	26480	1251-3073
XP1	2110-0470	3	FUSEHOLDER BODY EXTR PST; BAYONET; TWO	75915	345003-010
	2110-0465	0	FUSEHOLDER CAP EXTR PST; BAYONET; 20A	26480	2110-0465
	2950-0054	1	NUT-HEX-SBL-CHAM 1/2-20-TWO .125-IN-TMK	00000	ORDER BY DESCRIPTION

See introduction to this section for ordering information

Table 6-3. Replaceable Parts (Cont'd).

Reference Designation	HP Part Number	Qty	Description	Mfr Code	Mfr Part Number
KNOBS & MISCELLANEOUS PARTS					
	0370-0803	4	1	KNOB, PUSHBUTTON, SQUARE (LINE)	28480 0370-0803
	0370-0806	7	1	KNOB, BEZEL, SQUARE, PUSHBUTTON	28480 0370-0806
	08011-03701	3	1	EXTENDER, PUSHBUTTON SWITCH	28480 AR011-03701
	0370-2096	5	4	KNOB, PUSHBUTTON	28480 0370-2096
	0370-0914	0	4	BEZEL, PUSHBUTTON	28480 0370-0914
	5041-1473	3	4	EXTENDER PUSHBUTTON SWITCH	28480 5041-1473
	00339-04004	6	1	KNOB, FREQUENCY, UNITS	28480 00339-04004
	3030-0690	2	3	SCREW-SET 4-40 .13-IN-LG SMALL CUP-PT	00000 ORDER BY DESCRIPTION
	3130-0546	9	2	DETENT - 10 POSITION	28480 3130-0546
	2190-0016	3	3	WASHER-LX INTL T 3/8 IN .377-IN-ID	28480 2190-0016
	2950-0083	8	3	NUT-MEX-DBL-CHAN 3/8-32-TND .094-IN-TMX	00000 ORDER BY DESCRIPTION
	00339-04005	7	1	KNOB, FREQUENCY, TENTHS	28480 00339-04005
	3030-0690	2	1	SCREW-SET 4-40 .13-IN-LG SMALL CUP-PT	00000 ORDER BY DESCRIPTION
	3130-0546	9	2	DETENT - 10 POSITION	28480 3130-0546
	2190-0016	3	3	WASHER-LX INTL T 3/8 IN .377-IN-ID	28480 2190-0016
	2950-0083	8	3	NUT-MEX-DBL-CHAN 3/8-32-TND .094-IN-TMX	00000 ORDER BY DESCRIPTION
	0370-1125	7	2	KNOB, POINTER (VERNIER)	28480 0370-1125
	3030-0690	9	2	SCREW-SET 4-40 .13-IN-LG SMALL CUP-PT	00000 ORDER BY DESCRIPTION
	00239-03701	3	1	SHAFT, FREQUENCY VERNIER	28480 00239-03701
	1490-0881	7	2	COUPLER-RGD .375-LG BR8	28480 1490-0881
	3030-0690	5	2	SCREW-SET 4-40 .125-IN-LG SMALL CUP-PT	00000 ORDER BY DESCRIPTION
	00239-04001	2	1	KNOB, LEVEL	28480 00239-04001
	3030-0690	2	1	SCREW-SET 4-40 .13-IN-LG SMALL CUP-PT	00000 ORDER BY DESCRIPTION
	3130-0546	8	1	DETENT - 8 POSITION	28480 3130-0546
	2190-0016	3	1	WASHER-LX INTL T 3/8 IN .377-IN-ID	28480 2190-0016
	2950-0083	8	3	NUT-MEX-DBL-CHAN 3/8-32-TND .094-IN-TMX	00000 ORDER BY DESCRIPTION
	0370-1125	7	2	KNOB, POINTER (VERNIER)	28480 0370-1125
	3030-0690	4	1	SCREW-SET 4-40 .094-IN-LG SMALL CUP-PT	00000 ORDER BY DESCRIPTION
	7185-0011	2	1	BRASS-RND .125 DIA 2.75 IN LNG	28480 7185-0011
	1490-0881	7	2	COUPLER-RGD .375-LG BR8	28480 1490-0881
	3030-0690	5	1	SCREW-SET 4-40 .125-IN-LG SMALL CUP-PT	00000 ORDER BY DESCRIPTION
	1450-0404	4	1	LENS CAP CLR-TL .125-DIA	28480 1450-0404

See introduction to this section for ordering information

Table 6-3. Replaceable Parts (Cont'd).

Reference Designation	HP Part Number	Qty	Description	Mfr Code	Mfr Part Number
MECHANICAL PARTS					
MP1	00239-00201	6	FRONT PANEL	28480	00239-00201
MP2	00239-00202	7	FRONT SUB-PANEL	28480	00239-00202
MP3	00239-00601	0	FRONT SHIELD	28480	00239-00601
MP4	2360-0113	2	SCREW=MACH 6-32 .25-IN-LG PAN-ND-POZI	00000	ORDER BY DESCRIPTION
	5020-8813	8	FRONT FRAME	28480	5020-8813
	2360-0190	5	SCREW=MACH 6-32 .188-IN-LG 100 DEG	00000	ORDER BY DESCRIPTION
	2880-0126	7	SCREW=MACH 10-32 .25-IN-LG PAN-ND-POZI	00000	ORDER BY DESCRIPTION
MP5	5040-7208	5	COVER, TOP	28480	5040-7208
	00239-00602	1	TOP SHIELD	28480	00239-00602
MP6	2360-0190	5	SCREW=MACH 6-32 .188-IN-LG 100 DEG	00000	ORDER BY DESCRIPTION
	5040-7209	6	COVER, BOTTOM	28480	5040-7209
MP7	00239-00603	2	BOTTOM SHIELD	28480	00239-00603
MP8	2360-0190	5	SCREW=MACH 6-32 .188-IN-LG 100 DEG	00000	ORDER BY DESCRIPTION
	5040-8210	1	COVER, SIDE	28480	5040-8210
MP9	2360-0197	2	SCREW=MACH 6-32 .375-IN-LG PAN-ND-POZI	00000	ORDER BY DESCRIPTION
	2510-0199	3	SCREW=MACH 8-32 .25-IN-LG RD-ND-POZI	28480	2510-0199
MP10	00239-00605	4	SIDE SHIELD	28480	00239-00605
	2360-0113	2	SCREW=MACH 6-32 .25-IN-LG PAN-ND-POZI	00000	ORDER BY DESCRIPTION
MP11	00239-00203	8	REAR PANEL	28480	00239-00203
MP12	00239-00604	3	REAR SHIELD	28480	00239-00604
	2360-0113	2	SCREW=MACH 6-32 .25-IN-LG PAN-ND-POZI	00000	ORDER BY DESCRIPTION
MP13	5040-7201	6	FOOT (STANDARD)	28480	5040-7201
MP14	1460-1345	5	TILT STAND 88Y	28480	1460-1345
MP15	5001-0436	7	TRIM, SIDE	28480	5001-0436
MP16	5040-7203	0	TRIM, TOP 1/2	28480	5040-7203

See introduction to this section for ordering information



## **SECTION VII MANUAL CHANGES**

### **7-1. INTRODUCTION.**

7-2. This section of the manual normally contains backdating information necessary to adapt this manual to older instruments. Since no instrument modifications have been performed at the time this manual was printed, the manual applies directly to all instruments and no backdating material is required.

## SECTION VIII SERVICE

### 8-1. INTRODUCTION.

8-2. This section contains theory of operation, troubleshooting information, safety considerations, and general service information for the Model 239A Oscillator.

### 8-3. SAFETY CONSIDERATIONS.

8-4. Although this instrument has been designed in accordance with international safety standards, this manual contains information, cautions, and warnings which must be followed to ensure safe operation and to maintain the instrument in safe operating condition. Service and adjustments should be performed by qualified service personnel only.

8-5. Any adjustment, maintenance, or repair of the opened instrument while any power or voltage is applied should be avoided as much as possible, and when inevitable, should be carried out only by a skilled person who is aware of the hazard involved.

#### WARNING

*Any interruption of the protective grounding conductor (inside or outside the instrument) or disconnection of the protective earth terminal is likely to make the instrument dangerous. Intentional interruption of the protective grounding conductor is strictly prohibited.*

8-6. It is possible for capacitors inside the instrument to still be charged even if the instrument has been disconnected from its power source.

8-7. Be certain that only fuses with the required current rating and of the specified type (normal blow, time delay, etc.) are used for replacement. The use of repaired fuses and the short-circuiting of fuse holders must be avoided.

#### WARNING

*The service information presented in this manual is normally used with the protective covers removed and power applied to the instrument. Energy available at many points may, if contacted, result in personal injury.*

### 8-8. RECOMMENDED TEST EQUIPMENT.

8-9. Test equipment required to maintain the Model 239A Oscillator is listed in Table 1-3. Equipment other than that listed may be used as long as the critical specifications are met.

## THEORY OF OPERATION

### 8-10. GENERAL DESCRIPTION.

8-11. The Model 239A is an ultra-low distortion oscillator which provides a sinusoidal signal ranging from 10 Hz to 110 kHz at signal levels from less than 1 mV rms to 3.16 V rms into a 600 ohm impedance. Figure 8-1 shows a simplified block diagram of the Model 239A.

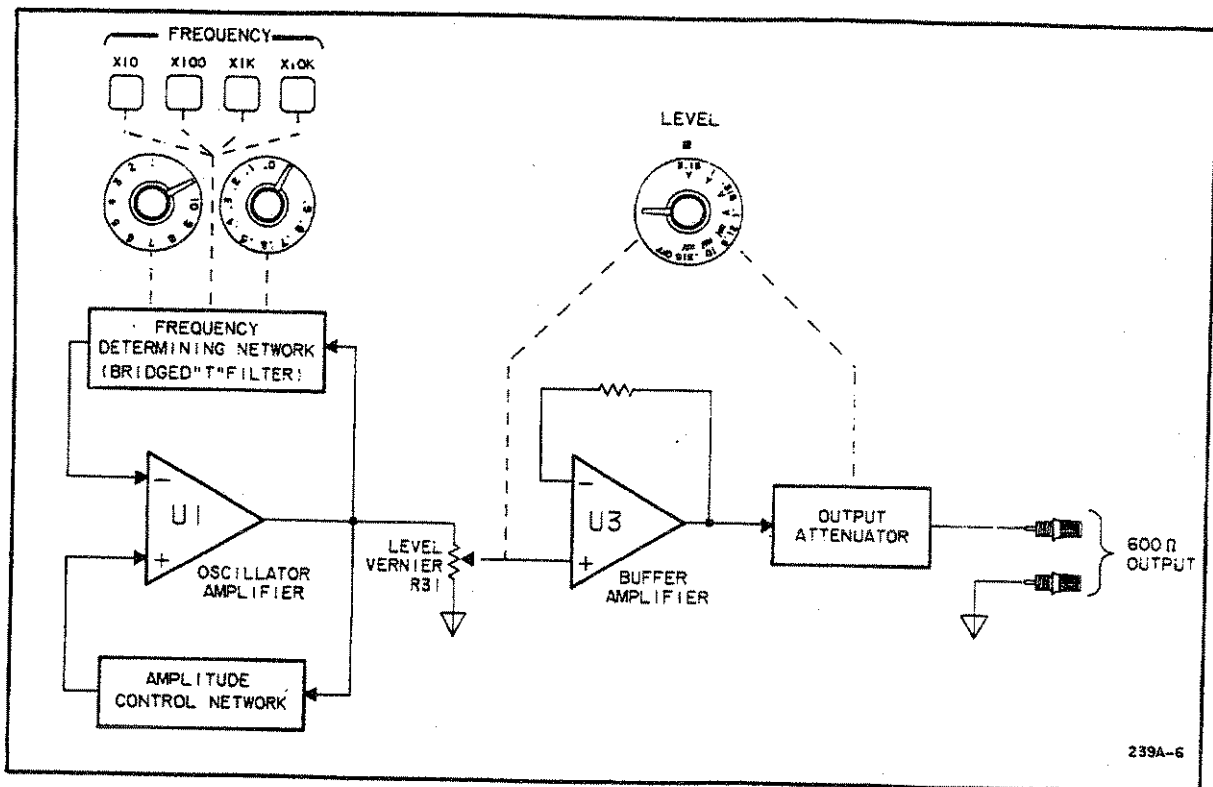

Figure 8-1. Model 239A Simplified Block Diagram.

8-12. Operating frequency of the oscillator is determined by a bridged "T" filter located in the negative feedback path of oscillator amplifier U1. Frequency is selected in four decade ranges with two digit resolution. A frequency vernier permits selection of frequencies between settings of the tenths frequency control for continuous frequency coverage from 10 Hz to 110 kHz.

8-13. Output level of the oscillator amplifier is maintained by an amplitude control circuit located in the positive feedback path of amplifier U1. The control circuit samples the positive peaks of the oscillator output and adjusts the gain of U1 as necessary to maintain a constant level.

8-14. Buffer amplifier U3 is a unity gain amplifier which isolates the oscillator circuitry from the output. The input level to U3 is varied from approximately 2 V rms to 6 V rms by LEVEL vernier R31. The output of U3 is applied to the output attenuator. The attenuator is a resistive divider which attenuates the output signal in 10 dBV steps. The maximum output level is 3.16 V rms into a 600 ohm load.

8-15. CIRCUIT DESCRIPTIONS.

8-16. Frequency Generation.

8-17. Figure 8-2 shows a simplified schematic diagram of the oscillator circuitry used in the Model 239A. The operating frequency of the oscillator is determined by the "bridge T" filter located in the negative feedback path of amplifier U1. At resonant frequency, the negative feedback signal at the inverting input of U1 is minimum and equal to  $V_o/51$ . The four decade frequency ranges ( $\times 10$ ,  $\times 100$ ,  $\times 1k$ ,  $\times 10k$ ) are determined by the values of  $C_A$  and  $C_B$ , while particular frequencies within each range are determined by the selection of resistors  $R_A$  and  $R_B$ .

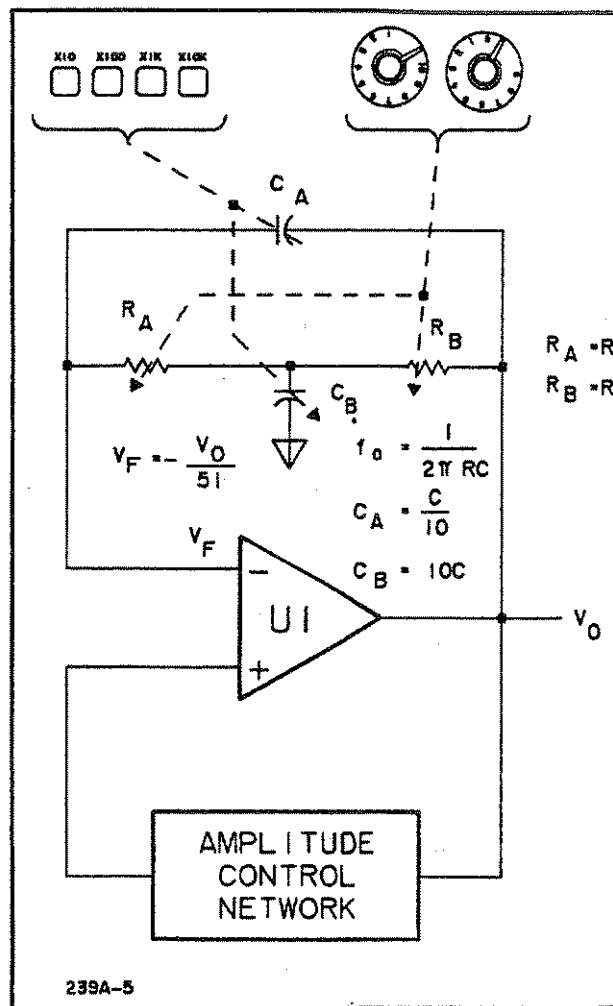
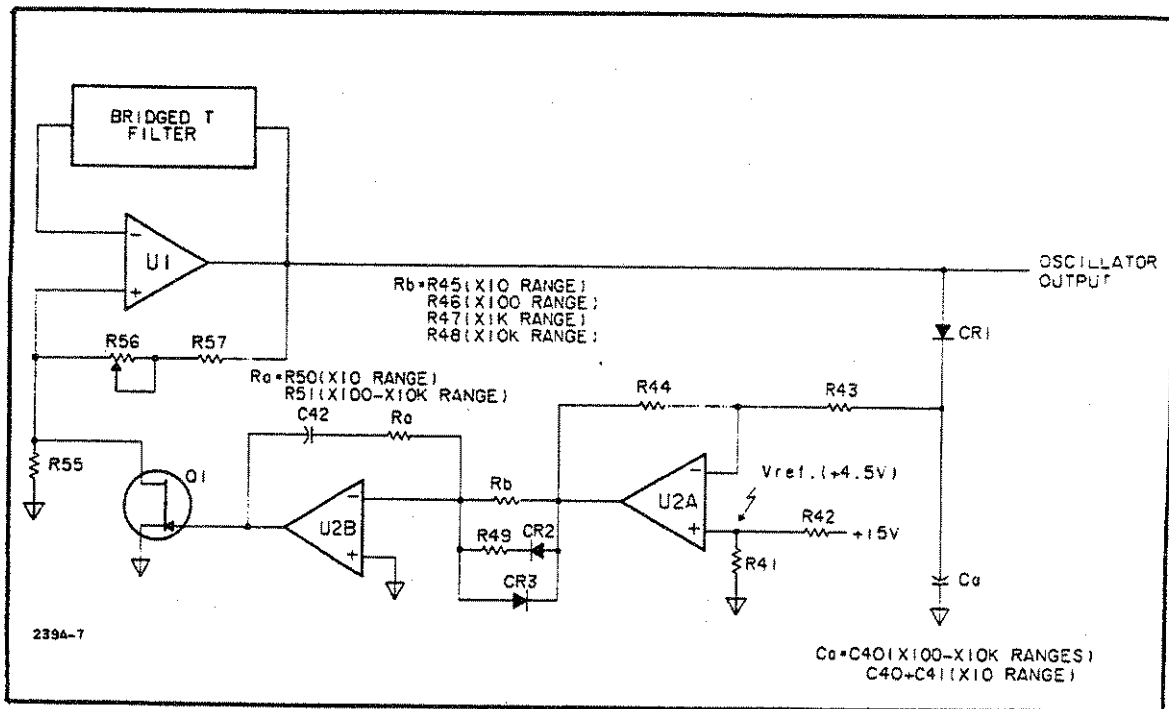

Figure 8-2. Simplified Oscillator Circuitry.

**8-18. Amplitude Control.**

8-19. The purpose of the amplitude control circuitry is to monitor the oscillator output level and derive an error signal to control the gain of amplifier U1. The basic oscillator amplitude is determined by resistors R55, R56 and R57 located in the positive feedback circuit of amplifier U1 and is regulated by the amplitude control circuit (see Figure 8-3).



**Figure 8-3. Simplified Amplitude Control Circuit.**

The oscillator output is sampled during the positive peaks by the peak detector circuit consisting of CR1 and Ca. A dc level equal to the peak value of the oscillator signal is stored on capacitor Ca and is compared to a reference voltage by difference amplifier U2A. The output of U2A represents the amplitude error of the oscillator output. Under normal conditions, the error signal is small (less than 300 mV) and is applied to integrator U2B through resistor Rb. Integrator U2B acts as a low-pass filter to reduce ripple due to the peak detector circuit. Resistor Rb determines the integrator charge current and is unique to each frequency range selected. The integrator drives control FET Q1 which acts as a variable resistor in parallel with feedback resistor R55 to change the gain of oscillator amplifier U1. Diodes CR2 and CR3 provide a fast response path when large amplitude errors occur. In this case, the amplitude error causes the output of difference amplifier U2A to exceed the conduction voltage of CR2 (output too low) or CR3 (output too high) which increases the integrator charge current.

**8-20. Output Buffer and Attenuator.**













8-21. (Refer to Figure 8-5). The oscillator signal is applied to the output buffer amplifier (U3) through the LEVEL VERNIER control. The level vernier varies the output level of the buffer amplifier from approximately 2 V rms to 6 V rms. The buffer amplifier output is divided by the output attenuator in 10 dB V steps from 3.16 V rms to 3.16 mV rms maximum output into a 600 ohm load. The attenuator also includes an OFF position which disables the oscillator output and terminates the OUTPUT terminals with a 600 ohm resistive load. The combination of output attenuator and level vernier permits the selection of output levels from 1 mV rms to 3.16 V rms into 600 ohms (2 mV to 6.32 V open circuit).

8-22. A zener diode protection circuit (CR30-CR33) protects the oscillator circuitry from the accidental application of voltage to the oscillator OUTPUT terminals.

**TROUBLESHOOTING**

8-23. Troubleshooting information for the Model 239A consists of waveforms, voltage levels and notes included as part of the schematic diagrams. Due to the circuit simplicity of the 239A, no special troubleshooting procedures are included.

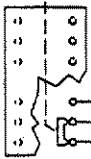
**SCHEMATIC DIAGRAM NOTES**

1. Partial component reference designations are shown. For complete reference designations, prefix with assembly designation. Example: R1 mounted on circuit assembly A1 becomes A1R1.
2. Unless otherwise noted, all resistance values are in ohms, all capacitance values are in microfarads.
3.  Denotes Earth Ground
4.  Denotes Chassis Ground
5.  Denotes Circuit Ground
6.  Denotes Assembly Borderline
7.  Denotes Main Signal Path
8.  Denotes Feedback Path
9.  Denotes Mechanical Connection
10.  Denotes Screwdriver Adjustment
11.  Denotes Troubleshooting Information  
Located on apron page of respective schematic
12. \* Denotes Factory Selected Component  
Average Value shown on schematic
13.  Indicates wire colors. Color code same as resistors. For example, 947 indicates white base, yellow wide stripe, and violet narrow stripe
14.  Feedthrough capacitor
15.  Multi-section pushbutton or slide switch. Appropriate section shown for circuit illustration.
16.  N-Channel J-FET. Gate drawn to note Source Connection.
17.  Indicates numbered Test Point

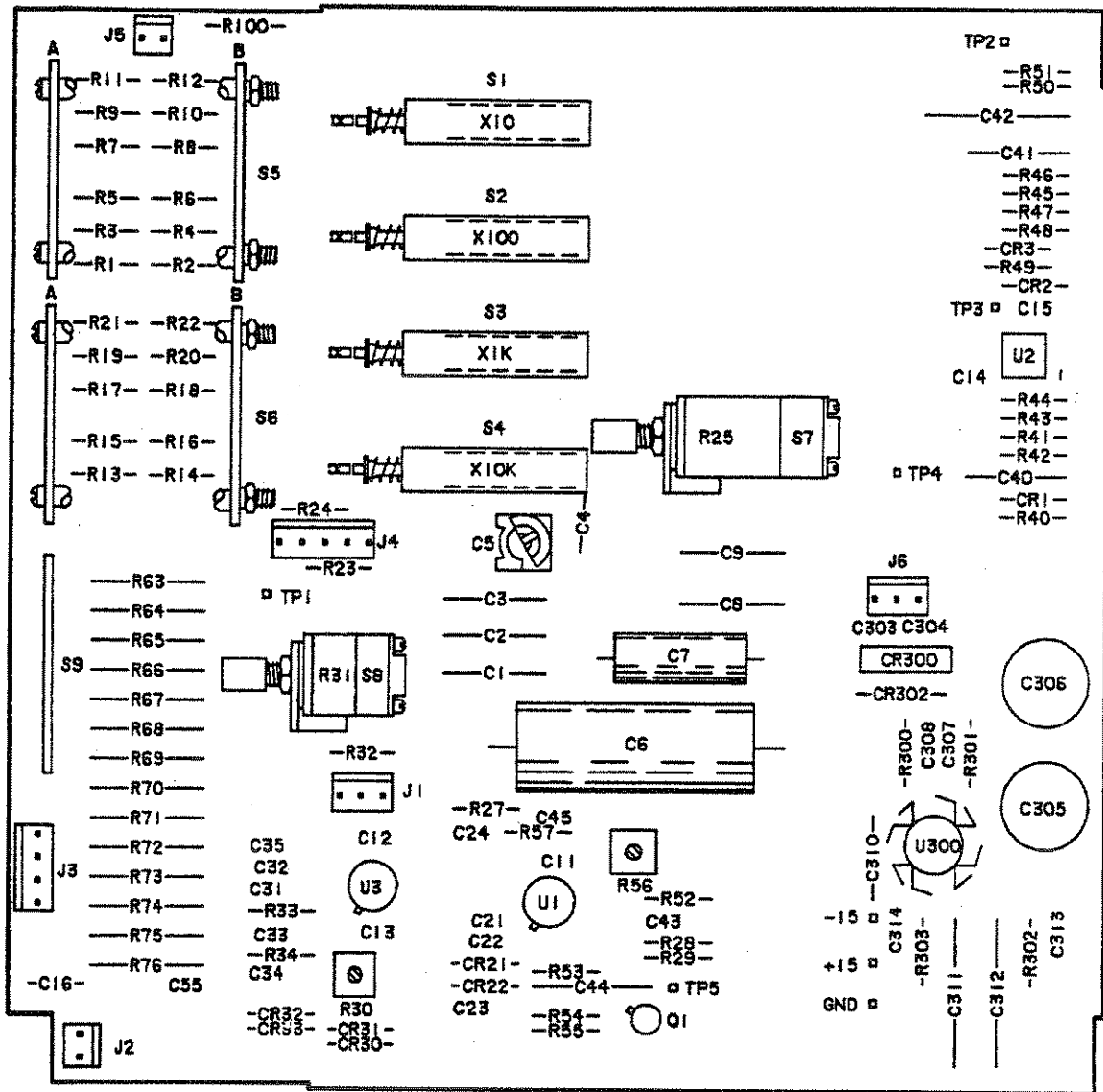

AI  
00239-66501  
REV. A





PRO A1 OUTPUT AND POWER SUPPLY CIRCUIT (00239-665011)

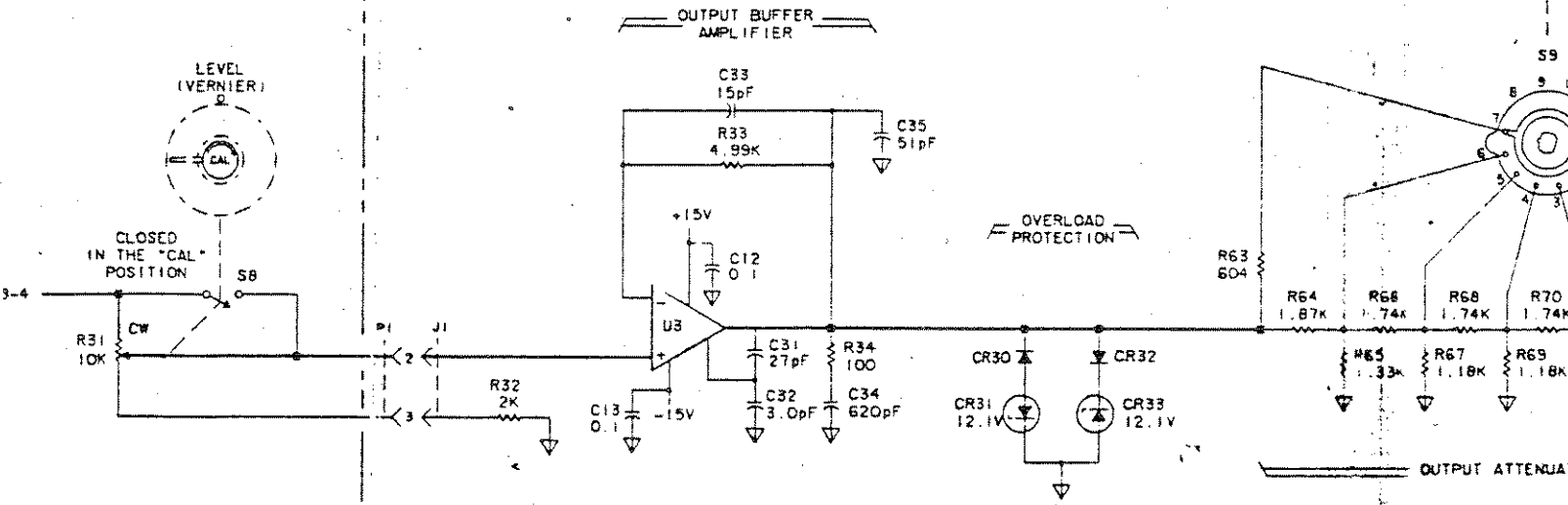

POWER SUPPLY

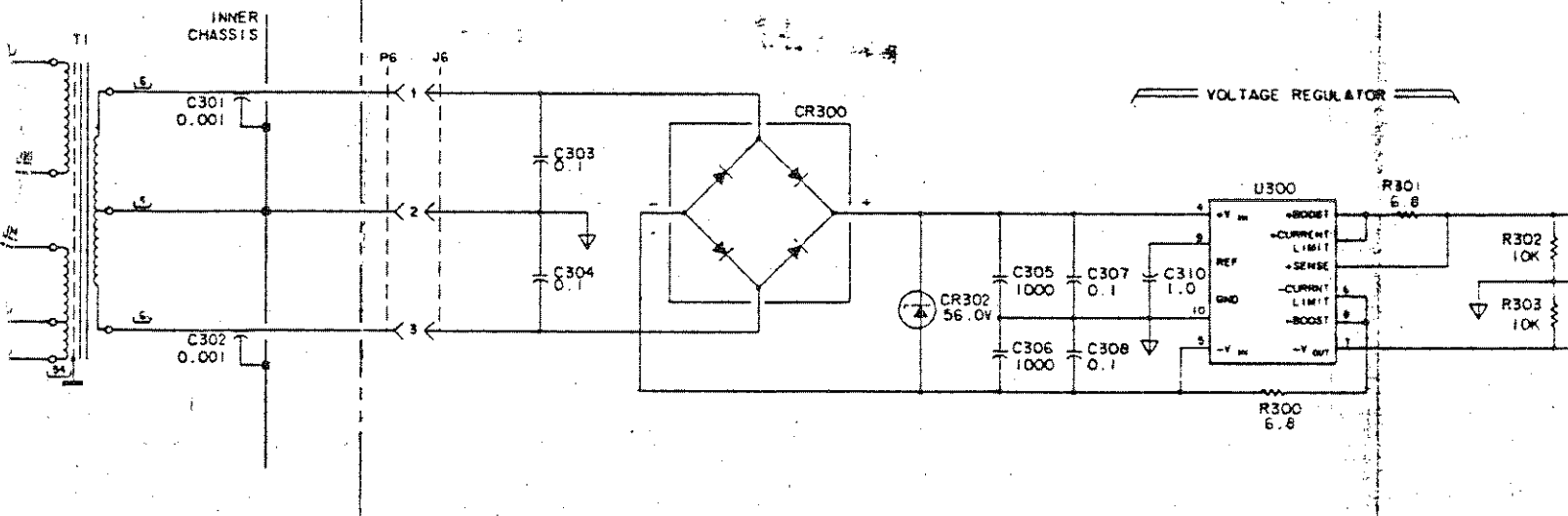

## Free Manuals Download Website

<http://myh66.com>

<http://usermanuals.us>

<http://www.somanuals.com>

<http://www.4manuals.cc>

<http://www.manual-lib.com>

<http://www.404manual.com>

<http://www.luxmanual.com>

<http://aubethermostatmanual.com>

Golf course search by state

<http://golfingnear.com>

Email search by domain

<http://emailbydomain.com>

Auto manuals search

<http://auto.somanuals.com>

TV manuals search

<http://tv.somanuals.com>