

HEWLETT  PACKARD

OPERATING AND SERVICE MANUAL

8505A
NETWORK ANALYZER
500 kHz to 1.3 GHz

SERIAL NUMBERS

This manual applies directly to HP Model 8505A Network Analyzers with serial number prefix 1930A. For instruments with serial number lower than 1930A, refer to the Manual Changes section of each chapter.

Copyright ©

HEWLETT-PACKARD COMPANY

1976

1400 FOUNTAIN GROVE PARKWAY, SANTA ROSA, CALIFORNIA 95404 U.S.A.

MANUAL PART NO. 08505-90072

Microfiche Part No. 08505-90073

Printed: AUGUST 1979

CERTIFICATION

Hewlett-Packard Company certifies that this product met its published specifications at the time of shipment from the factory. Hewlett-Packard further certifies that its calibration measurements are traceable to the United States National Bureau of Standards, to the extent allowed by the Bureau's calibration facility, and to the calibration facilities of other International Standards Organization members.

WARRANTY

This Hewlett-Packard instrument product is warranted against defects in material and workmanship for a period of one year from date of shipment. During the warranty period, Hewlett-Packard Company will, at its option, either repair or replace products which prove to be defective.

For warranty service or repair, this product must be returned to a service facility designated by HP. Buyer shall prepay shipping charges to HP and HP shall pay shipping charges to return the product to Buyer. However, Buyer shall pay all shipping charges, duties, and taxes for products returned to HP from another country.

HP warrants that its software and firmware designated by HP for use with an instrument will execute its programming instructions when properly installed on that instrument. HP does not warrant that the operation of the instrument, or software, or firmware will be uninterrupted or error free.

LIMITATION OF WARRANTY

The foregoing warranty shall not apply to defects resulting from improper or inadequate maintenance by Buyer, Buyer-supplied software or interfacing, unauthorized modification or misuse, operation outside of the environmental specifications for the product, or improper site preparation or maintenance.

NO OTHER WARRANTY IS EXPRESSED OR IMPLIED. HP SPECIFICALLY DISCLAIMS THE IMPLIED WARRANTIES OF MERCHANTABILITY AND FITNESS FOR A PARTICULAR PURPOSE.

EXCLUSIVE REMEDIES

THE REMEDIES PROVIDED HEREIN ARE BUYER'S SOLE AND EXCLUSIVE REMEDIES. HP SHALL NOT BE LIABLE FOR ANY DIRECT, INDIRECT, SPECIAL, INCIDENTAL, OR CONSEQUENTIAL DAMAGES, WHETHER BASED ON CONTRACT, TORT, OR ANY OTHER LEGAL THEORY.

ASSISTANCE

Product maintenance agreements and other customer assistance agreements are available for Hewlett-Packard products.

For any assistance, contact your nearest Hewlett-Packard Sales and Service Office. Addresses are provided at the back of this manual.

MODEL 8505A NETWORK ANALYZER
(Shown with Option 907, Front Handles)

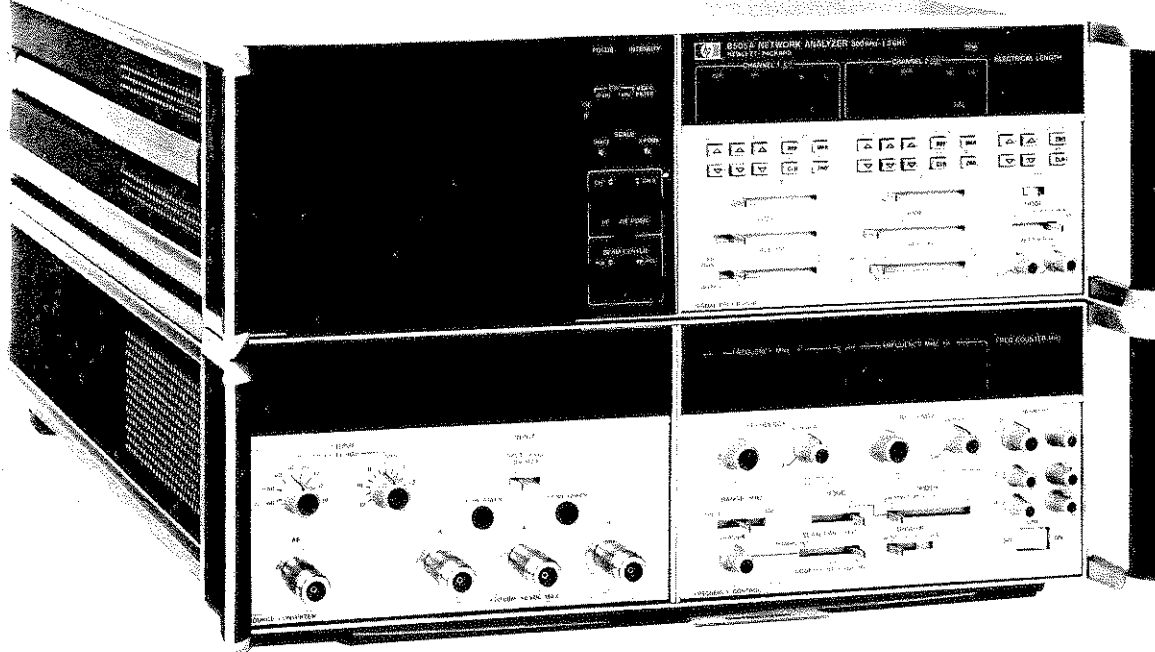

INTERCONNECT CABLE
(08505-60231)



NOTE

The following accessories supplied with the 8505A are not shown:

1. Smith and Log Chart CRT Overlays
2. AC Power Cable
3. PC Board Extenders (4) (See Accessories Supplied, Paragraph A1-40)

Figure A1-1. Model 8505A Network Analyzer

CHAPTER A MODEL 8505A NETWORK ANALYZER

SECTION I GENERAL INFORMATION

A1-1. INTRODUCTION

A1-2. The Model 8505A Network Analyzer comprises three functionally separate but physically integrated major assemblies: RF Source/Converter Assembly A1, Frequency Control Assembly A2, and Signal Processor Assembly A3. (A1, A2, and A3 are reference designators used to identify these assemblies throughout the manual.) The building-block approach used in construction of the 8505A is also used in the arrangement of the manual. Chapter A is divided into six sections containing information pertaining to the entire 8505A. This includes specifications, operating instructions, performance tests, adjustments, and sufficient theory and troubleshooting data to enable you to isolate a malfunction to a particular one of the three major assemblies.

A1-3. Chapters B, C, and D each cover one major assembly: Chapter B, the RF Source/Converter Assembly A1; Chapter C, the Frequency Control Assembly A2; and Chapter D, the Signal Processor Assembly A3. Each of these three chapters is divided into three sections containing general information about the assembly, a complete parts list for the assembly, the assembly theory of operation and schematic diagrams, and sufficient data for isolation of a failure within the assembly to the malfunctioning stage or component.

A1-4. DESCRIPTION

A1-5. The 8505A Network Analyzer measures network performance in the frequency range of 500 kHz to 1300 MHz. Three test input ports, A, B, and R, each provide 100 dB of dynamic range. The three test inputs are electrically identical, with R used as the reference for ratio measurements. A front-panel adjustable "line stretcher," with an associated readout in meters and centimeters, enables the electrical length of the R

input to be changed to match the electrical length of the test input. This feature is used to compensate for differences in test cable lengths, and to measure the electrical length of a network under test.

A1-6. Any one of the three test inputs, or the ratio of A/R or B/R, can be selected for presentation on one or both of two identical but independent display channels: CHANNEL 1 and CHANNEL 2. These two channels each display signal magnitude, phase, deviation from linear phase, and group delay of the under-test device's transmission or reflection characteristics. A selector switch enables all of these characteristics except group delay to be displayed in either rectangular or polar coordinates. Group delay is displayed in rectangular coordinates only. Digital readouts of the displayed characteristics are also provided on the 8505A.

A1-7. The 8505A's internal signal source provides seven selectable test signal modes: logarithmic full-range sweep, linear full-range sweep, linear expanded sweep (selected start/stop end points) No. 1, linear expanded sweep No. 2, linear expanded sweeps No. 1 and No. 2 alternately displayed on display channels 1 and 2 respectively, CW $\pm\Delta F$, and CW. Logarithmic full-range and linear full-range swept signals are provided in three selectable ranges: 500 kHz to 13 MHz, 500 kHz to 130 MHz, and 500 kHz to 1300 MHz.

A1-8. The Hewlett-Packard Interface Bus (HP-IB) allows both the Frequency Control and the Signal Processor of the 8505A to either receive instructions from or send data to a remote controller. The Learn Mode of the HP-IB enables the controller to store or "learn" the state of the 8505A manually-set front-panel controls so it can recall this information as needed.

A1-9. The three major assemblies (A1, A2, and A3) of the 8505A are contained in two chassis units, stacked one on top of the other and mechanically locked together. The lower unit contains the RF Source/Converter Assembly (A1) and the Frequency Control Assembly (A2). The top unit contains the Signal Processor Assembly (A3) and its associated CRT display. Each unit has its own ac power input receptacle and dc power supplies.

A1-10. INSTRUMENTS COVERED BY THE MANUAL

A1-11. Attached to the upper and lower units of the instrument are two identical serial number plates, both inscribed with the same serial number. As shown in Figure A1-2, the serial number is in two parts. The first four digits and the letter are the serial number prefix; the last five digits are the suffix. The prefix is the same for all identical instruments; it changes only when a change is made to the instrument. The suffix, however, is assigned sequentially and is different for each instrument. The contents of this manual apply to instruments with the serial number prefix(es) listed under SERIAL NUMBERS on the title page.

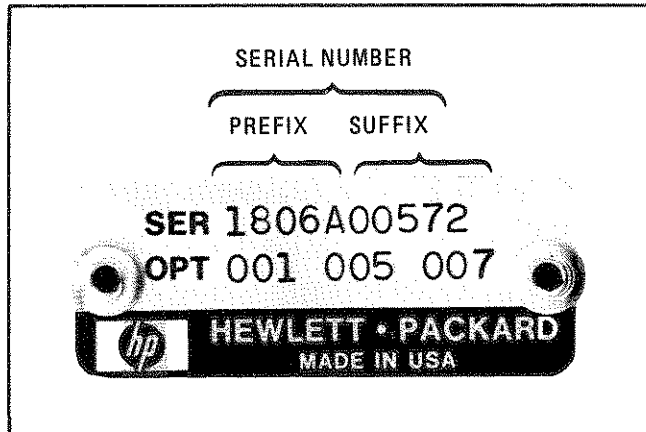

Figure A1-2. Serial Number Plate

A-12. Occasionally the manual will be accompanied by a yellow Manual Changes supplement. The Manual Changes supplement contains changes that have not yet been incorporated in the manual. A box in the upper right corner of the Manual Changes supplement identifies the affected manual by part number and print date. The supplement also identifies the serial numbers or serial number prefixes of instruments affected by it.

A1-2

A1-13. The Manual Changes supplement (when there is one) is available for updating manuals already shipped from the factory. To obtain the latest Manual Changes supplement, contact your nearest Hewlett-Packard office.

A1-14. SAFETY CONSIDERATIONS

A1-15. General

A1-16. This is a Safety Class I instrument. This instrument has been designed and tested according to International Safety Requirements for Electronic Measuring Apparatus.

A1-17. Safety Symbols



Instruction manual symbol: the apparatus will be marked with this symbol when it is necessary for the user to refer to the instruction manual in order to protect the apparatus against damage.



Indicates dangerous voltages.



Earth terminal (sometimes used in manual to indicate circuit connected to grounded chassis).

WARNING

The **WARNING** sign denotes a hazard. It calls attention to a procedure, practice, or the like, which, if not correctly performed or adhered to, could result in injury or loss of life. Do not proceed beyond a **WARNING** sign until the indicated conditions are fully understood and met.

CAUTION

The **CAUTION** sign denotes a hazard. It calls attention to an operating procedure, practice, or the like, which, if not correctly performed or adhered to, could result in damage to or destruction of part or all of the equipment. Do not proceed beyond a **CAUTION** sign until the indicated conditions are fully understood and met.

A1-18. Operation**CAUTION**

BEFORE APPLYING POWER make sure the instrument's TWO ac inputs are set for the available ac line voltage, that the correct fuses are installed, and that all normal safety precautions have been taken.

A1-19. Service

A1-20. Although the instrument has been designed in accordance with international safety standards, the information, cautions, and warnings in this manual must be followed to ensure safe operation and to keep the instrument safe. **SERVICE AND ADJUSTMENTS SHOULD BE PERFORMED ONLY BY QUALIFIED SERVICE PERSONNEL.**

A1-21. Adjustment or repair of the opened instrument with the ac power connected should be avoided as much as possible and, when unavoidable, should be performed only by a skilled person who knows the hazard involved.

A1-22. Capacitors inside the instrument may still be charged even though the instrument has been disconnected from its source of supply.

A1-23. Make sure only fuses of the required current rating and type (normal blow, time delay, etc.) are used for replacement. Fuse requirements are indicated on the instrument's rear panels. Do not use repaired fuses or short-circuit fuse holders.

A1-24. Whenever it is likely that the protection has been impaired, make the instrument inoperative and secure it against any unintended operation.

WARNING

If this instrument is to be energized through an auto-transformer (for voltage reduction), make sure the common terminal is connected to the earthed pole of the power source.

BEFORE SWITCHING ON THE INSTRUMENT, the protective earth ter-

minals of the instrument must be connected to the protective conductor of the (mains) power cord. The mains plug shall only be inserted in a socket outlet provided with protective earth contact. The protection action must not be negated by using an extension cord (power cable) without a protective grounding conductor. Grounding one conductor of a two-conductor outlet is not sufficient protection.

Any interruption of the protective (grounding) conductor, inside or outside the instrument, or disconnection of the protective earth terminal is likely to make this instrument dangerous. Intentional interruption of the earth ground is prohibited. Whenever it is likely that the protection has been impaired, the instrument must be secured against any unintended operation.

Servicing this instrument often requires that you work with the instrument's protective covers removed and with ac power connected. Be very careful; the energy at many points in the instrument may, if contacted, cause personal injury.

WARNING

At the top left rear of the Signal Processor Assembly A3, under the top cover, there is a two-position NORM/BY-PASS switch. When this switch is set to NORM, the front-panel LINE ON/OFF switch controls the primary power into the entire 8505A. When it is set to BY-PASS, however, only the lower unit (Source/Converter and Frequency Control Assemblies) is affected by operation of the LINE switch, the Processor Assembly will have power applied to it as long as the line cord (power cable) is connected to an ac source regardless of the position of the LINE switch. **DO NOT** assume there are no dangerous voltages present in the Signal Processor Assembly until you have checked the position of the NORM/BY-PASS switch.

A1-25. SPECIFICATIONS

A1-26. In order to provide the maximum amount of information about the usefulness and flexibility of the 8505A, both the performance specifications and the supplemental characteristics are listed in Tables A1-1 and A1-2. **Specifications** describe the instrument's warranted performance over the temperature range of 20° to 30°C. **Supplemental Characteristics** are intended to provide information useful in applying the instrument by giving typical but non-warranted performance parameters.

A1-27. OPTIONAL 8505A EQUIPMENT**A1-28. Option 005 Phase Lock**

A1-29. Option 005 provides the capability for phase-locking the HP 8505A to an external stable signal source such as the HP 8660A/C Synthesized Signal Generator or HP 8640A/B Signal Generator. When phase-locked, the residual FM of the system approaches that of the external signal source. This system is useful in making very narrow band measurements. See Chapter E for further information.

A-30. Option 007 Labeling Interface

A1-31. Option 007 provides the capability to obtain data from the 8505A to 8501A. Data obtained from the 8505A includes front-panel control settings, frequency, and Channel 1 and 2 marker measurement information. The 8501A processes this data and displays it on the 8505A CRT as labels and graphics. See Chapter F for further information.

A1-32. Option 907 Front Handles Kit

A1-33. Option 907 consists of four front handles, two for each 8505A chassis unit, and the necessary hardware for attaching the handles. The kit part number is HP 5061-0089. See Figure A2-2.

A1-34. Option 908 Rack Flange Kit

A1-35. Option 908 contains the flanges and hardware required to mount the 8505A in an equipment rack with 482.6 mm (19 inches) horizontal

spacing. The kit part number is HP 5061-0077. See Figure A2-2.

A1-36. Option 909 Rack Flange/Front Handle Kit

A1-37. Option 909 consists of one Option 907 Front Handle Kit and one Option 908 Rack Flange Kit. (See above.) The kit part number is HP 5061-0083. See Figure A2-2.

A1-38. Option 910 Additional 8505A Manual

A1-39. Option 910 provides an additional 8505A Operating and Service Manual.

A1-40. ACCESSORIES SUPPLIED

A1-41. Accessories supplied with 8505A are:

Table of Accessories

Accessory	HP Part Number
Interconnect Cable	08505-60231
HP-IB Cable (0.5 meter)	10631D
HP-IB Cable (2 meter)	10631B
*One Y-Type AC Power Cable	8120-2231 or
Two AC Power Cables	8120-1351 or
Two AC Power Cables	8120-1369 or
Two AC Power Cables	8120-1689 or
Two AC Power Cables	8120-0698
One Set Smith and Log Chart CRT Overlays	08505-60154
One 8505A Operating Instructions Sheet	08505-90074
One 12-Pin (Dual 6-Pin) Extender Board	08505-60109
Two 30-Pin (Dual 15-Pin) Extender Board	08505-60041
One 36-Pin (Dual 18-Pin) Extender Board	08505-60042
One 50-Pin (Dual 25-Pin) Extender Board	08505-60108
*Power cable supplied depends on configuration of ac power receptacle at user's location. Y-type cable connects to both top and bottom units of 8505A.	

Table A1-1. 8505A Network Analyzer Performance Specifications (1 of 3)

SOURCE			
FREQUENCY CHARACTERISTICS			
<p>Frequency Range: 500 kHz to 1.3 GHz in three ranges; 500 kHz to 13 MHz, 500 kHz to 130 MHz and 500 kHz to 1.3 GHz.</p> <p>Swept Frequency Accuracy: ±1% of range for linear sweep.</p> <p>CW Frequency Accuracy: ±2 counts ±time-base accuracy.</p> <p>Frequency Stability: better than ±0.01% of reading ±0.01% of frequency range over 10 minutes after warm up.</p>			
FREQUENCY COUNTER CHARACTERISTICS			
<p>Frequency counter measurements are made at any one of five continuously variable marker positions without interrupting the swept RF signal.</p> <p>Accuracy: Counter: ±2 counts ±time-base accuracy. Marker Frequency: ±0.002% of scan width ±counter accuracy. Time Base Accuracy: ±5 ppm ±1 ppm/°C ±3 ppm/90 days</p>			
OUTPUT CHARACTERISTICS			
<p>Power: Range: +10 dBm to -72 dBm.</p> <p>Accuracy: Attenuator: ±1.5 dB over 70 dB range. Vernier: ±1 dB Levelling: ±0.5 dB from 500 kHz to 1.3 GHz.</p> <p>Impedance: 50Ω; ≥16 dB return loss at -10 dBm output level (<1.38 SWR).</p> <p>Spectral Purity: Residual FM:</p>			
Frequency Range (MHz)	0.5 to 13	0.5 to 130	0.5 to 1300
Residual FM (Hz rms)	20 Hz	200 Hz	2 kHz
Measurement Bandwidth	20 Hz - 1 kHz	20 Hz - 1 kHz	20 Hz - 10 kHz
<p>Harmonics: >25 dB below main signal at +10 dBm output level. Typically >40 dB below main signal at -12 dB setting of vernier.</p> <p>Sub-harmonics and Spurious Signals: Below -50 dBm at +10 dBm output level.</p>			
RECEIVER			
FREQUENCY RANGE			
500 kHz to 1.3 GHz.			
INPUT CHARACTERISTICS			
<p>Input Channels: Three channels (R, A, and B) with 100 dB dynamic range.</p> <p>Maximum Input Level (Selectable): -10 dBm or -30 dBm input level.</p> <p>Noise (10 kHz BW): -110 dBm from 10 to 1300 MHz; -100 dBm from 2 to 10 MHz; -95 dBm from 0.5 to 2 MHz. Typically, -120 dBm using the -30 dBm input level position and 1 kHz BW.</p> <p>Impedance: 50Ω; ≥20 dB return loss (<1.22 SWR). Typically >26 dB return loss (<1.11 SWR).</p>			
MAGNITUDE CHARACTERISTICS			
Frequency Response:			
Absolute (A, B, R): ±1.5 dB.			
Ratio (A/R, B/R): ±0.3 dB from 0.5 MHz to 1.3 GHz.			
Dynamic Accuracy:			
<p>± 0.01 dB/dB from -20 to -40 dBm. ± 0.2 dB from -10 to -50 dBm. ± 0.5 dB from -50 to -70 dBm. ± 1.0 dB from -70 to -90 dBm. ± 2.0 dB from -90 to -100 dBm. ± 4.0 dB from -100 to -110 dBm.</p>			

Table A1-1. 8505A Network Analyzer Performance Specifications (2 of 3)

Crosstalk Error Limits: (>100 dB isolation between inputs.)

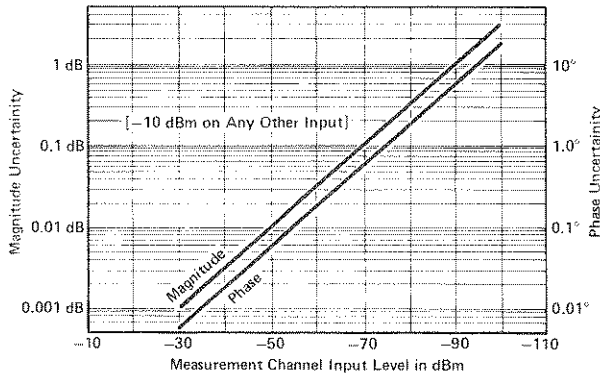

Reference Offset:
 Range: ± 199.9 dB.
 Accuracy: ± 0.03 dB ± 0.003 dB/dB of offset.

Resolution:
 Marker Measurement: 0.01 dB over any <10 dB range; 0.1 dB for ≥ 10 dB range.

CRT Display: 0.1 dB to 20 dB/division in 1, 2, 5 sequence.

Crosstalk: See amplitude crosstalk specifications.

Reference Offset:
 Range: ± 1700 degrees.
 Accuracy: $\pm 0.3^\circ \pm 0.5\%$ of offset.

Resolution:
 Marker Measurement: 0.1° over $<100^\circ$ range and 1° for $\geq 100^\circ$ range.

CRT Display: 1° to 180° per division in 8 steps.

POLAR CHARACTERISTICS

Frequency Response, Dynamic Response, Reference Offset and Marker Measurement specifications are the same as magnitude and phase characteristics.

CRT Display Accuracy: Actual value is within less than a 3 mm circle of the displayed value.

Tracking Between dB Offset Controls and Polar Full switch positions: ≤ 0.2 dB.

CRT Display Resolution: Magnitude graticules at 20% of full scale spacing; phase graticules at 10° increments around unit circle.

PHASE CHARACTERISTICS

Frequency Response: $\pm 3^\circ$ from 500 kHz to 750 MHz. $\pm 5^\circ$ from 750 MHz to 1.3 GHz.

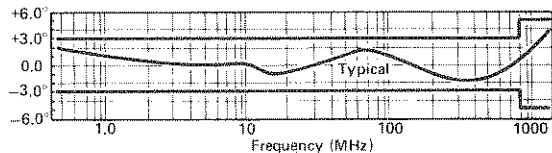

Range: $\pm 180^\circ$.
Accuracy: $\pm 0.01^\circ/\text{degree}$ for $\pm 170^\circ$
 $\pm 0.01^\circ/\text{degree} \pm 0.5^\circ$ for $\pm 180^\circ$

Dynamic Accuracy (in 10 kHz Bandwidth):
 $\pm 0.02^\circ/\text{dB}$ from -20 to -40 dBm.
 $\pm 0.5^\circ$ from -10 to -50 dBm.
 $\pm 1^\circ$ from -50 to -70 dBm.
 $\pm 3^\circ$ from -70 to -90 dBm.

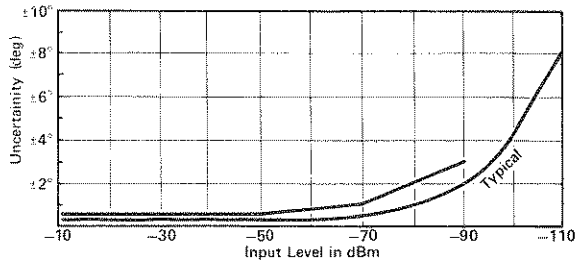

DELAY CHARACTERISTICS

Frequency Response: ± 1 ns from 500 kHz to 1.3 GHz

Delay Accuracy³: $\pm 3\%$ of reading ± 3 units.
 (Units = 1 nsec for 0.5 to 1300 MHz range, 10 nsec for 0.5 to 130 MHz range, and 100 nsec for 0.5 to 13 MHz range.)

Range, Resolution and Aperture²

Frequency Range (MHz)	0.5 to 13	0.5 to 130	0.5 to 1300
Range	0 to 80 μs	0 to 8 μs	0 to 800 ns
Resolution			
CRT:	100 ns	10 ns	1 ns
Marker:	100 ns	10 ns	1 ns
Marker over limited Range:	10 ns ($< 1 \mu\text{s}$)	1 ns (≤ 100 ns)	0.1 ns (≤ 10 ns)
Aperture ²	7 kHz	20 kHz	200 kHz

Reference Offset:
 Range: ± 1999 units.
 Accuracy: ± 0.3 units $\pm 0.3\%$ of offset.

Table A1-1. 8505A Network Analyzer Performance Specifications (3 of 3)

ELECTRICAL LENGTH/REF. PLANE EXTENSION CHARACTERISTICS																									
<p>Calibrated Electrical Length: Range and Resolution:³</p> <table border="1"> <thead> <tr> <th>Frequency Range (MHz)</th> <th>0.5 to 13</th> <th>0.5 to 130</th> <th>0.5 to 1300</th> </tr> </thead> <tbody> <tr> <td rowspan="2">Range</td> <td>x1</td> <td>±19.9 m</td> <td>±1.99 m</td> <td>±19.9 cm</td> </tr> <tr> <td>x10</td> <td>±100 m</td> <td>±10 m</td> <td>±1 m</td> </tr> <tr> <td rowspan="2">Resolution</td> <td>x1</td> <td>10 cm</td> <td>1 cm</td> <td>0.1 cm</td> </tr> <tr> <td>x10</td> <td>1 m</td> <td>10 cm</td> <td>1 cm</td> </tr> </tbody> </table>				Frequency Range (MHz)	0.5 to 13	0.5 to 130	0.5 to 1300	Range	x1	±19.9 m	±1.99 m	±19.9 cm	x10	±100 m	±10 m	±1 m	Resolution	x1	10 cm	1 cm	0.1 cm	x10	1 m	10 cm	1 cm
Frequency Range (MHz)	0.5 to 13	0.5 to 130	0.5 to 1300																						
Range	x1	±19.9 m	±1.99 m	±19.9 cm																					
	x10	±100 m	±10 m	±1 m																					
Resolution	x1	10 cm	1 cm	0.1 cm																					
	x10	1 m	10 cm	1 cm																					
<p>¹ ±3 Units may be calibrated out.</p> <p>² Typical measurement Aperture using linear FM modulation technique.</p> <p>³ Vernier provides continuous adjustment of electrical length.</p>																									
<p>Accuracy: ±3% of reading ±1% of range.</p> <p>Resolution: 10°</p> <p>Vernier Range: Continuously variable over >10° range.</p> <p>Accuracy: ±3% of reading ±10°/scan.</p> <p>Phase Compensation Linearity: < ±0.2% of phase slope inserted.</p> <p>Dimensions: 426 mm wide, 279 mm high, 553 mm deep (16-3/4 in. x 11 in. x 21-3/4 in.).</p> <p>Weight: Net, 36 kg (86 lb) Shipping, 48 kg (106 lb)</p>																									

Table A1-2. Supplemental Characteristics (1 of 2)

SOURCE				Typical CW Noise (SSB in 1 Hz BW):																															
<p>Swept Frequency Resolution: (Verniers provide continuous frequency adjustment.)</p> <table border="1"> <thead> <tr> <th>Frequency Range (MHz)</th> <th>0.5 to 13</th> <th>0.5 to 130</th> <th>0.5 to 1300</th> </tr> </thead> <tbody> <tr> <td>Start/Stop</td> <td>10 kHz</td> <td>100 kHz</td> <td>1 MHz</td> </tr> <tr> <td>CW ±ΔF</td> <td>10 kHz 1 kHz</td> <td>100 kHz 10 kHz</td> <td>1 MHz 100 kHz</td> </tr> <tr> <td>CW</td> <td>100 Hz</td> <td>1 kHz</td> <td>10 kHz</td> </tr> </tbody> </table>				Frequency Range (MHz)	0.5 to 13	0.5 to 130	0.5 to 1300	Start/Stop	10 kHz	100 kHz	1 MHz	CW ±ΔF	10 kHz 1 kHz	100 kHz 10 kHz	1 MHz 100 kHz	CW	100 Hz	1 kHz	10 kHz	<table border="1"> <thead> <tr> <th>Frequency Range (MHz)</th> <th>0.5 to 13</th> <th>0.5 to 130</th> <th>0.5 to 1300</th> </tr> </thead> <tbody> <tr> <td>dB below carrier</td> <td>70</td> <td>85</td> <td>100</td> </tr> <tr> <td>Frequency offset from carrier</td> <td>1 kHz</td> <td>10 kHz</td> <td>150 kHz</td> </tr> </tbody> </table>				Frequency Range (MHz)	0.5 to 13	0.5 to 130	0.5 to 1300	dB below carrier	70	85	100	Frequency offset from carrier	1 kHz	10 kHz	150 kHz
Frequency Range (MHz)	0.5 to 13	0.5 to 130	0.5 to 1300																																
Start/Stop	10 kHz	100 kHz	1 MHz																																
CW ±ΔF	10 kHz 1 kHz	100 kHz 10 kHz	1 MHz 100 kHz																																
CW	100 Hz	1 kHz	10 kHz																																
Frequency Range (MHz)	0.5 to 13	0.5 to 130	0.5 to 1300																																
dB below carrier	70	85	100																																
Frequency offset from carrier	1 kHz	10 kHz	150 kHz																																
<p>Frequency Counter Resolution: (Least Significant digit)</p> <table border="1"> <thead> <tr> <th>Frequency Range (MHz)</th> <th>0.5 to 13</th> <th>0.5 to 130</th> <th>0.5 to 1300</th> </tr> </thead> <tbody> <tr> <td>10 ms Sweep Time</td> <td>10 kHz</td> <td>100 kHz</td> <td>1 MHz</td> </tr> <tr> <td>100 ms Sweep Time</td> <td>1 kHz</td> <td>10 kHz</td> <td>100 kHz</td> </tr> <tr> <td>>1 second Sweep Time</td> <td>100 Hz</td> <td>1 kHz</td> <td>10 kHz</td> </tr> </tbody> </table>				Frequency Range (MHz)	0.5 to 13	0.5 to 130	0.5 to 1300	10 ms Sweep Time	10 kHz	100 kHz	1 MHz	100 ms Sweep Time	1 kHz	10 kHz	100 kHz	>1 second Sweep Time	100 Hz	1 kHz	10 kHz	<p>SOURCE General Characteristics:</p> <p>Sweep Modes: Linear Full, Log Full, Start/Stop 1, Start/Stop 2, Alternate, CW ±ΔF, and CW.</p> <p>Sweep Times: 10 ms to 100 seconds in decade ranges with vernier adjustment or manual sweep using vernier.</p> <p>Trigger Modes: Auto, line sync., single scan or external sync. up to 50 kHz rate with ≥2 Vpp and ≥1 μs trigger signal.</p> <p>RF Output Connector: Type N Female.</p>															
Frequency Range (MHz)	0.5 to 13	0.5 to 130	0.5 to 1300																																
10 ms Sweep Time	10 kHz	100 kHz	1 MHz																																
100 ms Sweep Time	1 kHz	10 kHz	100 kHz																																
>1 second Sweep Time	100 Hz	1 kHz	10 kHz																																

Table A1-2. Supplemental Characteristics (2 of 2)

RECEIVER	
<p>Input Damage Level: +20 dBm or ≥ 50 Vdc.</p> <p>Full Scale Polar Magnitude Range: 1 to 0.01 in a 1, 0.5, 0.2 sequence.</p> <p>Electrical Length Linearity: $\Delta\phi = 0.5\% \times 1.2f$ (MHz) \times 1 (meters)</p> <p>Linear Phase Substitution (degrees/scan):</p> <p style="margin-left: 20px;">Range: $\pm 1700^\circ$ per scan with 0° offset. $\frac{\pm 1.4 \text{ km}}{\text{scan width (MHz)}}$ or $\frac{\pm 4.7 \mu\text{sec}}{\text{scan width (MHz)}}$</p> <p>Magnitude Offset</p> <p style="margin-left: 20px;">Typical Maximum Offset between -10 and -30 dBm Input Level Position: ± 0.2 dB (excluding dynamic accuracy).</p> <p style="margin-left: 20px;">Typical Maximum Offset between 10 kHz and 1 kHz BW Positions: ± 0.2 dB (excluding dynamic accuracy).</p> <p>Phase Offset</p> <p style="margin-left: 20px;">Typical Maximum Offset between -10V and -30 dBm Input Level Position: $\leq \pm 2.0^\circ$ (excluding dynamic accuracy).</p> <p style="margin-left: 20px;">Typical Maximum Offset between 10 kHz and 1 kHz BW Position: $\leq \pm 5^\circ$ (excluding dynamic accuracy).</p> <p>General Characteristics:</p> <p style="margin-left: 20px;">RF Input Connectors: Type N Female.</p> <p style="margin-left: 20px;">CRT Reference Position: Reference lines for Channel 1, Channel 2, and beam center (in Polar) may be independently set to any position on the CRT Display.</p>	<p>General Characteristics (Cont'd)</p> <p>Display Bandwidth: Selectable IF bandwidths of 10 kHz and 1 kHz. A video filter position is also provided.</p> <p>CRT Background Illumination: Illumination control provided for CRT photography.</p> <p>CRT Overlays: Smith Charts (3.16, 1, 0.5, 0.2, 0.1 full scale), Log Charts (10 MHz, 100 MHz and 1000 MHz). HP Part No. 08505-60154.</p> <p>CRT Camera Adaptor: Hewlett-Packard 197A Option 006 camera is a direct fit. Camera bezel adaptor model 10375A is required to convert the standard 197A camera to fit the 8505A display.</p> <p>Auxiliary Outputs:</p> <p style="margin-left: 20px;">Channel 1 and 2 Outputs: 0.25 V/display division with 2 kΩ source impedance.</p> <p style="margin-left: 20px;">Sweep Output: 0.25 V/display division with 2 kΩ source impedance.</p> <p style="margin-left: 20px;">Pen Lift: DC coupled, 200 mA current sink.</p> <p>Power Requirements: 100, 120, 220, or 240 Vac $\pm 5\%$ -10%, 50 to 60 Hz, approximately 275 watts. (Total for Signal Processor and Source/Converter-Frequency Control units.)</p>

A1-42. TEST SETS AND ACCESSORIES AVAILABLE

A1-43. Test sets and accessories available for use with the 8505A are listed with their specifications in Table A1-3.

A1-8

A1-44. RECOMMENDED TEST EQUIPMENT

A1-45. Equipment recommended for testing and troubleshooting the 8505A Network Analyzer is listed in Table A1-4. Other equipment may be substituted for the equipment listed, providing it meets or exceeds the critical specifications indicated in the table.

Table A1-3. Test Sets and Accessories (1 of 7)

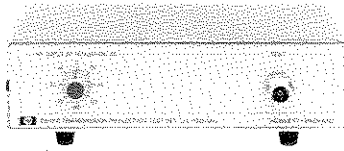

8502A
50 Ω TRANSMISSION/REFLECTION TEST SET

8502B
75 Ω TRANSMISSION/REFLECTION TEST SET¹

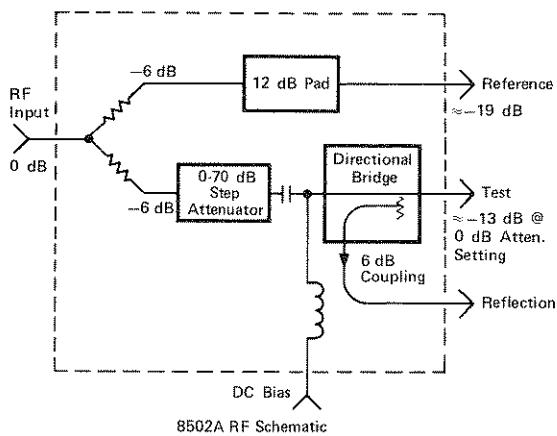

Frequency Range: 500 kHz to 1.3 GHz.

Impedance: 8502A, 50 Ω; 8502B, 75 Ω.

Directivity: ≥ 40 dB.

Frequency Response²:

Transmission: ≤±0.8 dB Magnitude and ≤±8° Phase.

Reflection: ≤±1.5 dB Magnitude and ≤±15° Phase from 0.5 to 1300 MHz; ≤±10° Phase from 2 to 1300 MHz.

Port Match:

Test Port: ≥26 dB Return Loss from 2 to 1300 MHz (≤1.12 SWR) ≥20 dB Return Loss from 0.5 to 2 MHz (1.22 SWR).

Test Port Open/Short Ratio: ±0.75 dB Magnitude and ±6° Phase from 2 to 1000 MHz; ±0.9 dB Magnitude and ±7° Phase from 1000 to 1300 MHz; ±1.25 dB Magnitude and ±10° Phase from 0.5 to 2 MHz.

Reference and Reflection Port²: ≥25 dB Return Loss from 2 to 1000 MHz (≤1.12 SWR); ≥23 dB Return Loss 0.5 to 1300 MHz (≤1.15 SWR).

Input Port³: ≥23 dB Return Loss (≤1.15 SWR).

Insertion Loss:

Input to Test Port: 13 dB.

Input to Reference Port: 19 dB.

Input to Reflection Port: 19 dB.

Maximum Operating Level: ≤+20 dBm.

Damage Level: >1 watt CW.

RF Attenuator Range: 0 to 70 dB in 10-dB steps.

DC Bias Input Range: ±30 V dc, ±200 mA, some degradation of RF specification 0.5 to 100 MHz; 500 mA maximum.

RF Connectors: 8502A, 50 Ω Type N Female; 8502B Test Port 75 Ω Type N Female, all other RF connectors 50 Ω Type N Female.

DC Bias Input Connector: BNC Female.

Includes: 8502B includes a 50 Ω to 75 Ω minimum loss pad (11852A).

Recommended Accessory: 11851A Cable Kit:

11853A 50 Ω N Accessory Kit for 8502A.

11855A 75 Ω N Accessory Kit for 8502B.

Dimensions: 101 mm wide, 61.5 mm high, 204 mm deep (7½ in. x 2-7/16 in. x 8 in.).

Weight:

Net, 1.7 kg (3-3/4 lb).

Shipping, 3.1 kg (7 lb).

¹ Tentative specification for 8502B.

² ±degrees specified as deviation from linear phase.

³ Other ports terminated in their characteristic impedance.

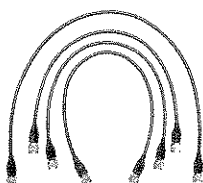

11851A
RF CABLE KIT

Function: Provides the necessary RF interconnections and RF shielding required for 8505A Network Analyzer measurements when using the 8502A, 8502B Transmission Reflection Test Sets or the 11850A, 11850B Power Splitters.

Kit Includes: Three 61 cm (24 in.) 50 Ω cables, phase matched to 4° at 1.3 GHz and one 86 cm (34 in.).

Connectors: 50 Ω Type N Male.

Weight: Net 0.91 kg (2 lb). Shipping, 1.36 kg (3 lb).

Table A1-3. Test Sets and Accessories (2 of 7)

 <p>11850A 50 Ω POWER SPLITTER</p>  <p>11850B 75 Ω POWER SPLITTER</p> <p>Frequency Range: 500 kHz to 1.3 GHz.</p> <p>Frequency Response (Absolute): Input to Output $\leq \pm 0.2$ dB.</p> <p>Nominal Insertion Loss: 9.54 dB for 11850A; 7.78 dB for 11850B.</p> <p>Impedance: 11850A, 50 Ω; 11850B, 75 Ω.</p> <p>Tracking Between Any Two Output Ports: ≤ 0.1 dB Magnitude and $\leq 1.5^\circ$ Phase.</p>	<p>Port Match: Output Ports: ≥ 32 dB Return Loss (≤ 1.05 SWR). Input Port: ≥ 20 dB Return Loss (≤ 1.2 SWR).</p> <p>Maximum Operating Level: $\leq +20$ dBm input.</p> <p>Burn-out Level: ≥ 1 watt CW.</p> <p>RF Connectors: 11850A, 50 Ω Type N Female; 11850B Test Ports (3) 75 Ω Type N Female, RF input 50 Ω Type N Female.</p> <p>Recommended Accessory: 11851A Cable Kit.</p> <p>Includes: 11850B includes three 50 Ω to 75 Ω minimum loss pads (11852A).</p> <p>Dimensions: 67 mm wide, 46 mm high, 67 mm deep (2-5/8 in. x 1-7/8 in. x 2-5/8 in.).</p> <p>Weight: Net, 1.8 kg (4 lb). Shipping, 3.1 kg (7 lb).</p> <p>¹ Tentative specification for 11850B.</p>
 <p>11600B/11602B TRANSISTOR FIXTURES</p> <p>Function: These units allow RF measurements to be made on leaded transistors. Either fixture provides common emitter, base, and collector for bipolar, and common source, gate, and drain for FET's. Other devices also fit the fixtures (tunnel diodes, diodes, etc.).</p> <p>Transistor Base Patterns: Model 11600B: Accepts TO-18/TO-72 packages. Will also accept any 3 or 4 lead packages with leads that lie on a 0.1-inch circle and whose diameters are 0.016 to 0.019 inch. Model 11602B: Accepts TO-5/TO-12 packages. Will also accept any 3 or 4 lead package with leads that lie on a 0.2-inch circle and whose diameters are 0.016 to 0.019 inch.</p> <p>Calibration References: Included for calibration of the transistor fixtures are two calibration references; a short circuit termination and a 50 Ω through-section.</p>	<p>Lead Lengths: Up to 1.5 inches long.</p> <p>Frequency Ranges: DC to 2 GHz.</p> <p>Impedance: 50 Ω nominal.</p> <p>Return Loss: >26 dB, 100 MHz to 1.0 GHz; >21 dB from 1 to 2 GHz.</p> <p>Connectors: Hybrid APC-7 precision connections.</p> <p>Option 001: Type N Female connectors.</p> <p>Recommended Accessory: The 11858A Rigid RF cable Interconnect Adapter is recommended for measurements using the 8503A S-parameter Test Set.</p> <p>Option 003: Includes 11858A Rigid Interconnect Adapter for use with 8503A.</p> <p>Maximum Power: 10W including RF signals.</p> <p>Weight: Net, 1.1 kg (2-3/8 lb). Shipping, 1.8 kg (4 lb).</p> <p>Dimensions: 44 mm wide, 152 mm high, 229 mm deep (1-3/4 in. x 6 in. x 9 in.).</p>

Table A1-3. Test Sets and Accessories (3 of 7)



8503A
50 Ω S-PARAMETER TEST SET
8503B
75 Ω S-PARAMETER TEST SET

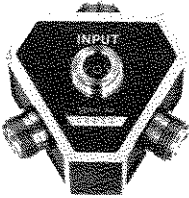
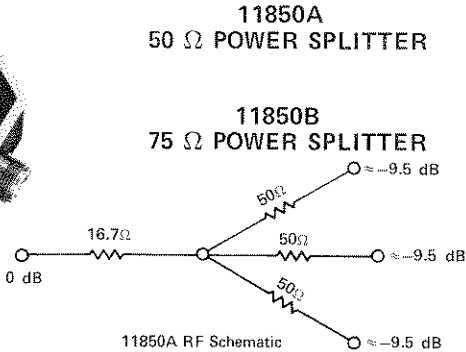
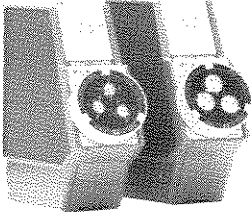
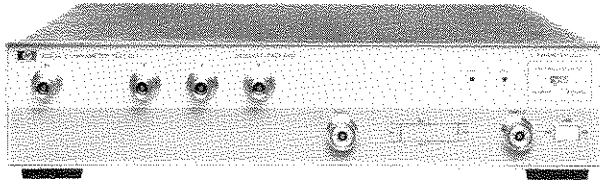
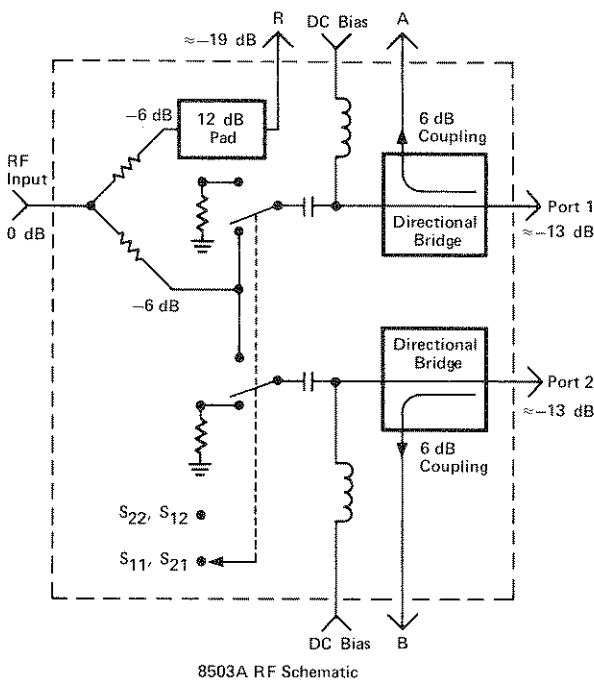

Frequency Range: 500 kHz to 1.3 GHz.

Impedance: 50 Ω.

Directivity: ≥40 dB.

Frequency Response:

Transmission¹ (S₂₁, S₁₂): ±1 dB, ±12° from 0.5 to 1300 MHz.

Reflection¹ (S₁₁, S₂₂): ±2 dB, ±20° from 0.5 to 1300 MHz, ±15° from 2 to 1300 MHz.

Port Match²:

8503A, Test Port 1 and 2: ≥28 dB Return Loss from 2 to 1000 MHz; ≥26 dB Return Loss from 1000 to 1300 MHz (≤1.11 SWR); ≥20 dB Return Loss from 0.5 to 2 MHz (≤1.22 SWR).

8503B, Test Port 1 and 2: ≥24 dB Return Loss from 2 to 1300 MHz; ≥18 dB Return Loss from 0.5 to 2 MHz.

8503A, Test Port 1 and 2 Open/Short Ratio: ≤±0.75 dB Magnitude and ±6° from 2 to 1000 MHz; ≤0.9 dB Magnitude and ±7.5° from 1000 MHz to 1300 MHz; ±1.25 dB Magnitude, ±10° Phase from 0.5 to 2 MHz

8503B, Test Port 1 and 2 Open/Short Ratio: ≤±0.9 dB Magnitude and ±7.5° from 2 to 1300 MHz; ≤±1.25 dB Magnitude and ±10° from 0.5 to 2 MHz.

Reference and Return Ports: ≥23 dB Return Loss from 2 to 1000 MHz (≤1.15 SWR); ≥20 dB Return Loss from 0.5 to 2 MHz and 1000 to 1300 MHz (≤1.22 SWR).

RF Input Port: ≥20 dB Return Loss from 0.5 to 1300 MHz (≤1.22 SWR).

Tracking Between Reference and Test Port 1 and 2:
Transmission¹ (S₂₁, S₁₂): ≤±0.5 dB Magnitude and ≤±4° Phase.

Reflection¹ (S₁₁, S₂₂): ≤±0.75 dB Magnitude and ≤±6° Phase.

RF Input to Test Port 1 or 2: ≤±1.5 dB.

Insertion Loss:

Input to Port 1 and 2:
 13 dB Nominal

Input to Port A, B, or R:
 19 dB Nominal

Maximum Operating Level: +20 dBm

Damage Level: 1 watt CW

Connectors:

Test Ports: APC-7.

All Other RF Ports: 50 Ω Type N Female.

DC Bias Inputs: BNC Female.

DC Bias Input Range: ±30 Vdc, ±200 mA, some degradation of RF specifications 0.5 to 100 MHz; 500 mA maximum.

Includes: Four 19 cm (7½ in.) cables with Type N Male connectors for connection to 8505A.

Recommended Accessory: 11857A Test Port Extension Cables.

Power: Selection of 100, 120, 220, or 240V +5%–10%, 50 or 60 Hz., approximately 10 watts.

Dimensions: 432 mm wide, 90 mm high, 495 mm deep (17 in. x 3½ in. x 19½ in.).

Weight: Net, 9.1 kg (20 lb). Shipping, 11.3 kg (25 lb).

¹ ±Degrees, specified as deviation from Linear Phase.

² Effective Port match for ratio measurement.

Table A1-3. Test Sets and Accessories (4 of 7)



<p style="text-align: center;">11857A/B/C¹ TEST PORT EXTENSION CABLES</p>  <p>¹11857A is 50 ohm cable with APC-7 connectors. 11857B is 75 ohm cable with Type-N 75 ohm male connectors on one end and Type-N 75 ohm female connectors on the other end. 11857C is 75 ohm cable with Type-N 75 ohm male connectors on one end and GR-900 75 ohm connectors on the other end.</p>	<p>Function: Two precision cables extend the 8503A test ports for convenient measurement of devices having any two-port geometry.</p> <p>Kit Includes: Two 61 cm (24 in.) cables, phase matched to 2° at 1.3 GHz</p> <p>Connectors: APC-7.</p> <p>Weight: Net, 0.91 kg (2 lb). Shipping, 1.36 kg (3 lb).</p>
 <p style="text-align: center;">11608A TRANSISTOR FIXTURE</p> <p>Function: Provides the capability of completely characterizing stripline transistors in either the TO-51 or HPAC-200 package styles. For special package styles, a through-line microstrip and bolt-in grounding structure machinable by customer is available.</p> <p>Frequency Range: DC to 12.4 GHz.</p> <p>Impedance: 50 Ω nominal.</p> <p>Return Loss: >26 dB dc to 4 GHz; >23 dB 4.0 to 8.0 GHz; >19 dB to 12.4 GHz.</p> <p>Microstrip Material: 0.031 in. polyphenylene oxide (P.P.O.); 0.080 in. wide 50 Ω stripline.</p>	<p>Package Styles: Option 001: Through-line microstrip (P.P.O. plastic) and bolt-in grounding structure machinable by customer for special package styles.</p> <p>Option 002: TO-51 (0.250 in. dia.).</p> <p>Option 003: HPAC-200 (0.205 in. dia.).</p> <p>Calibration References: Options 002 and 003 are supplied with two calibration references; a short circuit termination and a 50 Ω through-section.</p> <p>Connectors: APC-7 Hybrid connectors. Mates with 8503A and 8746B S-parameter Test Units. Option 100: Type N Female connectors.</p> <p>Maximum Power: 10 W including RF signals.</p> <p>Weight: Net, 0.9 kg (2 lb). Shipping, 1.4 kg (3 lb).</p> <p>Dimensions: 143 mm wide, 25 mm high, 89 mm deep (5-5/8 in. x 1 in. x 3½ in.).</p>
 <p style="text-align: center;">1121A AC PROBE</p> <p>Function: For making signal measurements without disturbing circuitry and for measuring voltage transfer functions in impedance systems radically different from 50 Ω. Furnished with 10:1 and 100:1 divider and BNC adapter.</p> <p>Bandwidth (3 dB): 1 kHz to >500 MHz.</p> <p>Gain: 0 dB ±1 dB.</p> <p>Frequency Response: 1 kHz to 100 MHz, ±0.5 dB, ±2°.</p>	<p>Input Impedance: 100 kΩ, shunt capacitance 3 pF at 100 MHz. With 10:1 or 100:1 divider, 1 MΩ shunt capacitance 1 pF at 100 MHz.</p> <p>Output Impedance: 50 Ω nominal.</p> <p>Maximum Input: 300 mV rms, ±100 V dc. With 10:1 divider, 3 V rms, ±350 V dc. With 100:1 divider, 30 V rms, ±350 V dc.</p> <p>Power: Supplied by 8505A through PROBE PWR jacks. Warning: The output of the 1121A is direct coupled and has an output voltage of approximately -2 to -4 V. The output must not be dc coupled or the probe may be permanently damaged. If using the 1121A with instruments other than the 8505A, or if an attenuator pad is to be used at the probe output, be sure a blocking capacitor is provided. Model 10240B or equivalent can be used.</p> <p>Weight: Net, 0.7 kg (1.5 lb). Shipping 1.2 kg (2.5 lb).</p>

Table A1-3. Test Sets and Accessories (5 of 7)

<p style="text-align: center;">11852A 50 Ω to 75 Ω Minimum Loss Pad</p> <p>Function: A low SWR impedance conversion is required for accurate transmission measurements of 75 Ω devices using the 8505A Receiver (50 Ω). The Minimum Loss Pad provides a matched impedance in both directions, 50 Ω to the 8505A and 75 Ω to the device under test.</p> <p>Frequency Range: DC to 1.3 GHz. Insertion Loss: 5.7 dB Return Loss: ≥30 dB (≤1.06 SWR). Maximum Input Power: 250 mW (+24 dBm). Connectors: 50 Ω Type N Female to 75 Ω Type N Female Dimensions: Diameter 14 mm, length 70 mm (9/16 in. x 2-3/4 in.). Weight: Net 0.11 kg (4 oz). Shipping, 0.26 kg (9 oz).</p>	<p style="text-align: center;">11855A 75 Ω Type N Accessory Kit</p> <p>Function: Provides the RF connecting hardware generally required for 75 Ω Type N component measurements using the 8502B Reflection/Transmission Test Set.</p> <p>Kit Includes:</p> <table border="0"> <thead> <tr> <th style="text-align: left;">Qty.</th> <th style="text-align: left;">Description</th> </tr> </thead> <tbody> <tr> <td>2</td> <td>75 Ω Type N Male barrel.</td> </tr> <tr> <td>2</td> <td>75 Ω Type N Female barrel.</td> </tr> <tr> <td>1</td> <td>75 Ω Type N Male short circuit</td> </tr> <tr> <td>1</td> <td>75 Ω Type N Female short circuit</td> </tr> <tr> <td>1</td> <td>Storage Case</td> </tr> </tbody> </table> <p>Dimensions: 254 mm wide, 64 mm high, 191 mm deep (10 in. x 2½ in. x 7½ in.). Weight: Net 0.91 kg (2 lb). Shipping, 1.36 kg (3 lb).</p>	Qty.	Description	2	75 Ω Type N Male barrel.	2	75 Ω Type N Female barrel.	1	75 Ω Type N Male short circuit	1	75 Ω Type N Female short circuit	1	Storage Case																
Qty.	Description																												
2	75 Ω Type N Male barrel.																												
2	75 Ω Type N Female barrel.																												
1	75 Ω Type N Male short circuit																												
1	75 Ω Type N Female short circuit																												
1	Storage Case																												
<p style="text-align: center;">11853A 50 Ω Type N Accessory Kit</p> <p>Function: The 11853A furnishes the RF components generally required when using the 8502A, 11850A, and 8503A (8503A requires 85032A also) when measuring devices having 50 Ω Type N connectors. The characteristics of the components in this kit insure high quality RF measurements for those devices having 50 Ω Type N connectors.</p> <p>Kit Includes:</p> <table border="0"> <thead> <tr> <th style="text-align: left;">Qty.</th> <th style="text-align: left;">Description</th> </tr> </thead> <tbody> <tr> <td>1</td> <td>Type N Female short circuit</td> </tr> <tr> <td>1</td> <td>Type N Male short circuit</td> </tr> <tr> <td>2</td> <td>Type N Male Barrel</td> </tr> <tr> <td>2</td> <td>Type N Female Barrel</td> </tr> <tr> <td>1</td> <td>Storage Case</td> </tr> </tbody> </table> <p>Dimensions: 254 mm wide, 64 mm high, 191 mm deep (10 in. x 2½ in. x 7½ in.). Weight: Net 0.91 kg (2 lb). Shipping, 1.36 kg (3 lb).</p>	Qty.	Description	1	Type N Female short circuit	1	Type N Male short circuit	2	Type N Male Barrel	2	Type N Female Barrel	1	Storage Case	<p style="text-align: center;">11856A 75Ω BNC Accessory Kit</p> <p>Function: Provides the BNC connecting hardware required for test setups using the HP 8502B Transmission /Reflection Test Set, the HP 8503B S-Parameter Test Set, or the HP 11850B Power Splitter (75-ohm) to make measurements on devices with 75Ω BNC connectors.</p> <p>Kit Includes:</p> <table border="0"> <thead> <tr> <th style="text-align: left;">Qty</th> <th style="text-align: left;">Description</th> </tr> </thead> <tbody> <tr> <td>2</td> <td>75Ω Type N Male to BNC Female adapter</td> </tr> <tr> <td>2</td> <td>75Ω Type N Male to BNC Male adapter</td> </tr> <tr> <td>2</td> <td>75Ω Type N Female to BNC Male adapter</td> </tr> <tr> <td>2</td> <td>75Ω Type N Female to BNC Female adapter</td> </tr> <tr> <td>1</td> <td>75Ω BNC Male short circuit</td> </tr> <tr> <td>1</td> <td>BNC Male 75Ω termination</td> </tr> <tr> <td>1</td> <td>Storage Case</td> </tr> </tbody> </table> <p>Dimensions: 168 mm wide, 114 mm deep, 51 mm high (6-5/8 in. x 4-1/2 in. x 2 in.) Weight: Net 0.91 kg (2 lb). Shipping: 1.36 kg (3 lb).</p>	Qty	Description	2	75Ω Type N Male to BNC Female adapter	2	75Ω Type N Male to BNC Male adapter	2	75Ω Type N Female to BNC Male adapter	2	75Ω Type N Female to BNC Female adapter	1	75Ω BNC Male short circuit	1	BNC Male 75Ω termination	1	Storage Case
Qty.	Description																												
1	Type N Female short circuit																												
1	Type N Male short circuit																												
2	Type N Male Barrel																												
2	Type N Female Barrel																												
1	Storage Case																												
Qty	Description																												
2	75Ω Type N Male to BNC Female adapter																												
2	75Ω Type N Male to BNC Male adapter																												
2	75Ω Type N Female to BNC Male adapter																												
2	75Ω Type N Female to BNC Female adapter																												
1	75Ω BNC Male short circuit																												
1	BNC Male 75Ω termination																												
1	Storage Case																												
<p style="text-align: center;">11854A 50 Ω BNC Accessory Kit</p> <p>Function: The 11854A furnishes the RF components generally required when using the 8502A, 11850A, and 8503A (8503A requires the 85032A also) when measuring devices having 50 Ω BNC connectors. The characteristics of the components in this kit insure high quality RF measurements for those devices having 50 Ω BNC connectors.</p> <p>Kit Includes:</p> <table border="0"> <thead> <tr> <th style="text-align: left;">Qty.</th> <th style="text-align: left;">Description</th> </tr> </thead> <tbody> <tr> <td>2</td> <td>Type N Male to BNC Female adapter</td> </tr> <tr> <td>2</td> <td>Type N Male to BNC Male adapter</td> </tr> <tr> <td>2</td> <td>Type N Female to BNC Male adapter</td> </tr> <tr> <td>2</td> <td>Type N Female to BNC Female adapter</td> </tr> <tr> <td>1</td> <td>BNC Male short circuit</td> </tr> <tr> <td>1</td> <td>Storage Case</td> </tr> </tbody> </table> <p>Dimensions: 254 mm wide, 64 mm high, 191 mm deep (10 in. x 2½ in. x 7½ in.). Weight: Net 1.13 kg (2½ lb). Shipping, 1.59 kg (3½ lb).</p>	Qty.	Description	2	Type N Male to BNC Female adapter	2	Type N Male to BNC Male adapter	2	Type N Female to BNC Male adapter	2	Type N Female to BNC Female adapter	1	BNC Male short circuit	1	Storage Case	<p style="text-align: center;">11858A Rigid Interconnect Adapter</p> <p>Function: Provides a rigid RF cable interconnection (horizontal to vertical test port orientation) between the 8503A S-parameter Test Set and the 11600B/11602B Transistor Fixtures and 11604A Universal Extension (11604A information provided in 8410S data sheet).</p> <p>Connectors: APC-7</p> <p>Dimensions: 254 mm wide, 64 mm high, 191 mm deep (10 in. x 2½ in. x 7½ in.). Weight: Net 0.91 kg (2 lb). Shipping 1.36 kg (3 lb).</p>														
Qty.	Description																												
2	Type N Male to BNC Female adapter																												
2	Type N Male to BNC Male adapter																												
2	Type N Female to BNC Male adapter																												
2	Type N Female to BNC Female adapter																												
1	BNC Male short circuit																												
1	Storage Case																												

Table A1-3. Test Sets and Accessories (6 of 7)

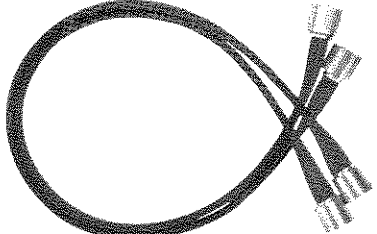
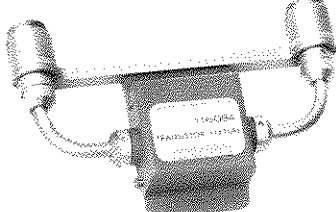
<p style="text-align: center;">85010A/B 8507A/B—8501A Application PAC</p> <p>Function: Provides a cassette program that supplements the 85030A/B Application PAC. It provides faster data transfer and incorporates the normalization and averaging features of the 8501A.</p> <p>Includes: Cassette and Operating/Programming Manual.</p>	<p style="text-align: center;">85032A 50 Ω Type N Calibration Kit</p> <p>Function: This kit is recommended for use with the 8503A S-parameter Test Set or 8507A Automatic Network Analyzer for measurement of devices having Type N RF connectors.</p> <p>Kit Includes:</p> <table border="0"> <thead> <tr> <th style="text-align: left;">Qty.</th> <th style="text-align: left;">Description</th> </tr> </thead> <tbody> <tr> <td>2</td> <td>APC-7 to Type N Female adapter</td> </tr> <tr> <td>2</td> <td>APC-7 to Type N Male adapter</td> </tr> <tr> <td>1</td> <td>50 Ω Type N Female termination with <1.005 SWR at 2 GHz</td> </tr> <tr> <td>1</td> <td>50 Ω Type N Male termination with <1.005 SWR at 2 GHz</td> </tr> <tr> <td>1</td> <td>Type N Female short circuit</td> </tr> <tr> <td>1</td> <td>Type N Male short circuit</td> </tr> <tr> <td>1</td> <td>Storage Case</td> </tr> </tbody> </table> <p>Dimensions: 254 mm wide, 64 mm high, 191 mm deep (10 in. x 2½ in. x 7½ in.).</p> <p>Weight: Net 1.13 kg (2½ lb). Shipping 1.59 kg (3½ lb).</p>	Qty.	Description	2	APC-7 to Type N Female adapter	2	APC-7 to Type N Male adapter	1	50 Ω Type N Female termination with <1.005 SWR at 2 GHz	1	50 Ω Type N Male termination with <1.005 SWR at 2 GHz	1	Type N Female short circuit	1	Type N Male short circuit	1	Storage Case												
Qty.	Description																												
2	APC-7 to Type N Female adapter																												
2	APC-7 to Type N Male adapter																												
1	50 Ω Type N Female termination with <1.005 SWR at 2 GHz																												
1	50 Ω Type N Male termination with <1.005 SWR at 2 GHz																												
1	Type N Female short circuit																												
1	Type N Male short circuit																												
1	Storage Case																												
<p style="text-align: center;">85030A 8507A/9830A Application PAC</p> <p style="text-align: center;">85030B 8507B/9825A Application PAC</p> <p>Function: Provides three cassette programs. The Accuracy Enhancement Program (AIM-30 or AIM-25) improves measurement accuracy by removing mismatch, directivity and frequency tracking errors for both one-and two-port devices. The Verification Program operationally checks calculator/network analyzer interfaces. The Basic Measurements Program makes the features of Learn Mode and data printing, plotting (with 9862A Plotter), and normalization available to the non-programmer.</p> <p>Includes: Cassettes and Operating/Programmers Manual</p> <p>Weight: Net 0.91 kg (2 lb). Shipping 1.36 kg (3 lb).</p>	<p style="text-align: center;">85033A SMA Calibration Kit</p> <p>Function: This kit is recommended for use with the 8503A S-parameter Test Set or 8507A Automatic Network Analyzer for measurement of devices having SMA RF connectors.</p> <p>Kit Includes:</p> <table border="0"> <thead> <tr> <th style="text-align: left;">Qty.</th> <th style="text-align: left;">Description</th> </tr> </thead> <tbody> <tr> <td>2</td> <td>APC-7 to SMA Male adapter</td> </tr> <tr> <td>2</td> <td>APC-7 to SMA Female adapter</td> </tr> <tr> <td>1</td> <td>50 Ω SMA Female termination</td> </tr> <tr> <td>1</td> <td>50 Ω SMA Male termination</td> </tr> <tr> <td>1</td> <td>SMA Female short circuit</td> </tr> <tr> <td>1</td> <td>SMA Male short circuit</td> </tr> <tr> <td>1</td> <td>Storage Case</td> </tr> </tbody> </table> <p>Dimensions: 254 mm wide, 64 mm high, 191 mm deep (10 in. x 2½ in. x 7½ in.).</p> <p>Weight: Net 1.13 kg (2½ lb). Shipping, 1.59 kg (3½ lb).</p>	Qty.	Description	2	APC-7 to SMA Male adapter	2	APC-7 to SMA Female adapter	1	50 Ω SMA Female termination	1	50 Ω SMA Male termination	1	SMA Female short circuit	1	SMA Male short circuit	1	Storage Case												
Qty.	Description																												
2	APC-7 to SMA Male adapter																												
2	APC-7 to SMA Female adapter																												
1	50 Ω SMA Female termination																												
1	50 Ω SMA Male termination																												
1	SMA Female short circuit																												
1	SMA Male short circuit																												
1	Storage Case																												
<p style="text-align: center;">85031A Verification and APC-7 Calibration Kit</p> <p>Function: This kit is furnished with the 8507A Automatic Network Analyzer and is used for verification of measurement system performance. 3 dB and 50 dB Pads are included for use with the 8507A's verification program which functionally checks all parts of the 8507A system. Test data on the pads is also provided.</p> <p>Kit Includes:</p> <table border="0"> <thead> <tr> <th style="text-align: left;">Qty.</th> <th style="text-align: left;">Description</th> </tr> </thead> <tbody> <tr> <td>1</td> <td>APC-7 50 Ω Termination <1.005 SWR at 2 GHz</td> </tr> <tr> <td>1</td> <td>APC-7 Short Circuit</td> </tr> <tr> <td>1</td> <td>APC-7 3 dB Pad with Test Data</td> </tr> <tr> <td>1</td> <td>APC-7 50 dB Pad with Test Data</td> </tr> <tr> <td>1</td> <td>Storage Case</td> </tr> </tbody> </table> <p>Dimensions: 254 mm wide, 64.0 mm high, 19 mm deep (10 in. x 2½ in. x 7½ in.).</p> <p>Weight: Net 0.91 kg (2 lb). Shipping, 1.36 kg (3 lb).</p>	Qty.	Description	1	APC-7 50 Ω Termination <1.005 SWR at 2 GHz	1	APC-7 Short Circuit	1	APC-7 3 dB Pad with Test Data	1	APC-7 50 dB Pad with Test Data	1	Storage Case	<p style="text-align: center;">85036A 75Ω Type N Calibration Kit</p> <p>Function: This calibration kit contains 75Ω Type N connector adapters, short circuits, and terminations. This hardware is required for making error-corrected measurements in accuracy enhancement program (AIM) test setups that use equipment with 75Ω Type N connectors.</p> <p>Kit Includes:</p> <table border="0"> <thead> <tr> <th style="text-align: left;">Qty</th> <th style="text-align: left;">Description</th> </tr> </thead> <tbody> <tr> <td>1</td> <td>75Ω Type N Male to Type N Male adapter</td> </tr> <tr> <td>1</td> <td>75Ω Type N Female to Type N Female adapter</td> </tr> <tr> <td>1</td> <td>75Ω Type N Male short circuit</td> </tr> <tr> <td>1</td> <td>75Ω Type N Female short circuit</td> </tr> <tr> <td>1</td> <td>Type N Male 75Ω termination</td> </tr> <tr> <td>1</td> <td>Type N Female 75Ω termination</td> </tr> <tr> <td>1</td> <td>Storage Case</td> </tr> </tbody> </table> <p>Dimensions: 168 mm wide, 114 mm deep, 51 mm high (6- 5/8 in. x 4- 1/2 in. x 2 in.).</p> <p>Weight: Net: 0.91 kg (2 lb). Shipping: 1.36 kg (3 lb).</p>	Qty	Description	1	75Ω Type N Male to Type N Male adapter	1	75Ω Type N Female to Type N Female adapter	1	75Ω Type N Male short circuit	1	75Ω Type N Female short circuit	1	Type N Male 75Ω termination	1	Type N Female 75Ω termination	1	Storage Case
Qty.	Description																												
1	APC-7 50 Ω Termination <1.005 SWR at 2 GHz																												
1	APC-7 Short Circuit																												
1	APC-7 3 dB Pad with Test Data																												
1	APC-7 50 dB Pad with Test Data																												
1	Storage Case																												
Qty	Description																												
1	75Ω Type N Male to Type N Male adapter																												
1	75Ω Type N Female to Type N Female adapter																												
1	75Ω Type N Male short circuit																												
1	75Ω Type N Female short circuit																												
1	Type N Male 75Ω termination																												
1	Type N Female 75Ω termination																												
1	Storage Case																												

Table A1-3. Test Sets and Accessories (7 of 7)

8505A TEST SET AND ACCESSORY RECOMMENDATIONS

Can be ordered as 11600B/11602B Option 003

Three 50 to 75 Ω Minimum Loss Pads provided with 11852A, one Minimum Loss Pad provided with 8502B.



	TRANSISTOR S-PARAMETERS TO-18/TO-72 TO-5/TO-12 TO-51 HPAC-200	S-PARAMETERS APC-7 (50 Ω) Type N (50 Ω) BNC (50 Ω)	TRANSMISSION/ REFLECTION MEASUREMENTS Type N (50 Ω) BNC (50 Ω) Type N (75 Ω)	TRANSMISSION MEASUREMENTS Only Type N (50 Ω) BNC (50 Ω) Type N (75 Ω)
8505A Network Analyzer	■	■	■	■
8502A 50 Ω Transmission/ Reflection Test Set			■	
8502B 75 Ω Transmission/ Reflection Test Set			■	
11850A 50 Ω Power Splitter				■
11850B 75 Ω Power Splitter				■
8503A 50 Ω S-Parameter Test Set	■	■		
11600B Transistor Fixture	■			
11602B Transistor Fixture		■		
11608A Option 002 Stripline Transistor Fixture	■			
11608A Option 003 Stripline Transistor Fixture	■			
11851A RF Cable Kit			■	■
11852A 50 Ω to 75 Ω Minimum Loss Pad			▴	▴
11853A 50 Ω Type N Accessory Kit			■	
11854A 50 Ω BNC Accessory Kit			■	
11855A 75 Ω Type N Accessory Kit			■	
11857A Test Port Extension Cables		■		
11858A Rigid Interconnect Adapter	▴			
85032A 50 Ω Type N Calibration Kit		■		

Table A1-4. Recommended Test Equipment (1 of 3)

Instrument	Recommended Model	Critical Specifications	Use*
Electronic Counter	HP 5340A	Freq Range: 400 kHz to 5.52 GHz Accuracy: ± 1 count Sensitivity: -5 dBm	P,A,T
Power Meter and Sensor	HP 435A/8482A/ 8484A or HP 436A/8482A/ 8484A	Freq Range: 500 kHz to 1300 MHz Power Range: $+20$ to -60 dBm Accuracy: ± 0.5 dB at 1300 MHz	P,A,T
Spectrum Analyzer	HP 141T/8552B/ 8553B/8555A	Freq Range: 500 kHz to 5.5 GHz Impedance: 50 ohms Dynamic Range: 60 dB Frequency identification capability	P,A,T
Oscilloscope	HP 180C/1801A/ 1820A/1804A	Vertical Bandwidth: 20 MHz minimum Vertical Sensitivity: 5 mV/Div Horizontal Sweep Rate: 1 μ s/Div Channels: 4 (with 1804A plug-in)	A,T
Digital Voltmeter, AC/DC	HP 3490A	AC Range: 0 to 300V, 50 to 400 Hz DC Range: 0 to 200V Accuracy: $\pm 5\%$ Resolution: to 5 digits	A,T
Function Generator	HP 3312A	Output: $+1V$ p-p square wave, 10 kHz and 100 kHz Adjustable DC offset.	A
Spectrum Analyzer	HP 8568A*	Freq. Range: to 1300 MHz Residual FM: < 3 Hz peak-to-peak	P
AM-FM Signal Generator	HP 8640A/B*	Frequency: 5 – 500 MHz Residual FM: < 5 Hz	P
Frequency Meter	HP 5210A*	Must have internal 12 kHz filter	P
RMS Voltmeter	HP 3400A*	True RMS Response: 1 mV-1V, 10 Hz to 10 MHz	P
Double Balanced Mixer	HP 10514A*	Frequency Range: 7 MHz to 500 MHz	P
40 dB Low Noise Amplifier	HP 08640-60506*	Input/Output Impedance: 50 ohms Low Frequency Response: 20 ± 4 Hz Noise: < 3 dB	P
10 kHz Low-Pass Filter	HP 08505-60155*	Impedance: 50 ohms Type: 5-pole Butterworth	P
1 kHz Low-Pass Filter	HP 08505-60156*	Impedance: 50 ohms Type: 5-pole Butterworth	P

*If a Model HP 8568A Spectrum Analyzer is not available to make Spectral Purity tests, an alternate procedure may be used using an 8640A/B, 5210A, etc.

Table A1-4. Recommended Test Equipment (2 of 3)

Recommended Model	Instrument	Critical Specifications	Use*
3-Way Power Splitter	HP 11850A	Impedance: 50 ohms Freq Range: 500 kHz to 1.3 GHz Connectors: Type N, female Freq Response: Input to output $\leq \pm 0.2$ dB	P,A,T
50-Ohm Transmission/Reflection Test Set	HP 8502A	No substitution	P,T
Matched Type N Coaxial Cables (3 required)	HP 11851A	50-ohm double-shielded coaxial cables 61 cm (24 inches) long, phase matched to 2° at 1300 MHz	P,A,T
50-Ohm Termination (3 required)	HP 909A Option 012	Freq Range: 500 kHz to 1.3 GHz Impedance: 50 ohms Connector: Type N, male SWR: < 1.4	P,A
10 dB Attenuator	HP 8491B	Attenuation: 10 dB ± 0.5 dB SWR: < 1.3	P,T
50-Ohm Feed-through Termination	HP 10100C	Connector: BNC	P
Type N Female Short	HP 11511A		P
BNC to Type N Adapter (2 required)	HP 1250-0780	Impedance: 50 ohms	P
12-Pin (Dual 6 -Pin) Extender Board	HP 08505-60109		A,T
Calibrated Step Attenuator	H89-355D	Attenuation: 0 to 120 dB in 10 dB steps Standards lab calibrated at 20 MHz Connectors: BNC	
AC Probe	HP 1121A	No substitution	A
Coaxial Step Attenuator	HP 8496A	Attenuation: 0 to 110 dB in 10 dB increments SWR: 1.5 Connectors: Type N, male	P, A

Table A1-4. Recommended Test Equipment (3 of 3)

Instrument	Recommended Model	Critical Specifications	Use*
30-Pin (Dual 15-Pin) Extender Board (2 required)	HP 08505-60041		A,T
36-Pin (Dual 18-Pin) Extender Board (3 required)	HP 08505-60042		A,T
50-Pin (Dual 25-Pin) Extender Board	HP 08505-60108		A,T
182.88 cm (72 inches) Coaxial Cable with Type N Connectors (2 required)	HP 11500A	50-ohm coaxial cable 182.88 cm long, terminated on both ends with UG-21D/U type N Male connectors	P
15.24 plus Meters (50 plus feet) of 50Ω Coaxial Cable		50-ohm type RG 223/U coaxial cable with BNC connectors on both ends	P,A
Type N Right Angle Adapter	HP 1250-0176		P
Type N Male-to-Male Adapter	HP 1250-0778	Impedance: 50 ohm	P
Type N Female-to-Female Adapter	HP 1250-0777	Impedance: 50 ohm	P
Service Interconnect Cable 61 cm (24 inches)	HP 08505-60202		T
Signature Analyzer	HP 5004A	No Substitute	T
Logic Pulser	HP 546A	No Substitute	T
Logic Probe	HP 545A	No Substitute	T
16-Pin IC Clip-on Connector (6 required)	HP 1400-0734	Any IC Clip	T
* P = Performance Test; A = Adjustment; T = Troubleshooting			

CHAPTER A MODEL 8505A NETWORK ANALYZER

SECTION II INSTALLATION & INCOMING INSPECTION

A2-1. INTRODUCTION

A2-2. This section provides instructions for setting up the Model 8505A Network Analyzer on a bench or installing it in a standard equipment rack. Information about receiving inspection, operation verification, operating and storage environmental limitations, and packing requirements for re-shipment are also included.

A2-3. RECEIVING INSPECTION

A2-4. Inspect the shipping container. If it or the cushioning material is damaged, keep it until the entire shipment has been checked for completeness, and the instrument has been checked mechanically and electrically. Check the equipment received in the shipment against the shipping manifest and equipment illustrations in Section I. Check the 8505A operation with the Incoming Inspection Tests in paragraph A2-49. If the shipment is incomplete, or if the equipment is damaged or will not pass the Incoming Inspection Tests, notify the nearest Hewlett-Packard office. If, in addition, the shipping container is damaged or the cushioning material shows signs of stress, notify the carrier as well as the Hewlett-Packard office. Keep the shipping materials for the carrier's inspection. The Hewlett-Packard office will arrange for repair or replacement of damaged equipment without waiting for a claim settlement.

A2-5. ENVIRONMENTAL LIMITATIONS

A2-6. Environmental limitations for the Model 8505A Network Analyzer are:

Temperature — 0° C to +55° C Operating;
—40° C to +75° C, stored or in shipment.

Altitude (Barometric) — To 4572 metres
(15 000 feet) operating. To 15240 metres
(50 000 feet) stored or in shipment.

Humidity — To 95%, however, instrument must be protected from temperature extremes that could cause condensation to form in it.

A2-7. BENCH USE

A2-8. For bench use, the two chassis units of the 8505A are locked together with the lower unit sitting on the bench or on an 8503A S-Parameter Test Set. On the rear corners of each chassis unit there are feet which allow the units to be set down front-panel up as long as no cables are connected to the rear panel connectors. The bottom two feet on the Signal Processor and display unit, and the upper two feet on the Source/Converter Frequency Control unit fasten together with thumbscrews to lock the two units together at the rear (See Figure A2-1). In the front, four hook-shaped flanges on the top of the lower unit engage corresponding slots in the top unit. To fasten the two units together, proceed as follows:

- a. Set the Signal Processor on top of the Source/Converter-Frequency Control, with the front edge of the Signal Processor overlapping the front edge of the bottom unit approximately 1/4-inch.
- b. Slide the top unit back until its front edge is even with the front edge of the lower unit. This should lock the fronts of the two units together. Make sure they are locked by lifting up on the front of the top unit.
- c. Tighten the thumb-screws on the bottom rear feet of the top unit into the top rear feet of the bottom unit.

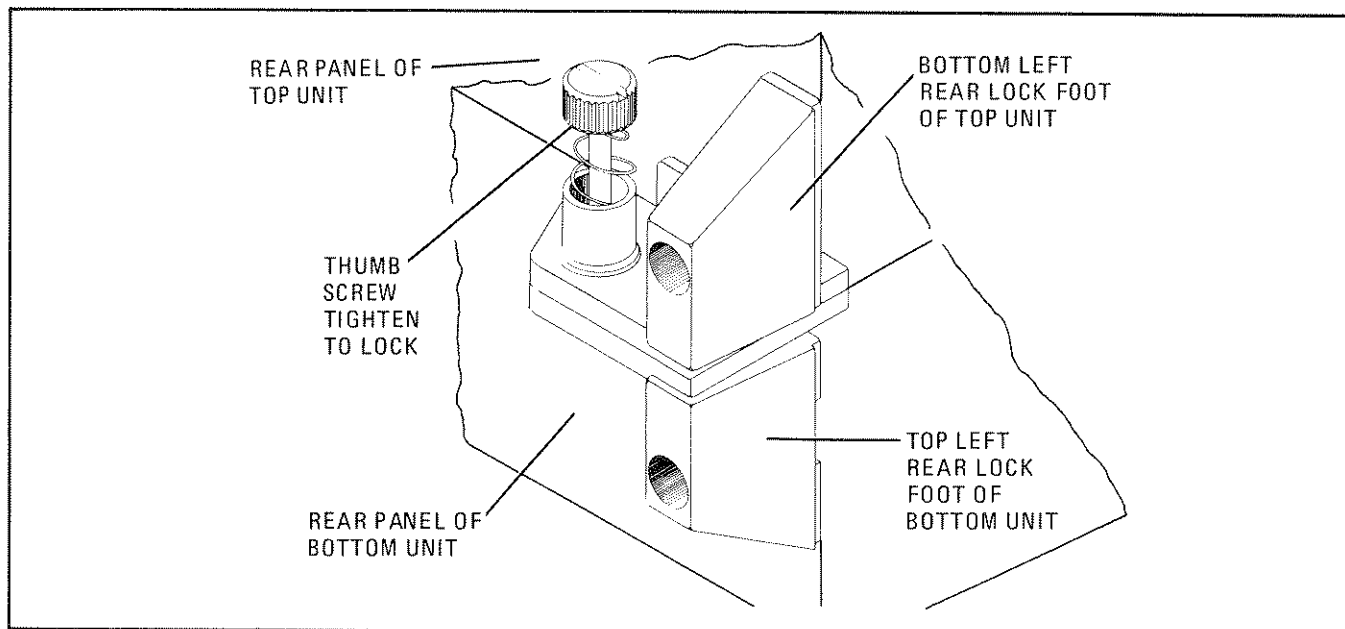

Figure A2-1. Lock Feet, Left Side

A2-9. RACK MOUNTING

A2-10. Two rack-mounting kits are available for the 8505A. One, Option 908, is for 8505A's that do not have or need front handles. The other rack

mounting kit, Option 909, includes both the rack-mounting hardware and the front handles. Parts supplied with the two kits are listed in Table A2-1; the manner in which these parts attach to the 8505A is shown in Figure A2-2.

Table A2-1. Rack-Mounting Kits for 8505A

Description	HP Part Number	Quantity
OPTION 908 (HP 5061-0077) Includes: Rack Flange	5020-8862	4
Machine Screw, Pan Head, 8-32 x 0.375 inch	2510-0193	12
Option 909 (HP 5061-0083) Includes: Handle Assembly	5060-9899	4
Rack Flange	5020-8874	4
Machine Screw, Pan Head, 8-32 x 0.625 inch	2510-0194	12

NOTE

Rack-mounting kits and other options are shipped with the instrument as part of the original order only; they are not supplied separately. If you already have an 8505A and want to add the optional equipment, order the kit, assemblies, attaching hardware or other materials you need by their HP Part Numbers, rather than by option number, from your nearest HP office.

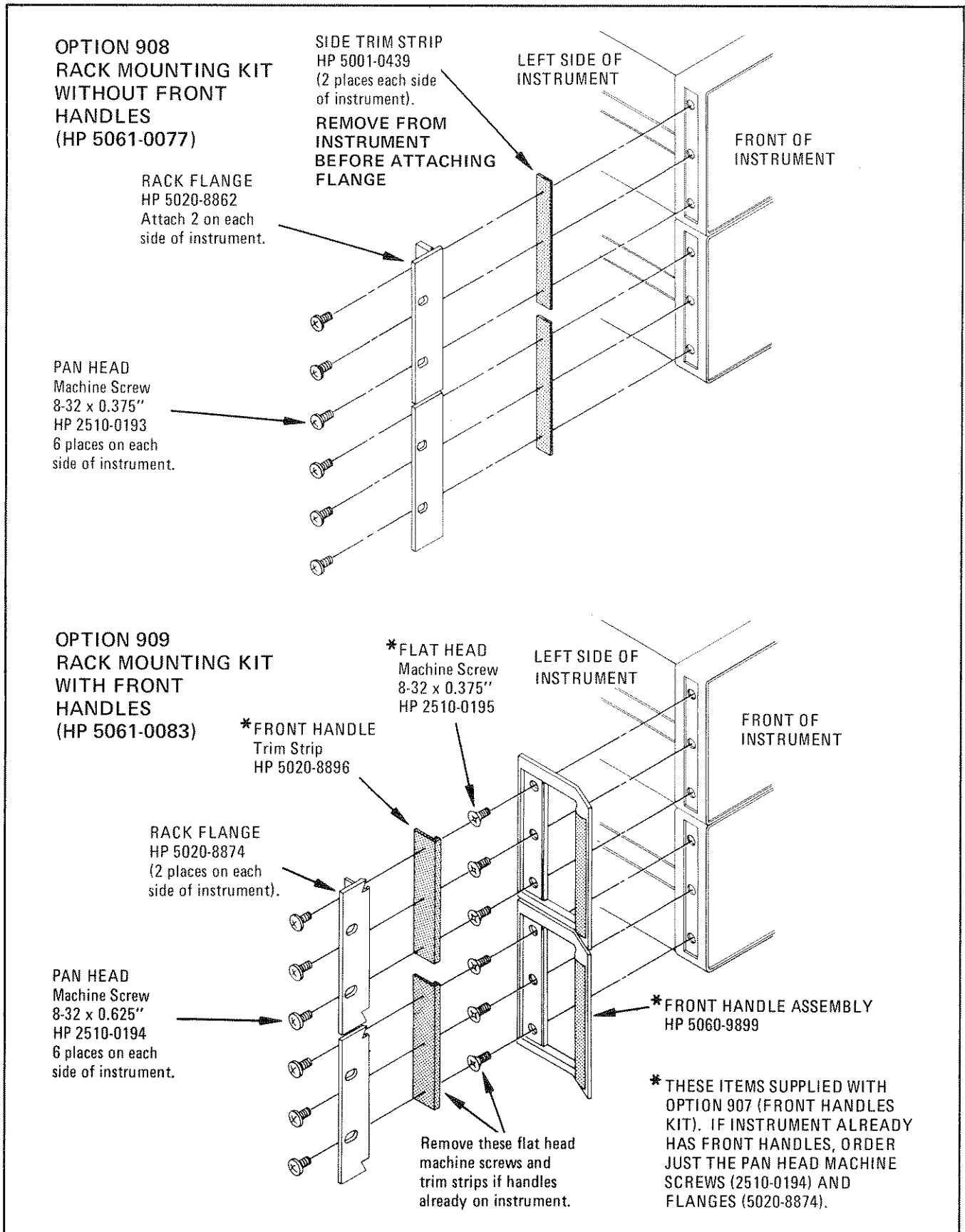

Figure A2-2. Attaching Rack Mounting Hardware and Handles

A2-11. PRE-OPERATION SET UP**A2-12. Power Requirements**

A2-13. The Model 8505A requires a power source of 100, 120, 220, or 240 Vac, +5% -10%, 50 to 60 Hz, single-phase. Power Consumption is approximately 275 watts.

A2-14. Line Voltage and Fuse Selection**WARNING**

BEFORE THIS INSTRUMENT IS SWITCHED ON, its protective earth terminals must be connected to the protective conductor of the mains power cable (cord). The mains power cable plug shall only be inserted in a socket outlet provided with a protective earth contact. DO NOT negate the earth-grounding protection by using an extension cable, power cable, or autotransformer without a protective ground conductor. Failure to ground the instrument properly can result in serious personal injury or death.

CAUTION

BEFORE SWITCHING ON THIS INSTRUMENT, make sure it is adapted to the voltage of the ac power source. You must set the voltage selector cards correctly in both the top and bottom units of the 8505A to adapt it to the power source. Failure to set the ac power inputs of the instrument for the correct voltage level could cause it to be severely damaged when switched on.

A2-15. Select the line voltage and fuses in both the top and bottom units of the 8505A as follows:

- Measure the ac line voltage you will be applying to the 8505A.
- See Figure A2-3. At each of the instrument's two rear-panel power line modules, select the

line voltage (100V, 120V, 220V, or 240V) closest to the voltage you measured in step a. Note that the available line voltage must be within +5% or -10% of the line voltage selection as shown below. If it is not, you must use an autotransformer between the ac source and the 8505A.

Line Voltage	Selection
90 to 105 Vac	100V
108 to 126 Vac	120V
198 to 231 Vac	220V
216 to 252 Vac	240V

- Make sure the fuses in the power module fuse holder are of the correct type and rating. Fuse requirements for the different line voltage selections are indicated next to the power modules.

A2-16. HP-IB Address Selection

A2-17. The talk/listen address pair for the signal processor/display is different than the talk/listen address pair for the frequency control-source/converter. The pre-set factory selected address pair for the signal processor/display is Talk Address P (Octal 120) and Listen Address \emptyset (Octal 060); the address pair for the frequency control-source/converter is Talk Address S (Octal 123) and Listen Address 3 (Octal 063). Before installing the HP-IB interface assemblies, other talk/listen address pairs shown in Table A2-2 may be selected. (The code selected must of course be compatible with the system.) The addresses are selected with switch S1 on the A3A21 and A2A16 HP-IB Buffer Assemblies. The numbers 1 through 5 on the two buffer assemblies correspond to b₁ through b₅ respectively in Table A2-2. The address is selected by pressing the desired switch to the open position. (See Figure A2-4.) The switches in Figure A2-4 are set to My Listen Address (MLA) in the ASCII character "3" address code (Octal 063) or to My Talk Address (MTA) in the ASCII alpha character "S" (Octal 123).

A2-18. Cable Connections

A2-19. All cable connections to the 8505A, except those to the device under test, are made at the rear panels. The rear-panel connectors and their reference designators are shown in Figure A2-5.

A2-20. Power Cable

WARNING

If this instrument is to be energized through an autotransformer, make sure the common terminal of the autotransformer is connected to the protective earth contact of the power source outlet socket. The protective earth terminals of the 8505A must be

connected through the protective conductor of the power cable to the power source outlet socket protective earth contact. This protection must not be negated through the use of an extension cord (power cable) without a protective ground conductor. Any interruption of the protective ground, inside or outside the 8505A, can make the 8505A a dangerous electric shock hazard.

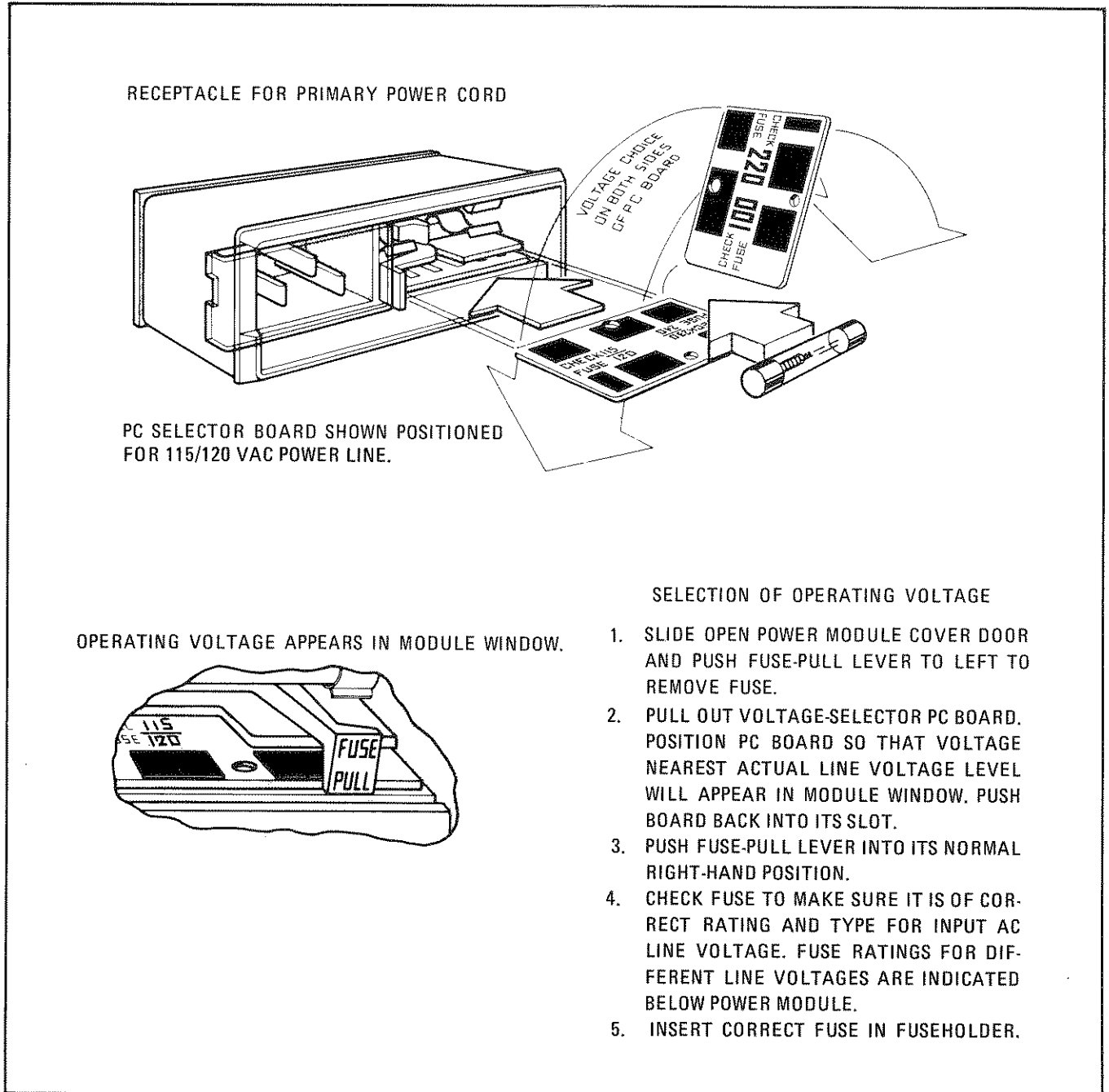

Figure A2-3. Line Voltage Selection with Power Module PC Board

Table A2-2. Talk and Listen Addresses

b ₅	b ₄	b ₃	b ₂	b ₁	Talk Address Character	Listen Address Character	Decimal Value
0	0	0	0	0	@	SP	00
0	0	0	0	1	A	!	01
0	0	0	1	0	B	"	02
0	0	0	1	1	C	#	03
0	0	1	0	0	D	\$	04
0	0	1	0	1	E	%	05
0	0	1	1	0	F	&	06
0	0	1	1	1	G	'	07
0	1	0	0	0	H	(08
0	1	0	0	1	I)	09
0	1	0	1	0	J	*	10
0	1	0	1	1	K	+	11
0	1	1	0	0	L	,	12
0	1	1	0	1	M	-	13
0	1	1	1	0	N	.	14
0	1	1	1	1	O	/	15
*1	0	0	0	0	P	0	16
1	0	0	0	1	Q	1	17
1	0	0	1	0	R	2	18
**1	0	0	1	1	S	3	19
1	0	1	0	0	T	4	20
1	0	1	0	1	U	5	21
1	0	1	1	0	V	6	22
1	0	1	1	1	W	7	23
1	1	0	0	0	X	8	24
1	1	0	0	1	Y	9	25
1	1	0	1	0	Z	:	26
1	1	0	1	1	[;	27
1	1	1	0	0	\	<	28
1	1	1	0	1]	=	29
1	1	1	1	0)	>	30

*Preset Address of Signal Processor.

**Preset Address of Frequency Control.

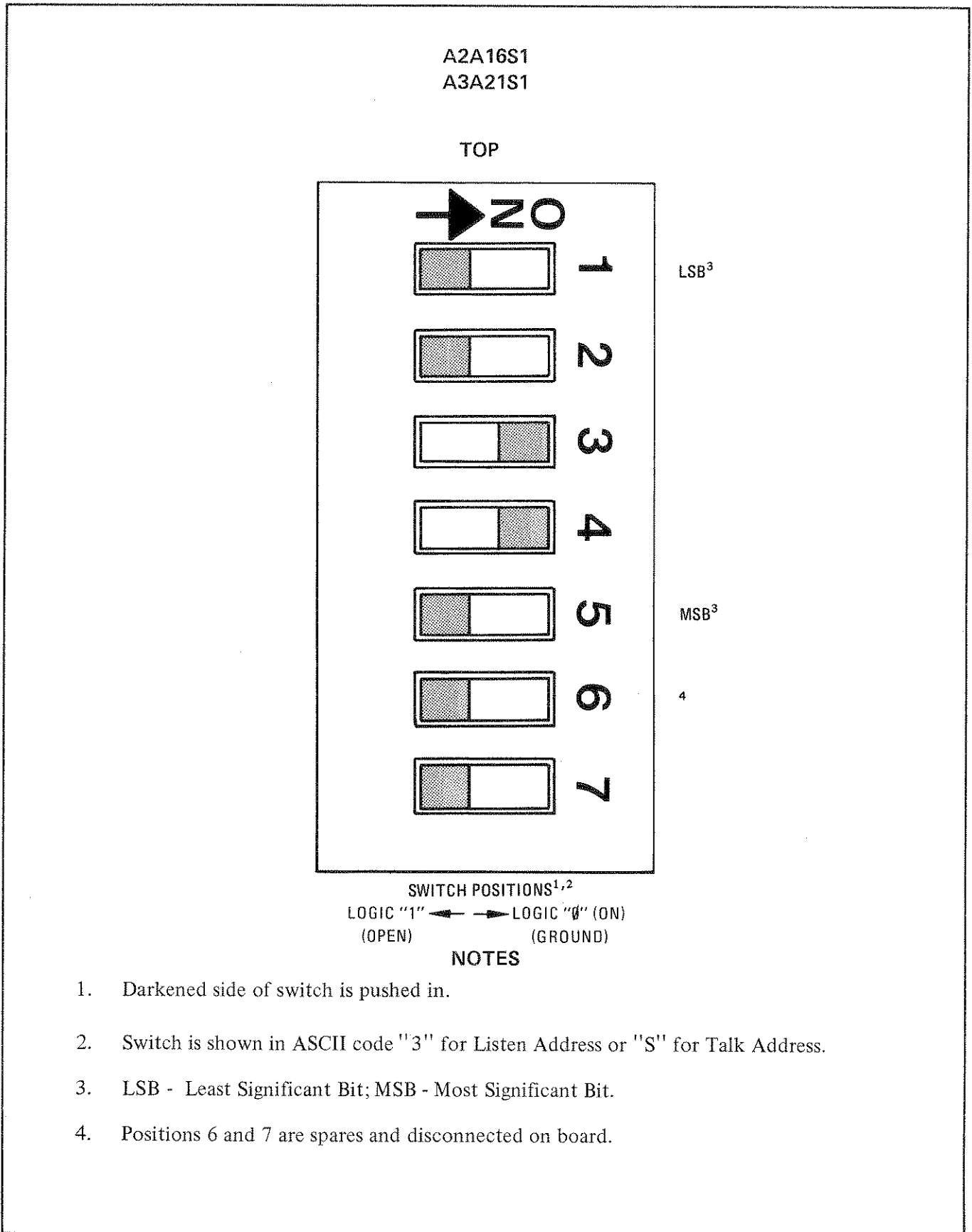

Figure A2-4. HP-IB Address Switch

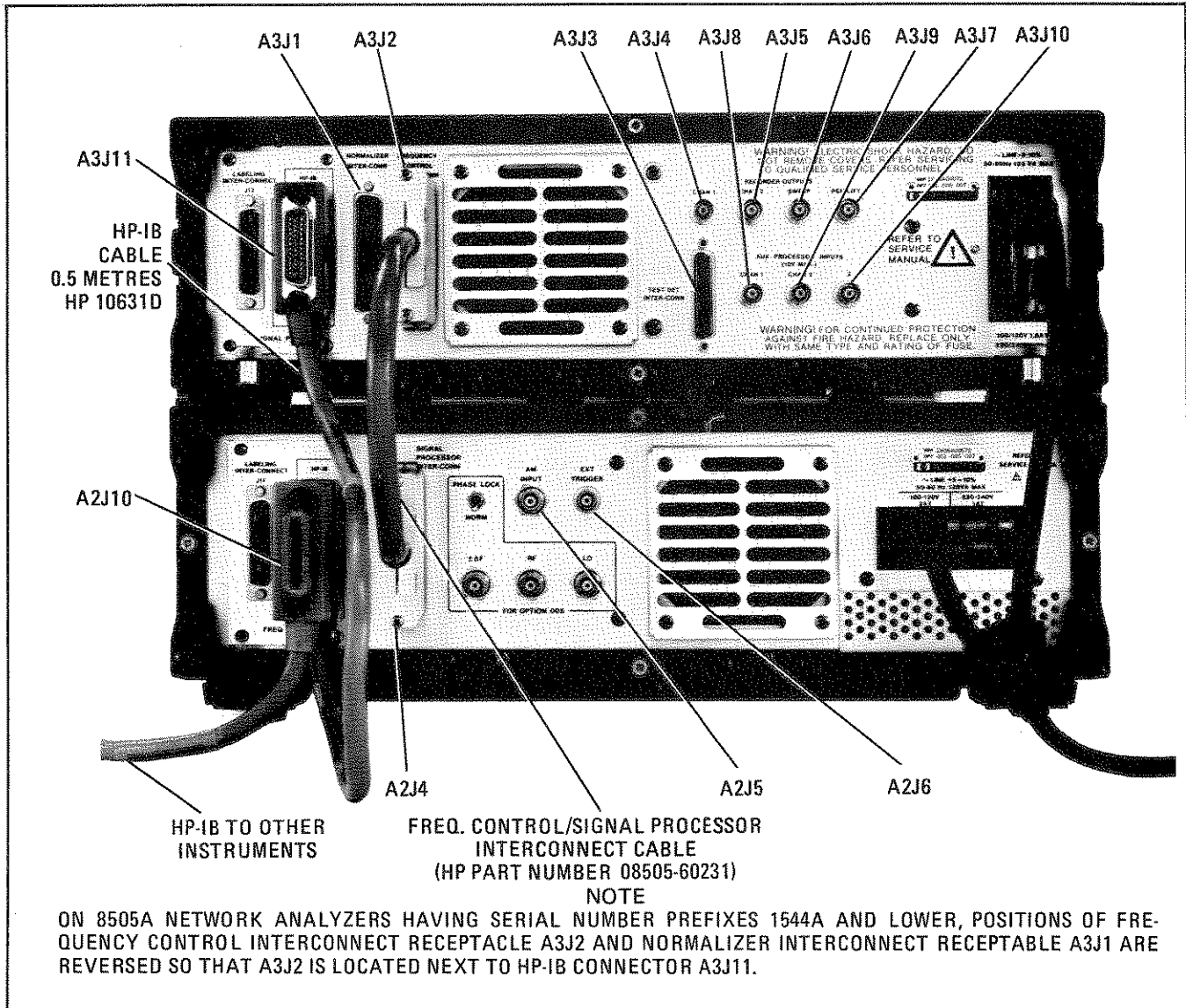

Figure A2-5. 8505A Rear Panel Connectors

A2-21. In compliance with international safety standards, this instrument is equipped with a three-wire power cable. When connected to a properly installed power line outlet, this cable grounds the 8505A chassis. Figure A2-6 shows the different kinds of mains plugs available for the power cable supplied with the 8505A. The number shown under each plug is the HP part number for the 8505A power cable with that particular kind of mains plug.

A2-22. The power cable supplied with the 8505A is selected to be compatible with power line outlet sockets in the country of destination. If the cable you receive does not fit your power line outlet sockets, refer to Figure A2-6 to determine

which cable is the correct one. Order the required cable by the HP Part Number shown from the nearest Hewlett Packard office.

A2-23. Frequency Control-Signal Processor Interconnect Cable

A-24. Connect the Frequency Control-Signal Processor cable (HP Part No. 08505-60021) between FREQUENCY CONTROL INTER-CONN receptacle A3J2 and SIGNAL PROCESSOR INTER-CONN receptacle A2J4 as shown in Figure A2-5.





Plug Type	Cable HP Part Number	Plug Description	Cable Length (inches)	Cable Color	For Use In Country
250V 	8120-1351 8120-1703	Straight*BS1363A 90°	90 90	Mint Gray Mint Gray	Great Britain , Cyprus, Nigeria , Rhodesia , Singapore , So. Africa, India
250V 	8120-1369 8120-0696	Straight*NZSS198/ASC112 90°	79 87	Gray Gray	Australia , New Zealand
250V 	8120-1689 8120-1692	Straight*CEE7-Y11 90°	79 79	Mint Gray Mint Gray	East and West Europe, Saudi Arabia, United Arab Republic (unpolarized in many nations)
125V 	8120-1348 8120-1398	Straight*NEMA5-15P 90°	80 80	Black Black	United States , Canada , Japan (100 or 200V) , Mexico , Phillippines , Taiwan
	8120-1754	Straight*NEMA5-15P	36	Black	
	8120-1378 8120-1521	Straight*NEMA5-15P 90°	80 80	Jade Gray Jade Gray	
	8120-1676	Straight*NEMA5-15P	36	Jade Gray	
250V 	8120-2104	Straight*SEV1011 1959-24507 Type 12	79	Gray	Switzerland
250V 	8120-0698	Straight*NEMA6-15P			
250V 	8120-1860	Straight*CEE22-VI			
* Part number shown for plug is industry identifier for plug only. Number shown for cable is HP Part Number for complete cable including plug. E = Earth Ground; L = Line; N = Neutral					

Figure A2-6. AC Power Plug Connectors and Power Cable Part Numbers

A2-25. Hewlett-Packard Interface Bus Cables

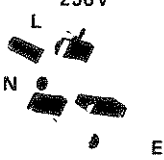
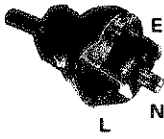
CAUTION

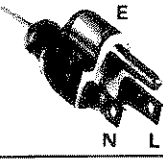
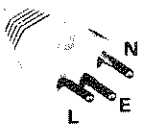
Do not mate HP-IB silver and black fasteners to each other. This device is equipped with metric thread fasteners (colored black). To avoid damaging the threads, mate only with other metric threaded devices. English threaded fasteners are colored silver.

A2-26. When the 8505A is used in automatic mode, and is being controlled through the Hewlett-Packard Interface Bus (HP-IB), the HP-IB interconnect cables are connected as follows. The 0.5 metre cable (HP 10631D) is connected between A2J10 on Frequency Control and A3J11 on Signal Processor. Another HP-IB cable is connected in "piggy-back" fashion to one of the connectors and the other end connected to the desk-top-computer, test set, or other instrument in the system. Signal lines in the HP-IB cables are identified in Figure A2-7.

A2-27. As many as 15 instruments can be connected in parallel on the Hewlett-Packard Interface bus. To achieve design performance on the bus, proper voltage levels and timing relationships must be maintained. If the system cable is too long or if

the accumulated cable length between instruments is too long, the data and control lines cannot be driven properly and the system may fail to perform. Therefore, the following restrictions must be observed:

- a. With two instruments in a system, the cable length must not exceed three meters (9 feet).
- b. When more than two instruments are connected on the bus, the cable length to each instrument cannot exceed two meters (six feet) per unit.
- c. The total cable length between all units cannot exceed 20 meters (65 feet).

A2-28. Normalizer Interconnect Cable

A2-29. When an 8501A Normalizer is used with the 8505A Network Analyzer, the Normalizer Interconnect Cable connects to NORMALIZER INTER-CONN receptacle A3J1. Signal lines in the Normalizer Interconnect Cable are identified in Figure A2-8.

A2-30. Test Set Interconnect Cable

A2-31. When an 8503A or B S-Parameter Test Set is used with the 8505A, the Test Set Interconnect

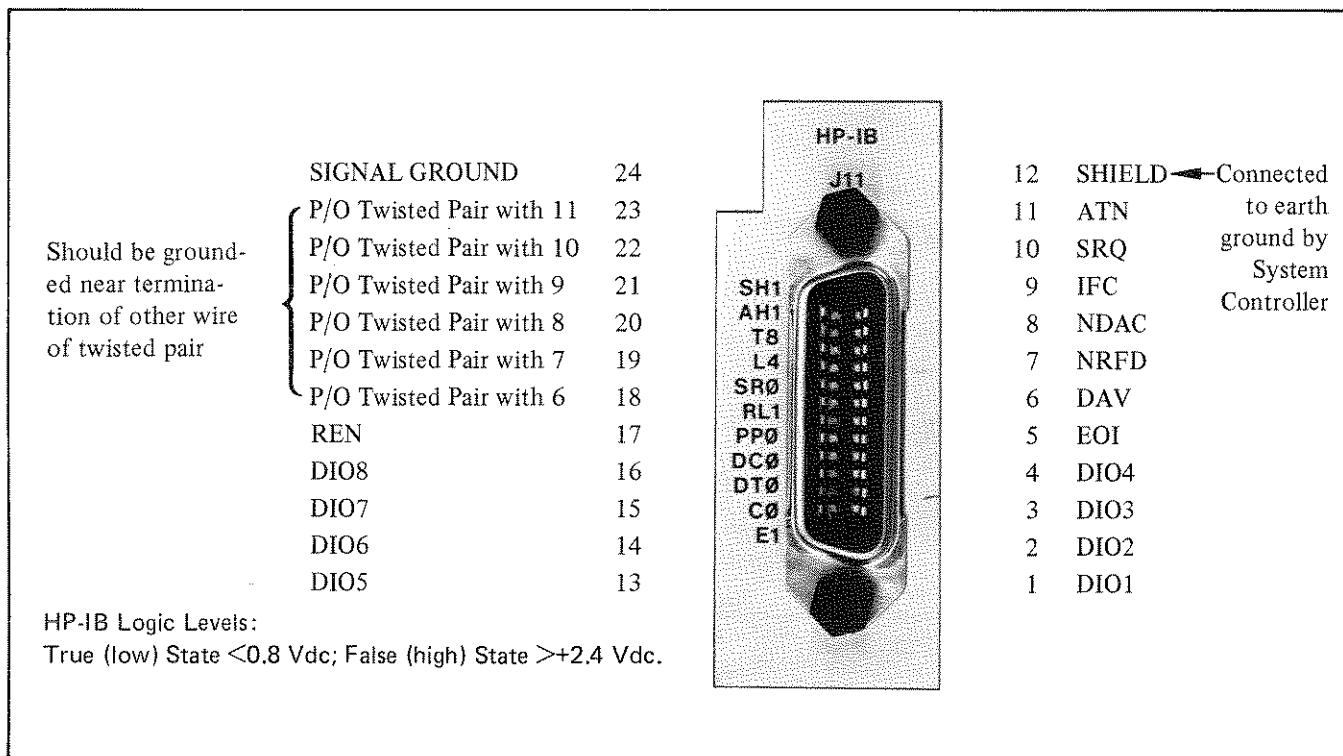

Figure A2-7. HP-IB Connectors, A2J10 and A3J11, Signals and Pin Configuration

Cable connects to TEST SET INTER-CONN receptacle A3J3. Signal lines in the Test Set Interconnect Cable are identified in Figure A2-9.

A2-32. Recorder Output Connections

A2-33. BNC connector receptacles A3J4 through A3J7 furnish channel 1, channel 2, X-axis sweep, and pen-lift outputs which can be applied to an X-Y recorder. See Table A1-2, Auxiliary outputs, for output signal characteristics. See Table A2-3 for outputs with various combination of front-panel control settings.

A2-34. Display Input Connections

A2-35. BNC connector receptacles A3J8 through A3J10 can be used to apply signals from external sources to the Signal Processor CRT display.

A2-36. AM Input Connection

A2-37. BNC connector receptacle A2J5 (AM INPUT) enables an external signal to be applied to the Source/Converter ALC control circuit to amplitude-modulate the RF signal.

A2-38. External Trigger Input Connection

A2-39. BNC connector A2J6 (EXT TRIGGER) enables the Frequency Control sweep to be triggered from an external source when the Frequency Control assembly's front-panel TRIGGER switch is set to EXT.

A2-40. PREPARATION FOR RESHIPMENT

A2-41. Original Packaging

A2-42. If you must reship the 8505A and you have not retained the original packing materials, the same kinds of containers and materials used for the original shipment can be obtained through the nearest Hewlett-Packard Sales or Service office. See Figure A2-10.

A2-43. If the instrument is being returned to Hewlett-Packard for servicing, attach a tag indicating the service required, return address, instrument model number (i.e., 8505A), and the instrument's full serial number. Mark the container or containers FRAGILE to ensure careful handling.

A3-44. In any correspondence, refer to the instrument by model number and its full serial number.

A2-45. Other Packaging Materials

A2-46. The following general instructions should be followed when repackaging with commercially available materials:

- a. Wrap the instrument in heavy paper or plastic. If you are shipping the instrument to a Hewlett-Packard Service office or center, attach a tag indicating the kind of service required, return address, model number, and full serial number.
- b. Place the wrapped instrument in a strong shipping container. A double-wall carton made of 350-pound test material is adequate.
- c. Place enough shock-absorbing material (a three-inch to four-inch layer) around all sides of the instrument to provide a firm cushion and prevent any movement of the instrument inside the container.
- d. Seal the shipping container or containers carefully and mark it or them FRAGILE to ensure careful handling.

A2-47. INCOMING INSPECTION TEST

A2-48. These procedures test the salient specifications of the instrument and should be used for incoming inspection. They functionally test all major operating modes, and test the major specifications of the instrument. If certification is required, use the more lengthy procedure in Section IV, which tests all of the detailed specifications of the instrument.

A2-49. EQUIPMENT REQUIRED

A2-50. The equipment required to perform the incoming inspection is listed in Table A2-4 and shown in Figure A2-11. If substitution is necessary for any of the equipment, the alternate models must meet or exceed the critical specifications.

(Text continued on page A2-19)

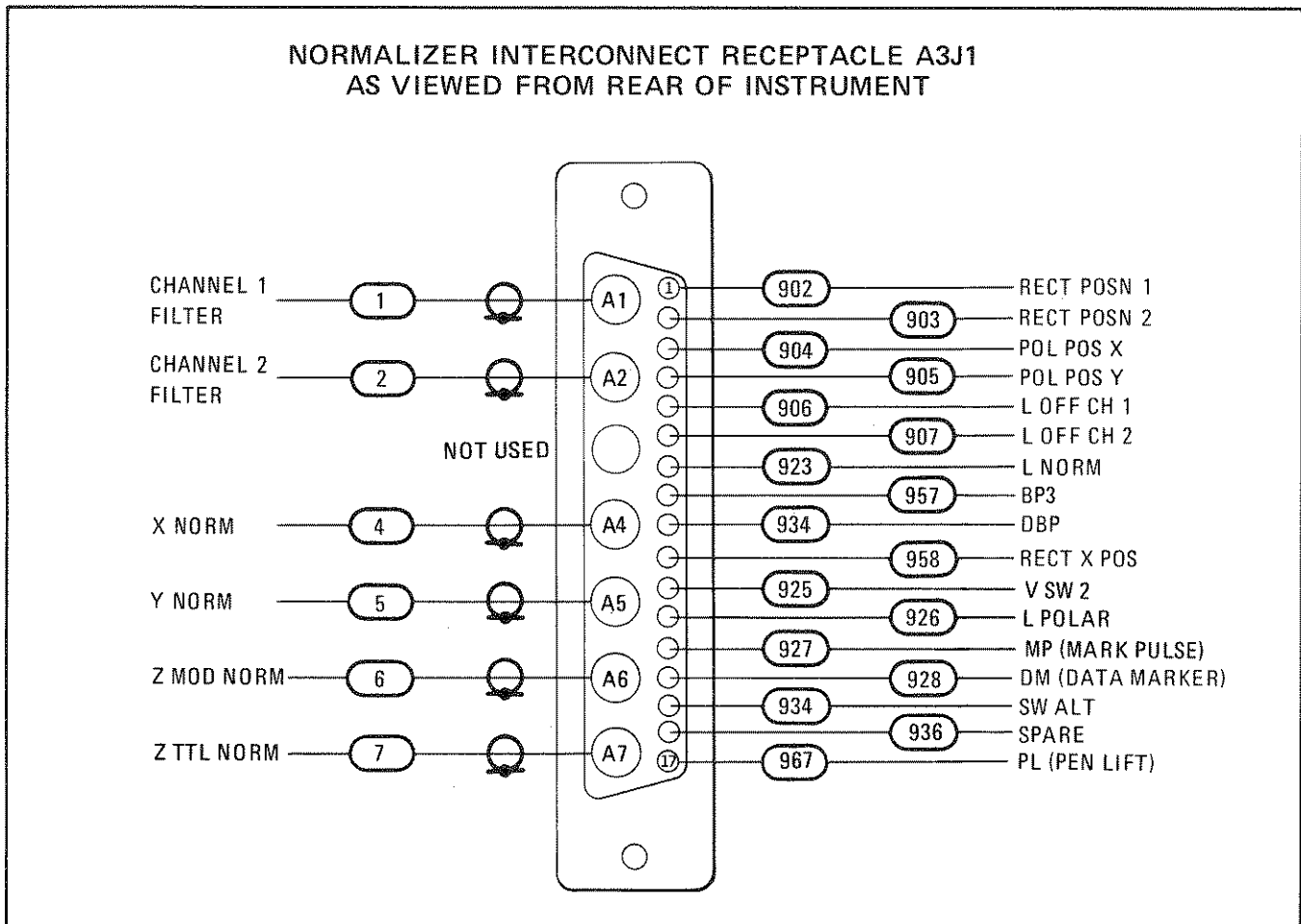

MNEMONICS TABLE

Pin	Mnemonic	Description
1	RECT POSN 1	Rectangular position, Channel 1
2	RECT POSN 2	Rectangular position, Channel 2
3	POL POS X	Display Polar Offset, X axis
4	POL POS Y	Display Polar Offset, Y axis
5	L OFF CH 1	Channel 1 on/off to Normalizer. Low = off
6	L OFF CH 2	Channel 2 on/off to Normalizer. Low = off
7	L NORM	Normalizer inputs enable. Low = inputs enable
8	BP3	Blanking Pulse 3
9	DBP	Display Blanking Pulse. High = blank
10	RECT X POS	Rectangular X Position
11	V SW 2	Sweep voltage to +13 Vdc to Signal Processor
12	L POLAR	Low polar alternate. Low = polar display
13	MARK PULSE	Marker pulse to Normalizer. High = display marker
14	DATA MARKER	Data marker. High = display marker and measure
15	SW ALT	Sweep alternate, Signal Processor to Normalizer High = Channel 1, Low = Channel 2
16	SPARE	
17	PL	Pen lift

Figure A2-8. Normalizer — 8505A Interconnecting Signal Lines and Receptacle Terminals

**TEST SET INTER-CONN (A3J3)
AS VIEWED FROM REAR OF INSTRUMENT**

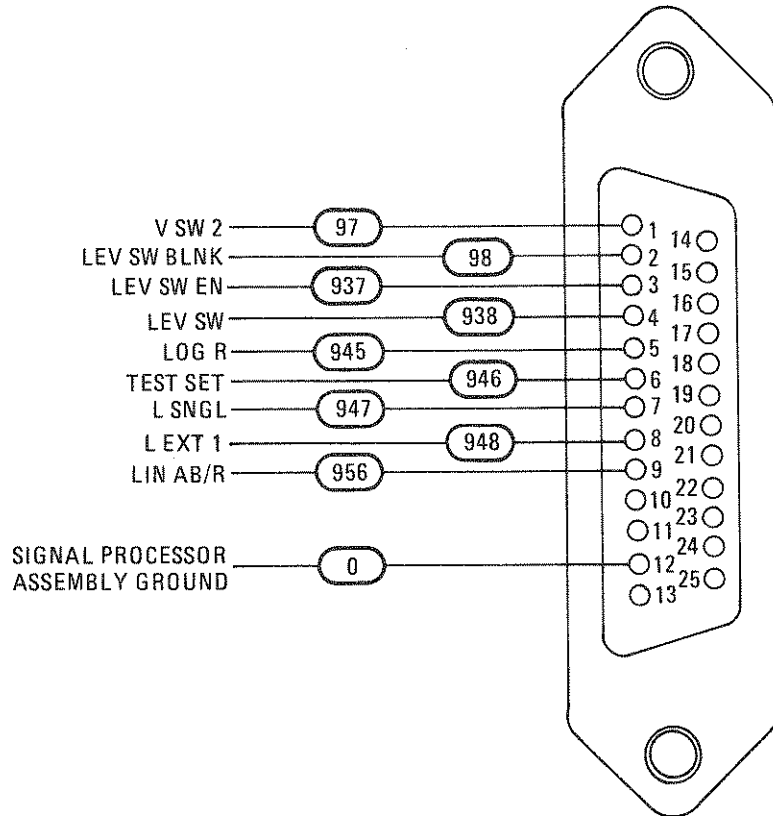

MNEMONICS TABLE

Pin	Mnemonic	Description
1	V SW 2	Sweep voltage independent of frequency or mode
2	LEV SW BLNK	Level sweep blanking
3	LEV SW EN	Level sweep enable
4	LEV SW	Level sweep
5	LOG R	Log magnitude of input R
6	TEST SET	Test Set (8503A) control line
7	L SNGL	Low Single sweep (Return to LOCAL)
8	L EXT 1	External signal control line
9	LIN AB/R	Linear ratio output of A or B over R

Figure A2-9. 8503A S-Parameter Test Set — 8505A Interconnecting Signal Lines and Receptacle Terminals

Table A2-3. Rear Panel Recorder Outputs with Combinations of Front-Panel Settings

Channel 1 MODE	OFF		MAG A or MAG A/R		MAG B or MAG B/R		MAG R		PHASE A/R or DELAY A/R		PHASE B/R or DELAY B/R		POLAR A/R or POLAR B/R		
Channel 2 MODE	OFF														
Consecutive Sweep Number*	1	2	1	2	1	2	1	2	1	2	1	2	1	2	
Rear Panel RECORDER OUTPUTS	CH1	∅	∅	Y1	Y1	Y1	Y1	Y1	Y1	Y1	Y1	Y1	Y1	Y1P	Y1P
	CH2	∅	∅	∅	∅	∅	∅	∅	∅	∅	∅	∅	∅	X1P	X1P
	SWR	X	X	X	X	X	X	X	X	X	X	X	X	X1P	X1P
Channel 2 MODE	MAG A or MAG A/R														
Rear Panel RECORDER OUTPUTS	CH1	∅	∅	Y1	Y1	Y1	∅	Y1	Y1	Y1	Y1	Y1	∅	Y1P	∅
	CH2	Y2	Y2	Y2	Y2	∅	Y1	Y2	Y2	Y2	Y2	∅	Y2	X1P	Y2
	SWP	X	X	X	X	X	X	X	X	X	X	X	X	X1P	X
Channel 2 MODE	MAG B or MAG B/R														
Rear Panel RECORDER OUTPUTS	CH1	∅	∅	Y1	∅	Y1	Y1	Y1	Y1	Y1	∅	Y1	Y1	Y1P	∅
	CH2	Y2	Y2	∅	Y2	Y2	Y2	∅	Y2	∅	Y2	Y2	Y2	X1P	Y2
	SWP	X	X	X	X	X	X	X	X	X	X	X	X	X1P	X
Channel 2 MODE	MAG R														
Rear Panel RECORDER OUTPUTS	CH1	∅	∅	Y1	Y1	Y1	∅	Y1	Y1	Y1	Y1	Y1	∅	Y1P	∅
	CH2	Y2	Y2	Y2	Y2	Y2	Y2	Y2	Y2	Y2	Y2	Y2	Y2	X1P	Y2
	SWP	X	X	X	X	X	X	X	X	X	X	X	X	X1P	X
Channel 2 MODE	PHASE A/R or DELAY A/R														
Rear Panel RECORDER OUTPUTS	CH1	∅	∅	Y1	Y1	Y1	∅	Y1	Y1	Y1	Y1	Y1	∅	Y1P	∅
	CH2	Y2	Y2	Y2	Y2	∅	Y2	Y2	Y2	Y2	Y2	∅	Y2	X1P	Y2
	SWP	X	X	X	X	X	X	X	X	X	X	X	X	X1P	X
Channel 2 MODE	PHASE B/R or DELAY B/R														
Rear Panel RECORDER OUTPUTS	CH1	∅	∅	Y1	∅	Y1	Y1	Y1	Y1	Y1	∅	Y1	Y1	Y1P	∅
	CH2	Y2	Y2	∅	Y2	Y2	Y2	∅	Y2	∅	Y2	Y2	Y2	X1P	Y2
	SWR	X	X	X	X	X	X	X	X	X	X	X	X	X1P	X
Channel 2 MODE	POLAR A/R or POLAR B/R														
Rear Panel RECORDER OUTPUTS	CH1	Y2P	Y2P	Y1	Y2P	Y1	Y2P	Y1	Y2P	Y1	Y2P	Y1	Y2P	Y1P	Y2P
	CH2	X2P	X2P	∅	X2P	∅	X2P	∅	X2P	∅	X2P	∅	X2P	X1P	X2P
	SWR	X2P	X2P	X	X2P	X	X2P	X	X2P	X	X2P	X	X2P	X1P	X2P

*Recorder outputs are multiplexed between channel 1 and channel 2 for certain combinations of mode and input settings. This causes the outputs to change on alternate sweeps from channel 1 to channel 2. If the entries in the table for 1 and 2 are the same, the outputs are the same for each sweep. However, if the entries are different for 1 and 2, the outputs are different for alternate sweeps.

Abbreviations:

- X = Rectangular X, both channels
- X1P = Polar X, channel 1
- X2P = Polar X, channel 2
- Y1 = Rectangular Y, channel 1
- Y2 = Rectangular Y, channel 2
- Y1P = Polar Y, channel 1
- Y2P = Polar Y, channel 2
- ∅ = Invalid Output

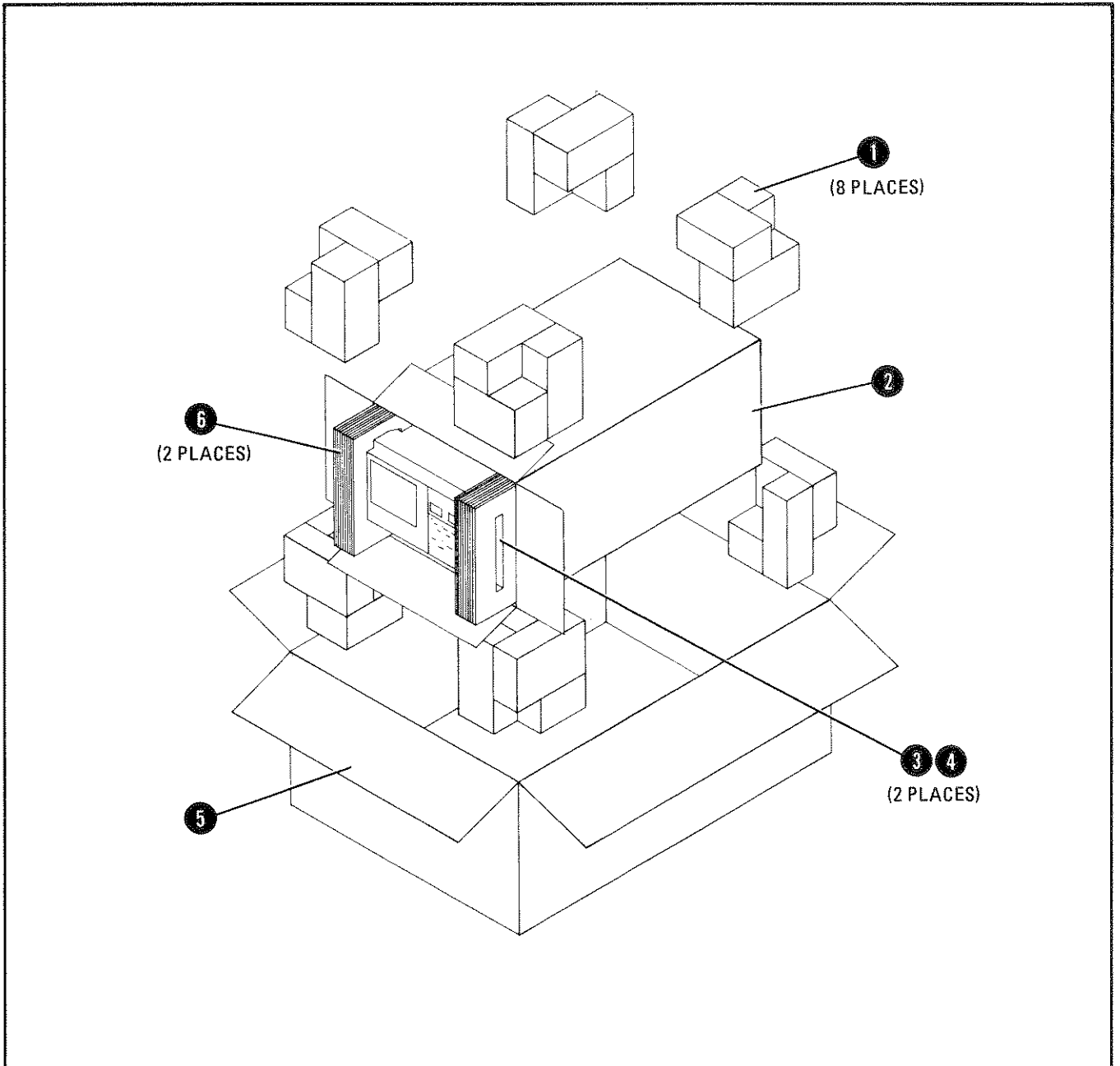

Item	Qty	HP Part No.	Description
1	16	9220-2732	FOAM PADS—TOP, CORNER; BOTTOM CORNER
2	2	9211-2729	CARTON—INNER
3	4	5021-1722	BARS—SHIPPING, ALUMINUM
4	8	2510-0061	SCREW—FOR ATTACHING SHIPPING BARS
5	2	9211-2730	CARTON—OUTER
6	4	9220-2775	SIDE PADS, CORRUGATED CARDBOARD

NOTE: Quantities given are for two containers.

Figure A2-10. Packaging for Shipment Using Factory Packaging Materials

Table A2-4. List of Equipment Required for Incoming Inspection Test

Instrument	Critical Specifications	Recommended Model
Electronic Counter	Frequency Range: to 10 MHz Accuracy: ± 1 count Sensitivity: -5 dBm	HP 5340A
Power Meter and Sensor	Power Range: $+10$ to -20 dBm Frequency Range: 0.5 to 1300 MHz Accuracy: ± 0.5 dB at 1300 MHz	HP 435A/8482A
0 – 110 dB Step Attenuator	Attenuation: 0 to 110 dB in 10 dB increments Frequency: Calibrated at 30 MHz SWR: < 1.5 Connectors: Type N Male	HP 8496A
3-Way Power Splitter	Impedance: 50 Ohms Frequency Range: 0.5 to 1300 MHz Connectors: Type N Female Frequency Response: Input to output $\leq \pm 0.2$ dB	HP 11850A
Matched Coaxial Cables (Set of 3)	50-ohm double-shielded coaxial cables 61 cm (24 inches) long, phase matched to 4° at 1300 MHz Connectors: Type N Male	HP 11851A
50-Ohm Termination (3 Required)	Frequency Range: 0.5 – 1300 MHz Impedance: 50 Ohms Connectors: Type N Male SWR: < 1.4	HP 909A Option 012
Type-N to BNC Adapter (2 required)		HP 1250-0780
15.24 plus Meters (50 plus feet) of Coaxial Cable	50-ohm type RG 223/U coaxial cable with BNC male connectors on both ends	
10 dB Attenuator	Attenuation: 10 dB ± 0.5 dB SWR: < 1.3	HP 8491B Option 010

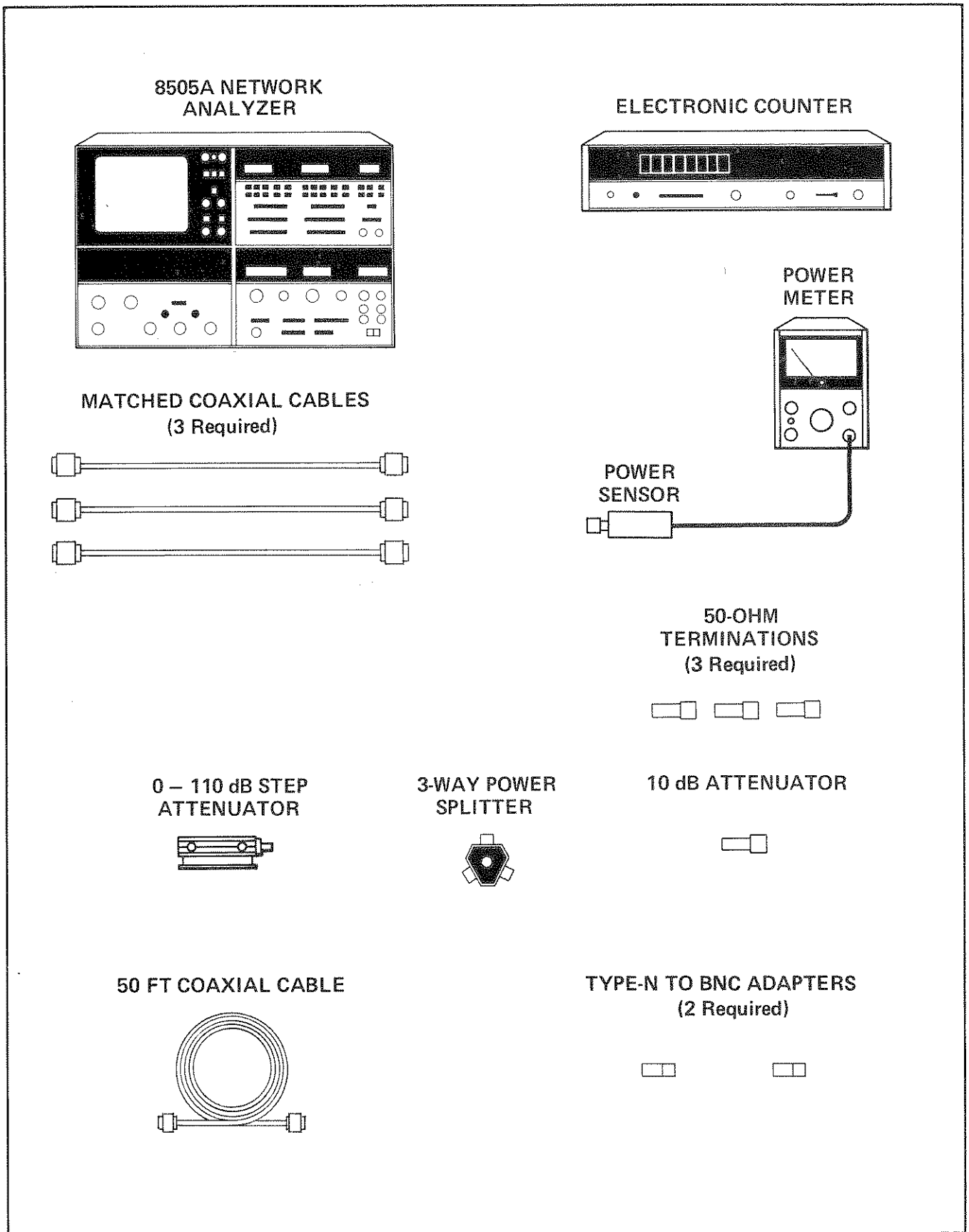

Figure A2-11. Equipment Required for Incoming Inspection Test

A2-51. FREQUENCY RANGE AND ACCURACY TEST

NOTE

Allow one hour warm-up time before making the incoming inspection.

SPECIFICATIONS:

CW Mode Accuracy ± 2 counts of LSD \pm time-base accuracy*
 Swept Frequency Accuracy: $\pm 1\%$ of range for linear sweep
 Counter Accuracy: ± 2 counts \pm time-base accuracy*

* Time-base Accuracy = 5 ppm ± 1 ppm/ $^{\circ}$ C ± 3 ppm/90 days.

DESCRIPTION:

The 8505A built-in frequency counter calibration is checked against a known good electronic counter by monitoring the CW RF signal. In CW $\pm \Delta F$ mode, the FREQUENCY READOUT is compared to the counter readout. If necessary, the CW RF signal is adjusted to match the FREQUENCY readout. This calibrates the digital FREQUENCY readout to the actual RF OUTPUT signal being read on the built-in counter. The START/STOP sweep signal frequency is measured using an external counter to monitor the frequencies with both START and STOP frequencies the same.

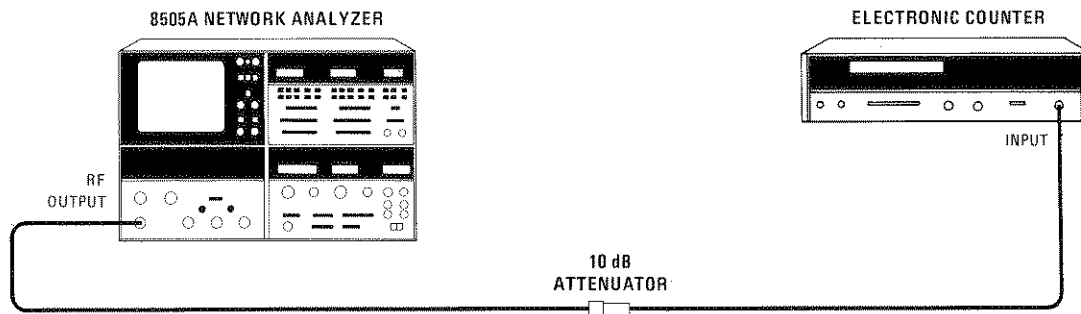

Figure A2-12. Frequency Accuracy Test Setup

EQUIPMENT:

Electronic Counter HP 5340A
 10 dB Attenuator HP 8491B Option 010

A2-51. FREQUENCY RANGE AND ACCURACY TEST (Cont'd)**PROCEDURE:***COUNTER ACCURACY*

- a. Set 8505A Controls as follows:

On A1 Source/Converter

OUTPUT LEVEL dBm -10
 OUTPUT LEVEL VERNIER 0

On A2 Frequency Control:

RANGE MHz5 — 1300
 MODE LIN EXPAND
 WIDTH CW
 SCAN TIME SEC 10 — 1
 VERNIER SCAN TIME Clockwise
 TRIGGER AUTO
 MARKERS 1
 Marker 1 Mid position

- b. Connect equipment as shown in Figure A2-12 and set external counter resolution to 100 Hz.
- c. Set CW FREQUENCY control and VERNIER control for 10.000 MHz indication on external Electronic Counter. The 8505A CW FREQUENCY digital display should indicate 0010.00 MHz ± 0.02 MHz. (If the indication is not within tolerance, the built-in counter is malfunctioning; go to troubleshooting in Chapter C.)

FREQUENCY CALIBRATION

- d. Set A2 Frequency Control WIDTH switch to CW $\pm \Delta F$.
- e. Set CW FREQUENCY to 10 MHz and set CW FREQUENCY VERNIER to 0.
- f. Set $\pm \Delta F$ FREQUENCY to 000.0, and set $\pm \Delta F$ FREQUENCY VERNIER to 0.
- g. Remove the front-panel window of A2 Frequency Control (Figure A2-13).
- h. Adjust FREQUENCY CALIBRATE (.5 — 1300 MHz) screwdriver adjustment in the middle of exposed subpanel so the FREQ COUNTER MHz reads 10.00 MHz plus or minus 2 counts of least significant digit (LSD).
- i. Reinstall the window.

SWEPT FREQUENCY ACCURACY

- j. At A2 Frequency Control, set RANGE MHz switch to .5 — 1300, MODE switch to LIN EXPAND, WIDTH switch to START/STOP 1, and SCAN TIME SEC switch to .1 — .01. Set RANGE MHz switch and START and STOP frequency as listed in Table A2-5 below and read the frequency on the internal counter.

A2-51. FREQUENCY RANGE AND ACCURACY TEST (Cont'd)

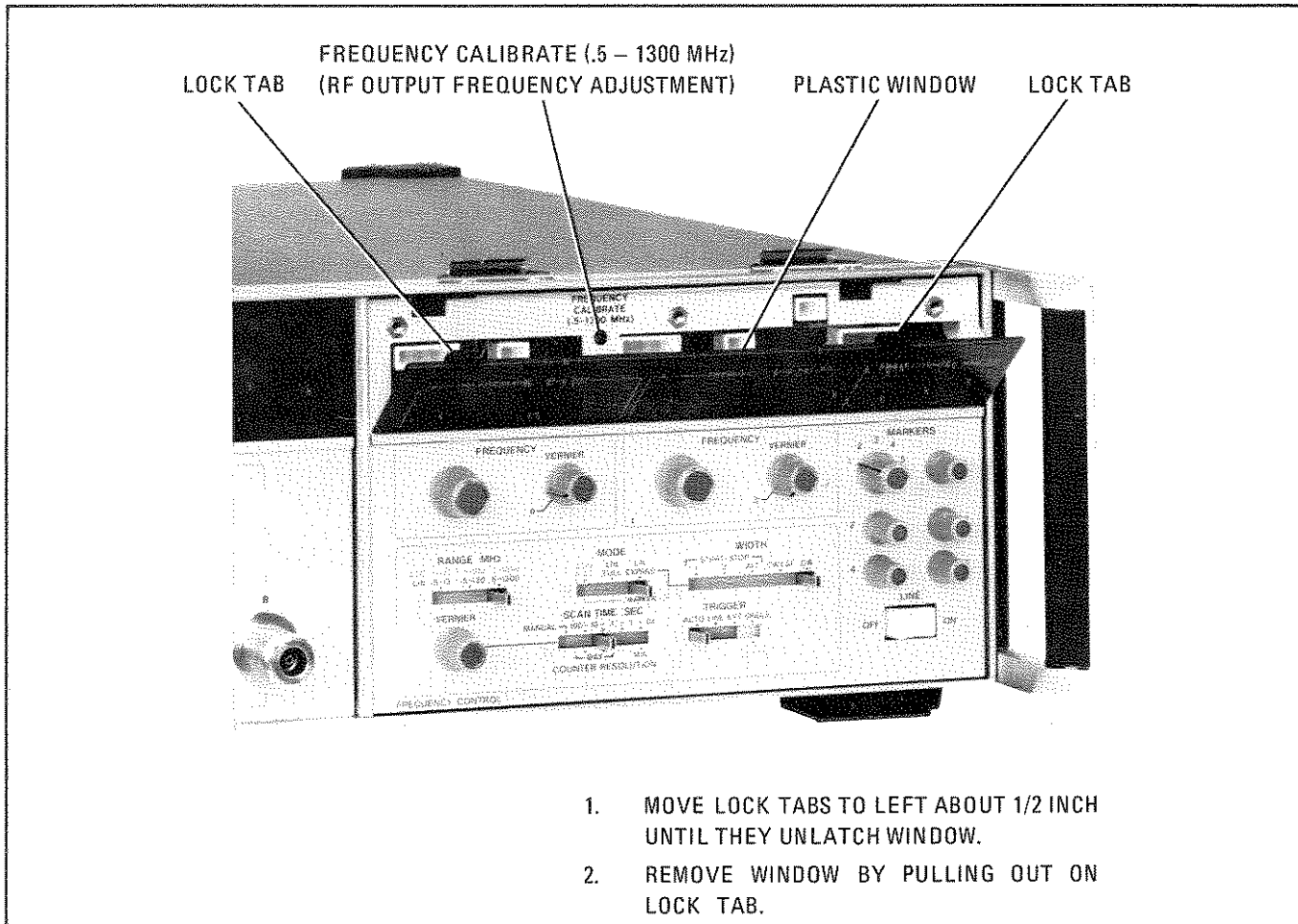

Figure A2-13. Frequency Control Front-Panel Window Removal

Table A2-5. Frequency Accuracy Table

RANGE MHz Switch Set At A2 Frequency Control	START and STOP FREQUENCY Digital Readout Set At A2 Frequency Control	Frequency Indicated On Internal Freq Counter
.5 - 1300	1300. MHz	1300 MHz ± 13 MHz
.5 - 130	130.0 MHz	130.0 MHz ± 1.3 MHz
.5 - 13	13.00 MHz	13.00 MHz ± 0.13 MHz
.5 - 1300	0100. MHz	0100. MHz ± 13 MHz
.5 - 130	010.0 MHz	010.0 MHz ± 1.3 MHz
.5 - 13	01.00 MHz	01.00 MHz ± 0.13 MHz

A-52. POWER OUTPUT LEVELING TEST AND ABSOLUTE POWER CALIBRATION

SPECIFICATION:

Power Output Range: +10 dBm to -72 dBm
 Attenuator Accuracy: ±1.5 dB over the 70 dB range
 Output Leveling: ±0.5 dB from 0.5 to 1300 MHz
 Output Level Vernier Accuracy: ±1 dB

DESCRIPTION:

The power output is measured directly with a power meter.

The power output is monitored on a power meter while the frequency band is tuned with CW FREQUENCY control. The highest and lowest power spots are noted and the total difference must be less than the specification.

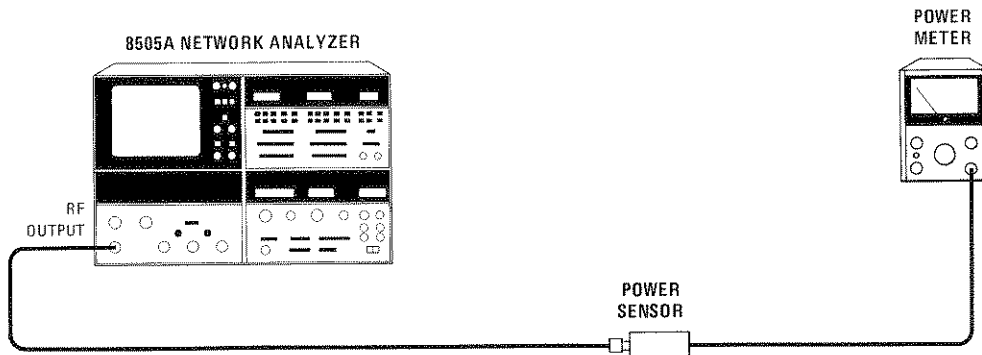

Figure A2-14. Power Output Range Test Setup

EQUIPMENT:

Power Meter HP 435A
 Power Sensor HP 8482A

PROCEDURE:

POWER OUTPUT RANGE

a. Set 8505A controls as follows:

On A1 Source/Converter:
 OUTPUT LEVEL dBm +10
 OUTPUT LEVEL Vernier 0

On A2 Frequency Control:
 RANGE MHz5 — 1300
 MODE LIN EXPAND
 WIDTH CW
 SCAN TIME SEC 1 — .1
 CW FREQUENCY MHz 30.0 MHz

A2-52. POWER OUTPUT LEVELING TEST AND ABSOLUTE POWER CALIBRATION
(Cont'd)

- b. Connect equipment as shown in Figure A2-14 and set Power Meter range to +15 dBm.
- c. Measure power output at the OUTPUT LEVEL dBm settings of +10 dBm to -20 dBm. All readings should be within ± 1.5 dB \pm tolerance of power meter. (The HP 435A/8482A power meter has an uncertainty of ± 0.4 dB.)

OUTPUT LEVEL VERNIER

- d. Set power meter to +15 dBm range. Set OUTPUT LEVEL dBm switch to +10 dBm.
- e. Turn the OUTPUT LEVEL dBm VERNIER from 0 to -12 dB position and the power meter indication should change by -12 dB ± 1 dB \pm tolerance of power meter used. (If slightly out of tolerance, go to Paragraph A5-14 for adjustment.)

POWER LEVELING

- f. While watching the power meter, turn the CW FREQUENCY control through the entire band. The total variation between the highest power and the lowest power indication across the band should be ≤ 1 dB (or ± 0.5 dB).

A2-53. CROSSTALK ISOLATION AND RECEIVER NOISE FLOOR

SPECIFICATION:

Crosstalk Error Limits: >100 dB isolation between inputs.

Noise floor in 10 kHz Bandwidth: -95 dBm (0.5 to 2 MHz)
 -100 dBm (2 to 10 MHz)
 -110 dBm (10 to 1300 MHz)

DESCRIPTION:

The noise floor is measured by offsetting the reference line -95 dB (0.5 to 2 MHz), -100 dB (2 to 10 MHz), and -110 dB (10 to 1300 MHz).

In the Crosstalk Isolation test, a signal of -10 dBm is applied to the "R" Channel input. The "A" and "B" Channels are terminated and the signal is displayed on the CRT. The displayed signal of Channel "A" should be 100 dB below the -10 dBm level of the "R" port showing isolation between ports. The other ports are checked in the same manner.

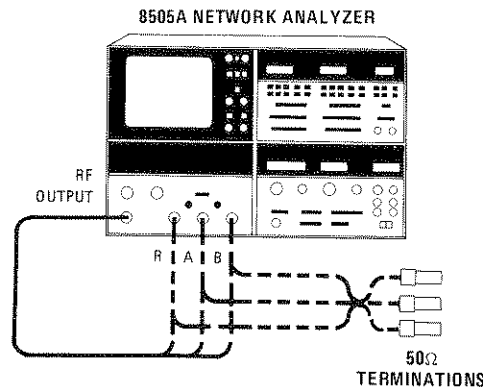

Figure A2-15. Crosstalk Isolation and Noise Floor Test Setup

EQUIPMENT:

50 Ohm Termination (3 required) HP 909A Option 012

A2-53. CROSSTALK ISOLATION AND RECEIVER NOISE FLOOR (Cont'd)

PROCEDURE:

- a. Connect equipment as shown in Figure A4-15 with the three terminations on A, B, and R ports.

- b. Set 8505A Controls as follows:

On A1 Source/Converter:

OUTPUT LEVEL dBm -60 dBm
 OUTPUT LEVEL VERNIER 0 dB
 INPUT LEVEL dBm MAX -30 dBm

On A2 Frequency Control:

RANGE MHz 0.5 - 13
 MODE LIN EXPAND
 WIDTH START/STOP 1
 START FREQUENCY 00.50 MHz
 STOP FREQUENCY 02.00 MHz
 MARKERS 1
 Marker 1 Center of CRT
 SCAN TIME SEC 10 - 1
 SCAN TIME Vernier Fully Clockwise
 TRIGGER AUTO

On A3 Signal Processor:

Channel 1

INPUT R
 MODE MAG
 SCALE/DIV 10 dB/DIV

Channel 2

MODE OFF

CRT Display

BANDWIDTH kHz 10 kHz
 VIDEO FILTER ON (in)

NOISE FLOOR FROM 0.5 to 2 MHz

- c. Connect 50-Ohm terminations to "R", "A", and "B" ports. On Signal Processor Display, press REF LINE POSN, then adjust CH1 control to place the CRT reference trace on the center graticule line. Press REF LINE POSN again for normal operation.
- d. At Channel 1, press DISPLAY REF, then CLR pushbutton until REL light goes out (if it was lit). Set INPUT switch to A, repeat above procedure, then set INPUT switch to B and repeat above procedure. Return Channel 1 INPUT switch to R position.
- e. At Channel 1, press REF OFFSET pushbuttons to obtain -95 dB offset. The CRT trace should be below the center graticule line. This shows the noise floor below -95 dBm.
- f. Set Channel 1 INPUT switch to "A". The CRT trace should be below the center graticule line.
- g. Set Channel 1 INPUT switch to "B". The CRT trace should be below the center graticule line.

A2-53. CROSSTALK ISOLATION AND RECEIVER NOISE FLOOR (Cont'd)*NOISE FLOOR FROM 2 TO 10 MHz*

- h. Set START frequency to 02.00 MHz and STOP frequency to 10.00 MHz. At Channel 1, press DISPLAY REF, then REF OFFSET pushbuttons to obtain -100 dB offset. The CRT trace should be below the center graticule line. This shows the noise floor below -100 dBm.
- i. Set Channel 1 INPUT switch to "A". The CRT trace should be below the center graticule line.
- j. Set Channel 1 INPUT switch to "R". The CRT trace should be below the center graticule line.

NOISE FLOOR FROM 10 TO 1300 MHz

- k. Set RANGE MHz switch to .5 - 1300 MHz. Set START frequency to 0010 MHz and STOP frequency to 1300 MHz. At Channel 1, press DISPLAY REF, then REF OFFSET pushbuttons to obtain -110 dB offset. The CRT trace should be below the center graticule line. This shows the noise floor below -110 dBm.
- l. Set Channel 1 INPUT switch to "A". The CRT trace should be below the center graticule line.
- m. Set Channel 1 INPUT switch to "B". The CRT trace should be below the center graticule line.

CROSSTALK ISOLATION

- n. On A1 Source/Converter, set INPUT LEVEL dBm MAX to -10 dBm.
- o. Connect equipment as shown in Figure A2-15, with RF OUTPUT cable connected to "R" input and the two 50-Ohm terminations to "A" and "B" input ports. Set OUTPUT LEVEL dBm switch to -10 dBm.
- p. At Channel 1, press DISPLAY REF, then REF OFFSET pushbuttons to obtain -110 dB of offset. Set INPUT switch to "A". The CRT trace should be below the center graticule line for 100 dB of isolation.
- q. At Channel 1, set INPUT switch to "B" and the CRT trace should be below the center graticule line.
- r. Move the RF OUTPUT cable to "A" input port and connect the two 50-Ohm terminations to "R" and "A" input ports. Set INPUT switch to "R" and the CRT trace should be below the center graticule line for 100 dB of isolation.
- s. At Channel 1, set INPUT switch to "A" and the CRT trace should be below the center graticule line.

A2-54. MAGNITUDE DYNAMIC ACCURACY TEST

SPECIFICATION:

Magnitude Dynamic Accuracy: $\leq \pm 0.01$ dB/dB from -20 to -40 dBm
 $\leq \pm 0.2$ dB from -10 to -50 dBm
 $\leq \pm 0.5$ dB from -50 to -70 dBm
 $\leq \pm 1$ dB from -70 to -90 dBm
 $\leq \pm 2$ dB from -90 to -100 dBm
 $\leq \pm 4$ dB from -100 to -110 dBm

DESCRIPTION:

The signal level into the receiver is adjusted by setting the external step attenuator. The signal trace is monitored on the CRT and deviation from the expected position of the trace on the graticule is noted.

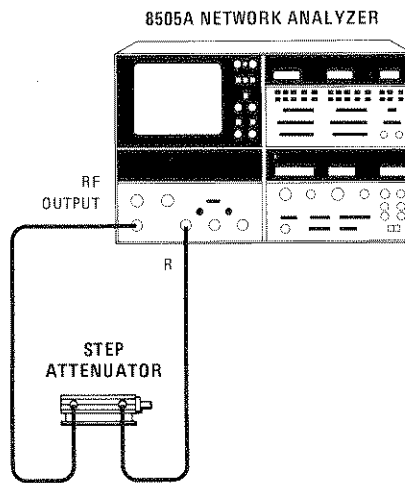

Figure A2-16. Dynamic Range Test Setup

EQUIPMENT:

0 — 110 dB STEP ATTENUATOR
 (calibrated at 30 MHz) HP 8496A

PROCEDURE:

a. On 8505A, set the controls as follows:

On A1 Source/Converter:
 OUTPUT LEVEL dBm 0
 OUTPUT LEVEL Vernier 0
 INPUT LEVEL dBm MAX -10

On A2 Frequency Control:
 RANGE MHz5 — 13
 MODE LIN EXPAND
 WIDTH CW
 CW FREQUENCY 30.0 MHz

A2-54. MAGNITUDE DYNAMIC ACCURACY TEST (Cont'd)

On A3 Signal Processor:

Channel 1
 INPUT R
 MODE MAG
 SCALE/DIV5 dB

Channel 2
 MODE OFF

Electrical Length
 MODE OFF

Display Section
 BANDWIDTH KHz 10 kHz ON (in)
 REF LINE POSN Ref line to center graticule line
 VIDEO FILTER ON (in)

- b. Connect equipment as shown in Figure A2-16.
- c. Set step attenuator to 30 dB. Press Channel 1 DISPLAY MKR, then ZRO push-buttons until trace settles. Press CHAN 1 DISPLAY REF pushbutton. As attenuator is stepped down, offset -10 dB/step with Channel 1 REF OFFSET pushbutton to bring trace back to reference line within limits shown in Table A2-6. (It may be necessary to change CHAN 1 SCALE/DIV to a less sensitive setting if trace is off screen.)
- d. Repeat step c with attenuator connected to "A" input and Channel 1 INPUT switch to "A".
- e. Repeat step c with attenuator connected to "B" input and Channel 1 INPUT switch to "B".

Table A2-6. Dynamic Accuracy Table

External Attenuator Setting	Channel 1 REF OFFSET	OFFSET from REF LINE (Plus attenuator tolerance)
10 dB	+20.0 dB	± 0.20 dB
20 dB	+10.0 dB	± 0.1 dB
30 dB	0 dB	± 0.00 dB
40 dB	-10.0 dB	± 0.1 dB
50 dB	-20.0 dB	± 0.2 dB
60 dB	-30.0 dB	± 0.4 dB
70 dB	-40.0 dB	± 0.6 dB
80 dB	-50.0 dB	± 0.8 dB
90 dB	-60.0 dB	± 1 dB
100 dB	-70.0 dB	± 2 dB
110 dB	-80.0 dB	± 4 dB

A2-55. PHASE DYNAMIC RANGE

SPECIFICATION:

Phase Dynamic Accuracy (in 10 kHz Bandwidth):
 ±0.02 degree/dB from -20 to -40 dBm
 ±0.5 degree from -10 to -50 dBm
 ±1 degree from -50 to -70 dBm
 ±3 degrees from -70 to -90 dBm

DESCRIPTION:

A phase reference level is established on the CRT. Then the signal at the receiver is changed through the dynamic range of the instrument and the change in phase indication is noted.

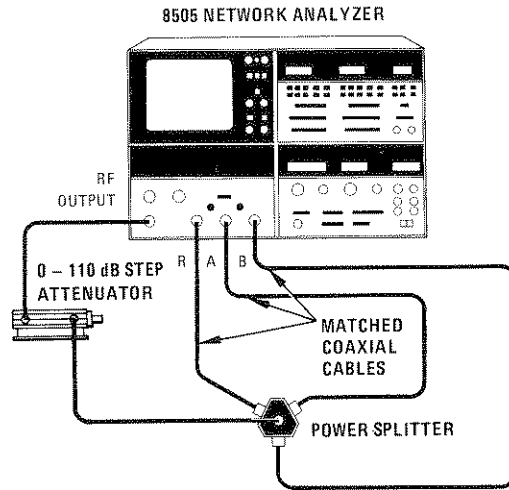

Figure A2-17. Phase Dynamic Range Test Setup

EQUIPMENT:

RF Cable Kit	HP 11851A
3-Way Power Splitter	HP 11850A
Step Attenuator, 0 - 110 dB	HP 8496A

PROCEDURE:

a. On 8505A, set controls as follows:

- On A1 Source/Converter
 - OUTPUT LEVEL dBm +10
 - OUTPUT LEVEL VERNIER 0
 - INPUT LEVEL dBm MAX -10
- On A2 Frequency Control:
 - RANGE MHz 5 - 130
 - MODE LIN EXPAND
 - WIDTH CW ± ΔF
 - SCAN TIME SEC1 - .01
 - CW FREQUENCY 30 MHz
 - ±ΔF FREQUENCY 00.0
 - MARKERS 1
 - Marker 1 Center of CRT screen

A2-56. MAGNITUDE, PHASE, AND GROUP DELAY FREQUENCY RESPONSE (Cont'd)

frequency response in group delay mode is read directly from the CRT trace by noting the deviation from the center graticule reference.

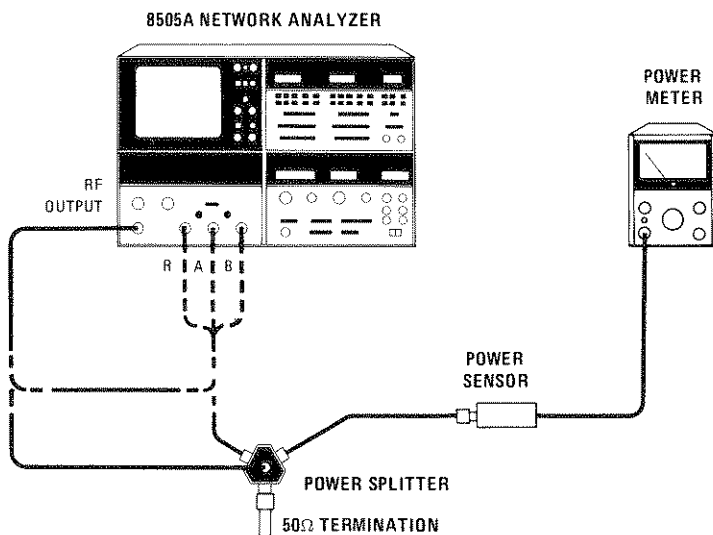

Figure A2-18. Absolute Magnitude Frequency Response Test Setup

EQUIPMENT:

- Power Meter HP 435A
- Power Sensor HP 8482A
- Three-Way Power Splitter HP 11850A
- 50-Ohm Termination HP 909A Option 012

PROCEDURE:

ABSOLUTE MAGNITUDE FREQUENCY RESPONSE

a. On 8505A, set the controls as follows:

- On A1 Source/Converter:
 - OUTPUT LEVEL dBm -10
 - OUTPUT LEVEL VERNIER -10
 - INPUT LEVEL dBm MAX -10

- On A2 Frequency Control:
 - RANGE MHz 0.5 — 1300
 - MODE LIN FULL
 - WIDTH START/STOP 1
 - SCAN TIME SEC 1 — .1
 - SCAN TIME VERNIER Midrange

NOTE

It may be necessary to make slight adjustment at 0.50 MHz of Frequency Calibrate pot behind FREQUENCY CONTROL front panel. (See paragraph A2-51, steps d through i.)

- MARKERS 1
- Marker 1 Midrange

**A2-56. MAGNITUDE, PHASE, AND GROUP DELAY FREQUENCY RESPONSE
(Cont'd)**

On A3 Signal Processor:

```

Channel 1
  INPUT..... R
  MODE..... MAG
  SCALE/DIV ..... 0.5 dB/DIV

Channel 2
  MODE..... OFF

CRT Display
  REF LINE POSN ..... Center Graticule Line
  BW ..... 10 kHz On (in)
  VIDEO FILTER ..... Off (out)

```

- b. Connect equipment as shown in Figure A2-18 with "R" INPUT cable connected directly to RF OUTPUT connector.
- c. Press DISPLAY CLR, MKR, then ZRO pushbuttons. Observe the highest and lowest point on the CRT trace between 0.5 and 1300 MHz. They should not be greater than 3 dB difference. If the CRT trace is within tolerance, go to step h and check "A" input port. If "A" port has been checked, go to step i and check "B" input port. If the CRT trace is out of tolerance, go to step d and cancel the affect of the RF source variations to see if the receiver section is actually within tolerance.
- d. Connect equipment as shown in Figure A2-18 with RF OUTPUT to center of Power Splitter and one leg of power splitter to port "R" and the other leg to Power Sensor and Power Meter.
- e. Set Marker 1 to the point on CRT trace that is maximum. Note Marker reading and Power Meter reading.
- f. Set Marker 1 to the point on CRT trace that is minimum. Adjust OUTPUT LEVEL VERNIER and step attenuator to set Power Meter to the same indication noted in step e.
- g. The difference between the Marker indication noted in step e and the displayed marker reading in step f should be ≤ 3 dB.
- h. Disconnect RF Cable from "R" INPUT and connect to "A" INPUT. Set Signal Processor Channel 1 INPUT switch to A. Repeat preceding step c and observe the power level variations for "A" INPUT.
- i. Disconnect RF Cable from "A" INPUT and connect to "B" INPUT. Set Signal Processor Channel 1 INPUT switch to B. Repeat preceding step c and observe the power level variations for "B" INPUT.

A2-56. MAGNITUDE, PHASE, AND GROUP DELAY FREQUENCY RESPONSE (Cont'd)

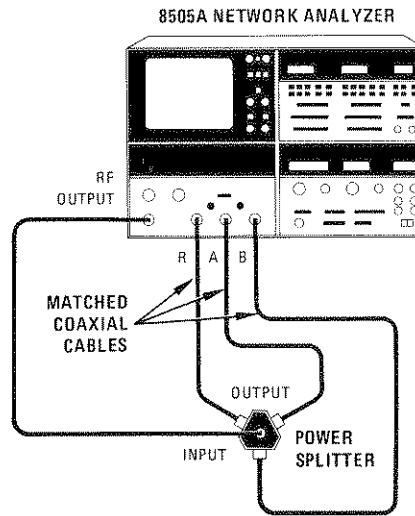

Figure A2-19. Ratio Frequency Response Test Setup

EQUIPMENT:

Three-way POWER SPLITTER	HP 11850A
Matched Cable Kit	HP 11851A

RATIO MEASUREMENT MAGNITUDE FREQUENCY RESPONSE

- j. Connect equipment as shown in Figure A2-19 with the power splitter connected to "R", "A", and "B" inputs and Power Meter disconnected from setup.
- k. On A2 Frequency Control, set RANGE MHz switch to 0.5 — 1300 MHz position, set MODE to LIN FULL, WIDTH to START/STOP 1, SCAN TIME SEC to 1 — .1, and TRIGGER to AUTO. Set MARKERS switch to 1 position and Marker 1 control to approximately 640 MHz.
- l. On A3 Signal Processor, set CHANNEL 1 INPUT switch to A/R, set MODE to MAG, set SCALE/DIV switch to 0.1 dB position and set VIDEO FILTER off (out). Press DISPLAY MKR, then ZRO pushbutton.
- m. On A2 Frequency Control, adjust MARKER 1 frequency control between 0.5 MHz (left end of CRT trace) and 1300 MHz (right end of CRT trace). Note the highest and lowest reading on the Signal Processor Channel 1 readout. The difference between the highest and lowest reading (peak-to-peak variation due to frequency response) should be ≤ 0.6 dB.
- n. Set Signal Processor Channel 1 INPUT switch to B/R. Press DISPLAY MKR, then ZRO pushbuttons. Repeat preceding step m.

A2-56. MAGNITUDE, PHASE, AND GROUP DELAY FREQUENCY RESPONSE (Cont'd)*PHASE MEASUREMENT FREQUENCY RESPONSE*

- o. Set MODE to LIN EXPAND, WIDTH to START/STOP 1, MARKERS switch to 1 position, and Marker 1 control to mid-position. Set START to 0000. MHz, STOP to 0750 MHz. Set Channel 1 INPUT to B/R, MODE to PHASE, and SCALE/DIV to 2 degrees.
- p. Set WIDTH to START/STOP 2. Set START to 0750 MHz and STOP to 1300 MHz. Return WIDTH to START/STOP 1.
- q. Set ELECTRICAL LENGTH INPUT to B and MODE to LENGTH X1. Press LENGTH pushbuttons to make the overall CRT trace as horizontal as possible. (It may be necessary to press Channel 1 DISPLAY MKR, then ZRO to bring trace on CRT.)
- r. Press Channel 1 DISPLAY MKR, then ZRO pushbutton to position the trace near the center graticule line. The maximum trace deviation from the highest point to the lowest point should be ≤ 6 degrees (3 divisions). If the reading is out of tolerance, the power splitter tracking may be at fault. Check the power splitter tracking as follows. Reverse the connections to the power splitter legs, then make the phase measurements again and subtract the two readings. The difference in readings is the power splitter tracking error. Correct the original phase measurements by subtracting one-half the power splitter tracking error.
- s. Set WIDTH to START/STOP 2 for the 750 to 1300 MHz range. The trace deviation should be ≤ 10 degrees (5 divisions).
- t. Repeat steps o through s for A/R measurement. Set all switches the same, except set Channel 1 INPUT switch to A/R in step o and set ELECTRICAL LENGTH INPUT switch to A in step q.

GROUP DELAY FREQUENCY RESPONSE

- u. On A3 Signal Processor, set Channel 1 INPUT switch to A/R, MODE switch to DLY and set SCALE/DIV switch to 1 ns. Set Frequency Control MODE switch to LIN FULL.
- v. Press Electrical Length DISPLAY CLR pushbutton. Press Channel 1 DISPLAY MKR then ZRO pushbuttons to center CRT trace about center graticule line and zero digital readout.
- w. On A2 Frequency Control, adjust MARKER 1 frequency control between 0.5 and 1300 MHz and note the highest and lowest reading on the Signal Processor Channel 1 readout. The difference between the highest and the lowest reading (peak-to-peak variation due to frequency response) should be ≤ 2 ns.
- x. Repeat steps t through v for B/R measurement. Set all switches the same except set Channel 1 INPUT switch to B/R in step u.

A2-57. PHASE ACCURACY AND ELECTRICAL LENGTH TEST

SPECIFICATION:

Phase Accuracy:

- ± 0.01 degrees/degree for ± 170 degrees
- ± 0.01 degrees/degree ± 0.5 degrees for ± 180 degrees.

A2-57. PHASE ACCURACY AND ELECTRICAL LENGTH TEST (Cont'd)

Polar Accuracy:

Actual value is within less than a 3 mm circle of displayed value.

Electrical Length Accuracy: $\pm 3\%$ of reading $\pm 1\%$ of length range.

DESCRIPTION

The hysteresis loop is observed to see that the 180 degree transition occurs at precisely +180 degrees and -180 degrees. The electrical length offset is checked by inserting two phase cycles and reading the resultant Electrical Length digital readout of 720 degrees.

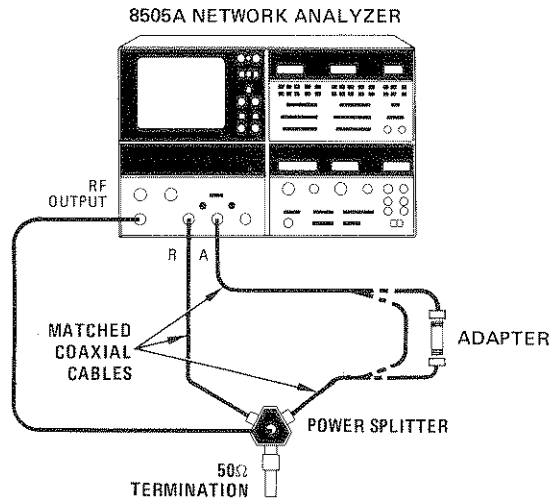

Figure A2-20. Phase Accuracy Test Setup

EQUIPMENT:

- 3-Way Power Splitter..... HP 11850A
- RF Cable Kit..... HP 11851A
- Type N Female to Type N Female Adapter..... HP 1250-0777
- 50-ohm Termination..... HP 909A Option 012

PROCEDURE:

PHASE ACCURACY TEST

a. On the 8505A, set the controls as follows:

- On A1 Source/Converter
 - OUTPUT LEVEL dBm -10
 - OUTPUT LEVEL VERNIER 0
 - INPUT LEVEL dBm MAX -10
- On A2 Frequency Control
 - RANGE MHz 0.5 — 130
 - MODE..... LIN EXPAND
 - WIDTH..... CW $\pm \Delta F$
 - CW FREQUENCY 60 MHz
 - $\pm \Delta F$ FREQUENCY..... 6.0 MHz
 - SCAN TIME SEC 0.1 — 01

A2-57. PHASE ACCURACY AND ELECTRICAL LENGTH TEST (Cont'd)

A2 Frequency Control (Cont'd)

TRIGGER..... AUTO
 MARKERS..... 1
 Marker 1..... 60 MHz

On A3 Signal Processor

Channel 1
 INPUT..... A/R
 MODE..... PHASE
 SCALE/DIV..... 90°/DIV

Channel 2
 MODE..... OFF

CRT Display

BW (Bandwidth)..... 10 kHz
 Video Filter..... Off (out)

ELECTRICAL LENGTH Panel

MODE..... OFF

- b. Connect equipment as shown in Figure A2-20 with two 24-inch matched cables connected in series between Port "A" and the 3-way power splitter.
- c. Offset the phase trace with the Channel 1 REF OFFSET pushbuttons to place a phase transition to the right of midscreen as shown in Figure A2-21.

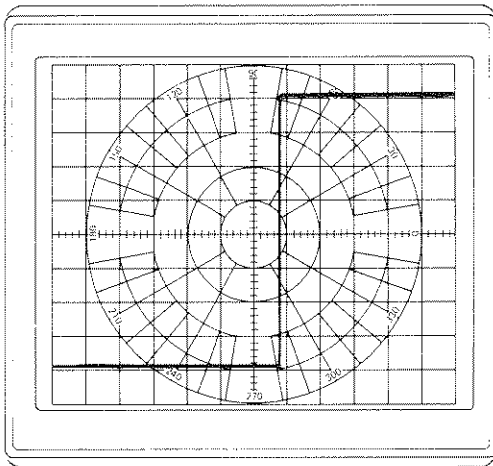

Figure A2-21. CRT Trace of Phase Transition

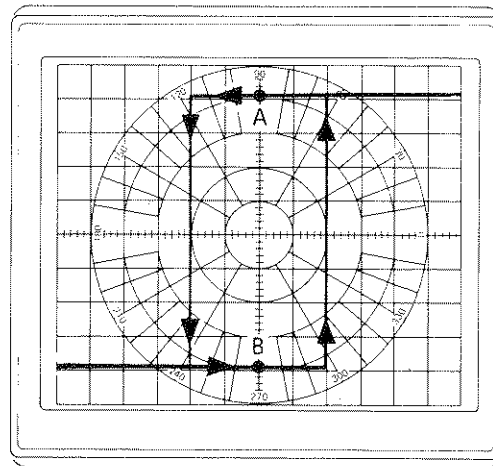

Figure A2-22. Hysteresis Loop of Phase Trace

- d. Set SCAN TIME SEC to MANUAL. Sweep through the transition in both forward and reverse direction using the Manual sweep control. Note the hysteresis loop as shown in Figure A2-22.
- e. Adjust both CW FREQUENCY and $\pm\Delta F$ FREQUENCY to make the hysteresis loop six divisions wide and centered on the vertical center line of CRT. (See Figure A2-22.)

NOTE

If either step f or g is out of tolerance, refer to Section V for adjustment of A3A12 Phase Detector.

A2-57. PHASE ACCURACY AND ELECTRICAL LENGTH TEST (Cont'd)

- f. Press Channel 1 DISPLAY MKR. Center trace dot on the vertical center line at point "A" on Figure A2-22 trace. The marker readout should be +180 degrees ±3.3 degrees.
- g. Center trace dot on the vertical center line at point "B" on Figure A2-22 trace. The Channel 1 marker readout should be -180 degrees ±3.3 degrees.

ELECTRICAL LENGTH LINE STRETCHER TEST

- h. Remove extra 24-inch cable and adapter and reconnect Port "A" to the three-way power splitter through one of the matched cables.
- i. On Frequency Control, set:
 - RANGE MHz 0.5 — 1300 MHz
 - MODE LIN EXPAND
 - WIDTH CW ±ΔF
 - ±ΔF FREQUENCY 0 MHz
 - CW FREQUENCY
(read on FREQ COUNTER MHz panel) 1000 MHz

On Signal Processor, set:

- Channel 1:
 - INPUT A/R
 - MODE POLAR MAG
 - SCALE/DIV POLAR FULL 1

CRT Display:

- BW (Bandwidth) 10 kHz On (in)
- VIDEO FILTER Off (out)

- j. At ELECTRICAL LENGTH panel, set:
 - INPUT A
 - MODE LENGTH X10
 - VERNIER A 0 (fully counterclockwise)
 - DISPLAY CLR Press and release
- k. On Channel 1, press DISPLAY MKR, then ZRO pushbuttons. Set Channel 1 MODE Switch to POLAR PHASE, then press DISPLAY ZRO. This should place the trace dot within 3 mm of the outside circle and zero degrees.
- l. Press ELECTRICAL LENGTH pushbuttons to add +30 cm length. The trace dot should move around the outside circle back to 0 degrees ±10 degrees.
- m. Set ELECTRICAL LENGTH MODE switch to LENGTH X1 position. Press ELECTRICAL LENGTH pushbuttons to read +15 cm. The trace dot should be at 180 degrees ±5 degrees. The same indication appearing on the CRT should appear on the Channel 1 digital readout.

LINEAR PHASE RANGE

- n. Set Channel 1 MODE to PHASE and SCALE/DIV to 90 degrees. On A2 Frequency Control, set SCAN TIME SEC switch to 0.1 — .01. Set ELECTRICAL LENGTH MODE switch to PHASE X10 degrees/SCAN. Press Channel 1 DISPLAY REF, then CLR and press ELECTRICAL LENGTH DISPLAY CLR.

A2-57. PHASE ACCURACY AND ELECTRICAL LENGTH TEST (Cont'd)

- o. With ELECTRICAL LENGTH offset pushbuttons, put in +1800 degrees of electrical length. (The electrical length readout displays +180.) Verify that five transitions are displayed and that the linear phase display limits over approximately the last 5% of the trace. (See Figure A2-23, Photo A.)

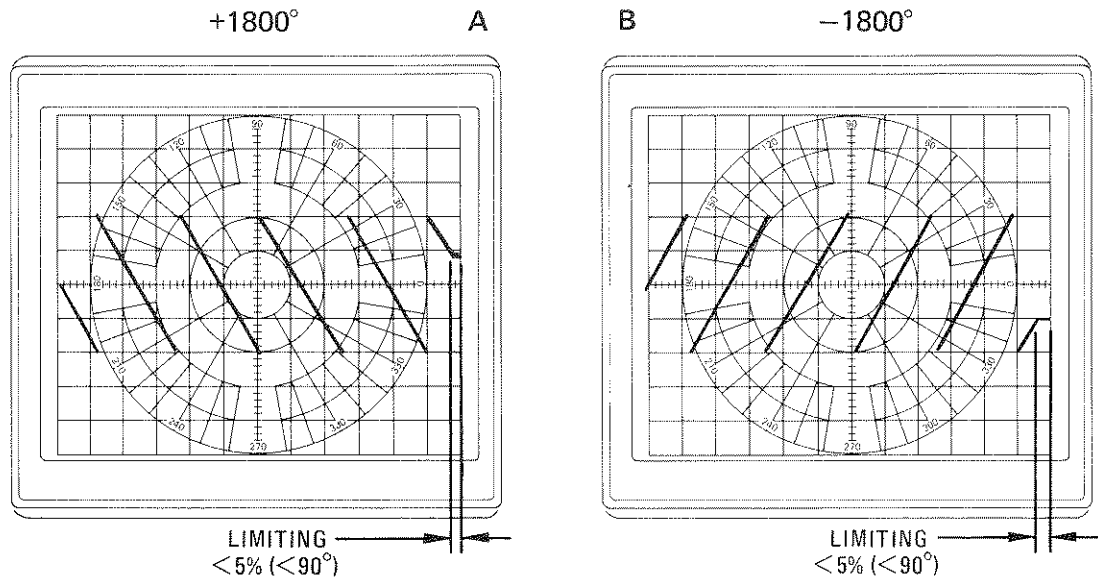

Figure A2-23. Phase Trace with Maximum Electrical Length Added

- p. Reduce electrical length with LENGTH pushbuttons until the limiting section just goes off-screen. The digital readout at ELECTRICAL LENGTH panel should be $\geq +173$ (≥ 1730 degrees).
- q. With ELECTRICAL LENGTH offset pushbuttons, put in -1800 degrees of electrical length. (The electrical length readout displays -180 .) Verify that five transitions are displayed and that the linear phase display limits over approximately the last 5% of the trace. (See Figure A2-23, photo B.)
- r. Reduce electrical length with LENGTH pushbuttons until the limiting section just goes off-screen. The digital readout at ELECTRICAL LENGTH panel should be equal to or more negative than -173 (equal to or more negative than -1730 degrees).

LINEAR PHASE ACCURACY

- s. On ELECTRICAL LENGTH panel, set MODE switch to PHASE X 10 degrees/SCAN, set VERNIER A to zero, then press DISPLAY CLR pushbutton.
- t. On Channel 1, set MODE switch to PHASE. Press DISPLAY REF, then CLR pushbuttons. Press MKR, then ZRO pushbuttons. Press DISPLAY REF, then REF OFF-SET pushbuttons to place -180 degrees of offset in Channel 1.
- u. On ELECTRICAL LENGTH panel, press LENGTH pushbutton to obtain two complete phase cycles on the CRT screen. The ELECTRICAL LENGTH digital readout should be $\pm 72 \pm 2$, corresponding to ± 720 degrees ± 20 degrees of electrical length.

A2-58. GROUP DELAY ACCURACY TEST

SPECIFICATIONS:

Group Delay Accuracy: $\leq \pm 3\%$ of reading ± 1 ns for 0.5 to 1300 MHz range, or ± 10 ns for 0.5 to 130 MHz range, or ± 100 ns for 0.5 to 13 MHz range.

DESCRIPTION:

A 50-foot coaxial cable is measured for group delay using the phase function of the 8505A. The group delay mode is then used to measure the 50-foot cable to obtain a direct group delay reading.

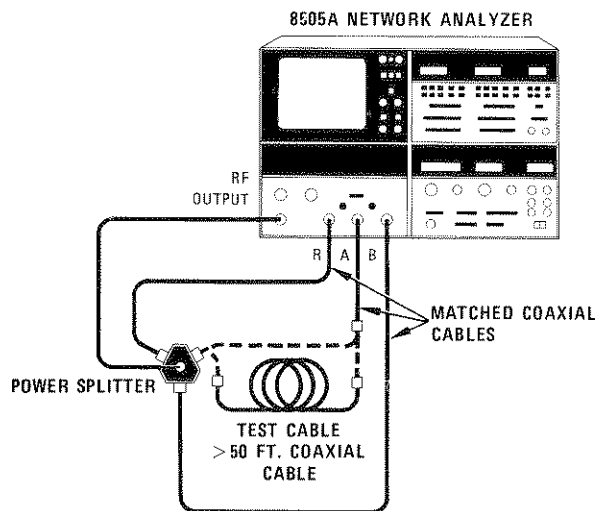

Figure A2-24. Test Setup to Measure Group Delay of Test Cable

EQUIPMENT:

- 3-Way Power Splitter HP 11850A
- Matched Type-N Coaxial Cables HP 11851A
- Test Cable ≥ 50 foot of coaxial cable
(RG-223/u or similar)
- BNC to Type-N Adapters HP 1250-0780

PROCEDURE:

- a. A coaxial cable greater than 50 feet in length is used as a standard in the group delay test. Group delay of the test cable is measured with the 8505A in phase mode as follows:
 - (1) Connect the "Test Cable" in A channel between the matched cable and the power splitter as shown in Figure A2-24.
 - (2) Set 8505A controls as follows:

On A1 Source/Converter:

- OUTPUT LEVEL dBm -10
- OUTPUT LEVEL VERNIER 0
- INPUT LEVEL dBm MAX -10

A2-58. GROUP DELAY ACCURACY TEST (Cont'd)

On A2 Frequency Control:

RANGE MHz 0.5 — 1300
 MODE LIN EXPAND
 WIDTH CW
 SCAN TIME SEC 0.1 — .01
 TRIGGER AUTO
 MARKERS 1
 SCAN TIME SEC Vernier Midrange

On A3 Signal Processor:

Channel 1
 INPUT A/R
 MODE PHASE
 SCALE/DIV 45 DEG

Channel 2
 MODE OFF

Electrical Length
 INPUT A
 MODE OFF

- (3) Press Electrical Length DISPLAY CLR pushbutton. Set A2 Frequency Control CW FREQUENCY and VERNIER for 700.00 MHz. Press Channel 1 DISPLAY MKR pushbutton, then ZRO pushbutton to zero the digital readout.
- (4) On A2 Frequency Control, adjust CW FREQUENCY up in frequency until the marker digital readout again indicates 0 degrees. Record frequency for use in later calculation. (NOTE: The phase change between the two zero points is 360 degrees.)

Frequency = _____ MHz

- (5) Calculate the group delay of the "Test Cable".

$$t_D = \frac{\text{(Phase change in degrees)}}{360 \times \text{(Change in Frequency in Hz)}}$$

EXAMPLE

Change in Phase = 360 degrees
 Change in Frequency = 713 MHz — 700 MHz
 = 13 MHz

$$t_D = \frac{360 \text{ degrees}}{360 (13 \times 10^6 \text{ Hz})} = \frac{1}{13 \times 10^6 \text{ Hz}}$$

= 77 ns

A2-58. GROUP DELAY ACCURACY TEST (Cont'd)

b. Connect equipment as shown in Figure A2-24 with both matched cables and adapters connected to power splitter and "test cable" not connected in circuit.

c. On 8505A, set controls as follows:

On A1 Source/Converter:

OUTPUT LEVEL dBm -10
 OUTPUT LEVEL VERNIER 0
 INPUT LEVEL dBm MAX -10

On A2 Frequency Control:

RANGE MHz 0.5 — 1300
 MODE LIN FULL
 WIDTH START/STOP 1
 SCAN TIME SEC 1 — .1
 SCAN TIME VERNIER Fully clockwise
 MARKERS 1
 Marker 1 Midrange
 TRIGGER AUTO

On A3 Signal Processor:

Channel 1

INPUT A/R
 MODE DLY
 SCALE/DIV DELAY 100 ns

Channel 2

MODE OFF

Electrical Length

INPUT A
 MODE OFF

- d. Press Electrical Length DISPLAY CLR pushbutton.
- e. Press Channel 1 DISPLAY REF pushbutton, then CLR pushbutton until REL light goes out (if it was lit). Then press MKR pushbutton.
- f. Connect "Test Cable" between adapters in the A channel. The Channel 1 digital read-out should indicate the group delay calculated for the "Test Cable" in step a (5) above $\pm (1 \text{ ns} + 3\% \text{ of reading})$.



SECTION III

OPERATING AND PROGRAMMING INSTRUCTIONS

A3-1. INTRODUCTION

A3-2. This section of the manual contains instructions showing how to make transmission and reflection measurements in both manual and automatic modes.

A3-3. Included are step-by-step instructions on manual operation supplied in Application Note 219, as well as detailed instructions for programming the 8505A in automatic mode from an external controller through the Hewlett-Packard Interface Bus (HP-IB).

A3-4. Manual Operation

A3-5. Application Note 219 is included in this section to introduce you to the various manual operating modes, and to give you a step-by-step sequence of operations to make specific measurements on a device.

A3-6. If you are interested in the operation of specific controls on the 8505A, go to Figures A3-1 through A3-4. In these figures, the function of each control is described in detail.

A3-7. Remote Operation and Programming

A3-8. The HP 8505A has a remote programming

interface using the Hewlett-Packard Interface Bus (HP-IB). All measurements that can be taken by the standard 8505A Network Analyzer can be automatically programmed and controlled remotely via the HP-IB. This provides a remote operator with the same control of the instrument as does a manual (local) operator. Remote control is maintained by a system controller (desk-top computer, etc.) that sends commands or instructions to and receives data from the 8505A using the HP-IB. The HP-IB is Hewlett-Packard's implementation of the IEEE Standard 488-1975. A complete general description of the HP-IB is provided in the manual entitled "Condensed Description of the Hewlett-Packard Interface Bus," HP Part Number 59401-90030.

A3-9. Programming information for the 8505A is given in Paragraph A3-14 and on. Specific examples are given for HPL and BASIC languages: the HP 9825A Desk-top Computer in HPL and the HP 9830A/B in BASIC. A table of HP-IB commands together with sample command statements are given in Table A3-1. A glossary of HP-IB terms is given in Table A3-7. A summary of codes to command the 8505A is given in Tables A3-2 and A3-3. Figure A3-5 gives the 8505A programming codes in pictorial form. Some programming functions require programmed time delays to allow completion of an operation. These are listed in Table A3-4.





Programming Note

8505A/0000-99

October 1979

Supersedes: none

Programming Code Summary for 8505A RF Network Analyzer

INTRODUCTION

This programming note contains a summary of the HP-IB codes used in the 8505A and their functions. It is intended for use by those familiar with both the 8505A and HP-IB programming. Refer to the 8505A Operating and Service manual for a complete explanation of the codes and functions.

ADDRESS TABLE

Instrument	Talk	Listen	Decimal
8505A Processor	P	0	16
8505A Source	S	3	19

The addresses may be changed by removing instrument covers and setting appropriate slide switches on the HP-IB circuit boards. For detailed instructions see Chapter A, Section II of the 8505A Operating and Service Manual, HP part No. 08505-90072.

DATA

The 8505A consists of two separately programmed instruments, Processor and Source.

8505A Instrument Conventions

1. Program letter codes must be uppercase, leading zeros and spaces are ignored.
2. Any controls not programmed will assume their front panel state as positioned before remote.
3. The switches are programmed using two character format.
 - a. The first character is a letter corresponding to switch name (example "R" for range).
 - b. The second character is a number corresponding to the position of the switch beginning with 1 at the left or CCW position.
 - c. Other controls have the same alpha-numeric sequence but may use a two letter code, a plus or minus sign, and up to a 5 digit number code.

Processor Programming Conventions

1. The Processor codes may be sent in any order except:
 - a. The duplicate controls for each display channel require that the following prefix codes be used.
 - "C1" for all CHANNEL 1 codes
 - "C2" for all CHANNEL 2 codes

"C3" FOR ALL ELECTRICAL LENGTH codes
"C0" for the BandWidth code

- b. Use the letter "E" to separate all "R", "O", and "D" program statements and to end the programming string.
2. The last digit programmed in REference OFFSET may not be displayed on the front panel LEDs.

Source Program Convention

1. The Source codes may be sent in any order except:
 - a. Range "R", Mode "M", and Width "W" codes should precede "FA" and "FB" codes.
 - b. The letter "E" is used to end the programming string.
2. FA and FB units are reduced by a factor of 10 when in W4 with phase lock option.

Reading the 8505A

The Processor MARKER values may both be read by reading them into two variables. The units are the same as displayed on the front panel LEDs.

The Counter marker value is obtained by reading the source into a variable. The units are in HZ.

The current state of many of the 8505A controls may be output using the Learn Mode (program, "L") then read on a properly dimensioned string.

Processor Learn String: 85 Characters												
"C0Bd,	C1ld	Md	Sd	R ±	dddd,	C2ld	Md	Sd				
	4	9	11	13	15		25	27	29			
R ±	dddd,	C3ld	Md	Sd	R ±	ddd,	E					
	31		41	43	45	47						
C10 ±	dddd,	C20 ±	dddd,	C30 ±	ddd,	E"						
	57		67		77	85						
Source Learn String: 30 characters												
"0d	ld	Rd	Md	Wd	Sd	Td,	FAdddd,	FBddd,	E"			
	2	4	6	8	10	12	14	18	25	30		

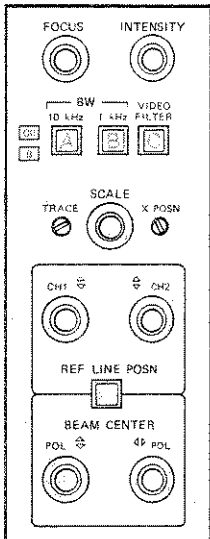
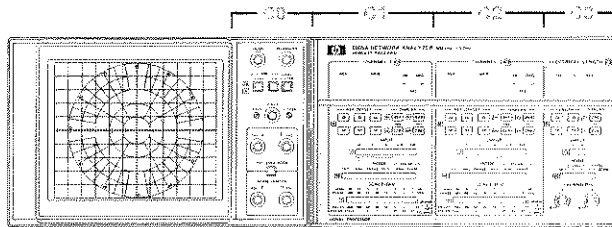

A: C0B1
 B: C0B2
 A + C: C0B3
 B + C: C0B4

NOT PROGRAMMABLE

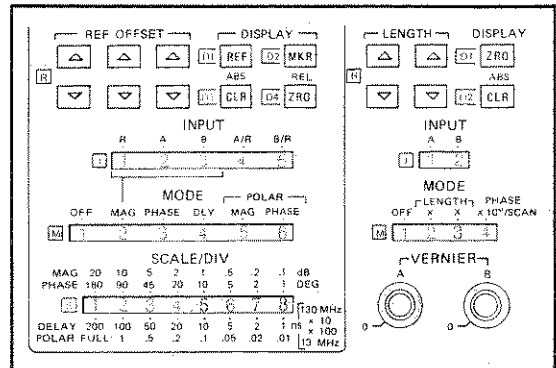

PROCESSOR PROGRAMMING CODES

FUNCTION AND COMMENT	HP-IB CODE	FUNCTION AND COMMENT	HP-IB CODE
IF and VIDEO filter selection*	C0Bd	ELECTRICAL LENGTH code must precede the other codes in C3.	C3
CHANNEL code must precede the other codes used in the channel. C1 codes are the same as C2 codes.	C2	INPUT*	Id
INPUT*	Id	MODE*	Md
MODE*	Md	ELECTRICAL LENGTH	R ± ddd
SCALE/DIV*	Sd	Stored Electrical Length	0 ± ddd
REFERENCE OFFSET	R ± dddd	The range of numbers for "R" and "0" is ± 199. The plus sign is implied and leading zeros ignored. Decimal position is not programmed. It is shown below to give implied position.	
STORED CALIBRATION	0 ± dddd		
The range of numbers for "R" and "0" is ± 19999. The plus sign is implied and leading zeros ignored. Decimal position is not programmed. It is shown below to give implied position.			
ddd		ddd	
Phase (degrees)		Source	C3
Delay 1300 MHz (ns)		Range	Mode
Magnitude (dB)		1	3
Delay 13 MHz (us)		3	3
Delay 130 MHz (us)		1	2
		2	3
		3	2
		2	2
			Scale
			m
			cm
			m
			cm
			m
DISPLAY* D3 when programmed clears only "R", to clear "0" enter O0. Non-learned programming code.	Dd	DISPLAY* D2 when programmed does not clear stored Length to clear this enter O0. Non-Learned programming code.	Dd
		Mode of unselected input only on Learn string (characters 44 and 45). Non-Programmable.	Sd
*The range for values of "d" are shown on corresponding control in illustration above.		Terminator used to end and separate all ("R", "O", and "D") program statements	E

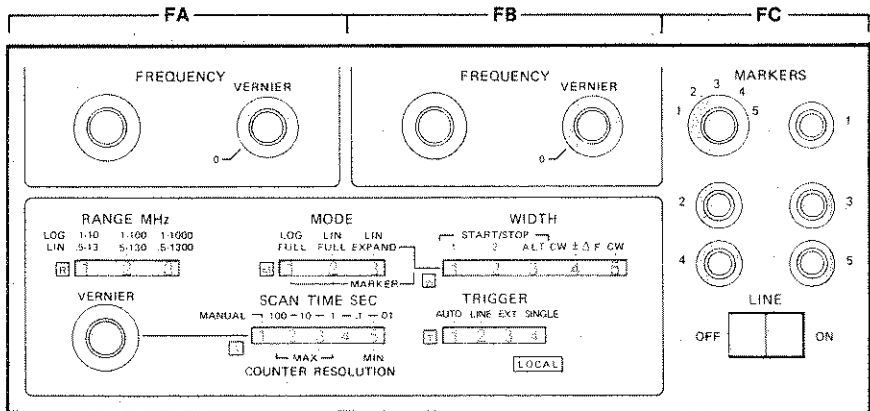
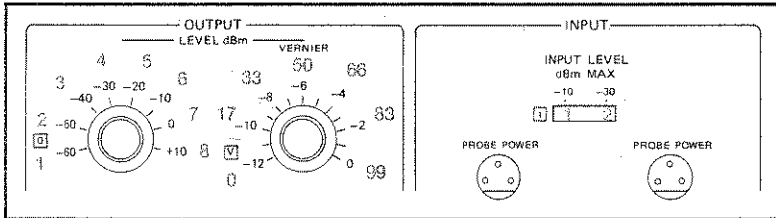
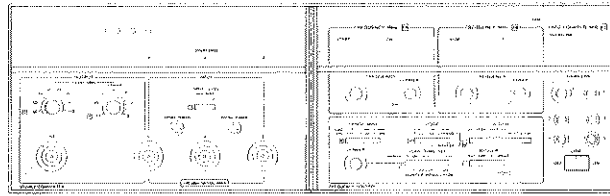

SOURCE PROGRAMMING CODES

FUNCTION AND COMMENT	HP-IB CODE	FUNCTION AND COMMENT	HP-IB CODE																
OUTPUT LEVEL dBm 10 dB steps* VERNIER Local Lockout required to program. Setting not on Learn String. dd = 99 ((V + 12)/12) V = Vernier in dB INPUT LEVEL dBm MAX*	Od Vdd Id	START FREQUENCY and CW STOP FREQUENCY and ΔF Leading zeros are ignored. Decimal position is not programmed. It is shown below to give implied position. The range of frequencies for Range and Mode settings are shown below.	FAdddd FBdddd																
RANGE MHz* MODE (sweep)* M4 = PHASE LOCK mode WIDTH* SCAN TIME SEC* Vernier defaults to min Scan Time when Local Lockout is set TRIGGER*	Rd Md Md Sd Td	<table border="0"> <tr> <td>ddd</td> <td>Range</td> <td>Mode1</td> <td>Mode 2 & 3</td> </tr> <tr> <td>3</td> <td>1 - 1000 MHz</td> <td>1 - 1300 MHz</td> <td></td> </tr> <tr> <td>2</td> <td>1 - 100.0 MHz</td> <td>.5 - 130.0 MHz</td> <td></td> </tr> <tr> <td>1</td> <td>1 - 10.00 MHz</td> <td>.5 - 13.00 MHz</td> <td></td> </tr> </table> <p>Vernier controls default to min (CCW) when Local Lockout is set. When in Mode "M4" the units for FB change to kHz.</p>	ddd	Range	Mode1	Mode 2 & 3	3	1 - 1000 MHz	1 - 1300 MHz		2	1 - 100.0 MHz	.5 - 130.0 MHz		1	1 - 10.00 MHz	.5 - 13.00 MHz		
ddd	Range	Mode1	Mode 2 & 3																
3	1 - 1000 MHz	1 - 1300 MHz																	
2	1 - 100.0 MHz	.5 - 130.0 MHz																	
1	1 - 10.00 MHz	.5 - 13.00 MHz																	
*The range of values for "d" are shown on corresponding control in illustration above.		FREQUENCY COUNTER Only one marker available in remote. Set marker (dd) to percentage of sweep width between 00% and 99%.	FCdd																

OPERATION	DELAY REQUIRED
PROCESSOR settling times COB BandWidth 10 kHz 1 kHz Video Filter	10 ms 25 ms 300 ms
C1-C2 CHANNELs 1 & 2 Any change affecting Reference Level (includes REF OFFSET, CLR, INPUT, MODE, and 8503A/B Test Set switching To 1% final value To .01% final value	1000 ms 3000 ms
ZRO (MKR & REF mode), CLR, INPUT, MODE, and SCALE/DIV	At least 3 sweep times per channel + 3000 ms
C3 ELECTRICAL LENGTH Any change affecting LENGTH (includes LENGTH, CLR, Channel 1 and 2 MODE, INPUT, and 8503A/B Test Set switching).	3000 ms
ZRO, CLR, INPUT, AND MODE	20 ms
Read marker value and determine if auto-ranging occurs (resolution changes): Resolution constant Autoranging	1 sweep/Channel + 25 ms 2 sweeps/Channel + 100 ms
SOURCE settling times OUTPUT, INPUT LEVEL dBm, MAX SCAN- TIME SEC, TRIGGER	20 ms
START/STOP, $\pm \Delta F$	120 ms
CW (to 0.01%)	1000 ms (first freq.) 360 ms (next freq.)

OTHER HP-IB COMMANDS

Trigger: The 8505A does not respond to a device Trigger.

Clear: The 8505A does not respond to a device Clear.

Remote: The Remote message will disable the 8505A front panel programmable controls. It will retain the pre-remote front panel settings until changed by program.

Local: The Local message or switching the 8505A off and on will return the 8505A to manual front panel control.

Local Lockout: Disables local switch on 8505A front panel and "presets" vernier controls.

VERNIER CONTROL "PRESET" POSITION	
Output Level	- 10 dBm
Scan time	Vernier Scan time min
Frequency (2)	0 Position MAX CCW
Electrical Length	0 Position MAX CCW

Serial Poll Enable: HP-IB, Octal 030.

Serial Poll Disable: HP-IB, Octal 031

Service Request: If the Serial Poll is enabled the Source will Service Request if loss of phase lock or RF input overload occurs. Bit 6 of the Status Byte will also refresh this. An initial Serial Poll after power on will enable the Service Request.

Pass Control: The 8505A does not have the ability to Pass Control or take Control.

Abort: The 8505A does not respond to the Abort message.

For more information, call your local HP Sales Office or nearest Regional Office: Eastern (301) 258-2000; Midwestern (312) 255-9800; Southern (404) 955-1500; Western (213) 877-1282; Canadian (416) 678-9430. Ask the operator for instrument sales. Or write Hewlett-Packard, 1501 Page Mill Road, Palo Alto, CA 94304. In Europe: Hewlett-Packard S.A., 7, rue du Bois-du-Lan, P.O. Box, CH 1217 Meyrin 2, Geneva, Switzerland. In Japan: Yokogawa-Hewlett-Packard Ltd., 29-21, Taka-ido-Higashi 3-chome, Suginami-ku, Tokyo 168.

HP 8505A
RF Network Analyzer
Basic
Measurements

APPLICATION NOTE 219

NOVEMBER 1978



CONTENTS

INTRODUCTION	3
Overview 8505A, test sets, and control functions.	
TRANSMISSION MEASUREMENTS	15
Setup, calibration, and measurement sequences for:	
Insertion Loss and Gain	
Insertion Phase	
Electrical Length	
Deviation from Linear Phase	
Group Delay	
REFLECTION MEASUREMENTS	22
Setup, calibration, and measurement sequences for:	
Return Loss, SWR	
Reflection Coefficient	
POWER LEVEL MEASUREMENTS	25
Measure the absolute power at the R, A, and B inputs.	
S-PARAMETER MEASUREMENTS	26
Setup, calibrate, and measure S_{11} , S_{21} , S_{12} , and S_{22} using the 8503A S-Parameter Test Set.	
THE 8501A STORAGE-NORMALIZER	30
Use the Digital Storage, Labels, Averaging, Magnification, and Normalization features of the 8501A to enhance 8505A measurement capabilities.	
CONTROLS AND DISPLAYS SUMMARY	33
A summary of the functions of the 8505A controls and displays.	

PREFACE

This application note will help you make transmission and reflection measurements with the Hewlett-Packard Model 8505A RF Network Analyzer and its associated test sets. Previous experience in network analysis techniques is assumed, so the note concentrates on generalized setup, calibration, and measurement sequences rather than basic measurement theory. As you become familiar with operation of the instrument you can modify and extend these sequences to more specialized applications.

The first part of this note introduces the 8505A and the standard test sets, then describes the main operations to make measurements. The Transmission Measurements, Reflection Measurements, Power Level Measurements, and S-Parameter Measurements sections contain specific step-by-step sequences used to make particular measurements on a device. If you have a device to measure, go directly to one of these sequences and try it. Use the Introduction as a reference for operations that require more explanation. A section for the 8501A Storage-Normalizer provides a brief description of how to use this important accessory. A foldout at the rear of this note presents a photo of the 8505A front panel and a summary of the functions of the controls, indicators, and displays.

Learn by doing. Use the 8505A to measure a device with known characteristics. You will better appreciate the ease with which measurements are made if you have access to an 8505A with test set from the very beginning. But, during the interval prior to arrival of your 8505A, you can develop valuable background knowledge of instrument operation from this note. Although the 8505A is fully programmable via the HP-IB, this note does not describe programming operations. It is recommended that you gain a good understanding of the 8505A in manual operation before writing programs to control it.

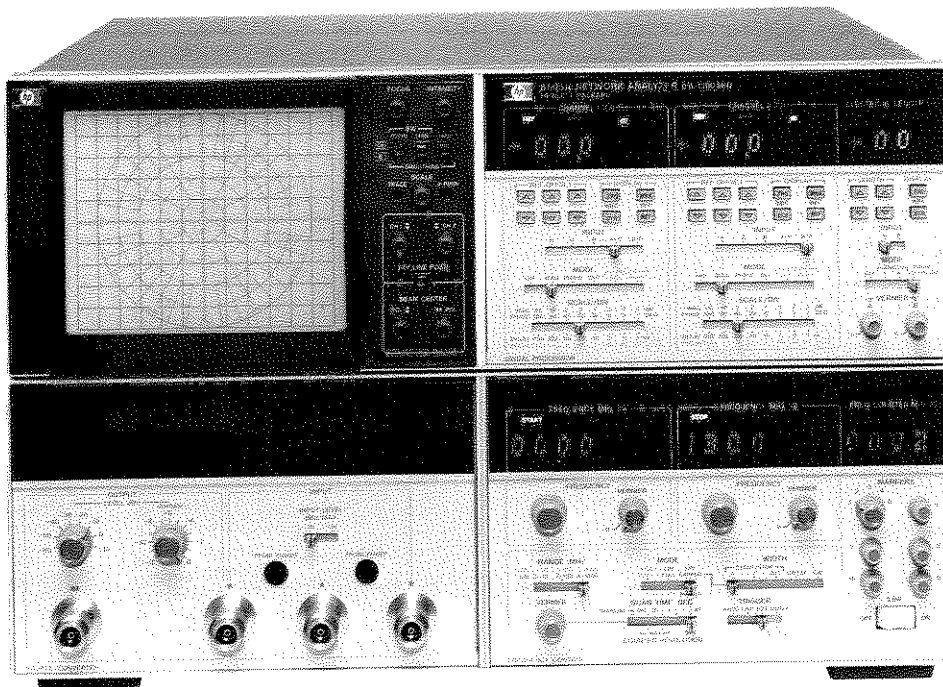

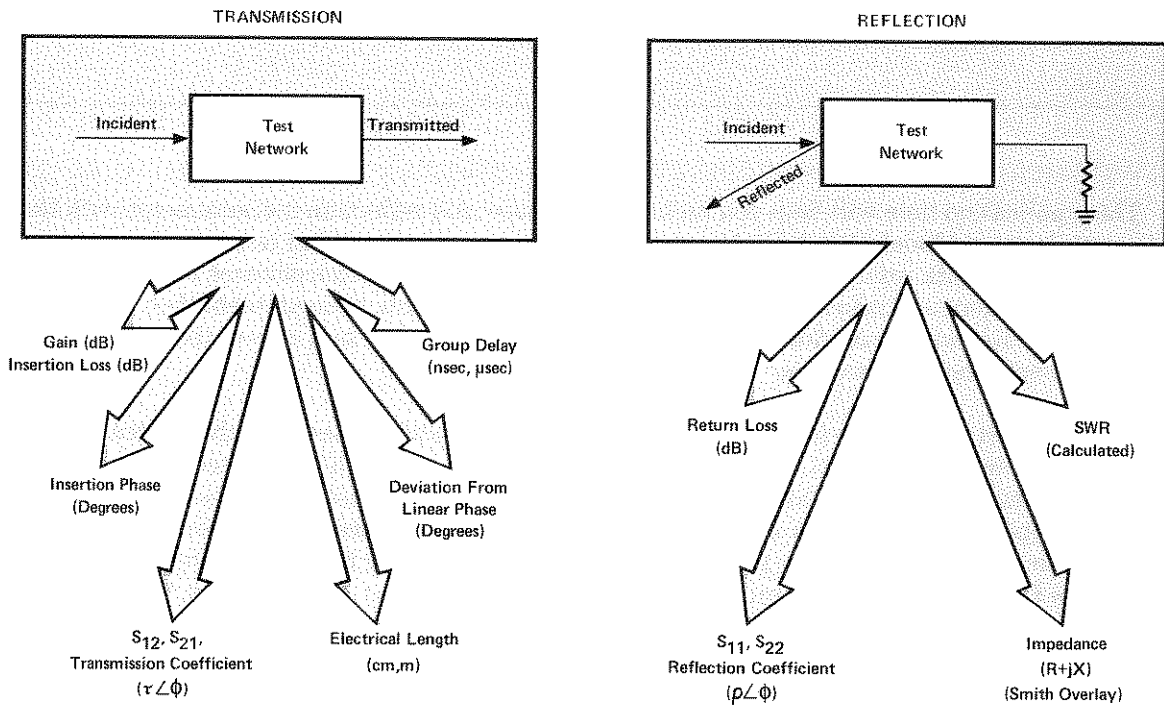

Basic 8505A Transmission and Reflection Measurements

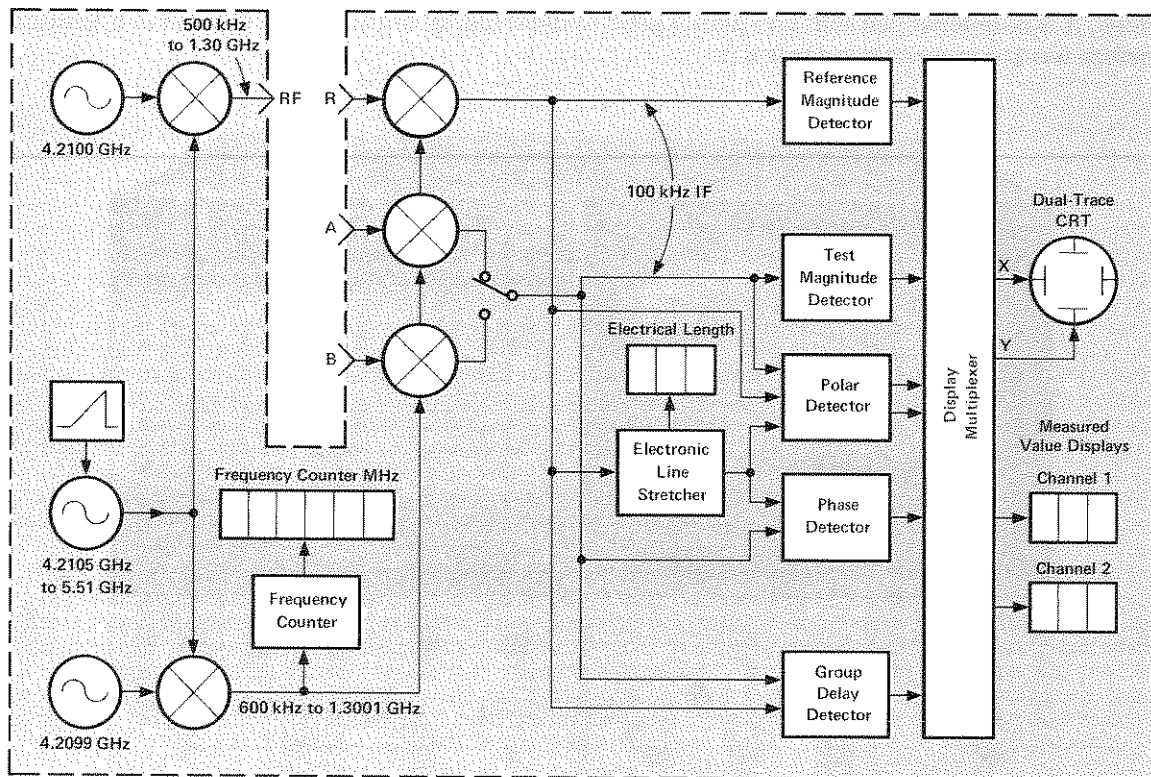

8505A Simplified Block Diagram

INTRODUCTION

The 8505A is a high performance RF network analyzer that includes a leveled source, frequency counter, two measurement channels, dual-trace CRT with both cartesian and polar displays, digital readout of the measured value, and an electronic line stretcher. Together with appropriate signal routing accessories, the 8505A is a fully integrated stimulus/response test system that measures magnitude, phase, and delay characteristics of linear networks by comparing the incident signal with the signal transmitted through the device or reflected from its input.

The basic transmission measurements described in this note are: insertion loss and gain, insertion phase, electrical length, deviation from linear phase, group delay, and transmission coefficient (S_{12} or S_{21}). Basic reflection measurements are: return loss, from which SWR can be calculated, and reflection coefficient (S_{11} or S_{22}), from which impedance can be calculated or read from a Smith Chart overlay.

To begin familiarizing yourself with the 8505A, recognize that it is packaged in two cases. The lower case contains the sweeper controls and displays, the receiver input connections, the measurement marker controls, and the frequency counter display. The upper case contains the dual trace CRT, the measurement selection controls, the measured value displays, and the electrical length controls and display. The boxed characters adjacent to the switches, buttons, and displays are HP-IB* addressing codes used when programming the instrument.

Block Diagram Description

The source produces leveled RF for the test device and a tracking local oscillator signal to the receivers. Reference (R) and test (A and B) inputs from the test setup are down-converted to 100 kHz IF frequency for application to the detectors. This combination of two identical fixed oscillators, which are phase-locked to a common reference and offset by 100 kHz, with a YIG-tuned swept oscillator provides continuous, very linear 3-½ decade frequency sweeps and the precise local oscillator tracking required for narrow bandwidth detection. High reliability thin-film technology enables all three input mixers to have closely matched magnitude, phase, and delay characteristics with full -10 to -110 dBm dynamic range and greater than 100 dB isolation between inputs.

Transmission and reflection characteristics can be measured simultaneously by using two identical measurement channels, one for the reference input and one switched between the A and B test inputs on alternate sweeps. Completely independent magnitude, phase, delay, and polar detectors process the IF to DC levels for multiplexing to the CRT display. The electronic line stretcher allows electrical length of the A and B test signal paths to be independently matched to the reference signal path by adding or subtracting up to 1700 degrees of linear phase shift per sweep prior to detection. This technique virtually eliminates the need for mechanical line length adjustments and allows direct measurement of deviation from linear phase. The group delay detector provides direct, calibrated measurement regardless of sweep width or sweep rate.

Frequency, magnitude, phase, and delay are read directly from digital displays by positioning a measurement marker to any point on the trace. Frequency at the marker is measured using a new up-down counter which measures the local oscillator frequency and subtracts the 100 kHz offset. This technique provides up to 100 Hz resolution and ± 2 count accuracy without the need to stop the sweep at the marker. Magnitude, phase, and delay values are measured by sampling the selected detector outputs at the marker position. An autoranging voltmeter displays the measured value with up to 0.01 dB, 0.1 degree, and 0.1 nanosecond resolution.

*HP-IB, the Hewlett-Packard Interface Bus, is Hewlett-Packard's implementation of IEEE 488.

TEST SETS

The following test sets are designed especially for use with the 8505.

For precision transmission tests, or ratio tests using a standard device as a reference, the 11851A RF Cable Kit and 11850A (50Ω) or 11850B (75Ω) Power Splitter provide the necessary RF connections and shielding with excellent magnitude and phase tracking characteristics over the 8505 frequency range. The 11850B includes three 50Ω to 75Ω Model 11852A minimum loss pads.

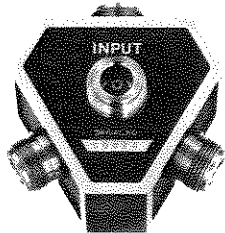

11850A/B Three-Way Power Splitter

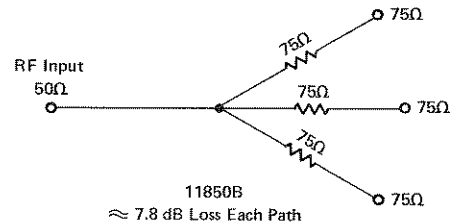
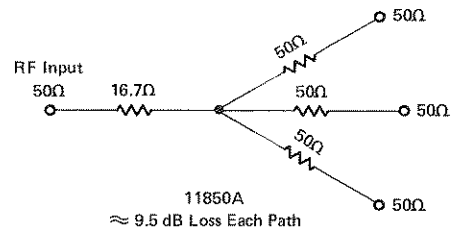

The 8502A (50Ω) or 8502B (75Ω) Transmission/Reflection Test Set contains a power splitter and directional bridge allowing simultaneous transmission and reflection measurements. It also includes a 0 to 70 dB, 10 dB step attenuator which allows control of the incident signal level independent from the reference signal level. The 8502B includes one 50Ω to 75Ω Model 11852A minimum loss pad.

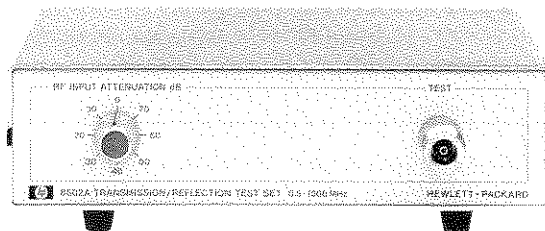

8502A Transmission/Reflection Test Set

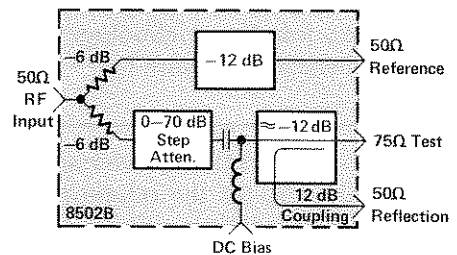
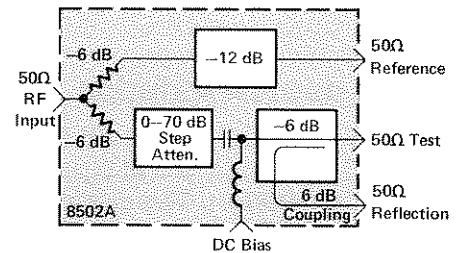

Transmission and reflection measurements on two port devices which require measurement of both forward and reverse characteristics can be accomplished easily using the 8503A (50Ω) or 8503B (75Ω) S-Parameter Test Set. With this test set and included cables, measurement of both forward and reverse characteristics can be accomplished without disconnecting and reversing the test device. DC bias connections for transistor testing are provided.

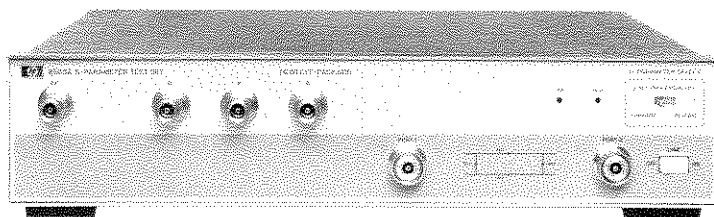

8503A S-Parameter Test Set

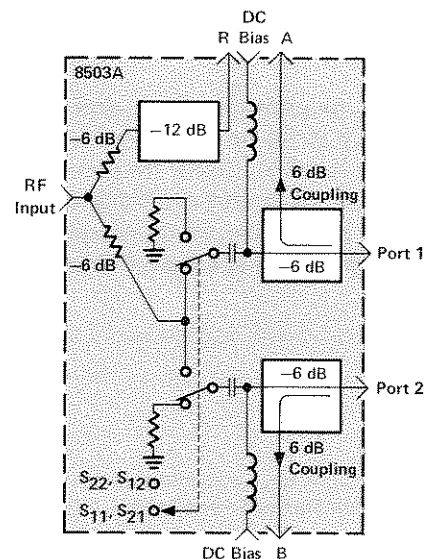

INTRODUCTORY MEASUREMENT SEQUENCE

With a basic understanding of the instrument and these test sets in mind, follow this typical operating sequence for measuring transmission insertion loss or gain. Use a bandpass filter or similar device with known characteristics. If you are not in front of an instrument, use the foldout at the rear of this note to locate the controls. This introductory sequence assumes measurements are made using the 8502 test set, or an 8503 test set with the front panel S-PARAMETER SELECT switch set to FORWARD.

Connect Test Set — See connection diagram. Do not connect the test device.

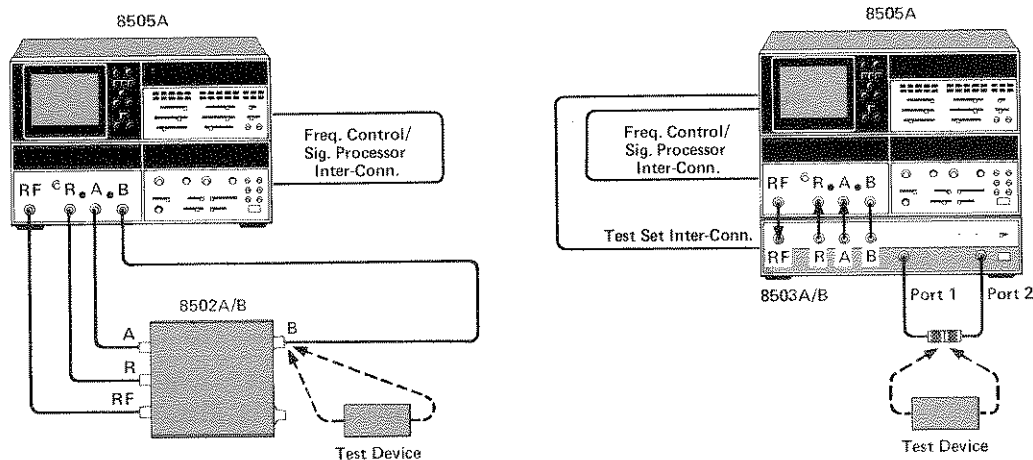

Set Signal Levels — Set the INPUT LEVEL dBm MAX switch to -10 . Use the OUTPUT LEVEL dBm and VERNIER to set the approximate signal levels to the test device. (Refer to the Power Level Measurements sequence on page 25 to measure the absolute power, if necessary.)

Select Measurement — Set CHANNEL 1 INPUT switch to B/R to select transmission, MODE to MAG to select magnitude ratio, and SCALE/DIV to 10 dB/division. Set CHANNEL 2 MODE and ELECTRICAL LENGTH MODE to OFF.

Set CRT Display — Press to detent REF LINE POSN/BEAM CENTER to display reference line, then use CH1 \blacklozenge to set reference line to desired position, usually center screen. Set TRIGGER to AUTO.

Set Frequency Sweep — Set RANGE MHz to lowest range that includes frequency range of interest. Set sweeper MODE to LIN EXPAND, and WIDTH to START/STOP 1. Now use the FREQUENCY controls below the FREQUENCY MHz displays to set the end points of the frequency sweep. Read the end points of the frequency sweep from the FREQUENCY MHz displays.

Calibrate — Connect through. Set MARKERS switch to position 1, then use the adjacent vernier to set upward-pointing measurement marker to desired calibration frequency. Press CHANNEL 1 MKR, then press and hold ZRO until the iterative zero process is complete and the trace moves to the reference line. This establishes test set response at 0 dB insertion loss or gain.

Connect Test Device — See connection diagram.

Read Measured Value — Use the MARKERS 1 vernier to position the measurement marker to any point on the trace. If necessary to position the trace for viewing, use the CH1 \blacklozenge control or the CHANNEL 1 REF OFFSET buttons (Δ moves trace up, ∇ moves trace down). Read the frequency at the measurement marker from the FREQ COUNTER MHz display. Press the CHANNEL 1 REF button to display value of the reference line, then press MKR to display marker displacement from the reference line. The measured value (dB) is the sum of the REF and MKR values.

The following paragraphs describe the functions of the controls used in these steps in more detail.

SET SIGNAL LEVELS

Set Sweeper Output Level

The OUTPUT LEVEL attenuator and VERNIER set the sweeper output level at the RF connector to any level from +10 to -72 dBm. The sum of the rotary switch and the VERNIER setting is the RF output level, ± 1 dB. If the OUTPUT controls are set to -30 and -6, then the level at the RF connector will be -36 (± 1) dBm.

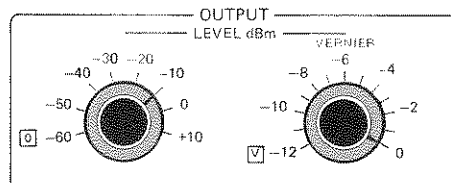

Set Reference and Test Channels Input Level

The maximum signal level which can be applied to the R, A, or B inputs is either -10 dBm or -30 dBm depending upon the INPUT LEVEL dBm MAX switch setting. If the signal level at any input is greater than the switch setting the R, A, or B OVERLOAD indicator on the dark panel above the switch will light to show that the input signal is near the compression point for the input mixer and measurement errors may result.

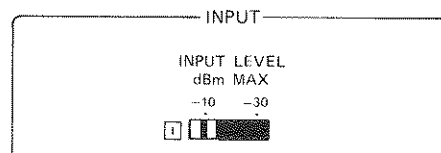

The switch is normally set at the -10 position. When making measurements in which the A or B inputs are below about -80 dBm and the R input is below -30 dBm, set the INPUT LEVEL dBm MAX switch to the -30 position. Selecting -30 increases the signal level into the detectors (and adds appropriate display compensation) thus reducing the magnitude, phase, and delay measurement uncertainties for low signal level measurements.

Signal Level Considerations

Minimum measurement uncertainty is achieved when the input levels are near maximum. For example, when the test input drops from -20 dBm to -100 dBm, the magnitude ratio uncertainty increases from ± 0.01 dB to ± 4.0 dB. The R, A, and B inputs are identical, each with -10 dBm to -110 dBm of range, thus allowing measurements to be made with 100 dB dynamic range. But, for best results in ratio measurements, the test input should be above -110 dBm for magnitude, -100 dBm for phase, and -90 dBm for delay.

The reference input level should remain constant for calibration and measurement. The test input level at calibration determines the gain and insertion loss range available for measurement without overload or excessive measurement uncertainty. Two examples are shown in this chart. Example (1) represents calibration levels for a passive device with both reference and test inputs at -10 dBm. When calibrated at this level the 8505 can measure the test device magnitude ratio to over 100 dB insertion loss. Example (2) represents calibration signal levels for an active device. It shows the reference level set to -10 dBm and the test channel set to -50 dBm. At these levels the magnitude ratio can be measured to 40 dB of gain and to over 60 dB for insertion loss.

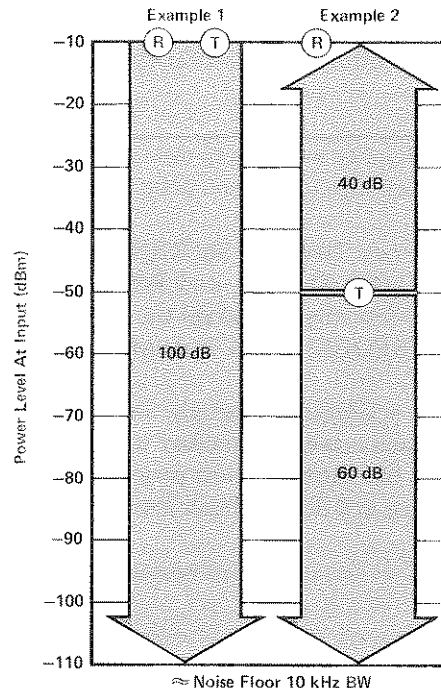

At low signal levels measurement uncertainty is seen as noise on the CRT trace. Select the 1 kHz IF bandwidth (the 1 kHz button to the right of the CRT) to reduce the pre-detection bandwidth and improve the signal-to-noise ratio into the detectors. Select the VIDEO FILTER to reduce the post-detection bandwidth and thus reduce the residual uncertainty caused by detector noise. Slower scan time may be required.

SELECT MEASUREMENT

The CHANNEL 1 and CHANNEL 2 MODE and INPUT switches function independently to select the measurement displayed on the CRT. This illustration shows the display format and measurement selected for each combination of MODE and INPUT switch settings for either channel when the R input is the reference, the A input is the reflected, and the B input is the transmitted signal.

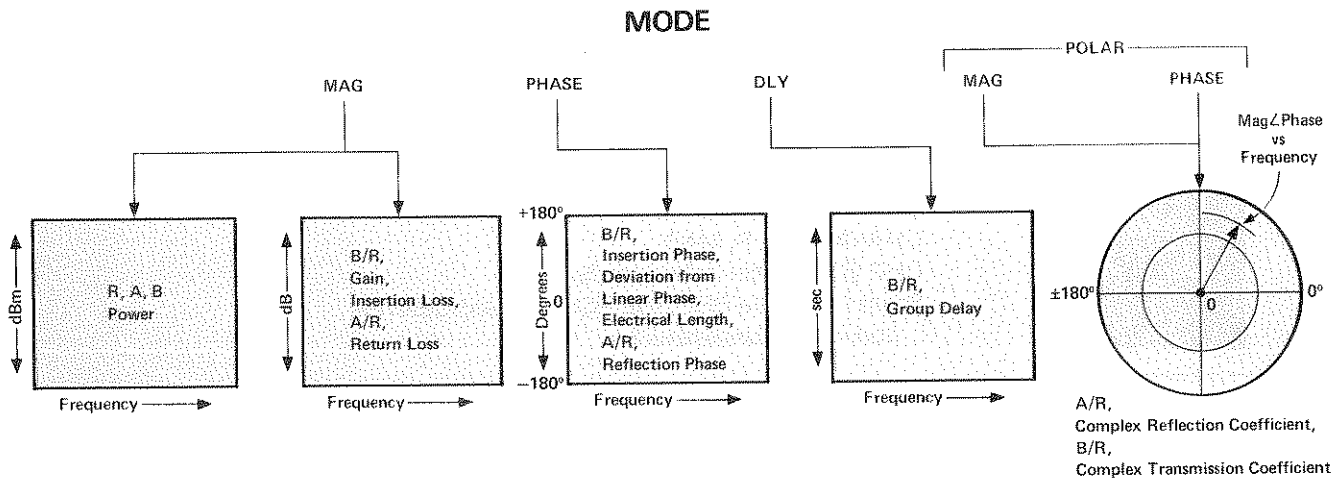
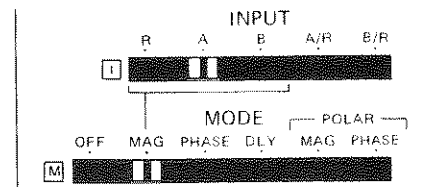

The MAG, PHASE, and DLY selections use the cartesian display; POLAR MAG and POLAR PHASE use the polar format. R, A, and B INPUT positions can only be selected with MODE in MAG. The MODE switch also selects the appropriate dB, degrees, microsecond or nanosecond units indicator near the measured value LED display. The CRT trace is identical for both POLAR MAG and POLAR PHASE selections. In POLAR MAG the dB ratio at the marker is displayed and in POLAR PHASE the phase angle at the marker is displayed.

For A/R and B/R INPUT selections, the CRT trace and the measured value is always presented as the ratio of the test channel to the reference channel.

The SCALE/DIV switch uses four scales. The MAG, PHASE, and DLY scales set the value per division on the cartesian display; the POLAR FULL scale establishes the linear transmission or reflection coefficient value of the polar display outer circle. Note that the DLY scale uses additional scaling factors which depend on the RANGE MHz switch position.

		SCALE/DIV							
MAG	20	10	5	2	1	.5	.2	.1	dB
PHASE	180	90	45	20	10	5	2	1	DEG
DELAY	200	100	50	20	10	5	2	1	ns x 10
POLAR FULL:	1	.5	.2	.1	.05	.02	.01		13 MHz

As an exercise, connect the RF output directly to one of the R, A, or B input connectors. Set the INPUT LEVEL dBm MAX switch to -10, the OUTPUT LEVEL dBm VERNIER to -12, and the OUTPUT LEVEL dBm attenuator to -10. Rotate the VERNIER toward zero and note the setting at which the OVERLOAD indicator lights. This is the simplest operator check you can make on the source and receiver. The OVERLOAD indicator lights at about ± 2 dB of the INPUT LEVEL switch setting. Make this test at each of the R, A, and B inputs using the -10 and/or the -30 input switch settings.

To observe the CRT trace, set CHANNEL 1 or CHANNEL 2 to R, A, or B MAG, set SCALE/DIV to 10 dB/division and repeat the above exercise. If the trace does not appear, set the CRT display as described on the next page.

SET CRT DISPLAY

Pressing to detent the REF LINE POSN/BEAM CENTER button displays the cartesian reference line or the polar beam center during the sweep retrace. Standard controls are used for beam focus, beam intensity, scale illumination, and trace align. This illustration presents a sequence for setting the cartesian reference line and polar beam center positions.

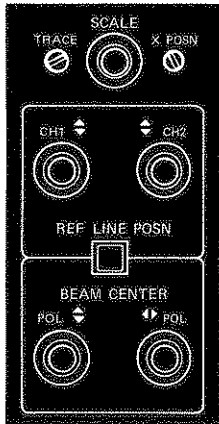

- Depress REF LINE POSN/BEAM CENTER button
- CHANNEL 2 MODE: OFF
- CHANNEL 1: R, MAG
(Use SCALE/DIV switch or press REF OFFSET to move CRT trace away from reference line)
- CH1 \blacktriangle to position reference line
- CHANNEL 1: POLAR MAG
- POL \blacktriangleleft and POL \blacktriangleright to center beam
- CHANNEL 1 MODE: OFF
- CHANNEL 2: R, MAG
- CH2 \blacktriangle to position reference line
- Press to release REF LINE POSN/BEAM CENTER
(may be left depressed)

For the cartesian display, the reference line is the position from which SCALE/DIV expands or contracts the trace. The value of the reference line is initially zero dB, degrees or seconds and the trace is positioned above or below the reference line depending upon whether the response characteristic is positive or negative.

The reference line can be set to any position on the CRT at any time using the CH1 \blacktriangle and CH2 \blacktriangle controls without disturbing the calibration values.

To continue the previous exercise, press to detent the REF LINE POSN/BEAM CENTER button and move the reference line to the center CRT graticule line. Connect the test set, and set CHANNEL 1 or CHANNEL 2 INPUT to R, A, or B and set MODE to MAG. If the REL indicator near the measured value display is lit, press and hold the CLR button until REL goes out (\cong 2 seconds at each INPUT position). Read the power at the R, A, and B inputs from the CRT display by assuming that the reference line is 0 dBm and noting the trace position with respect to the reference line.

For the polar display, reflection and transmission coefficient values can be read directly from the polar graticule. For magnitude ratio, the beam center position is the point of zero reflection coefficient (infinite dB return loss) and zero transmission coefficient (infinite dB insertion loss). The outer circle is the magnitude ratio reference line, having a linear coefficient value corresponding to the SCALE/DIV POLAR FULL selection. At POLAR FULL 1 (and zero dB REF OFFSET) the outer circle represents a reflection coefficient magnitude of 1 (0 dB return loss) and transmission coefficient magnitude of 1 (0 dB insertion loss). For phase angle, the zero degrees reference line is the right hand intersection of the center line and the concentric circles and is scaled from zero to ± 180 degrees.

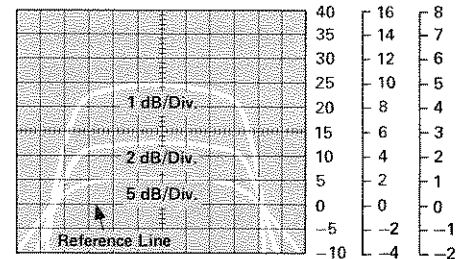
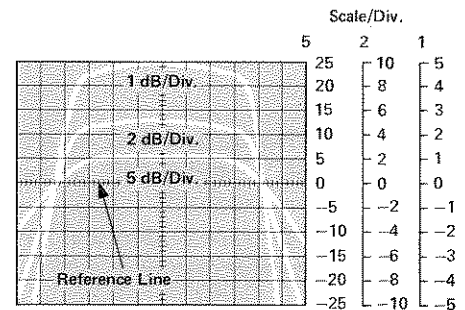

Cartesian Display

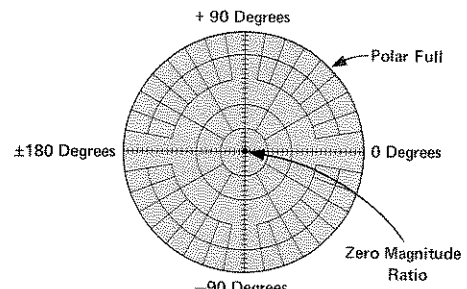

Polar Display

SET FREQUENCY SWEEP

Frequency sweep is controlled by the RANGE MHz, MODE, and WIDTH switches. RANGE MHz selects the frequency range. MODE selects logarithmic or linear full sweep, or the linear expanded sweep selected by WIDTH. You can set and store an independent expanded sweep at each of the WIDTH switch START/STOP 1, START/STOP 2, and CW $\pm \Delta F$ positions using the FREQUENCY MHz displays and FREQUENCY controls. To familiarize yourself with operation of the sweeper frequency controls, follow this sequence.

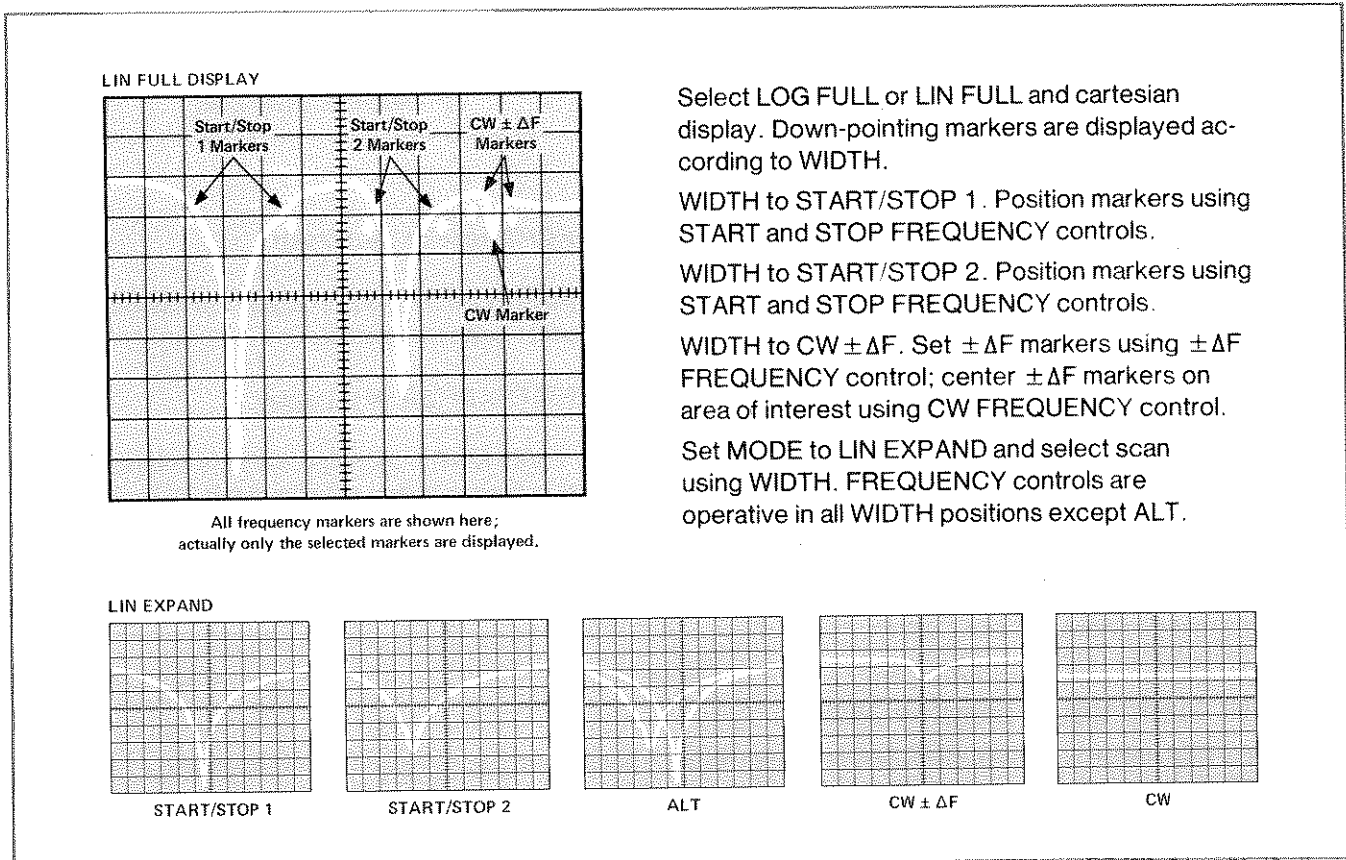

In LOG FULL, the full selected frequency range is swept with a logarithmic frequency axis. (The log sweep end points are identified above the RANGE MHz switch and log frequency graticule overlays are available.) LIN FULL selects a linear sweep of the full selected frequency range (500 kHz to 13, 130, or 1300 MHz). In the full sweep modes selecting one of the START/STOP or CW $\pm \Delta F$ places two down-pointing frequency markers on the CRT trace to identify the sweep end points. The FREQUENCY controls position these markers; each adjacent VERNIER provides fine adjustment but does not change the FREQUENCY MHz displays.

For ALT, CHANNEL 1 displays the START/STOP 1 sweep and CHANNEL 2 displays the START/STOP 2 sweep. The FREQUENCY MHz displays and the FREQ COUNTER MHz display readings apply to the START/STOP 1 sweep unless CHANNEL 1 is off, in which case the readings apply to the CHANNEL 2 sweep. For CW, the frequency counter measures the actual CW frequency and displays it using the left-hand six-digit FREQUENCY MHz display.

In START/STOP and CW $\pm \Delta F$ the FREQUENCY MHz displays do not have counter accuracy and thus should not be used for other than setting approximate frequency sweep widths. Residual FM performance is improved in the lower RANGE MHz settings, so select the lowest setting which includes the frequency range of interest for your measurement. The frequency controls can be set so that the start frequency is above the stop frequency, but degraded sweep linearity will reduce the accuracy of the measured frequency and group delay values.

Set Sweep Time

Time for a complete sweep of the selected frequency range is selected by the SCAN TIME SEC switch and adjacent VERNIER. Select the fastest sweep time then decrease until there is no distortion of the test device response. The vernier allows continuous adjustment within the selected range.

READ MEASURED VALUE

The general sequence to read the measured value at a particular point on the CRT trace is as follows.

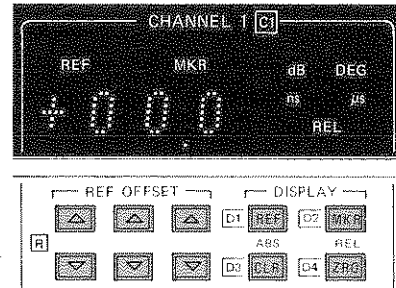

Measured Value Display

Use REF OFFSET buttons and SCALE/DIV switch to position CRT trace on the screen.

Select one of the five measurement markers using the MARKERS switch, then position the marker on the CRT trace at the point to be measured using the adjacent numbered vernier.

Read the frequency at the measurement marker from the FREQ COUNTER MHz display.

Press REF button and read the value of the reference line. Press MKR button and read the marker displacement from the reference line. Add the REF and MKR values to obtain the measured value at the measurement marker.

REF and MKR Value Display Modes

When the REF button is pressed, the measured value display shows the value assigned to the reference line. When the MKR button is pressed the measured value display shows the displacement of the selected measurement marker from the reference line. The magnitude, phase, or delay value at any point on the CRT trace is then:

$$\text{REF value} + \text{MKR value} = \text{Measured Value}$$

If REF OFFSET has not been used to position trace, REF will equal zero and the MKR value alone represents the measured value.

REF OFFSET

Pressing any REF OFFSET button increments the reference line value for that channel, thus moving the CRT trace in relation to the reference line. Holding a REF OFFSET button pressed increments the associated LED numeral at the rate of about two digits per second. Momentarily pressing the CLR button resets the reference line value for that channel to zero.

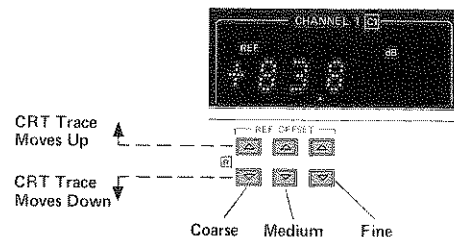

There is no accuracy advantage in moving the CRT trace closer to the reference line to make the measurement. In fact, the MKR value is correct even when the CRT trace and the measurement marker are positioned off screen. However, when the SCALE/DIV switch is at one of the four right-hand positions and the REF or MKR value is less than about 8 dB, 80 degrees, or 8 delay units, the displayed REF or MKR value gains an additional decimal digit of resolution. To see this change, select MKR mode, move SCALE/DIV to one of the four right-hand positions, and use REF OFFSET to move the CRT trace toward and away from the reference line.

Using REF OFFSET, the magnitude, phase, and delay trace positions can be set independently. The REF value is stored in six independent Reference Offset registers; three for each channel, one for each of the MAG, PHASE, and DLY selections. (The POLAR MAG position shares the same Reference Offset register as the MAG position and POLAR PHASE shares the PHASE register.)

Frequency Counter

The FREQ COUNTER MHz display indicates the frequency in MHz at the selected measurement marker in all sweep modes except CW. In CW, the counter uses the left-hand FREQUENCY MHz display to indicate the CW frequency.

Resolution of the FREQ COUNTER MHz display is controlled by RANGE MHz and SCAN TIME SEC selections. Slow sweep times allow greater counter resolution, shift one or more digits off the left of the display and cause the display OVERFLOW indicator to light. To obtain six digit counter resolution, move SCAN TIME SEC to a faster sweep position to inspect the most significant digits, then to a slower sweep position to inspect the least significant digits.

When the MARKERS rotary switch is moved to positions 2 through 5, all lower numbered markers are displayed on the CRT trace pointing down. The selected measurement marker points up.

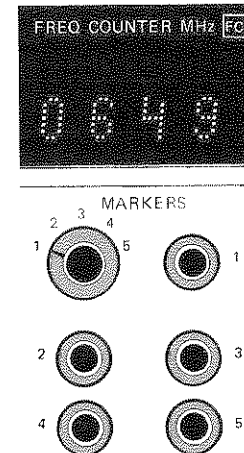

Polar Display

The CRT trace is the same for both POLAR MAG and POLAR PHASE selections. The measured value display reads the magnitude ratio at the measurement marker in POLAR MAG and the phase angle at the measurement marker in POLAR PHASE.

For POLAR MAG, the displayed measured value is the same dB ratio as indicated for the MAG selection. The magnitude part of the linear coefficient can be read from the concentric circles of the polar graticule, or calculated using the REF + MKR dB value and the HP Reflectometer Calculator (HP p/n 5952-0948) or the following equation:

$$\tau \text{ or } \rho = 10^D \quad \text{where } D = \frac{\text{Measured Value}}{20}$$

Where τ and ρ represent the magnitude part of the linear transmission or reflection coefficient, respectively, and Measured Value (dB) represents the REF + MKR value. For example if the REF + MKR value is -15 dB, the magnitude part of the linear coefficient is 0.178.

The phase value of the linear coefficient, $\angle\phi$, is read from the radial lines of the polar graticule, or by selecting POLAR PHASE and reading the REF + MKR value from the measured value display.

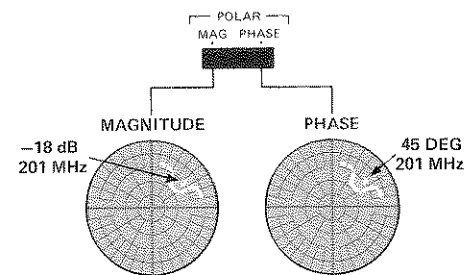

CALIBRATE

Measurements on a test device are made relative to a measurement standard with known response characteristics. Calibration establishes the offsets required to obtain a correct measured value for the measurement standard using the same test set-up as will be used for measurements on the test device.

The calibration standard for transmission measurements is a “through” connection (connect the points at which the test device will be connected). Complete transmission calibration sets the magnitude ratio between the transmitted and reference signals to unity (0 dB), equalizes any electrical length difference between the transmitted and reference signal paths, sets the phase to zero degrees, and the group delay to zero seconds. This establishes the transmission coefficient of the test set-up as $1 \angle 0^\circ$ with zero seconds group delay, the theoretical value for a zero-length transmission line.

The calibration standard for reflection measurements is normally a short circuit connected at the measurement plane (the point at which the test device will be connected). Complete reflection calibration sets the magnitude ratio between the reflected and reference signals to unity (0 dB), equalizes any electrical length difference between the reflected and reference signal paths, and sets the phase to 180 degrees. This establishes the reflection coefficient of the test set as $1 \angle 180^\circ$, the theoretical value for a short circuit.

Calibration values are stored in independent Stored Reference Offset registers, one for each measurement category. Thus, you can perform calibration for transmission and reflection magnitude, phase, and delay in sequence prior to measurement. Calibration values are shared by CHANNEL 1 and CHANNEL 2 so calibration using one measurement channel serves for both. Also, calibration values for magnitude and phase are shared by the cartesian and polar display modes so calibration using one display mode serves for both. Calibration values remain stored for as long as power is applied to the instrument or until manually cleared or changed.

ZRO buttons for CHANNEL 1 and CHANNEL 2 provide the magnitude, phase, and delay calibration function. Operation of the ZRO button depends upon the MKR or REF display mode selection. The MKR, ZRO sequence is used to establish a zero reference, as for magnitude, transmission phase, and delay calibrations. MKR, ZRO stores the offset required to move the measurement marker and trace to the reference line. The REF, ZRO sequence is used to establish a non-zero reference, as for the + or - 180 degree phase offset required for reflection phase calibration.

The REL indicator above the display lights to show that a calibration offset is stored and that the measured value is relative to the calibration standard. Pressing and holding CLR for about one second clears the stored calibration and extinguishes the REL indicator.

MKR, ZRO

To calibrate using MKR, ZRO, select the measurement mode, select MKR, then press and hold ZRO until the iterative process which moves the marker to the reference line and zeros the measured value display is complete (2 or 3 sweeps). Now the measurement marker is positioned on the reference line and the MKR and REF values are both zero. The process assigns the reference line the value of zero, then stores the offset required to move the measurement marker to the reference line. This is an example of MKR, ZRO operation for magnitude calibration using a simple transmission test set with a through connection.

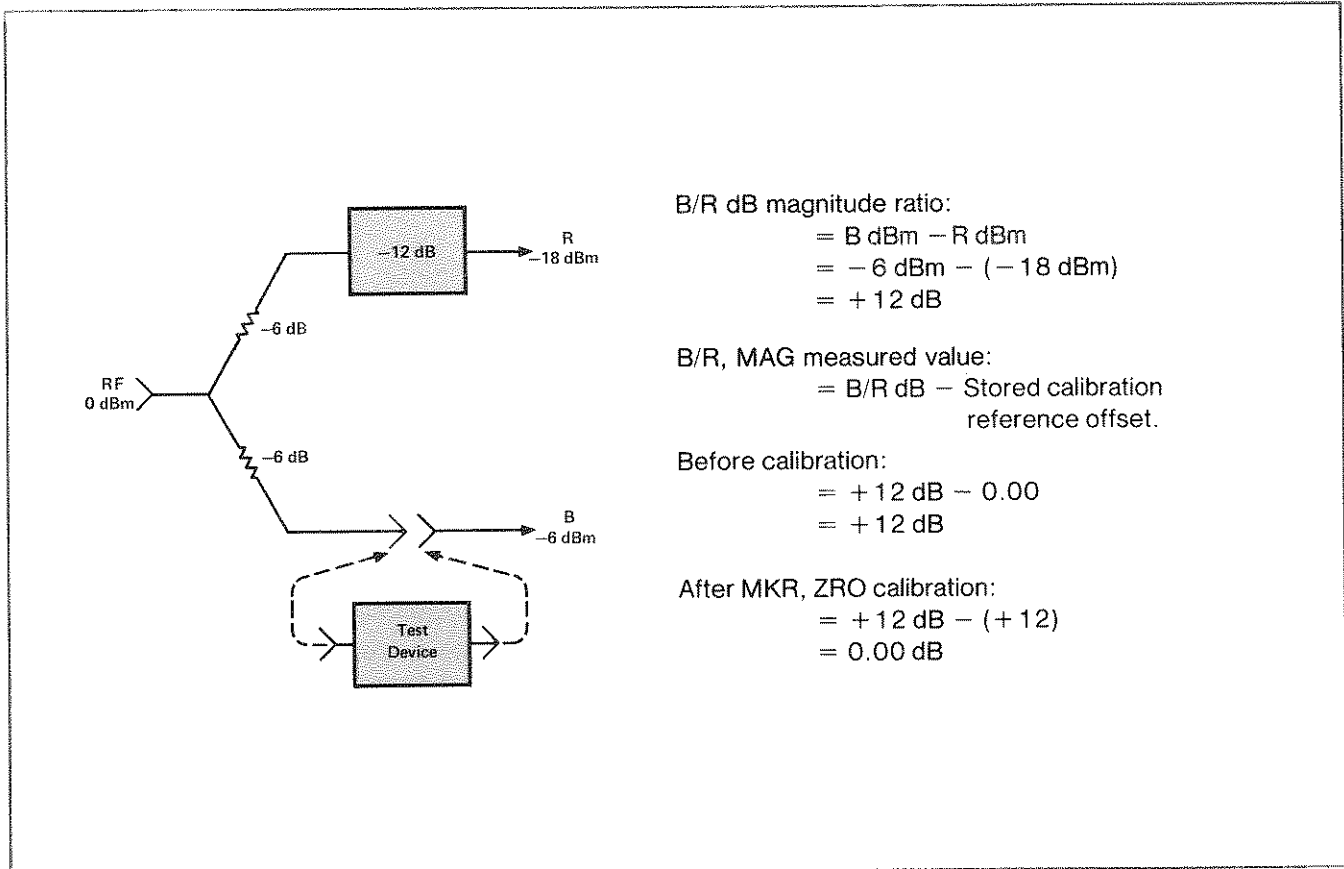

Calibration should be accomplished at higher than or equal to the resolution at which the measurement is to be made. Thus, if high resolution measurements are made, calibration should proceed as a two-step process. First set SCALE/DIV to one of the four left-hand positions, press MKR, then hold ZRO pressed until the display is zero. Now move SCALE/DIV to one of the four right-hand (high resolution) positions and hold ZRO pressed until the display is zero again. Notice that the display decimal point moves one digit to the left during the second step.

Offset values in the calibration registers cannot be displayed. It is not necessary to examine the calibration value following calibration because the value only represents the offset value necessary to remove the test set losses and offsets from the measurement. The absolute value of the measurement is the sum of the calibration offset value, the REF value, and the MKR value, but the instrument automatically subtracts the calibration value from the measurement and the test device response characteristic is represented by the MKR + REF value alone.

Each time ZRO is pressed, a new calibration offset is stored. Thus, for example, if the measurement marker is not at the correct calibration frequency the first time ZRO is pressed, the marker can be moved and ZRO pressed again. Normally, use ZRO only at calibration. CLR can be pressed momentarily to clear the displayed REF value, but holding it for about one second will clear the calibration offset value. Pressing and holding CLR until the REL indicator goes out will make re-calibration necessary.

SET ELECTRICAL LENGTH

Electrical length is equal in the reference and test signal paths when the linear insertion phase response does not vary (is constant) over the frequency sweep of interest. Constant insertion phase is identified by a flat trace in a cartesian measurement, or a small cluster in a polar measurement.

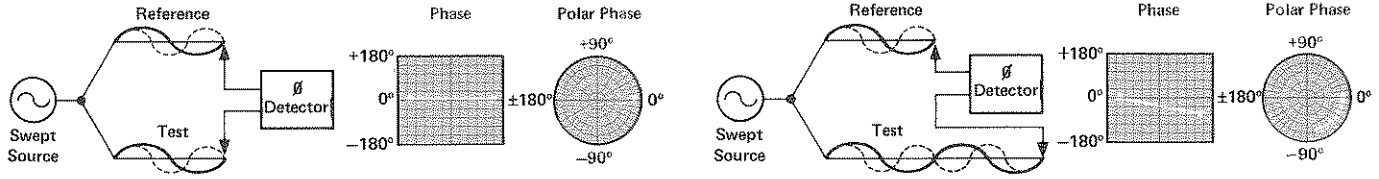

Equal Electrical Length. Phase relationship constant with frequency.

Unequal Electrical Length. Phase relationship shows linear variation with frequency.

On the ELECTRICAL LENGTH part of the control panel, INPUT selects display of the electrical length added to or subtracted from the reference signal path to equalize the A or B test signal path. There are two Electrical Length Offset registers, one for A and one for B. The LENGTH pushbuttons increment the register selected by INPUT, allowing independent equalization of the two test signal paths. Momentarily pressing the CLR button sets the selected register and display to zero. The A and B VERNIERS allow fine length adjustment without changing the LENGTH display or the value stored in the A or B electrical length register. Setting MODE to OFF removes the line length equalization for the test signal path selected by INPUT. Move the INPUT switch to the other position to deselect length for both channels.

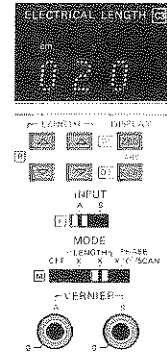

The MODE switch selects the units for electrical length. When MODE is set to x1 and x10, electrical length is introduced in units of meters or centimeters of equivalent air line as shown by the m or cm indicator above the display. When MODE is set to PHASE x10°/SCAN, ten times the displayed degrees of phase shift is introduced over the selected frequency sweep. The linear insertion phase added or subtracted is zero at the beginning of the frequency sweep, increasing linearly to ten times the display degrees at the end of the sweep. This degrees/scan mode allows greater range than the x1 or x10 MODE selection and is usually required for devices with long electrical length.

In the PHASE x10°/SCAN MODE, equivalent electrical length can be calculated from the displayed value using the following computation,

$$\begin{aligned} \text{electrical length (meters)} &= \frac{\text{phase change (degrees)}}{\text{sweep width (Hertz)}} \times \frac{3 \times 10^8 \text{ meters/sec}}{360 \text{ degrees/cycle}} \\ &= \frac{\text{display value} \times (10)}{\text{sweep width (MHz)} \times 1.2} \end{aligned}$$

where display value represents the ELECTRICAL LENGTH display reading, and sweep width represents the total selected frequency sweep in MHz. For example, if it is necessary to add +1350 degrees to flatten the phase response trace and the frequency sweep is from 1100 to 1110 MHz, the equivalent electrical length compensation is:

$$\text{(meters)} = \frac{+1350}{(1110-1100) 1.2} = +112.50 \text{ meters}$$

Electrical length calibration is accomplished by selecting the A or B input, equalizing the electrical length with the calibration standard connected, then pressing the ELECTRICAL LENGTH ZRO button. The displayed value is stored in the selected Stored Electrical Length register as the calibration electrical length offset, and the display is set to zero. The REL indicator lights to indicate that a non-zero calibration value is stored and that the display value is relative to the calibration value. Press and hold CLR until the REL light goes out to reset the stored calibration value to zero. Each time ZRO is pressed, the displayed value is added to the stored calibration value.

TRANSMISSION MEASUREMENTS

This section describes transmission insertion loss and gain, insertion phase, electrical length, deviation from linear phase, and group delay measurements. These measurements are described individually, each with separate setup, calibration, and measurement sequences. For a generalized calibration sequence for all transmission measurements, refer to the S-Parameter Measurements, General Calibration Sequence. Below is a diagram of transmission test connections using the 8502 Transmission/Reflection Test Set.

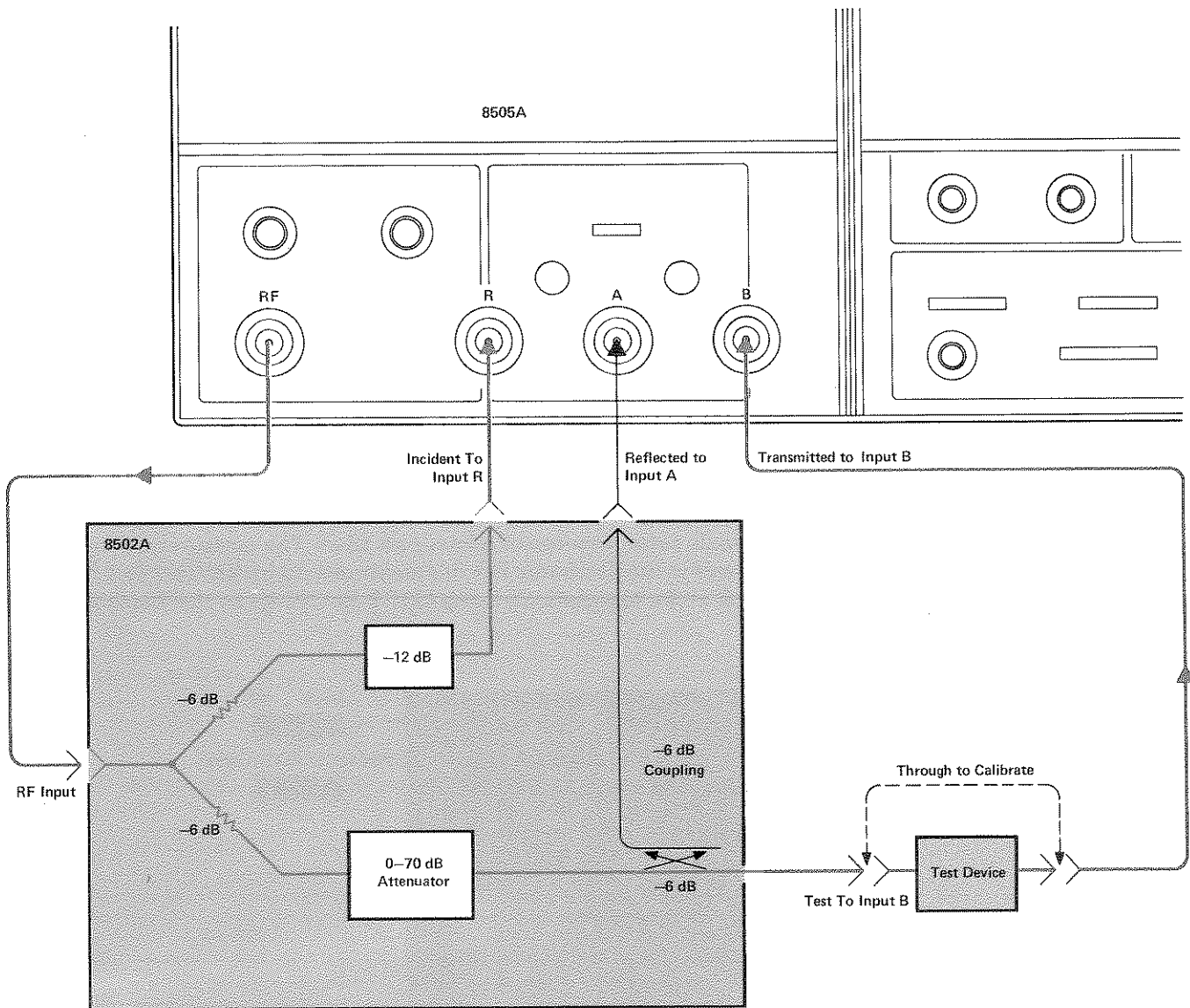

Connections to the test set and test device are made using the cables supplied in the 11851A Cable Kit. The test device input port is connected to the 8502 front panel TEST connector. For transmission calibration, the cable which connects to the device output is connected to the 8502 TEST output. Whatever configuration is used, all cables, adapters, and fixtures required for the measurement should also be used for calibration.

INSERTION LOSS AND GAIN

This sequence lists the steps for a typical insertion loss or gain measurement.

SETUP

- Set signal levels
- Set frequency sweep
- Set CRT display
- MARKERS: 1, position measurement marker so **FREQ COUNTER MHz** reads desired calibration frequency.

CALIBRATION

- Connect through.
- CHANNEL 1:
 - B/R, MAG, 10 dB/division,
 - MKR, ZRO (hold until display zero). ➡

MEASUREMENT

- Connect test device.
- Position measurement marker to read magnitude ratio (MKR + REF) and frequency.

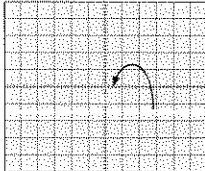

MKR, ZRO moves marker to reference line.

Calibration for insertion loss and gain measurement sets the magnitude ratio between the transmitted and reference signals to zero dB with the through connection. After connecting the test device, a negative measured value indicates insertion loss; a positive measured value indicates gain. Take care to choose signal levels to achieve maximum dynamic range (see page 6).

This figure shows a display of the magnitude ratio response of a bandpass filter. The measurement marker is positioned to the minimum insertion loss point in the passband. For this measurement no REF OFFSET has been added (the 0 dB reference line is positioned at the top graticule using CH1 \blacktriangle or CH2 \blacktriangledown) so the displayed MKR value represents the insertion loss.

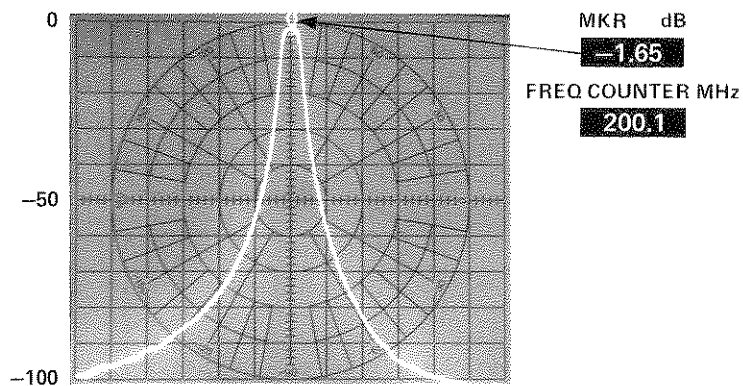

Relative Measurements

To measure the difference between two points on the trace, select MKR display mode, position the measurement marker to the first point, add or subtract REF OFFSET to make the MKR reading zero, then move the marker to the second point. The MKR reading at the second point represents the difference between the two points. Calibration is retained using this sequence and the measured value always represents the sum of the REF and MKR values at any point.

The same operation can be performed without preserving the original calibration value by positioning the marker to the first point, pressing MKR then ZRO (hold until display zero), then moving the marker to the second point. Using this sequence, a new calibration value is stored and all further measured value readings (REF + MKR) will be relative to the first point instead of the original calibration value.

Thus, both sequences are equivalent, but the first sequence retains the original calibration value. These sequences can also be used for magnitude, phase, and delay measurements.

3 dB Frequencies

For example, the insertion loss or gain measurement sequence can be extended to measure the 3 dB points of the filter.

SCALE/DIV: 1 dB/division.

Set frequency sweep to center the passband trace with 3 dB points visible.

Position measurement marker to center of passband or minimum insertion loss point.

MKR, then use REF OFFSET so MKR value is zero.

Move marker so MKR value is -3.00 dB.

Read frequency from FREQ COUNTER MHz.

Move marker to other 3 dB point and read frequency.

CLR (momentarily) to remove REF OFFSET.

Be sure to press CLR momentarily; if held for more than about one second, the REL light will go out indicating that the stored calibration offset has been cleared and recalibration is necessary.

Gain Compression

A sequence similar to that above can be used to measure the 1 dB gain compression output power.

Position measurement marker to frequency of interest.

OUTPUT LEVEL dBm and VERNIER to increase incident power level until magnitude ratio begins to decrease.

MKR, then use REF OFFSET so MKR value is zero.

Increase incident power until MKR value is -1 dB.

The amplifier output level can be estimated by summing the amplifier gain and sweeper output power, then subtracting test set transmission loss. A more precise measurement can be made by connecting the test device output directly to the B input and measuring the absolute power level by selecting B, MAG (see page 25).

INSERTION PHASE

This sequence lists the steps for a typical insertion phase measurement.

SETUP

Set signal levels.

Set frequency sweep.

Set CRT display.

MARKERS: 1, position measurement marker so FREQ COUNTER MHz reads desired calibration frequency.

CALIBRATION

Connect through.

CHANNEL 1:

B/R, PHASE, 90 degrees/division.

ELECTRICAL LENGTH:

B, MODE as required (usually x1 or x10),

CLR if REL lighted,

LENGTH AND VERNIER B for flat response. ➡

CHANNEL 1:

MKR, ZRO (hold until display zero).

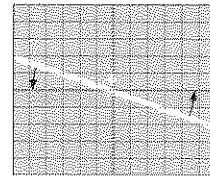

Center marker, press MKR, then press and hold CHANNEL 1 ZRO while adjusting LENGTH.

MEASUREMENT

Connect test device.

Electrical length MODE (and sweep width if PHASE x10°/SCAN selected) same as calibration.

Position measurement marker to read insertion phase (MKR + REF) and frequency.

This figure shows a bandpass filter insertion phase. The 8505A phase measurement range is +180 to -180 degrees, and the vertical line represents the transition between these values. Thus, the trace between any two of these transition lines represents 360 degrees of phase shift.

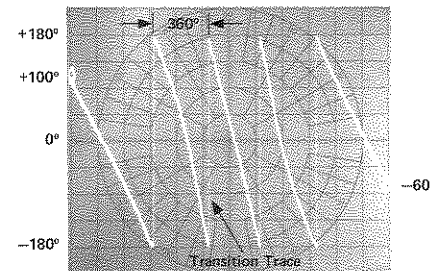

To illustrate the display format, determine the total phase shift for the selected sweep width as follows: Position the measurement marker as far to the left as possible before the FREQ COUNTER MHz display blanks. Read the phase value (+100° in this example) and determine the total number of degrees before the first transition trace (100 + 180). Next count the second and following transition traces and multiply by 360 (2 x 360). Now determine the number of degrees from the last transition trace to the right edge of the screen (180 + 60). The sum of these values represents the total phase shift over the frequency sweep.

$$(100 + 180) + (3 \times 360) + (180 + 60) = 1600^\circ$$

When the transmitted signal is below the noise floor for insertion phase measurements the CRT trace usually reads zero degrees.

ELECTRICAL LENGTH

This sequence lists the steps for a typical measurement of equivalent electrical length.

SETUP

- Set signal levels.
- Set frequency sweep.
- Set CRT display.

CALIBRATION

Connect through

CHANNEL 1:

B/R, PHASE, 90 degrees/division

ELECTRICAL LENGTH:

B, MODE as required (usually PHASE x10°/SCAN),

CLR if REL lighted,

LENGTH and VERNIER B for flat response,  ZRO.

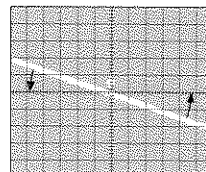

Center marker, press MKR, then press and hold CHANNEL 1 ZRO while adjusting LENGTH.

MEASUREMENT

Connect test device

Electrical length MODE (and sweep width if PHASE x10°/SCAN selected

must be same as calibration.

ELECTRICAL LENGTH:

LENGTH for flat response over frequency range of interest. If MODE set to x1 or x10 read equivalent electrical length of test device from ELECTRICAL LENGTH display, or, if MODE set to PHASE x 10°/SCAN, calculate equivalent electrical length of test device using

$$\text{meters} = \frac{\text{display value} \times 10}{\text{sweep width (MHz)} \times 1.2}$$

This measurement determines the linear insertion phase required to equalize the electrical length of the reference and test channels with the test device installed. Note that if PHASE x10°/SCAN is selected the sweep width cannot be changed without affecting the calibration; if x1 or x10 is selected, changing sweep width does not affect calibration. To avoid the electrical length calculation required when the PHASE x10°/SCAN mode is selected, measure electrical length with a frequency sweep width of 8.333 MHz. With this sweep width, the ELECTRICAL LENGTH display reads the length in centimeters directly.

The wide range of the electrical length controls allow great latitude in the test setup, but you should recognize the limitations. For best accuracy in phase and electrical length measurements the maximum values listed below for electrical length should not be exceeded.

ELECTRICAL LENGTH MODE	RANGE MHz		
	0.5 - 13	0.5 - 130	0.5 - 1300
x1	±19.9 m	±1.99 m	±19.9 cm
x10	±100 m	±10.0 m	±100 cm
PHASE x10°/SCAN	±1700°	±1700°	±1700°

The values represent the sum of the calibration value and any length added during the measurement. Above these values insertion phase linearity is degraded.

DEVIATION FROM LINEAR PHASE

This sequence lists the steps for a typical measurement of deviation from linear phase.

SETUP

- Set signal levels.
- Set frequency sweep.
- Set CRT display.

CALIBRATION

Connect through.

CHANNEL 1:

B/R, PHASE, 90 degrees/division.

ELECTRICAL LENGTH:

B, MODE as required (usually PHASE $\times 10^\circ/\text{SCAN}$),

CLR if REL lighted,

LENGTH AND VERNIER B for flat response. 

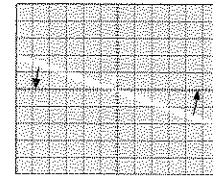

Center marker, press MKR, then press and hold CHANNEL 1 ZRO while adjusting LENGTH.

MEASUREMENT

Connect test device.

Electrical length MODE (and sweep width if PHASE $\times 10^\circ/\text{SCAN}$ selected) must be same as calibration.

ELECTRICAL LENGTH:

LENGTH and VERNIER B for flat phase response in frequency range of interest.

Position measurement marker to read phase deviation.

Measuring deviation from linear phase is an alternative to measuring group delay made possible by the range of the 8505 electronic line stretcher. Insertion phase consists of two components, linear and non-linear. Deviation from linear phase is a measure of the non-linear component of insertion phase. By compensating for the linear insertion phase component using the electrical length controls, the deviation from linear phase over the frequency sweep can be measured directly. Compared to group delay, deviation from linear phase is a fundamental measurement because delay is the derivative of phase change with frequency. Also, greater phase sensitivity allows a greater dynamic range than group delay measurements, and deviation from linear phase will produce greater detail in areas where the phase response changes rapidly over a small frequency change.

This figure shows how introducing linear insertion phase (electrical length) allows determination of non-linear insertion phase.

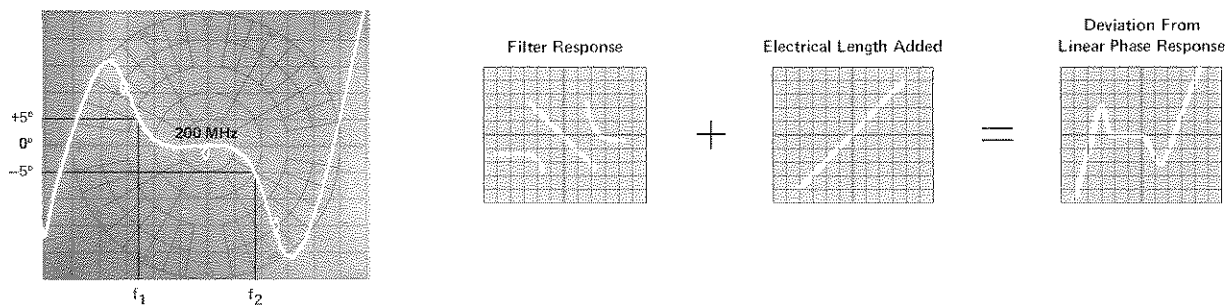

Note that the same maximum electrical length considerations as for the electrical length measurements (page 19) must be observed. If the network exhibits large phase changes with frequency, reduce the sweep width and make a series of measurements over the frequency range of interest. This example shows the deviation from linear phase of a bandpass filter with markers at the 3 dB frequencies. Even if the network must be specified in terms of group delay, the deviation from linear phase measurement serves as a good check of the actual phase response. Using the dual-trace capability of the 8505A, compare deviation from linear phase with the network group delay as described on the next page.

GROUP DELAY

This sequence lists the steps for a typical group delay measurement.

SETUP

Set signal levels.

Set frequency sweep.

Set CRT display.

MARKERS: 1, position measurement marker so FREQ COUNTER MHz reads desired calibration frequency.

CALIBRATION

Connect through.

CHANNEL 1:

B/R, DLY, 100 nanoseconds/division,

MKR, ZRO (hold until display zero).

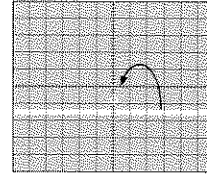

MKR, ZRO moves marker to reference line.

MEASUREMENT

Connect test device.

Position measurement marker to read group delay (MKR REF) and frequency.

A device with no phase distortion presents a linear insertion phase characteristic. Group delay will thus appear as a flat horizontal line. This figure shows that group delay varies as a function of frequency when the test device exhibits deviation from linear phase.

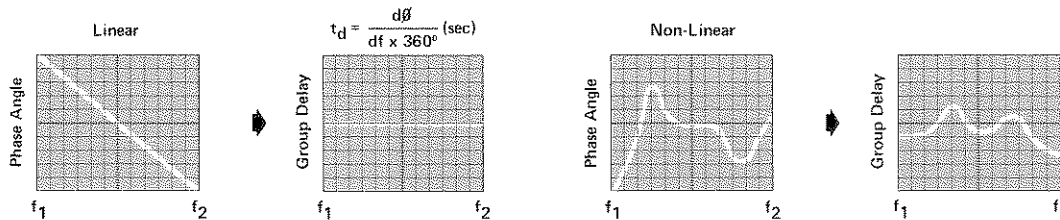

With slow sweep times or narrow frequency sweeps the instrument switches from the continuous mode to a sample mode in order to maintain the best signal-to-noise ratio for the measurement. Maximum sample rate is 1000 samples per second. If the test device bandwidth will permit fast sweeps, increase the sweep speed until the instrument switches to the analog mode, then slow the sweep speed until just before the switch to sampling. If not, slow to ≈ 1 sec/sweep and use the sample mode with video filtering.

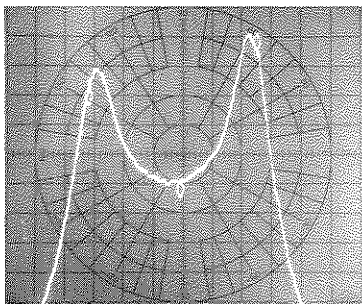

Continuous Mode. For best accuracy slow sweep until just before sampling.

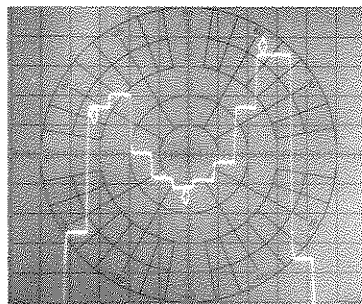

Sample Mode. Fast sweep means a small number of large samples.

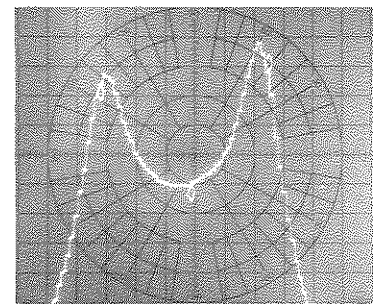

Sample Mode. For best accuracy slow to less than one second per sweep.

The maximum group delay which can be displayed depends upon the RANGE MHz selection as follows: 0.5-13, ± 80 microseconds; 0.5-130, ± 8 microseconds; and 0.5-1300, ± 800 nanoseconds and is the sum of the calibration offset value and the actual measured value.

REFLECTION MEASUREMENTS

This section describes return loss and reflection coefficient measurements. These measurements are described individually, each with separate setup, calibration, and measurement sequences. For a generalized calibration sequence for all reflection measurements, refer to the S-Parameter Measurements, General Calibration Sequence. Below is a diagram of reflection test connections using the 8502 Transmission/Reflection Test Set.

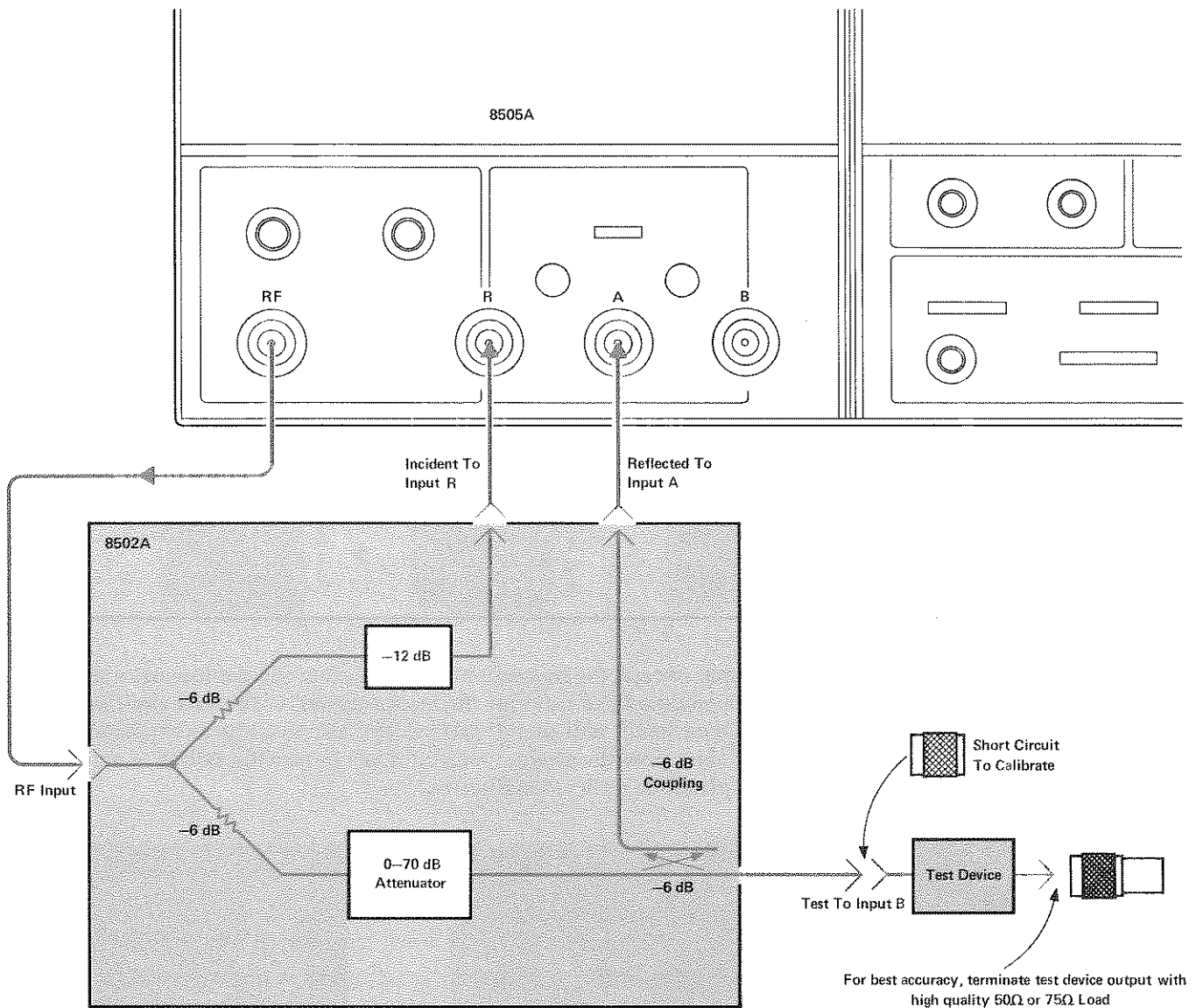

Connections to the test set and test device are made using the cables supplied in the 11851A Cable Kit. The test device input port is connected to the 8502 front panel TEST connector. For reflection calibration, connect the short circuit at the same point to which the test device will be connected. Whatever configuration is used, all cables, adapters, and fixtures required for the measurement should also be used during calibration.

RETURN LOSS

This sequence lists the steps for a typical return loss measurement.

SETUP

Set signal levels.

Set frequency sweep.

Set CRT display.

MARKERS: 1, position measurement marker so FREQ COUNTER MHz reads desired calibration frequency.

CALIBRATION

Connect short.

CHANNEL 1:

A/R, MAG, 10 dB/division,

MKR, ZRO (hold until display zero). 

MEASUREMENT

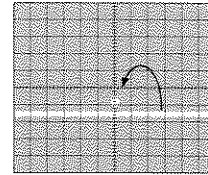

Connect test device.

Position measurement marker to read magnitude ratio (MKR + REF) and frequency.



MKR, ZRO moves marker to reference line.

Calibration for return loss sets the magnitude ratio between the reflected and reference signals to zero dB with the short circuit. After connecting the test device a negative value indicates that the reflected signal magnitude is less than the reference signal magnitude.

This figure shows a display of the return loss of a bandpass filter. The measurement marker is positioned to the minimum return loss point in the passband. The 0 dB reference line is set to the center graticule using CH1  or CH2  and no REF OFF-SET has been added, so the absolute value of the MKR reading is the return loss measured value.

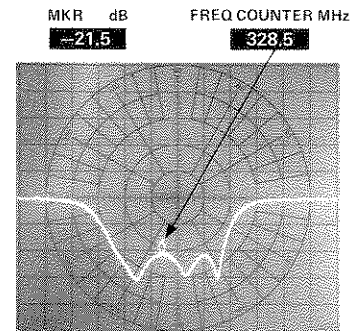

Standing wave ratio, SWR, can be calculated from the return loss measured value using the HP Reflectometer Calculator or these equations:

$$\rho = 10^{D/20} \quad \text{where } D = \frac{\text{measured value (dB)}}{20}$$

$$\text{SWR} = \frac{1 + \rho}{1 - \rho}$$

For example, if the measured magnitude ratio is -30 dB, ρ is 0.032 and the SWR is 1.07.

REFLECTION COEFFICIENT

This sequence lists the steps for a typical reflection coefficient measurement.

SETUP

- Set signal levels.
- Set frequency sweep.
- Set CRT display, polar beam center.
- MARKERS: 1, position measurement marker so **FREQ COUNTER MHz** reads desired calibration frequency.

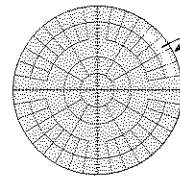

MKR, ZRO moves marker to outer circle.

CALIBRATION

- Connect short.
- CHANNEL 1:
 - A/R, POLAR MAG, POLAR FULL 1,
 - MKR, ZRO (hold until display zero),
- ELECTRICAL LENGTH:
 - A, MODE as required (usually x1 or x10), CLR if REL lighted, LENGTH and VERNIER A for smallest cluster.

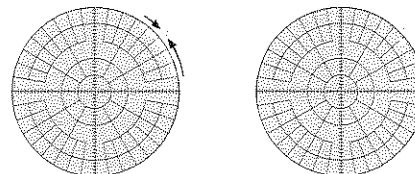

LENGTH to shorten trace.

- CHANNEL 1:
 - POLAR PHASE.
 - MKR, ZRO (hold until display zero),
 - REF,
 - REF OFFSET so display reads ± 180 degrees,
 - ZRO,
 - MKR.

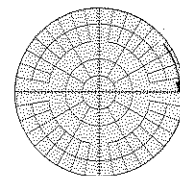

MKR, ZRO moves marker to zero degrees reference line.

MEASUREMENT

- Connect test device.
- Electrical length MODE (and sweep width if PHASE x10°/SCAN selected) same as calibration.
- Read $\rho \angle \phi$ at any point from polar display or:
 - POLAR MAG,
 - Position measurement markers to read magnitude ratio (MKR + REF) and frequency.
- Calculate ρ using

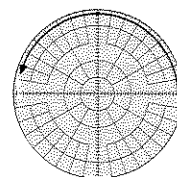

REF OFFSET and REF ZRO moves marker to ± 180 degrees.

$$\rho = 10^{\frac{D}{20}} \quad \text{where } D = \frac{\text{return loss (dB)}}{20}$$

- POLAR PHASE,
- Read $\angle \phi$ value (MKR + REF).

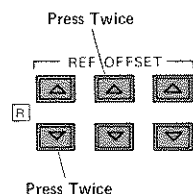

Impedance — Using Smith Chart

Impedance can be read directly from the polar display reflection coefficient by installing a Smith chart overlay. Smith chart overlays are supplied with the 8505 in four versions, 3.16, 1.0, 0.5, 0.2, and 0.1 full scale linear coefficient value of the outer circle. For the 3.16 full scale version use REF OFFSET to set the REF value to +10 dB in POLAR MAG and select POLAR FULL 1. For the other overlays, set the REF value to zero and select the POLAR FULL value corresponding to the full scale value of the Smith Chart.

MKR dB MKR DEG FREQ.COUNTER MHz
 -15.0 +46.0 196.2

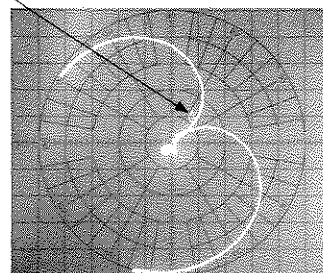

POWER LEVEL MEASUREMENTS

With the INPUT switch set to R, A, or B and the MODE switch set to MAG, the 8505 measures the absolute power level in dBm at the R, A, or B input. Some applications for this capability are: measuring and setting actual reference, reflected and transmitted signal levels into the R, A, and B inputs prior to calibration; verifying signal levels at various points in the test setup including actual incident and transmitted power; and direct measurement of losses in the test set, cables, and fixtures.

R, A, or B, MAG.

CLR (hold for 2 sec if REL lighted).

SCALE/DIV and REF OFFSET to position trace.

Position measurement marker to read measured dBm value (MKR + REF)

If desired, convert dBm to mW using

$$\text{mW} = 10^{\frac{\text{dBm}}{10}}$$

The dBm difference between an R, MAG and a B, MAG measurement may not be identical to the B/R, MAG measured value. The 8505A measures ratio values (A/R, B/R) with greater accuracy than absolute power.

S-PARAMETER MEASUREMENTS

Using the 8503A S-Parameter Test Set with the 8505A you can measure both forward and reverse transmission and reflection characteristics without disconnecting the test device. This illustration shows a typical 8505A/8503A installation. Use the 19 cm Type N cables supplied with the 8503A to connect RF, R, A, and B on the 8505A and 8503A front panels.

Be sure to connect the supplied test set interconnection cable between the 8505A TEST SET INTER-CONN connector on the rear of the signal processor and the SIGNAL PROCESSOR INTER-CONNECT connector on the rear of the 8503A test set.

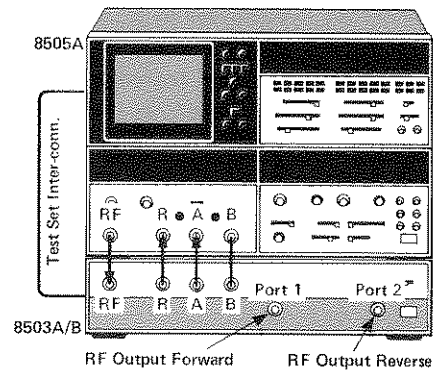

The 8503A front panel FORWARD/REVERSE control switches the incident RF to Port 1 for FORWARD or Port 2 for reverse. These illustrations show the functions of the 8505A R, A, and B connections in FORWARD and REVERSE.

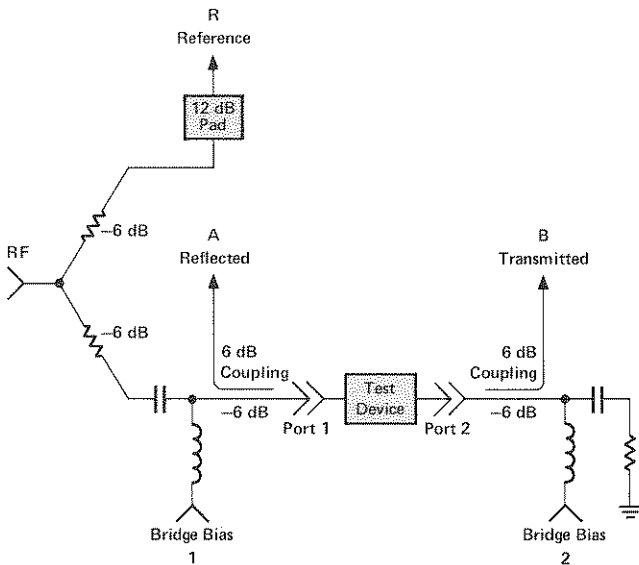

Forward. Incident wave at Port 1.

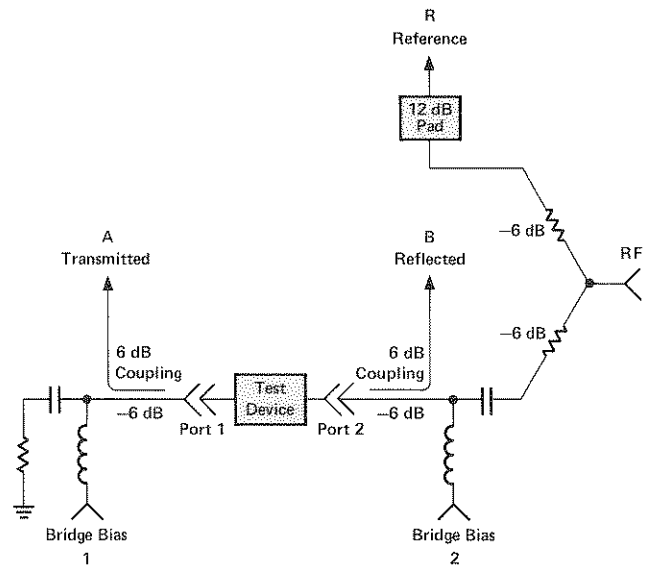

Reverse. Incident wave at Port 2.

With these connections, the forward (input) and reverse (output) parameters as follows:

FORWARD

$$S_{21} = B/R = \text{Forward Transmission Coefficient}$$

$$S_{11} = A/R = \text{Input Reflection Coefficient}$$

REVERSE

$$S_{12} = A/R = \text{Reverse Transmission Coefficient}$$

$$S_{22} = B/R = \text{Output Reflection Coefficient}$$

Thus, the forward calibrations and measurements are made in exactly the same way as described in the previous Transmission and Reflection Measurements sections. For reverse measurements the 8505 A and B inputs exchange transmission and reflection functions.

Connecting the 8503A test set rear panel interconnection cable to the 8505A signal processor enables a second set of Reference Offset, Stored Reference Offset, Electrical Length Offset, and Stored Electrical Length Offset registers, allowing independent storage of forward and reverse magnitude, phase, delay, and electrical length calibrations.

Connections to the test device should be made using the 11857A Test Port Extension Cables or with the 11608A Transistor Fixture. As shown in the following illustrations, you may connect the test device directly to the 8503A Port 1 or Port 2. Using two cables balances the electrical length of the test set up. Connecting the device directly to the 8503A port may reduce reflection errors at one port by reducing cable and adapter reflections. Whatever configuration is used, all cables, adapters, and fixtures, required to make the measurement should also be used during calibration.

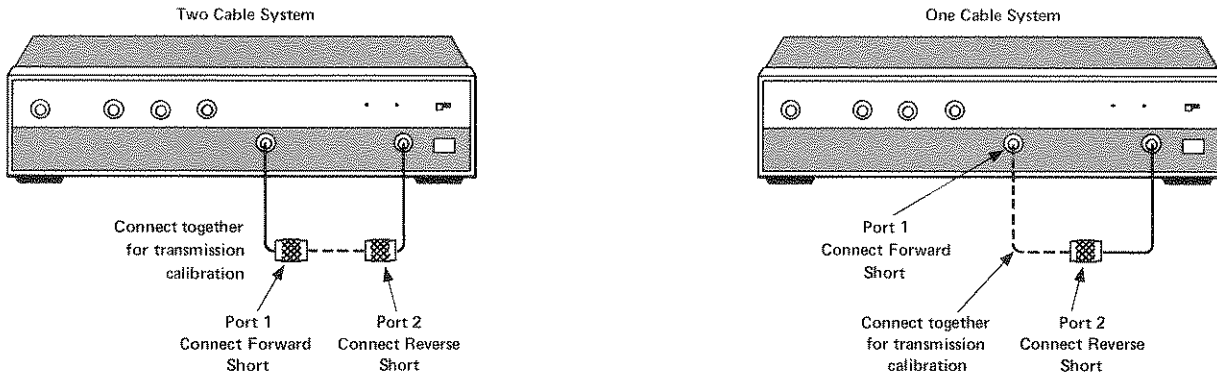

Transistor Bias

BRIDGE BIAS 1 and 2 on the 8503A rear panel provide connections for ± 30 Vdc, ± 200 mA bias when measuring transistors. Use a dual dc power supply, such as the HP 6205B, that is designed for use with bias tees optimized for RF applications. (The HP 8717B Transistor Bias Supply is not compatible with the 8503A; it is designed for bias tees optimized for microwave frequencies and may cause the test device to oscillate).

For common emitter configurations, bias is established by setting V_{ce} to the desired voltage then monitoring I_c as V_{be} in combination with resistor R_1 establishes the base current.

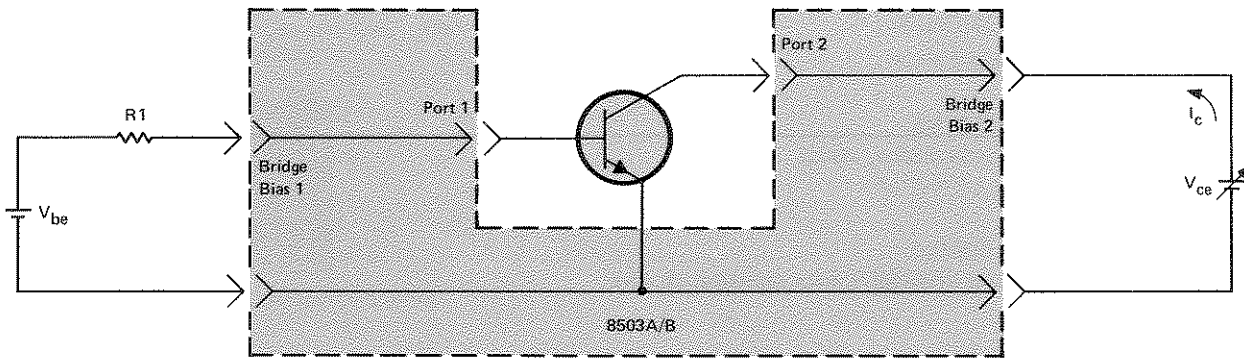

For common base configurations, bias is established by setting V_{cb} to the desired voltage then monitoring I_e as V_{eb} in combination with R_1 establishes emitter current.

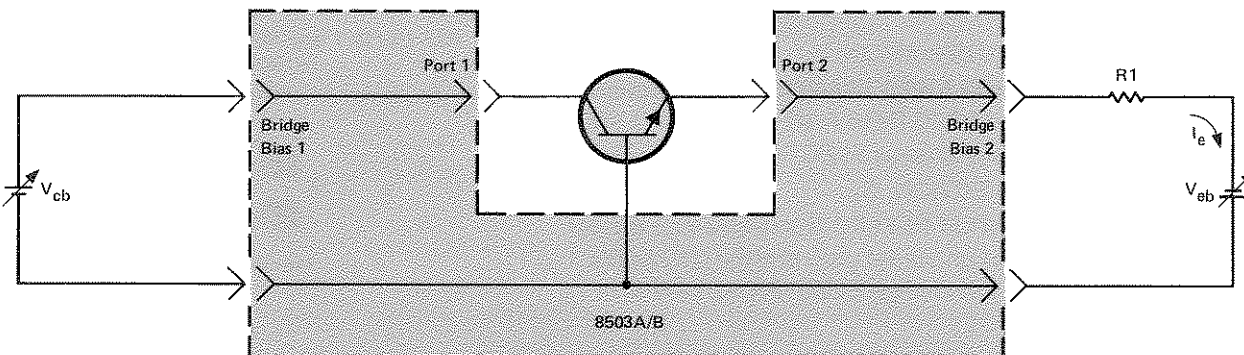

GENERAL CALIBRATION SEQUENCE

When testing most two port test devices it will probably be most convenient to perform complete forward and reverse transmission and reflection calibrations at one time. This sequence lists the steps for complete forward and reverse transmission and reflection calibration for all measurements.

SETUP

- Set signal levels.
- Set frequency sweep.
- Set CRT display; polar beam center.

MARKERS: 1, position measurement marker so **FREQ COUNTER** MHz reads desired calibration frequency.

FORWARD TRANSMISSION: S_{21} , Electrical Length, and Group Delay

- Select 8503 FORWARD
- Connect through.

CHANNEL 1:

- B/R, POLAR MAG, POLAR FULL 1, MKR, ZRO (hold until display zero).

ELECTRICAL LENGTH:

- B, MODE as required, CLR if REL lighted, LENGTH and VERNIER B for smallest cluster, ZRO.

CHANNEL 1:

- POLAR PHASE, ZRO (hold until display zero), DLY, ZRO (hold until display zero).

INPUT REFLECTION: S_{11}

- Connect forward short.

CHANNEL 1:

- A/R, POLAR MAG, ZRO (hold until display zero),

ELECTRICAL LENGTH:

- A, CLR if REL lighted, LENGTH and VERNIER A for smallest cluster, ZRO.

CHANNEL 1

- POLAR PHASE, ZRO (hold until display zero), REF, REF OFFSET so display reads ± 180 degrees, ZRO, MKR.

REVERSE TRANSMISSION: S_{12}

- Use above FORWARD TRANSMISSION sequence except select 8503 REVERSE, change CHANNEL 1 B/R to A/R, and change ELECTRICAL LENGTH B to A.

OUTPUT REFLECTION: S_{22}

- Use above INPUT REFLECTION sequence except connect short on output port, change CHANNEL 1 A/R to B/R, and change ELECTRICAL LENGTH A to B.

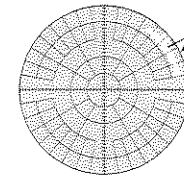

MKR, ZRO moves marker to outer circle.

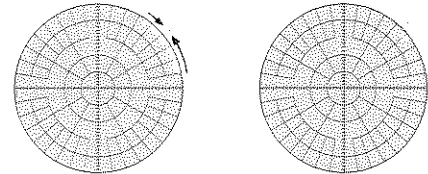

LENGTH to shorten trace.

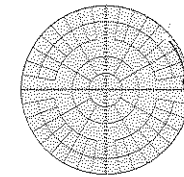

MKR, ZRO moves marker to zero degrees reference line.

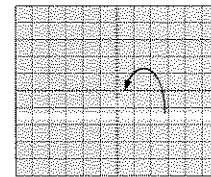

MKR, ZRO moves marker to reference line.

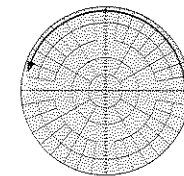

REF OFFSET and REF ZRO moves marker to ± 180 degrees.

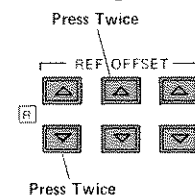

The measured value for any of the S-Parameters can be read directly from the polar display graticule. The magnitude ratio, τ for transmission or ρ for reflection, is read from the concentric circles and the angle, ϕ , read from the radial lines. (Also see page 11).

Magnitude and phase values can also be read using the measurement marker as follows:

Position measurement marker to desired point on trace.
 Select A/R or B/R.
 Select POLAR MAG.
 Read magnitude ratio (MKR + REF).
 Calculate linear magnitude coefficient using:

$$\tau \text{ or } \rho = 10^{\frac{D}{20}} \quad \text{where } D = \frac{\text{Measured Value}}{20}$$

Select POLAR PHASE
 Read phase angle, $\angle \phi$, (MKR + REF).

The S-Parameter displayed is determined by combination of the 8503 S-PARAMETER SELECT switch and 8505 CHANNEL 1 or CHANNEL 2 INPUT switch position.

S-PARAMETER	8503A S-PARAMETER SELECT	8505A INPUT	MEASUREMENT
S_{11}	FORWARD	A/R	INPUT REFLECTION
S_{21}	FORWARD	B/R	FORWARD TRANSMISSION
S_{12}	REVERSE	A/R	REVERSE TRANSMISSION
S_{22}	REVERSE	B/R	OUTPUT REFLECTION

For a device with greater than unity gain, the transmission coefficient will exceed 1 and REF OFFSET must be added to place the full trace within the outer circle. Adding 20 dB of REF OFFSET changes the polar full values by a factor of 10 as shown.

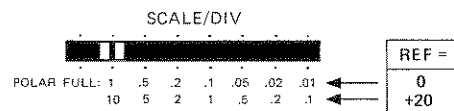

Electrical Length, Deviation from Linear Phase, Group Delay

These measurements can be made in the forward or reverse direction using the measurement sequences described in the Transmission Measurements section.

Return Loss

Return loss can be measured using FORWARD, A/R or REVERSE, B/R in either MAG or POLAR MAG mode. Refer to the Return Loss measurement sequence in the Reflection Measurements section.

Impedance — Using Smith Chart

Impedance can be read directly from the polar display of reflection coefficient (S_{11} or S_{22}) by installing a Smith Chart overlay. Smith chart overlays are supplied with the 8505A in four versions: 3.16, 1.0, 0.5, 0.2, and 0.1 full scale linear coefficient value of the outer circle. For the 3.16 full scale version use REF OFFSET to set the REF value to +10 dB in POLAR MAG and select POLAR FULL 1. For the others, set the REF value to zero and select the POLAR FULL value corresponding to the full scale value of the Smith Chart.

THE 8501A STORAGE-NORMALIZER

The 8501A provides independent processing and storage for both 8505A measurement channels. It serves as display memory for the 8505A by digitizing and storing measurement data at the 8505A sweep rate then outputting the processed trace to the CRT at a fixed display rate. Computational capabilities permit real time averaging and normalization, and the magnifier can increase display resolution. Also, key 8505A Channel 1 and 2 measurement parameters are displayed as labels on the CRT.

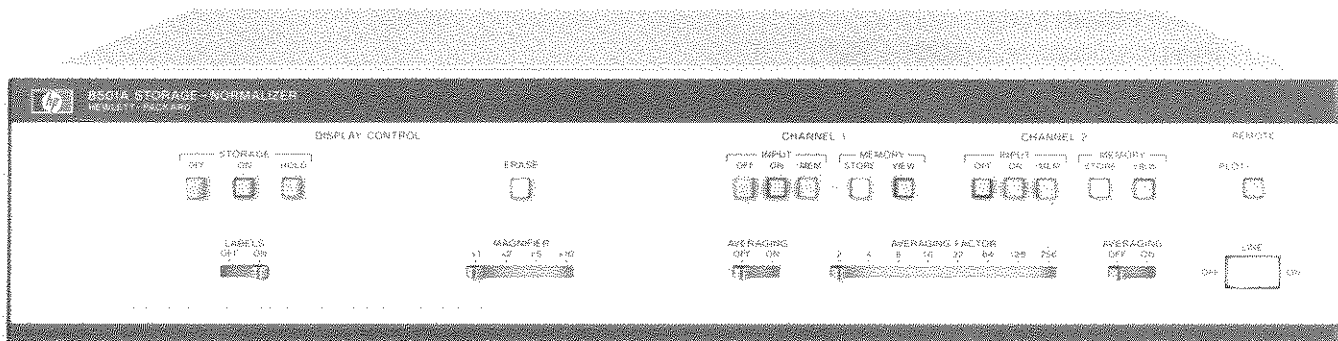

With 8501A STORAGE ON the 8501A controls all information presented on the 8505A CRT display. The MKR and REF values on the 8505A measured value displays are not affected by 8501A processing. All 8505A setup, calibration, and measurement sequences described in this note can be accomplished with STORAGE ON but the labeling interface must be connected to display the reference line or beam center. Selecting 8501A STORAGE OFF bypasses the 8501A and returns the 8505A CRT to conventional analog operation.

To familiarize yourself with operation of the 8501A make these control settings then proceed with the following paragraphs:

STORAGE OFF, LABELS OFF, MAGNIFIER X1,
Channel 1 and Channel 2 INPUT OFF, MEMORY VIEW OFF.

Digital Storage

When the device response characteristic requires a slow sweep to avoid distortion of the measurement, select

STORAGE ON,
Channel 1 and/or Channel 2 INPUT ON.

Cartesian traces are digitized at 500 frequency points on the X axis and 500 points on the Y axis, with $\pm 50\%$ overrange on the Y axis available to digitize an off-scale trace. Similarly, polar traces are digitized at 250 frequency points with $\pm 50\%$ overrange for both the X and Y axis. Changing the reference line or beam center position away from the middle of the CRT moves off-scale points onto the display.

INPUT OFF blanks the Channel 1 or Channel 2 trace. STORAGE HOLD freezes the CRT display for photography or further analysis and memory is not updated with new data on subsequent sweeps. ERASE completely clears 8501A memory of all stored information.

Labels

Select LABELS ON. Sweep mode and frequencies appear at the bottom of the CRT and measurement mode selections, including the MKR value, appear at the top of the CRT. 8505A Channel 1 and/or Channel 2 MODE switches must be set to other than OFF for the labels to appear.

Averaging

Both accuracy and resolution are improved when averaging is used to remove random noise variations from measurements. To use averaging, select

ERASE (momentary),
Channel 1 and/or Channel 2 AVERAGING ON,
AVERAGING FACTOR as required.

8501A averaging acts as a "digital" video filter, performing an exponential running average on the data at each frequency point. The current trace has the weight $1-1/n$ and the new trace has the weight $1/n$ where n is the selected AVERAGING FACTOR. Select an averaging factor appropriate for the sweep rate and degree of signal-to-noise improvement desired, noting that $2n$ sweeps are required to converge to 86% of the final value and $4n$ sweeps are required to reach 98%. Signal-to-noise improvement increases with \sqrt{n} .

These CRT photos illustrate the improvement in group delay measurement accuracy obtained by averaging.

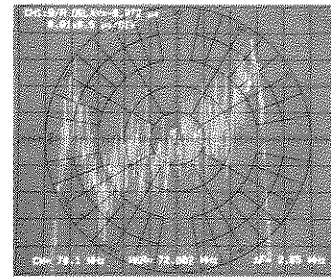

Noisy Group Delay Measurement

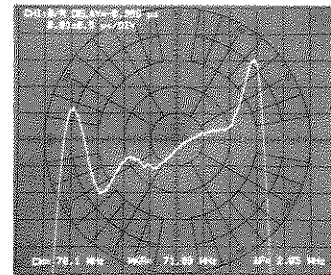

After Averaging

Magnification

High resolution displays at up to 0.01 dB, 0.1 degree, and 0.1 nanosecond per division are accomplished using the MAGNIFIER switch to expand the 8505A SCALE/DIV selection. For example, with 0.1 dB/division set at the 8505A and MAGNIFIER X10 selected, the CRT display resolution is 0.01 dB/division. The data stored in memory is amplified prior to display and the MAGNIFIER expands the trace about the reference line or beam center position. Frequency response of a cable using a 500 MHz sweep width and 0.01 dB/division is shown in this display. Digitizer resolution produces the step effect; each step represents a 0.002 dB change.

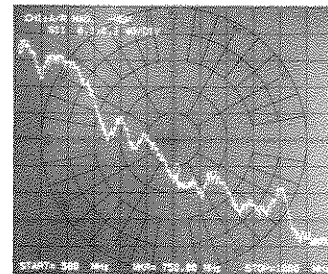

Passband Ripple at 0.01 dB/division using x10 magnification.

Normalization

Normalization is the process of storing a reference trace in memory and then automatically subtracting the reference trace from the incoming trace and displaying the difference. Typical applications are to remove frequency response characteristics of the test setup from the measurement or to make a comparison measurement in which the test device is matched to a standard. Normalization is independent for Channel 1 and Channel 2 and is ordinarily used only for cartesian displays. To normalize:

Connect standard (open, short, through, or standard device),
8505A SCALE/DIV same as for measurement,
MEMORY STORE (momentary),
INPUT—MEM,
Connect test device.

When MEMORY STORE is pressed, the displayed trace is transferred to reference memory. Selecting INPUT—MEM displays the difference between the reference trace and the current trace, resulting in a flat trace at the reference line if the reference trace and the current trace are identical.

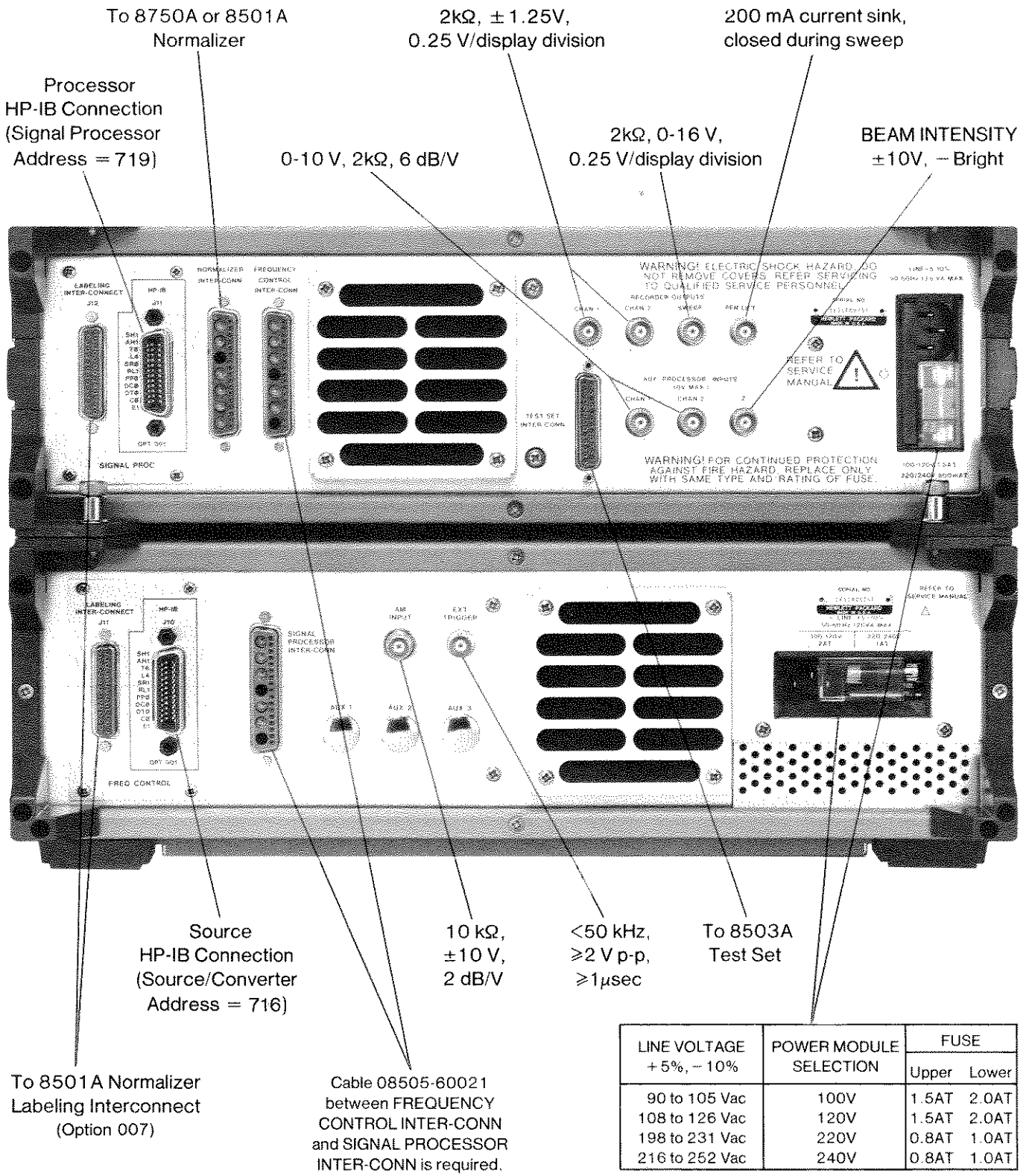

8505A Rear Panel Connections

CONTROLS AND DISPLAYS SUMMARY

CRT DISPLAY — The response of both measurement channels can be displayed simultaneously with magnitude and phase response displayed in either cartesian or polar format.

BEAM CONTROLS — Independent cartesian reference line position controls for each channel, beam center for both channels, and standard controls for beam and scale.

IF and VIDEO BANDWIDTH — Select either 10 kHz or 1 kHz IF bandwidth, and 30 Hz post detection video filter to smooth trace.

SWEEPER OUTPUT — Sweeper output at RF connector is sum of step attenuator and VERNIER settings.

REFERENCE AND TEST INPUTS - Three identical inputs for absolute or ratio measurements. Each input has a measurement range from -10 dBm to -110 dBm. Slide switch selects maximum input level applied at R, A, and B inputs for linear operation. OVERLOAD indicators above inputs light when level exceeded.

FREQUENCY SCAN CONTROLS AND DISPLAYS — RANGE MHz selects frequency range. MODE selects log and linear scans of full range or linear expanded scans selected by WIDTH. With MODE in LOG FULL or LIN FULL, WIDTH selections display down-pointing markers to identify end points of stored frequency displayed by the FREQUENCY MHz displays and set by the FREQUENCY controls. Moving MODE to LIN EXPAND selects the frequency stored for the WIDTH selection.

MEASUREMENT MARKERS — The rotary MARKERS switch selects measurement marker 1 through 5. The adjacent numbered vernier controls marker position on trace. The FREQ COUNTER MHz display is blank when the measurement is not accurate. At positions 2 thorough 5, deselected markers point down, the selected marker points up.

FREQUENCY COUNTER — Displays frequency of measurement marker selected by MARKERS. Resolution is controlled by RANGE MHz and SCAN TIME SEC. OVERFLOW indicates one or more most significant digits are shifted off left of display. Select fast scan time to inspect most significant digits, and slower scan time to inspect least significant digits.

ELECTRICAL LENGTH — Display shows equivalent electrical length or linear insertion phase added to reference channel to equalize electrical length in reference and A and B test signal paths depending upon INPUT and MODE selections. LENGTH buttons increment the displayed value. CLR (momentary) zeros display; CLR (hold until REL out) clears stored calibration; ZRO stores displayed value as calibration and zeros display.

CHANNEL 1 and CHANNEL 2 — Two identical, independent measurement channels. INPUT and MODE select measurement trace displayed on CRT. LED displays show the reference line value (REF button pressed), or measurement marker displacement from reference line (MKR button pressed). Measured value at marker is sum of REF and MKR values. REF OFFSET buttons increment the reference line value stored in separate magnitude, phase, and delay reference offset registers for each channel. CLR (momentary) resets the reference line value to zero; CLR (held until REL out) clears stored reference offset calibration. ZRO stores the calibration reference offset for selected measurement.

Channel 1 and Channel 2 Measured Value Controls and Displays

Beam Controls

IF and Video Bandwidth

Dual-Trace CRT

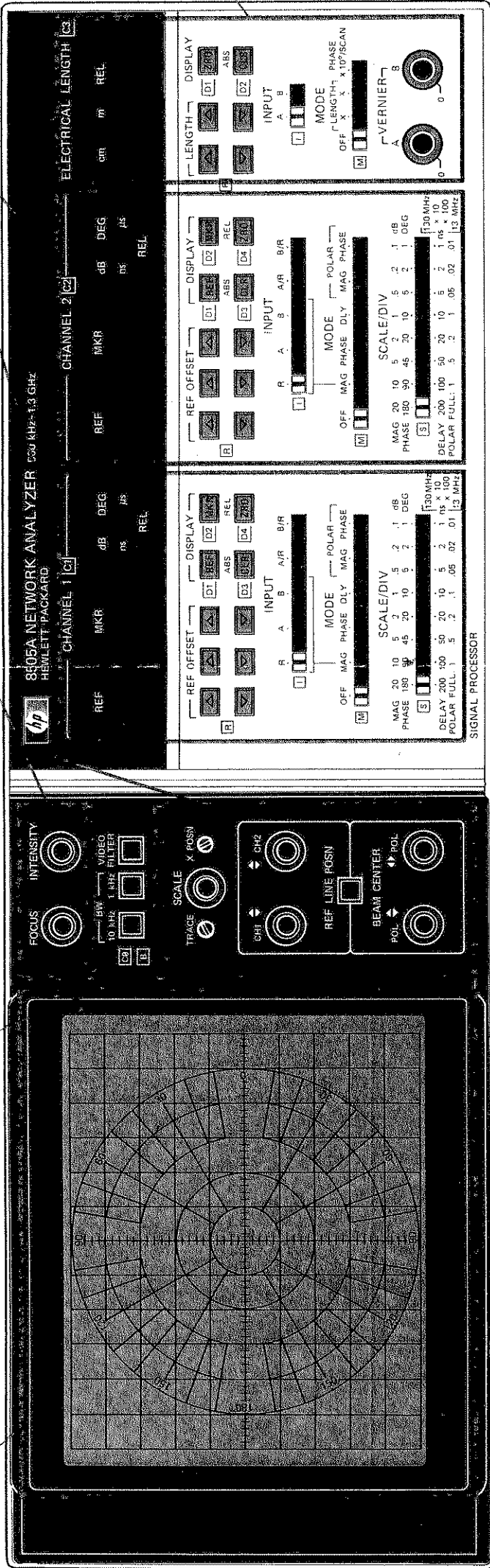

Frequency Counter

Measurement Marker Selection and Position

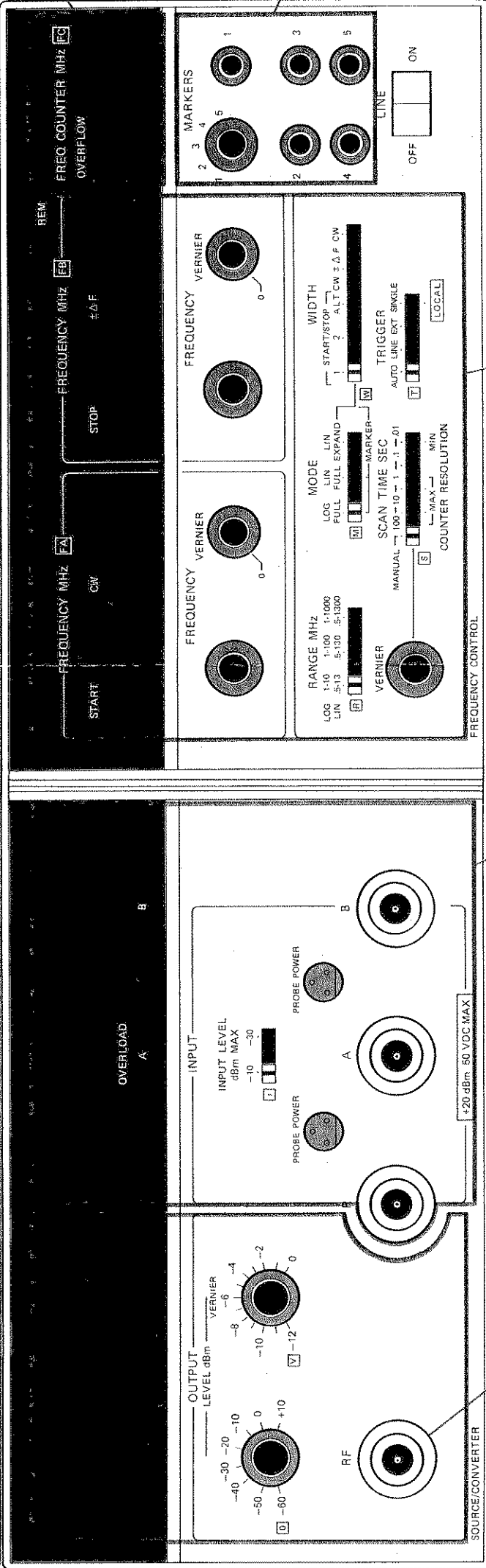

Sweeper Frequency Controls and Displays

Reference and Test Inputs

Sweeper Output

Free Manuals Download Website

<http://myh66.com>

<http://usermanuals.us>

<http://www.somanuals.com>

<http://www.4manuals.cc>

<http://www.manual-lib.com>

<http://www.404manual.com>

<http://www.luxmanual.com>

<http://aubethermostatmanual.com>

Golf course search by state

<http://golfingnear.com>

Email search by domain

<http://emailbydomain.com>

Auto manuals search

<http://auto.somanuals.com>

TV manuals search

<http://tv.somanuals.com>