



HP Envy 6

Maintenance and Service Guide

IMPORTANT! This document is intended for HP authorized service providers only.

© Copyright 2012 Hewlett-Packard
Development Company, L.P.

AMD, the AMD Arrow logo, and combinations thereof, are trademarks of Advanced Micro Devices, Inc. Bluetooth is a trademark owned by its proprietor and used by Hewlett-Packard Company under license. Intel is a trademark of Intel Corporation in the U.S. and other countries. Microsoft and Windows are U.S. registered trademarks of Microsoft Corporation. SD Logo is a trademark of its proprietor.

The information contained herein is subject to change without notice. The only warranties for HP products and services are set forth in the express warranty statements accompanying such products and services. Nothing herein should be construed as constituting an additional warranty. HP shall not be liable for technical or editorial errors or omissions contained herein.

First Edition: April 2012

Document Part Number: 695828-001

Safety warning notice

⚠ WARNING! To reduce the possibility of heat-related injuries or of overheating the device, do not place the device directly on your lap or obstruct the device air vents. Use the device only on a hard, flat surface. Do not allow another hard surface, such as an adjoining optional printer, or a soft surface, such as pillows or rugs or clothing, to block airflow. Also, do not allow the AC adapter to contact the skin or a soft surface, such as pillows or rugs or clothing, during operation. The device and the AC adapter comply with the user-accessible surface temperature limits defined by the International Standard for Safety of Information Technology Equipment (IEC 60950).

Table of contents

1 Product description	1
2 External component identification	4
Display	4
Button, speakers, and subwoofer	5
Keys	6
Lights	7
TouchPad	8
Left side	8
Right side	10
Bottom	11
3 Illustrated parts catalog	12
Service tag	12
Computer major components	13
Mass storage devices	18
Miscellaneous parts	19
Sequential part number listing	19
4 Removal and replacement procedures	26
Preliminary replacement requirements	26
Tools required	26
Service considerations	26
Plastic parts	26
Cables and connectors	26
Drive handling	27
Grounding guidelines	27
Electrostatic discharge damage	27
Packaging and transporting guidelines	29
Component replacement procedures	30
Service label	31
Display panel	32
Base enclosure	34
Battery	36
Hard drive	38
RTC battery	41

TouchPad module	43
WLAN module	45
Memory module	46
Fan	47
System board	48
Fan-Heat sink	53
RJ-45 module cover	54
Media card reader assembly (smart card reader)	55
Subwoofer	56
Security bracket	57
USB/Audio board	58
Power connector cable	59
Speakers	60
Power button board	61
Keyboard	62
Top cover	66
WLAN antenna cables	66
Display panel cable assembly	67
Webcam assembly	68
Display hinges and hinge covers	69

5 Setup Utility (BIOS) and System Diagnostics 71

Using Setup Utility	71
Starting Setup Utility	71
Changing the language of Setup Utility	71
Navigating and selecting in Setup Utility	72
Displaying system information	72
Restoring factory settings in Setup Utility	73
Exiting Setup Utility	73
Updating the BIOS	73
Determining the BIOS version	74
Downloading a BIOS update	74
Using System Diagnostics	75

6 Specifications 76

Computer specifications	76
15.6-inch display specifications	76

7 Backup and recovery 78

Restoring the system	78
----------------------------	----

Creating restore media	78
Performing a system recovery	79
Using the dedicated recovery partition	79
Restoring using the restore media	81
Changing the computer boot order	81
Backing up and recovering your information	81
Using Windows Backup and Restore	82
Using Windows system restore points	83
When to create restore points	83
Create a system restore point	83
Restore to a previous date and time	83
8 Power cord set requirements	84
Requirements for all countries	84
Requirements for specific countries and regions	84
9 Recycling	86
Index	87

1 Product description

Category	Description
Product Name	HP Envy 6 PC
Processors	Intel® Core™ i5-3317U 1.7GHz processor SC turbo up to 2.6GHz (3–MB cache, dual core 17 W)
	Intel® Core™ i3-3217U 1.8GHz processor 2c/4t (3–MB cache, dual core 17 W)
	Intel® Core™ i5-2467M 1.6GHz processor SC turbo up to 2.3GHz (3–MB L3 cache, dual core 17 W)
	Intel® Core™ i3-2367M 1.4GHz processor (3–MB L3 cache, dual 17W)
	Intel® Core™ i5-2377M 1.5GHz processor SC turbo up to 2.3GHz (3–MB L3 cache, dual core 17 W)
	AMD® A6–4455M 2.6GHz/2.1GHz (1–MB L2 cache)
	AMD® A10–4655M 2.8GHz/2.0GHz (4–MB L2 cache)
Chipset	Intel® HM77 Express platform controller hub (PCH)
	AMD A70M fusion controller hub (FCH)
Graphics	Intel® HD Graphics 4000 discrete-class graphics. Supports BD and or HD-DVD playback with HD decode, and DX11 support and HDMI support
	Intel® HD Graphics 3000 discrete-class graphics. Supports BD and or HD-DVD playback with HD decode, and DX11 support and HDMI support
	AMD Radeon™ HD 7500G for A6 APU
	AMD Radeon™ HD 7620G for A10 APU
Panel	15.6" high-definition (HD) light-emitting diode (LED), BrightView (1366x768) display; (3.2mm) Slim, Shuriken, 200 nits
	All display assemblies include 2 wireless local area network (WLAN) antenna cables.
	Supports 16:9 wide aspect ratio
	Support for non-flush glass panel cover (non-PMMA)
Memory	Two memory module slots
	DDR3-1600MHz single channel support
	DDR3-1333MHz single channel support (DDR3-1600 downgrade to 1333)
	Supports up to 16384-GB of system RAM

Category	Description
	<p>Supports the following configurations:</p> <ul style="list-style-type: none"> • 2048-MB total system memory (2048×1) • 4096-MB total system memory (2048×2) • 4096-MB total system memory (4096×1) • 6144-MB total system memory (2048×1 + 4096×1) • 8192-MB total system memory (4096×2) • 8192-MB total system memory (8192×1) • 12288-MB total system memory (8192×1 + 4096×1) • 16384-MB total system memory (8192×2)
Hard drives	<p>Hard drive (7mm SATA 2.5") configurations:</p> <ul style="list-style-type: none"> • 320-GB 7200 RPM 7mm SATA • 320-GB, 5400 RPM 7mm SATA • 500-GB 5400 RPM 7mm SATA <p>mSATA SSD configurations:</p> <ul style="list-style-type: none"> • 32-GB SSD • 128-GB SSD
Optical drive	<p>External USB optical drive (computer USB ports support 2A current)</p> <p>SATA</p> <p>12–7 mm tray load</p> <p>Supports the following external optical drives:</p> <ul style="list-style-type: none"> • Blu-ray ROM DVD±R/RW Super Multi Double-Layer Drive • DVD±RW and CD-RW Super Multi Double-Layer Combo Drive
Audio and video	<p>Dual array digital microphones</p> <p>Two integrated stereo speakers and subwoofer</p> <p>HP TrueVision high-definition webcam (fixed, no tilt, 1280×720 by 30 frames per second)</p>
Ethernet	<p>Integrated 10/100/1000 GB network interface card (NIC)</p>
Wireless	<p>Integrated WLAN options by way of wireless module</p> <p>Two WLAN antennas built into display assembly</p> <p>Supports the following WLAN formats:</p> <ul style="list-style-type: none"> • Intel® Centrino® Wireless-N 2230 + Bluetooth combo w/ *2 antennas (802.11 b/g/n, Bluetooth 3.0) • Atheros 9485GN 802.11b/g/n 1×1 WiFi and 3012 Bluetooth 4.0 Combo Adapter • Broadcom 4313GN 802.11b/g/n 1×1 WiFi and 20702 Bluetooth 4.0 Combo Adapter
External media card	<p>Push-push insertion/removal</p>

Category	Description
	<p>HP Multi-Format Digital Media Reader supports the following digital card formats:</p> <ul style="list-style-type: none"> • MultiMediaCard • Secure Digital (SD) Card • Secure Digital High-Capacity (SDHC) Card • Secure Digital Extended Capacity (SDxC) Card
Ports	<ul style="list-style-type: none"> • 3-pin AC power (non-smart pin) • Audio-in (mono microphone), supports jack detection • Audio-out (stereo headphone), supports jack detection • HDMI version 1.4b supporting 1920p, 1920 ×1200 @ 60Hz • RJ-45 (Ethernet, includes link and activity lights) • USB 3.0 (2 ports) • USB 2.0 (1 port)
Keyboard/pointing devices	<p>97% Duracoat, island-style black keyboard, no spill-resistance (in black finish)</p> <p>97% Duracoat, island-style black keyboard, no spill-resistance (in black/silver finish)</p> <p>Backlit, island-style keyboard in black finish (NA CTO onlly)</p> <p>Backlit, island-style keyboard in black/silver finish (NA CTO onlly)</p> <p>TouchPad with multi-touch gestures</p> <p>Taps enabled as default</p>
Power requirements	<p>Supports the following HP AC adapters:</p> <ul style="list-style-type: none"> • 65-W (non-smart) PFC RC V EM 2-wire HP AC adapter <p>Supports the following batteries:</p> <ul style="list-style-type: none"> • 4-cell, 60WHr 4.1 AH Li-ion battery
Operating system	<p>Preinstalled:</p> <ul style="list-style-type: none"> • Windows 7 Home Basic (64-bit) • Windows 7 Home Premium (64-bit) • Windows 7 Professional (64-bit)
Serviceability	<p>End-user replaceable parts:</p> <p>AC adapter</p>

2 External component identification

Display



Component	Description
(1) Internal display switch	Turns off the display and initiates Sleep if the display is closed while the power is on. NOTE: The internal display switch is not visible from the outside of the computer.
(2) WLAN antennas (2)*	Send and receive wireless signals to communicate with wireless local area networks (WLANs).
(3) Internal microphones (2)	Record sound.
(4) Webcam light	On: The webcam is in use.
(5) HP TrueVision HD Webcam	Records video, captures still photographs, and allows video conferences and online chat by means of streaming video. To use the webcam, select Start > All Programs > Communication and Chat > CyberLink YouCam .

*The antennas are not visible from the outside of the computer. For optimal transmission, keep the areas immediately around the antennas free from obstructions. For wireless regulatory notices, see the section of the *Regulatory, Safety, and Environmental Notices* that applies to your country or region. These notices are located in Help and Support.



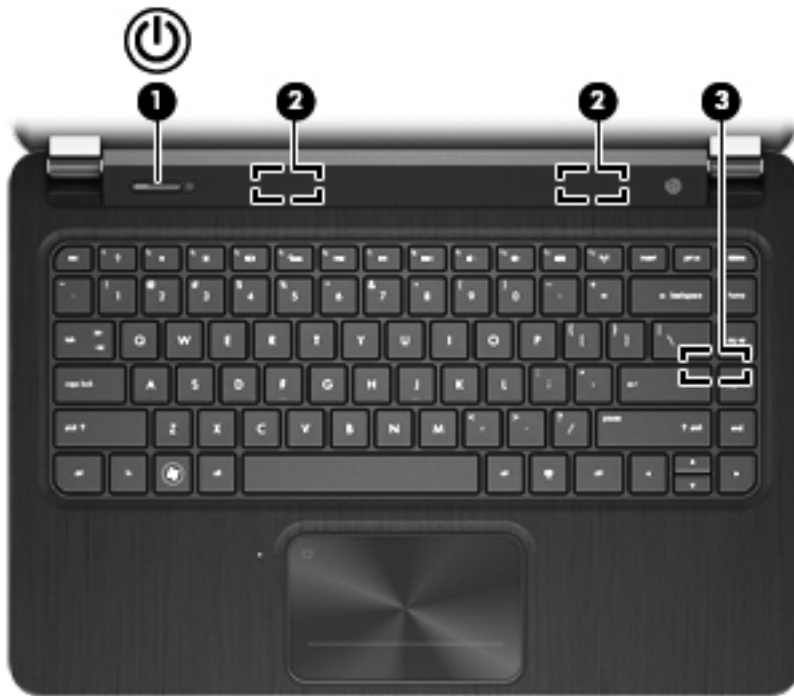

Button, speakers, and subwoofer

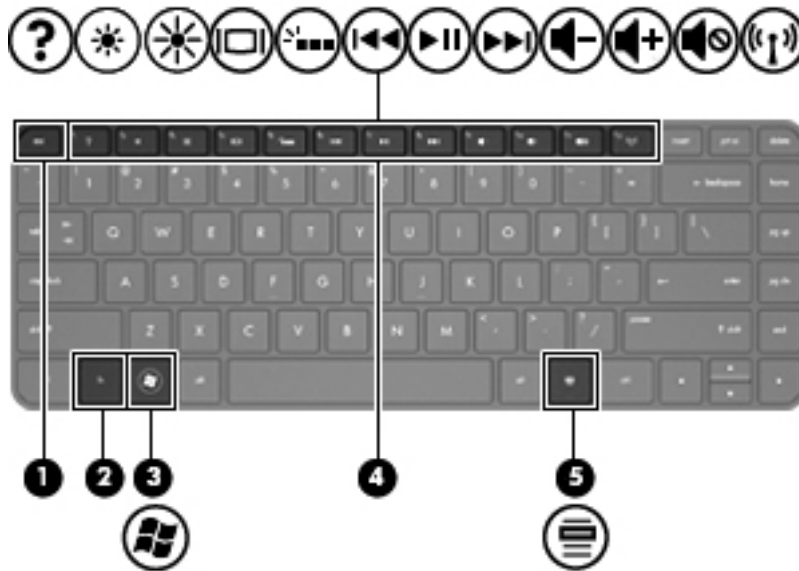

Component	Description
(1)  Power button	<ul style="list-style-type: none">When the computer is off, press the button to turn on the computer.When the computer is on, press the button briefly to initiate Sleep.When the computer is in the Sleep state, press the button briefly to exit Sleep.When the computer is in Hibernation, press the button down briefly to exit Hibernation. <p>CAUTION: Pressing and holding down the power button will result in the loss of unsaved information.</p> <p>If the computer has stopped responding and Microsoft® Windows® shutdown procedures are ineffective, press and hold the power button down for at least 5 seconds to turn off the computer.</p> <p>NOTE: For select models, the Intel® Rapid Start Technology feature is enabled at the factory. Rapid Start Technology allows your computer to resume quickly from inactivity. For more information, see the <i>User Guide</i>.</p> <p>To learn more about your power settings, select Start > Control Panel > System and Security > Power Options, or see the <i>User Guide</i>.</p>
(2) Speakers (2)	Produce sound.
(3) HP Triple Bass Reflex Subwoofer	Provides superior bass sound.

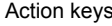

Keys



Component	Description
(1)  esc key	Displays system information when pressed in combination with the fn key.
(2)  fn key	Executes frequently used system functions when pressed in combination with the b key, the spacebar , or the esc key.
(3)  Windows logo key	Displays the Windows Start menu.
(4)  Action keys	Execute frequently used system functions. NOTE: On select models, the f5 action key turns the radiance backlight keyboard feature off or on.
(5)  Windows applications key	Displays a shortcut menu for items beneath the cursor.

Lights



Component	Description
(1)  Power light	<ul style="list-style-type: none"> • White: The computer is on. • Blinking white: The computer is in the Sleep state, which is an energy-saving mode. The computer shuts off power to the display and other unneeded components. • Off: The computer is off or in Hibernation. Hibernation is an energy-saving mode that uses the least amount of power. <p>NOTE: For select models, the Intel® Rapid Start Technology feature is enabled at the factory. Rapid Start Technology allows your computer to resume quickly from inactivity. For more information, see the <i>User Guide</i>.</p>
(2)  Mute light	<ul style="list-style-type: none"> • Amber: Computer sound is off. • Off: Computer sound is on.
(3)  Wireless light	<ul style="list-style-type: none"> • White: An integrated wireless device, such as a wireless local area network (WLAN) device and/or a Bluetooth® device, is on. • Amber: All wireless devices are off.
(4) Caps lock light	On: Caps lock is on, which switches the keys to all capital letters.
(5) TouchPad light	<ul style="list-style-type: none"> • On: The TouchPad is off. • Off: The TouchPad is on.

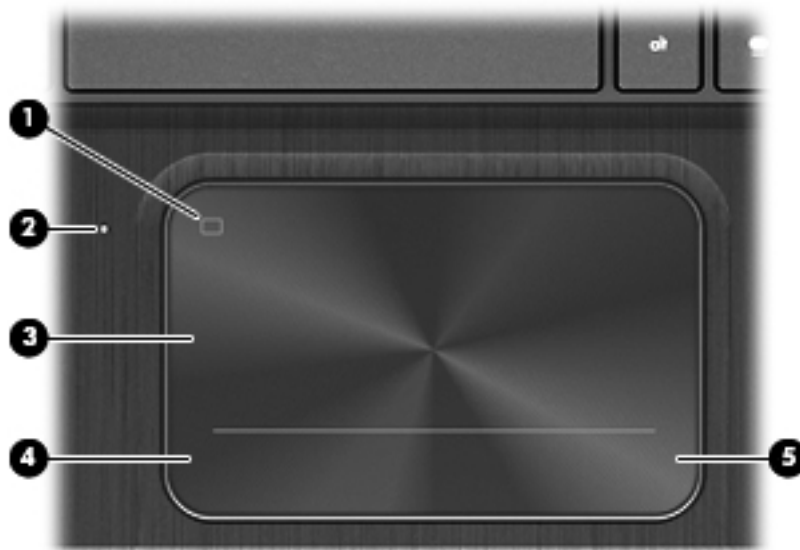

TouchPad





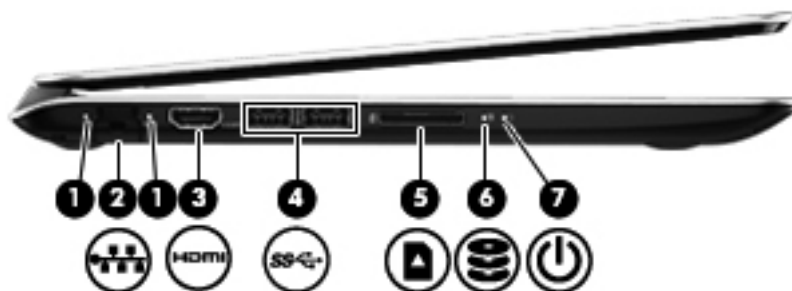

Component	Description
(1) TouchPad on/off button	Turns the TouchPad on or off.
(2) TouchPad light	<ul style="list-style-type: none"> On: The TouchPad is off. Off: The TouchPad is on.
(3) TouchPad zone	Moves the on-screen pointer and selects or activates items on the screen.
(4) Left TouchPad button	Functions like the left button on an external mouse.
(5) Right TouchPad button	Functions like the right button on an external mouse.

Left side





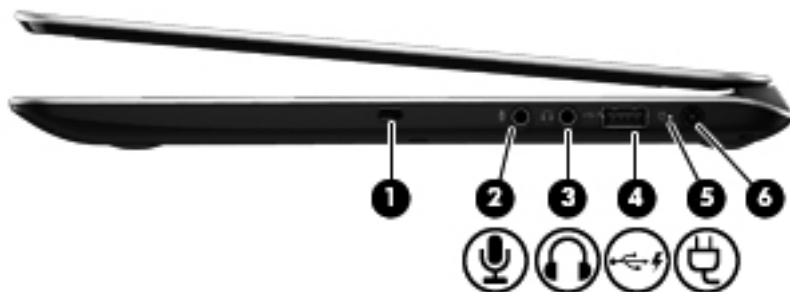

Component	Description
(1)  RJ-45 (network) jack	Connects a network cable.
(2)  HDMI port	Connects an optional video or audio device, such as a high-definition television, or any compatible digital or audio device.

Component	Description
(3)  USB 3.0 ports (2)	<p>Connect optional USB 3.0 devices and provide enhanced USB power performance.</p> <p>NOTE: For details about different types of USB ports, see the <i>User Guide</i>.</p>
(4)  Digital Media Slot	<p>Supports the following digital card formats:</p> <ul style="list-style-type: none"> • Secure Digital (SD) Memory Card • Secure Digital Extended Capacity (SDxC) Memory Card • Secure Digital High Capacity (SDHC) Memory Card • Ultra High Speed MultiMediaCard (UHS/MMC)
(5)  Hard drive light	<ul style="list-style-type: none"> • Blinking white: The hard drive is being accessed. • Amber: HP 3D DriveGuard has temporarily parked the hard drive. <p>NOTE: For information about HP 3D DriveGuard, see the User Guide.</p>
(6)  Power light	<ul style="list-style-type: none"> • White: The computer is on. • Blinking white: The computer is in the Sleep state, which is an energy-saving mode. The computer shuts off power to the display and other unneeded components. • Off: The computer is off or in Hibernation. Hibernation is an energy-saving mode that uses the least amount of power. <p>NOTE: For select models, the Intel® Rapid Start Technology feature is enabled at the factory. Rapid Start Technology allows your computer to resume quickly from inactivity. For more information, see the <i>User Guide</i>.</p>

Right side



Component	Description
(1)	Security cable slot Attaches an optional security cable to the computer. NOTE: The security cable is designed to act as a deterrent, but it may not prevent the computer from being mishandled or stolen.
(2) 	Audio-in (microphone) jack Connects an optional computer headset microphone, stereo array microphone, or monaural microphone.
(3) 	Audio-out (headphone) jack Connects optional powered stereo speakers, headphones, earbuds, a headset, or a television audio cable. WARNING! To reduce the risk of personal injury, adjust the volume before using headphones, earbuds, or a headset. For additional safety information, see the <i>Regulatory, Safety and Environmental Notices</i> . NOTE: When a device is connected to a headphone jack, the computer speakers are disabled.
(4) 	USB 2.0 charging port Connects an optional USB device. The USB 2.0 charging port can also charge select models of cell phones and MP3 players, even when the computer is off. NOTE: A charging USB port (also referred to as a powered USB port) allows you to charge connected USB devices. Standard USB ports will not charge all USB devices or will charge using a low current. Some USB devices require power and require you to use a powered port. NOTE: For details about different types of USB ports, see the <i>User Guide</i> .
(5)	AC adapter light <ul style="list-style-type: none"> White: The AC adapter is connected and the battery is charged. Amber: The AC adapter is connected and the battery is charging. Off: The computer is using DC power.
(6) 	Power connector Connects an AC adapter.

Bottom

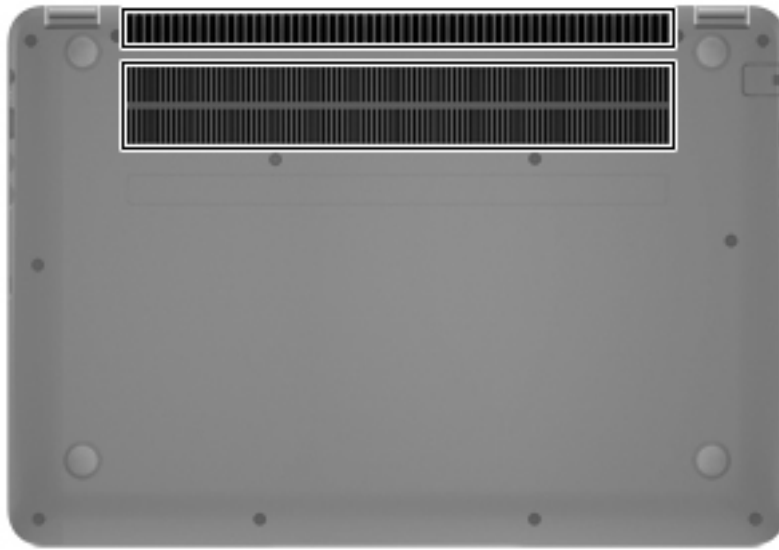

Component	Description
Vents (2)	Enable airflow to cool internal components. NOTE: The computer fan starts up automatically to cool internal components and prevent overheating. It is normal for the internal fan to cycle on and off during routine operation.

3 Illustrated parts catalog

Service tag

When ordering parts or requesting information, provide the computer serial number and model description provided on the service tag, which is located on the bottom of the computer.

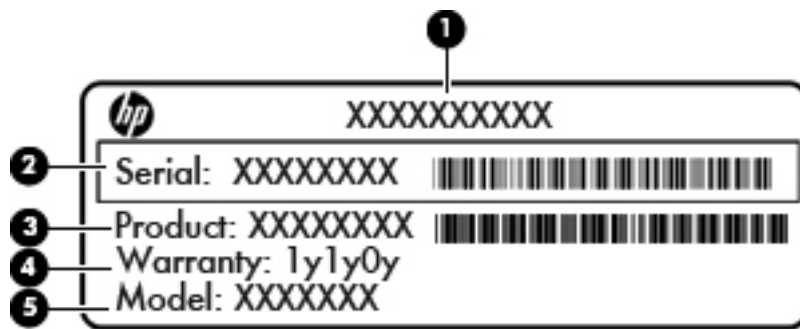

Item	Description	Function
(1)	Product name	This is the product name affixed to the front of the computer.
(2)	Serial number (s/n)	This is an alphanumeric identifier that is unique to each product.
(3)	Part number/Product number (p/n)	This number provides specific information about the product's hardware components. The part number helps a service technician to determine what components and parts are needed.
(4)	Warranty period	This number describes the duration of the warranty period for the computer.
(5)	Model description (select models only)	This is the alphanumeric identifier used to locate documents, drivers, and support for the computer.

Computer major components

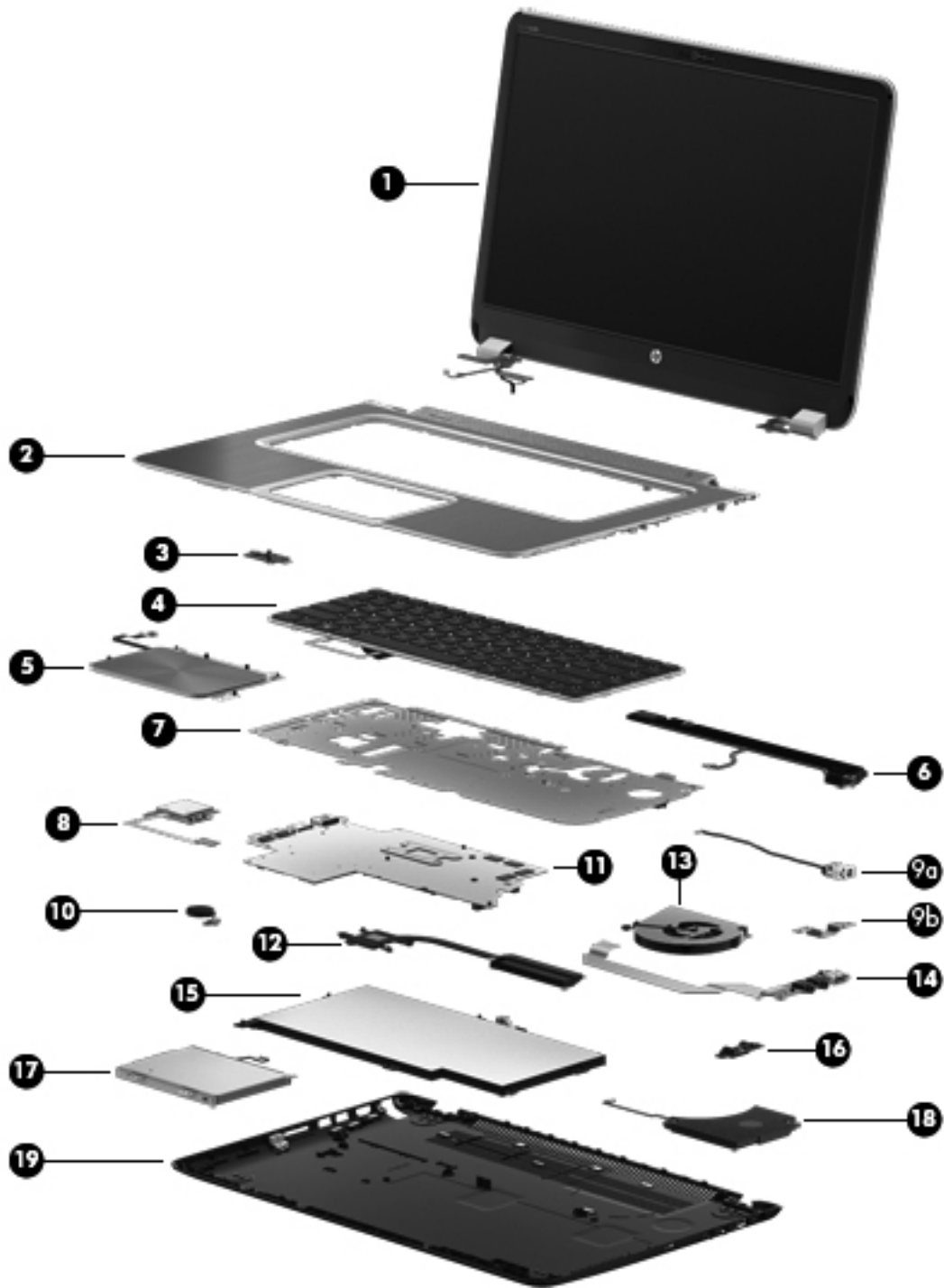

Item	Component	Spare part number
(1)	Display panel	686602-001
(2)	Top cover	686097-001 690198-001

Item	Component	Spare part number
(3)	Power button board	688003-001
(4)	Keyboard (includes keyboard cable):	
	Keyboard in black finish:	
	For use in the United States	686836-001
	For use in the United Kingdom and Singapore	686836-031
	For use in Germany	686836-041
	For use in France	686836-051
	For use in Italy	686836-061
	For use in Portugal	686836-131
	For use in Turkey	686836-141
	For use in Saudi Arabia	686836-171
	For use in Hungary	686836-211
	For use in Russia	686836-251
	For use in Romania	686836-271
	For use in Thailand	686836-281
	For use in Japan	686836-291
	For use in Taiwan	686836-AB1
	For use in South Korea	686836-AD1
	For use in the Netherlands	686836-B31
	For use in Slovenia	686836-BA1
	For use in Israel	686836-BB1
	For use in India	686836-D61
	For use in Canada	686836-DB1
	For use in Czechoslovakia	686836-FL1
	Backlit keyboard in black finish:	
	Backlit keyboard for use in the United States	687099-001
	Backlit keyboard for use in Spain	687099-071
	Backlit keyboard for use in Greece	687099-151
	Backlit keyboard for use in Saudi Arabia	687099-171
	Backlit keyboard for use in Belgium	687099-A41
	Backlit keyboard for use in the Netherlands	687099-B31
	Backlit keyboard for use in Switzerland	687099-BG1
	Backlit keyboard for use in Denmark, Norway, Finland	687099-DH1
	Keyboard in black/silver finish:	

Item	Component	Spare part number
	For use in the United States	692758-001
	For use in the United Kingdom and Singapore	692758-031
	For use in Germany	692758-041
	For use in France	692758-051
	For use in Italy	692758-061
	For use in Portugal	692758-131
	For use in Turkey	692758-141
	For use in Saudi Arabia	692758-171
	For use in Brazil	692758-201
	For use in Russia	692758-251
	For use in Romania	692758-271
	For use in Thailand	692758-281
	For use in Japan	692758-291
	For use in Taiwan	692758-AB1
	For use in South Korea	692758-AD1
	For use in the Netherlands	692758-B31
	For use in Slovenia	692758-BA1
	For use in Israel	692758-BB1
	For use in India	692758-D61
	For use in Canada	692758-DB1
	For use in Czechoslovakia	692758-FL1
	Backlit keyboard in black/silver finish:	
	Backlit keyboard for use in the United States	692759-001
	Backlit keyboard for use in Spain	692759-071
	Backlit keyboard for use in Greece	692759-151
	Backlit keyboard for use in Saudi Arabia	692759-171
	Backlit keyboard for use in Belgium	692759-A41
	Backlit keyboard for use in the Netherlands	692759-B31
	Backlit keyboard for use in Switzerland	692759-BG1
	Backlit keyboard for use in Denmark, Finland, Norway	692759-DH1
(5)	TouchPad button board (includes cable)	688001-001 691643-001
(6)	Speaker kit	686598-001
(7)	Keyboard bracket	688002-001

Item	Component	Spare part number
(8)	Media card reader assembly	688004-001
(9a)	Power connector cable (includes bracket)	686593-001
(9b)	Power connector cable bracket	686593-001
(10)	RTC battery:	686922-001
(11)	System board	
	System board for use only with computer models equipped with an Intel 1.8GHz processor (includes processor and replacement thermal material).	693228-001
	System board for use only with computer models equipped with an Intel 1.8GHz processor (includes processor and replacement thermal material)	693228-501
	System board for use only with computer models equipped with an Intel 1.8GHz processor (includes processor and replacement thermal material)	693228-601
	System board for use only with computer models equipped with an Intel 1.7GHz processor (includes processor and replacement thermal material).	693229-001
	System board for use only with computer models equipped with an Intel 1.7GHz processor (includes processor and replacement thermal material)	693229-501
	System board for use only with computer models equipped with an Intel 1.7GHz processor (includes processor and replacement thermal material)	693229-601
	System board for use only with computer models equipped with an Intel 1.4GHz processor (includes processor and replacement thermal material).	693230-001
	System board for use only with computer models equipped with an Intel 1.6GHz processor (includes processor and replacement thermal material).	693231-001
	System board for use only with computer models equipped with an Intel 1.4GHz processor (includes processor and replacement thermal material).	693232-001
	System board for use only with computer models equipped with an Intel 1.6GHz processor (includes processor and replacement thermal material).	693233-001
	System board for use only with computer models equipped with an Intel 1.7GHz processor (includes processor and replacement thermal material)	693234-001
	System board for use only with computer models equipped with an Intel 1.7GHz processor (includes processor and replacement thermal material)	693234-501
	System board for use only with computer models equipped with an Intel 1.7GHz processor (includes processor and replacement thermal material)	693234-601
	System board for use only with computer models equipped with an Intel 1.5GHz processor (includes processor and replacement thermal material)	693753-001
	System board for use only with computer models equipped with an Intel 1.5GHz processor (includes processor and replacement thermal material)	693753-501
	System board for use only with computer models equipped with an Intel 1.5GHz processor (includes processor and replacement thermal material)	693753-601
	System board for use only with computer models equipped with an Intel 1.5GHz processor (includes processor and replacement thermal material)	693754-001
	System board for use only with computer models equipped with an Intel 1.5GHz processor (includes processor and replacement thermal material)	693754-501

Item	Component	Spare part number
	System board for use only with computer models equipped with an Intel 1.5GHz processor (includes processor and replacement thermal material)	693754-601
	System board for use only with computer models equipped with an Intel 1.8GHz processor (includes processor and replacement thermal material)	693755-001
	System board for use only with computer models equipped with an Intel 1.8GHz processor (includes processor and replacement thermal material)	693755-501
	System board for use only with computer models equipped with an Intel 1.8GHz processor (includes processor and replacement thermal material)	693755-601
	System board for use only with computer models equipped with an AMD A6 2.6GHz/2.1GHz processor (includes processor and replacement thermal material)	689157-001
	System board for use only with computer models equipped with an AMD A6 2.6GHz/2.1GHz processor (includes processor and replacement thermal material)	689157-501
	System board for use only with computer models equipped with an AMD A6 2.6GHz/2.1GHz processor (includes processor and replacement thermal material)	689157-601
	System board for use only with computer models equipped with an AMD A10 2.8GHz/2.0GHz processor (includes processor and replacement thermal material)	689158-001
	System board for use only with computer models equipped with an AMD A10 2.8GHz/2.0GHz processor (includes processor and replacement thermal material)	689158-501
	System board for use only with computer models equipped with an AMD A10 2.8GHz/2.0GHz processor (includes processor and replacement thermal material)	689158-601
(12)	Fan — Heat sink	686578-001
		686579-001
		691656-001
		691657-001
(13)	Fan	686580-001
(14)	USB/Audio board	686597-001
(15)	Battery:	
	4-cell, 60 WHr 4.1AH Li-ion battery	681951-001
(16)	Security lock (in power connector kit)	686593-001
(17)	Hard drive (7mm SATA 2.5")	
	320-GB, 7200-rpm hard drive	634862-005
	4-GB memory module (PC3, 12800, 1600-MHz)	645193-005
	320-GB, 5400-rpm hard drive	683802-005
(18)	Subwoofer (included in Speaker Kit)	686599-001
(19)	Base enclosure	
	Base enclosure (red)	686096-001
	Base enclosure (black)	690197-001

Mass storage devices



Item	Component	Spare part number
(1)	Hard drive (7mm SATA 2.5")	
	320-GB, 7200-rpm hard drive	634862-005
	320-GB, 5400-rpm hard drive	645193-005
	500-GB 5400-rpm hard drive	683802-005
(2a)	Hard drive bracket	686594-001
(2b)	Hard drive cable	686594-001
(3)	Hard drive (mSATA solid-state drive)	
	32-GB solid-state (SSD) drive	687100-001
	128-GB solid-state (SSD) drive	687101-001
(4)	Optical drive	
	Blu-ray ROM DVD±R/RW Super Multi Double-Layer Drive	659941-001
	DVD±RW and CD-RW Super Multi Double-Layer Combo Drive	659940-001
	Screws (not illustrated)	

Miscellaneous parts

Component	Spare part number
AC adapter (non-smart):	
65-W PFC RC V 2-wire AC adapter (non-smart) for use in all countries and regions	613149-001
	693715-001
Power cord (3-pin, black, 1.83-m):	
For use in Australia	490371-011
For use in Italy	490371-061
For use in Denmark	490371-081
For use in Japan	490371-291
For use in North America	490371-001
For use in the People's Republic of China	490371-AA1
For use in South Korea	490371-AD1
For use in Argentina	490371-D01
For use in Taiwan	490371-AB1
For use in Thailand	490371-201
For use in Europe	490371-021
For use in Switzerland	490371-111
For use in the United Kingdom and Singapore	490371-031
For use in Brazil	490371-202
For use in South Africa	490371-AR1
For use in Israel	490371-BB1
For use in India	490371-D61
Screw Kit	690348-001

Sequential part number listing

Spare part number	Description
490371-001	Power cord for use in North America (3-pin, black, 1.83-m)
490371-011	Power cord for use in Australia (3-pin, black, 1.83-m)
490371-021	Power cord for use in Europe (3-pin, black, 1.83-m)
490371-031	Power cord for use in the United Kingdom and Singapore (3-pin, black, 1.83-m)
490371-061	Power cord for use in Italy (3-pin, black, 1.83-m)
490371-081	Power cord for use in Denmark (3-pin, black, 1.83-m)
490371-111	Power cord for use in Switzerland (3-pin, black, 1.83-m)

Spare part number	Description
490371-201	Power cord for use in Thailand (3-pin, black, 1.83-m)
490371-202	Power cord for use in Brazil (3-pin, black, 1.83-m)
490371-291	Power cord for use in Japan (3-pin, black, 1.83-m)
490371-AA1	Power cord for use in the People's Republic of China (3-pin, black, 1.83-m)
490371-AB1	Power cord for use in Taiwan (3-pin, black, 1.83-m)
490371-AD1	Power cord for use in South Korea (3-pin, black, 1.83-m)
490371-AR1	Power cord for use in South Africa (3-pin, black, 1.83-m)
490371-BB1	Power cord for use in Israel (3-pin, black, 1.83-m)
490371-D01	Power cord for use in Argentina (3-pin, black, 1.83-m)
490371-D61	Power cord for use in India (3-pin, black, 1.83-m)
613149-001	AC Adapter (non-smart) 65 W RC V 2-wire for use in all countries and regions except India
634862-005	320-GB, 7200-rpm hard drive
641369-005	4-GB memory module (PC3, 12800, 1600-MHz)
645193-005	320-GB, 5400-rpm hard drive
652972-005	2-GB memory module (PC3, 12800, 1600-MHz)
655795-005	Atheros 9485GN 802.11b/g/n 1×1 WiFi and 3012 Bluetooth 4.0 Combo Adapter
657325-005	Broadcom 4313GN 802.11b/g/n 1×1 WiFi and 20702 Bluetooth 4.0 Combo Adapter
659940-001	DVD±RW and CD-RW Super Multi Double-Layer Combo Drive
659941-001	Blu-ray ROM DVD±R/RW Super Multi Double-Layer Drive
670034-005	8-GB memory module (PC3, 12800, 1600-MHz)
670290-005	Intel® Centrino® Wireless-N 1030 + Bluetooth combo w/ *2 antennas (802.11 b/g/n, Bluetooth 3.0)
675794-005	Intel® Centrino® Wireless-N 1030 + Bluetooth combo w/ *2 antennas (802.11 b/g/n, Bluetooth 3.0)
681951-001	4-cell, 60 WHr 4.1AH Li-ion battery
683802-005	500-GB, 5400-rpm hard drive
686096-001	Base enclosure
686097-001	Top cover in black finish (includes power button board and cable and TouchPad and TouchPad cable)
686578-001	Thermal module
686579-001	Thermal module
686580-001	Fan
686587-001	Webcam
686589-001	WLAN antennas
686590-001	Display back cover
686591-001	Display bezel
686592-001	Display cable

Spare part number	Description
686593-001	Power connector cable (includes bracket)
686594-001	Hardware kit (Hard drive)
686595-001	Display hinge covers
686596-001	Display hinges
686597-001	USB/Audio board
686598-001	Speaker Kit (includes left and right speakers and cable)
686599-001	Subwoofer
686602-001	Display panel (15.6 LED, HD SVA BV)
686836-001	Keyboard in black finish for use in the United States (includes keyboard cable)
686836-031	Keyboard in black finish for use in the United Kingdom and Singapore (includes keyboard cable)
686836-041	Keyboard in black finish for use in Germany (includes keyboard cable)
686836-051	Keyboard in black finish for use in France (includes keyboard cable)
686836-061	Keyboard in black finish for use in Italy (includes keyboard cable)
686836-131	Keyboard in black finish for use in Portugal (includes keyboard cable)
686836-141	Keyboard in black finish for use in Turkey (includes keyboard cable)
686836-171	Keyboard in black finish for use in Saudi Arabia (includes keyboard cable)
686836-211	Keyboard in black finish for use in Hungary (includes keyboard cable)
686836-251	Keyboard in black finish for use in Russia (includes keyboard cable)
686836-271	Keyboard in black finish for use in Romania (includes keyboard cable)
686836-281	Keyboard in black finish for use in Thailand (includes keyboard cable)
686836-291	Keyboard in black finish for use in Japan (includes keyboard cable)
686836-AB1	Keyboard in black finish for use in Taiwan (includes keyboard cable)
686836-AD1	Keyboard in black finish for use in South Korea (includes keyboard cable)
686836-B31	Keyboard in black finish for use in The Netherlands (includes keyboard cable)
686836-BA1	Keyboard in black finish for use in Slovenia (includes keyboard cable)
686836-BB1	Keyboard in black finish for use in Israel (includes keyboard cable)
686836-D61	Keyboard in black finish for use in India (includes keyboard cable)
686836-DB1	Keyboard in black finish for use in Canada (includes keyboard cable)
686836-FL1	Keyboard in black finish for use in Czechoslovakia (includes keyboard cable)
686922-001	RTC battery for use only with computer models without WWAN capability
687099-001	Backlit keyboard in black finish for use in the United States (includes keyboard cable)
687099-071	Backlit keyboard in black finish for use in Spain (includes keyboard cable)
687099-131	Backlit keyboard in black finish for use in Greece (includes keyboard cable)
687099-151	Backlit keyboard in black finish for use in Greece (includes keyboard cable)

Spare part number	Description
687099-171	Backlit keyboard in black finish for use in Saudi Arabia (includes keyboard cable)
687099-A41	Backlit keyboard in black finish for use in Belgium (includes keyboard cable)
687099-B31	Backlit keyboard in black finish for use in the Netherlands (includes keyboard cable)
687099-BG1	Backlit keyboard in black finish for use in Switzerland (includes keyboard cable)
687099-DH1	Backlit keyboard in black finish for use in Denmark, Norway, Finland (includes keyboard cable)
687100-001	32-GB solid-state drive only (does not include bracket, connector cable, isolators, or screws)
687101-001	128-GB solid-state drive only (does not include bracket, connector cable, isolators, or screws)
688001-001	TouchPad assembly (includes bracket)
688002-001	Hardware kit (keyboard bracket)
688003-001	Power button board (includes cable)
688004-001	Media card reader assembly (smart card reader)
689157-001	System board for use only with computer models equipped with an AMD 2.6GHz/2.1GHz processor (includes processor and replacement thermal material)
689157-501	System board for use only with computer models equipped with an AMD 2.6GHz/2.1GHz processor (includes processor and replacement thermal material)
689157-601	System board for use only with computer models equipped with an AMD 2.6GHz/2.1GHz processor (includes processor and replacement thermal material)
689158-001	System board for use only with computer models equipped with an AMD 2.8GHz/2.0GHz processor (includes processor and replacement thermal material)
689158-501	System board for use only with computer models equipped with an AMD 2.8GHz/2.0GHz processor (includes processor and replacement thermal material)
689158-601	System board for use only with computer models equipped with an AMD 2.8GHz/2.0GHz processor (includes processor and replacement thermal material)
689855-001	Base enclosure (red)
690019-005	Atheros 9485GN 802.11b/g/n 1x1 WiFi and 3012 Bluetooth 4.0 Combo Adapter
690020-005	Intel® Centrino® Wireless-N 1030 + Bluetooth combo w/ *2 antennas (802.11 b/g/n, Bluetooth 3.0)
690197-001	Base enclosure (black)
690198-001	Top cover in black finish
690348-001	Screw Kit
691642-001	Display hinge covers
691643-001	TouchPad
691656-001	Fan-Heat sink thermal module 17W
691657-001	Fan-Heat sink thermal module 25W
692382-001	Display back cover
692758-001	Keyboard in black/silver finish for use in the United States (includes keyboard cable)
692758-031	Keyboard in black/silver finish for use in the United Kingdom and Singapore (includes keyboard cable)

Spare part number	Description
692758-041	Keyboard in black/silver finish for use in Germany (includes keyboard cable)
692758-051	Keyboard in black/silver finish for use in France (includes keyboard cable)
692758-061	Keyboard in black/silver finish for use in Italy (includes keyboard cable)
692758-131	Keyboard in black/silver finish for use in Portugal (includes keyboard cable)
692758-141	Keyboard in black/silver finish for use in Turkey (includes keyboard cable)
692758-171	Keyboard in black/silver finish for use in Saudi Arabia (includes keyboard cable)
692758-201	Keyboard in black/silver finish for use in Brazil (includes keyboard cable)
692758-251	Keyboard in black/silver finish for use in Russia (includes keyboard cable)
692758-271	Keyboard in black/silver finish for use in Romania (includes keyboard cable)
692758-281	Keyboard in black/silver finish for use in Thailand (includes keyboard cable)
692758-291	Keyboard in black/silver finish for use in Japan (includes keyboard cable)
692758-AB1	Keyboard in black/silver finish for use in Taiwan (includes keyboard cable)
692758-AD1	Keyboard in black/silver finish for use in South Korea (includes keyboard cable)
692758-B31	Keyboard in black/silver finish for use in the Netherlands (includes keyboard cable)
692758-BA1	Keyboard in black/silver finish for use in Slovenia (includes keyboard cable)
692758-BB1	Keyboard in black/silver finish for use in Israel (includes keyboard cable)
692758-D61	Keyboard in black/silver finish for use in India (includes keyboard cable)
692758-DB1	Keyboard in black/silver finish for use in Canada (includes keyboard cable)
692758-FL1	Keyboard in black/silver finish for use in Czechoslovakia (includes keyboard cable)
692759-001	Backlit keyboard in black/silver finish for use in the United States (include keyboard cable)
692759-071	Backlit keyboard in black/silver finish for use in Spain (include keyboard cable)
692759-151	Backlit keyboard in black/silver finish for use in Greece (include keyboard cable)
692759-171	Backlit keyboard in black/silver finish for use in Saudi Arabia (include keyboard cable)
692759-A41	Backlit keyboard in black/silver finish for use in Belgium (include keyboard cable)
692759-B31	Backlit keyboard in black/silver finish for use in the Netherlands (include keyboard cable)
692759-BG1	Backlit keyboard in black/silver finish for use in Switzerland (include keyboard cable)
692759-DH1	Backlit keyboard in black/silver finish for use in Denmark, Norway, Finland (include keyboard cable)
693228-001	System board for use only with computer models equipped with an Intel 1.8GHz processor (includes processor and replacement thermal material)
693228-001	System board for use only with computer models equipped with an Intel 1.8GHz processor (includes processor and replacement thermal material)
693228-501	System board for use only with computer models equipped with an Intel 1.8GHz processor (includes processor and replacement thermal material)
693228-601	System board for use only with computer models equipped with an Intel 1.8GHz processor (includes processor and replacement thermal material)

Spare part number	Description
693229-001	System board for use only with computer models equipped with an Intel 1.7GHz processor (includes processor and replacement thermal material)
693229-501	System board for use only with computer models equipped with an Intel 1.7GHz processor (includes processor and replacement thermal material)
693229-601	System board for use only with computer models equipped with an Intel 1.7GHz processor (includes processor and replacement thermal material)
693230-001	System board for use only with computer models equipped with an Intel 1.4GHz processor (includes processor and replacement thermal material)
693231-001	System board for use only with computer models equipped with an Intel 1.6GHz processor (includes processor and replacement thermal material)
693232-001	System board for use only with computer models equipped with an Intel 1.4GHz processor (includes processor and replacement thermal material)
693233-001	System board for use only with computer models equipped with an Intel 1.6GHz processor (includes processor and replacement thermal material)
693234-001	System board for use only with computer models equipped with an Intel 1.7GHz processor (includes processor and replacement thermal material)
693234-501	System board for use only with computer models equipped with an Intel 1.7GHz processor (includes processor and replacement thermal material)
693234-601	System board for use only with computer models equipped with an Intel 1.7GHz processor (includes processor and replacement thermal material)
693715-001	AC adapter non-smart 65W
693753-001	System board for use only with computer models equipped with an Intel 1.5GHz processor (includes processor and replacement thermal material)
693753-501	System board for use only with computer models equipped with an Intel 1.5GHz processor (includes processor and replacement thermal material)
693715-001	AC adapter
693753-601	System board for use only with computer models equipped with an Intel 1.5GHz processor (includes processor and replacement thermal material)
693754-001	System board for use only with computer models equipped with an Intel 1.5GHz processor (includes processor and replacement thermal material)
693754-501	System board for use only with computer models equipped with an Intel 1.5GHz processor (includes processor and replacement thermal material)
693754-601	System board for use only with computer models equipped with an Intel 1.5GHz processor (includes processor and replacement thermal material)
693755-001	System board for use only with computer models equipped with an Intel 1.8GHz processor (includes processor and replacement thermal material)
693755-501	System board for use only with computer models equipped with an Intel 1.8GHz processor (includes processor and replacement thermal material)
693755-601	System board for use only with computer models equipped with an Intel 1.8GHz processor (includes processor and replacement thermal material)
694436-001	System board for use only with computer models equipped with an AMD processor (includes processor and replacement thermal material)
694436-501	System board for use only with computer models equipped with an AMD processor (includes processor and replacement thermal material)

Spare part number	Description
694436-601	System board for use only with computer models equipped with an AMD processor (includes processor and replacement thermal material)
694437-001	System board for use only with computer models equipped with an AMD processor (includes processor and replacement thermal material)
694437-30`	System board for use only with computer models equipped with an AMD processor (includes processor and replacement thermal material)
694437-601	System board for use only with computer models equipped with an AMD processor (includes processor and replacement thermal material)
694471-001	Display back cover

4 Removal and replacement procedures

 **CAUTION:** This computer does not have user-replaceable parts. Only HP authorized service providers should perform the removal and replacement procedures described here. Accessing the internal part could damage the computer or void the warranty.

Preliminary replacement requirements

Tools required

You will need the following tools to complete the removal and replacement procedures:

- Flat-bladed screwdriver
- Magnetic screwdriver
- Phillips P0 and P1 screwdrivers

Service considerations

The following sections include some of the considerations that you must keep in mind during disassembly and assembly procedures.

 **NOTE:** As you remove each subassembly from the computer, place the subassembly (and all accompanying screws) away from the work area to prevent damage.

Plastic parts

 **CAUTION:** Using excessive force during disassembly and reassembly can damage plastic parts. Use care when handling the plastic parts. Apply pressure only at the points designated in the maintenance instructions.

Cables and connectors

 **CAUTION:** When servicing the computer, be sure that cables are placed in their proper locations during the reassembly process. Improper cable placement can damage the computer.

Cables must be handled with extreme care to avoid damage. Apply only the tension required to unseat or seat the cables during removal and insertion. Handle cables by the connector whenever possible. In all cases, avoid bending, twisting, or tearing cables. Be sure that cables are routed in such a way that they cannot be caught or snagged by parts being removed or replaced. Handle flex cables with extreme care; these cables tear easily.

Drive handling

⚠ CAUTION: Drives are fragile components that must be handled with care. To prevent damage to the computer, damage to a drive, or loss of information, observe these precautions:

Before removing or inserting a hard drive, shut down the computer. If you are unsure whether the computer is off or in Hibernation, turn the computer on, and then shut it down through the operating system.

Before handling a drive, be sure that you are discharged of static electricity. While handling a drive, avoid touching the connector.

Before removing a diskette drive or optical drive, be sure that a diskette or disc is not in the drive and be sure that the optical drive tray is closed.

Handle drives on surfaces covered with at least one inch of shock-proof foam.

Avoid dropping drives from any height onto any surface.

After removing a hard drive, an optical drive, or a diskette drive, place it in a static-proof bag.

Avoid exposing an internal hard drive to products that have magnetic fields, such as monitors or speakers.

Avoid exposing a drive to temperature extremes or liquids.

If a drive must be mailed, place the drive in a bubble pack mailer or other suitable form of protective packaging and label the package "FRAGILE."

Grounding guidelines

Electrostatic discharge damage

Electronic components are sensitive to electrostatic discharge (ESD). Circuitry design and structure determine the degree of sensitivity. Networks built into many integrated circuits provide some protection, but in many cases, ESD contains enough power to alter device parameters or melt silicon junctions.

A discharge of static electricity from a finger or other conductor can destroy static-sensitive devices or microcircuitry. Even if the spark is neither felt nor heard, damage may have occurred.

An electronic device exposed to ESD may not be affected at all and can work perfectly throughout a normal cycle. Or the device may function normally for a while, then degrade in the internal layers, reducing its life expectancy.

⚠ CAUTION: To prevent damage to the computer when you are removing or installing internal components, observe these precautions:

Keep components in their electrostatic-safe containers until you are ready to install them.

Before touching an electronic component, discharge static electricity by using the guidelines described in this section.

Avoid touching pins, leads, and circuitry. Handle electronic components as little as possible.

If you remove a component, place it in an electrostatic-safe container.

The following table shows how humidity affects the electrostatic voltage levels generated by different activities.

⚠ CAUTION: A product can be degraded by as little as 700 V.

Typical electrostatic voltage levels

Event	Relative humidity		
	10%	40%	55%
Walking across carpet	35,000 V	15,000 V	7,500 V
Walking across vinyl floor	12,000 V	5,000 V	3,000 V
Motions of bench worker	6,000 V	800 V	400 V
Removing DIPS from plastic tube	2,000 V	700 V	400 V
Removing DIPS from vinyl tray	11,500 V	4,000 V	2,000 V
Removing DIPS from Styrofoam	14,500 V	5,000 V	3,500 V
Removing bubble pack from PCB	26,500 V	20,000 V	7,000 V
Packing PCBs in foam-lined box	21,000 V	11,000 V	5,000 V

Packaging and transporting guidelines

Follow these grounding guidelines when packaging and transporting equipment:

- To avoid hand contact, transport products in static-safe tubes, bags, or boxes.
- Protect ESD-sensitive parts and assemblies with conductive or approved containers or packaging.
- Keep ESD-sensitive parts in their containers until the parts arrive at static-free workstations.
- Place items on a grounded surface before removing items from their containers.
- Always be properly grounded when touching a component or assembly.
- Store reusable ESD-sensitive parts from assemblies in protective packaging or nonconductive foam.
- Use transporters and conveyors made of antistatic belts and roller bushings. Be sure that mechanized equipment used for moving materials is wired to ground and that proper materials are selected to avoid static charging. When grounding is not possible, use an ionizer to dissipate electric charges.

Workstation guidelines

Follow these grounding workstation guidelines:

- Cover the workstation with approved static-shielding material.
- Use a wrist strap connected to a properly grounded work surface and use properly grounded tools and equipment.
- Use conductive field service tools, such as cutters, screwdrivers, and vacuums.
- When fixtures must directly contact dissipative surfaces, use fixtures made only of static-safe materials.
- Keep the work area free of nonconductive materials, such as ordinary plastic assembly aids and Styrofoam.
- Handle ESD-sensitive components, parts, and assemblies by the case or PCM laminate. Handle these items only at static-free workstations.
- Avoid contact with pins, leads, or circuitry.
- Turn off power and input signals before inserting or removing connectors or test equipment.

Equipment guidelines

Grounding equipment must include either a wrist strap or a foot strap at a grounded workstation.

- When seated, wear a wrist strap connected to a grounded system. Wrist straps are flexible straps with a minimum of one megohm $\pm 10\%$ resistance in the ground cords. To provide proper ground, wear a strap snugly against the skin at all times. On grounded mats with banana-plug connectors, use alligator clips to connect a wrist strap.
- When standing, use foot straps and a grounded floor mat. Foot straps (heel, toe, or boot straps) can be used at standing workstations and are compatible with most types of shoes or boots. On conductive floors or dissipative floor mats, use foot straps on both feet with a minimum of one megohm resistance between the operator and ground. To be effective, the conductive must be worn in contact with the skin.

The following grounding equipment is recommended to prevent electrostatic damage:

- Antistatic tape
- Antistatic smocks, aprons, and sleeve protectors
- Conductive bins and other assembly or soldering aids
- Nonconductive foam
- Conductive tabletop workstations with ground cords of one megohm resistance
- Static-dissipative tables or floor mats with hard ties to the ground
- Field service kits
- Static awareness labels
- Material-handling packages
- Nonconductive plastic bags, tubes, or boxes
- Metal tote boxes
- Electrostatic voltage levels and protective materials

The following table lists the shielding protection provided by antistatic bags and floor mats.

Material	Use	Voltage protection level
Antistatic plastics	Bags	1,500 V
Carbon-loaded plastic	Floor mats	7,500 V
Metallized laminate	Floor mats	5,000 V

Component replacement procedures

This chapter provides removal and replacement procedures.

There are as many as 77 screws that must be removed, replaced, or loosened when servicing the computer. Make special note of each screw size and location during removal and replacement.

Service label

When ordering parts or requesting information, provide the computer serial number and model number provided on the service label, which is found on the bottom of the computer.

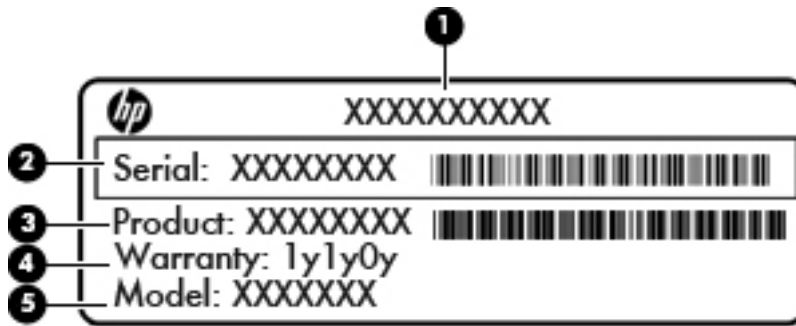

Item	Component	Description
(1)	Product name	This is the product name affixed to the front of the computer.
(2)	Serial number (s/n)	This is an alphanumeric identifier that is unique to each product.
(3)	Part number/Product number (p/n)	This number provides specific information about the product's hardware components. The part number helps a service technician determine what components and parts are needed.
(4)	Warranty period	This number describes the duration of the warranty period for the computer.
(5)	Model description (select models only)	This is the alphanumeric identifier used to locate documents, drivers, and support for the computer.

Display panel

Description	Spare part number
15.6-in, LED, BrightView SVA display panel	686602-001

Before removing the display panel, follow these steps:

1. Shut down the computer. If you are unsure whether the computer is off or in Hibernation, turn the computer on, and then shut it down through the operating system.
2. Disconnect all external devices connected to the computer.
3. Disconnect the power from the computer by first unplugging the power cord from the AC outlet and then unplugging the AC adapter from the computer.

Remove the display panel:

1. Turn the computer right-side up, with the rear toward you.
2. Open the computer.
3. Remove the screw covers (1) on the left and right side of the display panel.
4. Remove the 2 Phillips PM 2.5x2.5 screws (2) on the left and right hinges that secure the display panel to the computer.

 **NOTE:** Support the display panel as you are removing the screws.

5. Loosen the edges of the plastic bezel cover (3) from all four sides of the display panel.
6. Lift the display bezel cover (4), and then remove the cover (5).

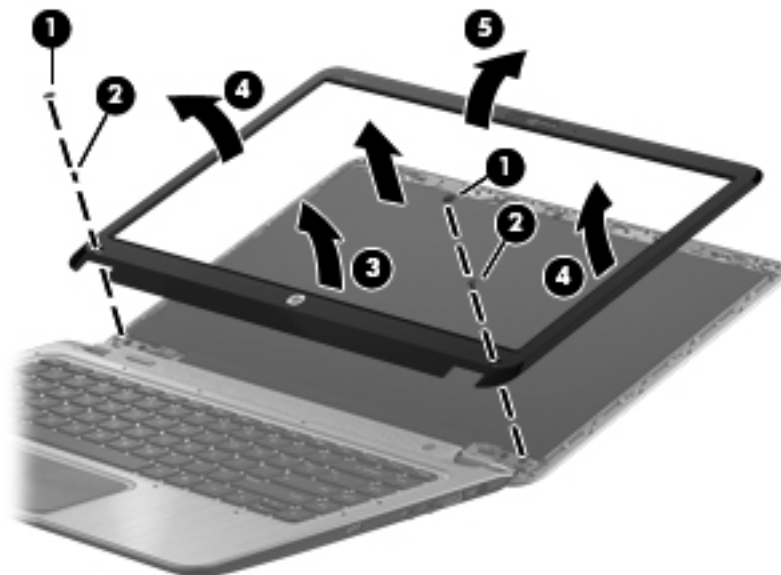

7. Remove the 4 Phillips PM 2x2 display panel screws.

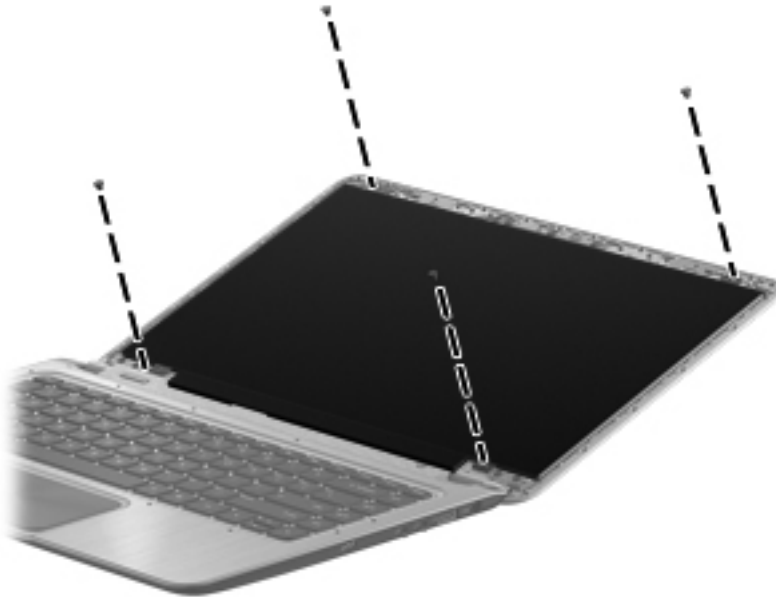

8. Remove any tabs or tape adhering to the display panel (1), and then move the panel towards the keyboard (2).



NOTE: Support the display panel as you lean the panel forward.

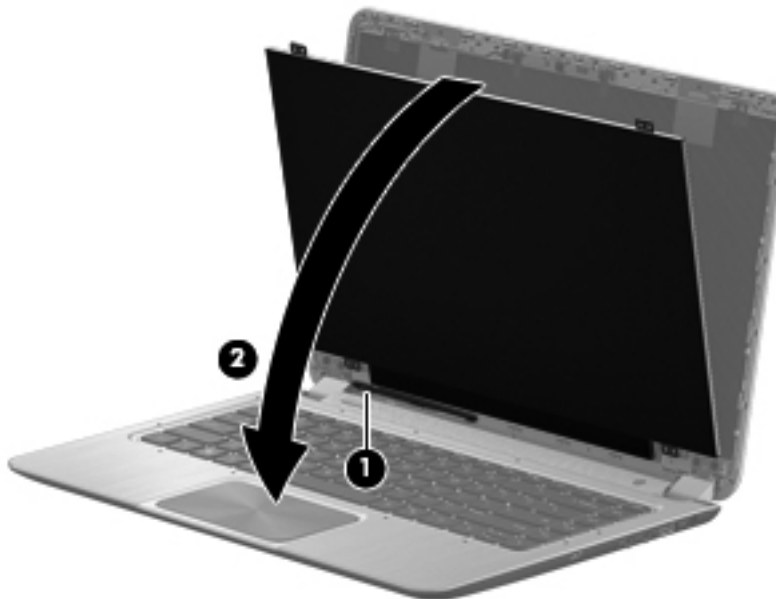

9. Release the support strip (1) covering the display panel connector. Disconnect the display panel cable from the display panel (2), and then remove the panel (3).

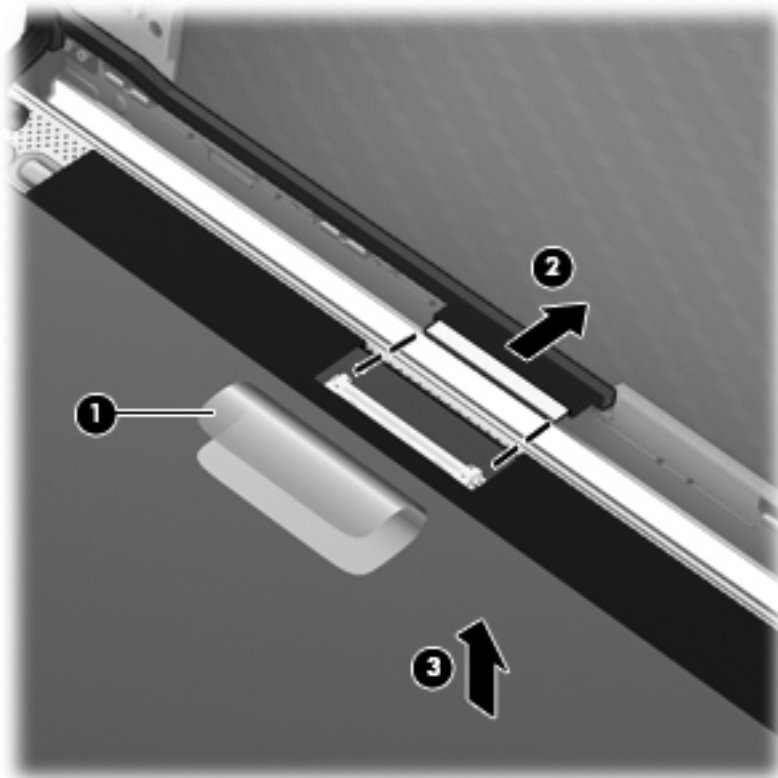

Reverse this procedure to install the display panel.

Base enclosure

Description	Spare part number
Base enclosure (Red)	686096-001
Base enclosure (Black)	690197-001
Base enclosure (Red)	689855-001

Before disassembling the computer, follow these steps:

1. Shut down the computer. If you are unsure whether the computer is off or in Hibernation, turn the computer on, and then shut it down through the operating system.
2. Disconnect all external devices connected to the computer.
3. Disconnect the power from the computer by first unplugging the power cord from the AC outlet and then unplugging the AC adapter from the computer.
4. Remove the display panel (see [Display panel on page 32](#)).

Remove the base enclosure:

1. Turn the computer face down, remove the 12 Phillips PM 7.5 millimeter long screws.

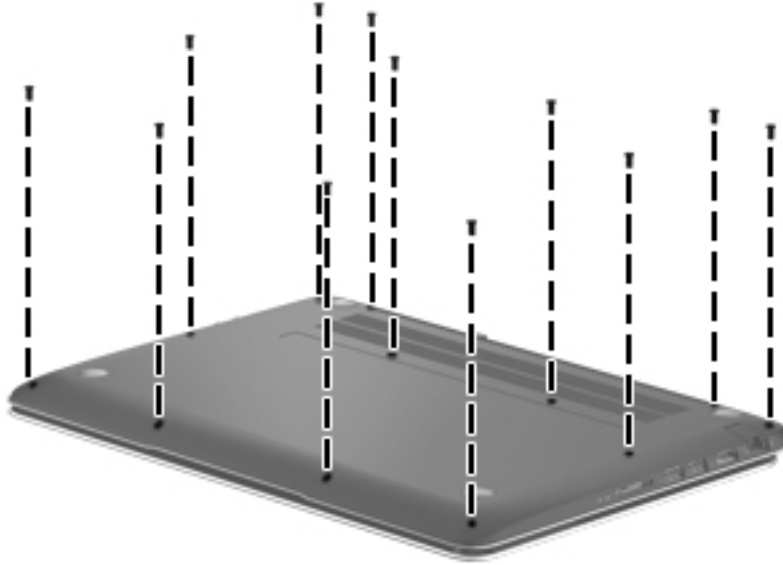

2. Remove the bottom enclosure.



NOTE: To remove the bottom enclosure, use a thin, non-conductive tool such as the HP Tool Shroud separator, available on the HP website.



Battery

Description	Spare part number
4-cell, 60WHr 4.1AH Li-ion battery	681951-001

Before removing the battery, follow these steps:

1. Shut down the computer. If you are unsure whether the computer is off or in Hibernation, turn the computer on, and then shut it down through the operating system.
2. Disconnect all external devices connected to the computer.
3. Disconnect the power from the computer by first unplugging the power cord from the AC outlet and then unplugging the AC adapter from the computer.
4. Remove the display panel (see [Display panel on page 32](#)).
5. Remove the base enclosure (see [Base enclosure on page 34](#)).

Remove the battery:

1. Turn the computer right-side up, with the front toward you.
2. Disconnect the battery cable.

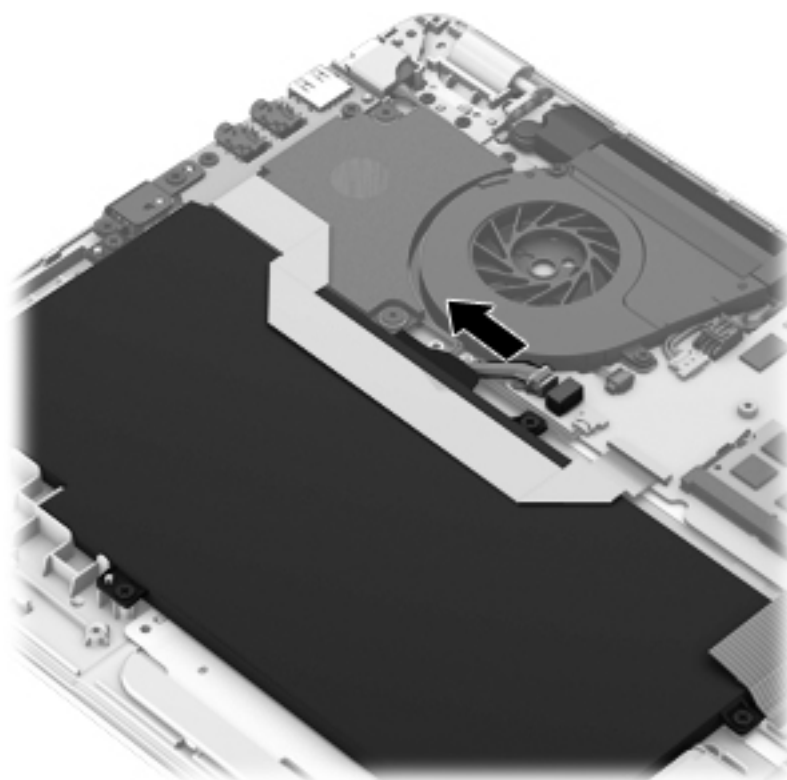

3. Move the battery cable to the side **(1)**, and then remove the 6 Phillips PM 2.5×4.2 screws **(2)** that secure the battery to the computer.

4. Remove the battery from the computer (3).

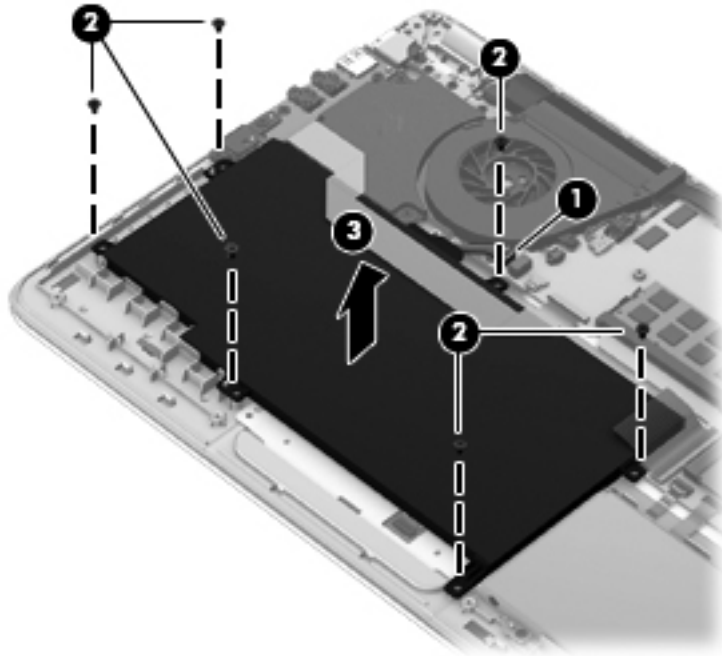

Reverse this procedure to install the battery.

Hard drive

Description	Spare part number
320-GB 7200RPM SATA 7mm	634862-005
320-GB 5400RPM SATA 7mm	645193-005
500-GB 5400RPM SATA 7mm	683802-005
32-GB mSATA solid-state drive (SSD)	687100-001
128-GB mSATA solid-state drive (SSD)	687101-001

Before removing the hard drive or SSD, follow these steps:

1. Shut down the computer. If you are unsure whether the computer is off or in Hibernation, turn the computer on, and then shut it down through the operating system.
2. Disconnect all external devices connected to the computer.
3. Disconnect the power from the computer by first unplugging the power cord from the AC outlet and then unplugging the AC adapter from the computer.
4. Remove the display panel (see [Display panel on page 32](#)).
5. Remove the base enclosure (see [Base enclosure on page 34](#)).
6. Disconnect the battery cable (see [Battery on page 36](#)).

Remove the hard drive:

1. Disconnect the hard drive cable from the system board **(1)**, and then remove the 4 screws **(2)** securing the hard drive to the top cover.

2. Remove the hard drive (3).

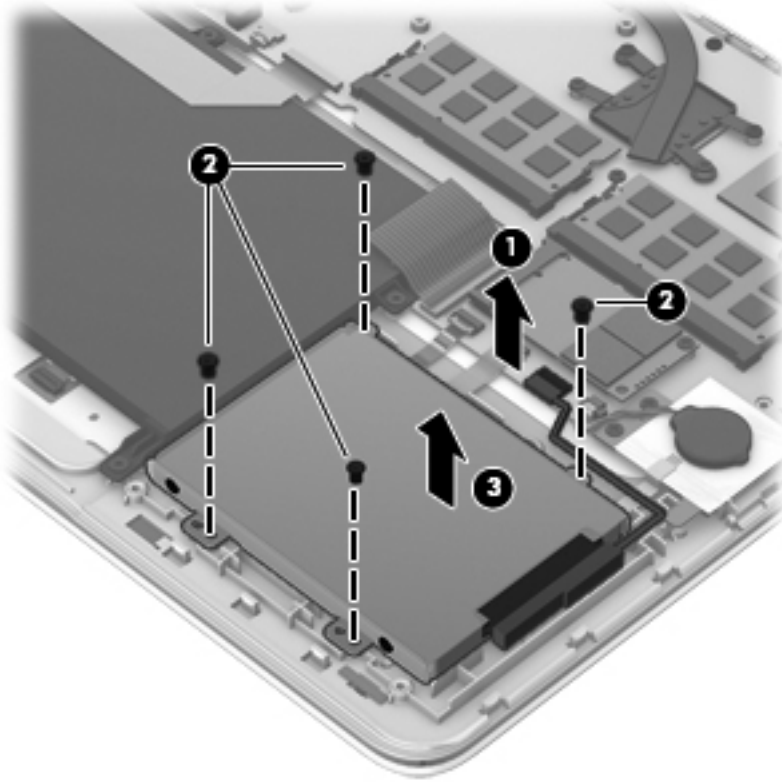

3. Remove the hard drive connector cable (1). Remove the 4 screws (2) securing the hard drive bracket to the hard drive, and then remove the hard drive bracket (3).

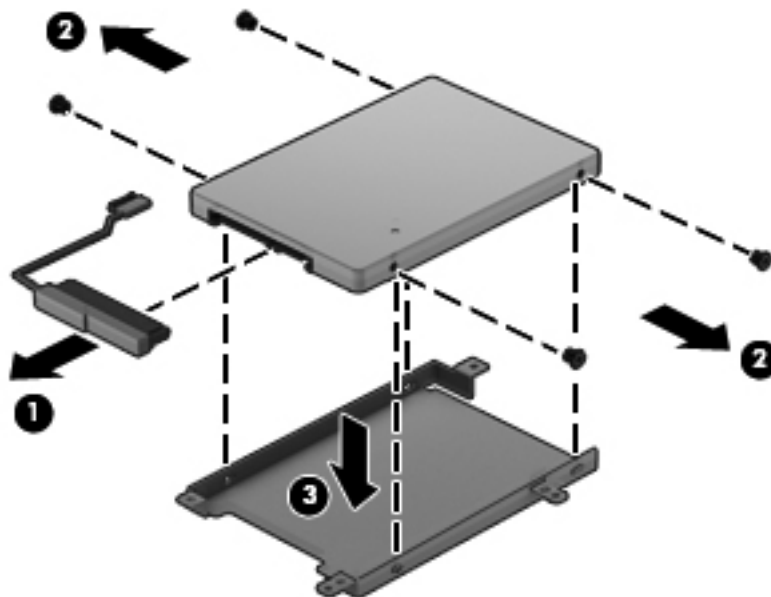

4. Remove the hard drive (3).

Remove the mSATA solid-state drive:

- ▲ Remove the screw (1), and then remove the mSATA solid-state drive (2).

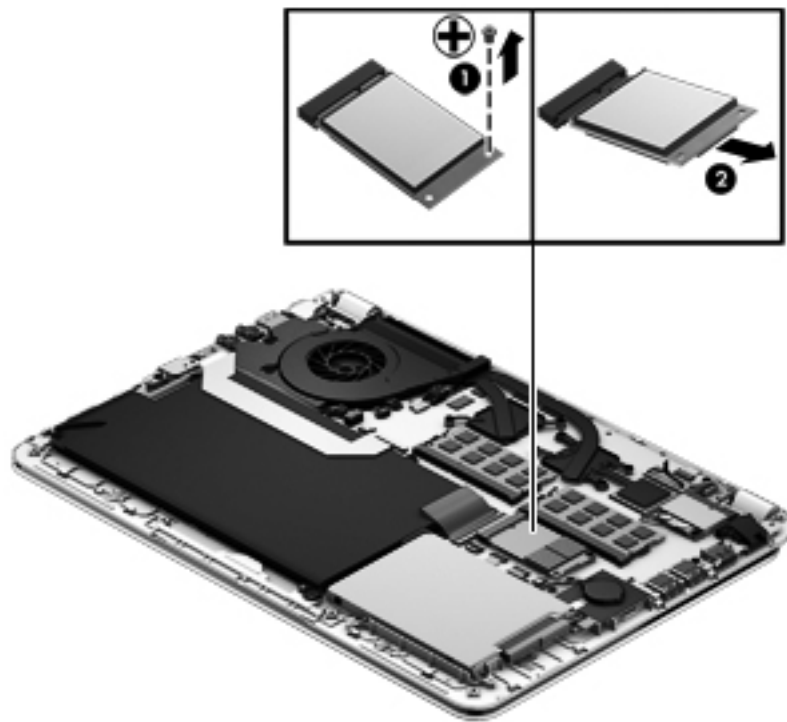

Reverse these procedures to reassemble and install the hard drive.

RTC battery

Description	Spare part number
RTC battery	686922-001

Before removing the RTC battery, follow these steps:

1. Shut down the computer. If you are unsure whether the computer is off or in Hibernation, turn the computer on, and then shut it down through the operating system.
2. Disconnect all external devices connected to the computer.
3. Disconnect the power from the computer by first unplugging the power cord from the AC outlet and then unplugging the AC adapter from the computer.
4. Remove the display panel (see [Display panel on page 32](#)).
5. Remove the base enclosure (see [Base enclosure on page 34](#)).
6. Disconnect the battery cable (see [Battery on page 36](#)).

Remove the RTC battery:

1. Use a thin, non-conductive tool to remove the RTC battery from the socket on the system board.

 **NOTE:** Use a thin, non-conductive tool to remove the RTC battery from the socket on the system board.

2. Hold down the media card reader board (2), and remove the RTC battery (3). (The RTC battery is also attached to the system board by foam material rather than double-sided adhesive.)

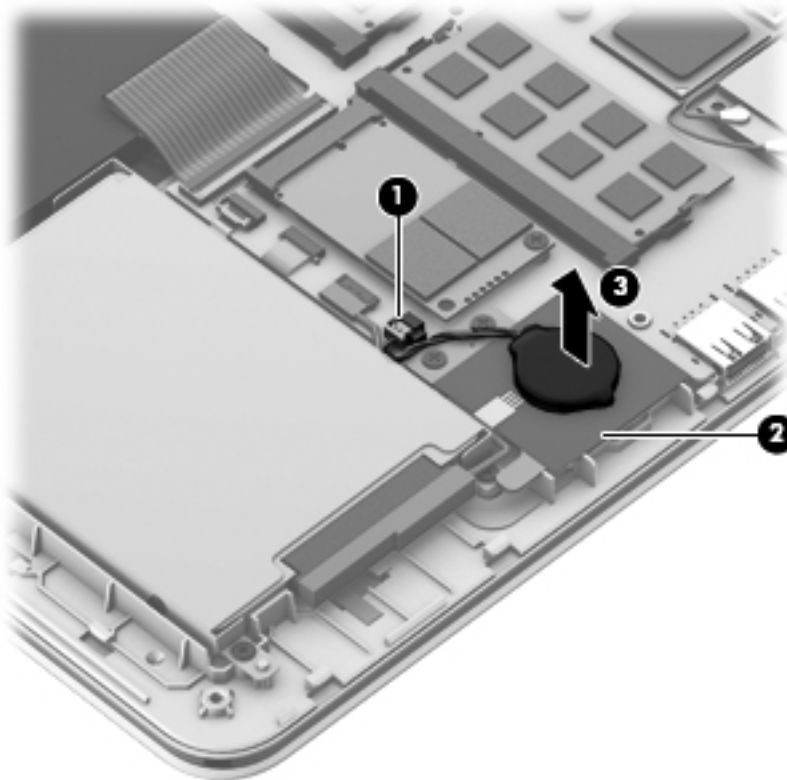

Reverse this procedure to install the RTC battery on computer models. When installing the RTC battery, make sure the “+” sign faces up.

TouchPad module

Description	Spare part number
TouchPad button board (includes cable)	688001–001
TouchPad button board (includes cable)	691643–001

Before removing the TouchPad button board, follow these steps:

1. Shut down the computer. If you are unsure whether the computer is off or in Hibernation, turn the computer on, and then shut it down through the operating system.
2. Disconnect all external devices connected to the computer.
3. Disconnect the power from the computer by first unplugging the power cord from the AC outlet and then unplugging the AC adapter from the computer.
4. Remove the display panel (see [Display panel on page 32](#)).
5. Remove the base enclosure (see [Base enclosure on page 34](#)).

Remove the TouchPad button board and cable:

1. Turn the top cover upside down, with the back edge toward you.
2. Disconnect the cable **(1)** that secures the TouchPad cable to the system board.
3. Remove the 4 Phillips PM 2.5×3.0 black screws **(2)** that secure the TouchPad button board to the top cover.
4. Remove the 2 Phillips PM 2.5×3.0 silver screws, and then remove the TouchPad bracket **(3)**.

5. Lift up on the rear edge, slide backwards, and then remove the TouchPad button board and cable (4).

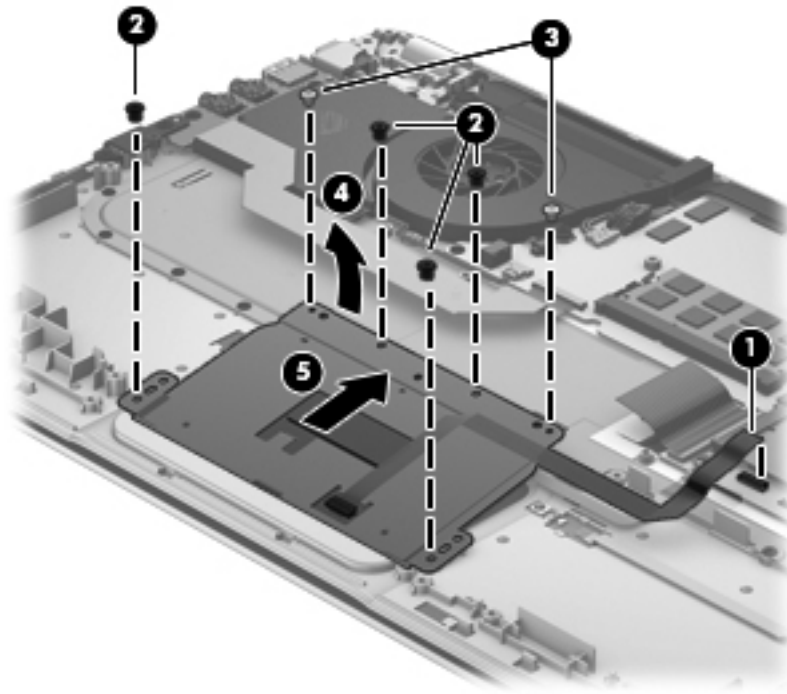

Reverse this procedure to install the TouchPad button board and cable.

WLAN module

Description	Spare part number
Intel® Centrino® Wireless-N 1030 + Bluetooth combo w/ *2 antennas (802.11 b/g/n, Bluetooth 3.0)	670290-005
Atheros 9485GN 802.11b/g/n 1×1 WiFi and 3012 Bluetooth 4.0 Combo Adapter	655795-005
Broadcom 4313GN 802.11b/g/n 1×1 WiFi and 20702 Bluetooth 4.0 Combo Adapter	657325-005
Atheros 9485GN 802.11b/g/n 1×1 WiFi and 3012 Bluetooth 4.0 Combo Adapter	690019-001
Intel® Centrino® Wireless-N 1030 + Bluetooth combo w/ *2 antennas (802.11 b/g/n, Bluetooth 3.0)	690020-001
Intel® Centrino® Wireless-N 1030 + Bluetooth combo w/ *2 antennas (802.11 b/g/n, Bluetooth 3.0)	690020-005

 **CAUTION:** To prevent an unresponsive system, replace the wireless module only with a wireless module authorized for use in the computer by the governmental agency that regulates wireless devices in your country or region. If you replace the module and then receive a warning message, remove the module to restore device functionality, and then contact technical support.

Before removing the WLAN module, follow these steps:

1. Shut down the computer. If you are unsure whether the computer is off or in Hibernation, turn the computer on, and then shut it down through the operating system.
2. Disconnect all external devices connected to the computer.
3. Disconnect the power from the computer by first unplugging the power cord from the AC outlet and then unplugging the AC adapter from the computer.
4. Remove the display panel (see [Display panel on page 32](#)).
5. Remove the base enclosure (see [Base enclosure on page 34](#)).
6. Disconnect the battery cable (see [Battery on page 36](#)).

Remove the WLAN module:

1. Disconnect the #1 and #2 WLAN antenna cables from the WLAN module **(1)**.

 **NOTE:** The #1 WLAN antenna cable is connected to the WLAN module #1 main terminal. The #2 WLAN antenna cable is connected to the WLAN module #2 auxiliary terminal.

2. Remove the Phillips PM 2.0×2.5 screw **(2)** that secures the WLAN module to the system board. (The WLAN module tilts up.)

3. Remove the WLAN module by pulling the module away from the slot at an angle (3).

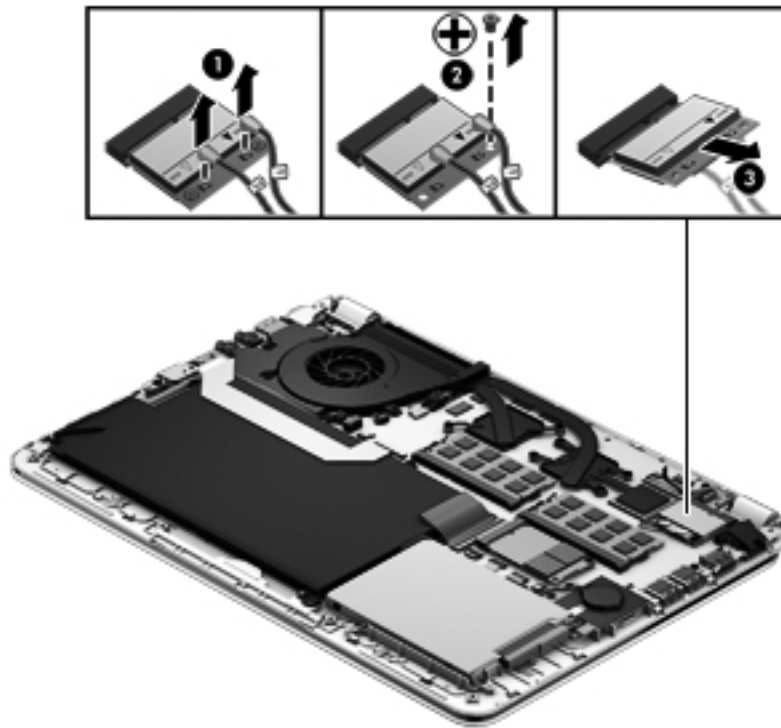

NOTE: If the WLAN antennas are not connected to the terminals on the WLAN module, the protective sleeves must be installed on the antenna connectors.

Memory module

Description	Spare part number
4-GB memory module (PC3, 12800, 1600-MHz)	641369-005
2-GB memory module (PC3, 12800, 1600-MHz)	652972-005
8-GB memory module (PC3, 12800, 1600-MHz)	670034-005

Before removing a memory module, follow these steps:

1. Shut down the computer. If you are unsure whether the computer is off or in Hibernation, turn the computer on, and then shut it down through the operating system.
2. Disconnect all external devices connected to the computer.
3. Disconnect the power from the computer by first unplugging the power cord from the AC outlet and then unplugging the AC adapter from the computer.
4. Remove the display panel (see [Display panel on page 32](#)).
5. Remove the base enclosure (see [Base enclosure on page 34](#)).
6. Remove the keyboard (see [Keyboard on page 62](#)).

7. Remove the top cover (see [Top cover on page 66](#)).
8. Disconnect the battery cable (see [Battery on page 36](#)).

Remove the memory module:

1. Spread the retaining tabs **(1)** on each side of the memory module slot to release the memory module. (The memory module tilts up.)

⚠ CAUTION: To prevent damage to the memory module, hold it by the edges only. Do not touch the components on the memory module.

2. Slide the memory module forward **(2)**.
3. Remove the memory module **(3)**.

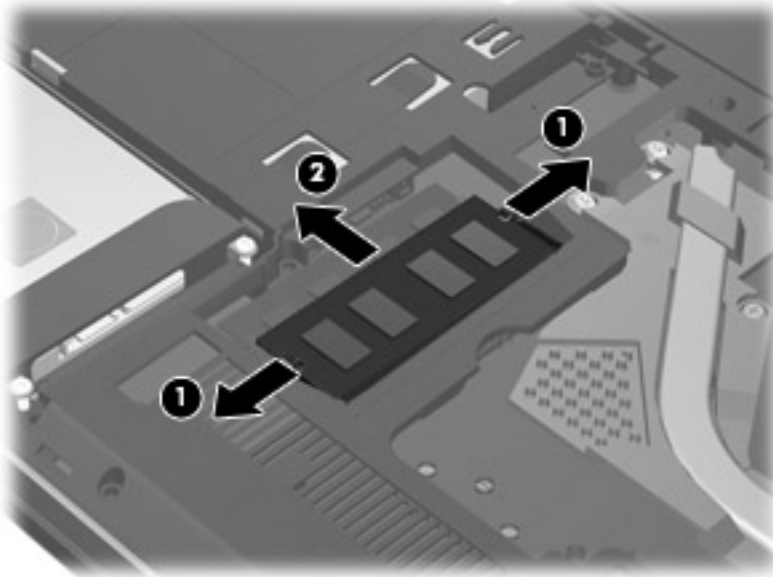

Reverse this procedure to install a memory module.

Fan

Description	Spare part number
Fan	686580-001

Before removing the fan:

1. Shut down the computer. If you are unsure whether the computer is off or in Hibernation, turn the computer on, and then shut it down through the operating system.
2. Disconnect all external devices connected to the computer.
3. Disconnect the power from the computer by first unplugging the power cord from the AC outlet and then unplugging the AC adapter from the computer.
4. Remove the display panel (see [Display panel on page 32](#)).
5. Remove the base enclosure (see [Base enclosure on page 34](#)).
6. Disconnect the battery cable (see [Battery on page 36](#)).

Remove the fan:

1. Disconnect the fan cable (1).
2. Remove the 2 Phillips PM screws (2) securing the fan to the unit, and then lift the fan upwards (3).
3. Remove the piece of tape on the underside of the heat sink that secures the fan to the unit (4).

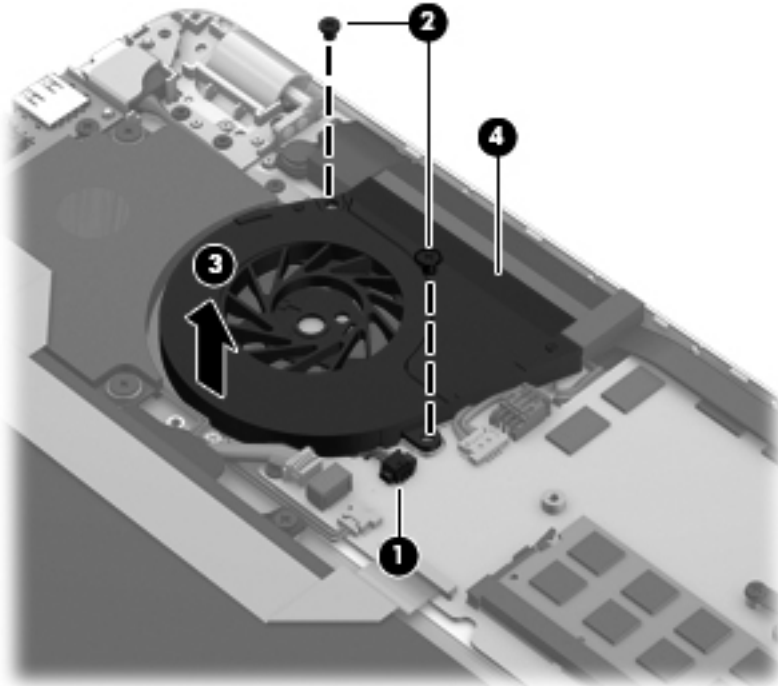

System board

 **NOTE:** The system board spare part kit includes replacement thermal material.

Description	Spare part number
For use only with computer models equipped with an Intel 1.8GHz processor, but not WWAN capability (includes replacement thermal material)	693228-001
For use only with computer models equipped with an Intel 1.8GHz processor but not WWAN capability (includes replacement thermal material)	693228-501
For use only with computer models equipped with an Intel 1.8GHz processor, but not WWAN capability (includes replacement thermal material)	693228-601
For use only with computer models equipped with an Intel 1.7GHz processor, but not WWAN capability (includes replacement thermal material)	693229-001
For use only with computer models equipped with an Intel 1.7GHz processor, but not WWAN capability (includes replacement thermal material)	693229-501
For use only with computer models equipped with an Intel 1.7GHz processor (includes replacement thermal material)	693229-601
For use only with computer models equipped with an Intel 1.4GHz processor (includes replacement thermal material)	693230-001

Description	Spare part number
For use only with computer models equipped with an Intel 1.6GHz processor (includes replacement thermal material)	693231-001
For use only with computer models equipped with an Intel 1.4GHz processor (includes replacement thermal material)	693232-001
For use only with computer models equipped with an Intel 1.6GHz processor (includes replacement thermal material)	693233-001
For use only with computer models equipped with an Intel 1.7GHz processor (includes replacement thermal material)	693234-001
For use only with computer models equipped with an Intel 1.7GHz processor (includes replacement thermal material)	693234-501
For use only with computer models equipped with an Intel 1.7GHz processor (includes replacement thermal material)	693234-601
For use only with computer models equipped with an Intel 1.5GHz processor (includes replacement thermal material)	693753-001
For use only with computer models equipped with an Intel 1.5GHz processor (includes replacement thermal material)	693753-501
For use only with computer models equipped with an Intel 1.5GHz processor (includes replacement thermal material)	693753-601
For use only with computer models equipped with an Intel 1.5GHz processor (includes replacement thermal material)	693754-001
For use only with computer models equipped with an Intel 1.5GHz processor (includes replacement thermal material)	693754-501
For use only with computer models equipped with an Intel 1.5GHz processor (includes replacement thermal material)	693754-601
For use only with computer models equipped with an Intel 1.8GHz processor (includes replacement thermal material)	693755-001
For use only with computer models equipped with an Intel 1-8GHz processor (includes replacement thermal material)	693755-501
For use only with computer models equipped with an Intel 1.8GHz processor (includes replacement thermal material)	693755-601
For use only with computer models equipped with an AMD 2.6GHz/2.1GHz processor (includes replacement thermal material)	689157-001
For use only with computer models equipped with an AMD 2.6GHz/2.1GHz processor (includes replacement thermal material)	689157-501
For use only with computer models equipped with an AMD 2.6GHz/2.1GHz processor (includes replacement thermal material)	689157-601
For use only with computer models equipped with an AMD 2.8GHz/2.0GHz processor (includes replacement thermal material)	689158-001
For use only with computer models equipped with an AMD 2.8GHz/2.0GHz processor (includes replacement thermal material)	689158-001
For use only with computer models equipped with an AMD 2.8GHz/2.0GHz processor (includes replacement thermal material)	689158-001
For use only with computer models equipped with an AMD processor (includes replacement thermal material)	694436-001

Description	Spare part number
For use only with computer models equipped with an AMD processor (includes replacement thermal material)	694436-501
For use only with computer models equipped with an AMD processor (includes replacement thermal material)	694436-601
For use only with computer models equipped with an AMD 2.8GHz/2.0GHz processor (includes replacement thermal material)	694437-001
For use only with computer models equipped with an AMD 2.8GHz/2.0GHz processor (includes replacement thermal material)	694437-501
For use only with computer models equipped with an AMD 2.8GHz/2.0GHz processor (includes replacement thermal material)	694437-601

Before removing the system board, follow these steps:

1. Shut down the computer. If you are unsure whether the computer is off or in Hibernation, turn the computer on, and then shut it down through the operating system.
2. Disconnect all external devices connected to the computer.
3. Disconnect the power from the computer by first unplugging the power cord from the AC outlet and then unplugging the AC adapter from the computer.
4. Remove the display panel (see [Display panel on page 32](#)).
5. Remove the base enclosure (see [Base enclosure on page 34](#)).
6. Remove the battery (see [Battery on page 36](#)).
7. Remove the WLAN module (see [WLAN module on page 45](#)).
8. Remove the hard drive (see [Hard drive on page 38](#)).
9. Disconnect the display panel cable from the system board (see [Display panel on page 32](#)).
10. Remove the speaker (see [Speakers on page 60](#)).
11. Remove the power connector and cable (see [Power connector cable on page 59](#)).
12. Remove the USB/Audio and cable (see [USB/Audio](#)).

When replacing the system board, be sure that the following components are removed from the defective system board and installed on the replacement system board:

- RTC battery (see [RTC battery on page 41](#))
- Memory module (see [Memory module on page 46](#))
- Power connector cable (see [Power connector cable on page 59](#))
- Fan (see [Fan-Heat sink on page 53](#))
- Heat sink (see [Fan-Heat sink on page 53](#))
- WLAN module see ([WLAN module on page 45](#)).
- Hard drive (see [Hard drive on page 38](#)).
- USB/Audio (see [USB/Audio](#))
- Display panel cable (see [Display panel on page 32](#)).

Remove the system board:

1. Remove the following cables:
 - Power connector cable (1)
 - Speaker cable (2)
 - Subwoofer cable (3)
 - USB/Audio board cable (4)
 - Keyboard cable (5)
 - Keyboard light cable (6)
 - TouchPad board cable (7)
 - Wireless cable (8)
 - Display panel cable (9)
 - Power button board cable (10)

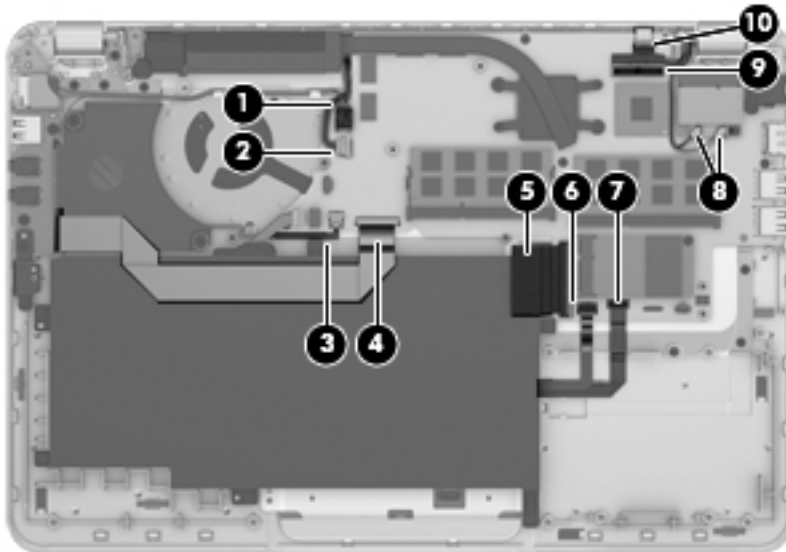

2. Remove the 4 Phillips PM 2.5x3 screws (1) until the system board rests at an angle.

3. Remove the system board (2) by sliding it up and to the right at an angle.

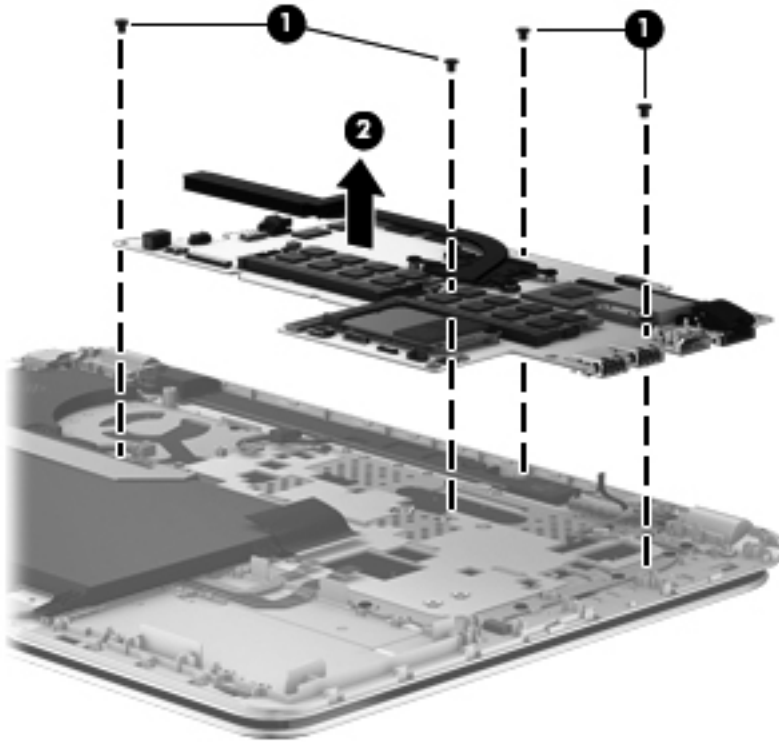

Reverse this procedure to install the system board.

Fan-Heat sink

Description	Spare part number
Fan — Heat sink	686578–001
Fan — Heat sink	686579–001
Fan — Heat sink	691656–001
Fan — Heat sink	691557–001



NOTE: To properly ventilate the computer, allow at least 7.6 cm (3 in) of clearance on the left side of the computer. The computer uses an electric fan for ventilation. The fan is controlled by a temperature sensor and is designed to turn on automatically when high temperature conditions exist. These conditions are affected by high external temperatures, system power consumption, power management/battery conservation configurations, battery fast charging, and software requirements. Exhaust air is displaced through the ventilation grill located on the left side of the computer.

Before removing the fan, follow these steps:

1. Shut down the computer. If you are unsure whether the computer is off or in Hibernation, turn the computer on, and then shut it down through the operating system.
2. Disconnect all external devices connected to the computer.
3. Disconnect the power from the computer by first unplugging the power cord from the AC outlet and then unplugging the AC adapter from the computer.
4. Remove the display panel (see [Display panel on page 32](#)).
5. Remove the base enclosure (see [Base enclosure on page 34](#)).
6. Disconnect the battery cable (see [Battery on page 36](#)).

Remove the fan:

1. Turn the computer, with the front toward you.
2. Disconnect the fan cable **(1)** from the system board.
3. Remove the 4 Phillips PM 2.0×3.0 screws securing the heat sink **(2)**, and the 2 Phillips PM 2.0×3.0 screws securing the fan **(3)**.

4. Remove the fan/heat sink (4).

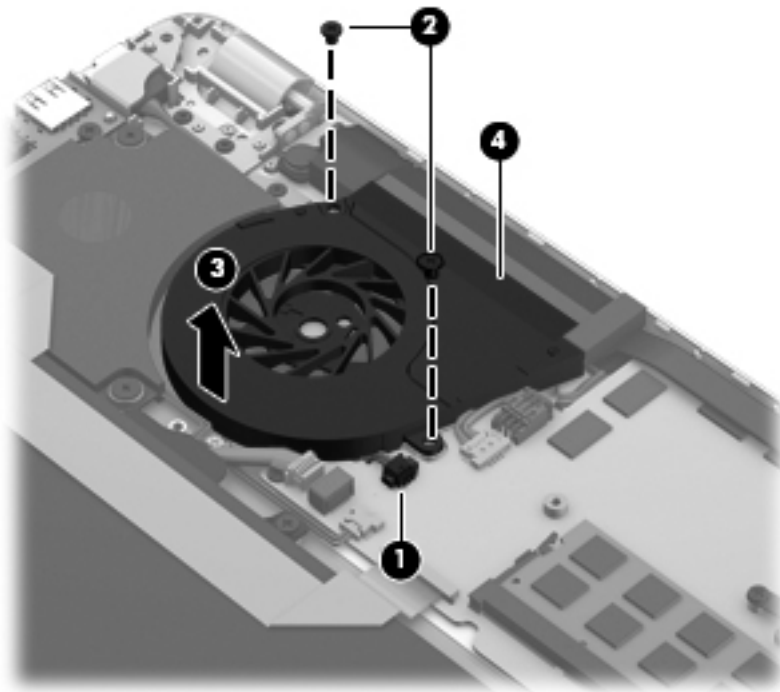

Reverse this procedure to install the fan/heat sink..

RJ-45 module cover

Description	Spare part number
RJ-45 module cover	691642-001

Before removing the RJ-45 module cover:

1. Shut down the computer. If you are unsure whether the computer is off or in Hibernation, turn the computer on, and then shut it down through the operating system.
2. Disconnect all external devices connected to the computer.
3. Disconnect the power from the computer by first unplugging the power cord from the AC outlet and then unplugging the AC adapter from the computer.
4. Remove the display panel (see [Display panel on page 32](#)).
5. Remove the base enclosure (see [Base enclosure on page 34](#)).
6. Disconnect the battery cable (see [Battery on page 36](#)).

Remove the RJ-45 module cover:

1. Remove the 2 Phillips PM screws securing the RJ-45 module cover (1).

2. Remove the cover (2).

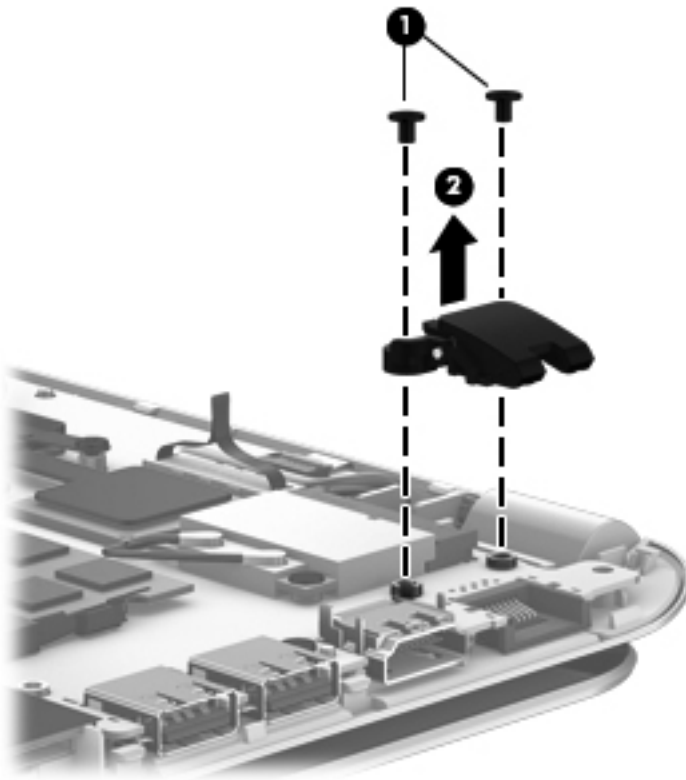

Media card reader assembly (smart card reader)

Description	Spare part number
Media card reader assembly (smart card reader)	688004-001

Before removing the media reader assembly, follow these steps:

1. Shut down the computer. If you are unsure whether the computer is off or in Hibernation, turn the computer on, and then shut it down through the operating system.
2. Disconnect all external devices connected to the computer.
3. Disconnect the power from the computer by first unplugging the power cord from the AC outlet and then unplugging the AC adapter from the computer.
4. Remove the display panel (see [Display panel on page 32](#)).
5. Remove the base enclosure (see [Base enclosure on page 34](#)).
6. Disconnect the battery cable (see [Battery on page 36](#)).

Remove the media card reader assembly:

1. Remove the 2 screws (1), and then lift the media card reader assembly (2).

2. Disconnect the cable (3), and then remove the media card reader (4).

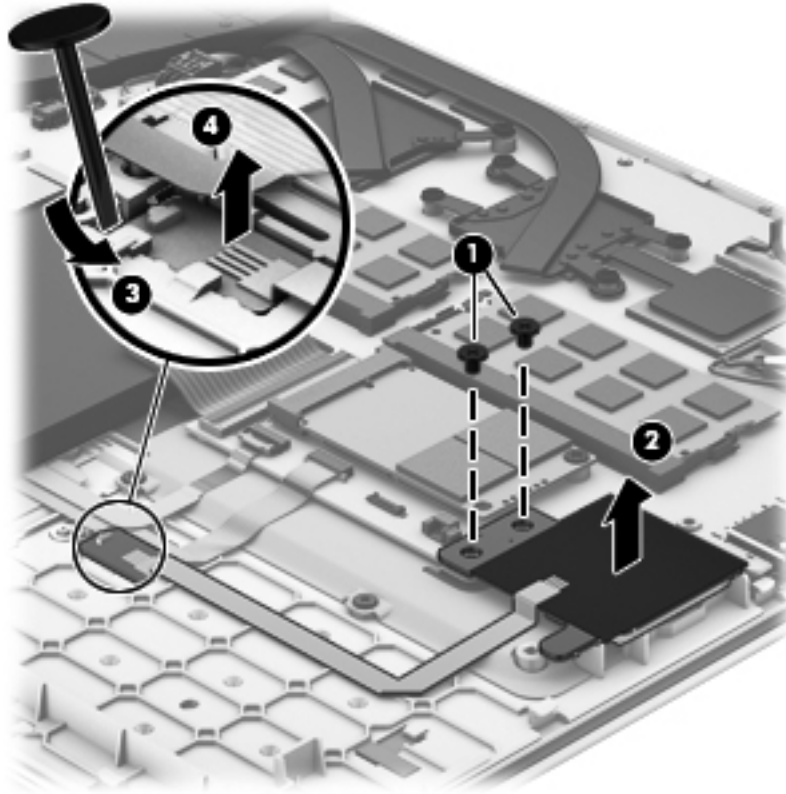

Subwoofer

Description	Spare part number
Subwoofer	686599-001

Before removing the USB/Audio board, follow these steps:

1. Shut down the computer. If you are unsure whether the computer is off or in Hibernation, turn the computer on, and then shut it down through the operating system.
2. Disconnect all external devices connected to the computer.
3. Disconnect the power from the computer by first unplugging the power cord from the AC outlet and then unplugging the AC adapter from the computer.
4. Remove the display panel (see [Display panel on page 32](#)).
5. Remove the base enclosure (see [Base enclosure on page 34](#)).
6. Disconnect the battery cable (see [Battery on page 36](#)).

Remove the subwoofer:

1. Disconnect the subwoofer cable (1).
2. Remove the 2 broadhead screws (2).

3. Remove the subwoofer (3).

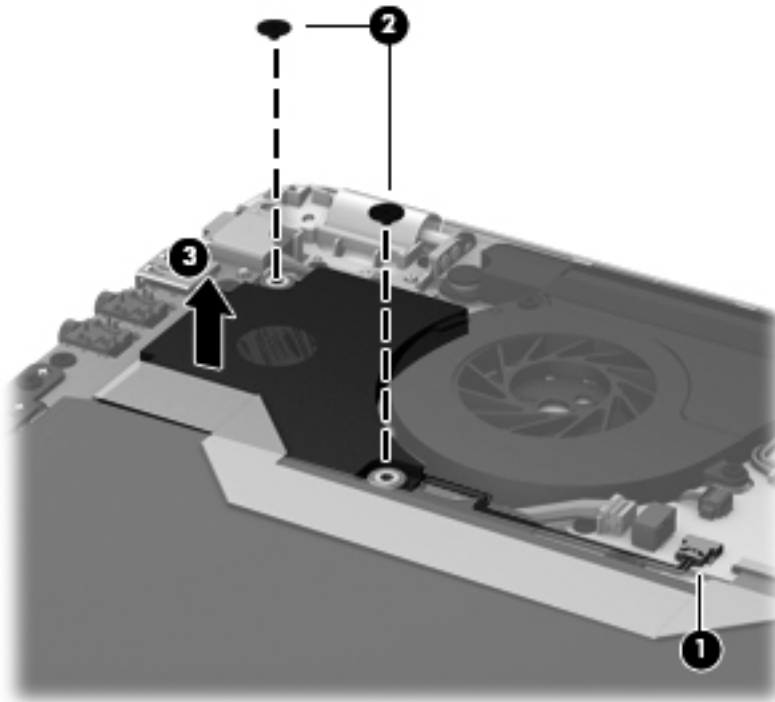

Security bracket

Description	Spare part number
Security bracket (included in power connector kit)	686593-001

Before you remove the security bracket, follow these steps:

1. Shut down the computer. If you are unsure whether the computer is off or in Hibernation, turn the computer on, and then shut it down through the operating system.
2. Disconnect all external devices connected to the computer.
3. Disconnect the power from the computer by first unplugging the power cord from the AC outlet and then unplugging the AC adapter from the computer.
4. Remove the display panel (see [Display panel on page 32](#)).
5. Disconnect the battery cable (see [Battery on page 36](#)).
6. Remove the subwoofer (see [Subwoofer on page 56](#)).

Remove the security bracket:

1. Remove the 2 Phillips PM screws (1).

2. Remove the security bracket (2).

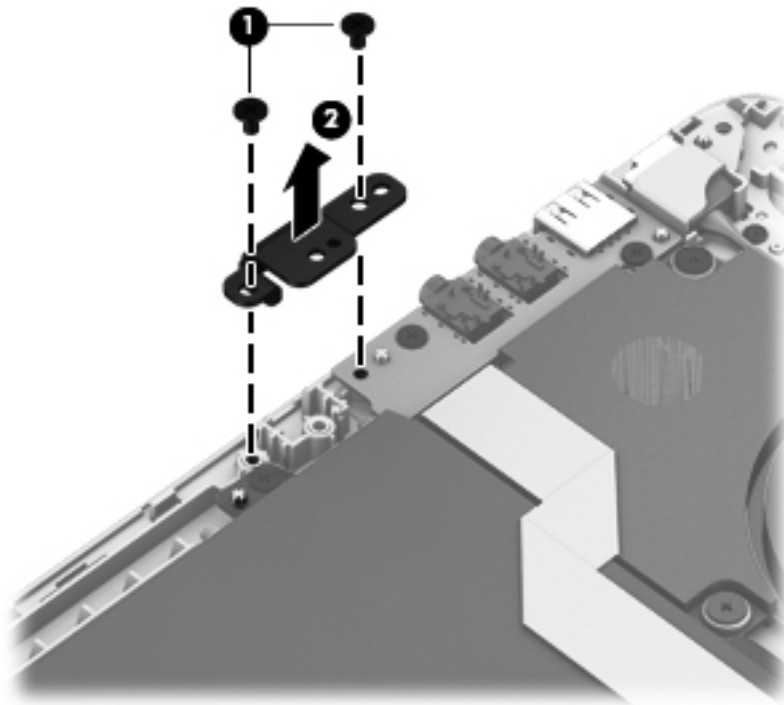

USB/Audio board

Description	Spare part number
USB/Audio board	686597-001

Before removing the USB/Audio board, follow these steps:

1. Shut down the computer. If you are unsure whether the computer is off or in Hibernation, turn the computer on, and then shut it down through the operating system.
2. Disconnect all external devices connected to the computer.
3. Disconnect the power from the computer by first unplugging the power cord from the AC outlet and then unplugging the AC adapter from the computer.
4. Remove the display panel (see [Display panel on page 32](#)).
5. Remove the base enclosure (see [Base enclosure on page 34](#)).
6. Disconnect the battery cable (see [Battery on page 36](#)).
7. Remove the subwoofer (see [Subwoofer on page 56](#)).
8. Remove the security bracket (see [Security bracket on page 57](#)).

Remove the USB/Audio board:

1. Disconnect the USB/Audio board cable from the system board (1)
2. Disconnect the Phillips PM 2.0x2.0 screw securing the USB/Audio board (2).

3. Remove the USB/Audio board (3).

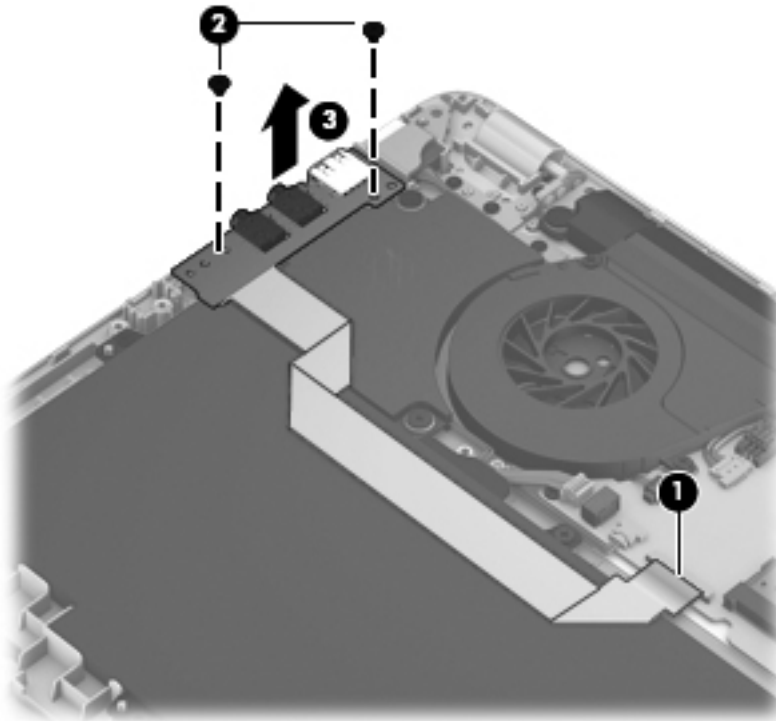

Power connector cable

Description	Spare part number
Power connector cable (includes bracket)	686593-001

Before removing the power connector cable, follow these steps:

1. Shut down the computer. If you are unsure whether the computer is off or in Hibernation, turn the computer on, and then shut it down through the operating system.
2. Disconnect all external devices connected to the computer.
3. Disconnect the power from the computer by first unplugging the power cord from the AC outlet and then unplugging the AC adapter from the computer.
4. Remove the display panel (see [Display panel on page 32](#)).
5. Remove the base enclosure (see [Base enclosure on page 34](#)).
6. Disconnect the battery cable (see [Battery on page 36](#)).
7. Remove the subwoofer (see [Subwoofer on page 56](#)).
8. Remove the security bracket (see [Security bracket on page 57](#)).
9. Remove the USB/Audio board (see [USB/Audio board on page 58](#)).

Remove the power connector cable:

1. Turn the computer, with the right side toward you.
2. Disconnect the power connector cable (1) from the system board.
3. Remove the double-sided tape (2) from the power connector.
4. Remove the power connector cable (3).

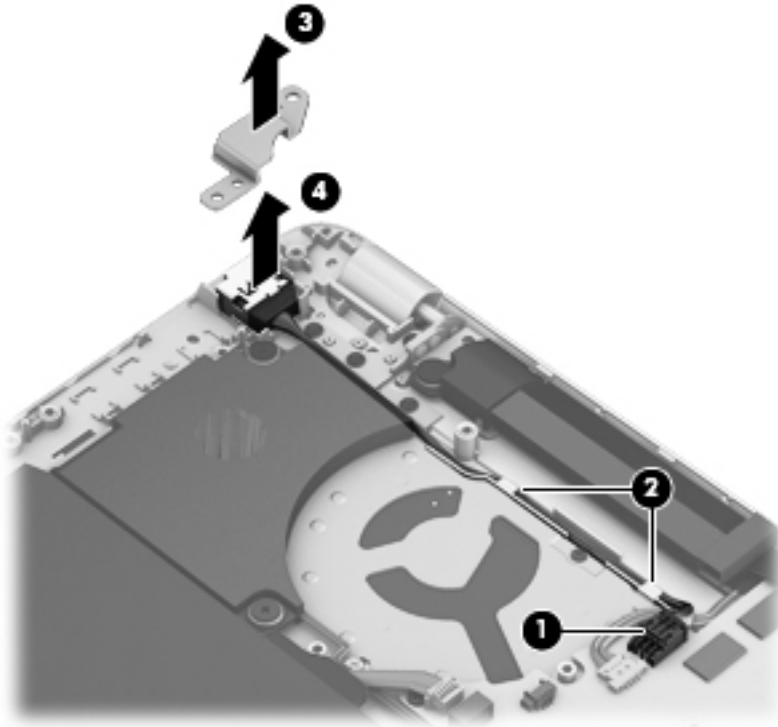

Reverse this procedure to install the power connector cable and bracket.

Speakers

Description	Spare part number
Speaker Kit (includes left and right speakers and cable)	686598-001

Before removing the speakers, follow these steps:

1. Shut down the computer. If you are unsure whether the computer is off or in Hibernation, turn the computer on, and then shut it down through the operating system.
2. Disconnect all external devices connected to the computer.
3. Disconnect the power from the computer by first unplugging the power cord from the AC outlet and then unplugging the AC adapter from the computer.
4. Remove the display panel (see [Display panel on page 32](#)).
5. Remove the base enclosure (see [Base enclosure on page 34](#)).
6. Disconnect the battery cable (see [Battery on page 36](#)).

Remove the speakers:

1. Turn the computer, with the front edge toward you.
2. Release the 2 Phillips PM 2.0×3.0 screws securing each speaker. **(1)**
3. Remove the speakers and cables **(2)**.

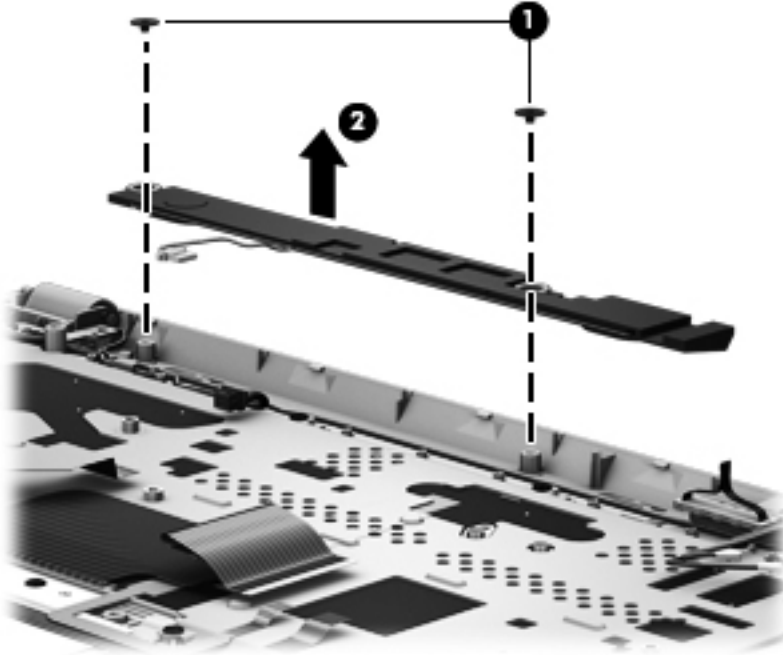

Reverse this procedure to install the speakers.

Power button board

Description	Spare part number
Power button board	688003-001

Before removing the Power button board, follow these steps:

1. Shut down the computer. If you are unsure whether the computer is off or in Hibernation, turn the computer on, and then shut it down through the operating system.
2. Disconnect all external devices connected to the computer.
3. Disconnect the power from the computer by first unplugging the power cord from the AC outlet and then unplugging the AC adapter from the computer.
4. Remove the display panel (see [Display panel on page 32](#)).
5. Remove the base enclosure (see [Base enclosure on page 34](#)).
6. Disconnect the battery cable (see [Battery on page 36](#)).

Remove the Power button board and cable:

1. Turn the top cover upside down, with the back edge toward you.
2. Remove the 2 Phillips PM 2.0x3x0 screws securing the Power button board to the top cover (1).
3. Remove the Power button board (2).

 **NOTE:** The Power button board's cable is attached to the board.

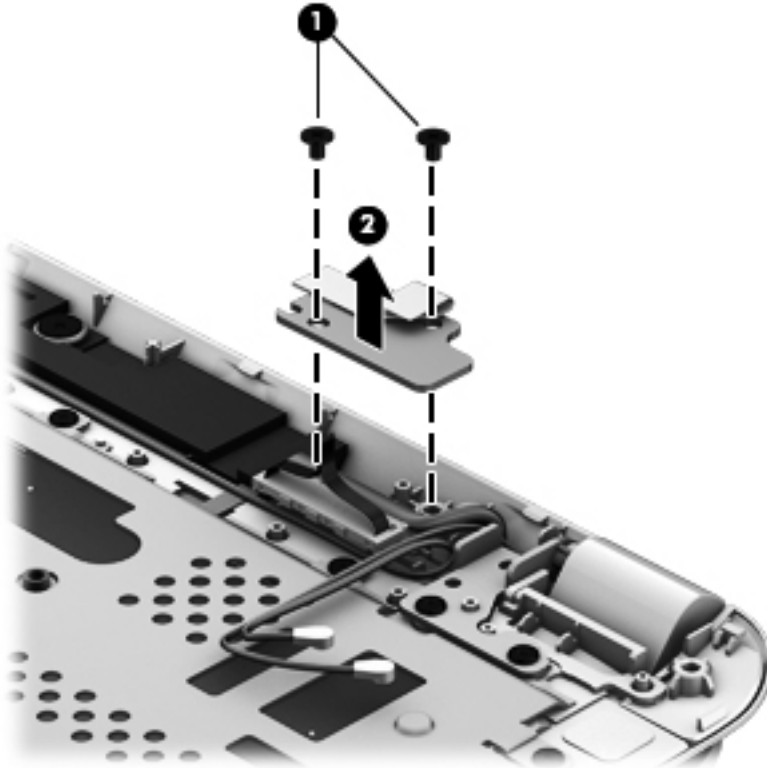

Keyboard

 **NOTE:** The keyboard spare part kit includes a keyboard cable.

For use in country or region:	Spare part number:	For use in country or region:	Spare part number:
Keyboard in black finish for use in the United States	686836-001	Keyboard in black finish for use in Saudi Arabia	686836-171
Keyboard in black finish for use in Romania	686836-271	Keyboard in black finish for use in Thailand	686836-281
Keyboard in black finish for use in Japan	686836-291	Keyboard in black finish for use in Taiwan	686836-AB1
Keyboard in black finish for use in South Korea	686836-AD1	Keyboard in black finish for use in the United Kingdom and Singapore	686836-031
Keyboard in black finish for use in France	686836-051	Keyboard in black finish for use in Italy	686836-061
Keyboard in black finish for use in the Netherlands	686836-B31	Keyboard in black finish for use in Russia	686836-251

For use in country or region:	Spare part number:	For use in country or region:	Spare part number:
Keyboard in black finish for use in Germany	686836-041	Keyboard in black finish for use in Portugal	686836-131
Keyboard in black finish for use in Turkey	686836-141	Keyboard in black finish for use in Hungary	686836-211
Keyboard in black finish for use in Israel	686836-BB1	Keyboard in black finish for use in Slovenia	686836-BA1
Keyboard in black finish for use in Canada	686836-DB1	Keyboard in black finish for use in India	686836-D61
Backlit keyboard in black finish for use in the United States	687099-001	Keyboard in black finish for use in Czechoslovakia	686836-FL1
Backlit keyboard in black finish for use in Greece	687099-151	Backlit keyboard in black finish for use in Spain	687099-071
Backlit keyboard in black finish for use in Belgium	687099-A41	Backlit keyboard in black finish for use in Saudi Arabia	687099-171
Backlit keyboard in black finish for use in Switzerland	687099-BG1	Backlit keyboard in black finish for use in the Netherlands	687099-B31
Backlit keyboard in black finish for Denmark, Norway, Finland	687099-DH1	Black/silver keyboard for use in the United States	692758-001
Black/silver keyboard for use in Germany	692758-041	Black/silver keyboard for use in the United Kingdom and Singapore	692758-031
Black/silver keyboard for use in Italy	692758-061	Black/silver keyboard for use in France	692758-051
Black/silver keyboard for use in Turkey	692758-141	Black/silver keyboard for use in Portugal	692758-131
Black/silver keyboard for use in Brazil	692758-201	Black/silver keyboard for use in Saudi Arabia	692758-171
Black/silver keyboard for use in Romania	692758-271	Black/silver keyboard for use in Russia	692758-251
Black/silver keyboard for use in Japan	692758-291	Black/silver keyboard for use in Thailand	692758-281
Black/silver keyboard for use in South Korea	692758-AD1	Black/silver keyboard for use in Taiwan	692758-AB1
Black/silver keyboard for use in Slovenia	692758-BA1	Black/silver keyboard for use in the Netherlands	692758-B31
Black/silver keyboard for use in India	692758-D61	Black/silver keyboard for use in Israel	692758-BB1
Black/silver keyboard for use in Czechoslovakia	692758-FL1	Black/silver keyboard for use in Canada	692758-DB1
Black/silver backlit keyboard for use in Spain	692759-071	Black/silver backlit keyboard for use in the United States	692759-001
Black/silver backlit keyboard for use in Belgium	692759-A41	Black/silver backlit keyboard for use in Greece	692759-151

For use in country or region:	Spare part number:	For use in country or region:	Spare part number:
Black/silver backlit keyboard for use in Switzerland	692759–BG1	Black/silver backlit keyboard for use in the Netherlands	692759–B31
Black/Silver backlit keyboard for use in Saudi Arabia	692759–171	Black/silver backlit keyboard for use in Denmark, Norway, Finland	692759–DH1

Before removing the keyboard, follow these steps:

1. Shut down the computer. If you are unsure whether the computer is off or in Hibernation, turn the computer on, and then shut it down through the operating system.
2. Disconnect all external devices connected to the computer.
3. Disconnect the power from the computer by first unplugging the power cord from the AC outlet and then unplugging the AC adapter from the computer.
4. Remove the display panel (see [Display panel on page 32](#)).
5. Remove the base enclosure (see [Base enclosure on page 34](#)).

Remove the keyboard:

1. Turn the computer right-side up with the front facing you.
2. Remove the 16 Phillips PM 2x3 screws.

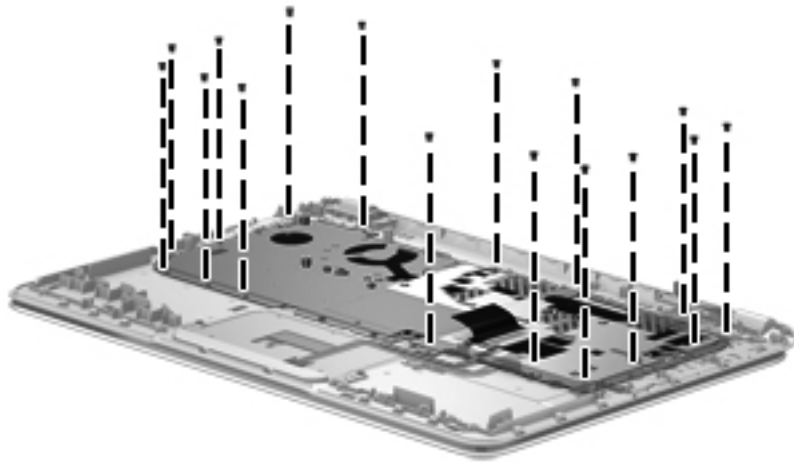

3. Remove the single screw (1), and then release the keyboard and keyboard bracket from the top cover (2).

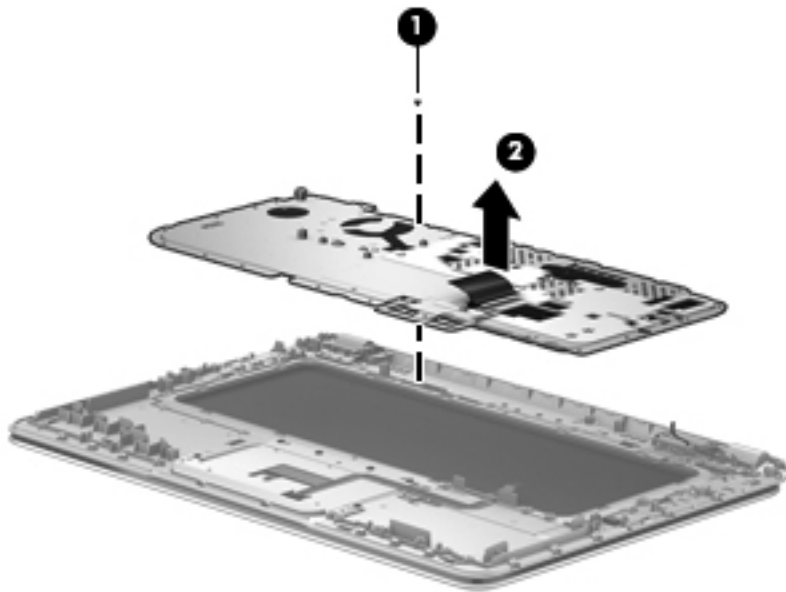

4. Remove the 1 Phillips PM 2.5x3 screw securing the keyboard to the bracket (1), disconnect the keyboard cable (2) (pushing it through the bracket), and then remove the keyboard from the bracket (3).

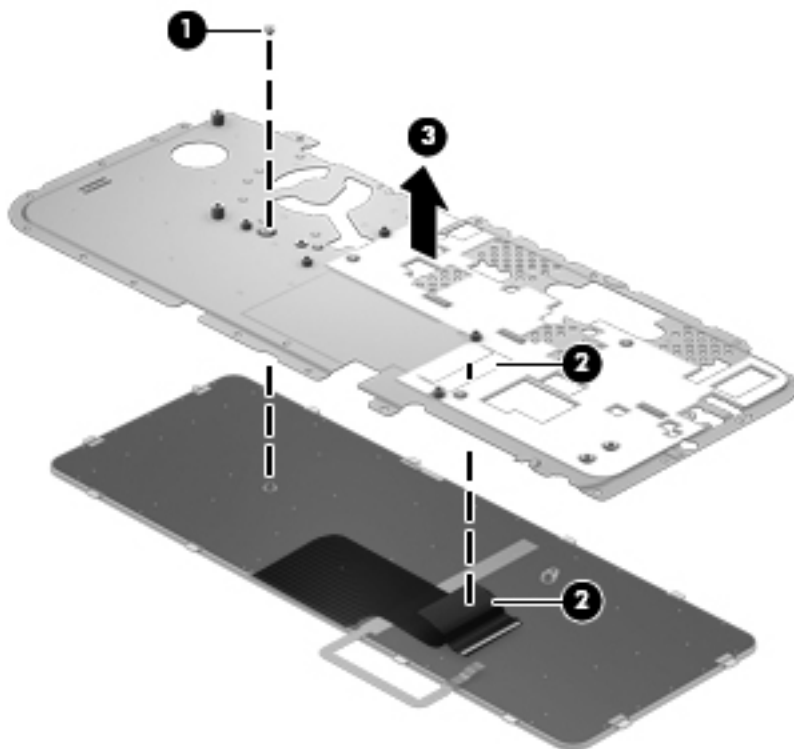

Reverse this procedure to install the keyboard.

Top cover

Description	Spare part number
Top cover	686097-001
	690198-001

Before removing the top cover, follow these steps:

1. Shut down the computer. If you are unsure whether the computer is off or in Hibernation, turn the computer on, and then shut it down through the operating system.
2. Disconnect all external devices connected to the computer.
3. Disconnect the power from the computer by first unplugging the power cord from the AC outlet and then unplugging the AC adapter from the computer.
4. Remove the display panel (see [Display panel on page 32](#)).
5. Remove the base enclosure (see [Base enclosure on page 34](#)).
6. Disconnect the battery cable (see [Battery on page 36](#)).

Remove the top cover:

1. Turn the computer right-side up, with the front toward you.
2. Open the computer.
3. Remove the 3 screws from each hinge on the top cover (1), and then remove the top cover (2).

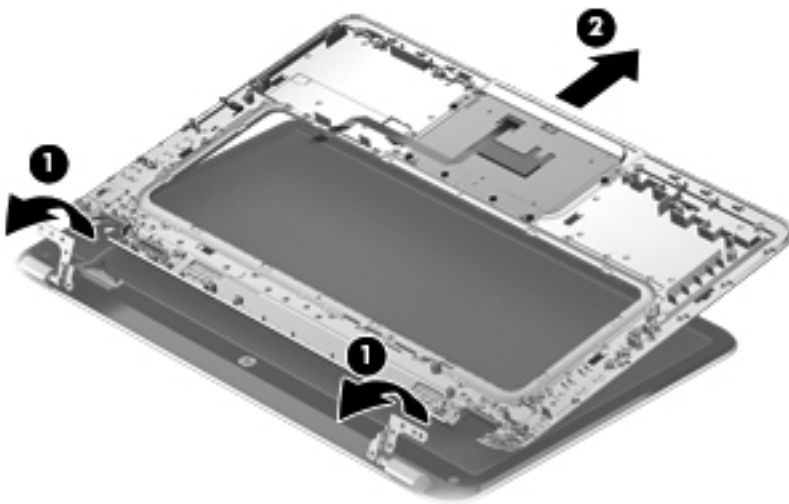

Reverse this procedure to install the top cover.

WLAN antenna cables

Description	Spare part numbers
WLAN antennas	686589-001

Before removing the antenna cables:

1. Shut down the computer. If you are unsure whether the computer is off or in Hibernation, turn the computer on, and then shut it down through the operating system.
2. Disconnect all external devices connected to the computer.
3. Disconnect the power from the computer by first unplugging the power cord from the AC outlet and then unplugging the AC adapter from the computer.
4. Remove the display panel (see [Display panel on page 32](#)).
5. Remove the base enclosure (see [Base enclosure on page 34](#)).
6. Disconnect the battery cable (see [Battery on page 36](#)).

Remove the WLAN antenna cables:

- ▲ Remove the WLAN antenna transceivers (1), and then remove the cables (2) from the right and left sides of the hinge.

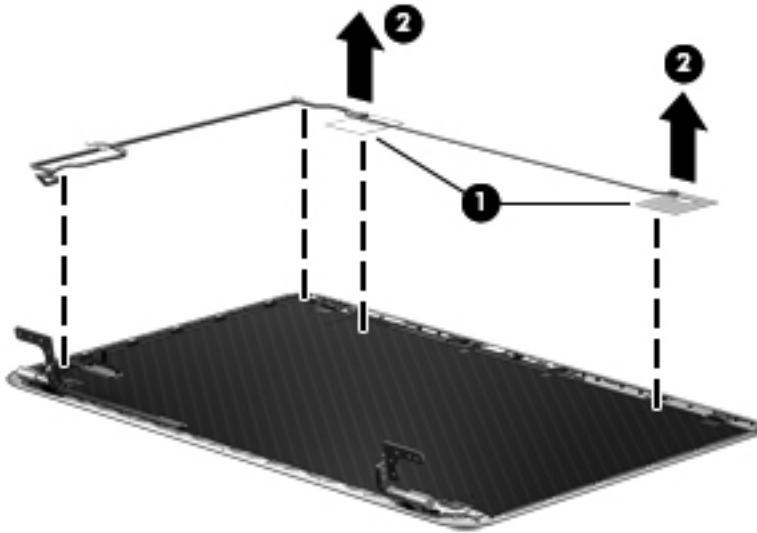

Display panel cable assembly

Description	Spare part number
Display panel cable assembly	686592-001

Before removing the display panel cable assembly:

1. Shut down the computer. If you are unsure whether the computer is off or in Hibernation, turn the computer on, and then shut it down through the operating system.
2. Disconnect all external devices connected to the computer.
3. Disconnect the power from the computer by first unplugging the power cord from the AC outlet and then unplugging the AC adapter from the computer.
4. Remove the display panel (see [Display panel on page 32](#)).

5. Remove the base enclosure (see [Base enclosure on page 34](#)).
6. Disconnect the battery cable (see [Battery on page 36](#)).

Remove the display panel cable assembly:

- ▲ Disconnect the display panel cable from the webcam, and then remove the cable on the left side up to the left hinge.

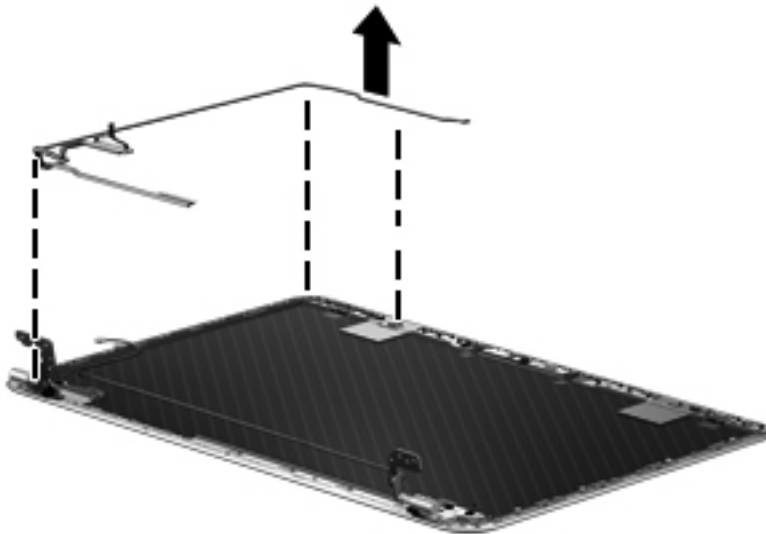

Webcam assembly

Description	Spare part numbers
Webcam assembly	686587-001

Before removing the webcam assembly:

1. Shut down the computer. If you are unsure whether the computer is off or in Hibernation, turn the computer on, and then shut it down through the operating system.
2. Disconnect all external devices connected to the computer.
3. Disconnect the power from the computer by first unplugging the power cord from the AC outlet and then unplugging the AC adapter from the computer.
4. Remove the display panel (see [Display panel on page 32](#)).
5. Remove the base enclosure (see [Base enclosure on page 34](#)).
6. Disconnect the battery cable (see [Battery on page 36](#)).

Remove the webcam assembly:

- ▲ Disconnect the webcam cable (1), and then remove the cable (2).

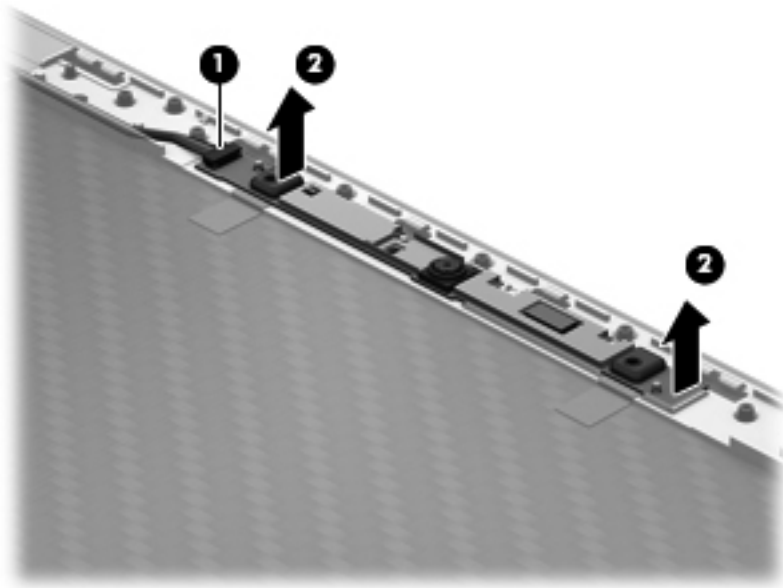

Display hinges and hinge covers

Description	Spare part number
Display hinges	686596-001
Display hinge covers	686595-001

Before removing the webcam assembly:

1. Shut down the computer. If you are unsure whether the computer is off or in Hibernation, turn the computer on, and then shut it down through the operating system.
2. Disconnect all external devices connected to the computer.
3. Disconnect the power from the computer by first unplugging the power cord from the AC outlet and then unplugging the AC adapter from the computer.
4. Remove the display panel (see [Display panel on page 32](#)).
5. Remove the base enclosure (see [Base enclosure on page 34](#)).
6. Disconnect the battery cable (see [Battery on page 36](#)).

Remove the display hinge covers:

1. Remove the Phillips PM screws that secure the display the left and right hinge covers (1), and then remove the hinge covers (2).

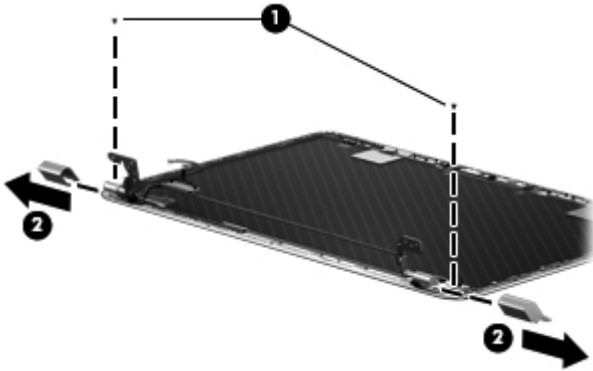

2. Remove the 4 Phillips PM screws (2 on each side) that secure the hinge to the display panel (1), and then remove the hinges (2).

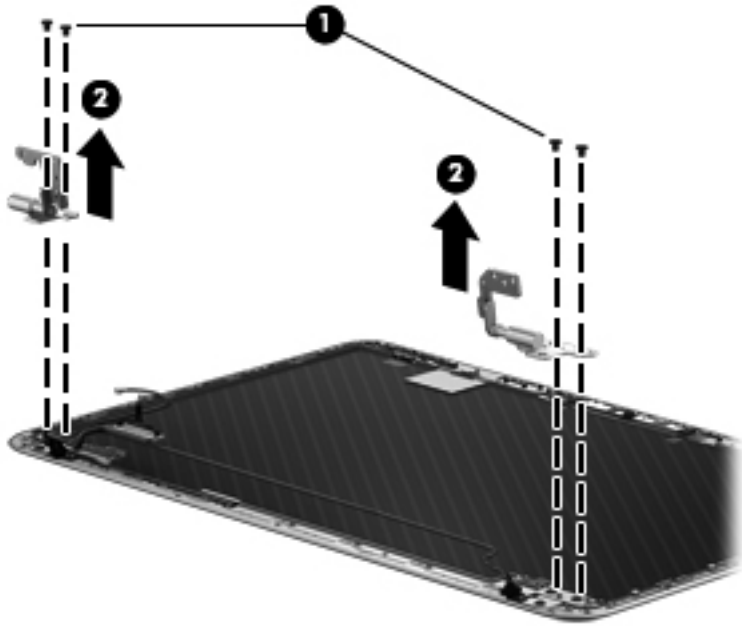

5 Setup Utility (BIOS) and System Diagnostics

Using Setup Utility

Setup Utility, or Basic Input/Output System (BIOS), controls communication between all the input and output devices on the system (such as disk drives, display, keyboard, mouse, and printer). Setup Utility includes settings for the types of peripherals installed, the startup sequence of the computer, and the amount of system and extended memory.

 **NOTE:** Use extreme care when making changes in Setup Utility. Errors can prevent the computer from operating properly.

Starting Setup Utility

 **NOTE:** An external keyboard or mouse connected to a USB port can be used with Setup Utility only if USB legacy support is enabled.

To start Setup Utility, follow these steps:

1. Turn on or restart the computer, and then press **esc** while the “Press the ESC key for Startup Menu” message is displayed at the bottom of the screen.
2. Press **f10** to enter Setup Utility.

Changing the language of Setup Utility

1. Start Setup Utility.
2. Use the arrow keys to select **System Configuration > Language**, and then press **enter**.
3. Use the arrow keys to select a language, and then press **enter**.
4. When a confirmation prompt with your language selected is displayed, press **enter**.
5. To save your change and exit Setup Utility, use the arrow keys to select **Exit > Exit Saving Changes**, and then press **enter**.

Your change takes effect immediately.

Navigating and selecting in Setup Utility

To navigate and select in Setup Utility, follow these steps:

1. Turn on or restart the computer, and then press **esc** while the “Press the ESC key for Startup Menu” message is displayed at the bottom of the screen.
 - To select a menu or a menu item, use the tab key and the keyboard arrow keys and then press **enter**, or use a pointing device to click the item.
 - To scroll up and down, click the up arrow or the down arrow in the upper-right corner of the screen, or use the up arrow key or the down arrow key.
 - To close open dialog boxes and return to the main Setup Utility screen, press **esc**, and then follow the on-screen instructions.
2. Press **f10** to enter Setup Utility.

To exit Setup Utility menus, choose one of the following methods:

- To exit Setup Utility menus without saving your changes, press the **esc** key, and then follow the on-screen instructions.

– or –

Use the arrow keys to select **Exit > Exit Discarding Changes**, and then press **enter**.

- To save your changes and exit Setup Utility menus, press **f10**, and then follow the on-screen instructions.

– or –

Use the tab key and the arrow keys to select **Exit > Exit Saving Changes**, and then press **enter**.

Your changes go into effect when the computer restarts.

Displaying system information

1. Start Setup Utility.
2. Select the **Main menu**. System information such as the system time and date, and identification information about the computer is displayed.
3. To exit Setup Utility without changing any settings, use the arrow keys to select **Exit > Exit Discarding Changes**, and then press **enter**.

Restoring factory settings in Setup Utility

 **NOTE:** Restoring defaults will not change the hard drive mode.

To return all settings in Setup Utility to the values that were set at the factory, follow these steps:

1. Turn on or restart the computer, and then press **esc** while the “Press the ESC key for Startup Menu” message is displayed at the bottom of the screen.
2. Press **f10** to enter Setup Utility.
3. Use the arrow keys to select **Exit > Load Setup Defaults**.
4. Follow the on-screen instructions.
5. To save your changes and exit, press **f10**, and then follow the on-screen instructions.

– or –

Use the arrow keys to select **Exit > Exit Saving Changes**, and then press **enter**.

Your changes go into effect when the computer restarts.

 **NOTE:** Your password settings and security settings are not changed when you restore the factory settings.

Exiting Setup Utility

- To exit Setup Utility and save your changes from the current session:
If the Setup Utility menus are not visible, press **esc** to return to the menu display. Then use the arrow keys to select **Exit > Exit Saving Changes**, and then press **enter**.
- To exit Setup Utility without saving your changes from the current session:
If the Setup Utility menus are not visible, press **esc** to return to the menu display. Then use the arrow keys to select **Exit > Exit Discarding Changes**, and then press **enter**.

Updating the BIOS

Updated versions of the BIOS may be available on the HP website.

Most BIOS updates on the HP website are packaged in compressed files called *SoftPaqs*.

Some download packages contain a file named *Readme.txt*, which contains information regarding installing and troubleshooting the file.

Determining the BIOS version

To determine whether available BIOS updates contain later BIOS versions than those currently installed on the computer, you need to know the version of the system BIOS currently installed.

BIOS version information (also known as *ROM date* and *System BIOS*) can be displayed by pressing **fn+esc** (if you are already in Windows) or by using Setup Utility.

1. Start Setup Utility (BIOS).
2. Use the arrow keys to select **Main**.
3. To exit Setup Utility (BIOS) without saving your changes, use the tab key and the arrow keys to select **Exit > Exit Discarding Changes**, and then press **enter**.

Downloading a BIOS update

 **CAUTION:** To reduce the risk of damage to the computer or an unsuccessful installation, download and install a BIOS update only when the computer is connected to reliable external power using the AC adapter. Do not download or install a BIOS update while the computer is running on battery power, docked in an optional docking device, or connected to an optional power source. During the download and installation, follow these instructions:

Do not disconnect power from the computer by unplugging the power cord from the AC outlet.

Do not shut down the computer or initiate Sleep or Hibernation.

Do not insert, remove, connect, or disconnect any device, cable, or cord.

1. **Windows 7**—Select **Start > Help and Support > Maintain**.

Windows XP—Select **Start > Help and Support**, and then select the software and drivers update.

2. Follow the on-screen instructions to identify your computer and access the BIOS update you want to download.
3. At the download area, follow these steps:
 - a. Identify the BIOS update that is later than the BIOS version currently installed on your computer. Make a note of the date, name, or other identifier. You may need this information to locate the update later, after it has been downloaded to your hard drive.
 - b. Follow the on-screen instructions to download your selection to the hard drive. Make a note of the path to the location on your hard drive where the BIOS update is downloaded. You will need to access this path when you are ready to install the update.



NOTE: If you connect your computer to a network, consult the network administrator before installing any software updates, especially system BIOS updates.

BIOS installation procedures vary. Follow any instructions that are displayed on the screen after the download is complete. If no instructions are displayed, follow these steps:

1. **Windows 7**—Open Windows Explorer by selecting **Start > Computer**.

Windows XP—Open Windows Explorer by selecting **Start > My Computer**.

2. Double-click your hard drive designation. The hard drive designation is typically Local Disk (C:).
3. Using the hard drive path you recorded earlier, open the folder on your hard drive that contains the update.

4. Double-click the file that has an .exe extension (for example, *filename.exe*). The BIOS installation begins.
5. Complete the installation by following the on-screen instructions.

 **NOTE:** After a message on the screen reports a successful installation, you can delete the downloaded file from your hard drive.

Using System Diagnostics

System Diagnostics allows you to run diagnostic tests to determine if the computer hardware is functioning properly. The following diagnostic tests are available in System Diagnostics:

- Start-up test—This test analyzes the main computer components that are required to start the computer.
- Run-in test—This test repeats the start-up test and checks for intermittent problems that the start-up test does not detect.
- Hard disk test—This test analyzes the physical condition of the hard drive, and then checks all data in every sector of the hard drive. If the test detects a damaged sector, it attempts to move the data to a good sector.
- Memory test—This test analyzes the physical condition of the memory modules. If it reports an error, replace the memory modules immediately.
- Battery test—This test analyzes the condition of the battery. If the battery fails the test, contact HP support to report the issue and purchase a replacement battery.

You can also view system information and error logs in the System Diagnostics window.

To start System Diagnostics:

1. Turn on or restart the computer. While the “Press the ESC key for Startup Menu” message is displayed in the lower-left corner of the screen, press **esc**. When the Startup Menu is displayed, press **f2**.
2. Click the diagnostic test you want to run, and then follow the on-screen instructions.

 **NOTE:** If you need to stop a diagnostics test while it is running, press **esc**.

6 Specifications

Computer specifications

	Metric	U.S.
Dimensions		
Width	29.16 cm	11.48 in
Depth	2.15 cm	8.46 in
Height (front to back)	2.11 to 3.19 cm	0.83 to 1.26 in
Weight		
With 6-cell battery	1.60 kg	3.53 lb
With 3-cell battery	1.46 kg	3.22 lb
Input power		
Operating voltage and current	19.5V dc @ 3.33 A – 65 W	
Temperature		
Operating	5°C to 35°C	41°F to 95°F
Nonoperating	-20°C to 60°C	-4°F to 140°F
Relative humidity (noncondensing)		
Operating	10% to 90%	
Nonoperating	5% to 95%	
Maximum altitude (unpressurized)		
Operating	-15 m to 3,048 m	-50 ft to 10,000 ft
Nonoperating	-15 m to 12,192 m	-50 ft to 40,000 ft
NOTE: Applicable product safety standards specify thermal limits for plastic surfaces. The device operates well within this range of temperatures.		

15.6-inch display specifications

	Metric	U.S.
Dimensions		
Height	16.50 cm	6.50 in
Width	25.34 cm	11.60 in
Diagonal	33.66 cm	13.30 in
Number of colors	262,144	

	Metric	U.S.
Contrast ratio	200:1 (typical)	
Brightness	200 nits (typical)	
Pixel resolution		
Pitch	0.197 mm × 0.197 mm	
Format	1366 × 768	
Configuration	RGB vertical stripe	
Backlight	LED	
Character display	80 × 25	
Total power consumption	2.0 W	
Viewing angle	±65° horizontal, ±50° vertical (typical)	

7 Backup and recovery

Your computer includes tools provided by the operating system and HP to help you safeguard your information and restore it if ever needed.

This chapter provides information on the following topics:

- Creating a set of recovery discs or a recovery flash drive (HP Recovery Manager software feature)
- Performing a system restore (from the partition, recovery discs, or a recovery flash drive)
- Backing up your information
- Recovering a program or driver

Restoring the system

If the computer hard drive fails, you must use a set of recovery discs or a recovery flash drive to restore your system to its factory image. Ideally, you have already used HP Recovery Manager to create these tools immediately after software setup.

 **NOTE:** All references to the hard disk drive in this guide refer to the solid-state (SSD) drive

For issues other than hard drive failure, you can restore your system by using the HP Recovery partition, rather than by using recovery discs or a recovery flash drive. To check for the presence of a recovery partition, click **Start**, right-click **Computer**, click **Manage**, and then click **Disk Management**. If the recovery partition is present, a Recovery drive is listed in the window.

 **CAUTION:** HP Recovery Manager (partition or discs/flash drive) restores only software that was preinstalled at the factory. Software not provided with this computer must be reinstalled manually.

Creating restore media

HP recommends that you create either a set of recovery discs or a recovery flash drive so that you can restore your computer to its original factory state if the hard drive fails, or if for any reason you cannot restore using the recovery partition tools. Create these discs or the flash drive after setting up the computer for the first time.

 **NOTE:** HP Recovery Manager allows the creation of only one set of recovery discs or one recovery flash drive. Handle these recovery tools carefully, and keep them in a safe place.

 **NOTE:** You can use an optional external optical drive (purchased separately) to create recovery discs, or you can purchase recovery discs for your computer from the HP website. If you use an external optical drive, it must be connected directly to a USB port on the computer, not to a USB port on an external device, such as a USB hub.

Guidelines:

- Purchase high-quality DVD-R, DVD+R, DVD-R DL, or DVD+R DL discs.

 **NOTE:** Read-write discs, such as CD-RW, DVD±RW, double-layer DVD±RW, and BD-RE (rewritable Blu-ray) discs, are not compatible with the HP Recovery Manager software.

- The computer must be connected to AC power during this process.

- Only one set of recovery discs or one recovery flash drive can be created per computer.

 **NOTE:** If you are creating recovery discs, number each disc before inserting it into an optional external optical drive (purchased separately).

- If necessary, you can exit the program before you have finished creating the recovery discs or recovery flash drive. The next time you open HP Recovery Manager, you will be prompted to continue the backup creation process.

To create a set of recovery discs or a recovery flash drive:

1. Select **Start > All Programs > Security and Protection > HP Recovery Manager > HP Recovery Media Creation**.
2. Follow the on-screen instructions.

Performing a system recovery

HP Recovery Manager software allows you to repair or restore the computer to its original factory state. HP Recovery Manager works from recovery discs, a recovery flash drive, or from a dedicated recovery partition on the hard drive.

 **NOTE:** A system restore must be performed if the computer hard drive fails or if all attempts to correct any functional computer issues fail. A system restore should be used as a final attempt to correct computer issues.

Note the following when performing a system restore:

- You can restore only the system that you have previously backed up. HP recommends that you use HP Recovery Manager to create either a set of recovery discs or a recovery flash drive as soon as you set up the computer.
- Windows has its own built-in repair features, such as System Restore. If you have not already tried these features, try them before using HP Recovery Manager to restore your system.
- HP Recovery Manager restores only software that was installed at the factory. For software not provided with this computer, you must either download the software from the manufacturer's website or reinstall the software from the disc provided by the manufacturer using an optional external optical drive (purchased separately).

Using the dedicated recovery partition

When using the dedicated recovery partition, there is an option to back up pictures, music and other audio, videos and movies, recorded TV shows, documents, spreadsheets and presentations, e-mails, Internet favorites and settings during this process.

To restore the computer from the recovery partition, follow these steps:

1. Access HP Recovery Manager in either of the following ways:
 - Select **Start > All Programs > Security and Protection > HP Recovery Manager > HP Recovery Manager**.
 - or –
 - Turn on or restart the computer, and then press **esc** while the “Press the ESC key for Startup Menu” message is displayed at the bottom of the screen. Then, press **f11** while the “F11 (System Recovery)” message is displayed on the screen.
2. Click **System Recovery** in the **HP Recovery Manager** window.
3. Follow the on-screen instructions.

Restoring using the restore media

1. If possible, back up all personal files.
2. Insert the first recovery disc into an optional external optical drive (purchased separately), and then restart the computer.

– or –

Insert the recovery flash drive into a USB port on your computer, and then restart the computer.

 **NOTE:** If the computer does not automatically restart in the HP Recovery Manager, the computer boot order needs to be changed.

3. Press **f9** at system bootup.
4. Select the external optical drive or the flash drive.
5. Follow the on-screen instructions.

Changing the computer boot order

To change the boot order for recovery discs:

1. Restart the computer.
2. Press **esc** while the computer is restarting, and then press **f9** for boot options.
3. Select **Internal CD/DVD ROM Drive** from the boot options window.

To change the boot order for recovery flash drive:

1. Insert the flash drive into a USB port.
2. Restart the computer.
3. Press **esc** while the computer is restarting, and then press **f9** for boot options.
4. Select the flash drive from the boot options window.

Backing up and recovering your information

It is very important to back up your files and keep any new software in a safe place. As you add new software and data files, continue to create backups on a regular basis.

How completely you are able to recover your system depends on how recent your backup is.

 **NOTE:** A recovery from your most recent backup needs to be performed if the computer has a virus attack or if any major system components fail. In order to correct computer issues, a recovery should first be attempted before a system restore is attempted.

You can back up your information to an optional external hard drive, a network drive, or discs. Back up your system at the following times:

- At regularly scheduled times

 **TIP:** Set reminders to back up your information periodically.

- Before the computer is repaired or restored
- Before you add or modify hardware or software

Guidelines:

- Create system restore points using the Windows® System Restore feature, and periodically copy them to an optical disc using an optional external optical drive (purchased separately) or an external hard drive. For more information on using system restore points, refer to [Using Windows system restore points on page 83](#).
- Store personal files in the Documents library and back up this folder periodically.
- Save customized settings in a window, toolbar, or menu bar by taking a screen shot of your settings. The screen shot can be a time-saver if you have to re-enter your preferences.

To create a screen shot:

1. Display the screen you want to save.

2. Copy the screen image:

To copy only the active window, press **alt+prt sc**.

To copy the entire screen, press **prt sc**.

3. Open a word-processing document, and then select **Edit > Paste**. The screen image is added to the document.
4. Save and print the document.

Using Windows Backup and Restore

Guidelines:

- Be sure that the computer is connected to AC power before you start the backup process.
- Allow enough time to complete the backup process. Depending on file sizes, it may take over an hour.

To create a backup:

1. Select **Start > Control Panel > System and Security > Backup and Restore**.

2. Follow the on-screen instructions to schedule and create a backup.



NOTE: Windows® includes the User Account Control feature to improve the security of the computer. You may be prompted for your permission or password for tasks such as installing software, running utilities, or changing Windows settings. Refer to Help and Support for more information.

Using Windows system restore points

A system restore point allows you to save and name a snapshot of your hard drive at a specific point in time. You can then recover back to that point if you want to reverse subsequent changes.



NOTE: Recovering to an earlier restore point does not affect data files saved or e-mails created since the last restore point.

You also can create additional restore points to provide increased protection for your files and settings.

When to create restore points

- Before you add or modify software or hardware
- Periodically, whenever the computer is functioning optimally



NOTE: If you revert to a restore point and then change your mind, you can reverse the restoration.

Create a system restore point

1. Select **Start > Control Panel > System and Security > System**.
2. In the left pane, click **System Protection**.
3. Click the **System Protection** tab.
4. Click **Create**, and then follow the on-screen instructions.

Restore to a previous date and time

To revert to a restore point (created at a previous date and time), when the computer was functioning optimally, follow these steps:

1. Select **Start > Control Panel > System and Security > System**.
2. In the left pane, click **System Protection**.
3. Click the **System Protection** tab.
4. Click **System Restore**.
5. Follow the on-screen instructions.

8 Power cord set requirements

The wide-range input feature of the computer permits it to operate from any line voltage from 100 to 120 volts AC, or from 220 to 240 volts AC.

The 3-conductor power cord set included with the computer meets the requirements for use in the country or region where the equipment is purchased.

Power cord sets for use in other countries and regions must meet the requirements of the country or region where the computer is used.

Requirements for all countries

The following requirements are applicable to all countries and regions:

- The length of the power cord set must be at least **1.5 m** (5.0 ft) and no more than **2.0 m** (6.5 ft).
- All power cord sets must be approved by an acceptable accredited agency responsible for evaluation in the country or region where the power cord set will be used.
- The power cord sets must have a minimum current capacity of 10 A and a nominal voltage rating of 125 or 250 V ac, as required by the power system of each country or region.
- The appliance coupler must meet the mechanical configuration of an EN 60 320/IEC 320 Standard Sheet C13 connector for mating with the appliance inlet on the back of the computer.

Requirements for specific countries and regions

Country/region	Accredited agency	Applicable note number
Argentina	IRAM	1
Australia	SAA	1
Austria	OVE	1
Belgium	CEBEC	1
Brazil	ABNT	1
Canada	CSA	2
Chile	IMQ	1
Denmark	DEMKO	1
Finland	FIMKO	1
France	UTE	1
Germany	VDE	1
India	ISI	1
Israel	SII	1
Italy	IMQ	1

Country/region	Accredited agency	Applicable note number
Japan	JIS	3
The Netherlands	KEMA	1
New Zealand	SANZ	1
Norway	NEMKO	1
The People's Republic of China	CCC	4
Saudi Arabia	SASO	7
Singapore	PSB	1
South Africa	SABS	1
South Korea	KTL	5
Sweden	SEMKO	1
Switzerland	SEV	1
Taiwan	BSMI	6
Thailand	TISI	1
The United Kingdom	ASTA	1
The United States	UL	2

1. The flexible cord must be Type HO5VV-F, 3-conductor, 0.75-mm² conductor size. Power cord set fittings (appliance coupler and wall plug) must bear the certification mark of the agency responsible for evaluation in the country or region where it will be used.
2. The flexible cord must be Type SVT/SJT or equivalent, No. 18 AWG, 3-conductor. The wall plug must be a two-pole grounding type with a NEMA 5-15P (15 A, 125 V) or NEMA 6-15P (15 A, 250 V ac) configuration. CSA or C-UL mark. UL file number must be on each element.
3. The appliance coupler, flexible cord, and wall plug must bear a "T" mark and registration number in accordance with the Japanese Dentori Law. The flexible cord must be Type VCTF, 3-conductor, 0.75-mm² or 1.25-mm² conductor size. The wall plug must be a two-pole grounding type with a Japanese Industrial Standard C8303 (7 A, 125 V ac) configuration.
4. The flexible cord must be Type RVV, 3-conductor, 0.75-mm² conductor size. Power cord set fittings (appliance coupler and wall plug) must bear the CCC certification mark.
5. The flexible cord must be Type H05VV-F 3X0.75-mm² conductor size. KTL logo and individual approval number must be on each element. Corset approval number and logo must be printed on a flag label.
6. The flexible cord must be Type HVCTF 3x1.25-mm² conductor size. Power cord set fittings (appliance coupler, cable, and wall plug) must bear the BSMI certification mark.
7. For 127 V ac, the flexible cord must be Type SVT or SJT 3 x 18 AWG, with plug NEMA 5-15P (15 A, 125 V ac), with UL and CSA or C-UL marks. For 240 V ac, the flexible cord must be Type H05VV-F 3x0.75-/1.00-mm² conductor size, with plug BS 1363/A with BSI or ASTA marks.

9 Recycling

When a non-rechargeable or rechargeable battery has reached the end of its useful life, do not dispose of the battery in general household waste. Follow the local laws and regulations in your area for battery disposal.

HP encourages customers to recycle used electronic hardware, HP original print cartridges, and rechargeable batteries. For more information about recycling programs, see the HP website at <http://www.hp.com/recycle>.

Index

A

- AC adapter 10
- AC adapter, spare part numbers 19, 20
- action keys
 - identifying 6
- audio, product description 2
- audio-in (microphone) jack 10
- audio-out (headphone) jacks 10

B

- backing up
 - customized window, toolbar, and menu bar settings 82
 - personal files 82
- base enclosure
 - removal 34
 - spare part numbers 34
- base enclosure, spare part number 20, 22
- battery
 - removal 36
 - spare part numbers 17, 20, 36
- Blu-ray ROM DVD±R/RW Super Multi Double-Layer Drive
 - precautions 27
 - spare part number 18, 20
- buttons
 - power 5
 - TouchPad on/off 8

C

- cables, service considerations 26
- caps lock light, identifying 7
- chipset, product description 1
- components
 - bottom 11
 - display 4
 - left side 8
 - right side 10
- computer major components 13
- computer part number 31
- computer specifications 76
- connector, power 10

- connectors, service considerations 26

D

- Digital Media Slot, identifying 9
- display
 - specifications 76
- display assembly
 - spare part numbers 32
- display panel
 - removal 32
- display panel, product description 1
- drives, preventing damage 27
- DVD±RW and CD-RW Super Multi Double-Layer Combo Drive
 - precautions 27
 - spare part number 18, 20

E

- electrostatic discharge 27
- equipment guidelines 30
- esc key, identifying 6
- Ethernet, product description 2
- external media cards, product description 2

F

- f11 80
- fan
 - removal 53
 - spare part number 20, 53
- fn key, identifying 6

G

- graphics, product description 1
- grounding guidelines 27
- guidelines
 - equipment 30
 - grounding 27
 - packaging 29
 - transporting 29
 - workstation 29

H

- hard drive
 - precautions 27
 - product description 2
 - removal 38
 - spare part numbers 18, 38
- hard drive light 9
- hard drive, spare part numbers 17, 18, 20
- HDMI port, identifying 8
- HP Recovery Manager 79

I

- integrated webcam light, identifying 4
- internal display switch, identifying 4
- internal microphones, identifying 4

J

- jacks
 - audio-in (microphone) 10
 - audio-out (headphone) 10
 - network 8
 - RJ-45 (network) 8

K

- keyboard
 - product description 3
 - removal 62
 - spare part numbers 14, 21, 62
- keys
 - action 6
 - esc 6
 - fn 6
 - Windows applications 6
 - Windows logo 6

L

- lights
 - AC adapter 10
 - caps lock 7
 - hard drive 9
 - mute 7

- power 7, 9
 - TouchPad 8
 - webcam 4
 - wireless 7
- M**
- mass storage device
 - precautions 27
 - removal 38
 - spare part numbers 18, 38
 - media card reader assembly
 - removal 55
 - spare part numbers 55
 - memory module
 - product description 1
 - removal 46
 - spare part numbers 17, 20, 46
 - microphone
 - product description 2
 - model description 31
 - model name 1
 - mute light, identifying 7
- N**
- network jack, identifying 8
- O**
- operating system, product
 - description 3
 - optical drive
 - precautions 27
 - product description 2
 - spare part numbers 18, 20
- P**
- packaging guidelines 29
 - plastic parts, service
 - considerations 26
 - pointing device, product
 - description 3
 - ports
 - HDMI 8
 - product description 3
 - USB 10
 - USB 3.0 9
 - power button, identifying 5
 - power connector cable 21
 - removal 59
 - spare part number 16, 21
 - power connector, identifying 10
- power cord
 - set requirements 84
 - spare part numbers 19, 20
- power lights, identifying 7, 9
- power requirements, product
 - description 3
- processor, product description 1
- product description
 - audio 2
 - chipset 1
 - display panel 1
 - Ethernet 2
 - external media cards 2
 - graphics 1
 - hard drives 2
 - keyboard 3
 - memory module 1
 - microphone 2
 - operating system 3
 - optical drive 2
 - pointing device 3
 - ports 3
 - power requirements 3
 - processors 1
 - product name 1
 - serviceability 3
 - video 2
 - wireless 2
- product name 1, 31
- product number 31
- R**
- recovering from the dedicated
 - recovery partition 79
 - recovering from the recovery
 - discs 81
 - recovery discs 78
 - recovery, system 79
 - removal/replacement
 - preliminaries 26
 - procedures 30
 - restore points 83
 - RJ-45 (network) jack, identifying
 - 8
 - RTC battery
 - removal 41
 - spare part numbers 16, 21, 41
- S**
- Screw Kit, spare part number 19, 22
 - security cable slot, identifying 10
 - serial number 31
 - service considerations
 - cables 26
 - connectors 26
 - plastic parts 26
 - service tag 12, 31
 - serviceability, product
 - description 3
 - slots
 - Digital Media 9
 - security cable 10
 - solid-state drive, spare part
 - number 18, 22
 - Speaker Kit, spare part number
 - 21, 60
 - speakers
 - removal 60
 - spare part number 21, 60
 - speakers, identifying 5
 - specifications
 - computer 76
 - display 76
 - supported discs 78
 - system board
 - removal 48
 - spare part numbers 16, 17, 22, 23, 24, 25, 48
 - system recovery 79
 - system restore points 83
- T**
- tools required 26
 - top cover
 - removal 66
 - spare part numbers 20, 22, 66
 - TouchPad button board
 - removal 43
 - spare part number 15, 43
 - TouchPad light 8
 - TouchPad on/off button 8
 - Touchpad zone, identifying 8
 - transporting guidelines 29
- U**
- USB 3.0 ports identifying 9
 - USB ports, identifying 10

USB/Audio board 17
 spare part number 21
using system restore 83

V

vents, identifying 11
video, product description 2

W

warranty period 31
webcam light, identifying 4
webcam, identifying 4
Windows applications key,
 identifying 6
Windows logo key, identifying 6
wireless light 7
wireless, product description 2
WLAN antennas, identifying 4
WLAN module
 removal 45
 spare part numbers 2, 20, 22,
 45
workstation guidelines 29



Free Manuals Download Website

<http://myh66.com>

<http://usermanuals.us>

<http://www.somanuals.com>

<http://www.4manuals.cc>

<http://www.manual-lib.com>

<http://www.404manual.com>

<http://www.luxmanual.com>

<http://aubethermostatmanual.com>

Golf course search by state

<http://golfingnear.com>

Email search by domain

<http://emailbydomain.com>

Auto manuals search

<http://auto.somanuals.com>

TV manuals search

<http://tv.somanuals.com>