

• **HP**  
**DESIGNS**  
**AND**  
**MARKETS**  
**THE**  
**WORLD**  
**WIDE**

# 721A

## POWER SUPPLY

SERIALS PREFIXED: 024-

### OPERATING AND SERVICING MANUAL



PRINTED 1/61

00010-2

# OPERATING AND SERVICING MANUAL



## MODEL 721A POWER SUPPLY SERIALS PREFIXED: 024 -

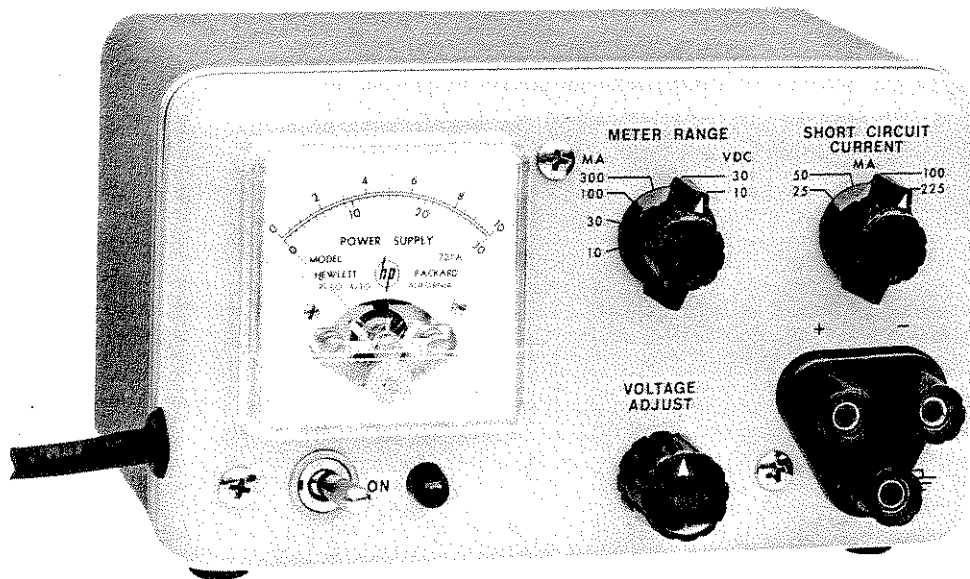

Copyright HEWLETT-PACKARD COMPANY 1959  
1501 PAGE MILL ROAD, PALO ALTO, CALIFORNIA, U. S. A.

printed 1/61  
00010-2

## SPECIFICATIONS

REGULATED OUTPUT VOLTAGE:	0 to 30 volts dc, continuously variable
FULL LOAD OUTPUT CURRENT:	150 ma over entire voltage range.
LOAD REGULATION:	With the meter monitoring voltage, the change in output voltage from no load to full load is less than 0.3% or 30 mv whichever is the greater.
LINE REGULATION:	The change in output voltage for a change from nominal line voltage of $\pm 10\%$ is less than $\pm 0.3\%$ or $\pm 15$ mv whichever is greater.
RIPPLE AND NOISE:	Less than 150 $\mu$ v rms.
OUTPUT IMPEDANCE:	Less than 0.2 ohm in series with less than 30 $\mu$ h with meter monitoring voltage.
METER RANGES:	Full scale indications of: 10 ma, 30 ma, 100 ma, 300 ma, 10 v and 30 v.
OVERLOAD PROTECTION:	Maximum current selected by switch in four steps, 25 ma, 50 ma, 100 ma, 225 ma.
OUTPUT TERMINALS:	Three banana jacks spaced 3/4" apart. Positive and negative terminals are isolated from chassis. A maximum of 400 volts may be connected between ground and either output terminal.
POWER:	115/230 volts $\pm 10\%$ , 50 to 60 cps, 16 watts.
WEIGHT:	Net 4 lbs., shipping 7 lbs.
DIMENSIONS:	7" wide, 4-3/8" high, 5-1/4" deep.

## CONTENTS

SECTION I	GENERAL INFORMATION	Page
	1 - 1 Manual Content . . . . .	I - 1
	1 - 2 General Description . . . . .	I - 1
	1 - 3 Inspection . . . . .	I - 1
	1 - 4 Power Cable . . . . .	I - 1
	1 - 5 230 Volt Operation . . . . .	I - 2
SECTION II	OPERATING INSTRUCTIONS	
	2 - 1 Operating Controls . . . . .	II - 1
	2 - 2 Meter Range Switch . . . . .	II - 1
	2 - 3 Short Circuit Current Switch . . . . .	II - 1
	2 - 4 Series Operation of Supplies . . . . .	II - 1
	2 - 5 Parallel Operation of Supplies . . . . .	II - 3
SECTION III	THEORY OF OPERATION	
	3 - 1 General Circuit Description . . . . .	III - 1
	3 - 2 Main and Auxiliary Supply Description . . . . .	III - 1
	3 - 3 Reference Voltage . . . . .	III - 1
	3 - 4 Regulation Cycle Description . . . . .	III - 1
	3 - 5 Short Circuit Current Limiting Circuit . . . . .	III - 1
	3 - 6 Output Surge Protection Circuit . . . . .	III - 2
	3 - 7 Frequency Response Control . . . . .	III - 2
SECTION IV	MAINTENANCE	
	4 - 1 Contents . . . . .	IV - 1
	4 - 2 General Maintenance Information . . . . .	IV - 1
	4 - 3 Trouble Localization . . . . .	IV - 1
	4 - 4 Checking Voltage Regulation and Ripple . . . . .	IV - 3
	4 - 5 Measuring AC Internal Impedance . . . . .	IV - 3
	4 - 6 Meter Calibration . . . . .	IV - 3
	4 - 7 Setting Maximum Output Voltage . . . . .	IV - 5
	4 - 8 Calibrating the Short Circuit Current Circuit . . . . .	IV - 5
	4 - 9 Replacing the Power Transistor . . . . .	IV - 5
	4 - 10 Replacing Diodes CR5, CR6 and CR7 . . . . .	IV - 5
SECTION V	TABLE OF REPLACEABLE PARTS	
	5 - 1 Table of Replaceable Parts . . . . .	V - 1

# SECTION I

## GENERAL INFORMATION

### 1-1 MANUAL CONTENT

The material for this instruction manual is written in five sections:

Section I contains material of a general nature.

Section II explains how to operate the power supply.

Section III explains how the circuit operates.

Section IV covers maintenance and trouble shooting procedures.

Section V is a table of replaceable parts.

### 1-2 GENERAL DESCRIPTION

The  $\Phi$  Model 721A Power Supply produces a dc regulated voltage adjustable from 0 to 30 volts. The supply makes load circuit performance independent of external power supply influences. The supply has very low source impedance and excellent regulation against change in line and/or load.

This supply is especially useful as a source of power for transistor circuits. A circuit is provided which electronically limits the maximum output current that can be supplied to four nominal values selected by a front panel switch. This feature helps prevent the accidental destruction of an expensive transistor should an accident occur that would normally allow excessive current to flow through it. The SHORT CIRCUIT CURRENT switch can be set to the value which is closest above the normal operating current. The supply will automatically limit the peak current flow to this nominal value regardless of the load resistance.

#### Built-In Metering

A built-in meter allows either output voltage or current to be monitored as selected by the METER RANGE switch.

#### Isolated Output

The power supply has both output terminals insulated from chassis ground. Either terminal may be grounded or a number of supplies may be connected in series to obtain higher voltages. Insulation is such that the supply may be operated as high as 400 volts off of ground.

#### Parallel Operation

Parallel operation of two or more supplies is possible due to the unique electronic current limiting switch. The supplies will each contribute only the number of milliamperes selected by the SHORT CIRCUIT CURRENT switch. The individual supplies may be loaded to approximately 225 ma with some reduction in ripple and regulation characteristics.

#### Reliability

The Model 721A Power Supply is very compact, and has low internal losses, which are made possible by fully transistorized circuitry. The trouble free characteristics of transistors together with the use of high quality components throughout, will result in a minimum of maintenance.

### 1-3 INSPECTION

When the Model 721A is received, inspect it for damage received in transit. Operate the instrument to make certain that it is functioning satisfactorily. If damage is evident, follow the procedures outlined in the "CLAIM FOR DAMAGE IN SHIPMENT" page of this manual.

### 1-4 POWER CABLE

The power cable consists of three conductors and is terminated in a three-prong male connector recommended by the National Electrical Manufac-

turers' Association. The third contact is an offset round pin added to a standard two-blade connector which grounds the instrument chassis when used with an appropriate receptacle. To use this NEMA connector in a two-contact receptacle, a three-prong to two-prong adapter should be used. When the adapter is used, the third contact is terminated in a short lead from the adapter which can be connected to the outlet mounting box in order to ground the instrument cabinet.

### **1-5 230 VOLT OPERATION**

This instrument may be easily converted from 115 to 230 volt operation by removing two jumpers and installing one jumper. This changes the dual 115 volt primary windings from a parallel to a series connection. Refer to the schematic diagram and Figure 4-6 for details. The main fuse (F1) should be changed (see Table of Replaceable Parts for the correct type of fuse).

# SECTION II

## OPERATING INSTRUCTIONS

### 2-1 OPERATING CONTROLS

Figure 2-1 shows the function of each of the controls and is normally self explanatory. There are a few additional facts to be considered which may be important in some applications.

### 2-2 METER RANGE SWITCH

This switch connects precision internal resistors into the meter circuit to obtain the various voltage and current ranges. When measuring current, the meter shunt resistor is in series with the output terminals. The meter shunt resistance adds to the source impedance of the supply which is normally less than 0.2 ohm in series with less than 30  $\mu$ h. The Table 2-1 lists the additional resistance for each current range. Where minimum source impedance is important, the METER RANGE switch should be left on one of the voltage ranges except when actually measuring load current. An accidental short circuit can damage the meter if it is on one of the lower ranges and the SHORT CIRCUIT CURRENT switch is set to a high value. Short time overloads of two times full scale will not damage the meter movement.

TABLE 2-1. ADDITIONAL INTERNAL RESISTANCE

Monitor Meter Current Range (f.s.)	Added Internal Resistance
10 ma	10 ohms
30 ma	3.33 ohms
100 ma	1 ohm
300 ma	0.33 ohm

### 2-3 SHORT CIRCUIT CURRENT SWITCH

This switch controls a circuit which adjusts the peak current output capability of the supply. The calibration is nominal. The actual value may be read by shorting the supply and reading the value on the monitor meter.

The clipping action is gradual. Consideration should be given to this characteristic if pulse type circuits are being supplied. The average current may be within the supply rating (150 ma) but peak currents may be high enough to cause the supply to clip. If the switch is set to a low peak value this situation can occur at low average current levels. When pulse circuits are being supplied, this switch must be set to a value which is greater than the peak current requirements of the circuit.

The output circuit has 24  $\mu$ f capacity shunting it, which helps supply high current peaks, providing they are of extremely short duration. The value of any external capacity added will improve the peak current capability but will decrease the safety provided by the SHORT CIRCUIT CURRENT switch, since the external capacity will provide high surge currents. The surge currents may destroy external components before the average current increases sufficiently inside the supply to cause the limiting circuits to operate.

### 2-4 SERIES OPERATION OF SUPPLIES

When operating the Model 721A at a voltage more than a few volts off of ground be careful not to accidentally short circuit the external circuits so the Model 721A is subjected to voltages of reverse polarity or high voltages of the same polarity. To do so will instantly destroy the electrolytic capacitors in the power supply and possibly the transistors. When a number of supplies are operated in series, be sure the SHORT CIRCUIT CURRENT switch on each supply is set to the same (or higher) value than maximum peak current desired.

METER READS OUTPUT VOLTS OR CURRENT AS SELECTED BY METER RANGE SWITCH

SELECT METER FUNCTION AND RANGE

SELECT MAXIMUM CURRENT OUTPUT

Note: Meter shunt resistance is in series with load on ma. Leave on volts for lowest (rated) internal impedance.

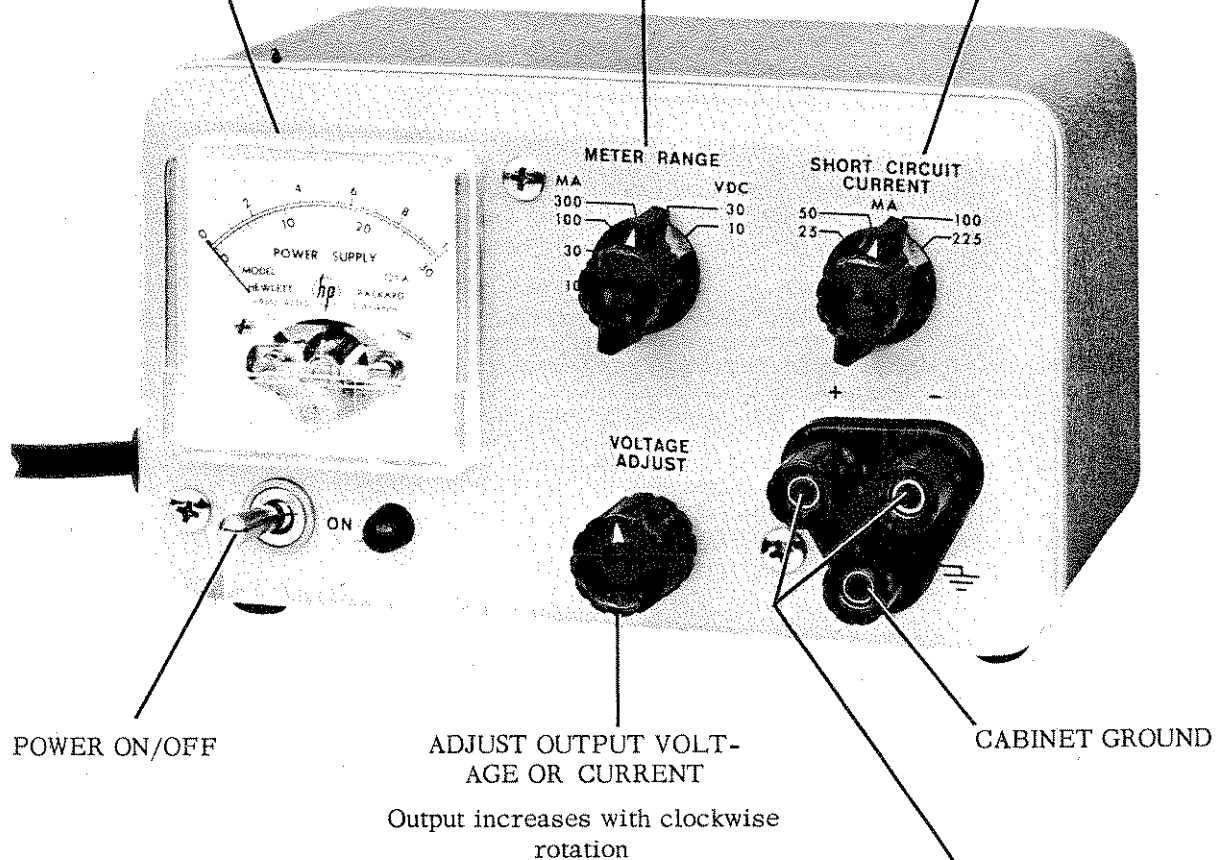

POWER ON/OFF

ADJUST OUTPUT VOLTAGE OR CURRENT

Output increases with clockwise rotation

CABINET GROUND

**CAUTION**

DO NOT SUBJECT POWER SUPPLY OUTPUT TERMINALS TO A VOLTAGE SOURCE OF REVERSE POLARITY. TO DO SO WILL DESTROY A TANTALUM CAPACITOR CONNECTED ACROSS THESE TERMINALS

CONNECT LOAD TO (+) AND (-) TERMINALS

Either terminal may be connected to grounded cabinet terminal. (+) and (-) terminals may be operated up to  $\pm 400$  volts dc from cabinet ground

MP-S-445

**Figure 2-1. Model 721A Power Supply Operating Controls**



### 2-5 PARALLEL OPERATION OF SUPPLIES

Two supplies may be operated in parallel to supply loads in excess of 150 ma. Set the SHORT CIRCUIT CURRENT switch of the first unit to maximum (225 ma). The first supply becomes a 225 ma constant current source. The supply will furnish up to this amount of current without harm, however the regulation and ripple specifications can no longer be guaranteed. Adjust the voltage of the second supply to be the same as the first unit before connecting them together. The second supply can be made to share load by advancing the VOLTAGE ADJUST control slightly clockwise. The second supply will furnish the regulation action up to the limit of its capacity (150 ma).

The second supply may be loaded beyond the 150 ma point up to a maximum of 225 ma, making a total of 450 ma available. The usefulness of this extra output capacity depends on the performance required from the supplies. The supplies become constant current sources when the SHORT CIRCUIT CURRENT limiting circuit is operating. At this point the ripple, source impedance and voltage regulation specifications cannot apply.

Operation of more than two instruments in parallel is not recommended as the total current capacity becomes greater and accidental gross misadjusted controls may result in instability.

## SECTION III

# THEORY OF OPERATION

### 3-1 GENERAL CIRCUIT DESCRIPTION

The regulation is accomplished in a manner which is similar to vacuum tube type circuits. A power type transistor in series with the rectified output and the load, acts like a variable resistor which maintains a constant output voltage or current as selected by the controls. The power transistor is controlled by a two stage amplifier which amplifies any changes in the relative amplitudes of the output voltage and the reference voltage.

The electronic short circuit current limiting switch is a unique feature which is not normally found in the vacuum tube counterpart of the supply. This circuit senses any increase in current above a pre-selected value and in turn controls the conduction of the power transistor to limit the peak current to the pre-selected value. A detailed description of the Power Supply and its operation follows. Refer to the schematic diagram to identify the various components.

### 3-2 MAIN AND AUXILIARY SUPPLY DESCRIPTION

Transformer T1 supplies ac voltages to the main and auxiliary supplies. The main supply consists of silicon rectifiers CR1 and CR2 and capacitor C2. This supply furnishes about 43 volts to the regulator circuit. Silicon rectifier CR3, CR4 and capacitors C3, C4 and C5 supply -20 volts, which is required for operation of the control circuits.

Regulator transistor Q1 acts as a variable series resistance to lower the voltage to the desired value, as set by the front panel VOLTAGE ADJUST control R19. Q1 conducts more current when the base voltage goes more negative with respect to the emitter.

### 3-3 REFERENCE VOLTAGE

CR7 is a reversed biased diode operating in the break-down condition. The diode maintains a constant nominal 7 volts across itself, establishing a constant reference voltage between the negative out-

put lead and the base of Q4. Q4 is an emitter follower which repeats the reference voltage at its emitter terminal, less a constant internal base-emitter drop of about 0.2 volt. The voltage at the emitter has a low source impedance, making it insensitive to normal variations in current flow. The output voltage from the (+) output bus is sampled by VOLTAGE ADJUST control R19 which causes a current flow through R20 and R21. The regulator action maintains a constant current through R19 and R20.

### 3-4 REGULATION CYCLE DESCRIPTION

Assume the output level has been set with R19 and some change has occurred which causes the output voltage to rise. The voltage at the base of Q3 is that which would appear across a forward biased diode and is essentially constant. The electron current flow through R20 is constant. When the output voltage rises, part of the normal electron flow into the base of Q3 is diverted through R19. The reduced base-emitter electron current of Q3 reduces the collector-emitter electron current flow from R17 by a factor of approximately 100. Since fewer electrons flow into the collector of Q3 from R17 and the -16 volt bus, the voltage at R16 goes in a negative direction. This causes more electrons to flow through R16 into the base of Q2. Increased Q2 base to emitter current causes much higher collector-emitter current. Increased Q2 collector current raises the voltage at R5 which reduces the base to emitter current of Q1. The reduced base-emitter current of Q1 increases its collector-emitter resistance to electron current flow, hence increases its collector to emitter voltage drop. That voltage drop increases just enough to compensate for the initial output voltage rise, maintaining the output voltage at a constant level.

### 3-5 SHORT CIRCUIT CURRENT LIMITING CIRCUIT

The current flow to the load is sensed by a voltage drop across R11 ABCD. Silicon diode CR5 is

forward biased approximately 0.4 volt which is not enough voltage to cause appreciable current flow. Screwdriver adjust control R8 adjusts the value of the forward bias slightly to calibrate the circuit. The voltage at the junction of R7 and R8 goes more negative as the load current increases, which also lowers the voltage at the base of Q2. Q2 conducts more current which raises the base voltage of Q1 maintaining the load current at the pre-selected value. The SHORT CIRCUIT CURRENT switch selects the value of resistance which will give the correct value of sensing voltage to cause the circuit to operate at the load current selected.

### 3-6 OUTPUT SURGE PROTECTION CIRCUIT

Diode CR6 prevents a large surge output when the output VOLTAGE ADJUST control R19 is set to a low value (nearly full counterclockwise) and the power switch is turned off. This would normally occur because the auxiliary supply voltage decays faster than the main supply due to the large storage capacity of C2. When the auxiliary supply stops, the base voltage of Q1 would not be controlled. Q1

would then conduct very heavily. The resulting output surge could damage external components. CR6 connects the base of Q1 to the junction of R20 and R21. This point is normally about -0.9 volt. When the supply is turned off, Q4 stops conducting and this point rises towards +40 volts because of the low resistance path provided by R19. CR6 is then forward biased and pulls the base of Q1 positive which cuts Q1 off, preventing any output surge.

### 3-7 FREQUENCY RESPONSE CONTROL

C10 bypasses R18 for high frequencies, which raises gain of Q3. C6 and R15 provide negative feedback around Q2 to improve the frequency response.

C7 bypasses R19 to provide a constant maximum ac feedback from the dc output to the control circuit amplifier regardless of the setting of R19. C8 bypasses C9 to compensate for increased effective series resistance in C9 at temperatures below 0°C. C11 provides low internal impedance at high frequencies. C1 is an rf bypass to eliminate noise introduced by the power line.

### SERVICING ETCHED CIRCUIT BOARDS

Excessive heat or pressure can lift the copper strip from the board. Avoid damage by using a low power soldering iron (50 watts maximum) and following these instructions. Copper that lifts off the board should be cemented in place with a quick drying acetate base cement having good electrical insulating properties.

A break in the copper should be repaired by soldering a short length of tinned copper wire across the break.

Use only high quality rosin core solder when repairing etched circuit boards. NEVER USE PASTE FLUX. After soldering, clean off any excess flux and coat the repaired area with a high quality electrical varnish or lacquer.

When replacing components with multiple mounting pins such as tube sockets, electrolytic capacitors, and potentiometers, it will be necessary to lift each pin slightly, working around the components several times until it is free.

**WARNING:** If the specific instructions outlined in the steps below regarding etched circuit boards without eyelets are not followed, extensive damage to the etched circuit board will result.

1. Apply heat sparingly to lead of component to be replaced. If lead of component passes through an eyelet in the circuit board, apply heat on component side of board. If lead of component does not pass through an eyelet, apply heat to conductor side of board.

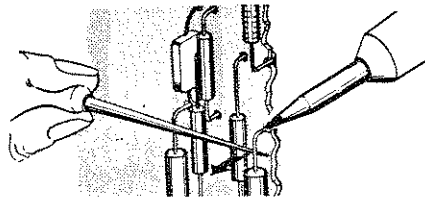

2. Reheat solder in vacant eyelet and quickly insert a small awl to clean inside of hole. If hole does not have an eyelet, insert awl or a #57 drill from conductor side of board.

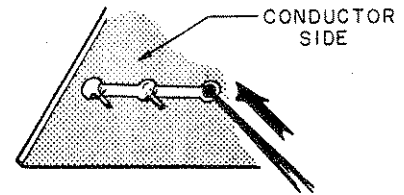

3. Bend clean tinned leads on new part and carefully insert through eyelets or holes in board.

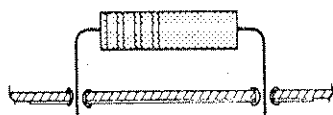

4. Hold part against board (avoid overheating) and solder leads. Apply heat to component leads on correct side of board as explained in step 1.

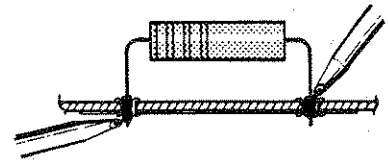

In the event that either the circuit board has been damaged or the conventional method is impractical, use method shown below. This is especially applicable for circuit boards without eyelets.

1. Clip lead as shown below.

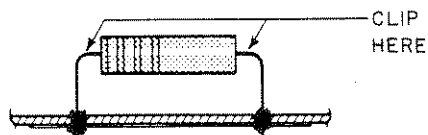

2. Bend protruding leads upward. Bend lead of new component around protruding lead. Apply solder using a pair of long nose pliers as a heat sink.

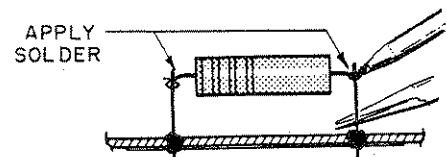

This procedure is used in the field only as an alternate means of repair. It is not used within the factory.

Figure 4-1. Servicing Etched Circuit Boards

# SECTION IV MAINTENANCE

## 4-1 CONTENTS

This section tells how to make internal adjustments, locate trouble and how to check over-all performance. Paragraphs 4-4 and 4-5 may be used as a rapid performance check to certify that the power supply is operating within published specifications. These tests can be made with the instrument in its cabinet.

## 4-2 GENERAL MAINTENANCE INFORMATION

The power supply has no parts which have a definite limited life. The instrument should operate indefinitely with no routine maintenance. If any parts are replaced you should recheck the settings of the screwdriver controls which set the maximum output voltage (R21) and maximum short circuit current (R8). Variations among parts may make it necessary to readjust these controls slightly. Reseal the control with duco cement after adjustment, otherwise the setting will change with shock and vibration.

A list of possible troubles and the probable cause are tabulated in paragraph 4-3. In each case, curing the trouble involves replacing the defective parts, except loose end-clips on the silicon rectifiers may be repaired by slightly crimping the fitting.

Be careful when soldering on the etched circuit board. You can cause damage by excessive heat or improper technique. Figure 4-1 explains some of the proper techniques to follow.

Paragraphs 4-4 and 4-5 show suitable set-ups for checking power supply performance. The equipment and connections should be followed carefully to avoid false results. This is especially true when making ripple and dynamic ac impedance measurements.

Stray ground loops are easy to establish if equipment grounding techniques are not carefully controlled. The relative position of each instrument in the set-up should be followed. If equipment other than that shown is used, it should be of equivalent performance and input characteristics. Avoid long leads to prevent stray pick-up.

The procedure given does not account for power supply noise which adds to the voltmeter reading due to internal impedance. The residual power supply noise represents a small error at low audio frequencies when calculating the internal impedance. However, the value obtained will be well within rated performance even neglecting this error.

Standard components are used for manufacture of  $\text{hp}$  instruments whenever possible. Special components are available directly from the  $\text{hp}$  factory. Perhaps your most convenient source for spare or replacement parts is your local  $\text{hp}$  Representative who maintains a parts stock for your convenience.

When ordering parts, please specify instrument model and serial number plus the component description and stock number appearing in the Table of Replaceable Parts.

Your local  $\text{hp}$  Representative also maintains complete service facilities and specially trained personnel to assist you with any engineering, application, test, or repair problems you may have with  $\text{hp}$  instruments.

## 4-3 TROUBLE LOCALIZATION

Table 4-1 lists some possible troubles and their causes.

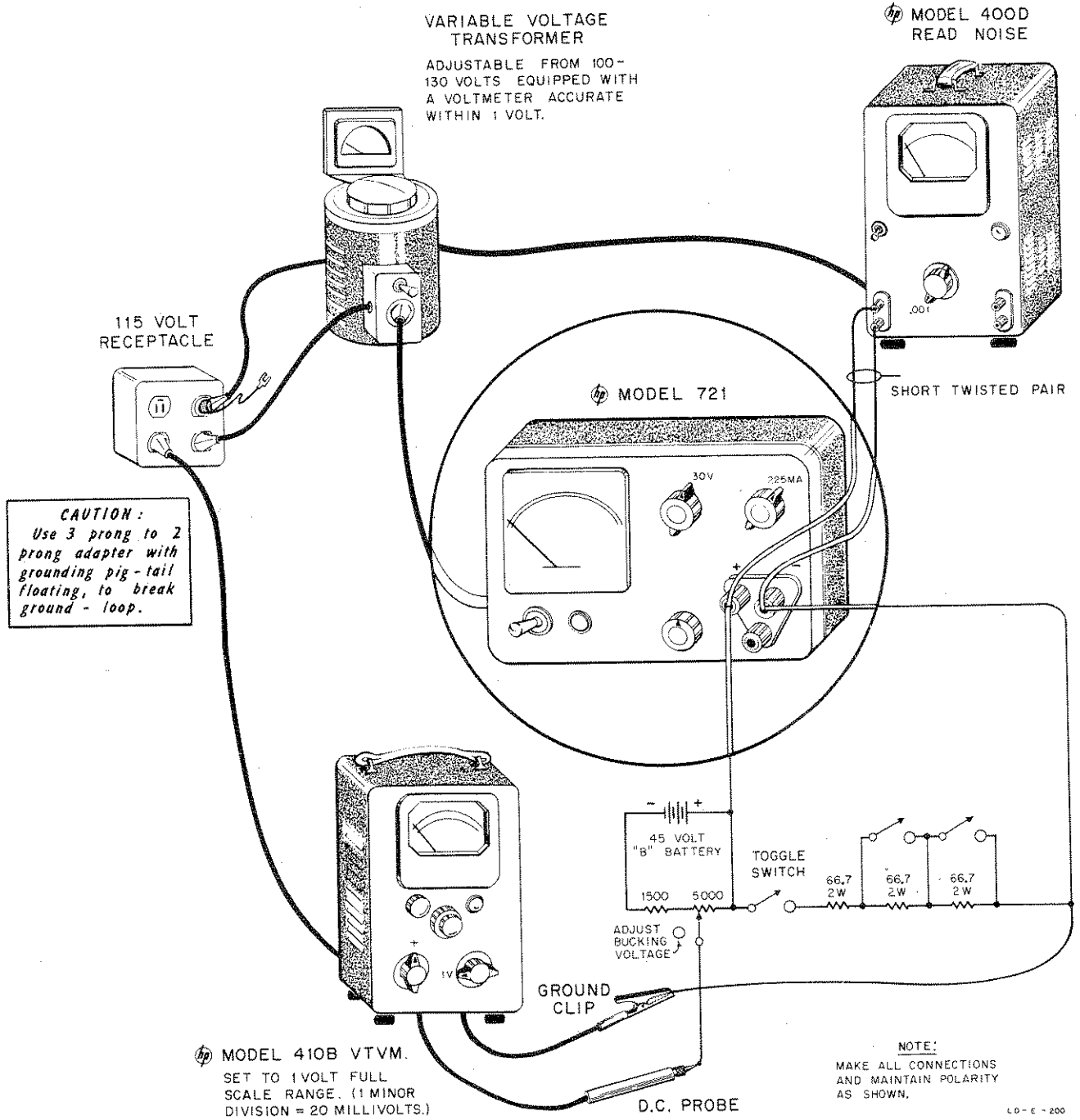

Figure 4-2. Checking Voltage Regulation and Ripple

TABLE 4-1. TROUBLE LOCALIZATION CHART

Trouble Symptom	Probable Cause
No output, fuse blows	Shorted C1 or T1
No output, fuse does not blow	Shorted C8
Output voltage unstable Poor regulation Wandering voltage	Defective reference diode CR7.
Poor regulation (line or load)	Defective Q1, Q2, Q3, Q4 or CR1, CR2, CR3, CR4.
High noise or ripple on dc output (approximately 30 mv 50 to 150 kc)	Open C6 or possibly C10.
Microphonics	Noisy R19.
Voltage control not smooth	Defective R19.

#### 4-4 CHECKING VOLTAGE REGULATION AND RIPPLE

- 1) Set Model 410B VTVM to 30 volt range.
- 2) Adjust Model 721A to 30 volt output.
- 3) Adjust line voltage to 115 volts.
- 4) Adjust Battery-Potentiometer to obtain 30 volts. VTVM will then read 0 volt.
- 5) Switch VTVM to 1 volt range.
- 6) Adjust bucking voltage so VTVM pointer sits at about 1/2 scale.
- 7) Switch from full load to no load.  
Load = 200 ohms.
- 8) Voltage will not change more than 0.3% (0.09 v) at 30 volts output, which is worst condition.
- 9) Repeat at 20 volts and 10 volts if desired. (Short out one or two 66.7 ohm resistors to get 150 ma rated load, depending on voltage selected). Readjust bucking voltage so VTVM is again at mid-scale.

$$20 \text{ v} \times .003 = 60 \text{ mv maximum change}$$

$$10 \text{ v} \times .003 = 30 \text{ mv maximum change}$$

At voltages less than 10 volts, change from no load to full load will result in less than 30 mv change in voltage.

- 10) Repeat test with line voltage at 103 and 127 volts.
- 11) Adjust line voltage to 115 volts.
- 12) Adjust output voltage to 30 volts and load to 200 ohms (for rated current).
- 13) Change line voltage  $\pm 10\%$  to 103 and 127 volts. Output will change less than .3% (.09 v). This is worst condition. At outputs below 5 v dc, regulation is within  $\pm 15$  mv.
- 14) Measure ripple with Model 400D, use 1 mv full scale range. Ripple + noise will be less than  $150 \mu\text{v}$  (0.15 mv).

#### 4-5 MEASURING AC INTERNAL IMPEDANCE

The internal impedance of the supply is affected by the ac gain of the regulator circuit. If the supply has good dc regulation and low ripple ac in the output the supply should also have low ac impedance. Figure 4-3 shows a suitable set-up for checking the internal ac impedance if desired. The set-up shown should be followed faithfully if meaningful results are to be obtained. The level of signal to be measured is very low and ground loops in the system can easily give very large errors. The measurement is made by driving a constant 10 ma alternating current through the power supply and measuring the IZ drop across the output terminals. The internal impedance can be easily calculated by ohm's law.

#### 4-6 METER CALIBRATION

The meter mechanical zero should be accurately set before calibration. The correct way to do this is to rotate the adjust screw clockwise until the pointer swings up scale and then starts to swing down scale toward zero. Continue rotating the adjust screw clockwise until the pointer is exactly over zero. If you overshoot, continue turning the screw clockwise until the pointer is again approaching zero from the up scale side.

The internal meter is calibrated by connecting an external standard milliammeter across the output

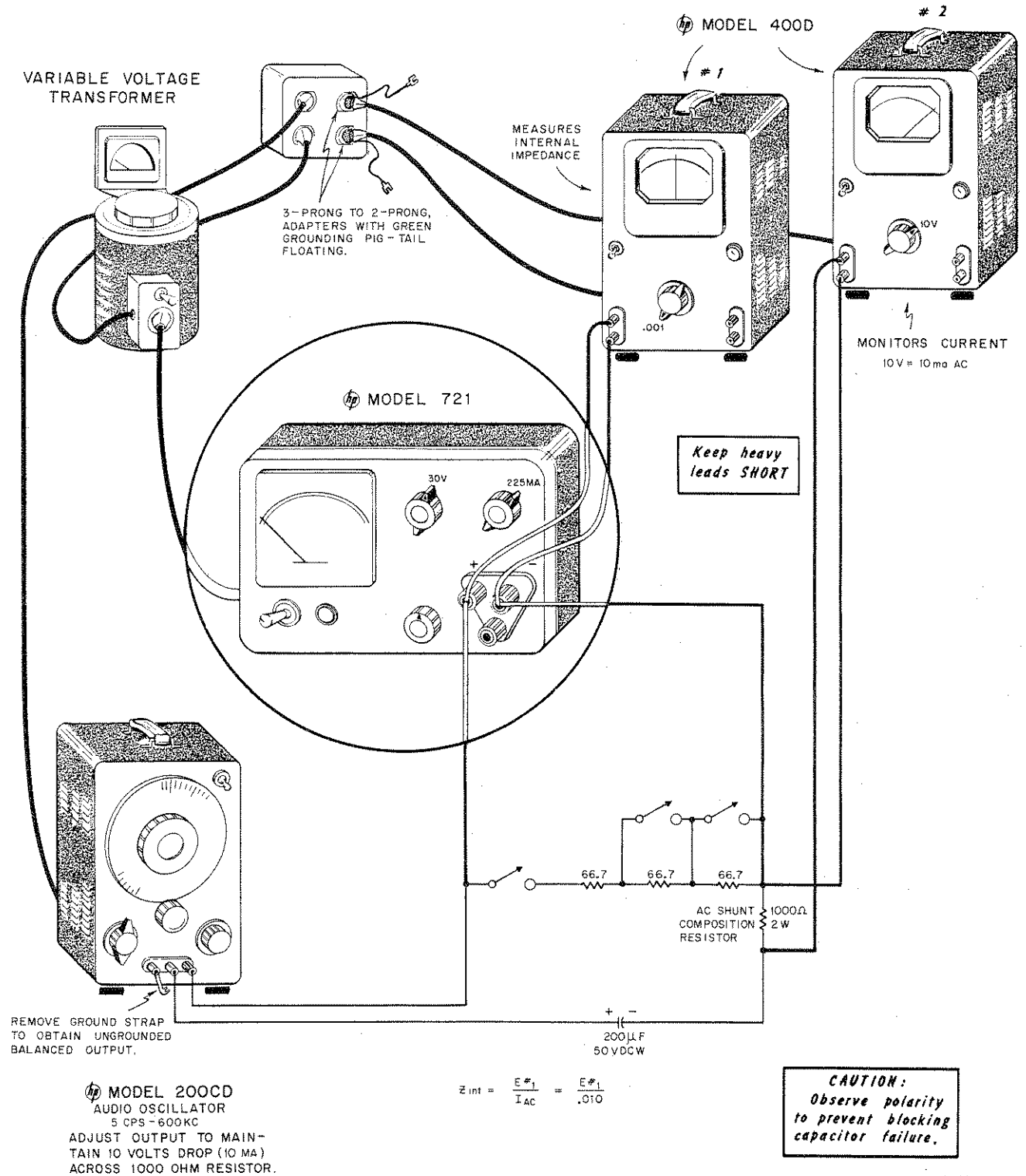

L0-E-201

Figure 4-3. Measuring AC Internal Impedance



terminals in series with approximately 1,000 ohms. The output VOLTAGE ADJUST control should be advanced until the standard meter indicates 10 ma. The internal meter should be switched to the 10 ma range. Adjust R25 until the internal meter reads the same as the external meter. All other current and voltage calibrations will then be determined by the precision current and voltage multiplier resistors associated with the METER RANGE switch.

#### 4-7 SETTING MAXIMUM OUTPUT VOLTAGE

The maximum output voltage should be set to be 31 volts.

- 1) Turn the VOLTAGE ADJUST control full clockwise.
- 2) Measure the output voltage with either internal voltmeter or an external standard voltmeter.
- 3) Adjust R21 to obtain 31 volts.
- 4) Reseal the control with duco cement.

#### 4-8 CALIBRATING THE SHORT CIRCUIT CURRENT CIRCUIT

- 1) Rotate the SHORT CIRCUIT CURRENT switch to 225 ma.
- 2) Short circuit the output terminals.
- 3) Rotate the VOLTAGE ADJUST control full clockwise.

- 4) Adjust R8 to obtain 230 ma.

#### NOTE

This adjustment provides the best over-all calibration of this circuit on all ranges. The circuit is slightly temperature sensitive. With the instrument in its cabinet and hot, the maximum current available will be approximately 225 ma.



-----

- 5) Reseal the control with duco cement.

#### 4-9 REPLACING THE POWER TRANSISTOR

If you replace the power transistor (Q1) be careful to note how the nylon bushings are installed in the transistor mounting holes. They must be reinstalled properly since the case of the transistor is not at chassis potential. You should also check that there are no burrs on the transistor case which can cut through the anodized surface of the mounting plate. The anodized surface acts as a good electrical insulator while allowing good heat transfer from the transistor. If this surface is damaged the maximum voltage at which the power supply can be operated off of ground potential may be reduced.

#### 4-10 REPLACING DIODES CR5, CR6 AND CR7

The diodes CR5, CR6 and CR7 are manufactured by . They have carefully controlled characteristics which result in a superior performing instrument. Should replacement be necessary we recommend that you use similar diodes. You may obtain these from your local  Representative or by ordering directly from the factory. The cathode end of the diode is marked with a spot of red paint.

FACTORY ADJ. SET FOR  
230 ma. MAX. SHORT  
CIRCUIT CURRENT.

SHORT CIRCUIT CURRENT SWITCH  
SET TO 225 ma. OUTPUT VOLTAGE  
ADJUST CONTROL FULL CLOCKWISE  
OUTPUT TERMINALS SHORTED.

FACTORY ADJ. SET FOR  
230 ma. MAX. SHORT  
CIRCUIT CURRENT.

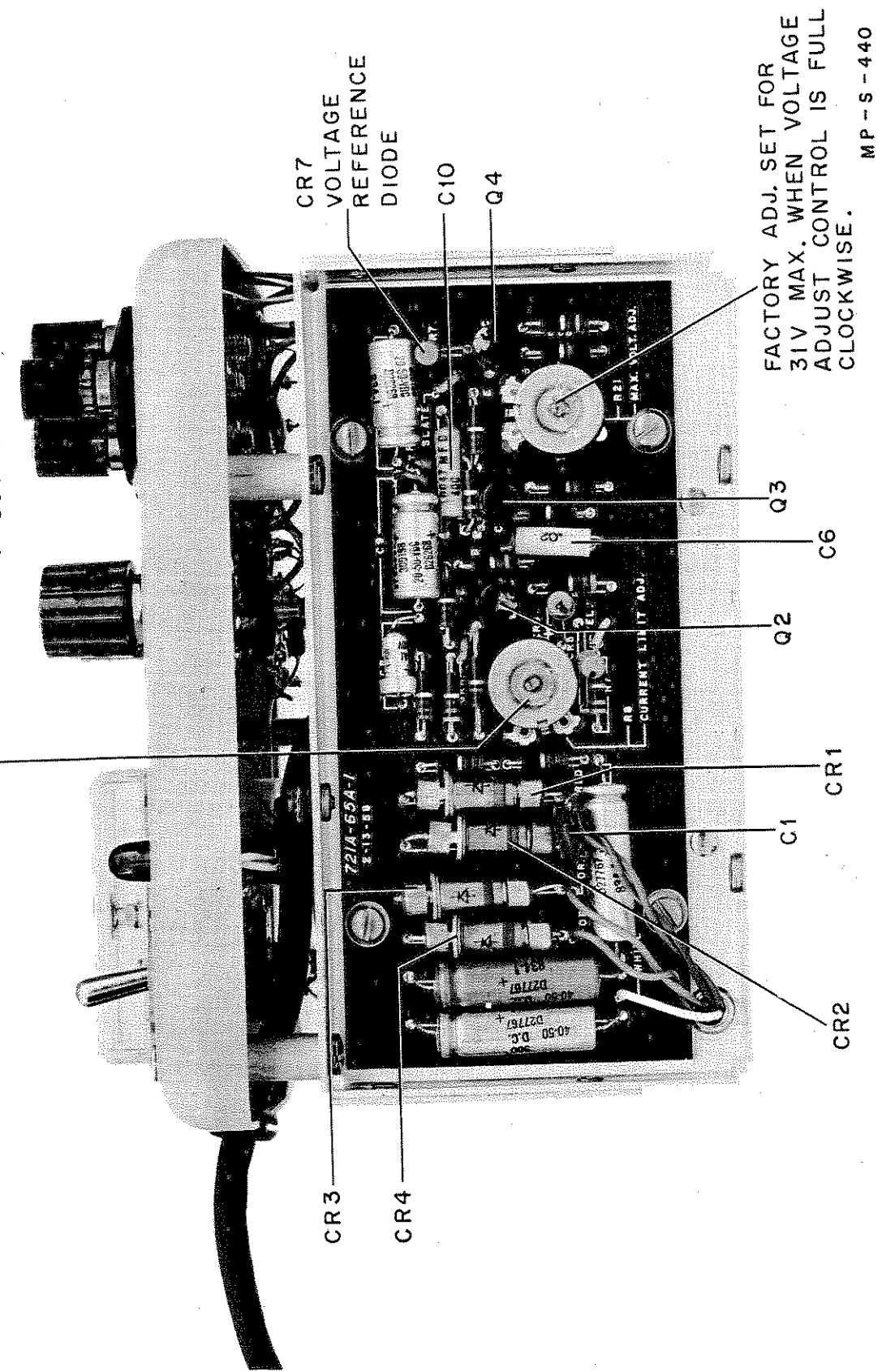

FACTORY ADJ. SET FOR  
31V MAX. WHEN VOLTAGE  
ADJUST CONTROL IS FULL  
CLOCKWISE.

MP-S-440

Figure 4-4. Model 721A Bottom Internal View

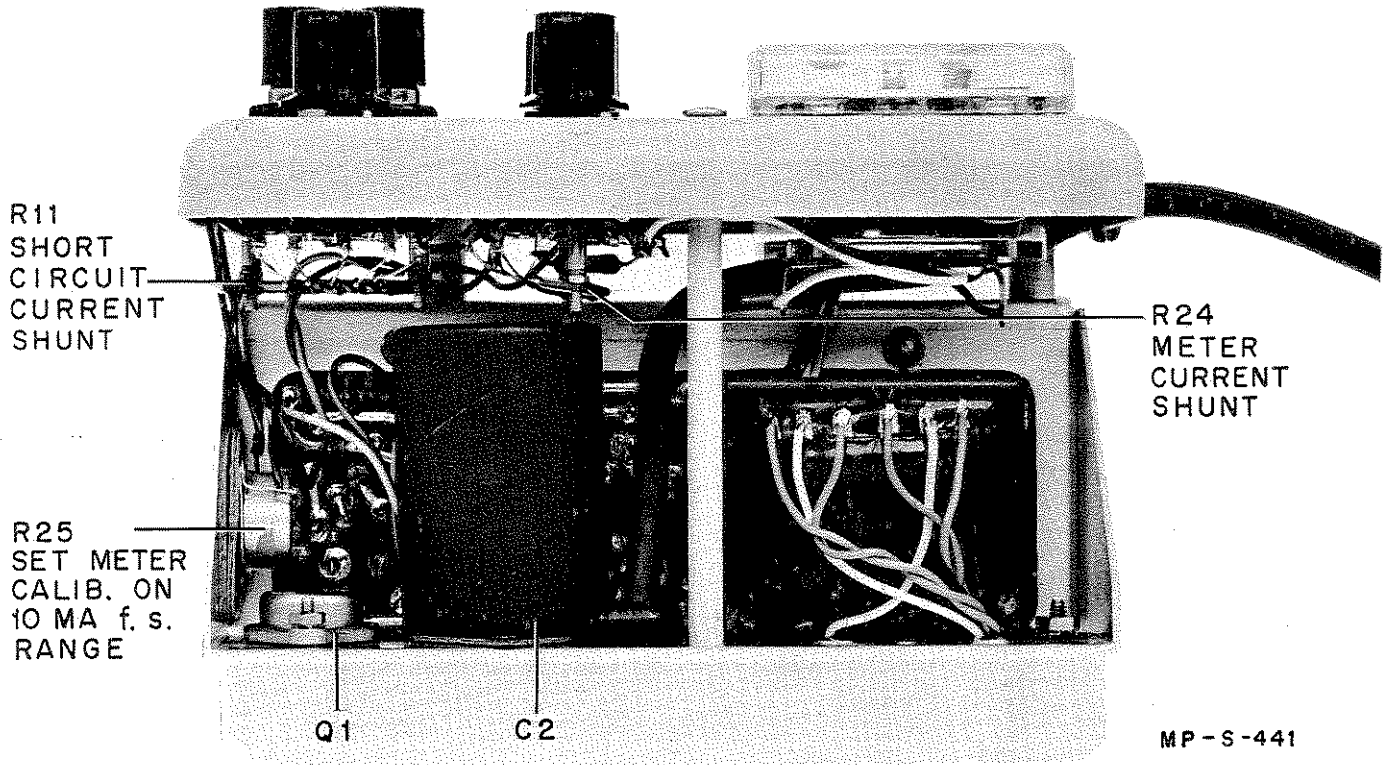

Figure 4-5. Model 721A Top Internal View

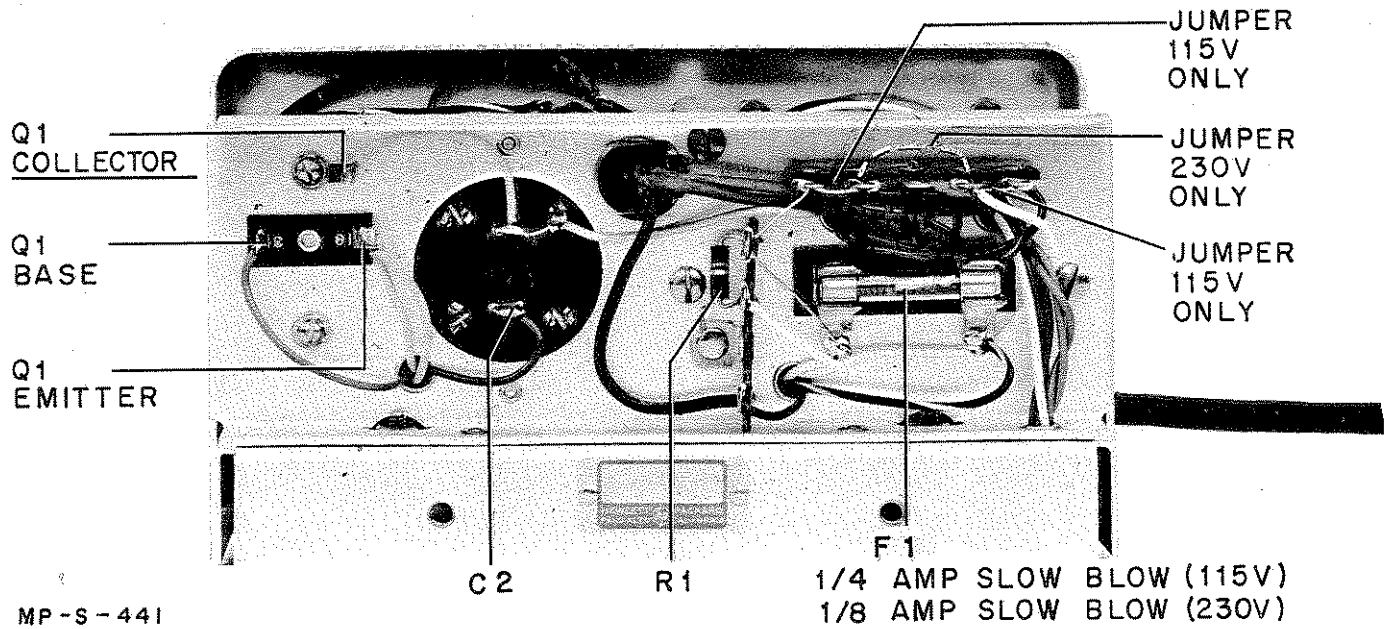
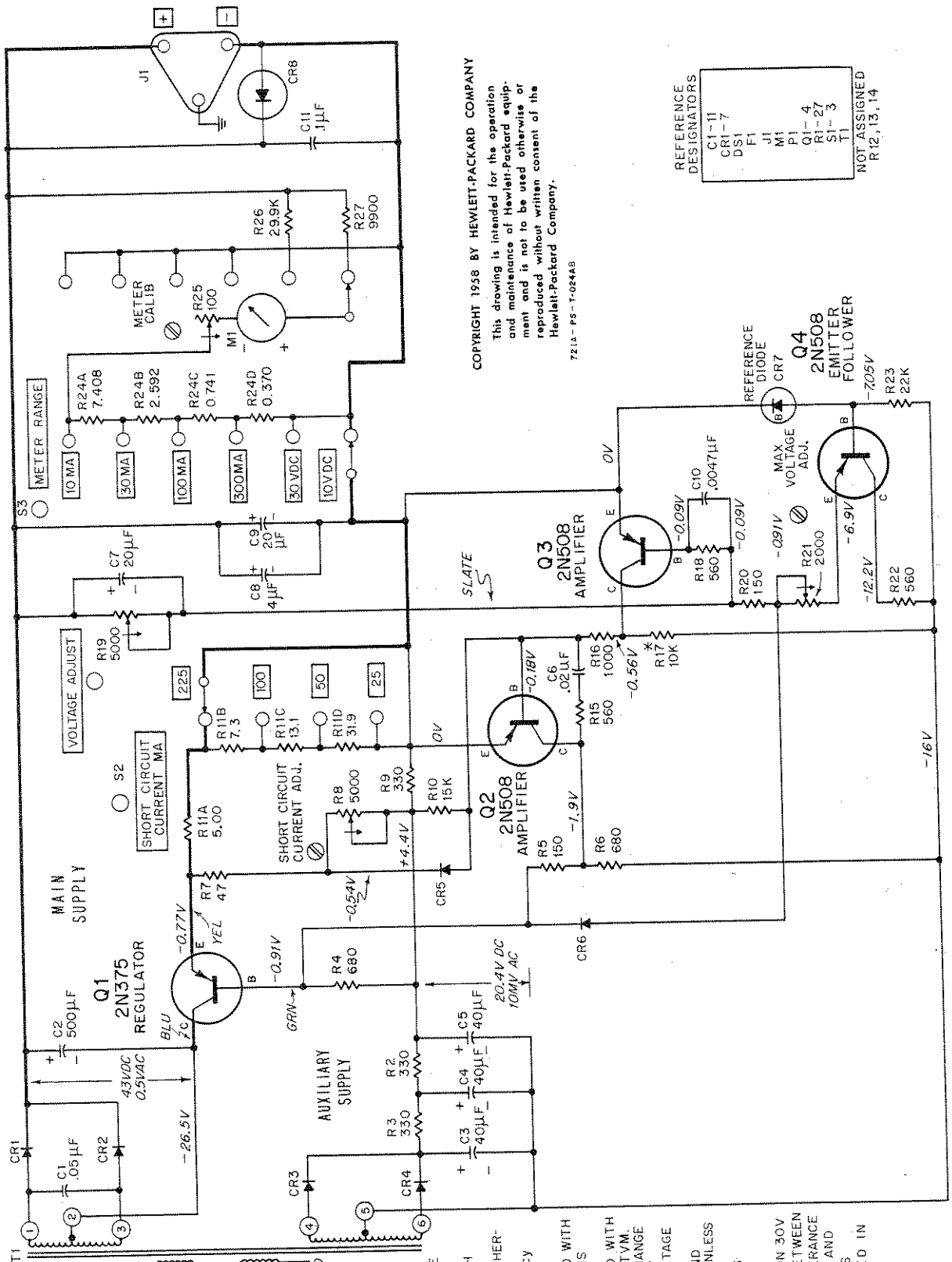

Figure 4-6. Model 721A Rear Internal View



COPYRIGHT 1958 BY HEWLETT-PACKARD COMPANY  
 This drawing is intended for the operation and maintenance of Hewlett-Packard equipment and is not to be used otherwise or reproduced without written consent of the Hewlett-Packard Company.  
 721A-PS-1-024AB

REFERENCE DESIGNATORS	NOT ASSIGNED
C1-11	R12, 13, 14
CR1-7	
DS1	
F1	
J1	
M1	
PI	
Q1-4	
R1-27	
S1-3	
T1	

NOTES  
 CONDITIONS OF DC VOLTAGE MEASUREMENTS

- 1) VOLTAGES MEASURED WITH RESPECT TO  $\square$  TERMINAL EXCEPT WHERE SHOWN OTHERWISE.
- 2) LINE VOLTAGE = 115V 60cy  $E_o = 15V$ ;  $I_o = 150\text{ ma}$  ( $R_L = 100\Omega$ )
- 3) D.C. VOLTAGES MEASURED WITH A V.TVM OF 122 MEGOHMS IMPEDENCE.
- 4) A.C. VOLTAGES MEASURED WITH  $-hp$  MODEL 400D AC VTVM.
- 5) MOST VOLTAGES WILL CHANGE WITH DIFFERENT SUPPLY VOLTAGE OR OUTPUT VOLTAGE OR CURRENT.
- 6) RESISTANCE IN OHMS AND CAPACITANCE IN  $\mu\text{F}$  UNLESS OTHERWISE NOTED.
- 7) POTENTIOMETER ARROWS INDICATE CLOCKWISE ROTATION.
- 8) METER RANGE SWITCH ON 30V
- 9) VOLTAGES MAY VARY BETWEEN SUPPLIES DUE TO TOLERANCE IN REFERENCE DIODES AND TRANSISTORS. VALUES SHOWN WERE MEASURED IN AN AVERAGE UNIT.

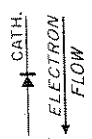



Figure 4-7. Model 721A Power Supply

## SECTION V TABLE OF REPLACEABLE PARTS

### NOTE

Standard components have been used in this instrument, whenever possible. Special components may be obtained from your local Hewlett-Packard representative or from the factory.

When ordering parts always include:

1.  Stock Number.
2. Complete description of part including circuit reference.
3. Model number and serial number of instrument.
4. If part is not listed, give complete description, function and location of part.

Corrections to the Table of Replaceable Parts are listed on an Instruction Manual Change sheet at the front of this manual.

### RECOMMENDED SPARE PARTS LIST

Column RS in the Table lists the recommended spare parts quantities to maintain one instrument for one year of isolated service. Order complete spare parts kits from the Factory Parts Sales Department. ALWAYS MENTION THE MODEL AND SERIAL NUMBERS OF INSTRUMENTS INVOLVED.

12-1-59

TABLE OF REPLACEABLE PARTS

CIRCUIT REF.	DESCRIPTION, MFR. * & MFR. DESIGNATION	STOCK NO.	TQ	RS		
C1	Capacitor: fixed, ceramic, .05 $\mu$ f $\pm$ 20%, 400 vdcw NN*	0150-0052	1	1		
C2	Capacitor: fixed, electrolytic 500 $\mu$ f, 75 vdcw CC*	0180-0047	1	1		
C3, 4, 5	Capacitor: fixed, electrolytic 40 $\mu$ f -15% + 100%, 50 vdcw CC*	0180-0050	3	1		
C6	Capacitor: fixed, mylar, .02 $\mu$ f $\pm$ 20%, 400 vdcw CC*	0170-0024	1	1		
C7	Capacitor: fixed, electrolytic, 20 $\mu$ f -15% + 100%, 50 vdcw CC*	0180-0049	2	1		
C8	Capacitor: fixed, electrolytic 4 $\mu$ f -15% + 20%, 60 vdcw AH*	0180-0008	1	1		
C9	Same as C7					
C10	Capacitor: fixed, mylar, .0047 $\mu$ f $\pm$ 10%, 400 vdcw CW*	0170-0021	1	1		
C11	Capacitor: fixed, mylar, 0.1 $\mu$ f $\pm$ 5%, 200 vdcw CW*	0170-0019	1	1		
CR1, 2, 3, 4	Rectifier, silicon: 100 PIV, 500 ma BV*	1901-0008	5	5		
CR5, 6	Diode HP*	G-29A-10	2	2		
CR7	Diode, Breakdown HP*	G-29A-3	1	1		
CR8	Same as CR1					
DS1	Light, indicator: 1/25 W, neon, NE2A Eldema	1450-0037	1	1		
F1	Fuse: 1/4 amp, slow-blow, 115 volt operation Fuse: .15 amp, slow-blow, 230 volt operation T*	2110-0018 2110-0017	1	10		
J1	Consists of: Binding post, black Binding post, red Insulator, binding post, dual Insulator, binding post, triple HP* HP* HP* HP*	AC-10C AC-10D AC-54A AC-54C	2 1 1 1	1 1 0 0		
M1	Meter HP*	1120-0069	1	1		
P1	Cord, power Cornish Wire Co.	8120-0037	1	1		
Q1	Transistor: 2N375 **	1850-0015	1	1		
Q2, 3, 4	Transistor: 2N508 **	1850-0013	3	3		

\* See "List of Manufacturers Code Letters For Replaceable Parts Table".

TQ - Total quantity used in the instrument.

\*\* Any transistor meeting EIA standards.

RS - Recommended spares for one year isolated service for one instrument.

TABLE OF REPLACEABLE PARTS

CIRCUIT REF.	DESCRIPTION, MFR. * & MFR. DESIGNATION	Ⓟ STOCK NO.	TQ	RS		
R1	Resistor: fixed, composition, 100,000 ohms $\pm 10\%$ , 1/2 W B*	0687-1041	1	1		
R2, 3	Resistor: fixed, composition, 330 ohms $\pm 10\%$ , 1/2 W B*	0687-3311	3	1		
R4	Resistor: fixed, composition, 680 ohms $\pm 10\%$ , 1/2 W B*	0687-6811	2	1		
R5	Resistor: fixed, composition, 150 ohms $\pm 10\%$ , 1/2 W B*	0687-1511	2	1		
R6	Same as R4					
R7	Resistor: fixed, composition, 47 ohms $\pm 10\%$ , 1/2 W B*	0687-4701	1	1		
R8	Resistor: variable, composition, linear taper, 5000 ohms $\pm 30\%$ , 1/3 W BO*	2100-0091	1	1		
R9	Same as R2					
R10	Resistor: fixed, composition, 15,000 ohms $\pm 10\%$ , 1/2 W B*	0687-1531	1	1		
R11ABCD	Resistor: wirewound HP*	721A-26A	1	1		
R12, 13, 14	These circuit references not assigned					
R15	Resistor: fixed, composition, 560 ohms $\pm 10\%$ , 1/2 W B*	0687-5611	3	1		
R16	Resistor: fixed, composition, 1000 ohms $\pm 10\%$ , 1/2 W B*	0687-1021	1	1		
R17	Resistor: fixed, composition, 10,000 ohms $\pm 10\%$ , 1/2 W Optimum value selected at factory. Average value shown B*	0687-1031	1	1		
R18	Same as R15					
R19	Resistor: variable, composition, linear taper, 5000 ohms BO*	2100-0011	1	1		
R20	Same as R5					
R21	Resistor: variable, composition, linear taper, 2000 ohms $\pm 30\%$ , 1/3 W BO*	2100-0090	1	1		
R22	Same as R15					
R23	Resistor: fixed, composition, 22,000 ohms $\pm 10\%$ , 1/2 W B*	0687-2231	1	1		

\* See "List of Manufacturers Code Letters For Replaceable Parts Table".

TQ - Total quantity used in the instrument.

RS - Recommended spares for one year isolated service for one instrument.

TABLE OF REPLACEABLE PARTS

CIRCUIT REF.	DESCRIPTION, MFR. * & MFR. DESIGNATION	Ⓢ STOCK NO.	TQ	RS		
R24 ABCD	Resistor: wirewound, meter range	HP* 721A-26B	1	1		
R25	Resistor: variable, 100 ohms	HP* M-80	1	1		
R26	Resistor: fixed, deposited carbon, 29,900 ohms $\pm 1\%$ , 1/2 W	NN* 0727-0185	1	1		
R27	Resistor: fixed, deposited carbon, 9900 ohms $\pm 1\%$ , 1/2 W	NN* 0727-0156	1	1		
S1	Switch, toggle: SPST	D* 3101-0001	1	1		
S2	Short Circuit Switch Assembly	HP* 721A-19A	1	1		
	Switch, rotary: less components	W* 3100-0171	1	0		
S3	Meter Range Switch Assembly	HP* 721A-19B	1	1		
	Switch, rotary: less components	W* 3100-0172	1	0		
T1	Transformer, power	HP* 9100-0129	1	1		
	<u>MISCELLANEOUS</u>					
	Fuseholder	T* 1400-0008	1	1		
	Knob: VOLTAGE ADJUST	HP* G-74D	1	0		
	Knob: METER RANGE, SHORT CIRCUIT CONTROL	HP* G-74BS	2	0		

\* See "List of Manufacturers Code Letters For Replaceable Parts Table".

TQ - Total quantity used in the instrument.

RS - Recommended spares for one year isolated service for one instrument.



## LIST OF CODE LETTERS USED IN TABLE OF REPLACEABLE PARTS TO DESIGNATE THE MANUFACTURERS

<u>CODE LETTER</u>	<u>MANUFACTURER</u>	<u>ADDRESS</u>	<u>CODE LETTER</u>	<u>MANUFACTURER</u>	<u>ADDRESS</u>
A	Aerovox Corp.	New Bedford, Mass.	AK	Hammerlund Mfg. Co., Inc.	New York 1, N. Y.
B	Allen-Bradley Co.	Milwaukee 4, Wis.	AL	Industrial Condenser Corp.	Chicago 18, Ill.
C	Amperite Co.	New York, N. Y.	AM	Insuline Corp. of America	Manchester, N. H.
D	Arrow, Hart & Hegeman	Hartford, Conn.	AN	Jennings Radio Mfg. Corp.	San Jose, Calif.
E	Bussman Manufacturing Co.	St. Louis, Mo.	AO	E. F. Johnson Co.	Waseca, Minn.
F	Carborundum Co.	Niagara Falls, N. Y.	AP	Lenz Electric Mfg. Co.	Chicago 47, Ill.
G	Centralab	Milwaukee 1, Wis.	AQ	Micro-Switch	Freeport, Ill.
H	Cinch-Jones Mfg. Co.	Chicago 24, Ill.	AR	Mechanical Industries Prod. Co.	Akron 8, Ohio
HP	Hewlett-Packard Co.	Palo Alto, Calif.	AS	Model Eng. & Mfg., Inc.	Huntington, Ind.
I	Clarostat Mfg. Co.	Dover, N. H.	AT	The Muter Co.	Chicago 5, Ill.
J	Cornell Dubilier Elec. Co.	South Plainfield, N. J.	AU	Ohmite Mfg. Co.	Skokie, Ill.
K	Hi-Q Division of Aerovox	Olean, N. Y.	AV	Resistance Products Co.	Harrisburg, Pa.
L	Erie Resistor Corp.	Erie 6, Pa.	AW	Radio Condenser Co.	Camden 3, N. J.
M	Fed. Telephone & Radio Corp.	Clifton, N. J.	AX	Shallcross Manufacturing Co.	Collingdale, Pa.
N	General Electric Co.	Schenectady 5, N. Y.	AY	Solar Manufacturing Co.	Los Angeles 58, Calif.
O	General Electric Supply Corp.	San Francisco, Calif.	AZ	Sealectro Corp.	New Rochelle, N. Y.
P	Girard-Hopkins	Oakland, Calif.	BA	Spencer Thermostat	Attleboro, Mass.
Q	Industrial Products Co.	Danbury, Conn.	BC	Stevens Manufacturing Co.	Mansfield, Ohio
R	International Resistance Co.	Philadelphia 8, Pa.	BD	Torrington Manufacturing Co.	Van Nuys, Calif.
S	Lectrohm Inc.	Chicago 20, Ill.	BE	Vector Electronic Co.	Los Angeles 65, Calif.
T	Littlefuse Inc.	Des Plaines, Ill.	BF	Weston Electrical Inst. Corp.	Newark 5, N. J.
U	Maguire Industries Inc.	Greenwich, Conn.	BG	Advance Electric & Relay Co.	Burbank, Calif.
V	Micamold Radio Corp.	Brooklyn 37, N. Y.	BH	E. I. DuPont	San Francisco, Calif.
W	Oak Manufacturing Co.	Chicago 10, Ill.	BI	Electronics Tube Corp.	Philadelphia 18, Pa.
X	P. R. Mallory Co., Inc.	Indianapolis, Ind.	BJ	Aircraft Radio Corp.	Boonton, N. J.
Y	Radio Corp. of America	Harrison, N. J.	BK	Allied Control Co., Inc.	New York 21, N. Y.
Z	Sangamo Electric Co.	Marion, Ill.	BL	Augat Brothers, Inc.	Attleboro, Mass.
AA	Sarkes Tarzian	Bloomington, Ind.	BM	Carter Radio Division	Chicago, Ill.
BB	Signal Indicator Co.	Brooklyn 37, N. Y.	BN	CBS Hytron Radio & Electric	Danvers, Mass.
CC	Sprague Electric Co.	North Adams, Mass.	BO	Chicago Telephone Supply	Elkhart, Ind.
DD	Stackpole Carbon Co.	St. Marys, Pa.	BP	Henry L. Crowley Co., Inc.	West Orange, N. J.
EE	Sylvania Electric Products Co.	Warren, Pa.	BQ	Curtiss-Wright Corp.	Carlstadt, N. J.
FF	Western Electric Co.	New York 5, N. Y.	BR	Allen B. DuMont Labs	Clifton, N. J.
GG	Wilkor Products, Inc.	Cleveland, Ohio	BS	Excel Transformer Co.	Oakland, Calif.
HH	Amphenol	Chicago 50, Ill.	BT	General Radio Co.	Cambridge 39, Mass.
II	Dial Light Co. of America	Brooklyn 37, N. Y.	BU	Hughes Aircraft Co.	Culver City, Calif.
JJ	Leecraft Manufacturing Co.	New York, N. Y.	BV	International Rectifier Corp.	El Segundo, Calif.
KK	Switchcraft, Inc.	Chicago 22, Ill.	BW	James Knights Co.	Sandwich, Ill.
LL	Gremar Manufacturing Co.	Wakefield, Mass.	BX	Mueller Electric Co.	Cleveland, Ohio
MM	Carad Corp.	Redwood City, Calif.	BY	Precision Thermometer & Inst. Co.	Philadelphia 30, Pa.
NN	Electra Manufacturing Co.	Kansas City, Mo.	BZ	Radio Essentials Inc.	Mt. Vernon, N. Y.
OO	Acro Manufacturing Co.	Columbus 16, Ohio	CA	Raytheon Manufacturing Co.	Newton, Mass.
PP	Alliance Manufacturing Co.	Alliance, Ohio	CB	Tung-Sol Lamp Works, Inc.	Newark 4, N. J.
QQ	Arco Electronics, Inc.	New York 13, N. Y.	CD	Varian Associates	Palo Alto, Calif.
RR	Astron Corp.	East Newark, N. J.	CE	Victory Engineering Corp.	Union, N. J.
SS	Axel Brothers Inc.	Long Island City, N. Y.	CF	Weckesser Co.	Chicago 30, Ill.
TT	Belden Manufacturing Co.	Chicago 44, Ill.	CG	Wilco Corporation	Indianapolis, Ind.
UU	Bird Electronics Corp.	Cleveland 14, Ohio	CH	Winchester Electronics, Inc.	Santa Monica, Calif.
VV	Barber Colman Co.	Rockford, Ill.	CI	Malco Tool & Die	Los Angeles 42, Calif.
WW	Bud Radio Inc.	Cleveland 3, Ohio	CJ	Oxford Electric Corp.	Chicago 15, Ill.
XX	Allen D. Cardwell Mfg. Co.	Plainville, Conn.	CK	Camloc-Fastener Corp.	Paramus, N. J.
YY	Cinema Engineering Co.	Burbank, Calif.	CL	George K. Garrett	Philadelphia 34, Pa.
ZZ	Any brand tube meeting RETMA standards.		CM	Union Switch & Signal	Swissvale, Pa.
AB	Corning Glass Works	Corning, N. Y.	CN	Radio Receptor	New York 11, N. Y.
AC	Dale Products, Inc.	Columbus, Neb.	CO	Automatic & Precision Mfg. Co.	Yonkers, N. Y.
AD	The Drake Mfg. Co.	Chicago 22, Ill.	CP	Bassick Co.	Bridgeport 2, Conn.
AE	Elco Corp.	Philadelphia 24, Pa.	CQ	Birnbach Radio Co.	New York 13, N. Y.
AF	Hugh H. Eby Co.	Philadelphia 44, Pa.	CR	Fischer Specialties	Cincinnati 6, Ohio
AG	Thomas A. Edison, Inc.	West Orange, N. J.	CS	Telefunken (c/o MVM, Inc.)	New York, N. Y.
AH	Fansteel Metallurgical Corp.	North Chicago, Ill.	CT	Potter-Brumfield Co.	Princeton, Ind.
AI	General Ceramics & Steatite Corp.	Keasbey, N. J.	CU	Cannon Electric Co.	Los Angeles, Calif.
AJ	The Gudeman Co.	Sunnyvale, Calif.	CV	Dynac, Inc.	Palo Alto, Calif.
			CW	Good-All Electric Mfg. Co.	Ogallala, Nebr.

## CLAIM FOR DAMAGE IN SHIPMENT

The instrument should be tested as soon as it is received. If it fails to operate properly, or is damaged in any way, a claim should be filed with the carrier. A full report of the damage should be obtained by the claim agent, and this report should be forwarded to us. We will then advise you of the disposition to be made of the equipment and arrange for repair or replacement. Include model number and serial number when referring to this instrument for any reason.

## WARRANTY

Hewlett-Packard Company warrants each instrument manufactured by them to be free from defects in material and workmanship. Our liability under this warranty is limited to servicing or adjusting any instrument returned to the factory for that purpose and to replace any defective parts thereof. Klystron tubes as well as other electron tubes, fuses and batteries are specifically excluded from any liability. This warranty is effective for one year after delivery to the original purchaser when the instrument is returned, transportation charges prepaid by the original purchaser, and when upon our examination it is disclosed to our satisfaction to be defective. If the fault has been caused by misuse or abnormal conditions of operation, repairs will be billed at cost. In this case, an estimate will be submitted before the work is started.

If any fault develops, the following steps should be taken:

1. Notify us, giving full details of the difficulty, and include the model number and serial number. On receipt of this information, we will give you service data or shipping instructions.
2. On receipt of shipping instructions, forward the instrument prepaid, to the factory or to the authorized repair station indicated on the instructions. If requested, an estimate of the charges will be made before the work begins provided the instrument is not covered by the warranty.

## SHIPPING

All shipments of Hewlett-Packard instruments should be made via Truck or Railway Express. The instruments should be packed in a strong exterior container and surrounded by two or three inches of excelsior or similar shock-absorbing material.

**DO NOT HESITATE TO CALL ON US**

**HEWLETT-PACKARD COMPANY**

*Laboratory Instruments for Speed and Accuracy*

275 PAGE MILL ROAD

CABLE



PALO ALTO, CALIF. U.S.A.

"HEWPACK"

## Free Manuals Download Website

<http://myh66.com>

<http://usermanuals.us>

<http://www.somanuals.com>

<http://www.4manuals.cc>

<http://www.manual-lib.com>

<http://www.404manual.com>

<http://www.luxmanual.com>

<http://aubethermostatmanual.com>

Golf course search by state

<http://golfingnear.com>

Email search by domain

<http://emailbydomain.com>

Auto manuals search

<http://auto.somanuals.com>

TV manuals search

<http://tv.somanuals.com>