



kitchen think

# Instructions for Installation and Use

**Washing machine  
Model ET 1400**

**To the Installer**

**Before installation fill in the product details on the back cover of this book.  
The information can be found on the rating plate.**

**To the User**

**You must read the instructions prior to installing and using the appliance and  
then retain them for future reference.**



**GB**

English,1

**ET 1400**

### Contents

#### **Installation, 2-3-4-5**

Unpacking and levelling, 2  
Electric and water connections, 2-3  
The first wash cycle, 4  
Technical details, 5

#### **Washing machine description, 6-7**

Control panel, 6  
Display, 7

#### **Starting and Programmes, 8**

Briefly: how to start a programme, 8  
Programme table, 8

#### **Personalisations, 9**

Setting the spin cycle, 9  
Setting the temperature, 9  
Setting the Delay Start, 9  
Functions, 9

#### **Detergents and laundry, 10**

Detergent dispenser, 10  
Bleach cycle, 10  
Preparing your laundry, 10  
Special items, 10  
Woolmark Platinum Care, 10

#### **Precautions and advice, 11**

General safety, 11  
Disposal, 11  
Saving energy and respecting the environment, 11

#### **Care and maintenance, 12**

Cutting off the water or electricity supply, 12  
Cleaning your appliance, 12  
Caring for your appliance door and drum, 12  
Cleaning the pump, 12  
Checking the water inlet hose, 12

#### **Troubleshooting, 13**

#### **Service, 17**

# Installation

GB

! Keep this instruction manual in a safe place for future reference. Should the appliance be sold, transferred or moved, make sure the instruction manual accompanies the washing machine to inform the new owner as to its operation and features.

! Read these instructions carefully: they contain vital information on installation, use and safety.

## Unpacking and levelling

### Unpacking

1. Unpack the washing machine.
2. Check whether the washing machine has been damaged during transport. If this is the case, do not install it and contact your retailer.

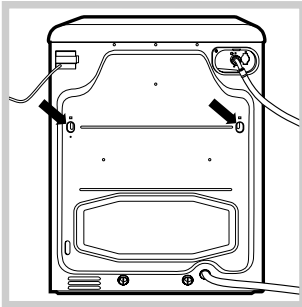

3. Remove the 2 protective screws and the rubber washer with the respective spacer, situated on the rear of the appliance (*see figure*).

4. Seal the gaps using the plastic plugs provided.
5. Keep all the parts: you will need them again if the washing machine needs to be moved to another location.

! Packaging materials are not children's toys.

### Levelling

Your machine may make a considerable amount of noise if the two front feet have not been adjusted correctly.

1. Install the washing machine on a flat sturdy floor, without resting it up against walls, furniture cabinets or other.

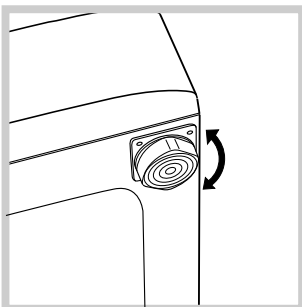

2. If the floor is not perfectly level, compensate for any unevenness by tightening or loosening the adjustable feet (*see figure*), the angle of inclination, measured according to the worktop, must not exceed 2°.

Levelling your appliance correctly will provide it with stability and avoid any vibrations, noise and shifting during operation. If it is placed on a fitted or loose carpet, adjust the feet in such a way as to allow enough room for ventilation beneath the washing machine.

## Electric and water connections

### Connecting the water inlet hose

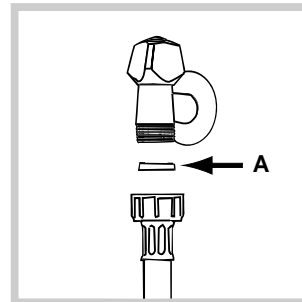

1. Insert seal A into the end of the inlet hose and screw the latter onto a cold water tap with a 3/4 gas threaded mouth (*see figure*). Before making the connection, allow the water to run freely until it is perfectly clear.

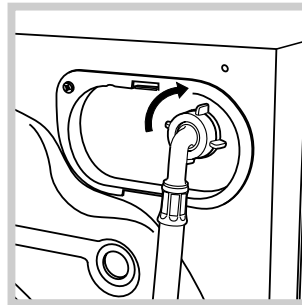

2. Connect the other end of the water inlet hose to the washing machine, screwing it onto the appliance's cold water inlet, situated on the top right-hand side on the rear of the appliance (*see figure*).

3. Make sure there are no kinks or bends in the hose.

! The water pressure at the tap must be within the values indicated in the Technical details table (*on the next page*).

! If the water inlet hose is not long enough, contact a specialist store or an authorised serviceman.

### Connecting the drain hose

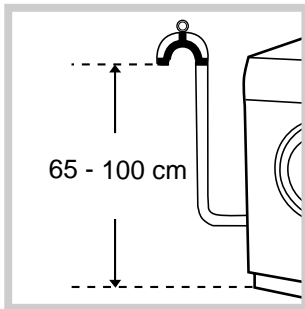

Connect the drain hose, without bending it, to a draining duct or a wall drain situated between 65 and 100 cm from the floor;

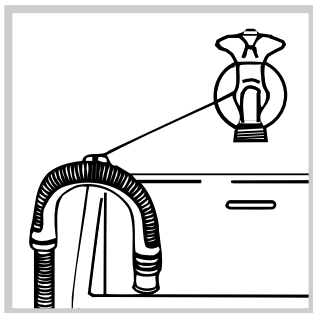

alternatively, place it over the edge of a basin, sink or tub, fastening the duct supplied to the tap (see figure). The free end of the hose should not be underwater.

! We advise against the use of hose extensions; in case of absolute need, the extension must have the same diameter as the original hose and must not exceed 150 cm in length.

### Electric connection

Before plugging the appliance into the mains socket, make sure that:

- the socket is earthed and in compliance with the applicable law;
- the socket is able to sustain the appliance's maximum power load indicated in the Technical details table (see page 5);
- the supply voltage is included within the values indicated on the Technical details table (see page 5);
- the socket is compatible with the washing machine's plug. If this is not the case, replace the socket or the plug.

Your appliance is now supplied with a 13 amp fused plug it can be plugged into a 13 amp socket for immediate use. Before using the appliance please read the instructions below.

**WARNING - THIS APPLIANCE MUST BE EARTHED. THE FOLLOWING OPERATIONS SHOULD BE CARRIED OUT BY A QUALIFIED ELECTRICIAN.**

#### Replacing the fuse:

When replacing a faulty fuse, a 13 amp ASTA approved fuse to BS 1362 should always be used, and the fuse cover re-fitted. If the fuse cover is lost, the plug must not be used until a replacement is obtained.

#### Replacement fuse covers:

If a replacement fuse cover is fitted, it must be of the correct colour as indicated by the coloured marking or the colour that is embossed in words on the base of the plug. Replacements can be obtained directly from your nearest Service Depot.

#### Removing the plug:

If your appliance has a non-rewireable moulded plug and you should wish to re-route the mains cable through partitions, units etc., please ensure that either:

the plug is replaced by a fused 13 ampere re-wearable plug bearing the BSI mark of approval.

or:  
the mains cable is wired directly into a 13 amp cable outlet, controlled by a switch, (in compliance with BS 5733) which is accessible without moving the appliance.

#### Disposing of the plug:

Ensure that before disposing of the plug itself, you make the pins unusable so that it cannot be accidentally inserted into a socket.

Instructions for connecting cable to an alternative plug:  
Important: the wires in the mains lead are coloured in accordance with the following code:

<b>Green &amp; Yellow</b>	<b>Earth</b>
<b>Blue</b>	<b>Neutral</b>
<b>Brown</b>	<b>Live</b>

As the colours of the wires in the lead may not correspond with the coloured markings identifying the terminals in your plug, proceed as follows:  
Connect Green & Yellow wire to terminal marked **E** or  $\perp$  or coloured Green or Green & Yellow.  
Connect Brown wire to terminal marked **L** or coloured Red.  
Connect Blue wire to terminal marked **N** or coloured Black.

GB

Installation

Description

Programmes

Detergents

Precautions

Care

Troubleshooting

Service

If a 13 amp plug (BS 1363) is used it must be fitted with a 13 amp fuse, either in the plug or adaptor or at the distribution board.

If you are in any doubt the electrical supply to your machine, consult a qualified electrician before use.

How to connect an alternative plug:

The wires in this mains lead are coloured in accordance with the following code:

<b>BLUE</b>	<b>NEUTRAL (N)</b>
<b>BROWN</b>	<b>LIVE (L)</b>
<b>GREEN &amp; YELLOW</b>	<b>EARTH (E)</b>

*Disposing of the appliance:*

When disposing of the appliance please remove the plug by cutting the mains cable as close as possible to the plug body and dispose of it as described above.

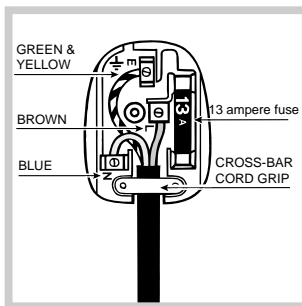

! The washing machine should not be installed in an outdoor environment, not even when the area is sheltered, because it may be very dangerous to leave it exposed to rain and thunderstorms.

! When the washing machine is installed, the mains socket must be within easy reach.

! Do not use extensions or multiple sockets.



! The power supply cable must never be bent or dangerously compressed.

! The power supply cable must only be replaced by an authorised serviceman.

Warning! The company denies all liability if and when these norms are not respected.

## The first wash cycle

Once the appliance has been installed, and before you use it for the first time, run a wash cycle with detergent and no laundry, setting the 90°C programme without a pre-wash cycle.

Technical details	
<b>Model</b>	ET 1400
<b>Dimensions</b>	68,6 cm wide 100 cm high 72,5 cm deep
<b>Capacity</b>	from 1 to 9 kg
<b>Electric connections</b>	voltage 230/240 Volts 50 Hz maximum absorbed power 2500 W
<b>Water connections</b>	maximum pressure 1 MPa (10 bar) minimum pressure 0.05 MPa (0.5 bar) drum capacity 87 litres
<b>Spin speed</b>	up to 1400 rpm
<b>Control programmes according to IEC456 directive</b>	programme C; temperature 60°C; run with a load of 9 kg.
 	<p>This appliance is compliant with the following European Community Directives:</p> <ul style="list-style-type: none"> <li>- 73/23/CEE of 19/02/73 (Low Voltage) and subsequent amendments - 89/336/CEE of 03/05/89 (Electromagnetic Compatibility) and subsequent amendments</li> <li>- 2002/96/CE</li> </ul>

# Washing machine description

## Control panel

GB

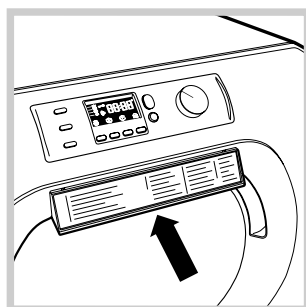
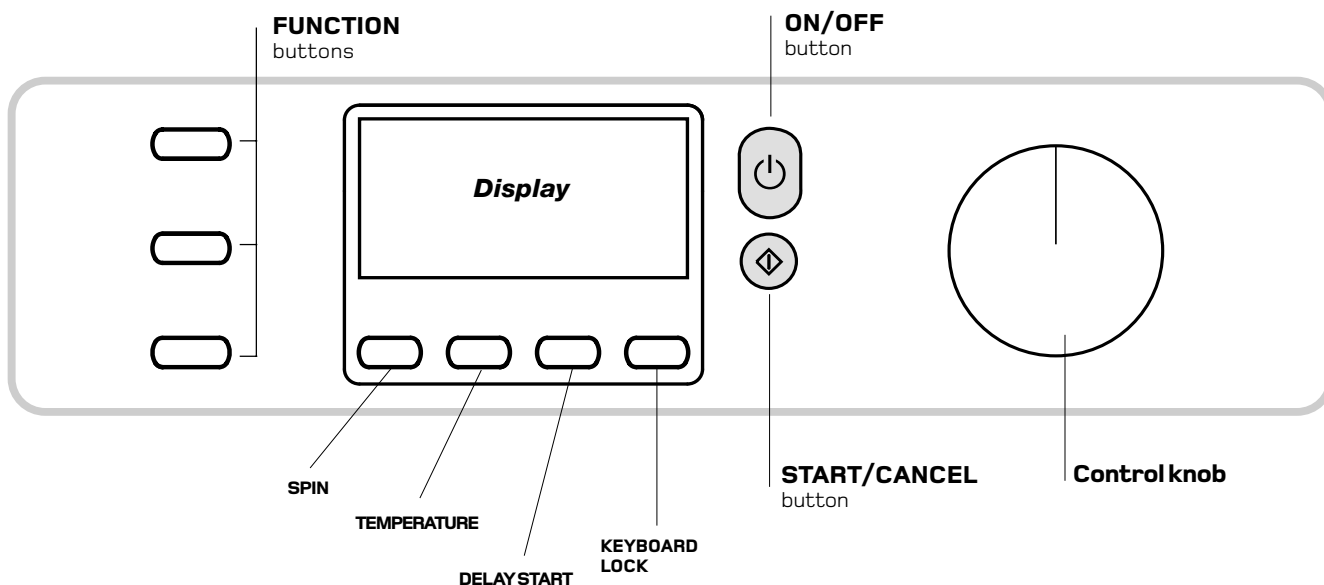

**Programme key:** to consult a straightforward chart of the different programmes available turn the lower part outwards to open it.

**FUNCTION** buttons to select the functions available. The button corresponding to the function selected will remain on.

**SPIN** button to adjust the spin speed or exclude it altogether (see page 9).

**TEMPERATURE** button to adjust the wash temperature (see page 9).

**DELAY START** button to delay the start of the set programme for a maximum period of 24 hours (see page 9).

**KEYBOARD LOCK** key. To lock all the keys on the washing machine during operation or during Stand-by mode.

**Display** to programme the washing machine and follow the wash cycle progress (see opposite page).

**ON/OFF** button to turn the washing machine on and off (see page 8).

**START/CANCEL** button to start the programmes or cancel any incorrect settings (see page 8).  
*N.B.: For safety reasons (eg. to avoid children climbing into the drum), if there is no electricity for more than two minutes the washing machine will not restart unless the START/CANCEL button is pressed.*

**Control knob** to select the wash programmes. The knob stays still during the cycle.



## Display

In addition to being a practical tool to programme your appliance (see page 9), the display provides useful information concerning the wash cycle and status.

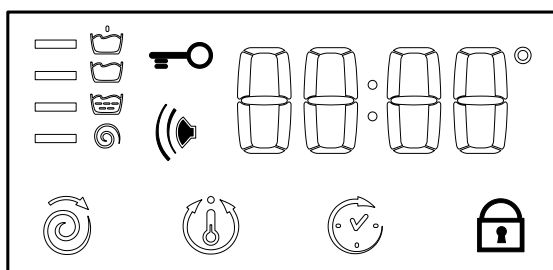
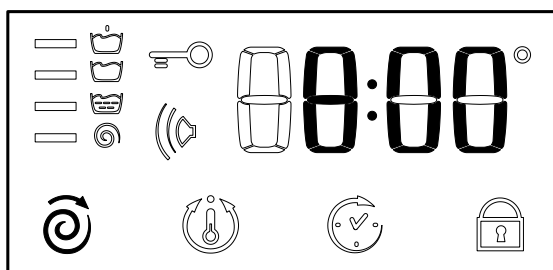
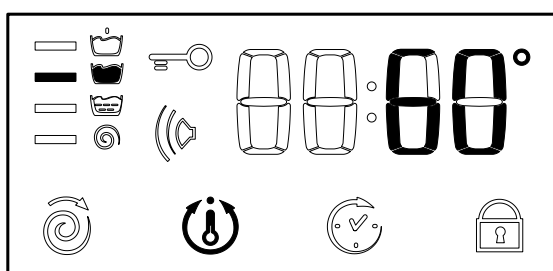
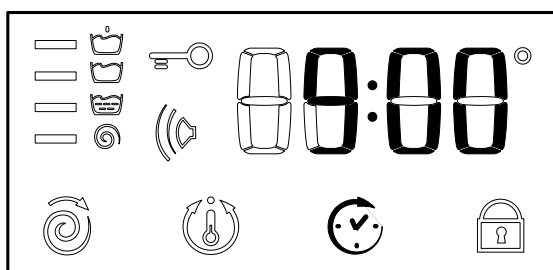

### **Keyboard lock:**

For your safety and that of your children, you can block all the keys during the machine's operation or during waiting position (delayed start - Stand-by) by pressing the function key for 2 seconds. To disable this function, hold the same button down for 4 seconds.

### **Door lock:**

If the symbol is on, the washing machine door is locked to prevent it from being opened accidentally. To avoid any damages, wait for the symbol to switch itself off before you open the appliance door. This model is equipped with a device that enables the door to be opened during the course of the wash cycle (however, this is only an option in phases where the safety conditions are guaranteed). To carry out this task, switch off the machine (by pressing the ON/OFF button), open the door, load the necessary clothes or detergent, close it again, switch the machine back on by pressing the ON/OFF button and press the START/CANCEL button. The machine will restart the wash cycle from the point at which it was interrupted.





At the end of the programme, the word END is displayed.

! In the event of an anomaly, an error code will appear, such as: F-01 (see page 13).

Once you have pressed the START/CANCEL button to start the programme, the display will indicate the amount of time left until the end of the wash cycle. If a delayed start has been set (using the Delay Start, see page 9), the delay time will be indicated on the display.

The following information is displayed during the wash cycle:

### **Cycle phase under way:**

-  Pre-wash
-  Wash cycle
-  Rinse
-  Spin cycle

### **Customised functions and options:**

To select functions and options, see below and on page 9.



### **Buzzer:**

Your washing machine comes with a buzzer, which will inform you of the various functions being carried out, or of any malfunctions: incompatibility, option/programme keys, start, end of cycle, reset.



# Starting and Programmes

GB

## Briefly: starting a programme

- Turn the washing machine on by pressing button . All the icons will light up for a few seconds and then go off.
- Add the detergent and any fabric softener (*see page 10*).
- Load your laundry into the washing machine (*see page 10*) and shut the appliance door.
- Set the knob to the desired programme. The estimated duration of the selected programme is displayed. The temperature and spin speed are automatically set according to the programme (to change them, *see page 9*).
- Select any function (*see page 9*).
- Start the programme by pressing the START/CANCEL button. To cancel it, keep the START/CANCEL button pressed for at least 2 seconds.
- When the programme has ended, the word END is displayed. Take out your laundry and leave the appliance door ajar to allow the drum to dry thoroughly. If you wish to start a new wash cycle, the door must be opened and shut for safety reasons before the START/CANCEL button is pressed again.
- Turn the washing machine off by pressing button .

## Programme table

Type of fabric and degree of soil	Progr.	Wash temp.	Detergent		Fabric softener	Max. Load (Kg.)	Cycle length (minutes)	Description of wash cycle
			Pre-wash	Wash				
<b>Standard</b>								
<b>Cotton:</b> Extremely soiled whites (sheets, tablecloths, etc.)	<b>A</b>	90°C	•	•	•	<b>9</b>	160	Pre-wash, wash cycle, rinse cycles, intermediate and final spin cycles
<b>Cotton:</b> Extremely soiled whites (sheets, tablecloths, etc.)	<b>B</b>	90°C		•	•	<b>9</b>	145	Wash cycle, rinse cycles, intermediate and final spin cycles
<b>Cotton:</b> Heavily soiled whites and fast colours	<b>C</b>	60°C		•	•	<b>9</b>	125	Wash cycle, rinse cycles, intermediate and final spin cycles
<b>Cotton:</b> Slightly soiled whites and delicate colours (shirts, jumpers, etc.)	<b>D</b>	40°C		•	•	<b>9</b>	90	Wash cycle, rinse cycles, intermediate and final spin cycles
<b>Synthetics:</b> Heavily soiled fast colours (baby linen, etc.)	<b>E</b>	50°C		•	•	<b>4</b>	90	Wash cycle, rinse cycles and delicate spin cycle
<b>Synthetics:</b> Fast colours (all types of slightly soiled garments)	<b>F</b>	40°C		•	•	<b>4</b>	75	Wash cycle, rinse cycles and delicate spin cycle
<b>Synthetics:</b> Delicate colours (all types of slightly soiled garments)	<b>G</b>	30°C		•	•	<b>4</b>	30	Wash cycle, rinse cycles and delicate spin cycle
<b>Delicates</b>								
Wool	<b>H</b>	40°C		•	•	<b>3</b>	60	Wash cycle, rinse cycles and delicate spin cycle
Very delicate fabrics (curtains, silk, viscose, etc.)	<b>J</b>	30°C		•	•	<b>3</b>	80	Wash cycle, rinse cycles, anti-crease
<b>Big Size Load</b>								
Bed & Bath	<b>K</b>	60°C		•	•	<b>6,5</b>	90	Wash cycle, rinse cycles, intermediate and final spin cycles
Feather Duvets	<b>L</b>	30°C		•	•	<b>4</b>	75	Wash cycle, rinse cycles, anti-crease intermediate and final spin cycles
Synthetic Duvets	<b>M</b>	30°C		•	•	<b>4</b>	65	Wash cycle, rinse cycles, anti-crease intermediate and final spin cycles
Woollen Blankets	<b>N</b>	40°C		•	•	<b>4</b>	70	Wash cycle, rinse cycles, intermediate and final spin cycles
<b>Specials</b>								
Rinse					•			Rinse cycles and spin cycle
Spin								Draining and spin cycle
Drain								Draining

## Notes

- To ensure the machine operates correctly and is able to achieve the best possible washing performance, we recommend that the maximum load indicated is not exceeded.
- For the anti-crease function: see Easy iron, *opposite page*. The information contained in the table is purely indicative.

## Daily Wash - 30mins.

Programme G for Synthetics is designed to wash lightly soiled garments in a short amount of time: it only lasts 30 minutes and allows you to save on both time and energy. By setting this programme (G at 30°C), you can wash different fabrics together (except for woollen and silk items), with a maximum load of 4 kg (*see page 10*).  
We recommend the use of liquid detergent.

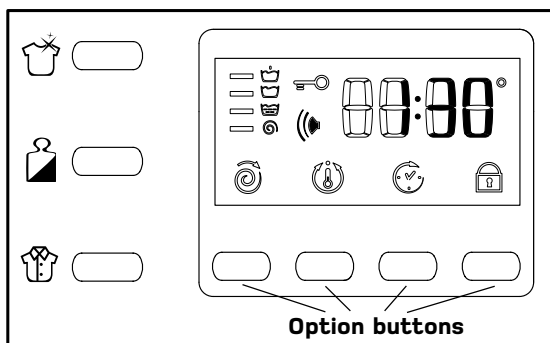

## Setting the spin cycle

If, when the appliance is switched on, the KNOB is positioned on a programme with a spin cycle, a fixed appears. Press button and the maximum spin speed allowed for the programme set will be displayed, and the icon flashes. Press it again and the values lower until they reach OFF, which indicates that the spin cycle has been excluded (press it again to go back to the maximum value); stop on the desired speed, after approximately 2 seconds the setting is accepted: the symbol remains fixed. The spin cycle setting is enabled with all the programmes except for J and the Draining cycle.

## Setting the temperature

If, when the appliance is switched on, the KNOB is positioned on a programme for which the temperature needs to be regulated, a fixed appears. Press button and the maximum temperature allowed for the programme set will be displayed and the icon flashes. Press it again and the temperature lowers until it reaches OFF, which indicates a cold wash cycle (press it again to go back to the maximum value); stop on the desired value, after approximately 2 seconds the setting is accepted: the symbol remains fixed. The temperature adjustment is enabled with all wash programmes.

## Setting the Delay Start

Press the button and you will see the word OFF on the display, while the relative symbol flashes. Press the button again and "1h" appears, that is, a delay of one hour (this can reach up to 24h); stop on the "desired" delay; after approximately 2 seconds the setting is accepted, following which, the time for the set programme appears on the display and the symbol remains on.

If you now press the START/CANCEL button, the set "delay" appears; this decreases every hour until the start of the cycle. In this phase, the "delay" can only be modified by decreasing it.

The Delay Start regulation is enabled with all programmes.

For safety reasons (for example: preventing children from climbing into the drum and locking themselves in), if the door is opened or closed before the effective start of the cycle, it will be necessary to press the START/CANCEL button again.

## Keyboard Lock *(see page 7)*

## Functions

To enable a function:

1. press the button corresponding to the desired function, according to the table below;
2. the function is enabled when the corresponding button is illuminated.

Note: The rapid flashing of the button indicates that the corresponding function cannot be selected for the programme set.

If you set a function that is incompatible with another function you selected previously, only the last one selected will be enabled.

Function	Effect	Comments	Enabled with programmes:
<b>Super Wash</b>	Allows for an impeccable wash, visibly whiter than a standard <i>Class A</i> wash.		<b>A, B, C, D, E, F, K</b>
<b>Mini Load</b>	Reduces water and energy consumption and wash cycle times.	Use this function when the laundry that needs to be washed is equal to or less than half the recommended max. load <i>(see Programme table)</i> . Reduce the amount of detergent accordingly.	<b>A, B, C, D, E, F, H, K, L, M, Rinse cycle.</b>
<b>Easy Iron</b>	This option reduces the amount of creasing on fabrics, making them easier to iron.	If you set this option, programmes E, F, J, L, M will be suspended, leaving the laundry to soak (Anti-crease) and EASY IRON button will flash: - to conclude the cycle, press the START/CANCEL button or the EASY IRON button; - to run the draining cycle alone, set the knob to the relative symbol  and press the START/CANCEL button.	<b>C, D, E, F, J, K, L, M, Rinse cycle.</b>

GB

Installation

Description

Programmes

Detergents

Precautions

Care

Troubleshooting

Service

# Detergents and laundry

GB

## Detergent dispenser

Good washing results also depend on the correct dose of detergent: adding too much detergent won't necessarily make for a more efficient wash, and may in fact cause build up on the interior of your appliance and even pollute the environment.

The detergent dispenser is located inside the tub; to access it the door must be opened.

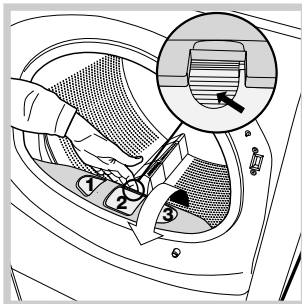
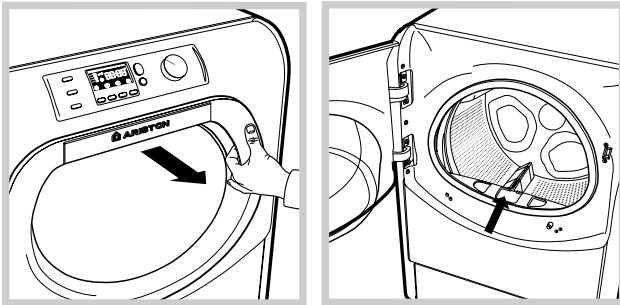

Open up the detergent dispenser (see figure) and pour in the detergent and fabric softener, as follows.

**compartment 1: Detergent for pre-wash (or bleach if carrying out the bleach cycle)**

**compartment 2: Detergent for the wash cycle**

**compartment 3: Additives (fabric softeners, etc.)**

! When closing the door, the detergent dispenser closes automatically.

! Do not use hand wash detergent because it may form too much foam.

## Preparing your laundry

! Unfold all garments completely before placing them inside the washing machine.

- Divide your laundry according to:
  - the type of fabric/the symbol on the label.
  - the colours: separate coloured garments from whites.
- Empty all pockets and check for loose buttons.
- Do not exceed the weight limits stated below, which refer to the weight when dry:

Sturdy fabrics: max 9 kg  
Synthetic fabrics: max 4 kg  
Delicate fabrics: max 3 kg  
Wool (Clothing): max 3 kg  
Wool (Blankets): max 4 kg

## How much does your laundry weigh?

1 sheet 400-500 g  
1 pillow case 150-200 g  
1 tablecloth 400-500 g  
1 bathrobe 900-1200 g  
1 towel 150-250 g

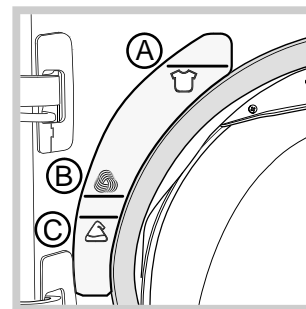

! Do not exceed the maximum load level of your laundry for each type of fabric, as indicated on the label in the internal part of the door (see figure).

A = Cotton  
B = Wool  
C = Synthetics

## Special items

**Curtains:** fold curtains and place them in a pillow case or mesh bag. Wash them separately without exceeding half the appliance load. Use programme J which excludes the spin cycle automatically.

**Trainers:** remove any mud. They can be washed together with jeans and other tough garments, but not with whites.



## Woolmark Platinum Care



### As gentle as a hand wash.

Hotpoint is the only washing machine to have obtained the prestigious Woolmark Platinum Care Plus mark of recognition (M.0505) from The Woolmark Company, the organisation that certifies the machine washing of all woollen garments.

Programme no. H - Wool - can even be used to wash garments whose labels specify "hand wash only" , and guarantees optimum performance levels while providing complete fabric care.

Programme no. N - Woollen blankets - can be used to wash large items made using pure virgin wool (not pile), for example blankets, quilts, etc. The programme also enables products of this type whose labels specify "dry clean only"   to be washed, and offers the best performance levels while guaranteeing complete fabric care. You should, however, check that the description "machine washable"  is present on the label of any items made using pile before washing them in the machine.

! The washing machine was designed and built in compliance with the applicable international safety regulations. The following information is provided for your safety and should consequently be read carefully.

## General safety

- This washing machine should only be used by adults and in accordance with the instructions provided in this manual.
- Never touch the washing machine when barefoot or with wet or damp hands or feet.
- Do not pull on the power supply cable to unplug the appliance from the electricity socket. Pull the plug out yourself.
- Do not touch the drain water as it could reach very high temperatures.
- Never force the washing machine door: this could damage the safety lock mechanism designed to prevent any accidental openings.
- In the event of a malfunction, do not under any circumstances touch internal parts in order to attempt repairs.
- Always keep children well away from the appliance while in operation.
- The appliance door tends to get quite hot during the wash cycle.
- Should it have to be moved, proceed with the help of two or three people and handle it with the utmost care. Never try to do this alone, because the appliance is very heavy.
- Before loading your laundry into the washing machine, make sure the drum is empty.
- Before starting the cycle, make sure the level of maximum load of your laundry is respected.

## Disposal

- Disposing of the packaging material: observe local regulations, so the packaging can be re-used.
- The European Directive 2002/96/EC on Waste Electrical and Electronic Equipment, requires that old household electrical appliances must not be disposed of in the normal unsorted municipal waste stream. Old appliances must be collected separately in order to optimise the recovery and recycling of the materials they contain and reduce the impact on human health and the environment. The crossed out "wheeled bin" symbol on the product reminds you of your

obligation, that when you dispose of the appliance it must be separately collected.

Consumers should contact their local authority or retailer for information concerning the correct disposal of their old appliance.

## Saving energy and respecting the environment

### Environmentally-friendly technology

If you only see a little water through your appliance door, this is because thanks to the latest Ariston technology, your washing machine only needs less than half the amount of water to get the best results: an objective reached to respect the environment.

### Saving on detergent, water, energy and time

- To avoid wasting resources, the washing machine should be used with a full load. A full load instead of two half loads allows you to save up to 50% on energy.
- The pre-wash cycle is only necessary on extremely soiled garments. Avoiding it will save on detergent, time, water and between 5 and 15% energy.
- Treating stains with a stain remover or leaving them to soak before washing will cut down the need to wash them at high temperatures. A programme at 60°C instead of 90°C or one at 40°C instead of 60°C will save up to 50% on energy.
- Use the correct quantity of detergent depending on the water hardness, how soiled the garments are and the amount of laundry you have, to avoid wastage and to protect the environment: despite being biodegradable, detergents do contain ingredients that alter the natural balance of the environment. In addition, avoid using fabric softener as much as possible.
- If you use your washing machine from late in the afternoon until the early hours of the morning, you will help reduce the electricity board's peak load. The Delay Start option (*see page 9*) helps to organise your wash cycles accordingly.
- If your laundry has to be dried in a tumble dryer, select a high spin speed. Having the least water possible in your laundry will save you time and energy in the drying process.

GB

Installation

Description

Programmes

Detergents

Precautions

Care

Troubleshooting

Service

# Care and maintenance

GB

## Cutting off the water or electricity supply

- Turn off the water tap after every wash. This will limit the wear of your appliance's water system and also prevent leaks.
- Unplug your appliance when cleaning it and during all maintenance operations.

## Cleaning your appliance

The exterior and rubber parts of your appliance can be cleaned with a soft cloth soaked in lukewarm soapy water. Do not use solvents or abrasives.

## Caring for your appliance door and drum

- Always leave the appliance door ajar to prevent unpleasant odours from forming.

## Cleaning the pump

The washing machine is fitted with a self-cleaning pump that does not require any maintenance. Sometimes, small items (such as coins and buttons) may fall into the pre-chamber that protects the pump, situated in the lower part of the same.

! Make sure that the wash cycle has ended and unplug the appliance.

To access the pre-chamber:

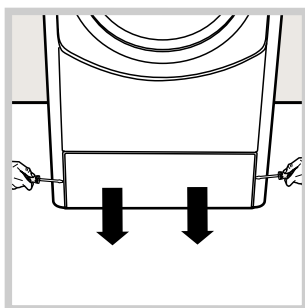

1. remove the cover panel (in the lower front of the washing machine), prizing it on both sides with a screwdriver. Do not force it.

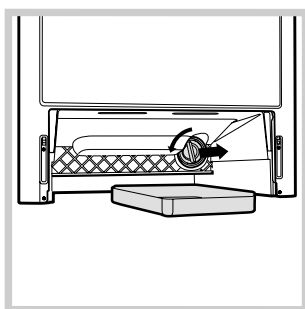

2. unscrew the lid rotating it in anti-clockwise. A little water may trickle out (about 1 liter). Put a little container under the hole.
3. clean the interior thoroughly.
4. screw the lid back on.

5. reposition the panel, making sure the hooks are securely in place before you push it onto the appliance.

## Checking the water inlet hose

Check the water inlet hose at least once a year. If you see any cracks, replace it immediately: during the wash cycles, water pressure is very strong and a cracked hose could easily split open.

! Never use hoses that have already been used.

Your washing machine could fail to work. Before calling for Assistance (*see pages 17-18*), make sure the problem can't easily be solved by consulting the following list.

## Problem

### The washing machine won't start.

### The wash cycle won't start.

### The washing machine fails to load water (The wording H2O is displayed).

### The washing machine continuously loads and unloads water.

### The washing machine does not drain or spin.

### The washing machine vibrates too much during the spin cycle.

### The washing machine leaks.

### The machine is locked and the display flashes, indicating an error code (e.g. F-01, F-..).

### There is too much foam.

## Possible causes/Solution:

- The appliance is not plugged into the socket, or not enough to make contact.
- There has been a power failure.
- The appliance door is not shut properly (the word DOOR is displayed).
- The  button has not been pressed.
- The START/CANCEL button has not been pressed.
- The water tap is not turned on.
- A delayed start has been set (using the Delay Start, *see page 9*).
- The water inlet hose is not connected to the tap.
- The hose is bent.
- The water tap is not turned on.
- There is a water shortage.
- The water pressure is insufficient.
- The START/CANCEL button has not been pressed.
- The drain hose is not fitted between 65 and 100 cm from the floor (*see page 3*).
- The free end of the hose is underwater (*see page 3*).
- The wall drainage system doesn't have a breather pipe.

If the problem persists even after these checks, turn off the water tap, switch the appliance off and call for Assistance. If the dwelling is on one of the upper floors of a building, there may be drain trap problems causing the washing machine to load and unload water continuously. In order to avoid such an inconvenience, special anti-drain trap valves are available in shops.

- The programme does not foresee the draining: some programmes require enabling the draining manually (*see page 8*).
- The Easy iron option is enabled: to complete the programme, press the START/CANCEL button (*see page 9*).
- The drain hose is bent (*see page 3*).
- The drain duct is clogged.
- When the machine is installed, the locking screws for the oscillating assembly are still in place. Remove the screws (*see page 2*).
- The washing machine is not level (*see page 2*).
- The washing machine is closed in between furniture cabinets and the wall (*see page 2*).
- The water inlet hose is not screwed on correctly (*see page 2*).
- The detergent dispenser is obstructed.
- The drain hose is not secured properly (*see page 3*).
- Switch off the machine and unplug the appliance; wait for approximately 1 minute then switch it on again. If the problem persists, contact Assistance.
- The detergent is not suitable for machine washing (it should bear the definition "for washing machines" or "hand and machine wash", or the like).
- You used too much detergent.

GB

Installation

Description

Programmes

Detergents

Precautions

Care

Troubleshooting

Service









## IMPORTANT INFORMATION – Please Read Carefully

This appliance is designed for domestic use only.

We may be able to offer service cover under our 12-month guarantee for this appliance provided that we are satisfied that it has:

- Not been used to generate revenue.
- Not been used on premises where the total number of rooms serviced by it exceeds 15.
- Only been installed and operated in accordance with the manufacturer's handbook.
- Been properly connected to a suitable electrical supply as stated on the rating plate on the appliance.
- Only been used in premises situated within the United Kingdom or Republic of Ireland.

The availability of the 12-month guarantee where the appliance is being used in a non-domestic situation is entirely at our discretion.

This appliance is heavier than most domestic washing machines. Our service engineers will use their best endeavours to avoid damage to property or flooring when carrying out either service or repairs. If our engineer is of the opinion that the appliance cannot be moved without damage being caused, then he will only proceed to move the appliance upon your acceptance that we cannot be responsible for any such damage.

We would also remind you of the general exclusions of our guarantee. It does not cover the following:

- 1) No fault found / customer advice given on engineer visit.
- 2) Misuse.
- 3) Accidental damage.
- 4) Malicious damage.
- 5) Rectification of faulty repairs by non authorised personnel.
- 6) Modifications to equipment.
- 7) Connections to gas, electricity, water supplies.
- 8) Moving or re-siting appliances.
- 9) Rectifying problems due to gas, electricity, water supplies.
- 10) Rectifying cosmetic problems – e.g. scratches, dents, surface marks (if these have not been notified to us within 72 hours of delivery).
- 11) Rectifying damage caused by water, fire, frost.
- 12) Trapped or kinked fill and drain hoses.
- 13) Rectifying faulty installations.
- 14) Faults caused by failure to remove all packaging materials – e.g. transit bolts.
- 15) Pumps blocked by extraneous objects – e.g. coins.
- 16) Replacement of consumables.
- 17) Degradation to glass, ceramic and steel surfaces due to normal wear and tear.
- 18) Damage caused by limescale or detergents.
- 19) Routine maintenance and cleaning.

### 5 Year Parts Guarantee

Hotpoint also offers you a free 5 year parts guarantee. This additional guarantee is conditional on you registering your appliance with us and the parts being fitted by one of our authorised engineers. There will be a charge for our engineer's time. To activate the extra parts warranty on your appliance, simply call our registration line on **0870 6092094 (ROI 01 230 0800)**.

### Extended Guarantees

We offer a selection of repair protection plans that enable you to fully cover yourself against the expense of repair bills for the life of your policy. To find the ideal plan for you please call our advice line on **08709 088 088 (ROI 01 230 0233)**.

### Free Helpdesk Service

We have a dedicated team who can provide free advice and assistance with your appliance if you experience any technical difficulties within the first 90 days of ownership. Simply call our Hotpoint Service Hotline on **08709 066 066 (ROI 0818 313 413)** for telephone assistance, or, where necessary, to arrange for an engineer to call. If we cannot resolve the technical problem we will replace your machine or, if you prefer, give you your money back.



## After Sales Service

No one is better placed to care for your Hotpoint appliance during the course of its working life than us - the manufacturer.

## Essential Contact Information

### Hotpoint Service

We are the largest service team in Europe offering you access to 400 skilled telephone advisors and 1100 fully qualified engineers on call to ensure you receive fast, reliable, local service.

**UK: 08709 066 066**

**Republic of Ireland: 0818 313 413**

**[www.hotpointservice.co.uk](http://www.hotpointservice.co.uk)**

**Please note: Our advisors will require the following information:**

**Model number:**

**Serial number:**

### Parts and Accessories

We supply a full range of genuine replacement parts as well as accessory products that protect and hygienically clean your appliance to keep it looking good and functioning efficiently throughout its life.

**UK: 08709 077 077**

**Republic of Ireland: 0818 313 413**

**[www.hotpointservice.co.uk](http://www.hotpointservice.co.uk)**

### Appliance Registration

We want to give you additional benefits of Hotpoint ownership. To activate your free 5 year parts guarantee you must register your appliance with us.

**UK: 0870 6092094**

**Republic of Ireland: 01 230 0800**

**[www.hotpointservice.co.uk](http://www.hotpointservice.co.uk)**

**Indesit Company UK Ltd. Morley Way, Peterborough, PE2 9JB**

**Indesit Company Unit 49 Airways Industrial Estate, Dublin 17**



## Recycling & Disposal Information

As part of Hotpoint's continued commitment to helping the environment, Hotpoint reserves the right to use quality, recycled components to keep down customer costs and minimise material wastage.

Please dispose of packaging and old appliances carefully. To minimise the risk of injury to children, remove the door, plug and cut the mains cable off flush with the appliance. Dispose of these parts separately to ensure that the appliance can no longer be plugged into a mains socket, and the door cannot be locked shut.

## Free Manuals Download Website

<http://myh66.com>

<http://usermanuals.us>

<http://www.somanuals.com>

<http://www.4manuals.cc>

<http://www.manual-lib.com>

<http://www.404manual.com>

<http://www.luxmanual.com>

<http://aubethermostatmanual.com>

Golf course search by state

<http://golfingnear.com>

Email search by domain

<http://emailbydomain.com>

Auto manuals search

<http://auto.somanuals.com>

TV manuals search

<http://tv.somanuals.com>