

HP 70100A POWER METER

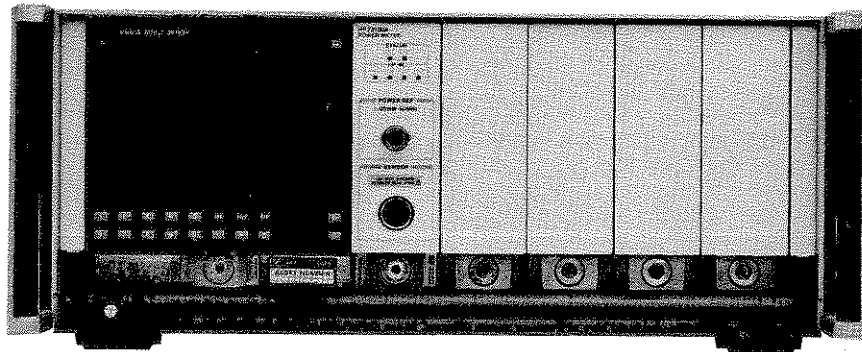

HP Part No. 70100-90001
Edition 1 E0489
HP Binder Part No. 9282-1077



HP 70100A POWER METER

SERIAL NUMBERS

This manual applies directly to instruments with serial numbers prefixed 2844A and above.

For additional important information about serial numbers, see "Instruments Covered By This Manual" in Chapter 1.



**HEWLETT
PACKARD**

© Copyright HEWLETT-PACKARD COMPANY 1989
1501 PAGE MILL ROAD, PALO ALTO, CALIFORNIA, U.S.A.

OPERATING AND PROGRAMMING MANUAL PART NO. 70100-90001

Edition 1 E0489

HP Binder Part No. 9282-1077

Microfiche Operating and Programming Manual Part No. 70100-90003

Service Manual Part No. 70100-90002

Microfiche Service Manual Part No. 70100-90004

CERTIFICATION

Hewlett-Packard Company certifies that this product met its published specifications at the time of shipment from the factory. Hewlett-Packard further certifies that its calibration measurements are traceable to the United States National Bureau of Standards, to the extent allowed by the Bureau's calibration facility, and to the calibration facilities of other International Standards Organization members.

WARRANTY

This Hewlett-Packard instrument product is warranted against defects in material and workmanship for a period of one year from date of shipment. During the warranty period, Hewlett-Packard Company will, at its option, either repair or replace products which prove to be defective.

For warranty service or repair, this product must be returned to a service facility designated by HP. Buyer shall prepay shipping charges to HP and HP shall pay shipping charges to return the product to Buyer. However, Buyer shall pay all shipping charges, duties, and taxes for products returned to HP from another country.

HP warrants that its software and firmware designated by HP for use with an instrument will execute its programming instructions when properly installed on that instrument. HP does not warrant that the operation of the instrument, or software, or firmware will be uninterrupted or error free.

LIMITATION OF WARRANTY

The foregoing warranty shall not apply to defects resulting from improper or inadequate maintenance by Buyer, Buyer-supplied software or interfacing, unauthorized modification or misuse, operation outside of the environmental specifications for the product, or improper site preparation or maintenance.

NO OTHER WARRANTY IS EXPRESSED OR IMPLIED. HP SPECIFICALLY DISCLAIMS THE IMPLIED WARRANTIES OF MERCHANTABILITY AND FITNESS FOR A PARTICULAR PURPOSE.

EXCLUSIVE REMEDIES

THE REMEDIES PROVIDED HEREIN ARE BUYER'S SOLE AND EXCLUSIVE REMEDIES. HP SHALL NOT BE LIABLE FOR ANY DIRECT, INDIRECT, SPECIAL, INCIDENTAL, OR CONSEQUENTIAL DAMAGES, WHETHER BASED ON CONTRACT, TORT, OR ANY OTHER LEGAL THEORY.

ASSISTANCE

Product maintenance agreements and other customer assistance agreements are available for Hewlett-Packard products.

For any assistance, contact your nearest Hewlett-Packard Sales and Service Office. Addresses are provided at the back of this manual.

Contents

Chapter 1

General Information

	Page
Introduction	1-1
Instruments Covered By This Manual	1-1
Manual Changes Supplement	1-1
Printing Conventions	1-1
Description of the HP 70100A Power Meter	1-2
Front Panel	1-2
Front-Panel LEDs	1-2
Front-Panel Connectors	1-3
Rear Panel	1-4
Rear-Panel Connectors	1-4
Mainframe/Module Interconnect	1-4
HP 70100A Power Meter Firmware	1-4
Options	1-5
W30 Service Option	1-5
Module/Instrument Options	1-5
HP 70001A Mainframe Options	1-5
HP 70206A System Graphics Display Options	1-5
HP 70100A Power Meter Options	1-5
Accessories	1-5
Power Sensor Cables	1-5
Rear Fan Filter	1-6
Display Screen Cleaner	1-6
Operating Requirements	1-6
Physical Requirements	1-6
Line Voltage Selection	1-7
Fuse Replacement	1-7
400 Hz Option	1-8
Power Cables	1-8
Operating Environment	1-9
Initial Inspection and Setup	1-11
Inspection	1-11
Front Handle Removal and Replacement	1-11
Rack-Mounting	1-13
Rack-Mounting With Slides	1-13
Connecting Instrument Cabinets	1-13
Storage and Shipment	1-15
Environment	1-15
Packaging	1-15
Electrostatic Discharge Information	1-18
Reducing Damage Caused By ESD	1-18
PC Board Assemblies and Electronic Components	1-18
Test Equipment	1-19
Static-Safe Accessories	1-19

Chapter 2

Installation

	Page
Initial Power-On	2-1
Module Installation and Removal	2-2
HP-MSIB/HP-IB Addressing	2-3
Modular Measurement System Terms	2-3
Functional Terms	2-3
Structural Terms	2-3
Address Matrix	2-4
HP-IB Access Area	2-4
Display-Response Area	2-5
Display Communication Capabilities	2-5
Address Switches	2-5
HP 70100A Address Switches	2-6
Display Address Switches	2-6
Soft-Set HP-IB Addresses	2-7

Chapter 3

Specifications

	Page
Specifications vs. Characteristics	3-1
Specifications	3-1
Characteristics	3-1

Chapter 4

Verification

	Page
Introduction	4-1
Performance Tests	4-1
Test Procedures	4-1
Equipment Required	4-1
Installing the HP 70100A	4-2
Displaying the HP 70100A Readings	4-2
Zero Carryover Test	4-3
Instrument Accuracy Test	4-5
Power Reference Level Test	4-8

Chapter 5

Troubleshooting

	Page
Troubleshooting Tools	5-1
Modular Measurement System Terms	5-1
Status Indicators	5-2
Error Indicators	5-2
Active Indicators	5-3
Error Message Reporting	5-3
Error Report Screen	5-3
Display-Disruptive Errors	5-5
HP 70100A Power Meter Self-Test	5-6
Performance Tests	5-7

Chapter 5

(cont'd)

	Page
Display Tests	5-7
HP-MSIB Troubleshooting Utility	5-7
Diagnostic Procedures	5-8
Categorizing Failures	5-8
Troubleshooting From The Front Panel	5-9
Troubleshooting Over HP-IB	5-10
Troubleshooting Catastrophic Failures	5-10
Abnormal CRT Screen	5-10
A blank or distorted CRT display	5-10
CRT blank except for a message written in large block letters	5-11
CRT shows Display ID screen	5-11
Missing User or Menu Screen Softkeys	5-11
Error Lights	5-11
Flashing E (error) letter or ERR (error) light	5-12
The I/O indicator on the HP 70206A System Graphics	
Display is lit	5-12
HP 70001A Mainframe VOLT/TEMP indicator is lit	5-12
HP 70001A Mainframe CURRENT indicator is lit	5-13
HP 70001A Mainframe I/O CHECK indicator is lit	5-13
Error Messages	5-14
Replaceable System Parts	5-18
Ordering Information	5-18
Direct Mail-Order System	5-18
Replaceable Parts Tables	5-19

Chapter 6

Power Meter Functions

	Page
Preparation For Power Meter Operation	6-2
Display Keys Overview	6-3
Calibration Functions (Cal Funcs)	6-7
Overview	6-7
Cal Funcs Detailed Operating Information	6-10
Zero (ZERO)	6-10
Zeroing Procedure	6-10
Calibration (cal)	6-10
Calibration Procedure	6-11
Power Reference (PWR REF)	6-11
Power Reference Procedure	6-12
Sensor Tables(sensor tables)	6-12
Select (SELECT)	6-13
Select Procedure	6-13
Edit/View (edit/view)	6-13
Edit/View Procedure	6-14
Save (SAVE)	6-15
Save Procedure	6-15
Name Table (name table)	6-15
Name Table Procedure	6-15
Delete Line (DELETE LINE)	6-16
Delete Line Procedure	6-16
Exit (EXIT)	6-17
Exit Procedure	6-17

**Chapter 6
(cont'd)**

	Page
Copy From (copy from)	6-17
Copy Procedure	6-18
Clear (clear)	6-18
Clear procedure	6-19
Exit (EXIT)	6-19
Measurement Functions (Meas Funcs)	6-20
Overview	6-20
Meas Funcs Detailed Operating Information	6-24
Frequency (FREQ)	6-24
Frequency Procedure	6-24
Calibration Factor (CALFAC)	6-25
Calibration Factor Procedure	6-25
Offset (offset)	6-25
Offset Procedure	6-26
Duty Cycle (duty cycle)	6-27
Duty Cycle Procedure	6-27
Relative Mode (rel)	6-28
Relative Mode Procedure	6-28
Using the Current Reference	6-29
Changing the Reference Value	6-29
Using the Power Meter Reading as the Reference	6-29
Range (range)	6-30
Range Procedure	6-30
Filter Average (filter avg)	6-31
Filter Average Procedure	6-32
Resolution (display resolu)	6-32
Resolution Procedure	6-33
Limits	6-34
Limits Procedure	6-35
Trigger (trigger)	6-35
Trigger Procedure	6-36
State	6-37
Overview	6-38
State Detailed Operating Information	6-39
Show State (SHOW STATE)	6-39
Show Procedure	6-39
Save State (SAVE STATE)	6-39
Save Procedure	6-39
Recall State (RECALL STATE)	6-40
Recall Procedure	6-40
P State (P STATE On Off)	6-40
P State Procedure	6-40
Power Up (POWER UP IP LAST)	6-40
Power Up Procedure	6-40
Miscellaneous (Misc)	6-41
Overview	6-41
Misc Detailed Operating Information	6-42
Annotation (ANNOTATION)	6-42
Annotation Procedure	6-42
Entry Hold (ENTRY HOLD)	6-42
Entry Hold Procedure	6-44
Service Tests (service tests)	6-44

Chapter 7

Remote Operation and Programming

	Page
Setup Procedures	7-1
Address Switches	7-2
Soft-Set HP-IB Addresses	7-3
Communication with the System	7-4
Executing Remote Commands	7-4
Local and Remote Control	7-4
Initial Program Considerations	7-5
Hewlett-Packard Interface Bus	7-6
HP-IB Compatibility	7-6
Remote Mode	7-8
Local Mode	7-9
Addressing	7-9
Turn-on Default Conditions	7-9
Data Messages	7-10
Receiving the Data Message	7-10
Sending the Data Message	7-11
Receiving the Clear Message	7-13
Receiving the Trigger Message	7-13
Receiving the Remote Message	7-13
Receiving the Local Message	7-15
Receiving the Local Lockout Message	7-16
Receiving the Clear Lockout/Set Local Message	7-16
Receiving the Pass Control Message	7-16
Sending the Require Service Message	7-16
Sending the Status Byte Message	7-17
Event Status Register	7-18
Clearing the Error Message Queue	7-19
Receiving the Abort Message	7-20
HP-IB Syntax and Characteristics Summary	7-20
Calibration Program Example	7-25
Zeroing Program Example	7-26

List of Illustrations

No.		Page
1-1.	HP 70100A Power Meter	1-3
1-2.	Rear Fan Filter	1-6
1-3.	Line Voltage Selection	1-7
1-4.	Line Fuse Removal and Replacement	1-8
1-5.	Front Handle Removal and Rack Mounting	1-12
1-6.	Interconnecting System II Cabinets	1-14
1-7.	Packaging Materials for Mainframe	1-16
1-8.	Packaging Materials for Modules	1-17
1-9.	Static-Safe Workstation	1-18
2-1.	Module Removal/Replacement	2-2
2-2.	Address Matrix	2-4
2-3.	Address Switches — HP 70100A	2-6
2-4.	Address Switches — Display	2-7

List of Illustrations (cont'd)

No.		Page
4-1.	Zero Carryover Test Setup	4-3
4-2.	Instrument Accuracy Test Setup	4-5
4-3.	Power Reference Level Test Setup	4-9
5-1.	Error Report Screen	5-4
5-2.	“MORE ERRORS” Softkey	5-5
5-3.	Power Meter Self Test Menu	5-6
5-4.	Power Meter Self Test Array	5-6
6-1.	HP 70100A Power Meter Main Menu	6-3
6-2.	HP 70100A Menu Tree	6-5
6-3.	Cal Funcs Menu	6-7
6-4.	Cal Menu	6-10
6-5.	Sensor Tables Menu	6-12
6-6.	Edit/View Menu	6-13
6-7.	Name Table Menu	6-15
6-8.	Exit Menu	6-17
6-9.	Copy From Menu	6-18
6-10.	Clear Menu	6-19
6-11.	Meas Funcs Menu	6-20
6-12.	Offset Menu	6-26
6-13.	Duty Cycle Menu	6-27
6-14.	Rel Menu	6-28
6-15.	Range Menu	6-30
6-16.	Filter Avg Menu	6-31
6-17.	Display Resoln Menu (dB)	6-33
6-18.	Display Resoln Menu (Watts)	6-33
6-19.	Limits Menu	6-34
6-20.	Trigger Menu	6-36
6-21.	State Menu	6-38
6-22.	Misc Menu	6-41
6-23.	Power Meter Window (Full Display)	6-43
6-24.	Power Meter Window (Half Display)	6-43
6-25.	Power Meter Window (Quarter Display)	6-44
7-1.	Address Switches — HP 70100A	7-2
7-2.	Status Message Format	7-13
7-3.	The Status Byte and Service Request Mask	7-17
7-4.	Event Status Register and Event Status Enable Register	7-19

List of Tables

No.		Page
1-1.	Power Cables	1-10
3-1.	Specifications	3-2
3-2.	Characteristics	3-3
4-1.	Recommended Test Equipment	4-2
4-2.	Performance Test Record	4-12
5-1.	Primary Error Messages	5-15
5-2.	Secondary Error Messages	5-16
5-3.	Cabinet Interconnect and Rack-Mounting Kits	5-19
5-4.	Interconnection Cables and Accessories	5-19
5-5.	Misscellaneous System-Level Parts	5-20
5-6.	Service Accessories	5-20
6-1.	Power Meter Preset Parameters	6-2
7-1.	Message Reference Table	7-7
7-2.	Status Message Information	7-14
7-3.	Response to a Clear Message (Preset)	7-15
7-4.	Response to a Trigger Message	7-15
7-5.	HP-IB Codes to Parameter Summary	7-21



General Information

Introduction

This chapter contains the following information:

1. Introduction
2. Description of the HP 70100A Power Meter module
3. Options and accessories
4. Operating requirements
5. Initial inspection and setup
6. Packaging
7. Electrostatic discharge (ESD)

Instruments Covered By This Manual

Attached to the lower front panel of the instrument is a serial number plate. The serial number is in the form: 0000A00000. The first four digits and the letter are the serial number prefix. The last five digits are the suffix. The prefix is the same for identical instruments; it changes only when a configuration change is made to the instrument. The suffix however, is assigned sequentially and is different for each instrument. The contents of this manual apply directly to instruments having the serial number prefix(es) listed under SERIAL NUMBERS on the title page.

Manual Changes Supplement

The "Manual Changes Supplement" provides information necessary to update the manual. The supplement is identified with the manual datecode and part number, both of which appear on the manual title page.

Printing Conventions

The conventions listed below are used throughout this manual.

"Hard" keys, keys physically on an instrument, are represented in the following way:

Key [KEY]

Softkeys, keys defined by software or firmware, are represented in the following way:

Softkey **softkey**

Text that appears on the CRT is represented in the following way

Screen text screen text

Description of the HP 70100A Power Meter

The HP 70100A Power Meter is a 1/8 module, programmable single-channel average power meter. The Power Meter is designed to work in an HP 70000 Series mainframe. It has both HP-IB (Hewlett-Packard Interface Bus) and HP-MSIB (Hewlett-Packard Modular System Interface Bus) communication capabilities. However, it doesn't have master or slave capabilities. The Power Meter measures power in the range of -70 to $+44$ dBm over the frequency range of 100 kHz to 50 GHz using the existing Hewlett-Packard 8480 series power sensors. A 1.00 mW 50 MHz power reference is provided at the front panel for calibrating the meter to the power sensor.

The Power Meter displays power in the following modes: dBm, dB relative, watts, and percent relative. The resolution of the display can be set from the front panel. Three levels of display resolution are available: 1.0%, 0.1%, or 0.01% of full scale in linear mode (0.1, 0.01, and 0.001

dB in log mode). The **duty cycle** softkey provides a convenient peak power representation of the measured average power of a rectangular pulsed input signal.

The Power Meter has both manual and automatic ranging. In auto mode the meter automatically selects the appropriate range for measuring the input signal. In manual mode, any one of the five ranges can be selected by the user.

Memory capacity for saving up to ten front panel settings is built into the Power Meter and can be accessed by using the "State" key. The Power Meter also contains memory space for ten tables of sensor specific calibration factors. These tables are accessed using the "Cal Funcs" key. This feature allows the user to make calibrated power measurements without the necessity of entering the calibration factor for each frequency.

The Power Meter also has a **FREQ** (frequency) softkey which allows entry of the frequency of the input signal. Entering a frequency causes the Power Meter to select a sensor-specific calibration factor from previously stored tables. A specific table of calibration factors is selected using the "Cal Funcs" key.

Other Power Meter functions include the following: zeroing, calibration, offsets, automatic or manual filter selection, setting upper and lower display limits, manual triggering, entering frequency vs. calibration factor tables, and invoking a series of internal self-tests and service tests.

Front Panel

Front-Panel LEDs

The front-panel LEDs indicate the status of the HP 70100A Power Meter. The front-panel LEDs should turn on and off while the HP 70100A Power Meter is doing its self-test (for example, at turn-on).

If the ERR (error) LED lights at any time other than during self-test, there is a problem with the HP 70100A Power Meter, or with one of the other components in the system. Conditions that generate an error, such as, PLEASE ZERO, NO SENSOR, OR ENTRY ERROR will cause the LED to light. (Refer to Chapter 5 for more information.)

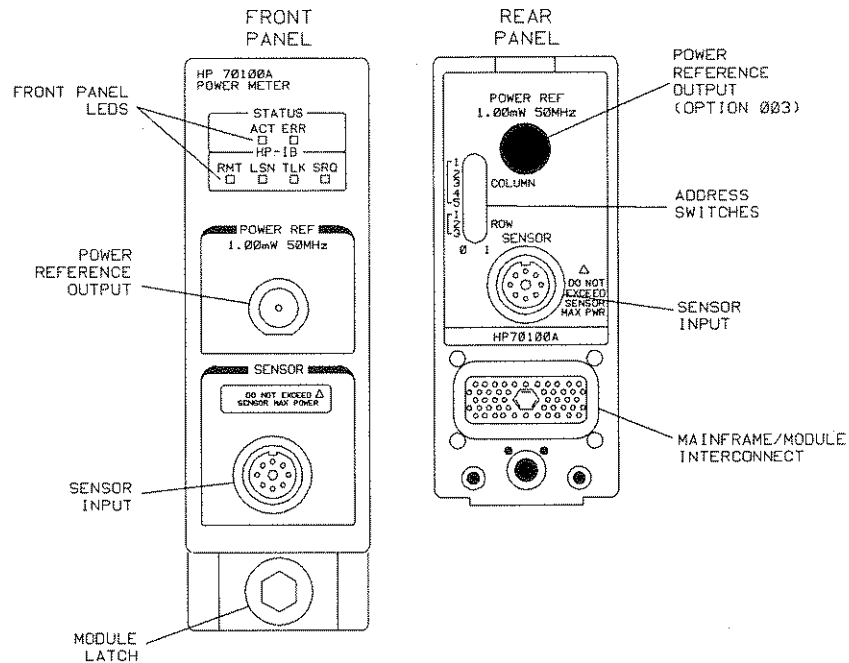

Figure 1-1. HP 70100A Power Meter

The SRQ (service request) LED can be set, over HP-IB, by the user to light when certain conditions occur (for example, an error condition, or completion of an operation). Otherwise, it will only be lit during self-test, when it is turned on and off to test the LED.

The other LEDs, ACT (active), RMT (remote), LSN (listen), TLK (talk), and MEASURE, indicate types of activity that the HP 70100A Power Meter is engaged in, and do **not** indicate an error condition.

Front-Panel Connectors

POWER REF. The POWER REF output on the front panel and on the rear panel (Option 003) require 50 Ω type N male mating connectors. These connectors must be compatible with the specifications of US MIL-C-39012.

Interconnections

The connection from the Power Meter to the power sensor is made through HP 11730 series sensor cables.

Module Latch

An 8 mm hex-ball driver is used to turn the module hex-nut latch for installation of the module in a mainframe. Chapter 2 contains module installation and removal instructions.

Rear Panel

Rear-Panel Connectors

When Option 003 is ordered the POWER REF connector is placed on the rear panel. It requires a 50 Ω type N male mating connector. These connectors must be compatible with the specifications of US MIL-C-39012.

Mainframe/Module Interconnect

The mainframe provides the power supply, HP-MSIB connections, and HP-IB connections for the module through this mainframe/module interconnect.

Note

Only elements that have been designed with HP-IB capability, and are addressed at row 0, are able to communicate over HP-IB. (Refer to Chapter 2 for more addressing information.)

HP 70100A Power Meter Firmware

The firmware version that is currently installed in the Power Meter can be read only over HP-IB. The Power Meter will respond to the following HP-IB codes:

- The HP-IB codes *IDN? or ID will send back the following string: HEWLETT-PAC KARD, 70100A,0,X.XX (Where 0 is a place holder and X.XX is the revision code.)
- The HP-IB code ?ID will send back the following string: HP70100A, REVX.XX (Where X.XX is the revision code.)

Options

W30 Service Option

Option W30 (where available) supplies an additional two years of Return-to-HP service. All products have a one year warranty. Option W30 coverage is for years two and three after the product's one year of warranty.

This option is ordered by the customer when the product is ordered. Call your nearest Hewlett-Packard office for Option W30 price information.

Module/Instrument Options

HP 70001A Mainframe Options

- Option 010 Rack-mount slide kit for mounting a mainframe in an Hewlett-Packard rack.
- Option 400 Provides an in-line isolation transformer for use with the mainframe during 400 Hz operation.
- Option 908 Rack-mount flange kit for a mainframe without handles.
- Option 913 Rack-mount flange kit for a mainframe with handles.

HP 70206A System Graphics Display Options

- Option 011 Rack-mount slide kit for mounting a stand-alone display in an Hewlett-Packard rack.
- Option 400 Provides an in-line isolation transformer for use with the stand-alone display during 400 Hz operation.
- Option 908 Rack-mount flange kit for a stand-alone display without handles.
- Option 913 Rack-mount flange kit for a stand-alone display with handles.

HP 70100A Power Meter Options

- Option 003 Removes the 50 MHz power reference output from the front panel and places it on the rear panel.
- Option 004 Deletes the standard 5 foot sensor cable.
- Option 005 Deletes the 50 MHz power reference.
- Option 910 Adds an additional Operating and Programming Manual.
- Option 915 Adds the Service Manual.

Accessories

Power Sensor Cables

Power Sensor cables of various lengths are available. The model numbers and lengths are listed below:

- HP 11730A 1.5m (5 ft; shipped with each Power Meter.)
- HP 11730B 3.0m (10 ft)
- HP 11730C 6.1m (20 ft)
- HP 11730D 15.2m (50 ft)
- HP 11730E 30.5m (100 ft)
- HP 11730F 61.0m (200 ft)

Rear Fan Filter

An optional Rear Fan Filter is available for the mainframe to reduce the amount of dust that enters the instrument. Figure 1-2 illustrates filter installation.

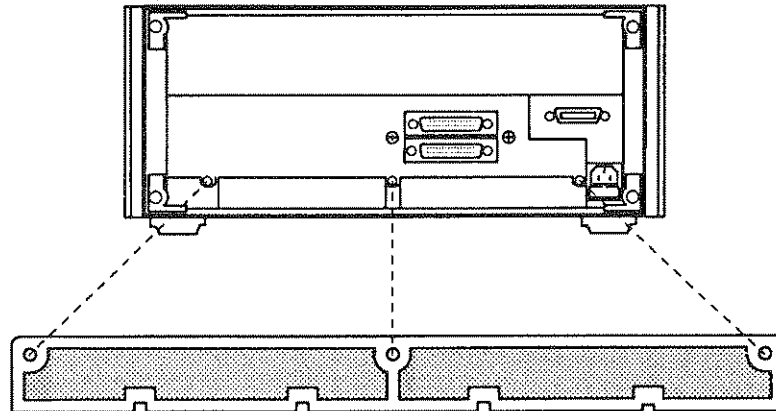

Figure 1-2. Rear Fan Filter

Display Screen Cleaner

To avoid damaging the coating on the display CRT, use a thin film cleaner such as Hewlett-Packard Display Cleaner (HP Part Number 8500-2163). This should be used with an abrasion-free cleaning tissue or soft cloth.

Caution



Paper towels, both hand and laboratory, should not be used to clean the screen, because they may scratch the coating.

Operating Requirements

Physical Requirements

See Chapter 3 for instrument weight and dimensions.

Warning



BEFORE TURNING THE MAINFRAME ON, make sure it is grounded through the protective conductor of the power cable to a socket outlet provided with protective earth contact. Any interruption of the protective (grounding) conductor inside or outside the mainframe, or disconnection of the protective earth terminal, can result in personal injury.

Line Voltage Selection

Caution

BEFORE TURNING THE MAINFRAME ON, set the LINE VOLTAGE SELECTOR to the voltage of the power source. Failure to do this could cause instrument damage when the power cable is plugged in.

Use the LINE VOLTAGE SELECTOR (see Figure 1-3) to select a line voltage. The mainframe LINE VOLTAGE SELECTOR switch is located on the mainframe bottom. The LINE VOLTAGE SELECTOR switch for the stand-alone display is located on its rear panel.

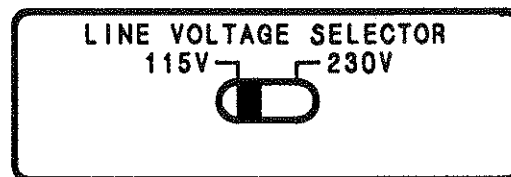

Figure 1-3. Line Voltage Selection

Fuse Replacement

The line module housing at the rear of the mainframe contains both the mainframe line fuse and a spare fuse. These metric 6.3A fuses (HP Part Number 2110-0703) are used in both 120V and 230V applications.

Caution

When replacing the mainframe fuse, use only fuses that are of the recommended size.

Figure 1-4 illustrates fuse removal and replacement.

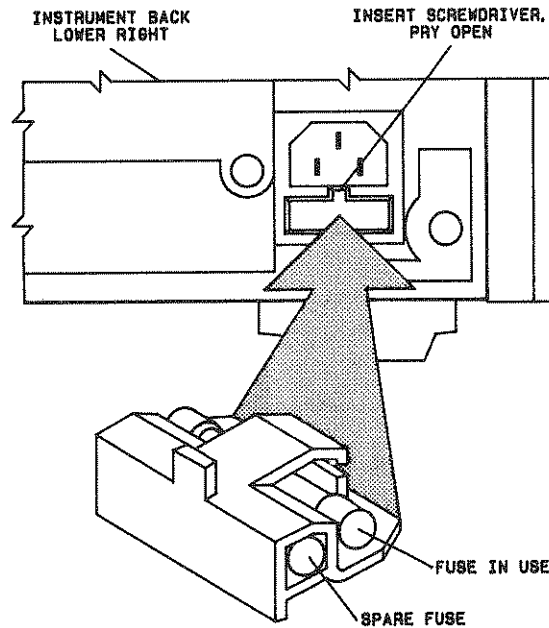

Figure 1-4. Line Fuse Removal and Replacement

400 Hz Option

Both the mainframe and stand-alone display are available with an option that allows them to run on a power-line frequency of 400 Hz. These 400 Hz options come with an external in-line isolation transformer that must be used when the instrument uses a 400 Hz power source. (Refer to Chapter 5 for replaceable parts information.)

Warning



Never operate a 400 Hz option instrument on a 400 Hz power line without the included in-line isolation transformer. Failure to follow this precaution can result in personal injury.

The 400 Hz option can be operated on a 60 Hz power line if the in-line isolation transformer is detached from the mainframe and a standard power cord is used. The in-line isolation transformer must be reattached before the mainframe is plugged into a 400 Hz power line source. The in-line isolation transformer protects the user from shock hazard in the event the power-line source is incorrectly grounded.

Power Cables



In accordance with international safety standards, the mainframe is supplied with a three-wire power cable. When connected to an appropriate and properly grounded power receptacle, this cable grounds the mainframe cabinet.

The type of power cable shipped with the mainframe depends on the country of destination. If additional or different cables are needed, refer to Table 1-1 for power cable descriptions and HP part numbers.

Operating Environment

Temperature	0°C to +55°C
Humidity	At 40°C <95% relative
Altitude	<4570 metres (15 000 feet)

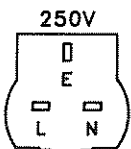
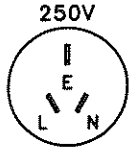
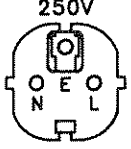
Table 1-1. Power Cables

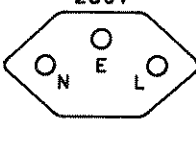
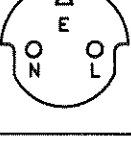
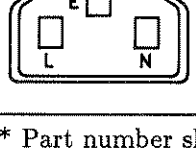
Plug Type**	Opt.	Cable HP Part No.	Plug Description	Cable Length cm (in)	Cable Color	For Use In Country
	900	8120-1351 8120-1703	Straight*BS1363A 90°	229 (90) 229 (90)	Mint Gray "	Great Britain, Cyprus, Nigeria, Zimbabwe, Singapore,
	901	8120-1369 8120-0696	Straight*NZSS198/ ASC112 90°	201 (79) 221 (87)	Gray "	Australia, New Zealand
	902	8120-1689 8120-1692	Straight*CEE7-Y11 90°	201 (79) 201 (79)	Mint Gray "	East and West Europe, Saudi Arabia, United Arab Republic (unpolarized in many nations)
	903	8120-1378 8120-1521 8120-1676	Straight*NEMA5-15P 90° Straight*NEMA5-15P	203 (80) 203 (80) 91 (36)	Jade Gray " "	United States, Canada, Mexico, Philippines, Taiwan
	918	8120-4753 8120-4754	Straight*MITI41-9692 90°	229 (90) 229 (90)	Dark Gray "	Japan only
	906	8120-2104	Straight*SEV1011 1959-24507 Type 12	201 (79)	Gray	Switzerland
	904	8120-0698	Straight*NEMA6-15P			
	905	8120-1860	Straight*CEEE22-VI			

* Part number shown for plug is industry identifier for plug only. Number shown for cable is HP Part Number for complete cable, including plug.

** E = Earth Ground; L = Line; N = Neutral.

Initial Inspection and Setup

The information given below covers initial inspection of the instrument after its arrival, removing and replacing the instrument's front handles, rack-mounting and connecting instrument cabinets.

Refer to Chapter 2 for information about module installation, removal, and addressing.

Inspection

Inspect the shipping container for damage. If the container or cushioning material is damaged, check the contents of the shipment both mechanically and electronically. To check electrical performance, run the performance tests. (Refer to Chapter 4.)

If the instrument is damaged or defective, contact the nearest Hewlett-Packard office. Hewlett-Packard will arrange for repair or replacement of the damaged or defective equipment without waiting for a claim settlement. Keep the shipping materials for the carrier's inspection.

For convenience in bench operation, the stand-alone displays have fold-away tilt stands. Both the stand-alone displays and mainframes have plastic feet that are shaped to make full-width cabinets self-aligning when stacked. The stand-alone displays (for example, HP 70206A System Graphics Display) and mainframes are shipped with front handles attached for ease of moving. The stand-alone displays and most mainframes also have side strap handles.

Warning



Do not install side strap handles on HP 70001A Mainframes with a serial prefix of 2504A or below without first installing a new rear frame. In a mainframe with an old rear frame, the weight of the mainframe and modules can cause the frame to break, allowing the instrument to drop. This could cause personal injury. Consult with your nearest HP service office for more information.

Keep undamaged shipping materials for future shipment or storage of the instrument. The original HP shipping materials, or the equivalent, are required for reshipment of instruments. Using substandard packaging can result in instrument damage. Read Packaging in this chapter for packaging information and requirements.

Front Handle Removal and Replacement

To install rack-mounting options, the front handles need to be removed. See Figure 1-5 for instructions.

Note



When replacing parts in this instrument, be sure to use identical hardware. This instrument contains both metric and English hardware.

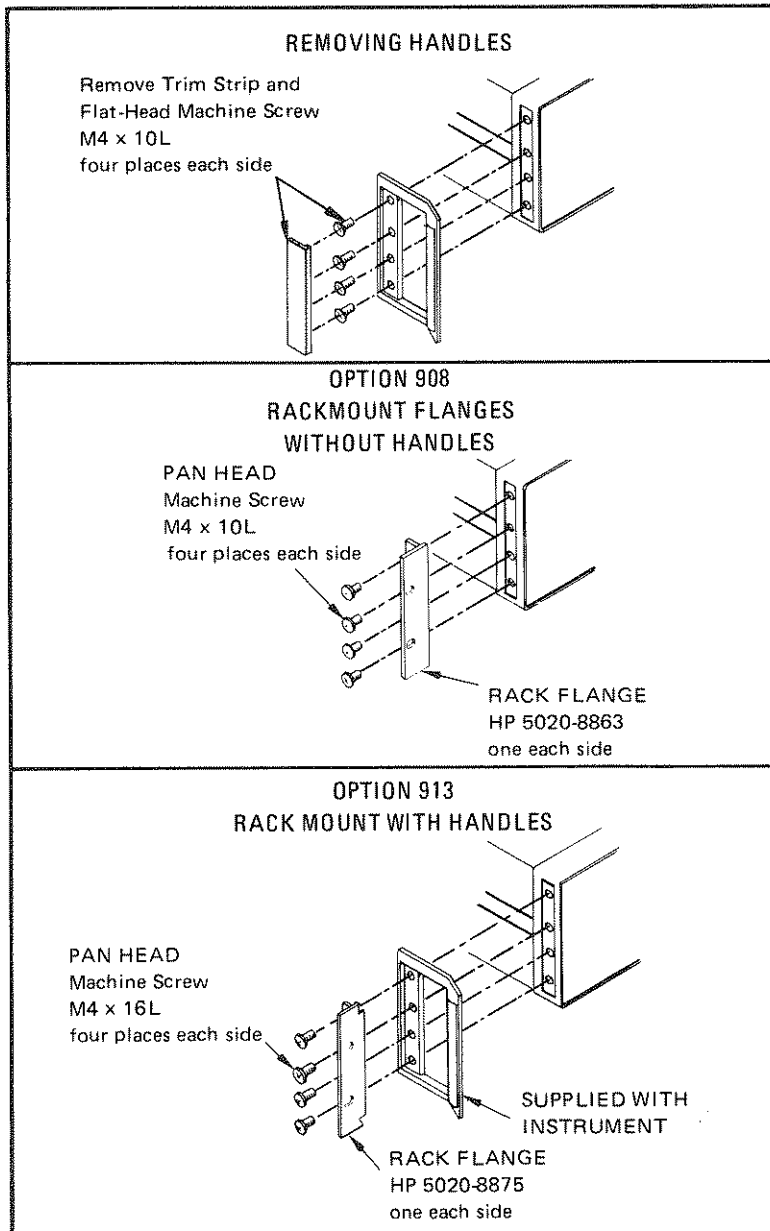

NOTE: LEFT FRONT IS SHOWN IN EACH EXAMPLE.

Figure 1-5. Front Handle Removal and Rack Mounting

Caution



Do not rack-mount combined instrument cabinets; use separate rack-mounting kits for each cabinet.

Rack-Mounting

Options 908 and 913 for the mainframe and stand-alone display contain the necessary hardware to mount the instrument in a rack with 482.6 mm (19 inches) spacing. Rack-mounting without handles requires Option 908; rack-mounting with handles requires Option 913.

See Figure 1-6 for correct screw size and positioning of handles or brackets when installing rack-mount options. An angle bracket (HP Part Number 12679C) can be ordered to provide the additional support that is required at the rear or sides of the instrument.

Rack-Mounting With Slides

Option 010 contains the necessary hardware to attach slides to a mainframe and mount it in an HP rack with 482.6 mm (19 inch) spacing. Adapter kits are available to allow slide rack-mounting in non-HP racks.

Option 011 contains the necessary hardware to attach slides to a stand-alone display (for example, HP 70206A) and mount it in an HP rack with 482.6 mm (19 inch) spacing. Adapter kits are available to allow slide rack-mounting in non-HP racks.

Refer to Chapter 5 for the part numbers of the slide rack-mount kits and their adapter kits. Instructions are included with each kit.

Connecting Instrument Cabinets

Connect instrument cabinets using the mainframe-to-mainframe or mainframe-to-System II Interconnect Kit. Refer to Chapter 5 for the part numbers of the interconnect kits.

Figure 1-6 illustrates the kit hardware used for vertically interconnecting the mainframe and various System II cabinets. The kit, which contains metric 4.0, 3.5, and English 6-32 screws, covers all mainframe and System II cabinet combinations.

Caution

The HP 70001A Mainframe and HP 70206A System Graphics Display contain metric 4.0 screws. Other System II cabinets contain metric 3.5 or English 6-32 screws. You will damage the cabinets, unless you use screws of the correct size, length, and thread type when connecting instrument cabinets.

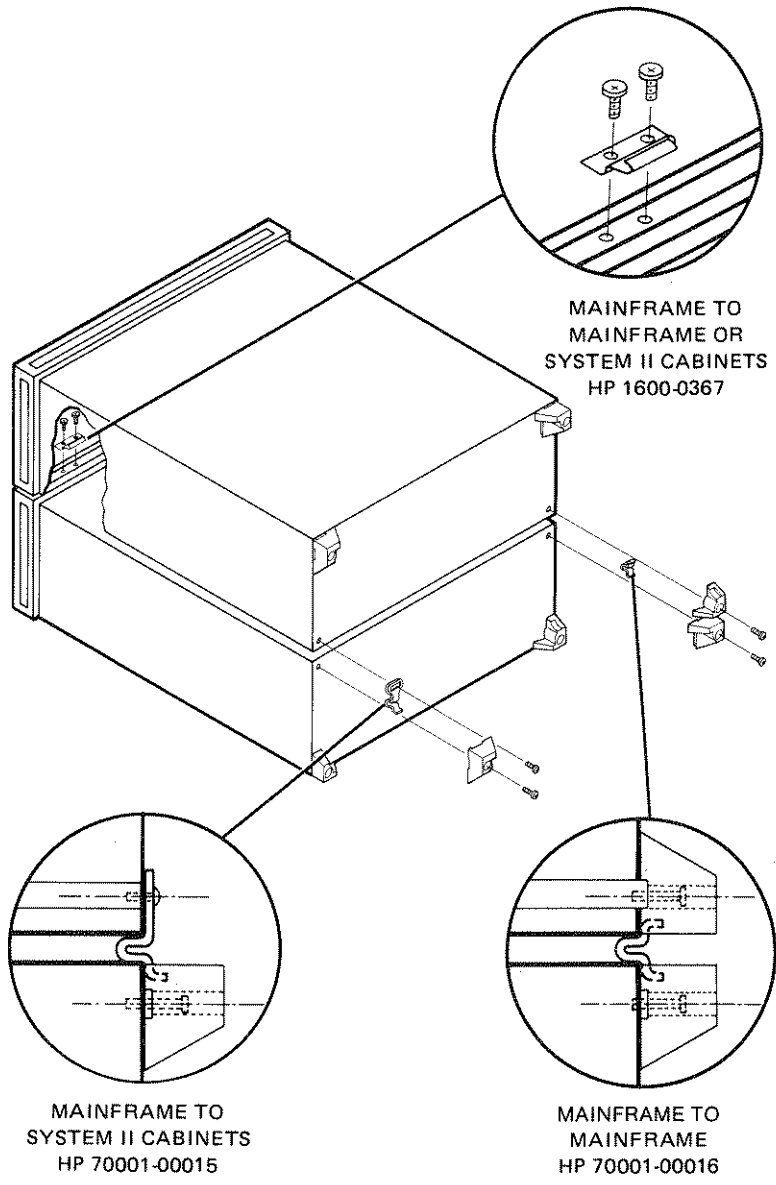

Figure 1-6. Interconnecting System II Cabinets

Storage and Shipment

Environment

The instrument should be stored in a clean, dry environment. The following environmental limitations apply to both storage and shipment.

Temperature	-40°C to +75°C
Humidity	<95% relative
Altitude	<15 300 metres (50 000 feet)

Packaging

The original shipping containers and materials, or the equivalent, must be used when repackaging the mainframe with modules or modules alone. Packaging materials identical to the original factory packaging can be purchased through any Hewlett-Packard office, including those listed at the rear of this book.

Figures 1-7 and 1-8 show the packaging materials.

Caution



Instrument damage can result from using packaging materials other than those specified. Never use styrene pellets in any shape as packaging materials. They do not adequately cushion the instrument or prevent it from shifting in the carton. They cause instrument damage by generating static electricity and by lodging in the instrument fan.

If the original packaging materials are not available, and you do not wish to order new packaging materials, instruments can be repackaged for shipment using the following instructions.

1. Wrap the instrument in anti-static plastic to reduce the possibility of damage caused by electrostatic discharge.
2. For instruments that weigh less than 120 lb, use a double-walled, corrugated cardboard carton of 350-lb test strength. The carton must be both large enough and strong enough to accommodate the instrument. Allow at least three to four inches on all sides of the instrument for packing material.
3. Surround the equipment with three to four inches of packing material, and prevent the instrument from moving in the carton. If packing foam is not available, the best alternative is S.D.-240 Air Cap from Sealed Air Corporation (Commerce, California, 90001). Air Cap looks like a plastic sheet filled with 1-1/4 inch air bubbles. Use the pink-colored Air Cap to reduce static electricity. Wrapping the instrument several times in this material should both protect the instrument and prevent it from moving in the carton.
4. If you are returning an instrument to Hewlett-Packard, fill out one of the blue repair cards (located at the rear of this manual) and include it in the package. If a tag is not available, make sure the following information is sent with the returned instrument:
 - a. Type of service required
 - b. Description of the problem; state if the problem is constant or intermittent
 - c. Name of technical contact person (please include phone number)
 - d. Return address

- e. Model number of returned instrument
- f. Full serial number of returned instrument
- g. List of any accessories returned with instrument.
- h. Seal the carton with strong nylon adhesive tape.
- i. Mark the carton "FRAGILE, HANDLE WITH CARE".

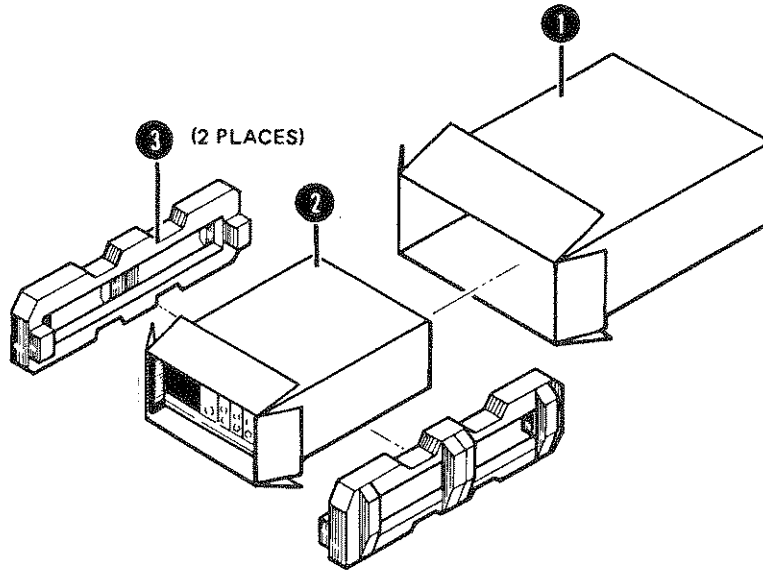

ITEM	QTY	HP PART NO.	DESCRIPTION
①	1	9211-4487	CARTON—OUTER
②	1	5180-2321	CARTON—INNER
③	2	5180-2319 OR 5180-7829	FOAM PADS (HP 70001A) FOAM PADS (HP 70206A)

Figure 1-7. Packaging Materials for Mainframe

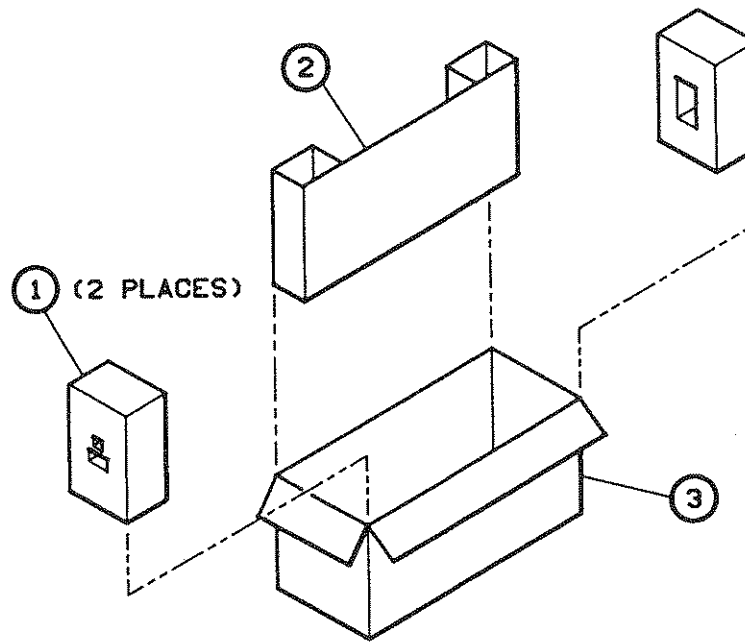

Item	Qty	HP Part No.	Description
1	2	70100-80008	Foam Pad
2	1	70100-80007	Corrugated Pad
3	1	70100-80006	Carton

Figure 1-8. Packaging Materials for Modules

Electrostatic Discharge Information

Electrostatic discharge (ESD) can damage or destroy electronic components. Therefore, all work performed on assemblies consisting of electronic components should be done at a static-safe workstation.

Figure 1-9 shows an example of a static-safe workstation using two types of ESD protection: 1) conductive table mat and wrist strap combination, and 2) conductive floor mat and heel strap combination. These methods may be used together or separately. (A list of static-safe accessories and their part numbers is given on the following pages.)

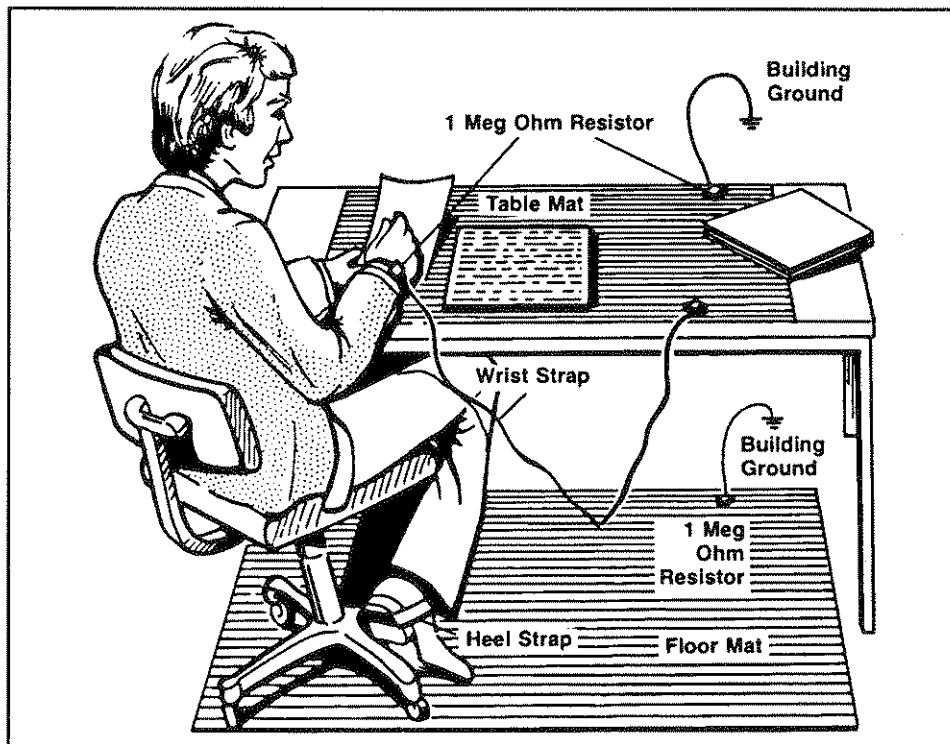

Figure 1-9. Static-Safe Workstation

Reducing Damage Caused By ESD

Below are suggestions that may help reduce ESD damage that occurs during testing and servicing instruments.

PC Board Assemblies and Electronic Components

Handle these items at a static-safe workstation.

Store or transport these items in static-shielding containers.

Caution

Do not use erasers to clean the edge connector contacts. Erasers generate static electricity and remove the thin gold plating, which degrades the electrical quality of the contacts.

Do not use paper of any kind to clean the edge connector contacts. Paper or lint particles left on the contact surface can cause intermittent electrical connections.

Do not touch the edge connector contacts or trace surfaces with bare hands. Always handle board assemblies by the edges.

PC board assembly edge connector contacts may be cleaned by using a lint-free cloth with a solution of 80% electronics-grade isopropyl alcohol and 20% deionized water. This procedure should be performed at a static-safe workstation.

Test Equipment

Before connecting any coaxial cable to an instrument connector for the first time each day, momentarily ground the center and outer conductors of the cable.

Personnel should be grounded with a resistor-isolated wrist strap before touching the center pin of any connector and before removing any assembly from the instrument.

Be sure that all instruments are properly earth-grounded to prevent buildup of static charge.

Static-Safe Accessories

The following is a list of static-safe accessories that may be obtained from any Hewlett-Packard office by using the HP part numbers listed.

HP Part Number 9300-0797

Includes: 3M static control mat .6m x 1.2m (2 ft. x 4 ft.)

4.6m (15 ft.) ground wire

wrist strap and attachment cord

HP Part Number 9300-0980

Wrist strap cord 1.5m (5 ft.)

HP Part Number 9300-0985

Wrist strap (large)

HP Part Number 9300-0986

Wrist strap (small)

HP Part Number 9300-1169

ESD heel strap (reusable 6 to 12 months)

HP Part Number 9300-0793

Shoe ground strap (one-time use only)

The following ESD accessories can be ordered from:

Hewlett-Packard Company
Computer Supplies Operations
1320 Kifer Road
Sunnyvale, California 94086
Phone: (408) 738-8858

HP Part Number 92175A

Black, hard-surface, static control mat
1.2m x 1.5m (4 ft. x 5 ft.)

HP Part Number 92175B

Brown, soft-surface, static control mat
2.4m x 1.2m (8 ft. x 4 ft.)

HP Part Number 92175C

Small, black, hard-surface, static control mat
1.2m x 0.9m (4 ft. x 3 ft.)

HP Part Number 92175T

Tabletop static control mat
58 cm x 76 cm (23 in. x 30 in.)

HP Part Number 92176A (natural color)

HP Part Number 92176C (russet color)

Anti-static carpet, 1.8m x 1.2m (6 ft. x 4 ft.)

HP Part Number 92176B (natural color)

HP Part Number 92176D (russet color)

Anti-static carpet, 2.4m x 1.2m (8 ft. x 4 ft.)

Installation

This chapter contains the following information:

- Initial power-on
- Module installation and removal
- HP-MSIB/HP-IB addressing

Most HP 70000 Modular Measurement Systems are shipped in a preconfigured system model. These preconfigured systems have already had their addresses set.

If you do not have a preconfigured system, or if you want to check the system addressing, refer to the following pages for more information. For information about rack-mounting and connecting instrument cabinets, refer to chapter 1, "General Information".

Note



1. The address switches on the back of the HP 70206A System Graphics display are for the display instrument only. They do *not* set the address of the system. The system address can be set using the addressing rules explained in "HP-MSIB/HP-IB Addressing" in this chapter.
 2. When the system is first turned on, the User screen softkeys may not be visible on the CRT. This is usually caused by the display window's not being assigned. Assign the display window to an instrument, with a row address of 0, by pressing [DISPLAY], then **SELECT INSTR.** This assigns the display to the instrument with the lowest column address. Press the [▲] key to assign the display to the instrument with the next-highest column address.
-

Initial Power-On

The following procedure may be used for the initial power-on:

1. Check the power cable (shipped with the system) for damage to the socket ends or cable cord.
2. If the cable is not damaged, set the mainframe or stand-alone display LINE switch to OFF, connect the power cable(s) to the system and then to the power source.
3. Set the mainframe or stand-alone display LINE switch to ON. The power light should come on, and the ventilation fan(s) should start.

Note

If the mainframe power light is on, but the ventilation fan does not start, set the mainframe LINE switch to OFF. Visually check for blockage of the fan intakes at the bottom rear of the mainframe. If the fan intakes appear clear and there are no other obvious causes for failure, contact a Hewlett-Packard office for instructions. If the power light on the mainframe or stand-alone display is not on, check the instrument fuse.

4. When the system is started, the indicator lights on the front panel of each module will turn on and off as the modules go through their self-test routine. If there is evidence of a problem after the self-test (for example, an ERR light's remaining lit), refer to Chapter 5, Troubleshooting for more information.

Module Installation and Removal

To install a module into the mainframe, follow these steps (see Figure 2-1):

1. Set the instrument LINE switch to OFF.
2. Swing the mainframe front door down. Note that the door will not open unless the LINE switch is OFF.
3. Check the module HP-MSIB address switches for correct addressing. (Refer to the addressing information in the following pages.)
4. Slide the module into the mainframe.
5. Tighten the module latch using an 8 mm hex-ball driver.

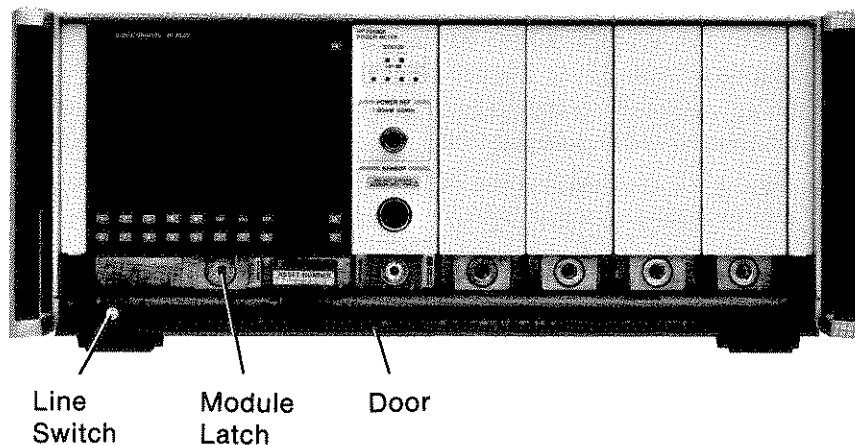

Figure 2-1. Module Removal/Replacement

To remove a module from the mainframe, follow these steps (see Figure 2-1):

1. Set the instrument LINE switch to OFF.
2. Swing the mainframe front door down. Note that the door will not open unless the LINE switch is OFF.
3. Loosen the module latch using an 8 mm hex-ball driver.
4. Slide the module forward, out of the mainframe.

HP-MSIB/HP-IB Addressing

HP 70000 Modular Measurement Systems are made up of separate parts called elements. All elements communicate over the HP-MSIB. To communicate and function properly, all elements must have appropriate HP-MSIB addresses.

HP-MSIB addressing is not the same as HP-IB addressing. Given below are definitions of essential terms, and explanations of the three main subjects you must understand to set the HP-MSIB and HP-IB addresses of an element:

- Modular Measurement System Terms
- Address Matrix
- Address Protocol
- Address Switches

Modular Measurement System Terms

Understanding the following terms is essential to understanding HP-MSIB addressing and the structural relationship of modular measurement system devices.

Functional Terms

Functional terms refer to the types of function, or work, that a given device may perform in a system and to the interrelationships that occur among the devices in a system.

Element: Any device (for example, HP 70100A Power Meter) that communicates over the HP-MSIB. In contrast, the HP 70001A Mainframe provides a path for all HP-MSIB communication, but does not communicate over the HP-MSIB and therefore is not an element.

Independent element: The display is an example of an independent element.

Instrument: An independent element and an element that performs an independent function.

Structural Terms

Structural terms refer to the hardware type of the device.

Mainframe: A device designed for modules to plug into. The mainframe supplies power, and HP-IB and HP-MSIB interconnections for the modules.

Module: A plug-in designed to work in a Hewlett-Packard modular measurement system mainframe.

Stand-Alone Instrument: An element that can function without being plugged into a mainframe (for example, HP 70206A System Graphics Display).

Address Matrix

The address matrix (see Figure 2-2) is a graphic representation of the addresses available on the HP-MSIB and the relationships among elements . The placement of an element on the address matrix is one of the factors that determines whether the element will have HP-IB access and can respond to display queries. (Illustrations of the physical switches used to set these addresses are given in Address Switches later in this section.)

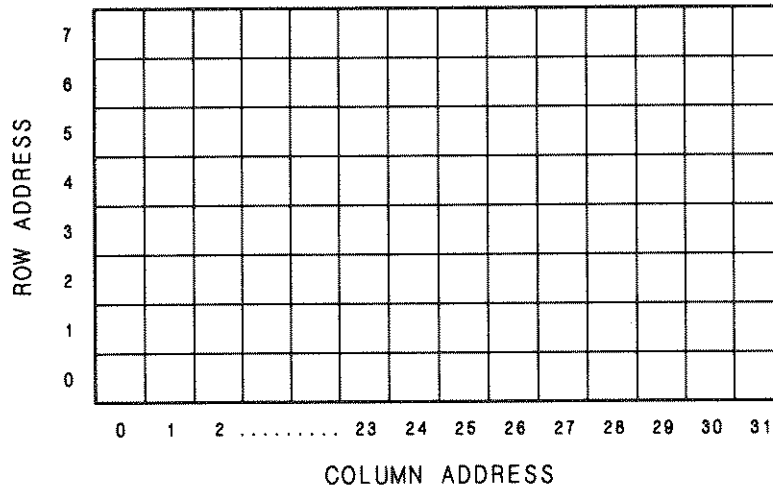

Figure 2-2. Address Matrix

To allow the elements to communicate and function properly, each element must have a binary eight-bit HP-MSIB address that is appropriately positioned on the address matrix. Every element in a system must have a unique address. The three most significant bits (MSB) of the HP-MSIB address determine the row address; the five least significant bits (LSB) determine the column address (see Figure 2-2). The decimal equivalents of the binary row and column addresses are used throughout this documentation. For example:

Row	Column	
Binary	(MSB) 010	11000 (LSB)
Decimal	2	24

There are eight possible row addresses and 32 possible column addresses. Address 0, 31 (row, column) is an illegal address, leaving 255 HP-MSIB addresses available.

HP-IB Access Area

The HP-IB access area on the address matrix is row 0 (except address 0, 31). Elements that have been designed for HP-IB access will be able to communicate on HP-IB only if they are addressed at row address 0 in the HP-IB access area.

Display-Response Area

When there is a display on the HP-MSIB, a display-response area exists at row address 0 of the address matrix. Only elements that have been designed to interface with the display and report errors (for example, HP 70100A Power Meter) should be addressed at row address 0.

Note



If an element that does not have these capabilities is addressed at row address 0, the system will cease to communicate.

Display Communication Capabilities

Before an element can communicate with the display it must have a display window, or keyboard, assigned. This provides a link for communication between the display and the element.

A display can be assigned to any element at a legal address, that has been designed with the capability to interface with the display and report errors.

An element that is addressed at row address 0, and has a display assigned to it, can use both the automatic error-reporting routine and the **REPORT ERRORS** softkey to report errors to the display. To assign a display to an element at row address 0, press **[DISPLAY]**, then **SELECT INSTR.** This automatically assigns the display to the element with the lowest HP-MSIB column address. Use the **[▲]** key to select an element with a higher HP-MSIB column address.

A display can be assigned to an element that is at an address other than row address 0. However the element will not be able to use the **REPORT ERRORS** softkey to report errors to the display. It will be able to use the automatic error-reporting routine. To assign a display to an element that is at an address other than row address 0, use the **assign keybd**, **assign window** or **ALLOC DISPLAY** softkeys in the Display menus to gain a display link. For example, to use the **ALLOC DISPLAY** softkey, press **[DISPLAY]**, then **address map**. After using the front-panel knob, or **[▲]** and **[▼]** keys, to select the element to which you want to assign the display, press **ALLOC DISPLAY**.

Address Switches

The address switches set the HP-MSIB address of an element; the column switches also set the HP-IB address for elements and independent elements. Some elements and displays can also have their HP-IB address set through the use of softkeys (that is, soft-set address). The instructions for entering a soft-set HP-IB address are given after the descriptions of the (hard) address switches.

The address switches (see Figures 2-3 and 2-4) are located on the rear of the Power Meter, and the rear of the HP 70206A System Graphics Display.

Descriptions of the address switches are given below.

HP 70100A Address Switches

The HP 70100A Power Meter address switches are located on the rear of the Power Meter.

COLUMN Address Switches 1—5. These set the HP-MSIB column address, which is also the HP-IB address. The switch labeled with a one (1) is the least significant bit.

ROW Address Switches 1—3. These set the HP-MSIB row address. The switch labeled with a one (1) is the least significant bit.

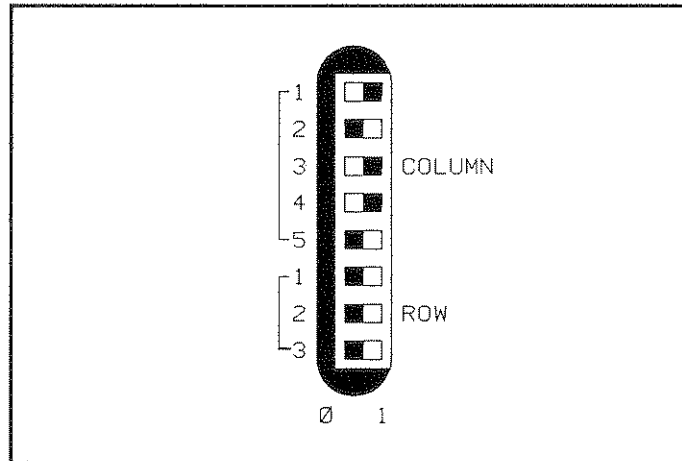

Figure 2-3. Address Switches — HP 70100A

Display Address Switches

HP-IB ON/OFF. This switches the display on or off the HP-IB without disrupting instrument operation.

A6—A8 or MSIB ROW. This shows that the default HP-MSIB row address is (0).

A1—A5 HP-IB/HP-MSIB. These address switches set the HP-MSIB column address, which is also the HP-IB address.

TALK ONLY. When this is set to 1 (on), the display can talk on the HP-IB without requiring a reply (some plotters cannot reply). In normal operation, this switch is set to 0 (off).

SYSTEM CONTROLLER. When this is set to 1 (on), the display functions as a controller on the HP-IB. In normal operation, the switch is set to 0 (off).

TEST MODE. When this is set to 1 (on), the display goes into a special test mode at instrument power-on. In normal operation, the switch is set to 0 (off).

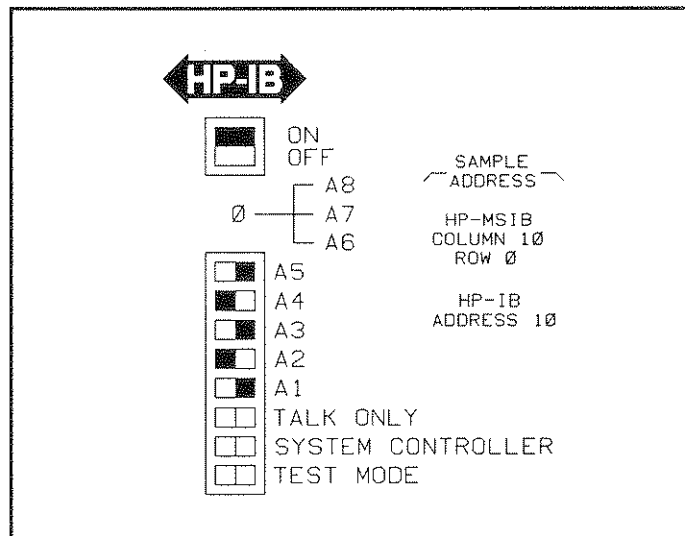

Figure 2-4. Address Switches — Display

Soft-Set HP-IB Addresses

The HP-IB address of the Power Meter can be set from the front panel of a display. At startup, the soft-set address will override the address switch settings. The soft-set address remains until the (hard) address switches are reset, or until another soft-set address is entered.

Use the following procedure to enter a soft-set HP-IB address:

1. Press **[DISPLAY]** on the display front panel.
2. When the menu appears, press **address map**.
3. When the next menu appears, select the Power Meter, using the display front-panel knob or **[▲]** and **[▼]** keys.
4. Press **SET HP-IB**.
5. Enter the new HP-IB address, using the numeric keys on the display front panel.
6. Press **ENTER**.



Specifications

This chapter contains the specifications and characteristics that apply to the Power Meter. Refer to the Operating Manual of the display for specifications and characteristics that apply to the display.

Specifications vs. Characteristics

Specifications

Specifications describe warranted performance over the temperature range of 0°C to +55°C after one hour of continuous operation (unless otherwise noted).

Characteristics

Characteristics provide useful information by giving functional, but non-warranted performance parameters.

Table 3-1. Specifications

Electrical Characteristics	Performance Limits	Conditions
Frequency Range	100 kHz to 50 GHz	Sensor dependent
Power Range	-70 to +44 dBm (100 pW to 25W)	Sensor dependent
Dynamic Range	50 dB total range	In 10 dB steps
Display Units	Watts or dBm Percent or dB	Absolute measurement mode Relative measurement mode
Resolution Low Mid High	1.0% full scale (0.1 dB) 0.1% full scale (0.01 dB) 0.01% full scale (0.001 dB)	
Accuracy Instrumentation Zero Set (digital settability of zero)	Absolute Measurement Mode ± 0.02 dB or ± 0.5% Relative Measurement Mode ± 0.02 dB or ± 0.5% ± 0.04 dB or ± 1% ± 0.5% of full scale ± 2% of full scale	Within calibration range Outside calibration range Most sensitive range. Divide percentage by a factor of 10 for each higher range, ± 1 count. If using the HP 8484A, 8485D, or 8486D Power Sensors.
Power reference Accuracy	1.00 mW ± 1.2% ± 0.9%	Internal 50 MHz oscillator factory set to ± 0.7% traceable to U.S. National Institute of Standards. Worst case RSS for one year
Operating Temperature Range	0°C to 55°C	
Remote Operation	HP-IB	
Compatibility	HP-IB interface	SH1,AH1,T6,TE0,L4,LE0, SR1,RL1,PP0,DC1,DT1,C0
Operating and non-operating environment	Temperature, humidity, shock, and vibration type tested using the limits of MIL-T-28800C Class V requirements.	
EMI	Radiated interference is within the requirements of MIL-STD-461C, RE02	
Net weight	4.2 lb. (1.9 kg)	
Dimensions Height × Width × Depth	1/8-width module	

Table 3-2. Characteristics

Meter Noise

Meter noise is specified as a percent of full scale, at two standard deviations from the mean. The noise was measured over a one minute interval, under constant temperature, and in range 1. Decrease noise by a factor of 10 for each higher range, for all sensors and all filters.

HP 8481, 8482, 8483, 8485A, 8486A, 8487A Sensors:

Filter Number	Number of Averages	Noise (%)
0	1	12
1	4	2.4
2	8	1.8
3	16	0.9
4	32	0.7
5	64	0.5
6	128	0.4
7	256	0.3
8	512	0.2
9	1024	0.15

HP 8484A/8485D Sensors: multiply noise levels by four for all filters

HP R/Q8486D Sensors: multiply noise levels by six for all filters

Zero Drift of sensors

As a percent of full scale after one hour at a constant temperature and a 24-hour warm up. Divide percentage by a factor of ten for each higher range.

HP 8481,8482,8483,8485A,8486A,8487A Sensors: <0.3% of full scale in range 1.

HP 8484A/8485D/8486D Sensors: <2.0% of full scale on range 1.

Settling Time

0 to 99% settled readings over the bus. Using range HOLD, 10 dB decreasing power step.

Filter Number	Number of Averages	Response Time(s)
0	1	0.03
1	4	0.13
2	8	0.25
3	16	1.0
4	32	1.4
5	64	2.2
6	128	3.7
7	256	6.9
8	512	14.0
9	1024	27.0

Table 3-2. Characteristics (cont'd)

Settling Time (cont'd)

Settling time by range with a default resolution of 0.01 dB, in range HOLD and 10 dB decreasing power step:

Range 1	<7.0s
Range 2	<1.0s
Range 3	<150 ms
Ranges 4,5	<100 ms

Settling time versus range and resolution, for auto filter mode:

Range	0.1 dB (1%)	0.01 dB (0.1%)	0.001 dB (0.01%)
5	0.1s	0.1s	1.0s
4	0.1s	0.1s	1.4s
3	0.1s	0.15s	2.2s
2	0.1s	1.0s	14.0s
1	1.0s	6.9s	6.9s

Measurement Speed over HP-IB

Free-run Triggering: 40 readings per second

Verification

Introduction

The procedures in this section test the HP 70100A's electrical performance using the specifications in this Manual as the performance standards. All tests can be performed without access to the interior of the instrument.

Note

If the performance tests are to be considered valid, the following conditions must be met:

- a. The HP 70100A must have one-half hour warm-up for all specifications.
 - b. The line voltage for all instruments must be 100, 120, 220, or 240 Vac +5%, -10%; and the line frequency must be 48 to 66 Hz. The HP 70100A Power Meter system has the additional capability of operating on line frequencies of 360 to 440 Hz, but the line voltage is limited to a nominal 100 to 120 Vac.
 - c. The ambient temperature must be 0° to 55° C.
-

Performance Tests

The performance tests given in this section are suitable for incoming inspection, troubleshooting, or preventive maintenance. During any performance test, all shields and connecting hardware must be in place. The tests are designed to verify published instrument specifications.

Test Procedures

It is assumed that the person performing the following tests understands how to operate the specified test equipment. Equipment settings, other than those for the HP 70100A, are stated in general terms. It is also assumed that the technician will select the proper power sensor, cables, adapters, and probes required for test setups illustrated in this section.

Equipment Required

The equipment and accessories required for the performance tests are listed below in Table 4-1. Other equipment may be substituted if it meets or exceeds the critical specifications listed.

Table 4-1. Recommended Test Equipment

Instrument	Critical Specifications	Recommended Model
Digital Voltmeter	Range 0 to 20 Vdc	HP 3456A
Frequency Counter	Range: 10 Hz to 50 MHz Resolution: 1 Hz	HP 5328A Option 031
Modular Measurement System		HP 70000 Series
Power Meter	Range: 1 mW Transfer Accuracy: 0.2% (Input to output)	HP 432A
Range Calibrator	Calibration uncertainty $\pm 0.25\%$	HP 11683A
Thermistor Mount	SWR: 1.05 at 50 MHz Accuracy: ± 0.5 at 50 MHz	HP 478A-H76 ¹
¹ HP standards lab calibration to $\pm 0.58\%$ at 50 MHz (traceable to NIS).		

Installing the HP 70100A

1. Set the Modular Measurement System's LINE switch to OFF.
2. Ensure that the HP 70100A's HP-MSIB switch is set to 13.
3. Open the Modular Measurement System's door and slide the HP 70100A into any available slot.
4. Using a hex-ball driver, tighten the hex-ball nut at the bottom of the HP 70100A until it is firmly seated in the Modular Measurement System.
5. Close the Modular Measurement System's door.
6. Set the Modular Measurement System's LINE switch to ON.

Displaying the HP 70100A Readings

1. Press the [DISPLAY] key on the Graphics Display.
2. Press the **SELECT INSTR** key.
3. Press **▲** or **▼** until the following message appears at the bottom of the display: "Row 0, Column 13: HP70100A, PWR MTR"
4. Press the [MENU] key on the Graphics Display to display the Power Meter's menu.

Zero Carryover Test

Specification

Electrical Characteristics	Performance Limits	Conditions
Accuracy: Zero set (Digital settability of zero)	$\pm 0.5\%$ full scale	Most sensitive range. Decrease percentage by factor of 10 for each higher range ± 1 count.

Description

After the HP 70100A is initially zeroed, the change in the readings is monitored as the HP 70100A is stepped through its ranges. This test also checks drift and noise since drift, noise, and zero carryover readings cannot be separated.

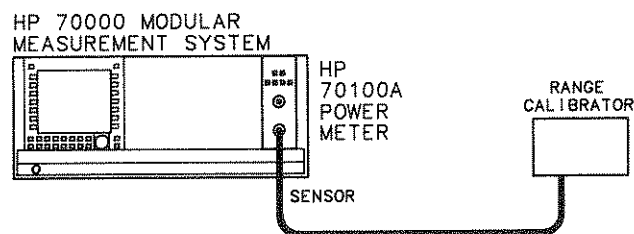

Figure 4-1. Zero Carryover Test Setup

Equipment

Modular Measurement System	HP 70000 Series
Range Calibrator	HP 11683A
Power Sensor Cable	HP 11730A

Procedure

1. Connect the equipment as shown in Figure 4-1.
2. Set the System's LINE switch to ON.
3. If necessary, bring the HP 70100A's display onto the screen.
4. Press the dBm/W key for a meter reading in watts.

5. Set the range calibrator as follows:

LINE	ON
RANGE	3 μ W
FUNCTION	STANDBY
6. Press the **Cal Funcs** key, then the **ZERO** key. Wait approximately 15 seconds for the "Zeroing*****" display to disappear. Verify that the display reads $0.00 \pm 0.06 \mu$ W
7. Press the **Meas Funcs** key, then select **range**.
8. Press **RANGE 1**.
9. Verify that the HP 70100A's reading is within the limits shown in the table below. Record the reading.
10. Repeat steps 7 through 9 using ranges 2, 3, 4, and 5.

HP 70100A Range	Min	Actual Results	Max
1	-0.05 μ W	_____	0.05 μ W
2	-0.1 μ W	_____	0.1 μ W
3	-0.001 mW	_____	0.001 mW
4	-0.01 mW	_____	0.01 mW
5	-0.1 mW	_____	0.1 mW

Instrument Accuracy Test

Specification

Electrical Characteristics	Performance Limits	Conditions
Accuracy: Instrumentation, includes sensor linearity. ¹ $\pm 0.5\%$ or ± 0.02 dB	Within same calibration range	
¹ When operating in Ranges 4 or 5, add the corresponding sensor power linearity percentage.		

Description

The HP 70100A is initially calibrated on the 1 mW range. The readout is then monitored as the range calibrator is switched to provide reference inputs corresponding to each of the HP 70100A operating ranges.

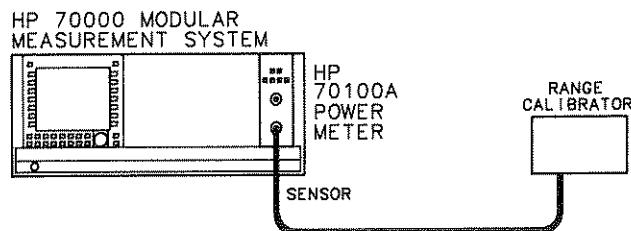

Figure 4-2. Instrument Accuracy Test Setup

Equipment

Modular Measurement System	HP 70000 Series
Range Calibrator	HP 11683A
Power Sensor Cable	HP 11730A

Procedure

1. Connect the equipment as shown in Figure 4-2.
2. Press the system's LINE switch to ON.
3. If necessary, bring the HP 70100A's display onto the screen.
4. Press the dBm/W key for a meter reading in watts.

5. Set the range calibrator as follows:

LINE	ON
FUNCTION	STANDBY
POLARITY	NORMAL
RANGE	3 μ W

Note

When switching the range calibrator to STANDBY, allow enough time for the range calibrator to settle to its zero value before attempting to zero the HP 70100A. This settling would appear on the HP 70100A display as downward drift. When the drift has reached minimum, (typically around 60 seconds), the range calibrator is settled.

6. Press the **Cal Funcs** key, then the **ZERO** key. Wait approximately 15 seconds for the "Zeroing*****" display to disappear. Verify that the display reads 0.00 ± 0.05 mW.
7. Set the range calibrator's FUNCTION switch to CALIBRATE.
8. Set the range calibrator's RANGE switch to 1 mW.
9. Press **cal**.
10. Using the knob, adjust the calibration factor until the display reads "REF CAL FACTOR 100.0%".
11. **EXECUTE**
Press **CAL**. (The display will read "Calibrate**" for a few seconds.)
12. Verify that the HP 70100A display reads 1.000 ± 0.001 mW.
13. Set the range calibrator's RANGE switch to the positions shown in the following table. For each setting, verify that the HP 70100A's reading is within the limits shown.

Range Calibrator Setting	Min	Actual Results	Max
3 μ W	3.10 μ W	_____	3.23 μ W
10 μ W	9.90 μ W	_____	10.10 μ W
30 μ W	31.4 μ W	_____	31.8 μ W
100 μ W	99.5 μ W	_____	100.5 μ W
300 μ W	.314 mW	_____	.318 mW
1 mW	0.995 mW	_____	1.005 mW
3 mW	3.14 mW	_____	3.18 mW
10 mW	9.95 mW	_____	10.05 mW
30 mW	31.4 mW	_____	31.8 mW
100 mW	99.5 mW	_____	100.5 mW

Note



It is not necessary to check instrument accuracy in dBm. The HP 70100A uses the same internal circuitry to measure power and mathematically converts watts to dBm.

Power Reference Level Test

Specification

Electrical Characteristics	Performance Limits	Conditions
Power reference	$\pm 1.2\%$	Worst case.
Accuracy	$\pm 0.9\%$	RSS for one year.
Power reference	1.0 mW	Internal 50 MHz oscillator factory set to $\pm 0.7\%$ traceable to U.S. National Institute of Standards.

Description

The power reference oscillator output is factory adjusted to 1 mW $\pm 0.7\%$. To achieve this accuracy, Hewlett-Packard employs a special measurement system accurate to 0.5% (traceable to the U.S. National Institute of Standards) and allows for a transfer error of $\pm 0.2\%$ in making the adjustment. If an equivalent measurement system is employed for verification, the power reference oscillator output can be verified to 1 mW $\pm 1.9\%$ ($\pm 1.2\%$ accuracy plus $\pm 0.5\%$ verification system error plus $\pm 0.2\%$ transfer error = 1.9% maximum error).

The power reference oscillator can be set to $\pm 0.7\%$ using the same equipment and following the adjustment procedure. To ensure maximum accuracy in verifying the power reference oscillator output, the following procedure provides step by step instructions for using specified Hewlett-Packard test instruments of known capability. If equivalent test instruments are used, signal acquisition criteria may vary and reference should be made to the manufacturer's guidelines for operating the instruments.

Note

The HP 70100A may be returned to the nearest Hewlett-Packard office to have the power reference oscillator checked and/or adjusted. Refer to Chapter 1, "Packaging".

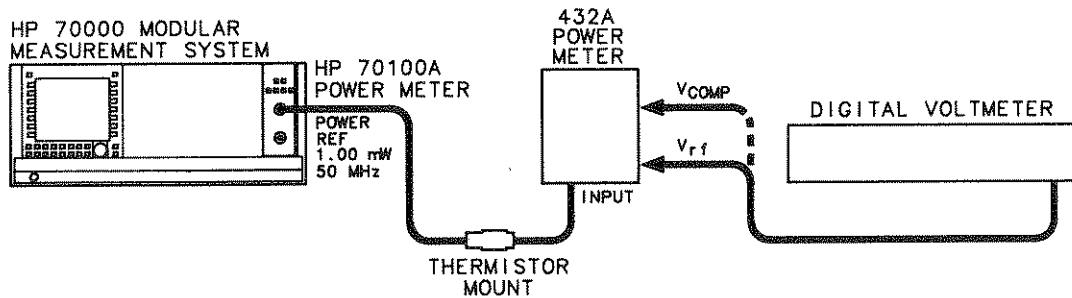

Figure 4-3. Power Reference Level Test Setup

Equipment

Modular Measurement System	HP 70000 Series
Test Power Meter	HP 432A
Thermistor Mount	HP 478A-H76
Digital Voltmeter (DVM)	HP 3456A

Procedure

1. Set the DVM to measure resistance. Connect the DVM between the V_{rf} connector on the rear panel of the test power meter, and pin 1 on the thermistor mount end of the test power meter interconnect cable.
2. Round off the DVM indication to two decimal places and record this value as the internal bridge resistance (R) of the test power meter (approximately 200Ω).

R _____

3. Connect the test power meter to the HP 70100A as shown in Figure 4-3.
4. Set the Modular Measurement System's LINE switch to ON.
5. Ensure that the screen displays the HP 70100A reading.

Note

Wait thirty minutes for the test power meter thermistor mount to stabilize before proceeding to the next step.

6. Set the test power meter RANGE switch to Coarse Zero. Adjust the front panel Coarse Zero control to obtain a zero meter indication.
7. Fine zero the test power meter on the most sensitive range, then set the RANGE switch to 1 mW.

Note

Ensure that the DVM input leads are isolated from chassis ground when performing the next step.

8. Set the DVM to measure microvolts. Connect the positive and negative input leads, respectively, to the Vcomp and Vrf connectors on the rear panel of the test power meter.
9. Observe the reading on the DVM. If less than 400 microvolts, proceed to the next step. If 400 microvolts or greater, press and hold the test power meter Fine Zero switch and adjust the Coarse Zero control so that the DVM indicates 200 microvolts or less. Release the Fine Zero switch and proceed to the next step.
10. Round the DVM reading to the nearest microvolt. Record this reading as V_0 .

V_0 _____

11.

On the HP 70100A display, press the **Cal Funcs** key, then the **PWR REF** **On Off** key until *On* is underlined.

12. Observe the reading on the DVM. Record the reading as V_1 .

V_1 _____

13. Disconnect the DVM negative input lead from the Vrf connector on the test power meter. Reconnect it to the test power meter chassis ground.
14. Observe the DVM reading. Record the reading as V_{comp} .

V_{comp} _____

15. Calculate the power reference oscillator output level (Prf) from the following formula:

$$Prf = \frac{2V_{comp}(V_1 - V_0) + V_0^2 - V_1^2}{4R(CalibrationFactor)}$$

Where:

Prf = power reference oscillator output level

V_{comp} = previously recorded value

V₁ = previously recorded value

V₀ = previously recorded value

Calibration Factor = value for thermistor mount at 50 MHz (traceable to the U.S. National Institute of Standards).

16. Verify that Prf is within the limits shown in the following table. Record the reading.

Min	Actual	Max
0.988 mW	_____	1.012 mW

Table 4-2. Performance Test Record

Hewlett-Packard Company

Tested by _____

Model HP 70100A Modular Power Meter

Serial Number _____

Date _____

Test	Min	Actual Result	Max
ZERO CARRYOVER			
HP 70100A Range			
1	-0.05 μ W	_____	0.05 μ W
2	-0.1 μ W	_____	0.1 μ W
3	-0.001 mW	_____	0.001 mW
4	-0.01 mW	_____	0.001 mW
5	-0.1 mW	_____	0.1 mW
INSTRUMENT ACCURACY			
Accuracy			
3 μ W	3.10 μ W	_____	3.23 μ W
10 μ W	9.90 μ W	_____	10.10 μ W
30 μ W	31.4 μ W	_____	31.8 μ W
100 μ W	99.5 μ W	_____	100.5 μ W
300 μ W	.314 mW	_____	.318 mW
1 mW	0.995 mW	_____	1.005 mW
3 mW	3.14 mW	_____	3.18 mW
10 mW	9.95 mW	_____	10.05 mW
30 mW	31.4 mW	_____	31.8 mW
100 mW	99.5 mW	_____	100.5 mW
POWER REFERENCE			
Prf	0.988 mW	_____	1.012 mW

Troubleshooting

This chapter contains information needed to troubleshoot an HP 70100A Power Meter system to the faulty element or mainframe. It contains the following sections:

- **Troubleshooting Tools** explains the tools (for example, status indicators) used to isolate problems.
- **Diagnostic Procedures** tells you how to use the troubleshooting tools to identify which part of the system is faulty.
- **Error Codes** lists the error code messages used in the HP 70100A Power Meter system.
- **Replaceable System Parts** contains ordering information and part numbers for system-level replacement parts, cables, and service accessories.

Troubleshooting Tools

This section contains definitions of some HP 70000 Modular Measurement System terms, and explanations of the troubleshooting tools used for isolating problems in HP 70100A Power Meter system:

- Status Indicators
- Error Message Reporting
- HP 70100A Power Meter Self-Test
- Display Tests
- HP-MSIB Troubleshooting Utility

The information in this section should be read before using the procedures given in the Diagnostic Procedures section of this chapter.

Modular Measurement System Terms

Functional Terms refer to the types of function, or work, that a given device may perform in a system.

- **Element:** Any device (for example, HP 70100A Power Meter) that communicates over the HP-MSIB. In contrast, the HP 70001A Mainframe controls all HP-MSIB communication, but does not communicate over the HP-MSIB and therefore is not an element.
- **Independent element:** A display is an example of an independent element.
- **Instrument:** An element or an independent element that performs a function that does not require, or rely on, another piece of equipment.

Structural Terms refer to the hardware type of the device.

- **Mainframe:** A device designed for modules to plug into. The mainframe supplies power, cooling, and HP-IB and HP-MSIB interconnections for the modules, in addition to controlling HP-MSIB communication.
- **Module:** A plug-in designed to work in a Hewlett-Packard modular measurement system mainframe.
- **Stand-Alone Instrument:** An element that can function without being plugged into a mainframe (for example, HP 70206A System Graphics Display).

Status Indicators

All elements and the mainframe have status indicators. Status indicators that inform the operator of a problem are called error indicators. Indicators that tell the user which elements are being controlled or accessed are called active indicators.

All elements, except the displays, have **ERR** (error) and **ACT** (active) indicator lights located on the front panel. Displays have indicator letters, **E** (error) and **A** (active). The display indicator letters are in the lower right corner of the display in the display status block. Some elements have additional status indicators:

- The HP 70206A System Graphics Display has an **I/O** error indicator light on the front panel. The I/O light should be off when both HP-MSIB cables are either connected to or disconnected from the HP 70206A System Graphics Display. It should be lit when only one HP-MSIB cable is disconnected from the HP 70206A System Graphics Display. In this section, refer to Troubleshooting Catastrophic Failures for more information about the I/O error indicator.
- The HP 70100A Power Meter has several HP-IB related indicators: **RMT** (remote), **LSN** (listen), **TLK** (talk), and **SRQ** (service request). RMT, LSN and TLK are status indicators and do not indicate an error condition when they are lit. SRQ can be set by the user to light in response to different conditions (for example, an error condition, or completion of an operation). Refer to the HP 70100A Power Meter programming section for information about setting SRQ.

The HP 70001A Mainframe does not have an active indicator, but it does have three front-panel error indicators: **VOLT/TEMP**, **CURRENT**, and **I/O CHECK**. The **I/O CHECK** indicator should be off when both HP-MSIB cables are either connected to or disconnected from the HP 70001A Mainframe. It should be lit when only one HP-MSIB cable is connected to the HP 70001A Mainframe. Refer to Troubleshooting Catastrophic Failures, in this section, for more information about mainframe error indicators.

Error Indicators

The **ERR** (error) light indicates that the Power Meter has an error condition. Conditions that generate an error, such as, **PLEASE ZERO**, **NO SENSOR**, or **ENTRY ERROR** will cause the LED to light. The error light goes out when the error condition no longer exists and the error

REPORT

condition has been reported. The error is reported by using the **ERRORS** softkey of the display module.

The display **E** (error) letter indicates an error condition in any element on the HP-MSIB which is on row 0. All elements at row 0 report their error status to the display.

An error indicator flashing at about a 1 Hz rate indicates that the element cannot communicate on the HP-MSIB.

Active Indicators

The ACT (active) light of an element comes on when the element is being used through the display keyboard. Most elements also turn their ACT light on and off during their self-test.

The display A (active) letter comes on when [DISPLAY] is pressed, and may come on when Display screen softkeys are selected.

Each element turns its active indicator on when the cursor of the Address Map (Display screen) is at that particular element's HP-MSIB address. The HP-MSIB address of each element can be identified by scrolling the cursor through the Address Map and observing the active indicators.

Error Message Reporting

Any element on the HP-MSIB that has a display link has its errors reported to the display through the automatic error-reporting routine.

If an element has a row 0 address, the errors are also available through the use of the **REPORT ERRORS** softkey in the Display screen.

Note



Not all elements have the capability to interface with a display. The HP 70100A Power Meter has the capability to interface with the display.

Error Report Screen

Errors reported by any element at row address 0 can also be seen by using the **REPORT ERRORS** softkey in the Display Menu to view the Error Report screen. See Figure 5-1. The Error Report screen allows the errors to be seen whether the element has a display window or not.

When **REPORT ERRORS** is pressed, the display queries all elements that are at row address 0.

The top of the Error Report screen shows the model number, description, and HP-MSIB address of the element that is reporting errors. See Figures 5-1 and 5-2.

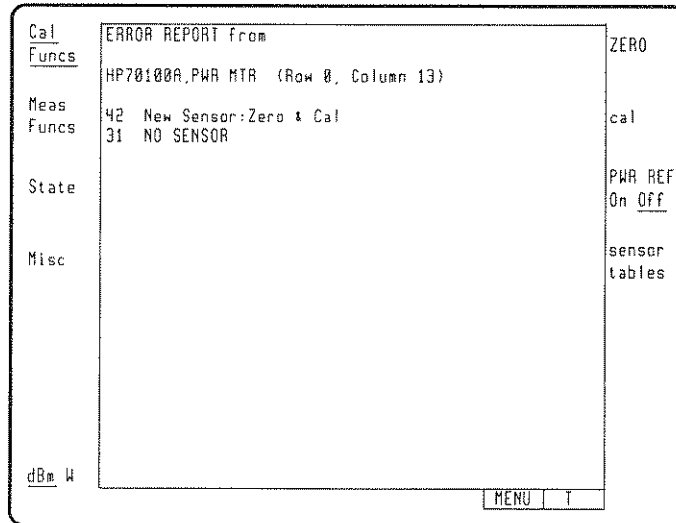

Figure 5-1. Error Report Screen

If any two elements in row 0 (including the display) are reporting errors, the Error Report screen displays the errors of the element with the lowest column address and a **MORE ERRORS** softkey. Pressing **MORE ERRORS** displays the errors of the element with the next-highest column address. See Figure 5-2.

To exit the Error Report screen, press the [USER] or [MENU] key.

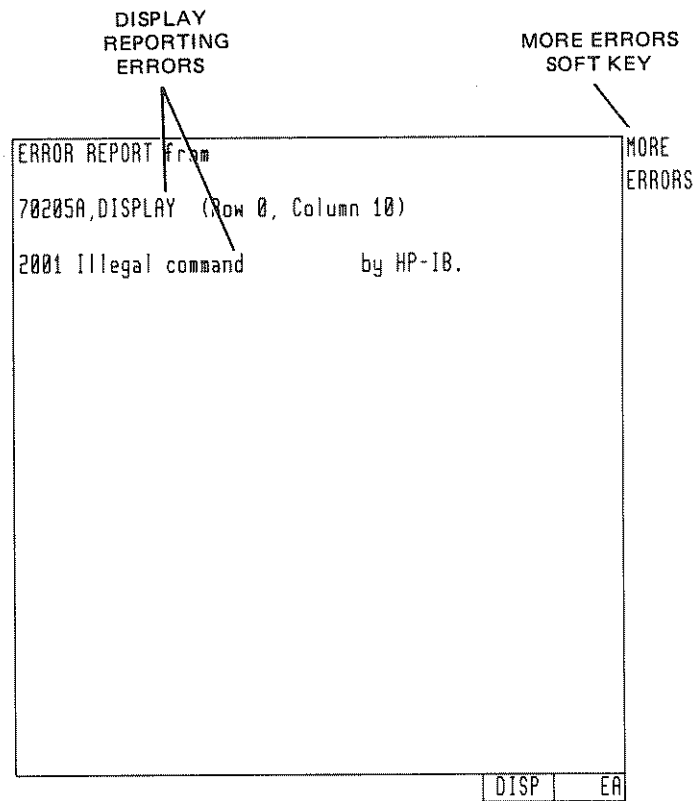

Figure 5-2. "MORE ERRORS" Softkey

Display-Disruptive Errors

Display error conditions that might interfere with a normal display are called display-disruptive errors. Display-disruptive error messages (for example, A3 MEMORY READ) are written on the CRT in large block letters.

HP 70100A Power Meter Self-Test

The self tests allow the user to run a battery of tests that check the digital and analog circuitry of the Power Meter. The self tests are accessed through the Misc key and the **service tests** softkey. The self test menu is shown in Figure 5-3.

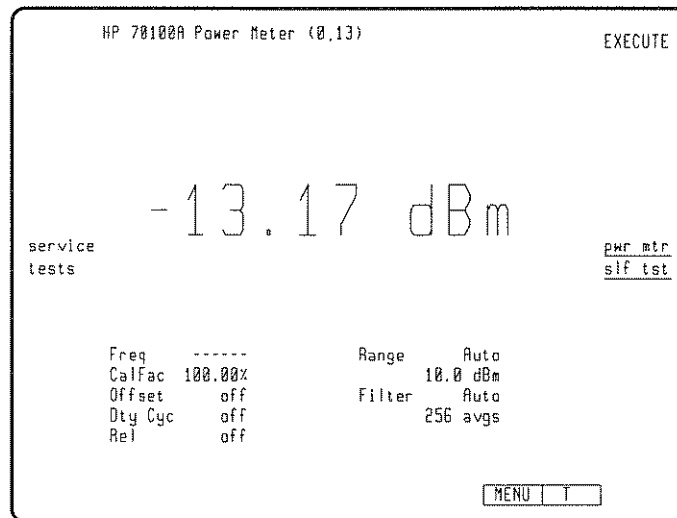

Figure 5-3. Power Meter Self Test Menu

When the self tests are activated, the Modular Measurement System screen will display an array that shows the test being performed and whether it passed or failed. Figure 5-4 shows an example of the array.

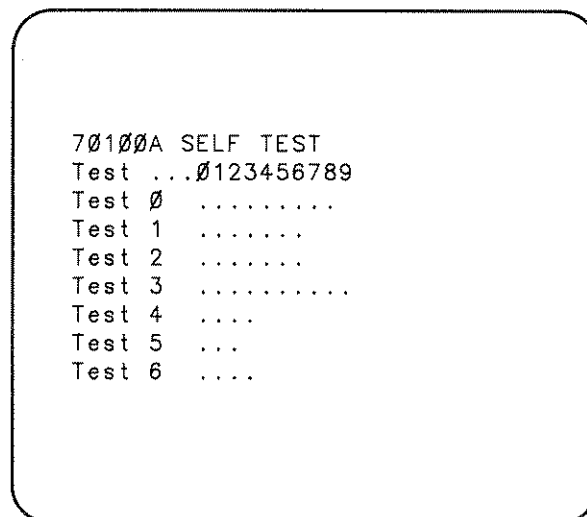

Figure 5-4. Power Meter Self Test Array

Each test in the self tests is identified by a number. The rows of the displayed array indicate the prefix of the number, the columns indicate the suffix of the number. For example, the third row and 1st column indicate test number 3.1.

As the self tests are performed, the displayed array will indicate whether the test passed or failed. The array will display “p” if the test passed and “F” if the test failed. This display can be used to pinpoint tests to be performed using the diagnostics. This display can be recalled at anytime while using the diagnostics.

Note

Some of the Power Meter self tests will give false indications of failure if:

1. No power sensor is attached to the Power Meter input port.
 2. A significant level of RF is present at the power sensor.
 3. The Power Meter is outside its normal enclosures (such as on the Module Extender)
-

Performance Tests

HP 70100A Power Meter Performance Tests contain tests of specified performance. Refer to Chapter 4 for more information.

Display Tests

For a description of the display tests, refer to the Troubleshooting section of the Installation and Verification Manual for the HP 70205A Graphics Display or HP 70206A System Graphics Display.

HP-MSIB Troubleshooting Utility

For a description of the HP-MSIB Troubleshooting Utility, refer to the Troubleshooting section of the Installation and Verification Manual for the HP 70205A Graphics Display or HP 70206A System Graphics Display.

Diagnostic Procedures

This section contains the following procedures for diagnosing problems in HP 70100A Power Meter Systems:

- Categorizing Failures
- Troubleshooting from the Front Panel
- Troubleshooting over HP-IB
- Troubleshooting Catastrophic Failures
- Using the HP-MSIB Troubleshooting Utility

If you have not already read the Troubleshooting Tools section in this chapter, read it before beginning these procedures.

Categorizing Failures

Most system problems can be isolated using either Troubleshooting from the Front Panel or Troubleshooting over HP-IB. However, because this troubleshooting information is dependent upon running troubleshooting routines, it is not useful when there is a catastrophic failure.

Catastrophic failures prevent the system from running troubleshooting routines. These failures usually result in a blank or distorted CRT screen, flashing error lights, or no User or Menu screen softkeys.

The following procedure allows categorization of system failures, and directs you to the troubleshooting information that will be the most helpful. Before beginning this procedure, make note of any error messages that are present.

1. Cycle mainframe power and wait about ten seconds.
2. If the CRT shows a display-disruptive error, the display instrument (for example, HP 70205A) is faulty. Refer to the appropriate Service Manual for further troubleshooting and repair information.
3. If the User screen softkeys are shown on the CRT, the problem is not caused by a catastrophic failure. If a problem still exists, troubleshoot it using the Troubleshooting from the Front Panel or Troubleshooting over HP-IB sections on the following pages.
4. If the CRT does not show the User screen softkeys, use the following steps to assign the display window.
 - a. Press **[DISPLAY]**.
 - b. Press **SELECT INSTR**.

Note



If there is more than one system on the HP-MSIB, the **SELECT INSTR** softkey assigns the display window to the element with the lowest HP-MSIB column address. If you do not want to test this element, press the **[▲]** key to select the element with the next-highest HP-MSIB column address. In this manner you can assign the display window to any element.

5. Press the [USER] key.
 - a. If the User screen softkeys are shown on the CRT, the problem is not caused by a catastrophic failure. If a problem still exists, troubleshoot it using the Troubleshooting from the Front Panel or Troubleshooting over HP-IB sections on the following pages.
 - b. If the User screen softkeys are still not shown, the system has a catastrophic failure. Refer to Troubleshooting Catastrophic Failures, in this section, for further troubleshooting information.

Note

If the display window assignment is lost when the instrument is turned off, the display battery needs replacing. A dead battery will result in a 6008 Confidence Test Failed error message at power-on and a 6002 A6 RAM Check Sum error message when you press the **REPORT ERRORS** softkey (Display screen). To gain access to the battery, remove the screws from the BATTERY cover at the rear of the stand-alone display or the display module. Battery part number information is in the System Replaceable Parts section of this chapter.

Troubleshooting From The Front Panel

The following procedure uses most of the troubleshooting tools of the system. Before attempting to diagnose an instrument failure, use this procedure to collect all possible clues.

1. The display instrument will be tested first. Use the procedure below to run Confidence Test, the self-test of the display instrument.
 - a. Press [DISPLAY].
 - b. Press **DISPLAY TESTS**.
 - c. Press **CONFID TEST**.
 - d. The display indicates on the CRT title line whether the Confidence Test passed or failed. If the Confidence Test failed, press **REPORT ERRORS**. Record the errors and refer to the appropriate display's Service Manual to repair the faulty display instrument. If the Confidence Test passed, continue with this procedure.
2. The HP 70100A Power Meter is tested using its self test. Use the following procedure to run the self test.

Note

When activated, the tests will run once, then stop. Press **service tests** then **RESET** to leave the self tests and return to the **Cal Funcs** menu.

- a. Press [MENU].
- b. Press **Misc**.
- c. **service**
Press **tests**.
- d. **pwr Mtr**
Press **slf tst**.
- e. Press **EXECUTE**. As the self tests are run, a **p** (pass) or an **F** (fail) will be displayed for each test. If an **F** is displayed for any of the tests, refer to Chapter 4 in the HP 70100A Power Meter Service Manual for further troubleshooting information.

If no error messages were generated by the procedure and you still suspect an instrument failure, run the performance tests to verify that the system meets its specifications. Refer to Chapter 4 for instructions.

Troubleshooting Over HP-IB

Troubleshooting over HP-IB is recommended only if you do **not** have access to a display instrument (for example, HP 70205A). For more information, refer to Section 8 of the HP 70100A Service Manual. The part number of the Service Manual can be found on the title page of this manual.

Troubleshooting Catastrophic Failures

Catastrophic failures prevent the system from running most troubleshooting routines. These failures usually result in an abnormal CRT screen, no User or Menu screen softkeys, or flashing error lights.

Note



Before troubleshooting a catastrophic failure, verify that the correct line power is applied to the mainframe (and stand-alone display, if used). The mainframe power-on indicator should light when the LINE switch is turned on. If the power-on indicator does not light, refer to the HP 70001A Mainframe Service Manual for troubleshooting information.

Abnormal CRT Screen

Troubleshooting information is given below for the following symptoms: blank or distorted CRT display, message written in large block letters on the CRT display, and the CRT showing the Display ID screen.

A blank or distorted CRT display

If a display module (for example, HP 70205A) has a blank or distorted CRT display after power to the system is cycled, the display module is faulty. Refer to the appropriate Service Manual for further troubleshooting and repair information.

If a stand-alone display (for example, HP 70206A) has a blank or distorted CRT display, disconnect the HP-MSIB cables and cycle power on the stand-alone display. If the CRT is still

blank or distorted, the stand-alone display is faulty. Refer to the appropriate Service Manual for repair information.

CRT blank except for a message written in large block letters

The message is a display-disruptive message. It indicates a faulty display instrument. Refer to the appropriate Service Manual for repair information.

CRT shows Display ID screen

The Display ID screen shows the following information about the display instrument: model number, firmware version, HP-MSIB address, HP-IB address, and Dot Generator release date. If this information is shown on the CRT, either the display window is not assigned to an element, or the display cannot talk to an element. Assign the display window to an element by pressing [DISPLAY], then **SELECT INSTR.** This assigns the display to the element with the lowest column address. Press the [▲] key to assign the display to the element with the next-highest address. If the display window cannot be assigned to an element, then a module with a faulty HP-MSIB interface is hanging up the system, or the HP-MSIB or element is faulty. Refer to Using the HP-MSIB Troubleshooting Utility to further troubleshoot the problem. The HP-MSIB Troubleshooting Utility is found in the Troubleshooting section of the Installation and Verification Manual for the display.

Note



If the display window assignment is lost when the instrument is turned off, the display battery needs replacing. A dead battery will result in a 6008 Confidence Test Failed error message at power-on and a 6002 A6 RAM Check

REPORT

Sum error message when you press the **ERRORS** softkey (Display screen).

To gain access to the battery, remove the screws from the BATTERY cover at the rear of the stand-alone display or the display module. Battery part number information is in the Replaceable System Parts section of this chapter.

Missing User or Menu Screen Softkeys

If the User or Menu screen softkeys are missing, press [DISPLAY], then **SELECT INSTR** to assign the display window to the element with the lowest column address. Press the [▲] key to assign the display to the element with the next-highest address.

Press [USER] or [MENU]. If the User or Menu screen softkeys are still missing, refer to Using the HP-MSIB Troubleshooting Utility to further troubleshoot the problem. The HP-MSIB Troubleshooting Utility is found in the Troubleshooting section of the Installation and Verification Manual for the display.

Error Lights

Troubleshooting information is given below for the following symptoms: flashing E (error) letter or ERR (error) light, lit I/O indicator on an HP 70206A System Graphics Display, and lit VOLT/TEMP, CURRENT, or I/O CHECK on an HP 70001A Mainframe.

Flashing E (error) letter or ERR (error) light

If the E letter or the ERR light of an element flashes at a 1 Hz rate, the element cannot talk on the HP-MSIB and is probably faulty. If more than one module flashes its error indicator at a 1 Hz rate, either the mainframe HP-MSIB is faulty, a faulty module is disrupting the whole HP-MSIB, or the HP-MSIB cables are faulty. (It is possible, but not probable, for a module to disrupt the whole HP-MSIB without flashing its own error indicator.) Refer to Using the HP-MSIB Troubleshooting Utility to further isolate the problem. The HP-MSIB Troubleshooting Utility is found in the Troubleshooting section of the Installation and Verification Manual for the display.

The I/O indicator on the HP 70206A System Graphics Display is lit

The HP 70206A System Graphics Display I/O indicator light should be off when both HP-MSIB cables are either connected to or disconnected from the HP 70206A. It should be lit when only one HP-MSIB cable is connected to the HP 70206A. Follow the troubleshooting procedure below to isolate other causes of the I/O indicator being lit:

1. Verify that all mainframes and stand-alone displays on the HP-MSIB have their power turned on.
2. Check for proper HP-MSIB cable connections, making sure that all cable connections are secure.
3. Disconnect the HP-MSIB cables from the HP 70206A.
 - a. If the I/O indicator is still lit, the HP 70206A System Graphics Display is faulty. Refer to the HP 70206A System Graphics Display Service Manual for further troubleshooting and repair information.
 - b. If the I/O indicator is not lit, the problem is either in the cables or in the instrument that was connected by the cables to the HP 70206A System Graphics Display. Reconnect the HP-MSIB cables and use the HP-MSIB Troubleshooting Utility to further isolate the problem. The HP-MSIB Troubleshooting Utility is found in the Troubleshooting section of the Installation and Verification Manual for the display.

HP 70001A Mainframe VOLT/TEMP indicator is lit

The VOLT/TEMP indicator usually lights because the input voltage is too low or the internal temperature on the mainframe power-supply board assembly exceeds the normal operating temperature.

1. Check the LINE VOLTAGE SELECTOR on the bottom of the mainframe to make sure the selector setting matches the line voltage.
2. Allow the instrument to cool. If the temperature decreases to normal operating range, the mainframe will attempt to restart itself. After the instrument has restarted, verify that the cooling fans are operating by visually checking the airflow into both fan-intake openings in the rear panel of the mainframe.

If neither of the above steps result in correction of the problem, the HP 70001A Mainframe is faulty. Refer to the HP 70001A Mainframe Service Manual for further troubleshooting and repair information.

HP 70001A Mainframe CURRENT indicator is lit

The CURRENT indicator lights when a module in the mainframe is drawing too much current.

1. Remove one module from the mainframe.
2. Cycle the power.
 - a. If the CURRENT indicator is no longer lit, the module is faulty. Verify this by replacing the module in the mainframe and seeing if the CURRENT indicator lights again. Refer to the appropriate Service Manual for repair information.
 - b. If the CURRENT indicator is still lit, the module is not faulty. Repeat steps 1 and 2 until a faulty module is identified.
3. If the CURRENT indicator is still lit when all of the modules have been removed from the mainframe, the mainframe is faulty. Refer to the HP 70001A Mainframe Service Manual for further troubleshooting information.

HP 70001A Mainframe I/O CHECK indicator is lit

The I/O CHECK light should be off when both HP-MSIB cables are either connected to or disconnected from the HP 70001A Mainframe. It should be lit when only one HP-MSIB cable is connected to the mainframe.

To isolate other causes of the I/O CHECK's being lit, use the following procedure.

1. Verify that all mainframes and stand-alone displays on the HP-MSIB have their power turned on.
2. Check for proper HP-MSIB cable connections, making sure that all cable connections are secure.
3. Disconnect the HP-MSIB cables from the mainframe.
 - a. If the I/O CHECK light is still lit, the HP 70001A Mainframe is faulty. Refer to the HP 70001A Mainframe Service Manual for further troubleshooting information.
 - b. If the I/O CHECK light is no longer lit, the problem is either in the cables or in the instrument that was connected by the cables to the mainframe. Reconnect the HP-MSIB cables, and refer to Using the HP-MSIB Troubleshooting Utility to further isolate the problem. The HP-MSIB Troubleshooting Utility is found in the Troubleshooting section of the Installation and Verification Manual for the display.

Error Messages

The HP 70100A generates error messages during operation when an incorrect instrument state is sensed. When an error message is generated the “ERR” annunciator on the Power Meter’s front panel is lit. The resulting error message can be viewed in one of two ways:

1. If the Power Meter’s readings are on the display, the error message will be displayed on the screen.
2. If the Power Meter’s readings are **not** on the display, the Modular Measurement System will place a small “e” in the lower right corner of the display. The error message can be viewed by using the following procedure:
 - a. Press the [DISPLAY] (or DSP) key.

- b. Press the **REPORT**
ERRORS key.

The display will show the error message and the instrument that is generating the message.

Error messages are displayed in two formats: primary messages and secondary messages. The primary messages are displayed across the full Power Meter screen. When a primary error message is displayed, any power measurements are removed from the display. Secondary messages are warnings. These indicate that a parameter entry is incorrect or that an action needs to be taken. The secondary messages are displayed on the screen below the Power Meter instrument settings. Secondary messages do not change the power measurement display in any way. Under certain conditions both a primary and secondary message can be displayed.

Primary messages are described in Table 5-1, and secondary messages are describe in Table 5-2.

Table 5-1. Primary Error Messages

Error Code	Error Display	Message	Action Required
01	ZERO ERROR	Power Meter cannot zero the sensor.	Ensure that no RF power is being applied to the sensor during zeroing.
05	CAL ERROR	Power Meter cannot calibrate sensor.	Make sure power sensor is connected to a 1 mW 50 MHz source.
11	Input overload	Input overload	Reduce input power.
15	PLEASE ZERO	Sensor's zero reference has drifted negative.	Zero sensor. If error persists, check input power.
17	Up Range	Input power on sensor is too high for current range.	Select a higher range, reduce input power to sensor, or use AUTO RANGE.
19	Down Range	Input power on sensor is too low for current range.	Select a lower range, increase input power to sensor, or use AUTO RANGE.
31	NO SENSOR	No power sensor connected to the input.	Connect a power sensor to the input.
33	TWO SENSORS	Both front and rear sensor inputs have sensors connected (Option 002 or Option 003 only).	Remove one of the 2 sensors connected to sensor input.
41	PLEASE CAL	Power sensor needs calibration	Calibrate the power sensor.
57	Recall Failure	Continuous memory failure.	Refer to Table 5-2, Error 40.
99	Too Many Errors	Error queue overload.	Use REPORT ERRORS softkey on Display module.

Table 5-2. Secondary Error Messages

Error Code	Error Display	Message	Action Required
21	OVER LIMIT	Power reading over high limit.	Check input power at sensor, adjust limit, or disable limit checking function.
23	UNDER LIMIT	Power reading under low limit.	Check input power at sensor, adjust limit, or disable limit checking function.
40	BAD BATTERY	Low voltage/current in memory protection battery.	Replace A3BT1 (on Service Sheet A3b)
42	New Sensor: Zero & Cal	New sensor connected.	Zero and calibrate the sensor.
	ENTRY ERROR:¹		
50	CFAC 1-150%	Entered calibration factor out of range.	Enter new calibration factor between 1% and 150%.
51	OS ±99.99dB	Entered offset out of range.	Enter new offset between +99.99 dB and -99.99 dB.
52	RANGE: 1-5	Entered range is incorrect.	Select new range between 1 and 5.
53	FILTER 0-9	Entered filter number out of range.	Select new filter number between 0 and 9.
54	ST 1—19	Entered storage or recall register number is out of range.	Re-enter register number between 1 and 19.
55	Protected	Attempted storage to protected register.	Select another register or turn off protection.
56	RCF 50-120%	Entered reference cal factor out of range.	Enter new reference cal factor between 50% and 150%.

Table 5-2. Secondary Error Messages (cont'd)

Error Code	Error Display	Message	Action Required
81	DY 1-100%	Entered duty cycle out of range.	Enter new duty cycle between 1% and 100%.
82	FR<100kHz, FR>999.9GHz	Entered frequency value out of range.	Re-enter frequency value between 100 kHz and 999.9999 GHz.
83	LL<1E-20mW, LL<-199dBm, LL>1E10mW, LL>99dBm	Lower limit out of range.	Reset limit to be >-199 dBm.
84	LH<-199dBm, LH<1E-20mW, LH>1E10mW, LH>99dBm	Upper limit out of range.	Reset limit to be <+99 dBm.
85	RES: 1-3	Entered resolution is out of range.	Re-enter resolution number between 1-3
86	RF 50-120%	Sensor table reference calibration factor is out of range.	Re-enter reference cal factor between 50.0 and 120%.
89	RR<-199dBm, RR<1E-20mW RR>1E10mW, RR>99dBm	Entered reference level for REL is out of range.	Re-enter reference level between -199 dBm and +99 dBm.
91	HP-IB error	Invalid HP-IB code	Check, then re-enter correct HP-IB code.
92	ESE 0-255	Status enable mask out of range.	Re-enter status enable mask value.
93	SRE 0-255	SRQ mask value out of range.	Re-enter mask value between 0-255

¹The error display for Error codes 50 through 93, excluding 55 and 91, are preceded by ENTRY ERROR:.

Replaceable System Parts

This section contains ordering information and the following system-level replaceable-parts tables:

- Table 5-3. Cabinet Interconnect and Rack-Mount Kits
- Table 5-4. Interconnection Cables and Adapters
- Table 5-5. Miscellaneous System-Level Parts
- Table 5-6. Service Accessories

Instructions for returning a faulty instrument to Hewlett-Packard for repair are given in the Packaging section of Chapter 1. For more information about troubleshooting, repair, and lower-level parts, refer to the appropriate Service Manual for the mainframe or element.

Ordering Information

To order a part that is listed in the replaceable parts list, contact the nearest Hewlett-Packard office and give the following information:

1. Hewlett-Packard part number of each part required
2. Check digit (CD) of each part (if known)
3. Quantity required
4. Name and address for delivery and billing

To order a part that is **not** listed in the replaceable parts list, contact the nearest Hewlett-Packard office and give the following information:

1. Model number of element or mainframe that needs replacement part.
2. Serial number of element or mainframe
3. Description and function of each part required
4. Quantity required
5. Name and address for delivery and billing

Direct Mail-Order System

Within the USA, Hewlett-Packard can supply parts through a direct mail-order system. The advantages of using this system are listed below.

1. Direct ordering and shipment from the HP Parts Center in Roseville, California
2. No maximum or minimum on any mail order (There is, however, a minimum order amount for parts ordered through a local HP office when the orders require billing and invoicing.)
3. Prepaid transportation (There is a small handling charge for each order.)
4. No invoices (A check or money order must accompany each order.)

Mail order forms and specific ordering information are available through your local HP office.

Replaceable Parts Tables

Table 5-3. Cabinet Interconnect and Rack-Mounting Kits

HP Part Number	CD	Description
70001-60059	9	Cabinet Interconnect Kit: to connect a mainframe to another mainframe
5061-9061	6	Cabinet Interconnect Kit: to connect a mainframe to a System Graphics Display
5061-9678	7	Rack Flange Kit: to mount w/out handles (Same as Option 908)
5061-9684	9	Rack Flange Kit: to mount with handles (Same as Option 913)
1494-0058	6	Rack-Mount with Slides: to mount mainframe in HP Rack (Same as Option 010)
1494-0059	7	Rack-Mount with Slides: To mount System Graphics Display in HP rack (Same as Option 011)
1494-0064	4	Adapter Kit: for rack-mount with slides in non-HP rack (Use with Option 010, or HP Part Number 1494-0058)
1494-0061	1	Adapter Kit: for rack-mount with slides in non-HP rack (Use with Option 011, or HP Part Number 1494-0059)

Table 5-4. Interconnection Cables and Accessories

HP Part Number	CD	Description
		HP-MSIB Cables
HP 70800A		Cable: HP-MSIB, 0.5 meter
HP 70800B		Cable: HP-MSIB, 1.0 meter
HP 70800C		Cable: HP-MSIB, 2.0 meter
HP 70800D		Cable: HP-MSIB, 6.0 meter
HP 70800E		Cable: HP-MSIB, 30 meter

Table 5-5. Miscellaneous System-Level Parts

HP Part Number	CD	Description
5061-9006	7	Panel: front blank 1/8 module size, for use in mainframe
70001-40017	7	Filter: optional air filter, for mainframe
1420-0315	3	Battery: 3.60V 1.7AH, for use in displays
70001-60066	8	Isolation Transformer Assembly: for 400 Hz

Table 5-6. Service Accessories

HP Part Number	CD	Description
		Display Service Accessories
70206-60029	0	Extender Kit: for servicing displays, includes the following extenders:
70206-60027	8	Extender: for host board assembly
70206-60028	9	Extender: for memory and dot generator board assemblies
70205-60022	2	Extender: 24 pin, for HP 70205A power supply board assembly and HP 70206A sweep board assembly
70206-60041	6	Extender: special, for HP 70206A only
70206-60042	7	Extender: for HP-MSIB
		Miscellaneous System Service Accessories
70001-60013	5	Module Service Extender
8710-1307	7	8MM Hex-Ball Driver: for removing and installing modules

Power Meter Functions

This chapter describes the functions of the HP 70100A Power Meter that perform all power meter operations. These functions are accessed through softkeys via the display module.

The organization of this chapter first prepares the user for operation of the power meter system. Then the Display Keys Overview presents general concepts that apply to the hardkey and softkey menu structure and also briefly describes the display screen status and annotation. Finally, for convenience, the display keys are divided into five groups according to their function: **Cal Funcs** (Calibration Functions), **Meas Funcs** (Measurement Functions), **State**, **Misc** (Miscellaneous), and **dBm W**.

For each functional group, the Overview provides a listing of each softkey in that group with a brief one-line functional description. After the Overview section, more detailed functional information follows for each softkey. A brief summary of each section in this chapter is listed below.

- **Preparation For Power Meter Operation** describes how to prepare the power meter system for initial operation.
- **Display Key Overview** describes general concepts that pertain to the hardkeys and softkeys and their functions.
- **Calibration Functions** set up the parameters of a calibration. This group includes the functions of calibrate, zero, power reference, and sensor data.
- **Measurement Functions** setup the parameters of a measurement. This group includes the functions of frequency, calibration factor, offset, duty cycle, relative measurement, range, filter averages, resolution, limits, and trigger.
- **State Functions** provide for storing, recalling, and displaying instrument states.
- **Misc Functions** contain housekeeping and service functions. This group includes the functions of annotation on and off, entry hold, and service tests.

Preparation For Power Meter Operation

The display front-panel keys are necessary to access the functions of the power meter system.

- The [DISPLAY] key accesses the entire Display Main Menu, which enables all the display functions. For more information on the display, refer to the display documentation.
- The [MENU] key accesses the functions of the Power Meter.
- The [USER] key performs the same function as the [MENU] key.
- The [I-P] (Instrument Preset) key sets the Power Meter to a known state. Table 6-1 lists the Power Meter parameters that are set after preset.

Table 6-1. Power Meter Preset Parameters

Parameter	Setting
Calibration Factor	100.0%
Duty Cycle	100%; Off
Frequency	50 MHz
Display Units	Linear
Upper Limit	90 dBm; Off
Lower Limit	-90 dBm; Off
Offset	0
Power Reference	Off
Resolution	.01 dBm (.1%)
Filtering	Auto
Range	Auto
Relative Measurement	Reference= 1mW; Off
Response to GET	Trigger with Delay
Thresh	Off
Trigger	Freerun

The Power Meter system must be properly installed and configured prior to performing any manual operations. Refer to the Installation section of this manual for correct installation and configuration instructions for a Power Meter system. Use the following procedure to prepare the Power Meter for operation.

1. Press the [DISPLAY] key on the display front panel to access the Display Main Menu.
2. Press **SELECT INSTR** until the HP 70100A Power Meter is selected as the active module.
3. Press the [MENU] key to display the Main Menu of the Power Meter, which consists of 5 dedicated softkeys.
4. If desired, press [I-P] to set the Power Meter to a known state. Refer to Table 6-1.

Note



To return to the Main Menu from the second-level menu structure, press the [Menu] or [←] key on the display front panel.

Display Keys Overview

The HP 70100A Power Meter Main Menu is shown in Figure 6-1. The Main Menu consists of dedicated softkeys and softkeys whose function can be changed. The softkeys on the left side of the display are dedicated softkeys. The functions associated with these keys do not change. The functions associated with the softkeys on the right side of the display do change. The functions for the softkeys on the right side of the display are dependent upon which dedicated softkey is selected. If a key is shown in lower case, this indicates that a lower-level menu exists. A key shown in upper-case letters indicates that there are no further lower-level menus.

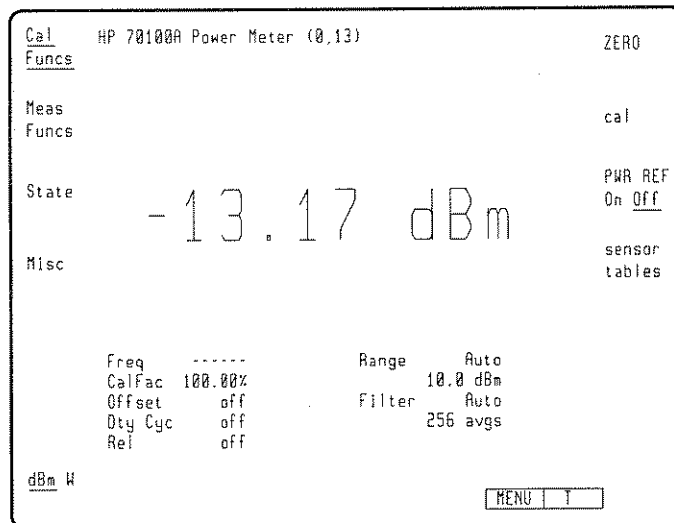

Figure 6-1. HP 70100A Power Meter Main Menu

When a dedicated softkey is selected the label for the key will flash in inverse video and the label will then be underlined. When a softkey is selected and its function is performed immediately, the label for the key will flash in inverse video. If a softkey is selected that requires data to be entered, the label for the softkey will be displayed in inverse video.

For some softkey functions, data values are required. These may be entered using three methods: the numeric key pad, the step up/down arrow keys, and the RPG (rotary pulse generator) knob. If applicable, the use of each method is described in the Procedure section following each softkey description.

Note



When the RPG knob is turned, its rate of change is determined by the speed at which the knob is turned, unless otherwise noted.

Along with measurement information, the Power Meter displays three other types of information:

- Data for functions that require data entry.
- Error messages, including measurement, entry, and service.
- Annotation block

If a function requires that data be entered, the data will appear in the upper left section of the display. The data will continue to be displayed until another Power Meter function is

selected or **ENTRY** is used. Refer to the Misc (Miscellaneous) portion of this chapter for more information about entry hold.

Measurement errors, such as, ZERO ERROR and NO SENSOR, are displayed in the measurement area of the display. Entry and service errors are displayed in the lower left section of the display window.

The annotation block allows the user to display certain Power Meter parameters. The parameters that can be displayed are listed below:

- Frequency
- Cal factor
- Offset
- Duty Cycle
- Rel (relative measurement)
- Range
- Filter

A graphic representation of all the HP 70100A Power Meter softkeys and how they relate to the overall Main Menu of the Power Meter is shown in Figure 6-2. Corresponding remote commands are described in the "Remote Operation and Programming" section of this manual.

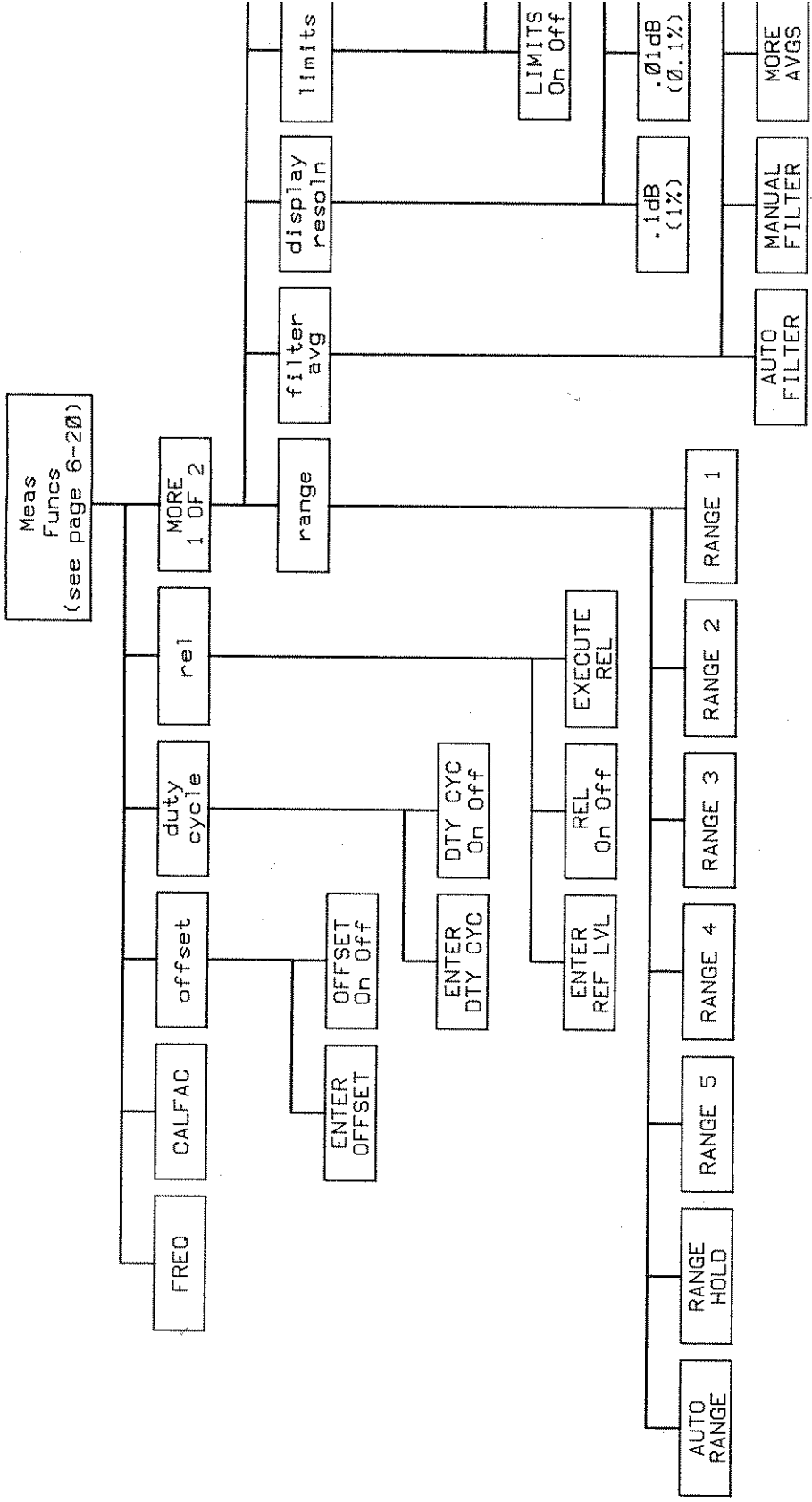
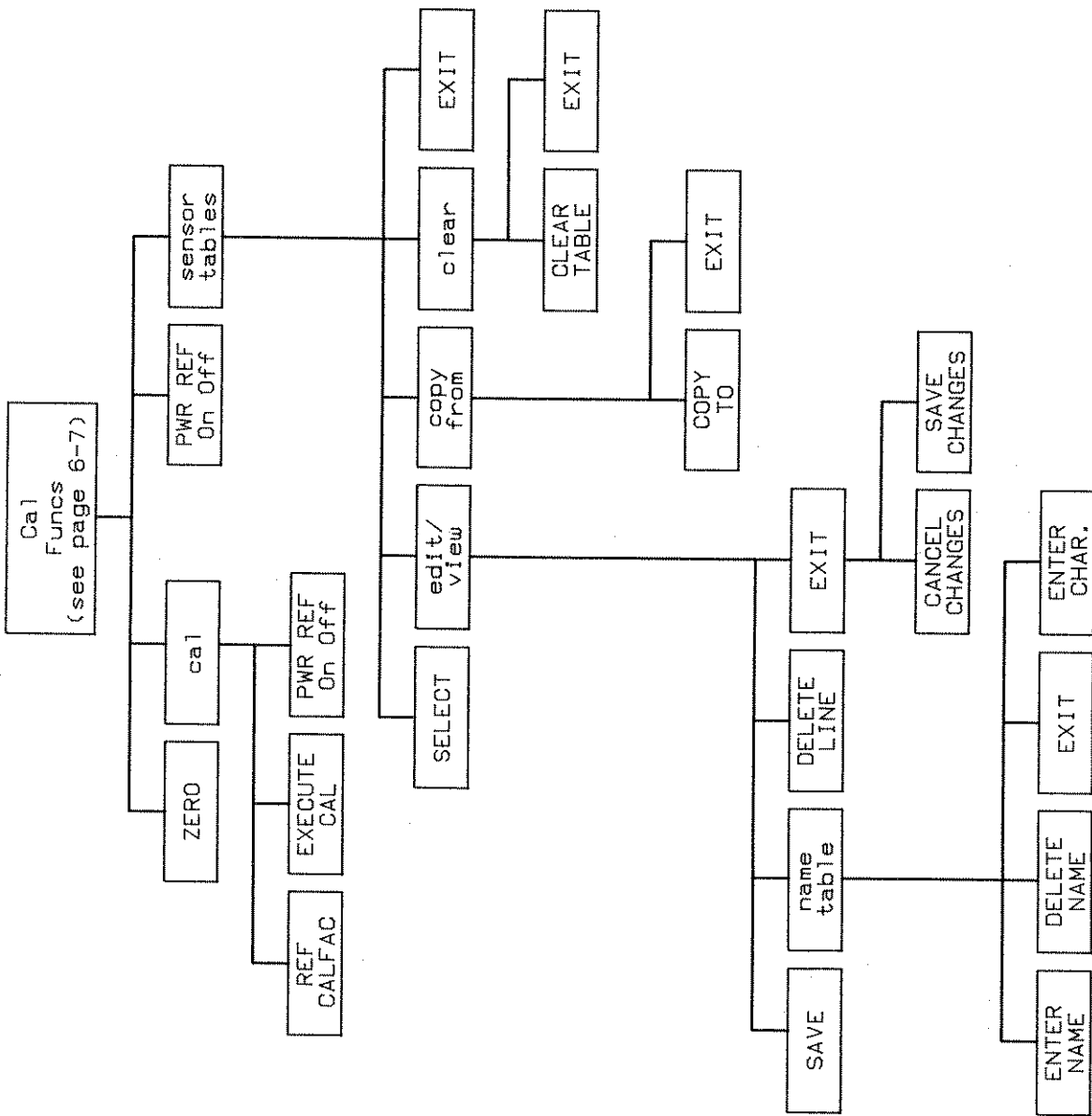

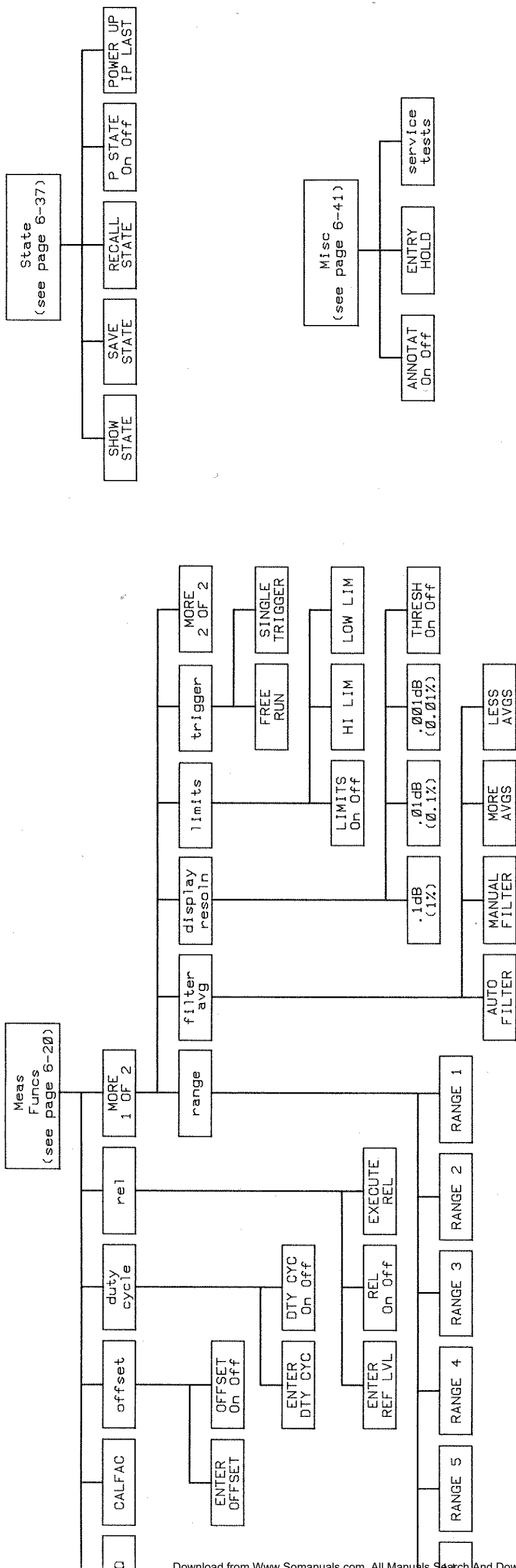

Figure 6-2. HP 70100A Menu Tree
6-5/6-6

Calibration Functions (Cal Funcs)

Calibration Functions establish the parameters for an accurate power measurement and include the following functions: **ZERO**, **cal** (calibrate), **PWR REF On Off** (power reference), and **sensor tables**. These functions may be accessed through the **Cal Funcs** key of the Power Meter display screen. The Cal Funcs menu is shown in Figure 6-3.

The zero, cal, pwr ref, and sensor tables softkey functions are briefly described below and in more detail following the Overview section.

Overview

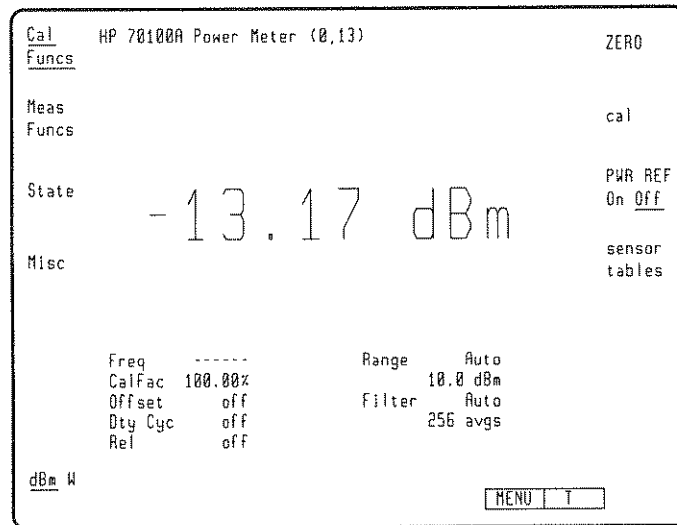

Figure 6-3. Cal Funcs Menu

ZERO will adjust the Power Meter's internal circuitry for a zero power indication when no power is applied to the sensor.

cal accesses another menu that is used to calibrate the Power Meter and a compatible power sensor to a known reference.

REF

CALFAC allows entry of the reference cal factor.

EXECUTE

CAL starts a calibration of the Power Meter and a compatible power sensor to a known reference.

PWR REF

On Off is used to turn on or off a stable 50 MHz, 1 mW signal at the POWER REF output connector on the front panel.

PWR REF

On Off this softkey performs the same function as the softkey described above.

sensor

tables accesses another menu that is used to select, edit, copy, and clear the frequency versus cal factor sensor data tables.

SELECT is used to choose the sensor data table that is to be active.

edit/

view will display the selected sensor data table.

SAVE is used to save sensor data when one of the sensor data tables has been modified.

name

table will access another menu that is used to name a sensor data table.

ENTER

NAME is used to enter the name of a sensor data table.

DELETE

ENTER

NAME will delete a newly entered name, only if **NAME** has not been pressed. The

new name will be deleted and the old name will be retained. **DELETE** **NAME** can't be used to delete an existing name.

edit/

EXIT will take the user to the **view** menu.

ENTER

CHAR. is used to enter a character for the name of a sensor data table.

DELETE

LINE allows the user to delete a frequency versus cal factor point in a sensor data table.

edit/

sensor

EXIT allows the user to leave the **view** menu and return to the **tables** menu. When **EXIT** is pressed another menu comes up which allows the user to save or cancel any changes that may have been made.

CANCEL

CHANGES terminates data entry and any changes are not kept.

SAVE

CHANGES terminates data entry and saves any changes that were made.

copy from accesses another menu that is used to copy a sensor data table.

COPY TO will duplicate a sensor data table into another table location.

EXIT will return the user to the **sensor tables** menu if it is decided not to use the copy function.

clear will access another menu that is used to delete all frequency versus cal factor data points from a sensor data table.

CLEAR TABLE will delete all data points from the selected sensor data table.

EXIT will return the user to the **sensor tables** menu if it is decided not to use the clear function.

EXIT will return the user to the **Cal Funcs** main menu.

Cal Funcs Detailed Operating Information

Zero (ZERO)

ZERO will adjust the the Power Meter's internal circuitry for a zero power indication when no power is applied to the power sensor. Pressing **ZERO** automatically zeros all five of the Power Meter's ranges. When **ZERO** is pressed, "Zeroing*****" will appear on the display. The asterisks will begin disappearing as the routine progresses.

Zeroing Procedure

Note



Ensure that no power is applied to the sensor while the Power Meter is zeroing. Any applied RF input power will cause an erroneous reading.

Zeroing will typically take 15 seconds. Zeroing time may vary depending on the power sensor used.

1. Disconnect the power sensor from any power sources.
2. Press **ZERO**. The power meter will display "Zeroing*****".
3. The asterisks will begin disappearing as the routine progresses.

Calibration (cal)

cal accesses another menu. Refer to Figure 6-4. This menu allows entry of the reference cal factor, the calibration of the Power Meter and any compatible power sensor to a known reference, and turning on or off of the power reference.

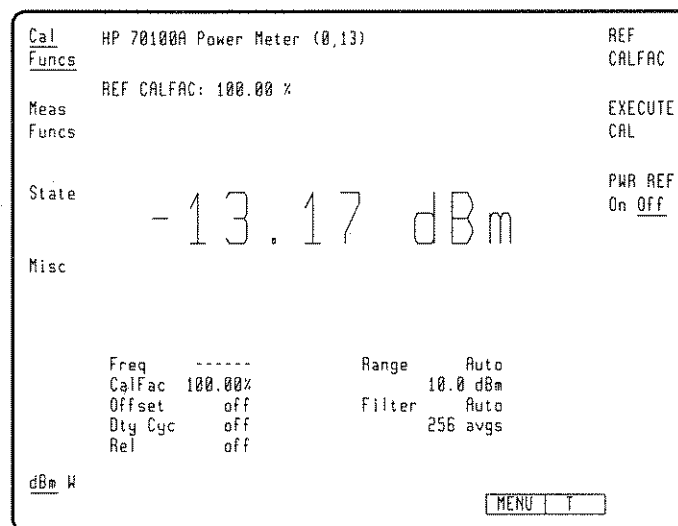

Figure 6-4. Cal Menu

When **cal** is pressed the menu shown in Figure 6-4 will be displayed. The reference cal factor is displayed in the upper left corner of the menu. A new reference cal factor can be entered

using the numeric keypad, or the current reference cal factor can be retained. The reference cal factor has a range of 50 to 120%. If a sensor table is being used, the reference cal factor from the sensor table will automatically come up.

The 50 MHz, 1 mW power reference is turned on or off by pressing **PWR REF** **On Off**.

To perform a calibration, press **CAL** **EXECUTE**. Pressing **CAL** **EXECUTE** turns the power reference on automatically. As the calibration is being performed, "Calibrate**" will be shown in the display. The asterisks will begin disappearing as the calibration progresses.

Calibration Procedure

1. Connect a power sensor to the Power Meter with a power sensor cable.
2. Connect the sensor to the POWER REF connector on the Power Meter's front panel.
3. Press **cal**, the menu shown in Figure 6-4 will be displayed.
4. Examine the power sensor to determine the REF CAL FACTOR.
5. Enter the REF CAL FACTOR using the numeric keypad, or retain the current reference cal factor. When the numeric keypad is used, another menu will be displayed containing the following softkeys: **%** **PERCENT** and **CLEAR** **%**. **PERCENT** is the data entry terminator, and **CLEAR** **%** will delete an entry, before **PERCENT** is pressed, if an error is made. The previously stored reference cal factor will then be displayed.

Note



If a reference cal factor is entered that is outside of 50 to 120 % the following error message will be displayed: ENTRY ERROR: RCF 50—120 %

When the reference cal factor is entered using the numeric keypad, pressing **%** **PERCENT** will start the calibration automatically.

6. To perform a calibration, press **CAL** **EXECUTE**. As the calibration is performed, "Calibrate**" will be shown on the display. The asterisks will begin disappearing as the calibration progresses.

Power Reference (PWR REF)

PWR REF **On Off** provides a stable 50 MHz, 1mW signal at the POWER REF output connector on the front panel. At preset the power reference is off. The power reference is used to calibrate the power sensor to the Power Meter. The softkey toggles the reference on and off.

Power Reference Procedure

1. **PWR REF**
 Press On **Off** to turn the reference on. When the reference is enabled, On is underlined.
2. **PWR REF**
 When the reference is enabled, press On **Off** to disable the reference. When the reference is disabled, Off is underlined.

Sensor Tables(sensor tables)

sensor tables accesses another menu as shown in Figure 6-5. This menu is used to select, edit/view, copy, and clear the ten power sensor data tables.

The sensor data tables allow the user to store complete frequency versus calibration factor data for up to ten sensors. Each table will contain enough space for eighty data points. Sensor data is entered into the tables in frequency/calibration factor pairs. These frequency/calibration factor pairs are entered into the tables from the graph (or table) of calibration factors printed on the side of the power sensor. When an operating frequency is used that is not a data point, the Power Meter will interpolate between the data points to calculate the correct calibration factor. If a measurement frequency is higher than the highest frequency in a sensor data table, the Power Meter will use the calibration factor for the highest frequency in the table. If a measurement frequency is lower than the lowest frequency in a sensor data table, the Power Meter will use the calibration factor for the lowest frequency in the table. When a sensor data table is used that doesn't contain any frequency versus calibration factor pairs, the Power Meter will use a calibration factor of one hundred percent for each measurement frequency. When shipped from the factory the sensor tables are loaded with typical data. The typical data comes from ten of Hewlett- Packard's more common power sensors. This data can be kept, modified, or erased by the user.

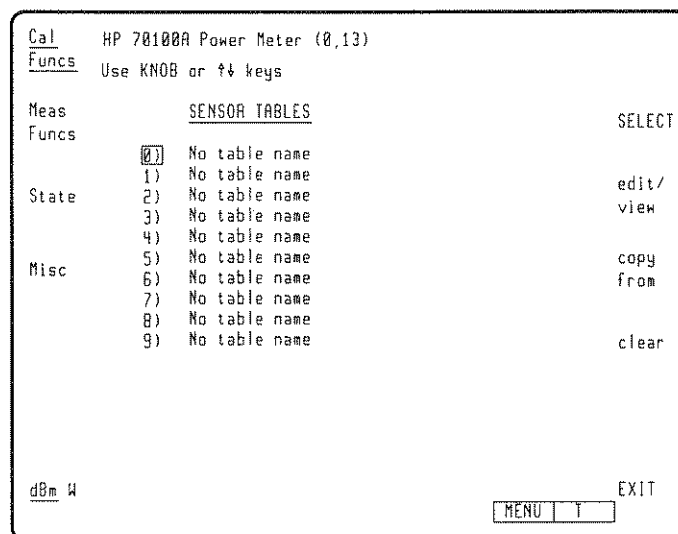

Figure 6-5. Sensor Tables Menu

When the sensor tables menu comes up, it will display a catalog of ten tables available as shown in Figure 6-5. If there is no information stored in a table, it will read "No table name"

until data is entered. The cursor is the box around one of the table numbers. The cursor can be moved around with the RPG knob or the arrow keys. The current or active table is the one highlighted in inverse video. Along with bringing up the sensor data tables, a new menu has been displayed which contains the following softkeys:

- SELECT
- edit/view
- copy from
- clear

Select (SELECT)

SELECT will enable a sensor data table to be active. When the key is pressed, the table number with the cursor around it will be active. That table number will then be highlighted in inverse video.

Select Procedure

1. Using the RPG knob or arrow keys, position the cursor box around the number of the table that is to be active.
2. Press **SELECT**. The selected table is now active and highlighted in inverse video.

Edit/View (edit/view)

Once a table has been selected, this function allows the table to be edited or just viewed.

Pressing **edit/view** will produce the display shown in Figure 6-6.

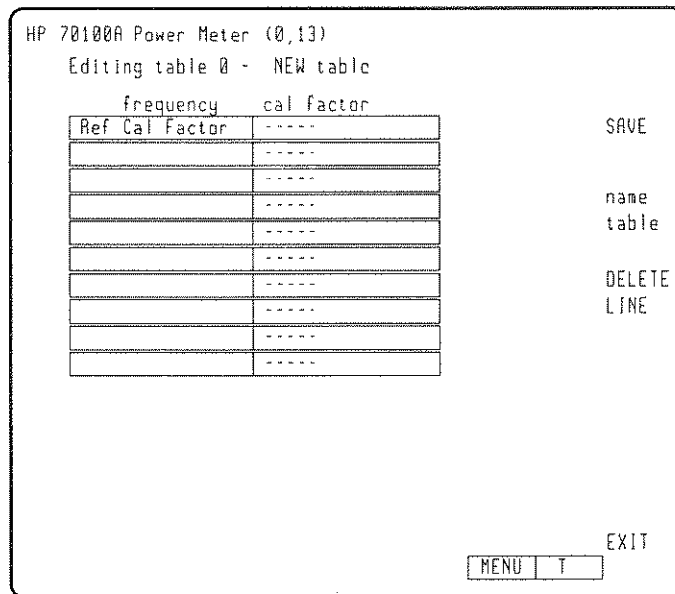

Figure 6-6. Edit/View Menu

The cursor box is moved around anywhere in the table to select which entries will be added, modified, or deleted. The cursor is moved around using the RPG knob or the up and down arrow keys. If the whole table won't fit on the display, the table scrolls when the cursor gets to the top or bottom of the display. As data points are entered, the proper terminator menu will automatically come up; the user then selects one of the following: GHz, MHz, kHz, or % PERCENT. Data points are entered using the numeric keypad. The reference calibration factor is always the first entry of the table.

Edit/View Procedure

1. Press **edit/**
view. The display will be as shown in Figure 6-6.
2. Move the cursor from box to box using the RPG knob or the up and down arrows keys.

Note



The allowable range of frequencies is 100 kHz to 999.90 GHz, and the allowable range for cal factor is 50% to 120%.

If an invalid frequency is entered, the following error message will be displayed:

Incorrect: XXXXX
range 100 kHz to 999.90 GHz

If an invalid cal factor is entered, the following error message will be displayed:

Incorrect: XXXXX
range 50% to 120%

3. Add or modify a frequency or cal factor using the numeric keypad. Using the keypad will cause a units menu to come up which is used to terminate data entry. Select the appropriate unit for the frequency or cal factor being entered. If an error is made during data entry, **CLEAR** will delete the current entry and restore the previous value. Delete a frequency/cal factor pair by using **DELETE** **DELETE** **LINE** **LINE**. **DELETE** **DELETE** will be explained in more detail at a later point in this text.
4. Save the table by pressing **SAVE**. **SAVE** will be explained in more detail at a later point in this text.

Along with displaying the contents of a sensor data table, **edit/**
view accesses another menu:

SAVE
name table
DELETE LINE
EXIT

Save (SAVE)

When all modifications have been made, **SAVE** will store the new data. The new data will be sorted by frequency. If duplicate frequency points were entered, the Power Meter saves the last entry.

Save Procedure

1. Once additions or modifications have been made to a table, press **SAVE**. All additions and modifications will be kept, and the frequency/cal factor pairs will be sorted by frequency.

Note



If there are any duplicate frequency entries, the last frequency entered will be kept.

Name Table (name table)

This function is used to name a sensor data table . When **name table** is pressed, the display will be as shown in Figure 6-7.

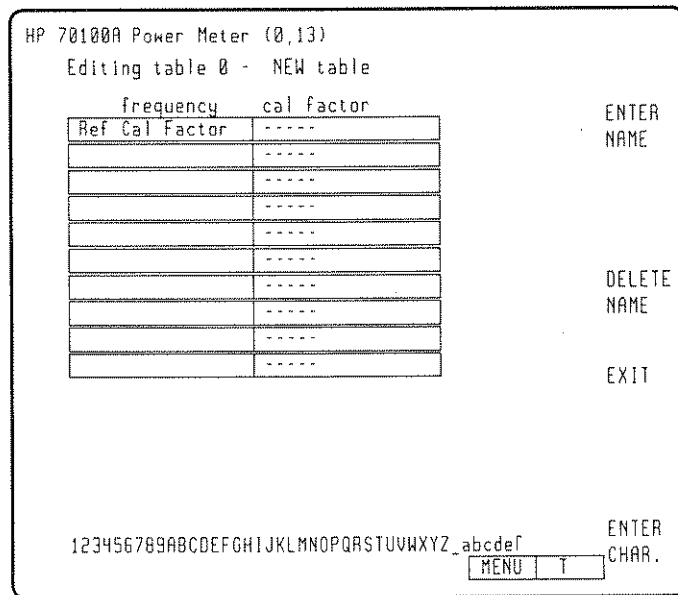

Figure 6-7. Name Table Menu

This function utilizes a canned routine which brings up a portion of the character set at the bottom of the display. One of the characters will be highlighted in inverse video.

Name Table Procedure

1. **name table**
Press **name table**. The menu will be as shown in Figure 6-7.

Note

Return to the **edit/**
view menu by pressing **EXIT**.

Pressing **ENTER**
NAME, before any characters have been selected, will give the table the default name "No table name".

2. Position the cursor, using the RPG knob, on the desired character at the bottom of the display.
3. Enter the character by pressing **ENTER**
CHAR.. The character will appear near the top of the display.

Note

Moving the cursor towards the left or right of the display will cause more characters to be displayed.

If the wrong character is entered, press [0] and the [←] key until the character is deleted, then select the desired character.

Press **DELETE**
NAME to delete the characters currently being entered and to retain the old name.

Repeat the procedure until the name is spelled out. A name can be up to ten characters to accommodate sensor serial numbers.

4. When the name is spelled out, enter it by pressing **ENTER**
NAME. The display will then show the **edit/**
menu for **view**.

Delete Line (DELETE LINE)

DELETE
LINE will delete the frequency versus cal factor data point that the cursor is on.

Delete Line Procedure

1. Position the cursor, with the RPG knob or arrow keys, on the frequency/cal factor pair that is to be deleted.
2. Press **DELETE**
LINE.

Exit (EXIT)

EXIT allows the user to access another menu that is used to return to the “sensor tables” menu. Refer to Figure 6-8.

Exit Procedure

Two selections are available: **CANCEL** and **SAVE**. Select **CANCEL** and any changes that were made will be lost. The table will be as it was before **edit/view** was selected. Select **SAVE** and any changes that have been made will be saved. **CHANGES** performs the same function as **SAVE**.

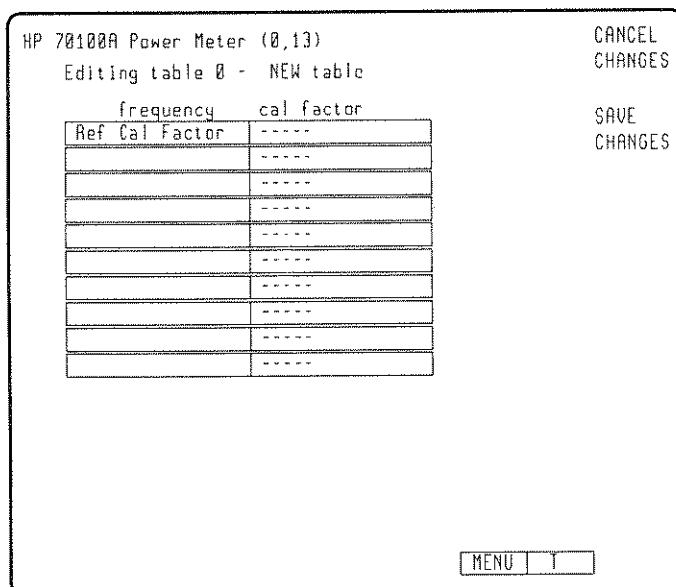

Figure 6-8. Exit Menu

Copy From (copy from)

copy from accesses another menu, refer to Figure 6-9, that allows the user to copy a specific sensor data table to another table location.

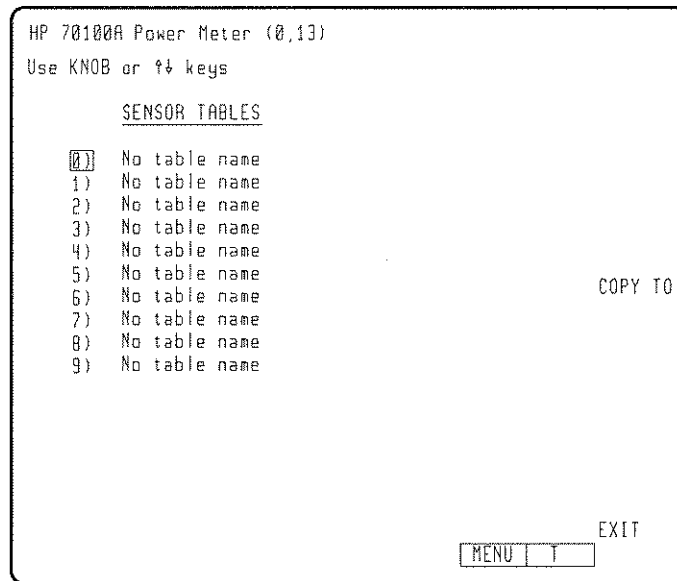

Figure 6-9. Copy From Menu

Copy Procedure

1. Position the cursor on the number of the table that is to be copied. Press **copy from**. Notice that a dotted box is now around the number of the table that is to be copied.

Note



Notice that a new menu has appeared. If it is decided not to make a copy, pressing **EXIT** will return to the **sensor tables** menu.

2. Position the cursor on the number of the table that is to be copied to. Press **COPY TO** to complete the copy operation.

Clear (clear)

clear will access another menu as shown in Figure 6-10. This function clears all entries from a sensor data table. As a safety feature two menus are required so that a sensor data table is not cleared accidentally.

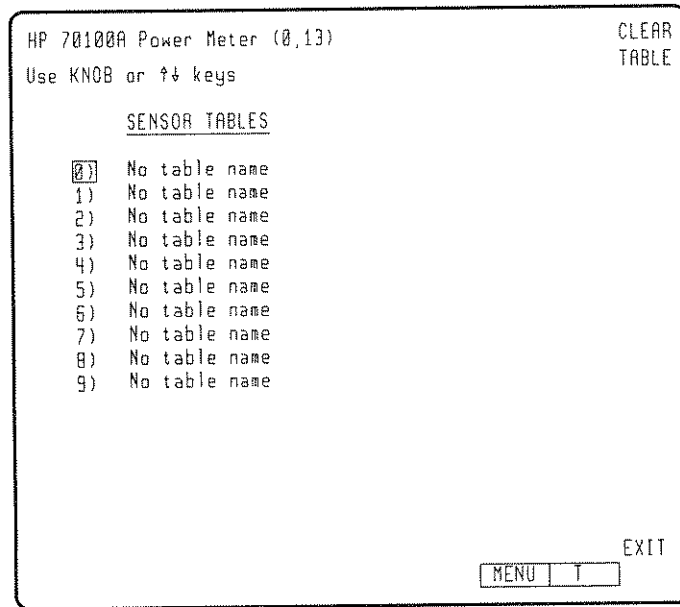

Figure 6-10. Clear Menu

Clear procedure

1. Position the cursor on the number of the table that is to be cleared, press **clear**.
2. Press **CLEAR** to clear the table. Or, press **EXIT** to not clear the table and return to the "sensor tables" menu.

Exit (EXIT)

EXIT returns the user to the **Cal Funcs** menu. **EXIT** can be used at any time.

Measurement Functions (Meas Funcs)

Measurement Functions set the parameters used during a measurement. The parameters that can be set are listed below:

- **FREQ** (Frequency)
- **CALFAC** (Calibration Factor)
- **offset**
- **duty cycle**
- **rel** (Relative Measurement)
- **range**
- **filter avg** (filter average)
- **display resoln** (display resolution)
- **limits**
- **trigger**

These functions are accessed through the **Meas Funcs** key of the Power Meter display screen. The Meas Funcs Menu is shown in Figure 6-11. The functions are briefly described below and in more detail following the Overview section.

Overview

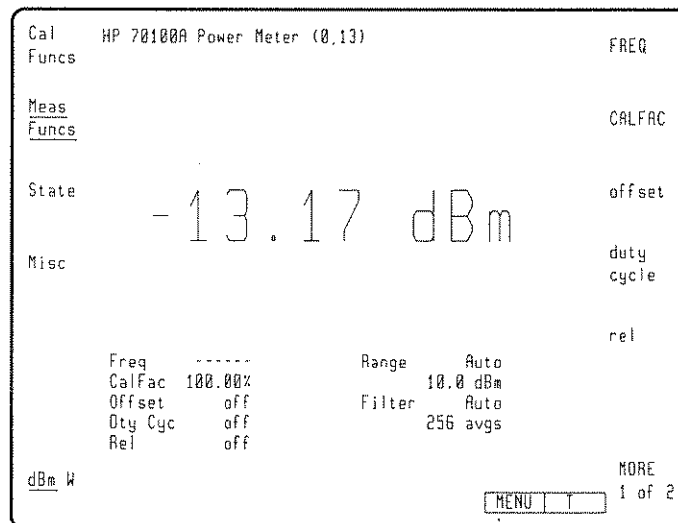

Figure 6-11. Meas Funcs Menu

FREQ is used to enter the frequency of the input signal.

CALFAC enables entry of the calibration factor of a specific power sensor at a specific input frequency.

offset accesses another menu. This second menu allows the user to enter values into the Power Meter that are used to compensate for signal gain or loss.

ENTER

OFFSET allows entry of an offset value. When **offset** is pressed, **OFFSET** is enabled automatically.

ENTER**OFFSET**

On **Off** enables or disables an offset during a measurement.

duty

cycle accesses another menu. This second menu is used to enter the duty cycle of a pulsed input signal.

ENTER

DTY CYC enables the user to enter the duty cycle of a pulsed input signal. When **cycle** is

duty**ENTER**

enabled, **DTY CYC** is automatically enabled.

DTY CYC

On **Off** enables or disables duty cycle during a measurement.

rel accesses another menu that is used for a relative measurement.

ENTER

REF LVL is used to change the reference level for a relative measurement.

REL

On **Off** will enable or disable a relative measurement.

EXECUTE

REL will change the reference level to the current Power Meter reading.

MORE

1 of 2 accesses the second menu for **Meas Funcs**.

range accesses another menu to control the range of the Power Meter, either automatically or manually.

AUTO

RANGE puts the Power Meter into autorange. The Power Meter will automatically change range as the input power level changes.

RANGE

HOLD will place the Power Meter in range hold when the Power Meter is in autorange.

RANGE 5 puts the Power Meter into range five. Range five is the least sensitive (highest power levels).

RANGE 4 puts the Power Meter into range four.

RANGE 3 puts the Power Meter into range three.

RANGE 2 puts the Power Meter into range two.

RANGE 1 puts the Power Meter into range one. Range one is the most sensitive (lowest power levels.)

filter

avg accesses another menu. This second menu controls the digital filtering of the Power Meter. The purpose of the filtering is to reduce jitter in the display.

AUTO

FILTER sets the Power Meter to auto filter mode. The Power Meter automatically selects the proper filtering for the best display.

MANUAL

FILTER allows the user to select the amount of filtering desired. The amount of filtering is

selected using the **MORE** or **LESS** keys.

MORE

AVGS increases the amount of filtering.

LESS

AVGS decreases the amount of filtering.

display

resoln accesses another menu. The second menu is used to set the display resolution. One of two menus will be displayed, depending upon the measurement units selected using the "dBm W" key. The description which follows will describe the six possible keys.

.1 dB produces a resolution of one place to the right of the decimal point.

.01 dB produces a resolution of two places to the right of the decimal point.

.001 dB produces a resolution of three places to the right of the decimal point.

1 % produces a resolution of one percent of full scale range.

0.1 % produces a resolution of one tenth percent of full scale range.

0.01 % produces a resolution of one hundredth percent of full scale range.

THRESH

On Off enables or disables the displaying of the measured power when it is less than ten percent of full scale. When On is active, the power will not be displayed. If Off is active, the power will be displayed.

Limits accesses another menu. The second menu allows the user to enter the upper and lower limits of the Power Meter.

LIMITS

On Off enables or disables the use of limits during a measurement.

HI LIM is used to enter the upper limit of the Power Meter.

LOW LIM is used to enter the lower limit of the Power Meter.

trigger accesses the menu used to set triggering.

FREE

RUN triggering causes the Power Meter to continuously take measurements.

SINGLE

TRIGGER causes the Power Meter to take one measurement and then hold.

MORE

2 of 2 accesses the first menu for Meas Funcs.

Meas Funcs Detailed Operating Information

Frequency (FREQ)

FREQ allows the user to enter the frequency of the input signal. When **FREQ** is selected, the softkey will be highlighted in inverse video. The allowable range of values is from 0.0001 to 999.9 GHz with a 100 kHz resolution. At preset the frequency is set to 50 MHz.

When a frequency is entered, the Power Meter accesses an internal table of calibration factors. This table of calibration factors is pre-programmed by the user for specific sensors. (For more information about the sensor tables, refer to the **Cal Funcs** section of this chapter.)

When a frequency is entered, the Power Meter accesses the table of calibration factors for the power sensor that has been selected. If the entered frequency does not have a corresponding calibration factor in the selected table, the Power Meter uses linear interpolation to calculate one. If the entered frequency is higher than the highest frequency in the calibration factor table, the Power Meter will use the calibration factor for the highest frequency. If the entered frequency is lower than the lowest frequency in the calibration factor table, the Power Meter will use the calibration factor for the lowest frequency.

Frequency Procedure

1. Press **FREQ**. The current frequency will appear in the upper left portion of the display.

Note



If a frequency is entered below 100 kHz the following error message will be displayed: ENTRY ERROR: FR<100kHz.

If a frequency is entered that is greater than 999.9999 GHz the following error message will be displayed: ENTRY ERROR: FR>999.9GHz.

When an entry error is made before one of the terminators has been selected, press **CLEAR** to restore the previously stored frequency, then re-enter the frequency again.

2. The frequency is changed using the RPG, arrow keys, or numeric key pad. The RPG and arrow keys will cause a frequency change appropriate to the current frequency. Any frequency between 0.0001 and 999.9999 GHz can be entered with the numeric key pad. A second menu will appear to terminate the frequency entry. The frequency is entered when one of the terminators is chosen: GHz, MHz, kHz, or Hz
3. To delete the frequency information from the top of the display, use the **Misc** key, then press **ENTRY** .
press **HOLD** .

Calibration Factor (CALFAC)

The calibration factor compensates for mismatch losses and effective efficiency over the frequency range of the power sensor.

Pressing **CALFAC** enables entry of the calibration factor of a specific power sensor at a specific input frequency. When **CALFAC** is enabled, the softkey is highlighted in inverse video. A chart or table of Frequency versus CAL FACTOR % is printed on each sensor and an accompanying data sheet. Calibration factor is entered in percent. Valid entries range from 1% to 150%. At preset the calibration factor is set to 100%.

Calibration Factor Procedure

1. Press **CALFAC**. The current CAL FACTOR will appear in the upper left portion of the display.
2. The cal factor can be changed using the RPG knob, the arrow keys or the numeric key pad. The RPG knob changes the frequency in 0.1% steps. The arrow keys change the frequency in 1% steps. The numeric key pad can be used to enter any cal factor between 1% and 150%. Only one digit to the right of the decimal point is accepted. When the numeric key pad is used, a second menu will appear to terminate the cal factor entry. The cal factor is entered when the percent terminator is chosen.

Note



If a cal factor is entered that is less than 1 or greater than 150%, the following error message will be displayed: ENTRY ERROR: CFAC 1—150%.

When the numeric key pad is used and an entry error is made before percent (%) has been selected, press **CLEAR** to restore the previously stored CAL FACTOR, then re-enter the CAL FACTOR again.

3. To delete the CAL FACTOR information from the top of the display, use the Misc key, then press **ENTRY** then press **HOLD**.

Offset (offset)

offset will access another menu, refer to Figure 6-12, that is used to enter values into the Power Meter to compensate for signal gain or loss (for example, to compensate for the loss of a 10 dB directional coupler). Offsets are entered in dB. The allowable range of values is -99.99 to +99.99 dB in 0.01 dB increments. The offset (in dB) is added to the measured power according to the following algorithm: $\text{Display} = \text{Measured power}(\text{dB}) + \text{OFFSET}(\text{dB}) - \text{REL}(\text{dB}) - \text{DUTY CYCLE}(\text{dB})$. At preset the offset is set to zero.

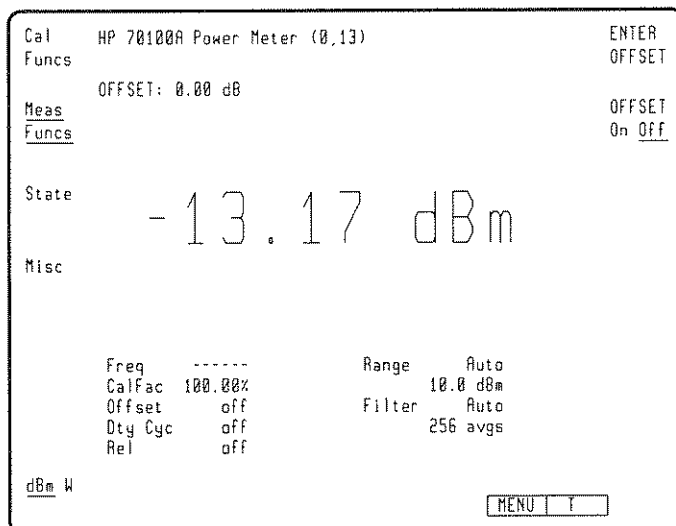

Figure 6-12. Offset Menu

Offset Procedure

1. Press **offset**. The current offset will be displayed in the upper left portion of the display.

When **offset** is pressed **ENTER** **OFFSET** is automatically enabled.

Note

Any modification of the offset value will automatically turn **OFFSET** on.



2. Retain the current offset by pressing **Meas Funcs** or the [**←**] key. Change the offset using the RPG knob, arrow keys or the numeric keypad. The RPG knob will change the current offset in 0.1 dB steps. The arrow keys will change the offset in 1 dB steps. If the numeric keypad is used, a second menu will appear on the right side of the display. Press **dB** to terminate the offset entry. If an entry error is made, before **dB** is pressed, press **CLEAR** to begin again.

Note

If an invalid offset is entered, the following error message will be displayed:
ENTRY ERROR: OS±99.99dB.



3. **OFFSET**
Press **On Off** to toggle offset either ON or OFF.
4. **ENTRY**
To delete the offset information from the top of the display, use **Misc**, then press **HOLD**.

Duty Cycle (duty cycle)

duty cycle accesses another menu, refer to Figure 6-13, that allows entry of the duty cycle of a pulsed input signal. This function will cause the Power Meter to display the pulse power of a rectangular pulsed input signal. The allowable range of values is 1 to 100%. A preset the duty cycle is off and set to 100%.

Pulse power, as displayed by the Power Meter, is a mathematical representation of the pulse power rather than an actual measurement. The Power Meter measures the average power of the pulsed input signal and then divides the measurement by the duty cycle value to obtain a pulse power reading.

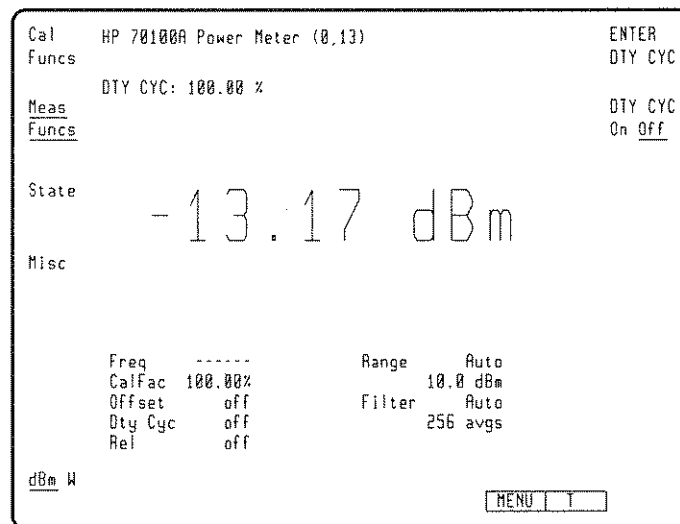

Figure 6-13. Duty Cycle Menu

Duty Cycle Procedure

1. **duty cycle**. Press **duty cycle**. The current duty cycle will be displayed in the upper left portion of the display. When **duty cycle** is pressed, **ENTER** **DTY CYC** is enabled automatically.
2. Retain the previously stored duty cycle by pressing **Meas Funcs** or the [←] key. Change the duty cycle using the RPG knob, the arrow keys, or the numeric keypad.

Note Changing the duty cycle will automatically turn duty cycle on.



The RPG knob will change the duty cycle in 0.1% steps. The arrow keys will cause the duty cycle to change in 1% steps. A terminator menu is displayed when the numeric keypad is used. Change the duty cycle with the keypad, press the percent (%) terminator

to enter the duty cycle. If an entry error is made, before percent (%) is pressed, press **CLEAR** to begin again.

Note



If an invalid duty cycle is entered, the following error message will be displayed: ENTRY ERROR: DY 1—100%.

3. **DTY CYC**
Press **On Off** to toggle duty cycle either ON or OFF.
4. To delete the duty cycle information from the top of the display, use **Misc**, then press **ENTRY HOLD**.

Relative Mode (rel)

rel accesses another menu, refer to Figure 6-14, that allows entry of a reference value for a relative measurement. Relative mode permits any measurement result to be compared in dB or percent (%) to the reference value. Allowable references range from -199 dBm to +99 dBm. After preset, relative mode is off and the reference is set to 1 mW.

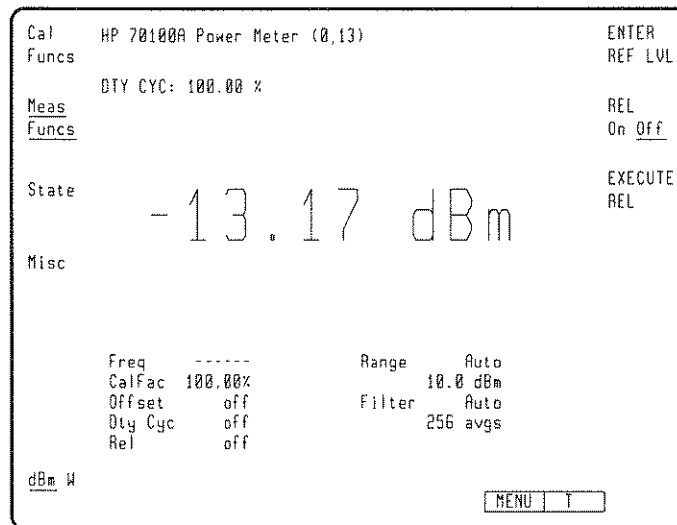

Figure 6-14. Rel Menu

Relative Mode Procedure

Note



There are three ways to set the reference for a relative measurement. Each method is described in the following text.

If an invalid reference is entered, one of the following error messages will be displayed: ENTRY ERROR: RR<-199dBm, RR>99dBm, RR<1E -20mW, RR>1E10mW

Using the Current Reference

1. Press **rel**. The menu will be as shown in Figure 6-14.
2. **ENTER**
Press **REF LVL**. The current reference value will be displayed in the upper left portion of the display.
3. **REL**
Press **On Off** until ON is underlined to use the previously stored reference value.
4. Retain the current reference level by pressing **Meas Funcs** or [**←**].

Changing the Reference Value

Note Any modification of the reference value will automatically turn relative mode on.



1. Press **rel**. The menu will be as shown in Figure 6-14.
2. **ENTER**
Press **REF LVL**. The current reference value will be displayed in the upper left portion of the display.
3. Change the reference with the RPG knob, arrow keys, or the numeric keypad. In log mode (dB) the RPG knob will change the current reference in 0.1 dB steps. In linear mode (W) the RPG knob will change the current reference in small linear steps. In log mode (dB) the arrow keys will change the reference in 1 dB steps. In linear mode (W) the arrow keys will change the reference in small linear steps. If the numeric keypad is used, the following terminators will appear: dBm, W, mW, μ W, nW, and CLEAR. Make a selection to enter the new reference value. If an entry error is made, before a terminator is chosen, press **CLEAR** to begin again.
4. To delete the reference information from the top of the display, use **Misc**, then press **ENTRY HOLD**.

Using the Power Meter Reading as the Reference

1. Press **rel**. The menu will be as shown in Figure 6-14.
2. **EXECUTE**
Press **REL** to use the current Power Meter reading as the reference level. Pressing **EXECUTE REL** will turn relative mode on if it is not already on.

Range (range)

range accesses another menu, refer to Figure 6-15, which allows entry of the Power Meter's range.

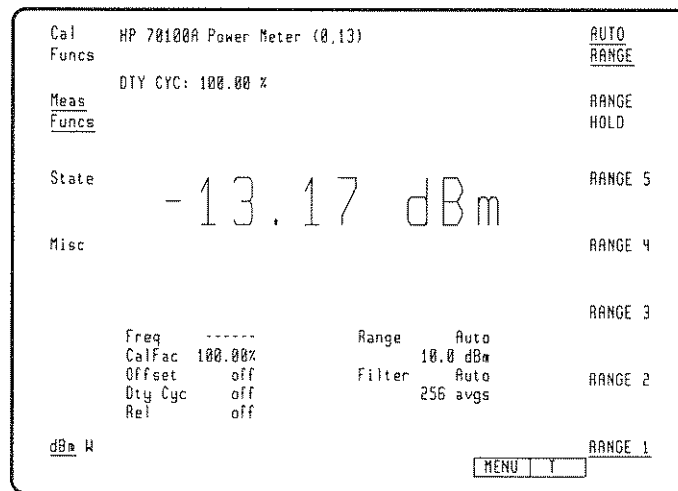

Figure 6-15. Range Menu

The Power Meter divides each sensor's power range into 5 ranges of 10 dB each. Range 1 is the most sensitive (lowest power levels), and Range 5 is the least sensitive (highest power levels).

With **range** enabled, the range of the Power Meter can be set manually or automatically. If

a range is selected manually, **RANGE X** and **HOLD** softkeys will both be underlined. Valid ranges are 1 through 5. When the Power Meter is in range hold, the Power Meter will stay in that range no matter what the applied input power is. To go from range hold to auto range, **AUTO** **AUTO** **AUTO** **RANGE** is pressed. When **RANGE** is selected, **RANGE** will be underlined. After preset, range is set to auto range.

If a number of measurements are to be made at an unknown power, select **AUTO** **RANGE**. The Power Meter will select the appropriate range for the applied power. Select **RANGE** **HOLD** to hold the range.

Range Procedure

1. Press **range**. The Power Meter will display the current setting for range, and whether the Power Meter is in auto range or range hold. The current conditions will be underlined.
2. Change range by selecting the range desired. Select auto range by pressing **AUTO** **RANGE** or select range hold by pressing **RANGE** **HOLD**.

Filter Average (filter avg)

filter
avg accesses another menu, refer to Figure 6-16, that is used to set the averaging of the Power Meter. The Power Meter uses a variable digital filter to average power readings. The purpose of filtering is to reduce jitter in the display. The number of readings averaged can range from 1 to 1024 in binary progression.

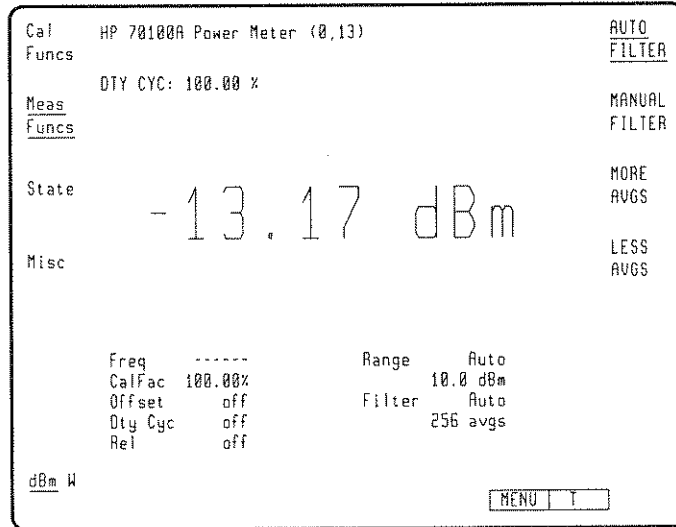

Figure 6-16. Filter Avg Menu

When a new power measurement is input to the filter, it is saved and the oldest reading is discarded. If the Power Meter's configuration changes such that the values in the filter are no longer valid (for example, a change in range), the filter contents are set to zero. The filter starts storing values again, and the Power Meter displays the average of the accumulated power readings.

The number of readings averaged together by the Power Meter can be selected automatically or manually. For most applications, auto filter mode is the best mode of operation. Manual filter mode is useful mainly in specialized applications requiring high resolution or fast settling times.

In auto filter mode, the Power Meter automatically sets the number of readings averaged together to satisfy the filtering requirements for most power measurements. The number of readings averaged together depends upon the resolution and the power range in which the Power Meter is currently operating. The following table lists the number of readings averaged for each range and resolution when the Power Meter is in auto filter mode.

Number of Averages vs. Range and Resolution (Auto Filter Mode)

	0.1 dBm (1%)	0.01 dBm (0.1%)	0.001 dBm (0.01%)
	Number of Averages	Number of Averages	Number of Averages
Range 1	8	128	128
Range 2	1	8	256
Range 3	1	2	32
Range 4	1	1	16
Range 5	1	1	8

Filter Average Procedure

1. Press **filter**. The menu that appears will be as shown in Figure 6-16.
2. Press **AUTO**. Press **FILTER** to have the Power Meter average readings automatically. Press **FILTER** to enable the user to select the filtering desired. If **FILTER** has been selected, press **AVGS** or **LESS** to change the number of averages that the Power Meter will take. The number of averages will be shown in the annotation block. If the annotation block is not displayed, use Misc, then press **On Off** until ON is underlined.

Resolution (display resoln)

Press **display resoln** will access one of two menus, see Figures 6-17 and 6-18, that are used to adjust the resolution of the Power Meter. The menu that is displayed depends on the setting of the "dBm W" key. Three levels of resolution can be set: .1 dB, .01 dB, and .001 dB (in watts mode, 1%, 0.1%, and 0.01% of full scale).

In dBm mode **THRESH** controls whether the Power Meter will display the measured level when it is less than ten percent of full scale.

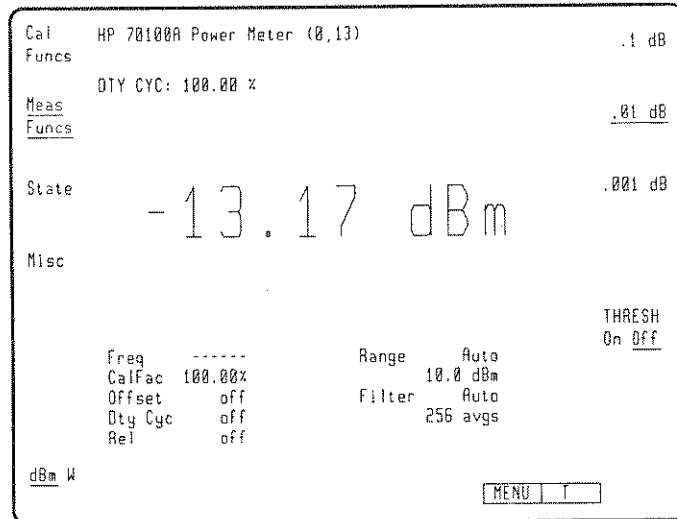

Figure 6-17. Display Resoln Menu (dB)

When in manual filter mode, setting the resolution sets the Power Meter to auto filter mode. If in auto filter mode, setting the resolution will set the optimum number of averages for the power range. For more information about auto and manual filter mode, refer to the **Filter Averages** portion of this section.

When the Power Meter is preset, threshold is off and the resolution is set to .01 dBm (.1%).

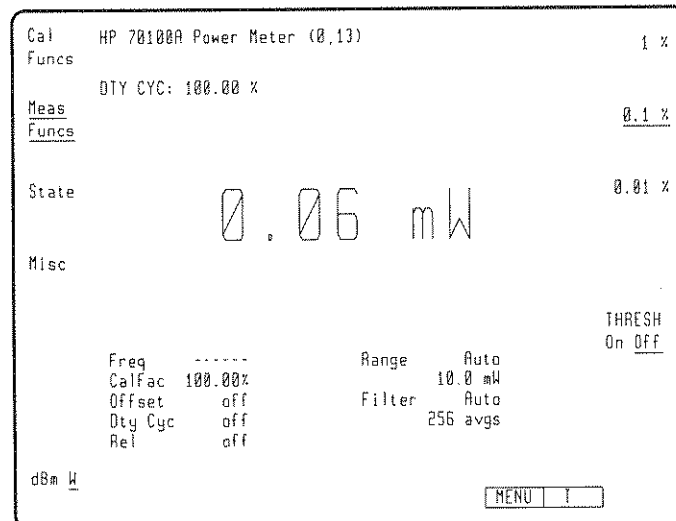

Figure 6-18. Display Resoln Menu (Watts)

Resolution Procedure

1. **display**
 Press **resoln**. The following softkeys will be displayed:
 - a. **1 dBm** or **1 %**
 - b. **01 dBm** or **0.1 %**

c. .001 dBm or 0.01 %

Select the desired number of digits to the right of the decimal. The selected resolution will be underlined. .1 dBm produces one digit of resolution, .01 dBm produces two digits of resolution, and .001 dBm produces three digits of resolution. 1 % produces a resolution of one percent of full scale range. 0.1 % produces a resolution of one tenth percent of full scale range. 0.01 % produces a resolution of one hundredth of a percent of full scale resolution.

2. THRESH

On Off will enable or disable the displaying of the measured power if it is less than ten percent of full scale. This means if the Power Meter is in auto range, the power is less than ten percent of Range 1. If the Power Meter is in range hold, the power is less than ten

percent of the current range. Press THRESH On Off until ON is underlined to disable the power

from being displayed. Press THRESH On Off until OFF is underlined to have the power displayed.

Limits

limits accesses another menu, see Figure 6-19, that is used to set the upper and lower limits of the Power Meter.

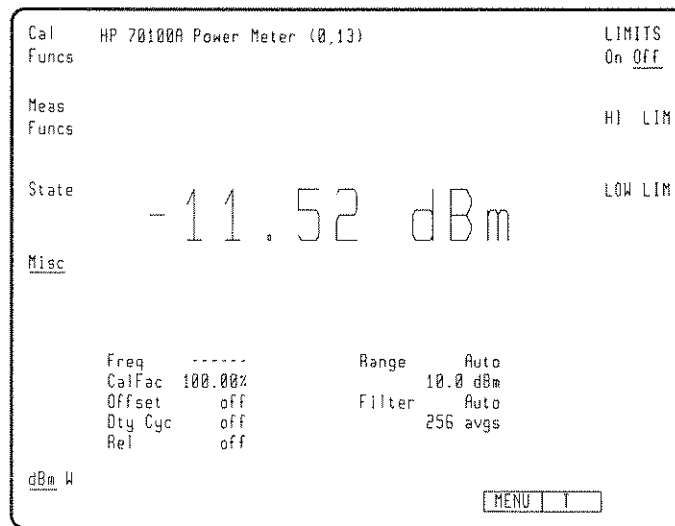

Figure 6-19. Limits Menu

The limits checking function allows the Power Meter to monitor the power level at the sensor and to indicate when that power is outside preset limits.

Limit values are entered in dBm, W, mW, μ W, and nW. Allowable values range from -199 dBm to +99 dBm.

When the limits checking function is enabled, the Power Meter uses the last entered high and low limit values.

At preset the limits are off, the high limit is 90.99 dBm, and the low limit is -90.99 dBm

Limits Procedure

1. Press **LIMITS**. The menu will be as shown in Figure 6-19.

Note



If an invalid lower limit is entered, one of the following error messages will be displayed: ENTRY ERROR: LL<-199dBm, LL>99dBm, LL<1E-20mW, LL>1E10mW

2. Press **LOW LIM**. The current lower limit will be displayed in the upper left portion of the display. The limit can be changed using the RPG knob, arrow keys, or the numeric keypad. In log mode (dB), the RPG knob will change the limit in 0.1 dB steps. In linear mode (W), the RPG knob will change the limit in small linear steps. In log mode (dB), the arrow keys will change the limit in 1 dB steps. In linear mode (W), the arrow keys will change the limit in small linear steps. If the numeric keypad is used, the following terminators will appear: dBm, W, mW, μ W, nW, and CLEAR. Make a selection to enter the new reference value. If an entry error is made, before a terminator is chosen, press **CLEAR** to begin again.

Note



If an invalid upper limit is entered, one of the following error messages will be displayed: ENTRY ERROR: LH<-199dBm, LH>99dBm, LH<1E-20mW, LH>1E10mW

3. Press **HI LIM**. The current upper limit will be displayed in the upper left portion of the display. The limit can be changed using the RPG knob, arrow keys, or the numeric keypad. In log mode (dB), the RPG knob will change the limit in 0.1 dB steps. In linear mode (W), the RPG knob will change the limit in small linear steps. In log mode (dB), the arrow keys will change the limit in 1 dB steps. In linear mode (W), the arrow keys will change the limit in small linear steps. If the numeric keypad is used, the following terminators will appear: dBm, W, mW, μ W, nW, and CLEAR. Make a selection to enter the new reference value. If an entry error is made, before a terminator is chosen, press **CLEAR** to begin again.

Trigger (trigger)

trigger accesses another menu, see Figure 6-20, that allows the user to manually set the triggering of the Power Meter. After preset, triggering is set to freerun.

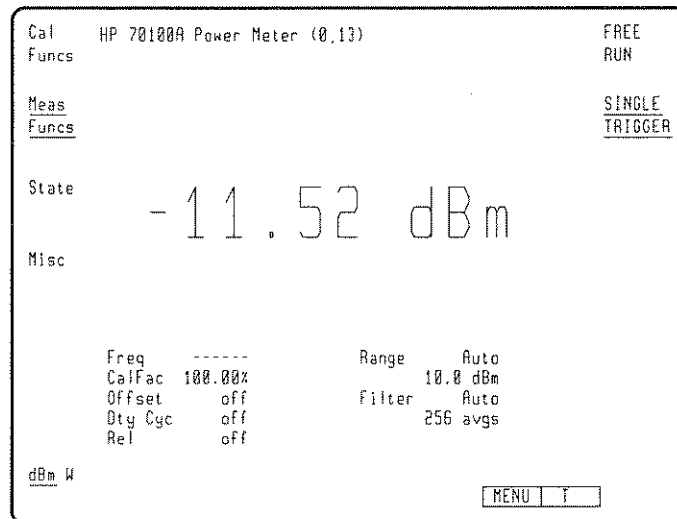

Figure 6-20. Trigger Menu

FREE

RUN causes the Power Meter to continually take measurements, and the display is updated as soon as the measurement results are available.

SINGLE

TRIGGER causes the Power Meter to take one measurement, then hold.

Trigger Procedure

1. Press **trigger**. The menu displayed will be as shown in Figure 6-20.

2.

FREE

Press **RUN** to have the Power Meter take measurements and output the results to the

SINGLE

display. This is the normal mode of operation for the Power Meter. Press **TRIGGER** to have the Power Meter take one measurement, then hold.

State

The state functions allow the user to save and recall different instrument configurations.

These functions are accessed through the **State** key of the Power Meter display screen. The functions are briefly described in the Overview section and in more detail following that section. The State menu is shown in Figure 6-21.

The following instrument settings can be stored in the Power Meter's internal registers:

- Ref Cal Factor (reference calibration factor) value
- Measurement units (dBm or watts)
- rel (relative) value and status (on or off)
- PWR REF (Power Reference) status (on or off)
- CALFAC (calibration factor) value
- sensor data (sensor data table selection)
- offset value and status (on or off)
- range (Auto or Hold)
- FREQ (Frequency) value
- display resoln (Resolution)
- duty cycle value and status (on or off)
- filter avg (number of readings averaged, auto or manual)
- limits value and status (on or off)
- Thresh (on or off)

The Power Meter uses registers 1 through 19 for storing instrument configurations.

Overview

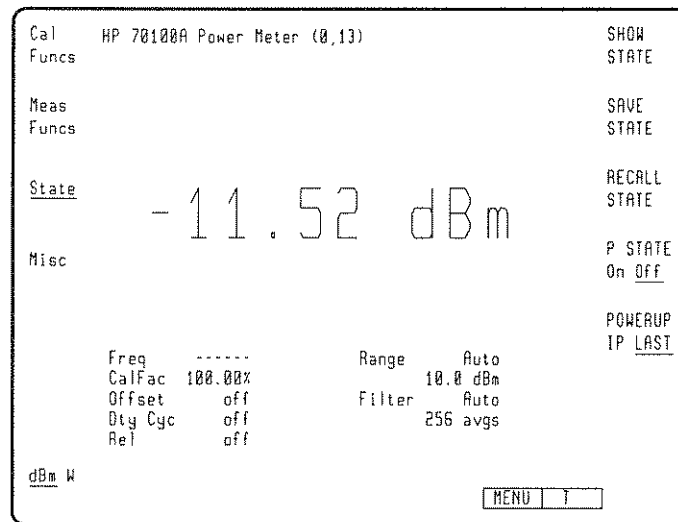

Figure 6-21. State Menu

SHOW

STATE will display all the instrument settings that have been stored in each of the Power Meter's nineteen state registers.

SAVE

STATE is used to save an instrument configuration to one of the Power Meter's nineteen state registers.

RECALL

STATE will recall an instrument configuration that was previously stored to one of the Power Meter's nineteen state registers.

P STATE

On Off allows the user to protect the state registers so that they will not be accidentally changed.

POWERUP

IP LAST will determine the state of the instrument when power is applied.

State Detailed Operating Information

Show State (SHOW STATE)

SHOW

STATE allows the user to view the different instrument configurations that are stored in the Power Meter's nineteen state registers.

Show Procedure

1. **SHOW**
Press **STATE**. "SHOW STATE:" will be displayed in the upper left portion of the display.
2. Enter the number of the register to be viewed.

Note

If an invalid register number is entered, the following error message will be displayed at the bottom of the CRT: ENTRY ERROR: REG 1—19

3. View the desired register by pressing **ENTER**. **ENTER** appeared when the register number was keyed in. "Show State X" will be displayed on the CRT when enter is pressed.
4. View the other state registers by turning the RPG knob or pressing the arrow keys.
5. Clear "Show State X" from the center of the CRT by pressing the State key.

Save State (SAVE STATE)

SAVE

STATE will save the present instrument configuration in one of the Power Meter's nineteen state registers.

Save Procedure

1. **SAVE**
Press **STATE**. "SAVE STATE:" will be displayed in the upper left portion of the display.
2. Key in the number of the register where the instrument configuration is to be saved.

Note

If an invalid register number is entered, the following error message will be displayed at the bottom of the CRT: ENTRY ERROR: REG 1—19

3. Enter the instrument configuration by pressing **ENTER**. **ENTER** appeared when the register number was keyed in.

Recall State (RECALL STATE)

RECALL

STATE will recall instrument configurations that have been stored in the Power Meter's nineteen state registers.

Recall Procedure

1. **RECALL**
Press **STATE**. "RECALL STATE:" will be displayed in the upper left portion of the display.
2. Key in the number of the register where the instrument configuration was saved.

Note



If an invalid register number is entered, the following error message will be displayed at the bottom of the CRT: ENTRY ERROR: REG 1—19

3. Recall the instrument configuration by pressing **ENTER**. **ENTER** appeared when the register number was keyed in.

P State (P STATE On Off)

P STATE

On Off allows the user to protect the state registers so that they will not be accidentally changed. The state registers cannot be changed if **On Off** is set to ON. The instrument **P STATE** preset does not change the status of **On Off**. The factory setting is off.

P State Procedure

P STATE

P STATE

On Off is a toggle function. Press **On Off** until ON is underlined to enable the function. Press the key again until OFF is underlined to disable the function.

Power Up (POWER UP IP LAST)

POWERUP

IP LAST sets the instrument state when power is applied. If IP is selected, the instrument will default to the instrument preset state. If LAST is selected, the instrument will be set to the state it was in when the power was turned off.

Power Up Procedure

POWERUP

IP LAST is a toggle function. Pressing the softkey will toggle between IP (instrument preset) and LAST (the configuration before power was removed).

Miscellaneous (Misc)

The Miscellaneous functions allow the user to perform housekeeping and service operations. These functions are accessed through the **Misc** key of the Power Meter display screen. The Misc Menu is shown in Figure 6-22. The functions are briefly described in the "Overview" section and in more detail following that section.

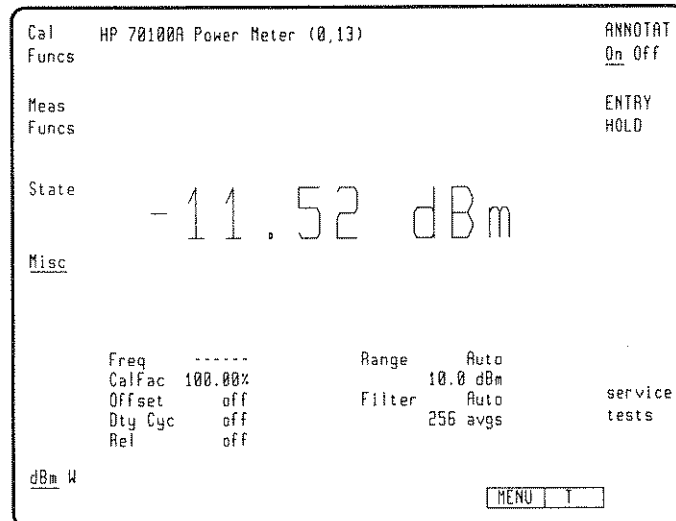

Figure 6-22. Misc Menu

Overview

ANNOTAT

On Off enables or disables the displaying of measurement parameter information at the bottom of the display.

ENTRY

HOLD disables the entry and displaying of the current active measurement parameter

service

tests accesses the self tests and diagnostics that are used to troubleshoot the Power Meter's circuitry.

Misc Detailed Operating Information

Annotation (ANNOTATION)

ANNOTAT

On Off allows the user to turn on or off the annotation block, which when displayed appears at the bottom of the display. When turned on the information is displayed at all times. The type of information that is displayed is as follows:

Note



With certain window sizes all of the annotation information is not displayed. Refer to the Display documentation for more information about changing the window assigned to the Power Meter.

- Freq (Frequency)
- CalFac (Calibration Factor)
- Offset
- Dty Cyc (Duty Cycle)
- Rel (Relative Measurement)
- Range (Auto or Manual and full scale range)
- Filter (Auto or Manual and number of averages)

Figures 6-23 through 6-25 show examples of different window sizes and the type of annotation information that will be displayed.

Annotation Procedure

1. **ANNOTAT** **ANNOTAT**
On Off is a toggle function. The current state of **On Off** will be underlined.
ANNOTAT
 Press **On Off** to toggle the state.

Entry Hold (ENTRY HOLD)

Along with **On Off**, **ENTRY** **HOLD** is a housekeeping function. When parameters, such as, offset, duty cycle, and frequency are enabled, the current value is displayed in the upper left portion of the display. The parameter will continue to be displayed until another parameter is selected or **ENTRY** **HOLD** is enabled.

ENTRY

HOLD is used to disable modification of the parameter, and stops the parameter from being displayed.

ANNOTAT

ENTRY

By using **On Off** and **HOLD** the display is simplified so that only the menu being used and the measurement result will be displayed.

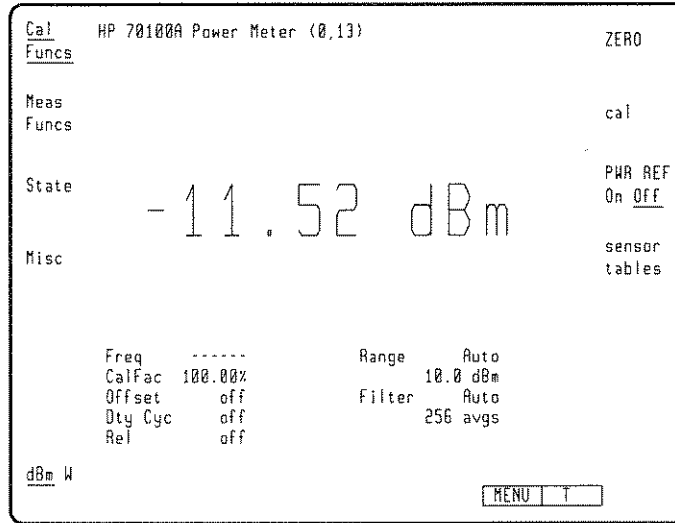

Figure 6-23. Power Meter Window (Full Display)

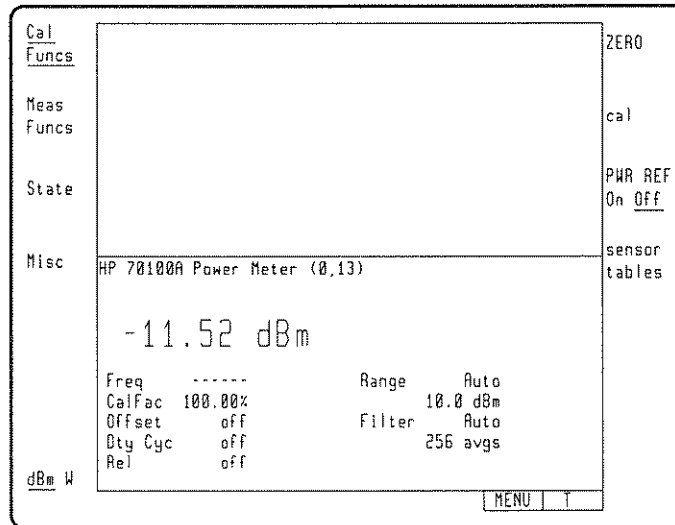

Figure 6-24. Power Meter Window (Half Display)

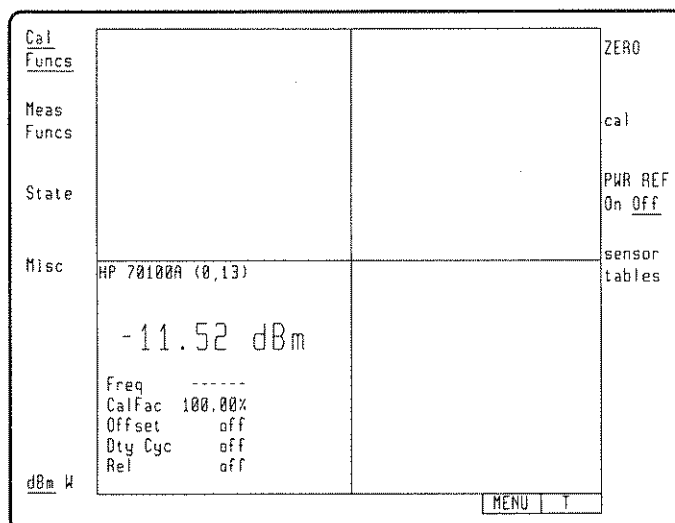

Figure 6-25. Power Meter Window (Quarter Display)

Entry Hold Procedure

1. **ENTRY**
Press **HOLD**. The softkey will be highlighted in inverse video and the active parameter will no longer be displayed. Enable a new parameter or the parameter that was just disabled using the menu that contains the desired parameter.

Service Tests (service tests)

service tests accesses the self tests and the diagnostics. The self tests allow the user to run a battery of tests that check the digital and analog circuitry of the Power Meter. The diagnostics are used to troubleshoot circuitry that failed during the self tests.

For more information about the **service tests** softkey, refer to Chapter 4, "Troubleshooting" in the Power Meter Service Manual.

Remote Operation and Programming

This chapter provides the necessary information to operate a Power Meter system via a computer. The topics described in this chapter are as follows:

- Setup Procedures for Remote Operation
- Address Switches
- Communication With the System
- Hewlett-Packard Interface Bus (HP-IB)
- Status Reporting Structure
- Programming Commands
- Programming Examples

Setup Procedures

The following procedure describes how to connect your equipment for remote operation for a Power Meter system.

Note

Refer to the HP 70100A Power Meter Installation and Verification section for more detailed and specific information on installation, configuration, and addressing for Power Meter systems.

1. Connect computer, Power Meter system, and other peripherals with HP-IB cables.
2. After the HP-IB cables are installed, reset all instruments connected to the bus. (If you are not sure how to reset a device, switch its line power off, then on, to reset it.)
3. Check the HP-IB address of the Power Meter module on the address map. To view the address map, press the [DISPLAY] key on the display front panel, then press the ADDRESS MAP softkey. Turn the RPG knob on the front panel of the display until the Power Meter module appears in the address map.

Note

The Power Meter module must be located in row 0 for HP-IB access and error-reporting capabilities.

Address Switches

Address switches set the HP-MSIB address of an element (module). Some elements can also have their HP-IB address set through the use of softkeys (for example, soft-set address).

The hard address switches for the Power Meter are located on the rear panel of the module.

Note HP-IB address 31 is an illegal address and should not be used.



Descriptions of the HP 70100A Power Meter address switches are given below.

Column ADDRESS Switches 1-5 These set the HP-MSIB column address which is also the HP-IB address.

Row ADDRESS Switches 1-3 These set the HP-MSIB row address.

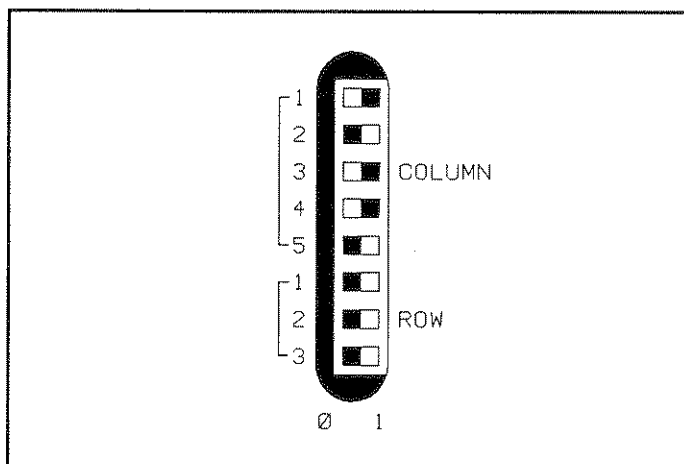

Figure 7-1. Address Switches — HP 70100A

Soft-Set HP-IB Addresses

The HP-IB address of the Power Meter module may be changed from the front panel of the display. This soft-set address will override any previous address set with the rear panel hard address switches. The soft-set address will stay in effect until the hard address switches are changed and power is cycled, or until another soft-set address is entered. At power-up, the soft-set address will override the hard address switch settings.

Note

Changing the HP-IB address via the display front panel does not affect the position of the modules on the address map.

Use the following procedure to enter a soft-set HP-IB address.

1. Press the [DISPLAY] key on the display front panel.
2. When the display Main Menu appears, press the ADDRESS MAP softkey.
3. When the next menu appears, press SET HP-IB.
4. Enter the new HP-IB address using the numeric keys on the display front panel.
5. Press ENTER.

Communication with the System

This section develops some fundamental techniques for controlling the Power Meter and obtaining sound measurement results. Remote operation of the Power Meter is controlled with commands that mainly correspond to front-panel softkey functions.

It is important to understand how messages are communicated to the Power Meter. Therefore, output statements and command syntax will be discussed in this section. It should be noted that HP BASIC is used for all examples in this manual.

Executing Remote Commands

Power Meter programs control the passage of Power Meter commands and data from the computer and to the Power Meter on the Hewlett-Packard Interface Bus (HP-IB) using HP BASIC **OUTPUT** statements.

An **OUTPUT** statement tells the computer to send a message to the Power Meter. For example, executing the output statement below sets the calibration factor:

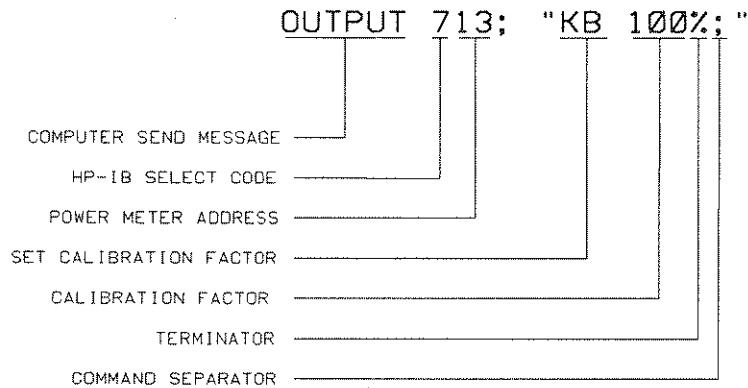

Syntax Requirements. All of the program examples in this manual show the recommended command syntax.

Local and Remote Control. Whenever the Power Meter is remotely addressed, the display front-panel softkeys are disabled. Pressing the [LOCAL] key or executing the HP BASIC command "LOCAL" reenables operation of the softkeys.

Initial Program Considerations

Programs should begin with a series of HP BASIC and Power Meter commands that form a good starting point for Power Meter measurements. The following example shows how to initialize the Power Meter to form a good starting point.

```
10 ASSIGN @POWER to 713
20 CLEAR @POWER
30 OUTPUT @POWER;"*RST"
```

The ASSIGN command is an HP BASIC command that creates an I/O path name and assigns that name to an I/O resource. In the example above, the I/O path name is "@POWER" and is assigned to the device at HP-IB address 13. (Note: all program examples in this manual assume that the Power Meter is at HP-IB address 13.)

The ASSIGN command offers several advantages when included in a Power Meter program. For example, the Power Meter address is easily changed in the computer program and the program can transfer data to a mass storage unit.

The RESET command, *RST, presets all of the analog parameters of the Power Meter and provides a good starting point for all measurement processes. Executing *RST actually is the same as executing a number of Power Meter commands that set the Power Meter to a known state.

The CLEAR command is an HP BASIC command that clears the input buffer, the output buffer, and the command parser of the specified instrument. That is, a device on HP-IB is "cleared" so that it is ready for operation. This command may be used to clear devices on the bus singly or in unison. It is often desirable to reset only one instrument so that other instruments on the bus are not affected.

To clear the Power Meter, the "CLEAR @POWER" statement may be entered into the computer.

To clear all devices at select code 7, the "CLEAR 7" statement may be entered into the computer.

Hewlett-Packard Interface Bus

The Power Meter can be operated through the Hewlett-Packard Interface Bus (HP-IB). HP-IB is Hewlett-Packard's implementation of ANSI/IEEE Standard 488.1. Bus compatibility, programming, and data formats are described in the following paragraphs.

For more information about HP-IB, refer to ANSI/IEEE Standard 488.1, the Hewlett-Packard Electronic Systems and Instruments catalog, and the booklet "Improving Measurements in Engineering and Manufacturing" (HP part number 5952-0058).

HP-IB Compatibility

The Power Meter's complete bus compatibility as defined by ANSI/IEEE Standard 488.1 is described at the end of Table 7-1. Table 7-1 also summarizes the Power Meter's twelve messages in the "HP-IB Message" column.

Table 7-1. Message Reference Table

HP-IB Message	Applicable	Response	Related Commands	Interface Functions
Data	Yes	All Power Meter measurement operations are bus programmable. All measurement results are available to the bus.		AH1, SH1, T6, TE0, L4, LE0
Trigger	Yes	The Power Meter's response to bus command GET (Group Execute Trigger) can be programmed. The default condition is Trigger With Delay (GT2). If in remote and addressed to listen, the Power Meter makes a measurement according to the previously programmed setup.	GET	DT1
Clear	Yes	All HP-IB inputs and outputs are canceled.	DCL, SDC	DC1
Remote	Yes	Remote mode is enabled when the REN bus control line is true. Remote mode is not entered, however, until the first time the Power Meter is addressed to listen. The front panel RMT annunciator lights when the instrument is actually in remote mode. When entering remote mode, no instrument settings or functions are changed but all front panel keys are disabled.	REN	RL1
Local	Yes	The Power Meter returns to local mode (front panel control). It responds equally to the Go To Local (GTL) bus command and the front panel local key on the display module.	GTL	RL1
Local Lockout	Yes	Disables all front panel keys, including the local key. Only the controller can return the Power Meter to local (front panel) control.	LLO	RL1
Clear Lockout/ Set Local	Yes	The Power Meter returns to local mode (front panel control). Local Lockout is cleared when the bus control line goes false.	REN	RL1
Pass Control/ Take Control	No	The Power Meter has no controller capability.		C0

Table 7-1. Message Reference Table (cont'd)

HP-IB Message	Applicable	Response	Related Commands	Interface Functions
Require Service	Yes	The Power Meter sets the SRQ bus control line true if one of the following conditions exists and has been enabled (via the Service Request Mask) to send the message for that condition: data ready, cal/zero completed, entry error, measurement error, or over/under limits.	SRQ	SR1
Status Byte	Yes	The Power Meter responds to a Serial Poll Enable (SPE) bus command by sending an 8-bit byte when addressed to talk. If the instrument is holding the SRQ bus control line true (issuing the Require Service message), bit position 6 in the Status Byte and the bit representing the condition causing the Require Service message to be issued will both be true. The bits in the Status Byte are latched but can be cleared by removing the causing condition and then reading the Status Byte or by receiving the Clear Status (CS) program code.	SPE, SPD	T6
Status Bit	No	The Power Meter does not respond to a Parallel Poll Enable (PPE) bus command.	PPE, PPD, PPC, PPU	PP0
Abort	Yes	The Power Meter stops talking and listening.	IFC	T6, TE0, L4, LE0
Complete HP-IB capability as defined in ANSI/IEEE Standard 488.1 is: SH1, AH1, T6, TE0, L4, LE0, SR1, RL1, PP0, DC1, DT1, C0				

Remote Mode

Remote Capability. The Power Meter communicates on the bus in both remote and local modes. In remote, all of the Power Meter's front panel keys are disabled. The display, however, remains active and valid.

In remote, the Power Meter can be addressed to talk or listen. When addressed to listen, the Power Meter responds to the Data, Trigger, Clear, Remote, and Local messages. When addressed to talk, the Power Meter can issue the Data and Status Byte messages. Whether addressed or not, the Power Meter responds to the Clear, Local Lockout, Clear Lockout/ Set Local, and Abort messages. In addition, the Power Meter may issue the Require Service and Status Bit messages.

Local-to-Remote Changes. The Power Meter switches to remote operation upon receipt of the Remote message. The Remote message has two parts:

- a. The remote enable bus control line (REN) is set true, and,
- b. the device listen address is received once (while REN is true).

When the Power Meter switches to remote, the front panel RMT annunciator turns on. The Power Meter's control settings remain unchanged with the local-to-remote transition.

Local Mode

Local Capability. In local, the Power Meter's softkeys are fully operational. The instrument will respond to the Remote message. The Power Meter can also send a Require Service message, a Status Byte message, and a Status Bit message.

Remote-to-Local Changes. The Power Meter always switches from remote to local whenever it receives the Local message (GTL) or the Clear Lockout/Set Local message. (The Clear Lockout/Set Local message sets the remote enable bus control line [REN] false.) If not in Local Lockout mode, the Power Meter switches to local from remote whenever the display [IP] (instrument preset) key is pressed.

Local Lockout. A local lockout is recommended for purely automatic applications. Local lockout disables the local key on the display and allows return-to-local only under program control.

Note



Return-to-local can also be accomplished by setting the display's LINE switch to OFF (0), then to ON (1). However, this technique has some disadvantages:

- a. Many of the Power Meter's parameters are set to default states. This may cause the measured power reading to change.
 - b. There are several HP-IB conditions that reset to default states at turn-on.
-

Addressing

The Power Meter interprets the byte on the eight HP-IB data lines as an address or a bus command if the bus is in the command mode. The command mode is defined as the attention control line (ATN) being set true and the interface clear control line (IFC) set false. Whenever the Power Meter is addressed (whether in local or remote), either the talk (TLK) or listen (LSN) annunciator on the front panel turns on.

The Power Meter's HP-IB address is set from the rear panel or the front panel display. For more information about setting the address from the front panel display, refer to the Soft-Set HP-IB Address at the beginning of this section.

Turn-on Default Conditions

Several HP-IB parameters are reset at turn-on. The parameters and their default conditions are listed below.

- HP-IB Local Mode

- Unaddressed
- Free Run Trigger Mode
- GT2 (Trigger with Delay) response to Trigger message
- Service Request Mask cleared
- Status Byte cleared
- Event Status Register = 128
- Event Status Enable Mask = 0

Data Messages

The Power Meter communicates on the interface bus primarily with Data messages. Data messages consist of one or more bytes sent over the bus' data lines when the bus is in the data mode (ATN bus control line false). Unless it is set to Talk Only, the Power Meter receives Data messages when addressed to listen. Unless it is set to Listen Only, the Power Meter sends Data messages or the Status Byte message when addressed to talk.

All measurement operations available in local mode can be performed in remote mode via Data messages. The Power Meter may also be triggered via Data messages to make measurements at a particular time.

Receiving the Data Message

The Power Meter responds to Data messages when it is enabled to remote (REN bus control line true) and it is addressed to listen. The instrument remains addressed to listen until it receives its talk address, an Abort message, or a universal unlisten command.

Data Input Format. The Data message string, or program string, consists of a series of ASCII codes. Each instrument command code is typically equivalent to a front panel keystroke in local mode. Numbers entered via HP-IB, however, are entered using ASCII strings. Example 1 shows a typical program string.

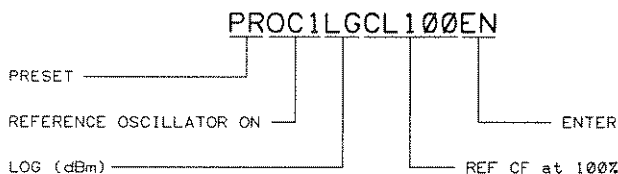

Example 1: Typical Program String

Program Codes. All of the HP-IB codes normally used by the operator to control the Power Meter are given in Table 7-5, HP-IB Code to Parameter Summary. Lower case alpha characters are interchangeable with upper case characters. The number 0 and the letter O are not interchangeable.

Numeric data can be entered in fixed, floating point, or exponential format.

Sending the Data Message

The Power Meter sends Data messages when addressed to talk. The instrument remains configured to talk until it is unaddressed to talk by the controller. To unaddress the Power Meter, the controller must send the Power Meter's listen address, a new talk address, an Abort message, or a universal untalk command.

Data Output Format. The output data is usually formatted as a real constant in exponential form. That is; first the sign, then a digit, a decimal point, and four digits followed by the letter E (which indicates that an exponent follows). The letter E is followed by a signed power-of-ten multiplier. The string is terminated by a carriage return (CR) and a line feed (LF). With the last byte of each output string, the Power Meter sends the END message (sets the EOI line true).

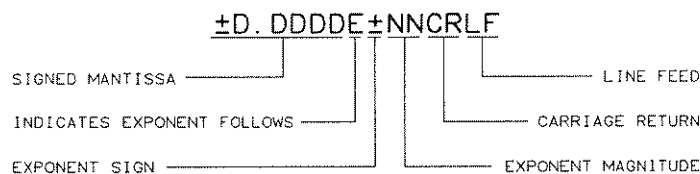

Example 2: Typical Data Output String

When an error is output to the bus, it follows the format described above.

Note



As long as the front panel display indicates a measurement error condition, the Power Meter sends 9.00XXX+40 as the measured data when addressed to talk.

Exceptions to this format are the data output for the following functions:

- Status Message
- Identification
- Read Service Request Mask Value
- Output Display
- Read Event Status Register Mask Value
- Read Event Status Register Value
- Read Service Request Mask Value
- Sensor Serial Number

Each of these functions is enabled by first addressing the Power Meter to listen. Then the Power Meter must receive a Data message with the appropriate program code. When the Power Meter is addressed to talk, it will output data for the selected function.

The output format for these functions is described in the following paragraphs. Service Request Mask Value is explained later under Sending the Service Request Mask Value.

Self-test Query. An HP-IB controlled pass/fail test exists in the Power Meter. This test can be used to ensure the circuitry of the Power Meter is operating correctly. Passing this test ensures the Power Meter is operating properly with an 80% confidence factor.

Perform the test as follows:

Note

This test assumes that the Modular Measurement System is connected to an HP-IB controller.

1. Connect a Power Sensor to the Power Meter using an HP 11730 series Power Sensor cable.
2. Send the command “*TST?” to the Power Meter.

When the test is finished, a number will be returned. This number indicates the pass/fail status of the test. The numbers and their meanings are listed in the table below.

Number Returned	Pass/Fail Status
0	Power Meter passed test. Look for possible malfunctions in other parts of the Modular Measurement System.
1	Power Meter failed test. Got to Digital/Analog isolation test listed below.

Identification. This function is used to identify the Power Meter’s model number and the firmware version. After receiving program code *IDN? and when addressed to talk, the Power Meter sends the following string: HEWLETT-PACKARD, 70100A,0,X.XX. 70100A is the instrument model number, 0 is a place holder, and X.XX is the firmware version number. The Power Meter will also respond to program code ?ID with the following string: HP70100A,REVV.XX. X.XX is the firmware version number.

Status Message. This function enables the Power Meter’s current state to be read under program control. After receiving an SM program code (Status Message) and when addressed to talk, the Power Meter sends a string of 26 ASCII characters followed by a carriage return (CR) and a line feed (LF). With the last byte of the string, the Power Meter sets the EOI line true. The Status Message is updated only after a measurement. The Status Message can be interpreted with the information shown in Figure 7-2 and Table 7-2.

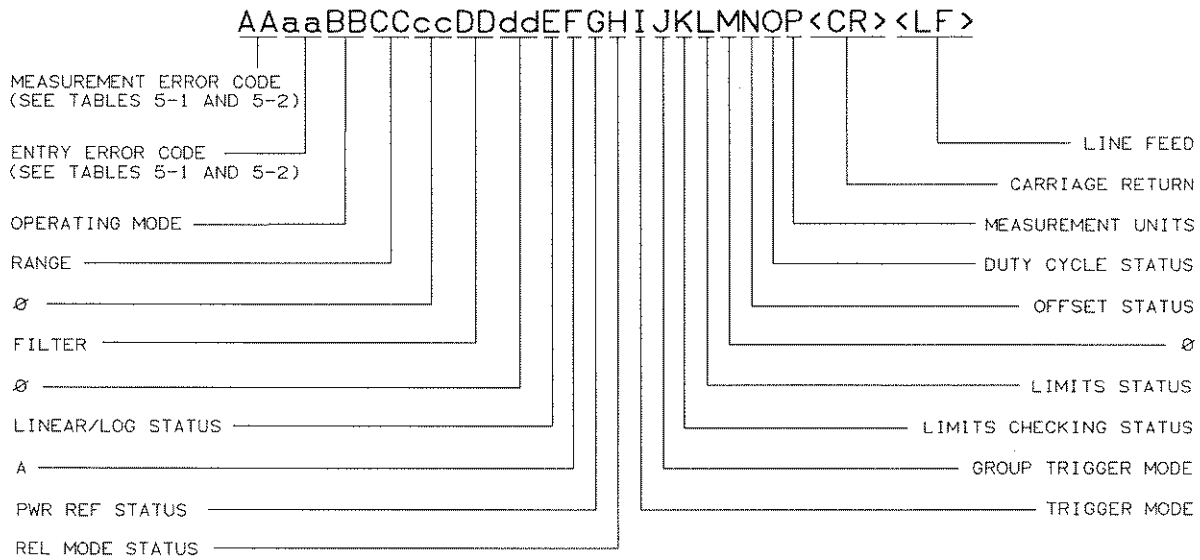

Figure 7-2. Status Message Format

Receiving the Clear Message

The Power Meter responds to the Clear message by assuming the same conditions as established by the [I-P] (instrument preset) key. Refer to Table 7-3. The Power Meter responds equally to the Selected Device Clear (SDC) bus command when addressed to listen, and the Device Clear (DCL) bus command whether addressed or not.

Receiving the Trigger Message

When in remote and addressed to listen, the Power Meter responds to a Trigger message (the Group Execute Trigger bus command [GET]) by executing one of the pre-programmed codes shown in Table 7-4. If none of the codes has been pre-programmed (via a Data message), the Power Meter responds to the Trigger message by executing one settled-measurement cycle (GT2), which is the default condition

Receiving the Remote Message

The Remote message has two parts. First, the remote enable control line (REN) is held true, then the device listen address is sent by the controller. These two actions combine to place the Power Meter in remote mode. Thus, the Power Meter is enabled to go into remote when controller begins the Remote message, but it does not actually switch to remote until addressed to listen the first time. No instrument settings are changed by the transition from local to remote. When actually in remote, the Power Meter lights the front panel RMT annunciator.

Table 7-2. Status Message Information

Code	Mode	Description
AA	Measurement Error	Refer to error codes in Troubleshooting.
aa	Entry Error	Refer to error codes in Troubleshooting
BB	Operating Mode	00=Normal 06=Zeroing 08=Calibration
CC	Range	Manual Range: 01=1 02=2 03=3 04=4 05=5 Auto Range: 11=1 12=2 13=3 14=4 15=5
cc		0
DD	Filter	Manual Filter: 00=1 01=4 02=8 03=16 4=32 05=64 06=128 07=256 08=512 09=1024 Auto Filter:10=1 11=4 12=8 13=16 14=32 15=64 16=128 17=256 18 18=512 19=1024
dd		0
E	Linear/Log Status	0=Linear 1=Log
F		A
G	PWR REF Status	0=Off 1=On
H	REL Mode Status	0=Off 1=On
I	Trigger Mode	0=Free Run 1=Standby
J	Group Trigger Mode	0=GT0 1=GT1 2=GT2
K	Limits Checking Status	0=Disabled 1=Enabled
L	Limits Status	0=In limits 1=Over limit 2=Under low limit 3=Over limit and under low limit
M		0
N	Offset Status	0=Off 1=On
O	Duty Cycle Status	0=Off 1=On
P	Measurement Units	0=Watts 1=dBm 2=% 3=dB

Table 7-3. Response to a Clear Message (Preset)

Parameter	Setting
Calibration Factor	100.0%
Duty Cycle	100%; Off
Frequency	50 MHz
Display Units	Linear
Upper Limit	90 dBm; Off
Lower Limit	-90 dBm; Off
Offset	0
Power Reference	Off
Resolution	0.01 dBm (0.1%)
Filtering	Auto
Range	Auto
Relative Measurement	Reference= 1 mW; Off
Response to GET	Trigger with Delay
Thresh	Off
Trigger	Freerun

Table 7-4. Response to a Trigger Message

Program Code	Power Meter Response
GTO	Ignore Group Execute Trigger
GT1	Trigger Immediate (TR1)
GT2	Trigger with Delay (TR2)

Receiving the Local Message

The Local message is the means by which the controller sends the Go To Local (GTL) bus command. If addressed to listen, the Power Meter returns to front panel control when it receives the Local message. If the instrument was in local lockout when the Local message was received, front panel control is returned, but lockout is not cleared. Unless it receives the Clear Lockout/ Set Local message, the Power Meter will return to local lockout the next time it goes to remote. No instrument settings are changed by the transition from remote to local.

When the Power Meter goes to local mode, the front panel RMT annunciator turns off. However, when the Power Meter is being addressed (whether in local or remote), its front panel LSN or TLK annunciator lights.

Receiving the Local Lockout Message

The Local Lockout message is the means by which the controller sends the Local Lockout (LLO) bus command. If in remote, the Power Meter responds to the Local Lockout message by disabling the front panel [IP] (instrument preset) key. The local lockout mode prevents loss of system control due to someone accidentally pressing front panel keys.

If, while in local, the Power Meter is enabled to remote (that is, REN is set true) and it receives the Local Lockout message, it will switch to remote mode with local lockout the first time it is addressed to listen. When in local lockout, the Power Meter can be returned to local only by the controller (using Local or Clear Lockout/Set Local messages), by setting the LINE switch to OFF (0) and back to ON (1), or by removing the bus cable.

Receiving the Clear Lockout/Set Local Message

The Clear Lockout/Set Local message is the means by which the controller sets the Remote Enable (REN) bus control line false. The Power Meter returns to local mode (full front panel control) when it receives the Clear Lockout/Set Local message. When the Power Meter goes to local mode, the front panel RMT annunciator turns off.

Receiving the Pass Control Message

The Power Meter does not respond to the Pass Control message because it cannot act as a controller.

Sending the Require Service Message

The Power Meter sends the Require Service message by setting the Service Request (SRQ) bus control line true. The instrument can send the Require Service message in either local or remote mode. When the Power Meter is sending the Require Service message, the front panel SRQ annunciator is enabled. The Require Service message is cleared when a serial poll is executed by the controller or when a "CS" (clear status byte) or "*CLS" (clear all status bytes) program code is received via a Data message.

There are six conditions that can be enabled to cause the Require Service message to be sent. These conditions, which are enabled by the Service Request Mask, are described below.

Data Ready: When the Power Meter has a data point requested by a trigger command.

Cal/Zero Completed: When the Power Meter has completed a calibration or zeroing cycle.

Entry Error: When a number is entered via HP-IB that is out of the allowable range for the selected parameter.

Measurement Error: When the power applied to the sensor is incorrect for the current instrument configuration.

Over/Under Limits: When the limits checking function is enabled and the measured power is greater than the high limit or lower than the low limit.

Event Status Register: When a specified condition in the Event Status Register occurs and the corresponding bit in the Event Status Enable Register is enabled (via *ESE), this bit will be set true.

Service Request Mask: The Service Request Mask determines which bits can set the Status Byte's RQS bit true (see Figure 7-3). When the RQS bit is true, the SRQ line is also true.

The Service Request Mask is set by the program code “*SRE” followed by an ASCII value between 0 and 255. Additionally, the Service Request Mask can be set by sending the program code “@1” followed by an ASCII value. The ASCII value is determined by summing the weights of each bit to be checked. Each bit, if true, enables the corresponding condition to set the RQS bit true. At turn-on, the Service Request Mask is cleared (set to 0).

Sending the Service Request Mask Value. After receiving an “*SRE?” program code (Read Service Request Mask Value) and when addressed to talk, the Power Meter will send an ASCII value between 0 and 255 that describes the present state of the mask. The Service Request Mask value can also be read by sending the program code “RV”. The ASCII value is determined by summing the weights of the bits that are set true. The bit pattern can be interpreted with the information in Figure 7-3.

Note This byte is sent with the EOI line true, thus terminating the message.



Bit 7	Bit 6	Bit 5	Bit 4	Bit 3	Bit 2	Bit 1	Bit 0
0	Require Service (RQS)	Event Status Register	Over/Under Limit	Measurement Error	Entry Error	Cal/Zero Complete	Data Ready
Value =128	Value =64	Value =32	Value =16	Value =8	Value =4	Value =2	Value =1

Figure 7-3. The Status Byte and Service Request Mask

Sending the Status Byte Message

After receiving a Serial Poll Enable (SPE) bus command and when addressed to talk, the Power Meter sends the Status Byte message. The Status Byte message consists of one 8-bit byte in which seven of the bits are set according to the conditions described under Sending the Require Service Message. The bit pattern of the Status Byte is shown in Figure 7-3. Note that bit 7 is always set to 0. The remaining bit is the RQS bit.

If one or more of the six conditions described above is both present and enabled by the Service Request Mask, the bits corresponding to those conditions (and also bit 6, the RQS bit), are set true and the Require Service message is sent. If one or more of the six conditions occurs but has not been enabled by the Service Request Mask, the corresponding bits are still set true. However, if a condition has not been enabled by the Mask, it cannot cause the RQS bit to be set true.

Once the Power Meter receives the serial poll enable (SPE) bus command, it is no longer able to alter the Status Byte. If a bit has been enabled and that condition occurs after the RQS bit has been set true, the bit is stored in a buffer and is read the next time the Power Meter receives the SPE bus command.

After the Status Byte message has been sent, it will be cleared if the Serial Poll Disable (SPD) bus command is received, if the Abort message is received, or if the Power Meter is unaddressed to talk. Bits stored in the buffer waiting to be read, however, are not cleared. Regardless of whether or not the Status Byte message has been sent, the Status Byte and any Require Service message pending will be cleared if a Clear Status (CS) or Clear Status Bytes (*CLS) program code is received by the Power Meter.

The value of the Status Byte can be read using the "*STB?" (Status Byte Query) command. When the Power Meter receives the "*STB?" command, it returns an ASCII value between 0 and 127. This value is the sum of the weighted values of the bits that are set. For example, if the Power Meter returns "012", bits 2 (value=4) and 3 (value=8) are set true. The "*STB?" command does **not** clear the Status Byte.

Event Status Register

The Event Status Register is a second status byte that is available to the user. It consists of an 8-bit byte similar to the Status Byte and is diagramed in Figure 7-4. The bits in the Event Status Register are set true when the specified event occurs. The setting of the Event Status Register can be read by sending the command "*ESR?". Upon receiving this command, the Power Meter will send an ASCII value between 0 and 255 that describes the present state of the register. The ASCII value is determined by summing the weighted values of the bits that are set.

The bits in the Event Status Register are defined below:

Power On: This bit is set when the display's LINE switch is set from OFF (0) to ON (1).

Command Error: This bit is set when an incorrect HP-IB code is sent to the Power Meter. For example, the command "QX" is a command error.

Execution Error: This bit is set when incorrect data is sent to the Power Meter. For example, the command "FR-3GZ" is an execution error.

Device Dependent Error: This bit is set true whenever a measurement error (error 1-49) occurs.

A bit being set true in the Event Status Register will cause bit 5 of the Status Byte to be set only if the corresponding bit in the Event Status Enable Register is enabled. The Event Status Enable Register is similar to the Service Request Mask in that it allows the user to select which bit(s) in the Event Status Register will set bit five in the Status Byte.

The Event Status Enable Register is set by sending the program code "*ESE" followed by an ASCII value. The ASCII value is determined by summing the weights of each bit to be checked. The setting of the Event Status Enable Register can be read by sending the command "*ESE?". Upon receiving this command, the Power Meter will send an ASCII value that describes the present state of the register. The ASCII value is determined by summing the weighted values of the bits that are set.

Bit 7	Bit 6	Bit 5	Bit 4	Bit 3	Bit 2	Bit 1	Bit 0
Power On	0	Command Error	Execution Error	Device Dependent Error	0	0	
Value =128	Value =64	Value =32	Value =16	Value =8	Value =4	Value =2	Value =1

Figure 7-4. Event Status Register and Event Status Enable Register

Clearing the Error Message Queue

There are three ways to clear the error message queue:

- Program code ERR?
- Program code SM
- Report Errors softkey on the display module

When first sent, program code ERR? will send back the oldest error stored in the queue. The queue can store as many as eight errors. Each time ERR? is sent another error code will be sent back. When there are not longer any errors to report, a value of zero will be returned.

Program code SM enables the Power Meter's current state to be read. Measurement parameters, measurement errors, and entry errors are shown. Refer to Figure 7-2, Status Message Format. If the queue contains more than one error, program code SM will return the oldest measurement and entry errors. Any additional errors will be cleared from the queue. When the queue is empty, zero will be sent in response to SM.

The final way to clear the queue is to use the **REPORT ERRORS** softkey of the display module. **REPORT ERRORS** will display all errors that have occurred.

The following steps describe how to use the **REPORT ERRORS** softkey:

1. Press [DISPLAY].
2. Press **REPORT ERRORS**. The current errors are now displayed.
3. Press [MENU] to return to the Power Meter menu.

Receiving the Abort Message

The Abort message is the means by which the controller sets the Interface Clear (IFC) bus control line true. When the Abort message is received, the Power Meter becomes unaddressed and stops talking and listening.

HP-IB Syntax and Characteristics Summary

Data Input Format: Typically the same as front panel keystrokes in local mode. Most numeric entries sent over the HP-IB must be terminated with the program code "EN" (for ENTER).

Data Output Format: Output format when no other talk mode has been defined:

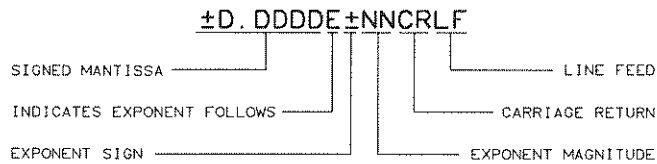

Output format for Identification: HEWLETT-PACKARD, 70100A,0,X.XX, for program code *IDN? and HP70100A,REVS.XX, for program code ?ID.

Output format for Status Message: 26 ASCII characters [CR] [LF] [EOI].

Output format for Service Request Mask Value: 1 byte [EOI].

Output format for *SRE?, *STB?, *ESR?, *ESE?, ERR? XXX [CR] [LF] [EOI] where XXX=000 to 255 in ASCII characters.

Return to Local: Front panel local key if not locked out.

Table 7-5. HP-IB Codes to Parameter Summary

HP-IB Code	Parameter
CL	CAL ⁴
*CLS	Clear all Status Registers ⁷
CS	Clear the Status Byte
CT0 – CT9	Clear sensor data tables 0-9 ¹
DC0	Duty Cycle on
DC1	Duty Cycle off
DD	Display Disable
DE	Display enable
DY	Duty Cycle (Enter duty cycle value) ⁴
ERR?	Device error query
*ESR?	Event Status Register query ⁷
*ESE	Set the Event Status Register Enable Mask ⁷
*ESE?	Event Status Register Enable Mask query ⁷
ET0 – ET9	Edit sensor cal factor table 0-9 ¹
FA	Automatic filter selection
FH	Filter hold
FM	Manual filter selection ¹
FR	FREQ ²
GT0	Ignore Group Execute Trigger (GET) bus command
GT1	Trigger Immediate response to GET command
GT2	Trigger with Delay response to GET command
ID	HP-IB Identification query
?ID	HP-IB Identification query
*IDN?	HP-IB Identification query ⁷
KB	CAL FAC ⁴
LG	Log display
LH	High limit ³
LL	Low limit ³
LM0	Disable limits checking function

Table 7-5. HP-IB Codes to Parameter Summary (cont'd)

HP-IB Code	Parameter
LM1	Enable limits checking function
LN	Linear display
OC0	Reference oscillator off
OC1	Reference oscillator on
OF0	Offset off
OF1	Offset on
OS	OFFSET (enter offset value) ⁵
PCT	Percent (can terminate DUTY CYCLE, CAL FAC, and REF CF)
PR	PRESET
RA	AUTO RNG
RC	RECALL ¹
RE	RESOLN ¹
RF0 – RF9	Enter sensor REF CAL FACTOR ¹
RH	Range hold
RL0	Exit REL mode
RL1	Enter REL mode using current Power Meter reading as REL value
RL2	Enter REL mode using old REL value
RM	SET RANGE ¹
RR	Enter REL mode using new REL value ³
*RST	Soft reset ⁷
RV	Read Service Request Mask Value
SE	SENSOR ¹
Service Codes	Refer to the HP 70100A Service Manual.
SM	Status Message
SN0 – SN9	Enter sensor serial number ⁶
SN?	Sensor serial number query
*SRE	Set the Service Request Mask Value ⁷
*SRE?	Service Request Mask query ⁷

Table 7-5. HP-IB Codes to Parameter Summary (cont'd)

HP-IB Code	Parameter
ST	STORE ¹
*STB?	Read the Status Byte
TR0	Trigger Hold
TR1	Trigger Immediate
TR2	Trigger with Delay
TR3	Trigger-Free Run
TR4	Trigger with Delay (Delay is longer than TR2.)
*TST?	Self test query
ZE	ZERO
@1	Prefix for Status Mask
%	Terminates Sensor Data table calibration factor entry (Can be used for DUTY CYCLE, CAL FAC, and REF CF)
<p>¹These HP-IB codes require a numeric entry followed by the program code EN (ENTER).</p>	
<p>²These HP-IB codes require a numeric entry followed by one of these program codes: GZ (GIGAHERTZ), MZ (MEGAHERTZ), KZ (KILOHERTZ), HZ (HERTZ), or EN (ENTER).</p>	
<p>³These HP-IB codes require a numeric entry followed by one of these program codes: KW (KILOWATT), W (WATT), MW (MILLIWATT), UW (MICROWATT), NW (NANOWATTS), DB (dBm), DM (dBm), or EN (ENTER).</p>	
<p>⁴These HP-IB codes require a numeric entry followed by one of these program codes: PCT (PERCENT), % (PERCENT), or EN (ENTER).</p>	
<p>⁵These HP-IB codes require a numeric entry followed by one of these program codes: DB (DECIBEL), or EN (ENTER).</p>	
<p>⁶This HP-IB code will use the next 6 characters (0-9, A-Z, or an underscore) as input data.</p>	
<p>⁷The "*" must be included as part of your HP-IB command string.</p>	

The following programming examples describe how to calibrate and zero the Power Meter.

Note



The following programs were written in BASIC 5.0 for the HP 9000 series 200 or 300 controllers.

The first program calibrates the Power Meter with a REF CF of 100% and displays whether the calibration was successful or unsuccessful. Lines 3000 through 3270 comprise a subroutine that contains the calibration routine. Lines 10 through 90 run the subroutine and print the result.

The second program initiates the zero routine and displays whether the zeroing was successful or unsuccessful. Lines 3000 through 3240 comprise a subroutine that contains the zeroing routine. Lines 10 through 90 run the subroutine and print the result.

Calibration Program Example

```

10 ! Program 'CAL 70100A
20 !
30 CALL Cal_70100A (713, 100, Err)
40 IF Err=0 THEN
50 PRINT "CAL SUCCESSFUL"
60 ELSE
70 PRINT "CAL UNSUCCESSFUL"
80 END IF
90 END
3000 SUB Cal_70100A (Hplib_address, Ref_cal_factor,Err)
3010 !
3020 !4/06/89: Simple subroutine to CALIBRATE the 70100A power meter
3030 ! Ref_cal_factor = Input of REF CF in percent
3040 ! If Err=0, then CAL was successful.
3050 ! If Err=1, then CAL was unsuccessful.
3060 !
3070 OUTPUT Hplib_address;"CS" !Clear SPOLL register
3080 Time_zero=TIMEDATE !Initialize time interval counter
3090 OUTPUT Hplib_address;"CL"&VAL$(Ref_cal_factor)&"EN"
3100 !Send the CAL command, reference
3110 !cal factor and ENTER
3120 I=1
3130 WHILE I !Cycle till Timeout, Routine
3140 !finished or measurement
3150 ! error occurs.
3160 Deltat=TIMEDATE-Time_zero !Time to CAL
3170 Spval=SPOLL(Hplib_address) !Check Status Byte
3180 IF Deltat>10 OR BIT (Spval,3) THEN
3190 Err=1 !CAL unsuccessful
3200 I=0
3210 END IF
3220 IF BIT(Spval,1) THEN
3230 Err=0 !CAL successful
3240 I=0
3250 END IF
3260 END WHILE
3270 SUBEND
3280 !

```

Zeroing Program Example

```
10 ! Program 'ZERO 70100A
20 !
30 CALL Zero_70100A (713,Err)
40 IF Err=0 THEN
50 PRINT "ZERO SUCCESSFUL"
60 ELSE
70 PRINT "ZERO UNSUCCESSFUL"
80 END IF
90 END
3000 SUB Zero_70100A (Hpib_address,Err)
3010 !
3020 ! 4/06/89: Simple subroutine to ZERO the 70100A power meter
3030 ! If Err=0, then ZEROing was successful.
3040 ! If Err=1, then ZEROing was unsuccessful.
3050 !
3060 OUTPUT Hpib_address;"CS" !Clear SPOLL register
3070 Time_zero=TIMEDATE !Initialize time interval counter
3080 OUTPUT Hpib_address;"ZE" !Send ZERO command
3090     I=1
3100     WHILE I !Cycle till Timeout, Routine
3110         !finished or measurement
3120         ! error occurs.
3130         Deltat=TIMEDATE-Time_zero !Time variable
3140         Spval=SPOLL(Hpib_address) !Check Status Byte
3150         IF Deltat>30 OR BIT (Spval,3) THEN
3160             Err=1 !ZERO unsuccessful
3170             I=0
3180         END IF
3190         IF BIT(Spval,1) THEN
3200             Err=0 !ZERO successful
3210             I=0
3220         END IF
3230     END WHILE
3240 SUBEND
3250 !
```

Index

A

- Abort message
 - receiving, 7-19
- Accessories
 - Display Screen Cleaner, 1-6
 - Power Sensor Cables, 1-5
 - Rear Fan Filter, 1-6
- Addressing
 - setting, 7-9
- Address Matrix, 2-4
 - display communication capabilities, 2-5
 - display-response area, 2-5
 - HP-IB Access Area, 2-4
- Address Switches, 2-5
 - display, 2-6
 - power meter, 2-6
- Annotation block, 6-42

C

- Calibrating, 6-10
- Calibration factor
 - entering, 6-25
- Calibration Functions
 - calibrating, 6-10
 - detailed operation, 6-10
 - overview, 6-7-9
 - power reference, 6-11
 - sensor tables, 6-12
 - zeroing, 6-10
- Characteristics, 3-3-4
- Clear lockout/set local message
 - receiving, 7-15
- Clear message
 - receiving, 7-13
- Communication with the System, 7-4
- Confidence Test
 - see* Self-Test Query, 7-12
- Connecting Instrument Cabinets, 1-13

D

- Data messages, 7-10
 - input format, 7-10
 - output format, 7-11
 - program codes, 7-10
 - receiving, 7-10

- sending, 7-11
- Description
 - Power Meter, 1-2
- Diagnostic procedures, 5-8
- Display keys
 - overview, 6-3
- Display tests, 5-7
- Duty Cycle
 - entering, 6-27

E

- Electrostatic Discharge, 1-18
 - reducing damage, 1-18
 - static-safe accessories, 1-19
 - test equipment, 1-19
- Entry hold, 6-42
- Error lights, 5-11
 - flashing E (error) letter or ERR (error) light, 5-12
 - HP 70001A Mainframe CURRENT indicator, 5-13
 - HP 70001A Mainframe I/O CHECK indicator, 5-13
 - HP 70001A Mainframe VOLT/TEMP indicator, 5-12
 - I/O indicator on the HP 70206A System Graphics Display, 5-12
- Error message queue
 - clearing, 7-19
- Error message reporting, 5-3
 - display-disruptive errors, 5-5
 - error report screen, 5-3
- Error messages, 5-14
- Executing remote commands, 7-4
 - local and remote control, 7-4
 - syntax requirements, 7-4

F

- Failures
 - categorizing, 5-8
- Filtering
 - selecting, 6-31
- Firmware
 - identification, 7-12
 - Power Meter, 1-4
- Front Handle Removal and Replacement, 1-11

Front panel
troubleshooting, 5-9

Front Panel
connectors, 1-3
LEDs, 1-2

H

Hewlett-Packard Interface Bus, 7-6
compatibility, 7-6
HP-IB message, 7-7
HP-MSIB/HP-IB Addressing, 2-3
HP-MSIB troubleshooting utility, 5-7

I

Initial Inspection and Setup, 1-11
Initial program considerations, 7-5
Installation
initial power-on , 2-1
module installation and removal, 2-2
Interconnections, 1-3

L

Limits
setting, 6-34
Local lockout message
receiving, 7-15
Local message
receiving, 7-15
Local mode
capability, 7-9
local lockout, 7-9
remote-to-local, 7-9

M

Mainframe/Module Interconnect, 1-4
Manual update package, 1-1
Measurement frequency
entering, 6-24
Measurement Functions
calibration factor, 6-25
detailed operation, 6-24
duty cycle, 6-27
filtering, 6-31
frequency, 6-24
limits, 6-34
offset, 6-25
overview, 6-20-23
range, 6-30
relative mode, 6-28
resolution, 6-32
triggering, 6-35
Miscellaneous functions
annotation, 6-42
detailed operation, 6-42

entry hold, 6-42
overview, 6-41
service tests, 6-44
Modular Measurement System Terms
functional, 2-3, 5-1
structural, 2-3, 5-1
Module Latch, 1-3

O

Offset
entering, 6-25
Operating Requirements
400 Hz Option, 1-8
fuse replacement, 1-7
line voltage selection, 1-6
operating environment, 1-9
physical requirements, 1-6
power cables, 1-8
Options
HP 70001A Mainframe , 1-5
HP 70100A Power Meter , 1-5
HP 70206A System Graphics Display , 1-5
W30 Service Option, 1-5

P

Packaging, 1-15
Pass control message
receiving, 7-15
Power Meter operation
preparation , 6-2
Power reference, 6-11
Power-up
selection, 6-40
Printing Conventions, 1-1
Program codes, 7-10
Program code summary, 7-21
Program examples, 7-24-25

R

Rack-Mounting, 1-13
with slides, 1-13
Range
selecting, 6-30
Rear Panel
connectors, 1-4
Relative reference
changing reference, 6-29
entering, 6-28
using current reference, 6-29
using Power Meter reading, 6-29
Remote message
receiving, 7-15
Remote mode
local-to-remote, 7-9

Index-2

- remote capability, 7-8
- Replaceable system parts, 5-18
 - direct mail-order system, 5-18
 - ordering, 5-18
- Require service message
 - event status register, 7-18
 - sending, 7-16
 - sending mask value, 7-16
- Resolution
 - selecting, 6-32

S

- Self-Test
 - Power Meter, 5-6
 - Self-Test Query, 7-12
- Sensor tables, 6-12
 - clearing, 6-18
 - copying, 6-17
 - delete line, 6-16
 - edit/view, 6-13
 - naming, 6-15
 - saving, 6-15
 - selection, 6-13
- Serial number, 1-1
- Service Tests, 6-44
- Soft-Set HP-IB Addresses, 2-7
- Specifications, 3-2
- State
 - detailed operation, 6-39
 - overview, 6-37-38
 - power-up state, 6-40
 - protect registers, 6-40
 - recall state, 6-40
 - save state, 6-39
 - show state, 6-39
- Status byte message
 - sending, 7-17

- Status indicators, 5-2
- Status Indicators
 - active, 5-3
 - error, 5-2
- Status message
 - output format, 7-12
- Storage
 - environment, 1-15
- Storage and Shipment, 1-15-16

T

- Trigger
 - selection, 6-35
- Trigger message
 - receiving, 7-14
- Troubleshooting
 - over HP-IB, 5-10
- Troubleshooting catastrophic failures, 5-10
 - A blank or distorted CRT display, 5-10
 - Abnormal CRT screen, 5-10
 - CRT blank except for a message written in large block letters, 5-11
 - CRT shows Display ID screen, 5-11
 - Missing user or menu screen softkeys, 5-11
- Troubleshooting tools, 5-1
- Turn-on
 - default HP-IB conditions, 7-9

V

- Verification
 - Instrument Accuracy Test, 4-5
 - Power Reference Level Test, 4-8
 - Zero Carryover Test, 4-3

Z

- Zeroing, 6-10



REGIONAL SALES AND SUPPORT OFFICES

For information relating to Sales or Support of Hewlett-Packard products, first contact your local Hewlett-Packard office listed in the white pages of your telephone directory. If none is listed locally, contact Hewlett-Packard at one of the offices listed below to obtain the address or phone number of the Sales or Support office nearest you.

ASIA

Hewlett-Packard Asia Ltd.
47/F, 26 Harbour Road
Wanchai, **HONG KONG**
G.P.O. Box 863, Hong Kong
Tel: (852) 5-8330833
Telex: 76793 HPA HX
Cable: HPASIAL TD

AUSTRALASIA

Hewlett-Packard Australia Ltd.
31-41 Joseph Street
BLACKBURN, Victoria 3130
Australia
Tel: (61) 895-2895
Telex: 31-024
Cable: HEWPARD Melbourne

CANADA

Hewlett-Packard (Canada) Ltd.
6877 Goreway Drive
MISSISSAUGA, Ontario L4V 1M8
Tel: (416) 678-9430
Telex: 069-8644

JAPAN

Yokogawa-Hewlett-Packard Ltd.
29-21 Takaido-Higashi, 3 Chome
Suginami-ku **TOKYO** 168
Tel: 03 (331) 6111
Telex: 232-2024 YHPTOK

MEDITERRANEAN & MIDDLE EAST

Hewlett-Packard S.A.
Mediterranean and Middle East
Operations
Atrina Centre
32 Kifissias Avenue
Paradissos-Amarousion, **ATHENS**
Greece
Tel: (30) 682 88 11
Telex: 21-6588 HPAT GR
Cable: HEWPACKSA Athens

BENELUX & SCANDINAVIA

Hewlett-Packard S.A.
Uilenstede 475
P.O. Box 999
NL-1183 AG **AMSTELVEEN**
The Netherlands
Tel: (31) 20/43 77 71
Telex: 18 919 hprner nl

SOUTH & EAST EUROPE, AFRICA

Hewlett-Packard S.A.
7, rue du Bois-du-Lan
CH-1217 **MEYRIN** 2, Geneva
Switzerland
Tel: (41) 22/83 12 12
Telex: 27835 hmea
Cable: HEWPACKSA Geneve

FRANCE

Hewlett-Packard France
Parc d'activités du Bois Briard
2, avenue du Lac
91040 **EVRY** Cedex
Tel: 1 6/077 83 83
Telex: 6923 15F

GERMAN FEDERAL REPUBLIC

Hewlett-Packard GmbH
Hewlett-Packard-Strasse
Postfach 1641
D-6380 **BAD HOMBURG**
West Germany
Tel: 06172/400-0
Telex: 410 844 hpbhg

ITALY

Hewlett-Packard Italiana S.p.A.
Via G. Di Vittorio 9
1-20063 **CERNUSCO SUL NAVIGLIO**
(Milano)
Tel: 02/92 36 91
Telex: 334632

UNITED KINGDOM

Hewlett-Packard Ltd.
King Street Lane
Winnersh, **WOKINGHAM**
Berkshire RG11 5AR
Tel: 734/78 47 74
Telex: 847178

EASTERN U.S.A.

Hewlett-Packard Co.
4 Choke Cherry Road
ROCKVILLE, MD 20850
Tel: (301) 670-4300

MIDWESTERN U.S.A.

Hewlett-Packard Co.
5201 Tollview Drive
ROLLING MEADOWS, IL 60008
Tel: (312) 255-9800

SOUTHERN U.S.A.

Hewlett-Packard Co.
2000 South Park Place
P.O. Box 105005
ATLANTA, GA 30348
Tel: (404) 955-1500

WESTERN U.S.A.

Hewlett-Packard Co.
5161 Lankershim Blvd.
P.O. Box 3919
NO. HOLLYWOOD, CA 91609
Tel: (818) 506-3700

OTHER INTERNATIONAL AREAS

Hewlett-Packard Co.
Intercontinental Headquarters
3495 Deer Creek Road
PALO ALTO, CA 94304
Tel: (415) 857-1501
Telex: 034-8300
Cable: HEWPACK



Free Manuals Download Website

<http://myh66.com>

<http://usermanuals.us>

<http://www.somanuals.com>

<http://www.4manuals.cc>

<http://www.manual-lib.com>

<http://www.404manual.com>

<http://www.luxmanual.com>

<http://aubethermostatmanual.com>

Golf course search by state

<http://golfingnear.com>

Email search by domain

<http://emailbydomain.com>

Auto manuals search

<http://auto.somanuals.com>

TV manuals search

<http://tv.somanuals.com>