



OPERATING AND SERVICE MANUAL

# MODEL 181A/AR OSCILLOSCOPE

SERIALS PREFIXED:840

See Section VII for Instruments With Other Serial Prefixes

Copyright HEWLETT-PACKARD COMPANY/COLORADO SPRINGS DIVISION 1967  
1900 GARDEN OF THE GODS ROAD, COLORADO SPRINGS, COLORADO, U. S. A.

Table 1-1. Specifications.

### HORIZONTAL AMPLIFIER

**External Input**

Bandwidth: dc coupled, dc to 5 MHz; ac coupled, 5 Hz to 5 MHz.

Deflection Factor (sensitivity): 1 v/div,  $\pm 5\%$  on X1; 0.2 v/div  $\pm 5\%$  on X5; 0.1 v/div  $\pm 5\%$  on X10; vernier provides continuous adjustment between ranges. Dynamic range  $\pm 5$  v.

Input RC: 1 megohm shunted by approximately 30 pf.

Sweep Magnifier: X1, X5, X10; magnified sweep accuracy  $\pm 5\%$ .

### CALIBRATOR

Type: approximately 1 kHz square wave, less than 3  $\mu$ sec rise time.

Voltage: 10v peak-to-peak,  $\pm 1\%$ .

### CATHODE RAY TUBE AND CONTROLS

Type: post-accelerator storage tube, 8.5 kv accelerating potential, aluminized P31 phosphor.

Graticule: 8 x 10 division parallax-free internal graticule marked in .95 centimeter squares.

Subdivisions of 0.2 div on major axes. Front panel recessed TRACE ALIGN aligns trace with graticule. Y axis may be aligned to be perpendicular with X axis with internal control for accurate rise time measurements.

Writing Rate: Write mode; 20 cm/msec

Max write mode; 1 cm/ $\mu$ sec

Erase: push-button erasure takes approximately 300 msec.

Brightness: greater than 200 foot/lamberts with entire screen faded positive.

Persistence: continuously variable from less than 0.2 second to more than one minute, or normal P31 persistence of approx 40  $\mu$ sec.

Storage Time (MAX W) Mode: ten minutes is STORE mode, ten seconds in VIEW mode.

Beam finder: pressing FIND BEAM control when operating in any mode except STORE or VIEW brings trace on CRT screen regardless of setting of horizontal or vertical controls.

Intensity Modulation: approximately +2 volts, dc to 15 MHz, will blank trace of normal intensity. Input resistance is 5100 ohms.

### OUTPUTS

Four emitter follower outputs for main and delayed gates, main and delayed sweeps. Maximum current available is  $\pm 3$  ma. Outputs will drive impedances down to 1k ohm without distortion.

### GENERAL

Active Components: all solid state (no vacuum tubes except CRT).

Environment: Model 181A/AR Oscilloscope with plug-ins operates within specifications over the following ranges:

Temperature: 0° C to +55° C.

Humidity: to 95% relative humidity to 40° C.

Altitude: to 15,000 ft.

Vibration: vibrated in three planes for 15 min each with 0.010 inch excursion, 10 to 55 Hz.

Power: 115 or 230 volts,  $\pm 10\%$ ; 50-400 Hz, 100 watts at normal line, convection cooled.

Dimensions: cabinet (overall dimensions) 8" (203) wide, 11" (280) high, 22-1/2" (570) deep.

Rack Dimensions/Model 181AR:

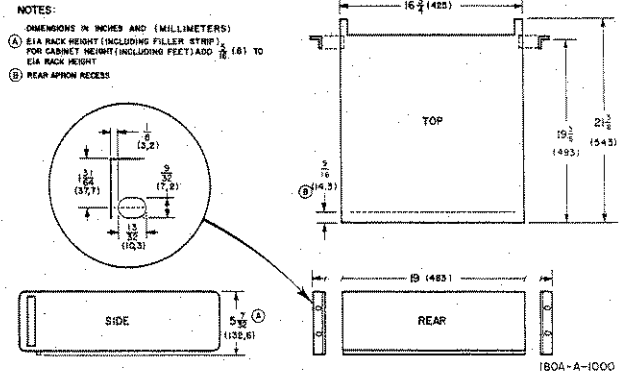

Weight: (without plug-ins) Model 181A; Net, 24 lbs (10,9 kg); Shipping, 32 lbs (14,5 kg).  
Model 181AR (rack); Net, 26 lbs (11,8 kg);  
Shipping 35 lbs (15,9 kg).

Accessories Furnished: mesh contrast filter, detachable power cord, rack mounting hardware, (rack model only).

## SECTION I GENERAL INFORMATION

### 1-1. DESCRIPTION.

1-2. The Model 181A/AR, Figure 1-1, is a lightweight, general purpose, variable persistence, storage oscilloscope with plug-in capability. The Model 181A and the Model 181AR as shipped from the factory are intended for bench use. The Model 181AR may be rack mounted as described in Section II.

1-3. Except for the CRT, all active components are solid state devices. The Model 181A/AR is convection cooled and operates within specifications over a temperature range of 0° C to +55° C.

1-4. The variable persistence capability is especially useful for viewing slow-speed signals. Adjustment of persistence time can provide viewing of a complete trace with fading sufficient to prevent interference with the next trace. The display persistence can readily be adjusted to eliminate flicker and still provide high resolution.

1-5. The storage feature of the hp Model 181A/AR can be used to store single-shot occurrences for later viewing or photographing. Comparison of waveforms can be accomplished by storing several separate occurrences and later viewing them simultaneously.

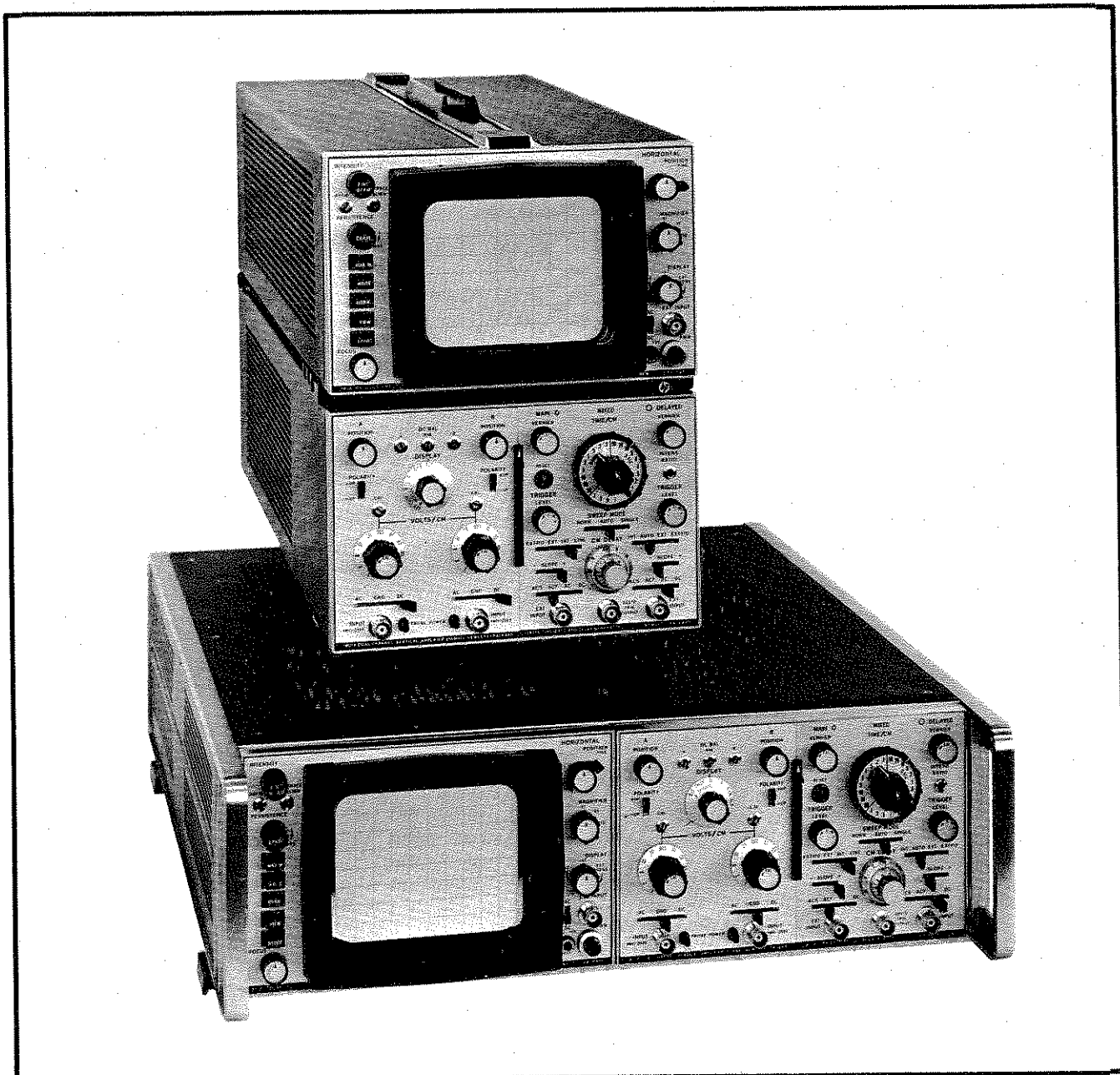

Figure 1-1. Model 181A and 181AR Oscilloscopes

1-6. The horizontal amplifier has a direct-coupled bandwidth of dc to 5 MHz. The ac-coupled bandwidth is 5 Hz to 5 MHz. With a dynamic range of  $\pm 5$  volts, the amplifier has front-panel selectable deflection ranges of 1 v/div, 0.2 v/div and 0.1 v/div. A vernier control provides continuous adjustment between ranges. A magnified sweep accuracy of  $\pm 5\%$  is maintained at selectable magnifications of X1, X5 or X10; and a front panel BNC connector permits the use of external deflection signals. The external input has an input impedance of 1 megohm shunted by approximately 30 pf.

1-7. A rear panel BNC connector is provided for external control of CRT blanking. A signal of approximately +2v from dc to 15 MHz will blank a trace of normal intensity. The input resistance is 5100 ohms.

1-8. External outputs are provided through four rear panel mounted BNC connectors for coupling plug-in derived signals to external equipment. Since these outputs are dependent upon the plug-ins utilized, the appropriate plug-in Operating and Service Manual should be referred to for identification of the output signals available. The output amplifiers can supply 3 ma, and will drive impedances as low as 1000 ohms without distortion.

1-9. A 1 kHz square wave signal is available at the front panel for calibration purposes. Its amplitude of 10 volts peak-to-peak is accurate to  $\pm 1\%$ , and it has a rise time of less than  $3\mu$  sec. The signal may be used to adjust horizontal and vertical deflection factors and to compensate divider probes.

### 1-10. CATHODE RAY TUBE.

1-11. The Model 181A/AR uses an internal graticule, P31 aluminized phosphor CRT. Special internal elements provide the variable persistence and storage features. Parallax observation error is eliminated by use of the internal graticule, and a non-glare safety face plate is bonded to the CRT.

### 1-12. WARRANTY.

1-13. This instrument is certified and warranted as described on the inside front cover of this manual. The CRT is covered by a warranty separate from the rest of the instrument. The CRT warranty and warranty claim forms are located at the rear of this manual. Should the CRT fail within the time specified on the warranty, contact your nearest hp Sales/Service Office, and return the CRT with the warranty form completed.

### 1-14. ACCESSORIES FURNISHED.

1-15. The standard Model 181A/AR Oscilloscope is supplied with a mesh contrast filter, and a detachable

power cord. Also included with the Model 181AR is a rack mounting kit.

### 1-16. ACCESSORIES AVAILABLE.

1-17. A mobile test stand for the cabinet Model 181A is available. The Model 1118A Testmobile provides adjustable height, tilt, and rotation. Equipped with locking wheels, it is readily collapsible for transport. An adapter assembly, available as hp Part No. 01119-69501, permits the rack Model 181AR to be mounted on the Model 1119A Testmobile.

1-18. A front panel cover of fiberglass material, hp Model 10166A, can be used to provide front panel protection for the cabinet Model 181A, and a cover for the rack Model 181AR is available as hp Part No. 5060-0437.

1-19. For ease of calibration and maintenance an hp Model 10407A Plug-in Extender can be obtained. It provides for removal of the plug-ins from the main frame and exposes components and adjustments.

1-20. Cameras, probes, viewing hoods, terminations and other accessory items are available for specialized requirements. Information on these and the above described accessories may be obtained from hp Sales/Service Offices listed in the rear of this manual.

### 1-21. INSTRUMENT IDENTIFICATION.

1-22. Hewlett-Packard uses a two-section, eight-digit serial number to identify instruments. The first three digits (preceding the dash) are the serial prefix which identifies a series of instruments; the last five digits identify a particular instrument in the series. The serial number appears on a plate located on the rear panel. All correspondence with a Hewlett-Packard Sales/Service Office in regard to an instrument should reference the complete serial number.

### 1-23. SCOPE OF MANUAL.

1-24. This manual provides operating and service information for the hp Model 181A/AR Oscilloscope. Information and operation of plug-ins is contained in appropriate plug-in manuals. Information in this manual applies directly to instruments (as manufactured) with serial numbers prefixed by the three digits indicated on the title page. If the serial prefix of the instrument is different from that on the title page, a "Manual Changes" sheet supplied, or Section VII of this manual, will describe changes which will adapt this manual to provide correct coverage. Technical corrections (if any) to this manual, due to known errors in print, are called Errata and are shown on the change sheet. For information on manual coverage of any hp instrument, contact the nearest hp Sales/Service Office (addresses are listed at the rear of this manual).

## SECTION II INSTALLATION

### 2-1. INITIAL INSPECTION.

2-2. **MECHANICAL CHECK.** Check the shipping carton for damage immediately after receipt. If it is damaged, ask the carrier's agent to be present when the instrument is unpacked. Inspect the Model 181A/AR for physical damage such as bent or broken parts and dents or scratches. If damage is found, refer to Paragraph 2-4 for recommended claim procedure. If the Model 181A/AR appears undamaged, perform the electrical check (Paragraph 2-3). Retain the packaging material for possible future use.

2-3. **ELECTRICAL CHECK.** The performance check is given in Paragraphs 5-5 through 5-14. This check will determine whether or not the instrument is still operating within its specifications as listed in Table 1-1. The initial performance and accuracy of this instrument are certified as stated on the inside front cover of this manual. If the Model 181A/AR does not operate as specified, refer to Paragraph 2-4 for the recommended claim procedure. Prior to initiating any performance check, refer to Paragraphs 2-10 through 2-14 and the operating guidance provided in Section III.

### 2-4. CLAIMS.

2-5. If physical damage is found or if the instrument is not within specifications when received, notify the carrier and the nearest Hewlett-Packard Sales/Service Office immediately. The Sales/Service Office will arrange for the repair or replacement of the instrument without waiting for a claim to be settled with the carrier.

### 2-6. REPACKAGING FOR SHIPMENT.

2-7. If the instrument is to be shipped to a Hewlett-Packard Sales/Service Office, attach a tag to it showing owner and owner's address, instrument's model number and 8 digit serial number, and a description of service required.

2-8. The original shipping carton and packaging materials, except for the accordion-pleated pads, should be used for reshipment. If they are not available or reusable, the instrument should be repackaged with the following materials:

- a. A double-walled carton (refer to Table 2-1 for test strength required).

Table 2-1. Shipping Carton Test Strength

Gross Weight (lbs)	Carton Test Strength (lbs)
up to 10	200
10 to 30	275
30 to 120	350
120 to 140	500
140 to 160	600

- b. Heavy paper or sheets of cardboard to protect all instrument surfaces (use a nonabrasive material such as polyurethane or a cushioned paper such as Kimpak around all projecting parts).

- c. At least 4 inches of tightly packed, industry approved, shock absorbing material, such as extra firm polyurethane foam.

- d. Heavy duty shipping tape to secure outside of carton.

### 2-9. PREPARATION FOR USE.

#### 2-10. POWER REQUIREMENTS.

2-11. The Model 181A/AR requires either a 115 or 230 vac  $\pm 10\%$ , single phase, 50 to 400 Hz power source that can deliver 100 watts.

- a. **115V OPERATION.** This instrument as shipped, is ready for operation on 115 vac. See Step b below for 230 vac operation.



Before applying power, check the rear panel slide switch for proper position, (115 or 230).

- b. **230V OPERATION.** If the instrument is to be operated on 230 vac, set the rear panel switch to 230. It is not necessary to replace the 115V fuse. Positioning the 115/230 switch selects the proper fuse for the desired voltage.

#### 2-12. THREE-CONDUCTOR POWER CABLE.

2-13. The National Electrical Manufacturer's Association (NEMA) recommends that the instrument panel and cabinet be grounded to protect the operating personnel. The Model 181A/AR is equipped with a detachable three-conductor power cord which, when plugged into an appropriate outlet, grounds the instrument through the round offset pin. When operating the Model 181A/AR from a two-contact outlet, use a three-conductor to two-conductor adapter. Preserve the safety feature by grounding the adapter lead. A 3-way grounding terminal is also provided on the rear panel of the instrument.

#### 2-14. INSTRUMENT MOUNTING.

2-15. **BENCH USE.** Both the Model 181A and the Model 181AR, as shipped from the factory, are intended for bench use. The Model 181AR, however, may be rack mounted as described in Paragraph 2-16.

2-16. **RACK MOUNTING.** A kit for converting the Model 181AR to a rack mount is supplied with each instrument. Instructions for making the conversion are given below. Refer to Figure 2-1 for parts identification.

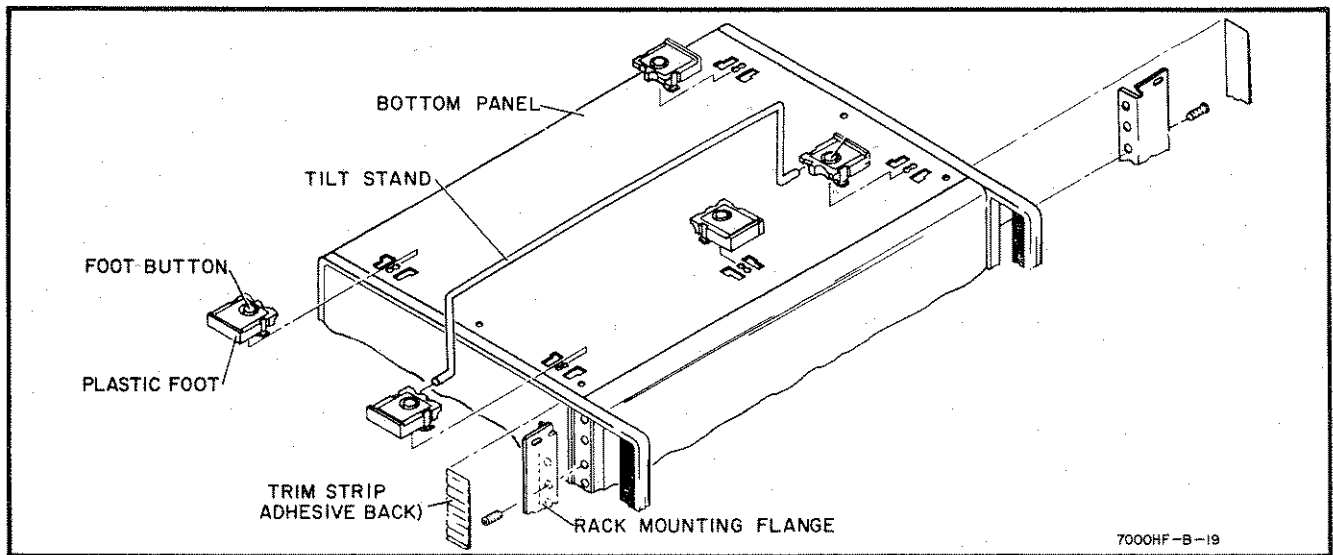

Figure 2-1. Bench/Rack-Mount Conversion

a. Detach tilt stand by pressing it away from front feet. Remove all plastic feet by depressing metal button and sliding feet free.

b. Remove aluminum trim strip from each side of instrument with a thin blade tool.

c. Attach rack mounting flange in space from which trim strip was removed (use screws provided with kit).

Large notch of flange should be positioned at bottom of instrument.

#### 2-17. INSTRUMENT COOLING.

2-18. The Model 181A/AR does not need forced-air cooling when operated in an ambient temperature of 0 to +55 degrees centigrade. Normal air circulation will maintain a reasonable temperature within the instrument.

#### 2-19. CONTRAST FILTER AND BEZEL REMOVAL.

2-20. A contrast filter which also acts as an RFI shield is located behind the bezel. Use of the filter is recommended since it provides for comfortable viewing and RFI shielding. In specific cases, however, such as when a camera is attached for use with the oscilloscope, removal of the filter may be desirable. To accomplish this, merely remove the bezel as shown in Figure 2-2, slip the filter out, and replace the bezel.

2-21. To remove the bezel, grasp it as shown in Figure 2-2A, gently apply a downward pressure with the index fingers until the bezel's upper ear is free of its slot, pull slightly forward and release. Next, grasp the bezel as shown in Figure 2-2B, apply an upward pressure with the thumbs until the bezel's

lower ear clears its slot, pull forward and remove the bezel. Be certain to apply pressure on the inner edge of the bezel to release the ears in both steps since pressure on the outer edge tends to cause a swivel action, defeating the purpose, and subjecting the ears to possible damage.

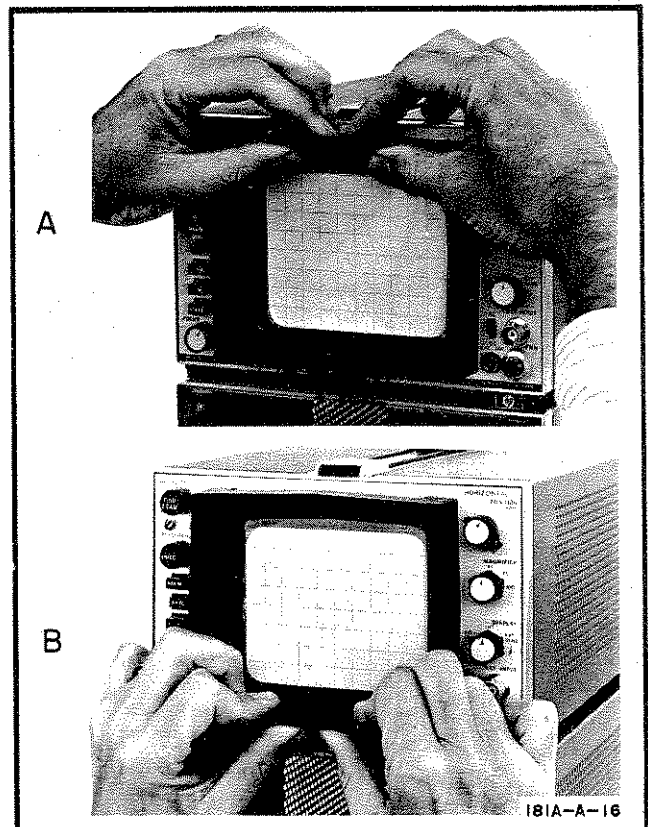

Figure 2-2. Bezel Removal

## SECTION III OPERATION

### 3-1. INTRODUCTION.

3-2. The Model 181A/AR is a light weight, variable persistence, storage oscilloscope using plug-in vertical and horizontal modules. Both high and low voltage power supplies, a calibrator, the CRT, and circuitry for the variable persistence and storage operation are contained in the Model 181A/AR. A compartment for the horizontal and vertical plug-ins is located in the lower portion of the Model 181A and in the right hand portion of the Model 181AR. In both models the compartment is designed to accept the vertical plug-in on the left side and the horizontal plug-in on the right. The plug-in units must be locked together before being inserted into the compartment (see plug-in manuals).

### 3-3. OPERATING CONSIDERATIONS.

3-4. Prior to operating the Model 181A/AR, the operator must have a thorough understanding of instrument operation and control functions. This section should be read in its entirety before attempting to operate the instrument.



To avoid CRT damage, the following procedure should be followed every time the instrument is operated.

3-5. The following are steps that must be taken prior to applying power to the Model 181A/AR Oscilloscope.

- a. Depress WRITE push button.
- b. Set PERSISTENCE control fully ccw.
- c. Set INTENSITY control fully ccw.
- d. Apply power to Model 181A/AR
- e. After 3 minutes, the entire CRT viewing area should be evenly flooded green.

#### NOTE

If there is no green illumination, turn instrument off and check all CRT connections.

### 3-6. CONTROLS AND CONNECTORS.

3-7. The location of operating controls and connectors is shown in Figure 3-1 together with a brief explanation of their functions. Additional information regarding some of these controls and connectors is provided below.

#### 3-8. FRONT PANEL.

3-9. FOCUS AND ASTIGMATISM. These controls are provided to assure uniform focus of the trace over the entire CRT screen. To adjust, set the Presentation Selector to WRITE, center a low-intensity spot on the CRT screen, and adjust FOCUS and ASTIGMATISM

controls for a small, round, sharply focused spot. Readjustment of the ASTIGMATISM control is seldom required except, for example, when the vertical plug-in is changed.

3-10. STORE. In order to retain whatever is visible on the CRT, depress the STORE push button. The signal will be stored at reduced intensity, resulting in a storage time of greater than one hour. The INTENSITY, PERSISTENCE, FOCUS, ERASE, and HORIZONTAL POSITION controls do not affect the presentation in the STORE mode.

3-11. In some applications, it may be desirable to show several overlapping traces at once. This is possible through proper manipulation of the PERSISTENCE and INTENSITY controls. Simply obtain the desired multiple trace display in the WRITE mode, then depress the STORE push button.

3-12. A display stored on the CRT when power is removed from the instrument will remain stored for several days. In order to observe this stored display, depress the VIEW push button and turn the POSITION control on the Vertical Plug-in counterclockwise prior to restoring power to the instrument. This prevents a bright spot from being portrayed on the screen due to the initial surge from the CRT write gun.

3-13. Several individual waveforms may also be stored, even though they are written at different times. Having stored a trace, for instance, the operator may choose to switch back to WRITE and record another trace, etc., prior to erasing. And by turning the Model 181A/AR power off, as few as one trace a day can be recorded for a week or more, depending on total time instrument is turned on, as storage time would decrease accordingly.

3-14. VIEW. To observe a previously stored display, depress the VIEW push button. The stored display will be intensified to a brightness level determined by the intensity and persistence values selected during the write process. Again, the INTENSITY, PERSISTENCE, FOCUS, ERASE and POSITION controls do not affect the display.



Excessive intensity for long duration may damage the CRT storage mesh. The INTENSITY setting for any sweep speed should be minimum usable intensity.

3-15. NORMAL. Selection of this operating mode disables the variable persistence and storage features of the instrument. It will now function as a conventional, general purpose, oscilloscope. The PERSISTENCE control does not function in this mode. Always adjust INTENSITY in WRITE mode with minimum PERSISTENCE, then switch to NORMAL.

3-16. WRITE. Depressing the WRITE push button

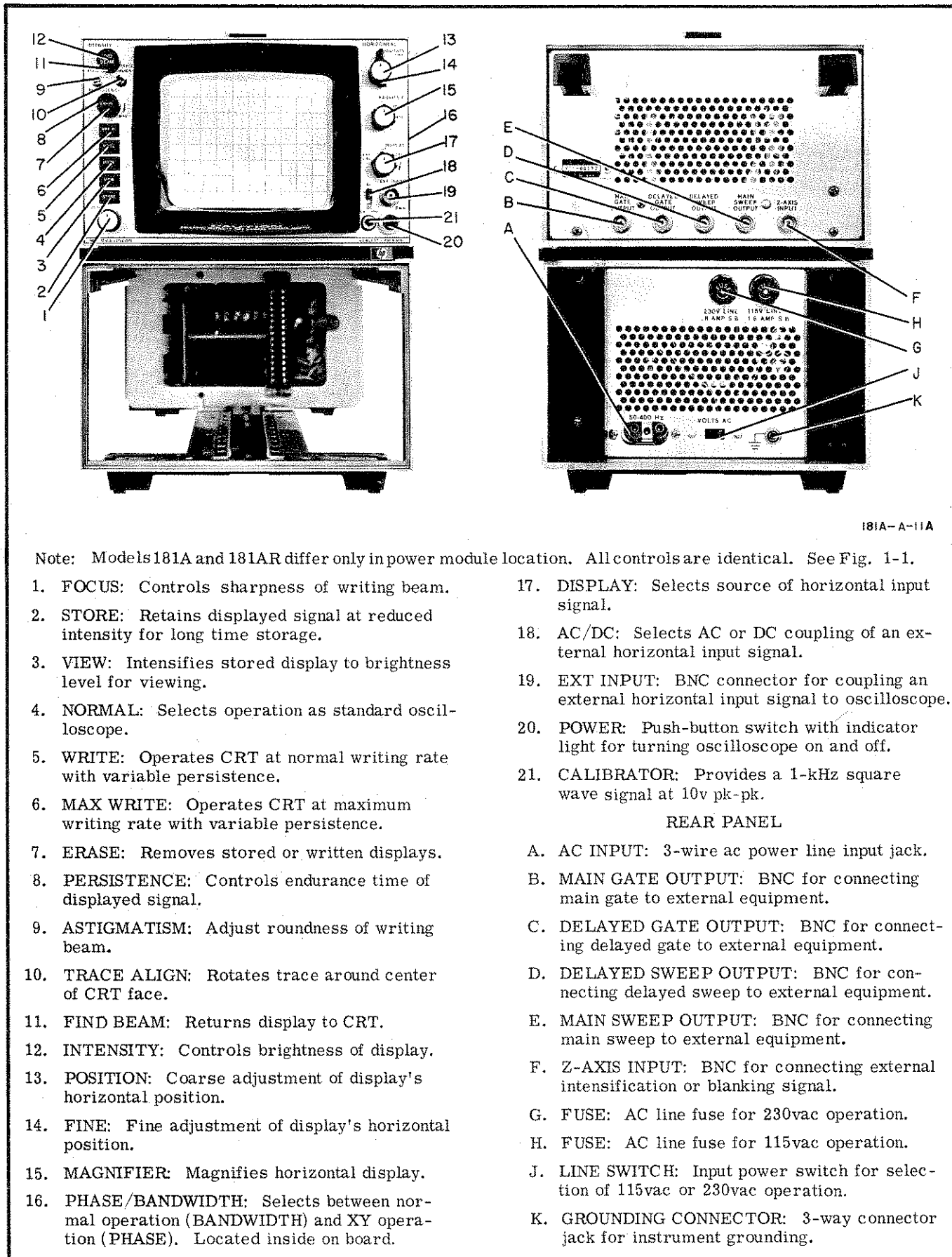

181A-A-11A

Note: Models 181A and 181AR differ only in power module location. All controls are identical. See Fig. 1-1.

- |   |   |
|---|---|
| <ol style="list-style-type: none"> <li>1. FOCUS: Controls sharpness of writing beam.</li> <li>2. STORE: Retains displayed signal at reduced intensity for long time storage.</li> <li>3. VIEW: Intensifies stored display to brightness level for viewing.</li> <li>4. NORMAL: Selects operation as standard oscilloscope.</li> <li>5. WRITE: Operates CRT at normal writing rate with variable persistence.</li> <li>6. MAX WRITE: Operates CRT at maximum writing rate with variable persistence.</li> <li>7. ERASE: Removes stored or written displays.</li> <li>8. PERSISTENCE: Controls endurance time of displayed signal.</li> <li>9. ASTIGMATISM: Adjust roundness of writing beam.</li> <li>10. TRACE ALIGN: Rotates trace around center of CRT face.</li> <li>11. FIND BEAM: Returns display to CRT.</li> <li>12. INTENSITY: Controls brightness of display.</li> <li>13. POSITION: Coarse adjustment of display's horizontal position.</li> <li>14. FINE: Fine adjustment of display's horizontal position.</li> <li>15. MAGNIFIER: Magnifies horizontal display.</li> <li>16. PHASE/BANDWIDTH: Selects between normal operation (BANDWIDTH) and XY operation (PHASE). Located inside on board.</li> </ol> | <ol style="list-style-type: none"> <li>17. DISPLAY: Selects source of horizontal input signal.</li> <li>18. AC/DC: Selects AC or DC coupling of an external horizontal input signal.</li> <li>19. EXT INPUT: BNC connector for coupling an external horizontal input signal to oscilloscope.</li> <li>20. POWER: Push-button switch with indicator light for turning oscilloscope on and off.</li> <li>21. CALIBRATOR: Provides a 1-kHz square wave signal at 10v pk-pk.</li> </ol> |
|---|---|

REAR PANEL

- |  |
|--|
| <ol style="list-style-type: none"> <li>A. AC INPUT: 3-wire ac power line input jack.</li> <li>B. MAIN GATE OUTPUT: BNC for connecting main gate to external equipment.</li> <li>C. DELAYED GATE OUTPUT: BNC for connecting delayed gate to external equipment.</li> <li>D. DELAYED SWEEP OUTPUT: BNC for connecting delayed sweep to external equipment.</li> <li>E. MAIN SWEEP OUTPUT: BNC for connecting main sweep to external equipment.</li> <li>F. Z-AXIS INPUT: BNC for connecting external intensification or blanking signal.</li> <li>G. FUSE: AC line fuse for 230vac operation.</li> <li>H. FUSE: AC line fuse for 115vac operation.</li> <li>J. LINE SWITCH: Input power switch for selection of 115vac or 230vac operation.</li> <li>K. GROUNDING CONNECTOR: 3-way connector jack for instrument grounding.</li> </ol> |
|--|

Figure 3-1. Front and Rear Panel Controls and Connectors.



establishes the CRT in a condition for variable persistence display of a signal which can later be stored. Use the minimum INTENSITY and maximum PERSISTENCE required to obtain the desired display.

3-17. MAX WRITE. Operation in the Max Write mode (MAX W.) provides a more rapid build-up and display of fast single-shot signals. Since the background illumination also increases more rapidly, the CRT contrast level and storage time are reduced.

3-18. ERASE. Depressing the ERASE push button will remove stored signals from the CRT when either the WRITE or MAX W push button is depressed. Stored or written displays that remain visible after erasure, may require the ERASE push-button be held depressed for approximately 30 seconds.

3-19. PERSISTENCE AND INTENSITY. These controls determine the viewing time of a signal being displayed. The INTENSITY sets the brightness of the trace as it is written. The PERSISTENCE control is used to establish the desired duration of signal viewing without rewriting. It accomplishes this by varying the rate at which the displayed signal is erased.

3-20. TRACE ALIGN. The TRACE ALIGN adjustment control compensates for external magnetic fields that may affect the alignment of the horizontal trace with the graticule. The alignment should be checked when the instrument is moved to a new location and the adjustment made whenever necessary.

3-21. FIND BEAM. Off-screen positioning of the CRT beam may occur due to initial improper control settings or a very high dc input signal. The beam may be brought back on screen by depressing the FIND BEAM push button. Adjust the horizontal and vertical position controls to center the beam (refer to the plug-in manuals). Adjust the INTENSITY control to obtain a visible trace.

3-22. MAGNIFIER. When the DISPLAY control is set to EXT CAL, the MAGNIFIER provides switched gain levels in the horizontal amplifier of X1, X5, or X10. In the X5 or X10 positions, the horizontal gain is increased to provide an amplified display of five or ten times, respectively. The insertion of a 1v signal into the EXT INPUT jack will result in a 1-division deflection in X1, 5-division in X5, and a 10-division deflection in the X10 position.

3-23. DISPLAY. This control determines the input signal to the horizontal amplifier. With the DISPLAY control set to EXT CAL, the external horizontal input signal is coupled directly to the horizontal amplifier. As the DISPLAY control is rotated counterclockwise, the external signal is increasingly attenuated. When the DISPLAY control is fully counterclockwise (INT), the external input signal is disconnected and the internal sweep is coupled directly to the horizontal amplifier.

3-24. CALIBRATOR. The 1kHz square-wave calibrator output signal of 10v can be used for vertical sensitivity calibration and for probe compensation adjustment. The CALIBRATOR output amplitude is accurate within  $\pm 1\%$ . Rise time of the square-wave output is less than  $3 \mu$  sec.

### 3-25. REAR PANEL.

3-26. OUTPUTS. Main and delayed sweep and gate signals are available at rear panel BNC connectors of the Model 181A/AR. These outputs are provided from separate isolation amplifiers which can supply 3 ma and will drive impedances as low as 1000 ohms without distortion. The plug-ins used in the Model 181A/AR and the control settings employed determine the output signals available.

3-27. Z-AXIS INPUT. An external signal can be utilized for control of CRT intensity. A rear-panel mounted BNC connector permits a direct connection to the CRT intensity gate amplifier. A signal of approximately +2v, dc to 15 MHz, is required to blank a beam of normal intensity. Input of a negative signal can be used for beam intensification.

3-28. AC LINE INPUT. A three-conductor ac input jack is provided for power input. Also located on the rear panel is the 115/230v slide switch and the required fuses for 115 vac and 230 vac operation.

### 3-29. INTERNAL.

3-30. PHASE/BANDWIDTH. The Model 181A/AR can also be used for phase measurements. Positioning the PHASE/BANDWIDTH switch to PHASE causes the horizontal input signal to be delayed the same amount of time as the vertical input signal.

#### NOTE

Make certain the control is returned to the Bandwidth position after making phase measurements.

### 3-31. PLUG-IN UNITS.

3-32. The Model 181A/AR Oscilloscope requires horizontal and vertical plug-ins. The deflection sensitivity of the CRT may vary slightly with different units. Plug-in units should be calibrated when first installed or when shifted between oscilloscopes. The horizontal and vertical plug-in units must be locked together prior to insertion into the Model 181A/AR main frame. Consult the respective plug-in Operating and Service Manual for operation and capability information.

### 3-33. MAGNETIC INTERFERENCE.

3-34. The CRT is provided with a mu-metal shield for protection against magnetic fields. Due to the sensitivity of the CRT, it is possible that the strong magnetic field from nearby motors, ac line transformers, etc., may still result in a noticeable beam deflection. In this event, reorient or relocate the instrument with respect to the interfering device.

### 3-35. OPERATING CONDITIONS.

#### 3-36. DEFINITIONS.

3-37. Several words and phrases, the definition of which may vary slightly from common usage, are used

to describe the operation of the Model 181A/AR. The definitions of these words and phrases which apply to the Model 181A/AR are as follows:

- a. **WRITE**-To transform an input signal into a visible display on the CRT screen.
- b. **PERSISTENCE**-The length of time a single sweep written display remains visible on the CRT screen (INTENSITY and sweep time constant).
- c. **STORE**-To retain, at reduced intensity, a display which has been written on the CRT.
- d. **VIEW**-To redisplay on the CRT screen, at normal intensity, a stored display.
- e. **ERASE**- To remove all displays, and blooms which have been stored, or written with persistence on the CRT.
- f. **INTENSITY**-The brightness of a display as it is written on the CRT screen ( PERSISTENCE and Sweep Time Constant).
- g. **BLOOM**-A visible, non-symmetrical expansion of a display written on the CRT screen.

h. **FADE POSITIVE**-Display obscured by slow blooming, see Figure 3-2A.

i. **BACKGROUND ILLUMINATION**-A green cloud of illumination visible on the CRT screen, see Figure 3-2B.

j. **SWEEP TIME**-The time (in seconds, milliseconds, or microseconds) required for the beam to move horizontally one unit of distance across the CRT screen, when writing a display.

### 3-38. CONTROL FUNCTIONS.

3-39. **PERSISTENCE AND INTENSITY**. These controls contribute to the duration of afterglow of a display. The **PERSISTENCE** control sets the rate at which a display is erased; **INTENSITY** sets the brightness of the trace as it is written. With a given **PERSISTENCE** setting, the actual duration of trace afterglow may be increased by increasing the **INTENSITY**. Since the **PERSISTENCE** control sets the rate of erasing a written display, it follows that a brighter trace will require more time to be erased. Conversely, a display of low intensity will disappear more rapidly. The same principle applies to a stored display of high and low intensity.

### CAUTION

The storage mesh of the CRT is not easily damaged, however, a high-intensity repetitive trace or spot, written on the screen for an extended time, may not erase completely. To prevent CRT damage, use minimum **INTENSITY** which will give the desired display for a given **PERSISTENCE** setting.

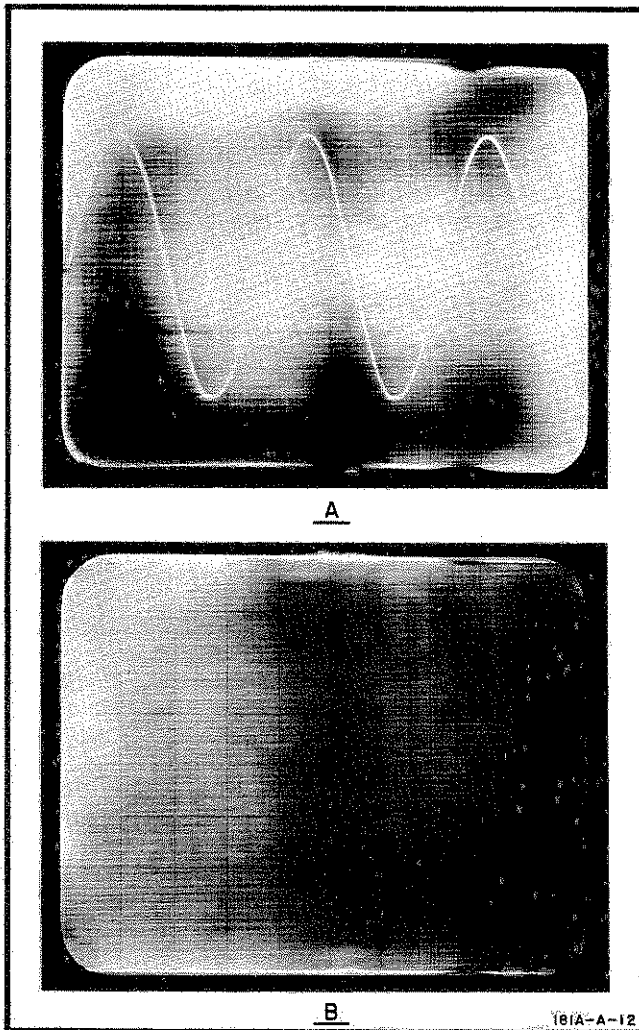

Figure 3-2. Fade Positive and Background Illumination.

3-40. **PRESENTATION SELECTION**. Push button controls select the mode in which the CRT functions. With **ERASE** push button depressed, the other three functions are disconnected and all stored and persisting displays are removed from the CRT. The **WRITE** and **MAX W.** modes are the only conditions in which a display may be written on the CRT screen. The **STORE** mode disconnects the **WRITE** and **ERASE** functions and retains written displays (at reduced intensity) on the CRT. **INTENSITY**, **PERSISTENCE**, and **ERASE** do not function in the **STORE** mode. The **VIEW** mode intensifies the stored display to a set brightness and again, **INTENSITY**, **PERSISTENCE**, and **ERASE** do not affect the display.

3-41. **MAX WRITE**. When **MAX W.** push button is depressed and then the **ERASE** push button is depressed and released, the storage surface is erased and then primed (or pre-fogged) to allow much faster writing on the storage surface. The display, however, has reduced contrast and fades positive more rapidly. The contrast and storage time are also reduced in this mode.

### 3-42. OPERATING TIPS.

3-43. This information is provided to aid the operator in becoming familiar with the Model 181A/AR controls and their functions, and to serve as a guide for obtaining the desired CRT display.

a. For normal persistence operation, depress **WRITE** push button and turn **PERSISTENCE** control

fully ccw. Slowly rotate INTENSITY control cw to a point where no trace blooming appears. Depress NORMAL push button; do not increase INTENSITY while in NORMAL. If sweep speed is changed, always check for proper intensity using the above procedure.



When not actively using the oscilloscope, switch to STORE or VIEW mode, thus turning off the write gun and eliminating the possibility of burning the storage mesh. When in WRITE, NORM, or MAX W mode, any visible trace may cause permanent damage to the CRT if display is left for prolonged periods of time. To prevent this from happening, periodically erase the display or switch to STORE mode if you wish to retain the image.

b. For variable persistence operation, press the WRITE push button. Use minimum INTENSITY and maximum PERSISTENCE compatible with display.

c. Use MAX WRITE mode only for fast sweep time, single shot display, or to improve the uniformity of trace intensity. The MAX W. mode causes more rapid positive fading on the CRT and persistence or storage time of the display is thus reduced.

d. To store a display, press the WRITE push button, adjust the INTENSITY and PERSISTENCE for the desired display, and press the STORE push button.

e. To view a stored display, press the VIEW push button.

f. To store more than one display, press the WRITE push button, set PERSISTENCE fully clockwise and INTENSITY as required; allow first display to be written on the CRT. Set INTENSITY fully counterclockwise and connect the second signal to be stored. Reset vertical POSITION if second display is not to be superimposed on first. Slowly rotate INTENSITY clockwise until second display appears. Press the STORE push button.

g. A display which is stored when the Model 181 A/AR power is turned off will remain stored for several days. To redisplay the stored waveform, press the STORE push button, turn POSITION controls fully ccw before turning power on. Apply power to Model 181A/AR and allow 5 minute warm-up. If stored sig-

nal was written in WRITE mode, depress WRITE push button. If stored in MAX W mode, depress MAX W push button. Depress VIEW push button to observe waveform.

h. To erase all persistent or stored displays, set mode to WRITE ( or Max Write ) and then the ERASE push button for approximately 2 seconds, then release.

i. If only a portion of a slow sweep display is desired, press the STORE push button when the trace has been written to the desired point; the write gun is blanked and the written portion is stored.

j. Use a viewing hood, if desired, to improve screen-display contrast.

### 3-44. SINGLE-SHOT OPERATION.

3-45. To write or store single-shot phenomena, a trial setting of INTENSITY is the best approach. The amplitude of the phenomena and the sweep-time required to display it will affect the persistence. For example, with maximum PERSISTENCE and some settings of INTENSITY, a single-shot straight-line may bloom. A single-shot signal with amplitude variations may not cause bloom. To determine the best INTENSITY setting, connect a signal which approximates the sweep time and amplitude of the single-shot signal to be written. Set PERSISTENCE fully clockwise and trigger a single sweep of the test signal. Set the INTENSITY as far as possible without causing blooming. Repeat this procedure, varying the INTENSITY, until the proper display is obtained. This setup should give maximum persistence to the single-shot display. After the signal has been written, press the STORE push button to retain the display.

3-46. Single-shot signals which require a sweep time faster than 20 microseconds per division can be written with more brightness by switching to the Max Write mode. The screen will be unevenly illuminated after erasing when in Max Write, Figure 3-2B; however, INTENSITY can be set high enough to make the display visible through the illumination. A display written in Max Write will be more rapidly obscured by positive fading than a signal written in NORMAL.

3-47. Single-shot signals which require a sweep time between 200 and 20 microseconds per division may have low brightness at the center of the screen. Fire a single-shot test signal with INTENSITY and PERSISTENCE fully clockwise and press the WRITE push button. If center screen brightness is low, wait for one to three minutes for the low brightness area to become brighter. Likewise, if the entire display brightness appears below a usable level, or the display is not visible at all, wait for one to five minutes for the display to appear.

## SECTION IV PRINCIPLES OF OPERATION

### 4-1. INTRODUCTION.

4-2. This section provides circuit theory analysis of the Model 181A/AR Oscilloscope. Since variable persistence and storage techniques may be somewhat unfamiliar to the reader, basic theory of operation will be explained first to aid in grasping these concepts. An over-all block diagram is explained next, followed by a detailed description of the individual circuits.

### 4-3. VAR PERSISTENCE & STORAGE.

#### 4-4. STORAGE PRINCIPLES.

4-5. The Model 181A/AR Storage CRT consists mainly of a conventional electron gun with deflection plates (write gun), an aluminized phosphor viewing screen, a pair of flood guns operated in parallel, flood beam shaping and accelerating grids, a flood beam collimator, a collector mesh, and a storage mesh as shown in Figure 4-1.

4-6. The write gun functions as a conventional electrostatic deflection gun, delivering high velocity electrons to selected points on the phosphor viewing screen. The elements which provide storage and variable persistence are located between the write gun and the phosphor.

4-7. The flood guns are physically located just outside the horizontal deflection plates. A cloud of electrons is emitted by each flood gun cathode. These clouds are combined, shaped, and accelerated by two control grids. It should be noted that under certain conditions the two electron clouds will appear as light areas on the viewing screen when the instrument is first turned on. The combined cloud is further shaped and accelerated by the collimator (a coating on the inside of the funnel section of the glass). The positive voltage on the collimator is adjusted so that the flood-gun electron cloud just fills the CRT viewing screen. The cloud is further accelerated toward the storage mesh and viewing screen by the collector mesh. After passing through the collector mesh, the flood electrons are further controlled by potentials on the storage mesh and surface.

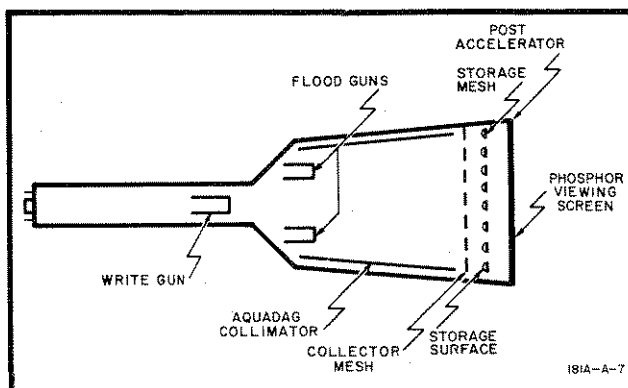

Figure 4-1. Simplified CRT Construction.

4-8. The storage mesh is located between the collector mesh and the phosphor. The back side of this mesh is coated with a layer of non-conductive material. The storage of information takes place on the surface of this non-conductive material (storage surface).

4-9. The basis for storage of information on the non-conductive material is the secondary emission ratio curve shown in Figure 4-2. This curve shows the ratio of the number of electrons leaving the surface to the energy of the electrons striking the surface. At an energy of about 40 electron/volts (ev) the number of electrons leaving the surface is equal to the number arriving. The point where the secondary emission ratio is equal to unity is called "first crossover." If the surface is bombarded with electrons with more than 40 ev of energy, the surface potential rises because more electrons are leaving than arriving. If the surface is bombarded with electrons with less than 40 ev of energy, the surface potential decreases because fewer electrons are leaving than arriving.

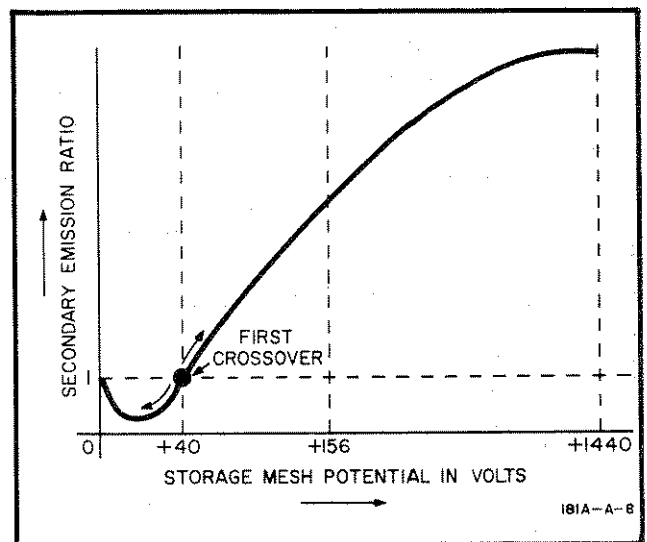

Figure 4-2. Secondary Emission Ratio.

4-10. When the ERASE push button is pressed, the storage mesh is changed to the same potential as the collector mesh (+156v). The storage surface is also changed to nearly this same potential by capacitive coupling. Since the surface is then being bombarded by electrons with energies much higher than first crossover energy, the entire storage potential becomes equal to +156 volts. The surface potential cannot increase beyond +156 volts because the collector mesh would then repel the emitted electrons back to the storage surface, tending to decrease the surface potential.

4-11. When the ERASE push button is released, (see Figure 4-3) the storage mesh is now changed to +3.3 volts and the storage surface follows to the same potential by capacitive coupling. The surface potential

then decays to zero volts by action of the flood gun electrons (surface below first crossover, brought to flood gun cathode potential). After 100 milliseconds, the storage mesh is raised to +13.3 volts and held there for 200 milliseconds. The storage surface follows to +10 volts by capacitive coupling, but immediately starts decaying toward zero volts by capturing flood gun electrons. At the end of the 200 milliseconds, the storage mesh is brought back to +3.3 volts. The storage surface is consequently reduced from zero volts to -10 volts by capacitive coupling.

4-12. Since the write gun electrons reach the storage surface with energy much higher than first crossover energy, they charge the surface in a positive direction wherever they strike. This charge pattern on the storage surface remains for a considerable length of time since the storage material is a very good insulator.

4-13. Those areas of the storage surface which are charged to near zero volts allow the field created by the high positive potential on the post accelerator to "reach through" and capture flood gun electrons, accelerating them to strike the phosphor viewing screen, thereby causing the phosphor to emit light. Thus the pattern of charge on the storage surface is made visible.

4-14. The secondary electrons emitted by the storage surface where the write gun electrons strike must charge the surface from its erased potential to about -5 volts before flood electrons can be captured by the

post accelerator. Thus the writing speed of the CRT could be enhanced by erasing the surface to just below this "cutoff" level. This is what the MAX WRITE mode does. The disadvantages of operating in this mode are reduced storage time and reduced contrast ratio. The "cutoff" potentials of various areas of the storage surface may not be exactly the same. Thus, the background illumination may not be uniform when the storage surface is erased in the MAX WRITE mode.

**4-15. VARIABLE PERSISTENCE.**

4-16. Figure 4-4 represents the method of obtaining variable persistence. The unwritten storage surface after erasure is at approximately -10 volts. Those areas of the storage surface which are struck by electrons from the write gun become charged to near zero volts. A +10 volt pulse applied to the storage mesh moves the unwritten areas of the storage surface to near zero volts and the written areas to near +10 volts. While at this potential, the written areas of the storage surface attract and capture flood gun electrons, which tends to lower the potential of these areas. When the storage mesh returns to its normal level, the storage surface drops 10 volts. The unwritten areas of the storage surface return to a -10 volt potential and the written areas return to a slightly negative potential, somewhat lower (more negative) than their initial value. This decrease in potential reduces the ability of the post accelerator potential to reach through and capture flood electrons, thus reducing the trace brightness slightly.

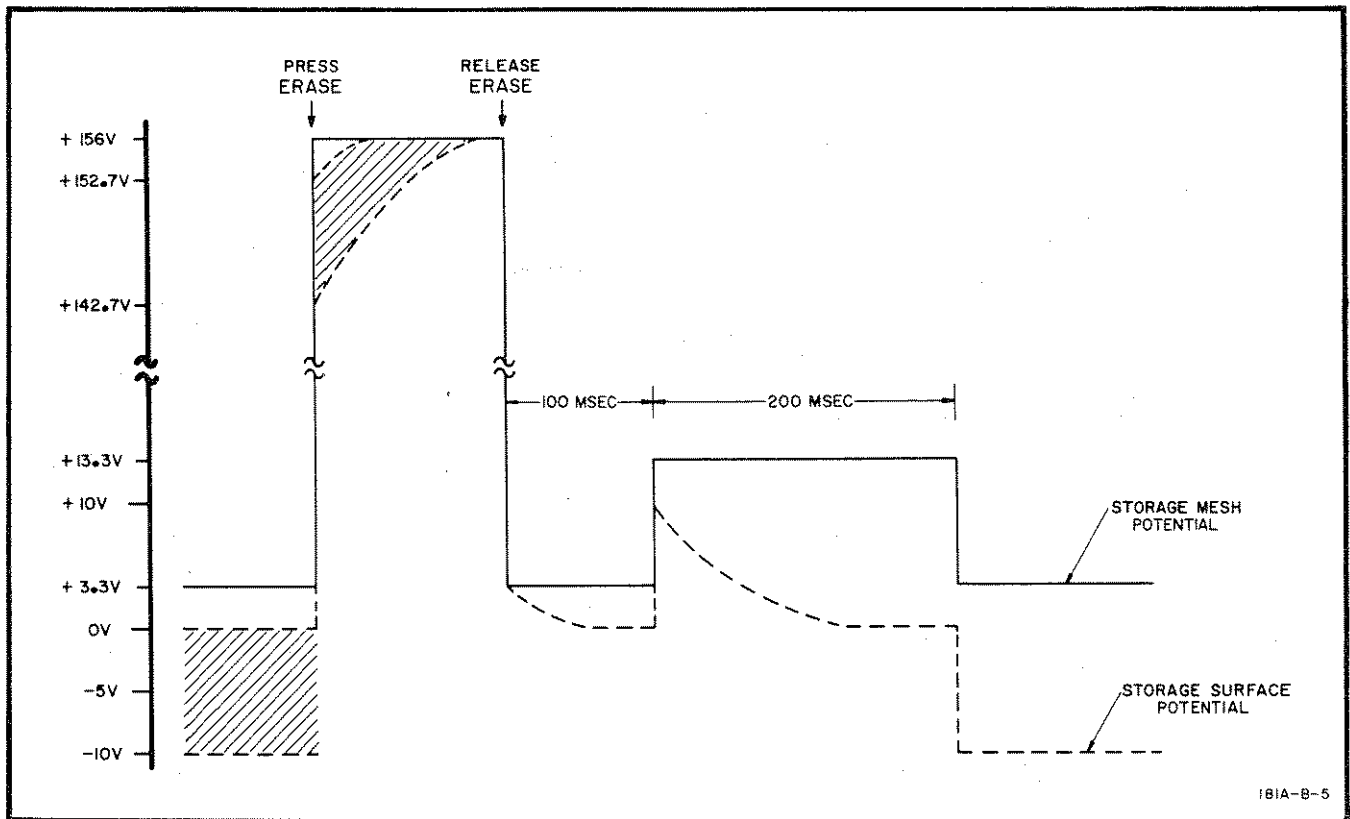

Figure 4-3. Storage Mesh and Surface Potentials During Erasure.

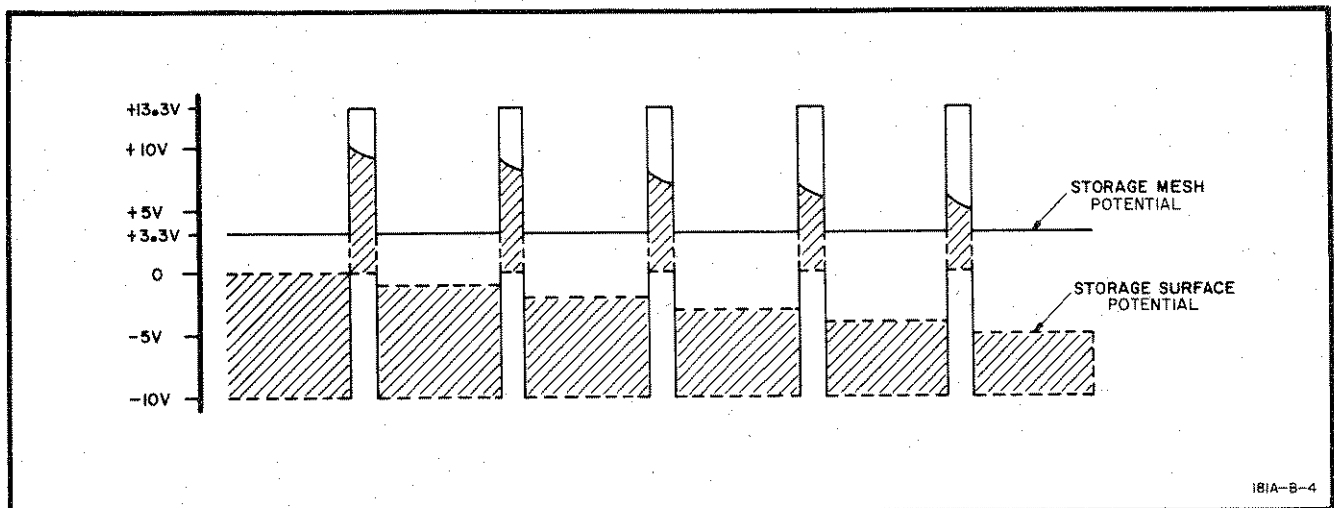

Figure 4-4. Variable Persistence Accomplishment Through Pulsed Erasure.

4-17. If this procedure is repeated many times, the stored trace will eventually be erased. The time required to accomplish this erasure is controlled by varying the duty cycle of the pulses applied to the storage mesh (or by varying the pulse width if the pulse repetition rate remains fixed).

4-18. During the time the storage mesh is pulsed positive, flood electrons are allowed through to the phosphor viewing screen. Thus a light background glow is visible when the CRT is used in the variable persistence mode.

#### 4-19. NORMAL.

4-20. If the storage mesh potential is reduced to -25 volts it acts as a control grid to flood gun electrons and prevents them from reaching the phosphor. However, it has little effect on write gun electrons, allowing many of them to reach the phosphor viewing screen. Some of the write gun electrons strike the storage surface, charging it positive toward zero volts wherever they strike. Thus the CRT appears to act as a conventional CRT without variable persistence or storage. However, when the storage mesh is brought back to +3.3 volts, those areas of the storage surface which have been struck by write gun electrons allow flood electrons to be captured by the post accelerator field, and thus display the pattern that was written on the phosphor while the storage mesh was at -25 volts.

4-21. In order to view a stored trace for one minute or more, the storage mesh is held at a constant +3.3 volts. This may be accomplished by reducing the width of the variable persistence erase pulses to zero (corresponding to maximum persistence), or by actually disconnecting the pulses from the storage mesh. The write gun may be turned off if desired, to prevent additional writing on the storage surface.

4-22. The mechanism which limits viewing time is the "fade positive" of the storage surface (entire screen illuminated). This is caused by positive ions reaching the storage surface and charging it positive. The positive ions are generated by flood gun electrons striking residual gas molecules in the CRT. To obtain an extended storage time, the flood guns should

be turned off. This is done in the STORE mode; however, the flood guns are turned on occasionally to permit viewing of the stored trace at a reduced intensity.

### 4-23. OVER-ALL DESCRIPTION.

#### 4-24. GENERAL.

4-25. The Model 181A/AR Oscilloscope consists of a low-voltage power supply, a calibrator, four external output isolation amplifiers, a high voltage power supply, a gate amplifier, a horizontal amplifier, and storage and variable persistence pulse circuitry. Figure 4-5 shows the functional relationship of these circuits. The instrument may be operated as a general purpose, a variable persistence, or a storage oscilloscope. Circuit operation in all three modes is described in this section.

4-26. Three input signals--intensity, horizontal deflection, and vertical deflection--are necessary to obtain a usable display on the CRT. The circuitry for the intensity and horizontal deflection signals is explained in the following paragraphs which are referenced to Figure 4-5. The vertical deflection signal is coupled to the CRT from the Vertical Plug-In.

#### 4-27. INTERNAL.

4-28. Horizontal deflection signals may be obtained from the Horizontal Plug-In by positioning the HORIZONTAL DISPLAY switch to INT. This applies -100 volts to the plug-in which produces an unblanking gate and generates an internal sweep signal.

4-29. The unblanking gate is coupled from the Horizontal Plug-In to the gate amplifier where it is summed with the Z-Axis Input, chopped blanking signals, and the unblanking signal from the storage pulse circuit. The resulting signal is amplified, coupled through the high voltage power supply, and applied to the CRT write gun grid to control the display intensity.

4-30. Each unblanking gate signal developed by the gate amplifier also generates an alternate trigger signal. This alternate trigger is directly coupled to the Vertical Plug-In. (The Operating and Service Manual for the Vertical Plug-In unit employed should be referred to for the signal function.)

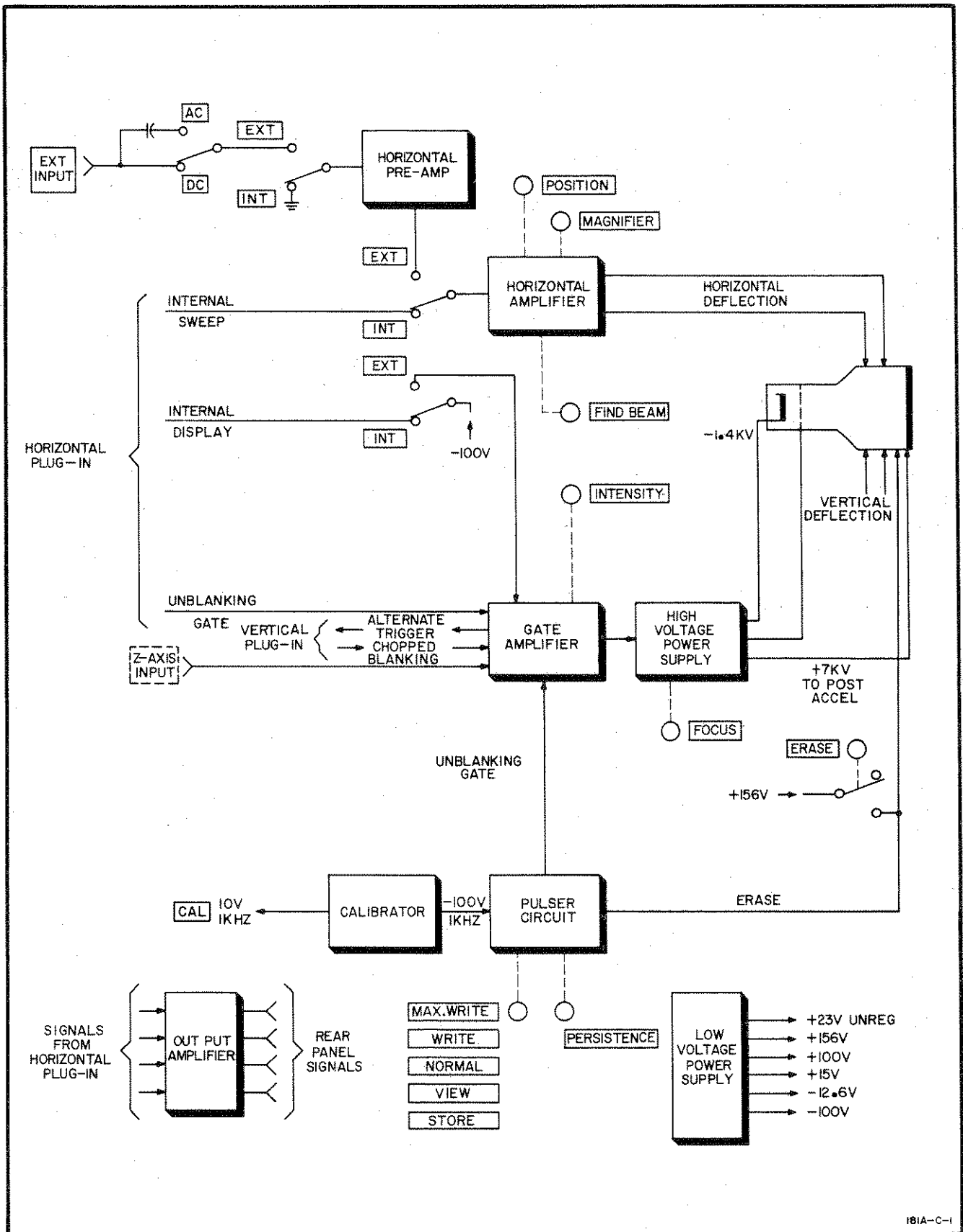

Figure 4-5. Overall Block Diagram

4-31. The internal sweep from the Horizontal Plug-In is coupled through the HORIZONTAL DISPLAY switch to the horizontal output amplifier. Here it is converted to a differential signal, amplified, and applied to the CRT horizontal deflection plates.

#### 4-32. EXTERNAL.

4-33. Positioning the HORIZONTAL DISPLAY switch to EXT removes the internal display voltage from the Horizontal Plug-In. The unblanking gate and the internal sweep are therefore not generated by the plug-in.

4-34. Gate amplifier operation (and thus CRT intensification) is determined by: an externally applied Z-Axis Input signal, the chopped blanking signal from the Vertical Plug-In, and an unblanking signal from the storage pulse circuit. When in EXT, the gate amplifier will produce an alternate trigger only if the external input signal is similar to the normal unblanking gate.

4-35. The externally applied horizontal deflection signal is preamplified, coupled to the output amplifier, converted to a differential output, and applied to the CRT horizontal deflection plates.

### 4-36. CIRCUIT DESCRIPTION.

4-37. The following paragraphs are a detailed description of the circuits and their functions in the Model 181 A/AR Oscilloscope.

#### 4-38. LOW VOLTAGE POWER SUPPLY (LVPS).

4-39. The low voltage power supply produces six dc voltages plus the CRT write and flood gun filament power. The -100, -12.6, +15, +100, and +156 volt supplies are regulated and used throughout the Model 181A/AR and the plug-in units. An unregulated +23v is produced for use by the High Voltage Power Supply (HVPS) and the pilot lamp. A regulated +105v is also produced for use only within the LVPS.

4-40. Figure 4-6 illustrates a basic regulated power supply. The series regulator and the parallel combination of the load and the sensing device divide the entire applied voltage. If the load changes, thus changing the voltage drop across the load, the sensing device will detect it and cause the resistance of the series regulator to change in the required manner to restore the output to the desired voltage level.

4-41. Refer to the schematic diagram of the LVPS, Figure 8-21. The closing of S5 supplies power to the primary of T1. The dual primary windings of T1 may be connected in series for 230v operation or in parallel for 115v operation. S6, located on the rear panel of the instrument, switches these windings for 115v or 230v operation.

4-42. The ac voltages developed by the secondary windings of T1 are bridge rectified, filtered, fused and applied to the regulating circuits. Decoupling RC and LC filter networks are employed for circuit isolation where required.

4-43. The -100v output is used as a reference for the other regulating circuits. It must be adjusted first since its output will affect all other regulated LVPS outputs.

4-44. -100 VOLT SUPPLY. A portion of the dc voltage from the -100v rectifier-filter circuit is dropped across A7R5 and series regulator Q4. The remainder is dropped across the voltage divider network A8R35, A8R36, and A8R37. If the -100v supply were to decrease in amplitude, a small portion of the positive-going change would be felt on the base of A8Q12. This change would be coupled through A8V2 and A8Q11 to the emitter of A8Q12. The difference between the inputs to A8Q12, a positive-going signal, is coupled through current amplifier, A8Q10, to the base of series regulator, Q4. Less voltage is dropped by Q4, and the -100v supply increases to normal. A8C8 and A8R29 prevent high frequency oscillation of the series regulator. A8CR8 and A8CR9 protect A8Q11 and A8Q12 respectively from reverse voltage breakdown in case the output voltage is shorted. A8CR10 acts to prevent reverse charging of A8C10 in the event F6 opens. A8CR12 protects A8Q10 and A8Q4 from reverse voltage breakdown during instrument turn-on.

4-45. +100 VOLT SUPPLY. Operation of the +100v supply is similar to the -100v supply except that the base of A8Q2 is held at a constant voltage by A8V1. Any variations in the output are felt only on the base of A8Q3 and inverted prior to coupling through A8Q1 to the series regulator Q1.

4-46. +105 VOLT SUPPLY. A filtered dc voltage from A7CR1-4 and A7C1 is applied across A7R2, A8R1 and breakdown diode A8VR1. Zener action keeps the top of A8VR1 five volts more positive than the bottom, which is at +100v. The +105v from A8VR1 is used to provide bias current for A8Q1 and A8Q3.

4-47. +156 VOLT SUPPLY. The rectified and filtered voltage from A7CR1-4 and A7C1 is applied across A7R1 and breakdown diode A7VR1. Zener action keeps the top of A7VR1 56.2 volts more positive than the bottom, which is at +100v. The 156 volt potential at A7VR1 is applied to the CRT collector mesh, and is also used for the ERASE function.

4-48. -12.6 VOLT SUPPLY. The voltage from the -12.6v rectifier filter is dropped across the series regulator Q3, A8R22, and the load. Any variation in output is coupled through voltage amplifier A8Q9 and current amplifier A8Q7 to the base of the series regulator Q3. A8C6 and A8R20 prevent high frequency oscillation of the regulator.

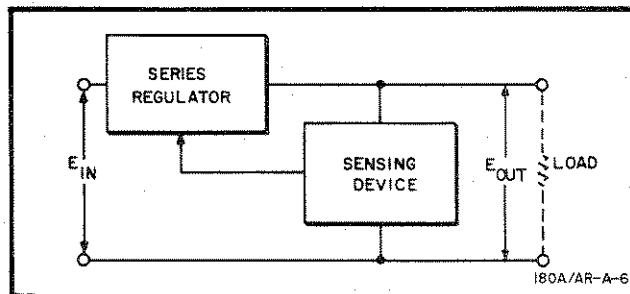

Figure 4-6. Basic Regulated Power Supply.



4-49. The current limiter, A8Q8, and A8R22 provide protection for the series regulator, Q3. If the output becomes shorted, the voltage drop across A8R22 turns on A8Q8. The negative signal from the collector of A8Q8 is coupled through the driver A8Q7 to the series regulator Q3, tending to turn it off. Output current is thus limited to only that required to keep A8Q8 conducting.

4-50. +15 VOLT SUPPLY. The +15 volt supply is similar to the -12.6v supply except that changes in the output are applied to the base of A8Q6 and inverted before being coupled through A8Q4 to the series regulator, A8Q2.

**4-51. PLUG-IN POWER.**

4-52. Table 4-1 lists the current available from each power supply for use by the vertical and horizontal plug-ins. Users desiring to design special purpose circuits should not exceed the capabilities shown in the table. There is no minimum current requirement for any supply.

Table 4-1. LVPS Current Capabilities

Power Supply	Maximum Safe Current Available
+100 VDC	160 ma
+15 VDC	420 ma
-12.6 VDC	725 ma
-100 VDC	80 ma

**4-53. CALIBRATOR.**

4-54. The calibrator circuit performs a dual function-- it provides a 1kHz output signal of 10v pk-pk, ±1% for calibration purposes, and a 1kHz, -100v signal for the storage pulse circuit (see Figure 8-15). A1Q6 and A1Q7 are used in a free-running multivibrator circuit. Diodes A1CR12 and A1CR14 provide voltage protection to the transistors. The collector of A1Q7 is discon-

nected from A1C15 by A1CR13 as A1Q7 turns off, providing a faster pulse rise-time. A1L2 and A1C16 isolate the multivibrator from the -100v supply, while A1R31 and A1C17 isolate it from the +15v supply. The 10v square wave output is applied to a front-panel connector for use in probe compensation and sensitivity calibration, and the -100v square wave output from the collector of A1Q6 is applied to the pulse circuit.

**4-55. OUTPUT ISOLATION AMPLIFIERS.**

4-56. Signals derived from the Horizontal Plug-In are coupled to rear panel BNC connectors J5-8 (refer to Figure 8-7). Four emitter followers, A2Q1-4, are employed as isolation amplifiers. The signals actually developed are determined by the Horizontal Plug-In used in the instrument; hence, the signals available can be determined by referring to the Operating and Service Manual for the applicable plug-in.

**4-57. HIGH VOLTAGE POWER SUPPLY (HVPS).**

4-58. Three regulated voltages are produced by the HVPS: -1440v, +7kv, and a control grid voltage of -1450v to -1500v (refer to Figure 4-7). A regulated oscillator is used to develop the required high voltages in transformer A5T1. The -1440v supply is sampled to provide control of the oscillator output and thus regulate all three voltages.

4-59. Unregulated +23v from the LVPS provides primary power to oscillator Q5 operating at approximately 35kHz (see Figure 8-18). The outputs from the high voltage transformer A5T1 are coupled to two-half wave rectifier/filter circuits and to a voltage tripler/filter circuit. CRT control grid voltage is rectified by A5CR1 and filtered. The write gun cathode voltage is rectified by A5CR2 while A5R2 establishes the dc potential applied to its control grid. Voltage regulators, A1V1 and A1V2, limit the maximum potential difference between the control grid and the cathode to 140v. The CRT focus voltage is obtained from the -1440 cathode voltage by a voltage divider network of which R5, the FOCUS control, is a part. Resistor,

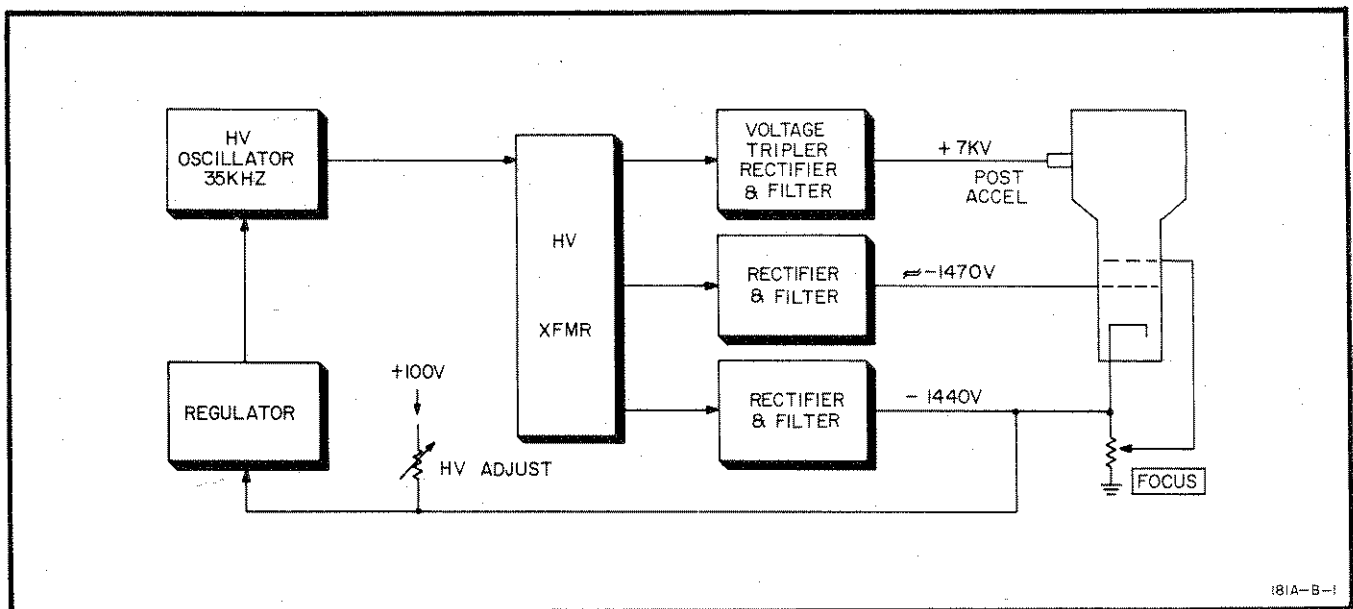

Figure 4-7. HVPS Block Diagram.

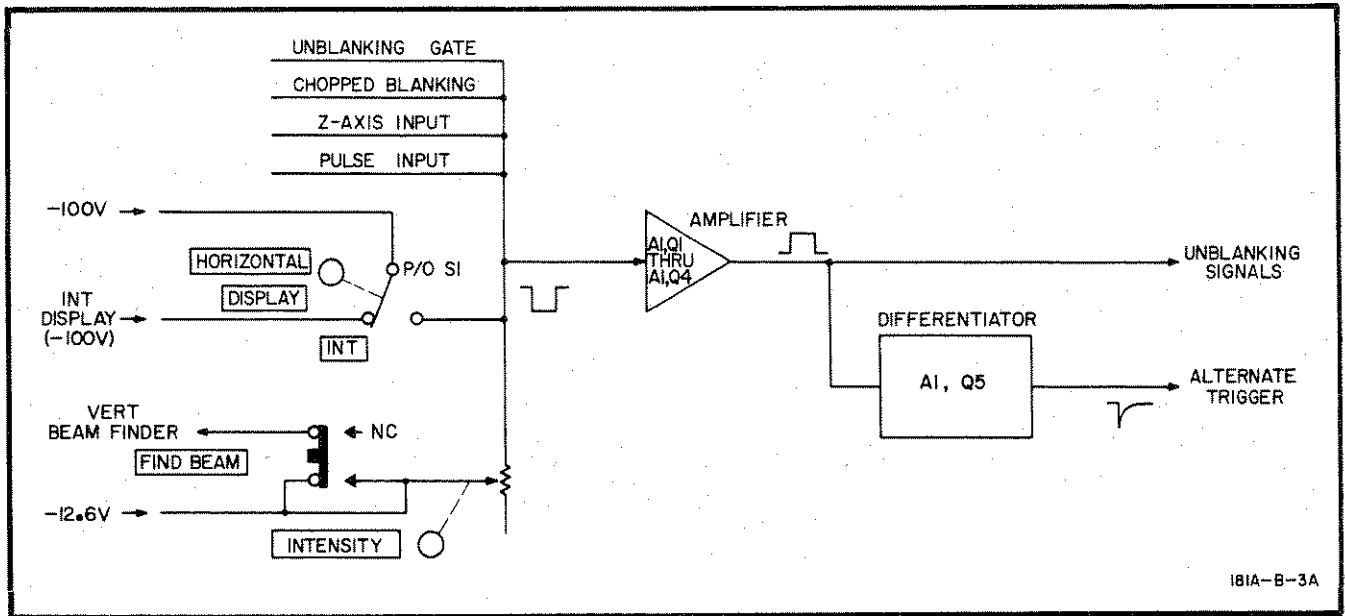

Figure 4-8. Gate Amplifier Block Diagram.

R6, maintains the write gun filament at cathode potential. The voltage tripler circuit of A9CR1-3 and A9C1-4 is contained on Assembly A9, the output of which (+7 kv) is applied to the CRT post-accelerator anode.

4-60. Changes in output of the -1440vdc supply are detected by the regulator A1Q8-A1Q10 to change the operating voltage of oscillator Q5. Assume that the -1440 supply voltage decreases (goes positive). A positive-going signal is applied through the regulator to the base of Q5, causing it to conduct for a greater portion of the input cycle. The oscillation amplitude is therefore varied so as to oppose the original change in output voltage. This causes a voltage change to appear on the primary of A5T1 and increases the voltage of the secondary. The steady state value of the CRT cathode voltage is established by A1R38, the High Voltage Adjust, by setting the normal dc value on the base of the A1Q8. Inductor A4L1 suppresses any possible high frequency parasitic oscillation.

#### 4-61. GATE AMPLIFIER.

4-62. The inputs to the gate amplifier (refer to Figure 4-8) are the unblanking gate, the chopped blanking, the Z-AXIS INPUT, and the storage pulse circuit signals. These four signals may be present either singly or simultaneously, depending upon control settings. They are summed with a current established by three front panel controls--FIND BEAM, INTENSITY, and HORIZONTAL DISPLAY. Depressing FIND BEAM shunts the normally adjustable INTENSITY control and supplies maximum current from this source. Setting HORIZONTAL DISPLAY to EXT SENS or EXT CAL supplies additional current to brighten the beam.

4-63. The gate amplifier, A1Q1-A1Q4, senses the input signal current, converts it to a voltage, amplifies it, and couples it to the control grid of the CRT write gun. And in addition, the output signal is also differentiated, clipped, and coupled to the Vertical Plug-In for use as a trigger signal if desired.

4-64. The input currents to the gate amplifier (refer to Figure 8-7) are summed in the low impedance emitter circuit of A1Q1. The resulting current is coupled to the complementary feedback amplifier (a current fed operational amplifier), A1Q2-A1Q4, where it is converted to a voltage and coupled to the control grid of the CRT write gun. The large negative feedback from the collectors of A1Q3 and A1Q4 to the base of A1Q2 provides the complementary feedback amplifier with a very stable gain. Trimmer capacitors, A1C8 and A1C9, adjust the high frequency feedback. Diode A1CR6 provides temperature compensation for A1Q3, while A1CR7 and A1CR8 protect A1Q3 and A1Q4 from voltage breakdown. Diode, A1CR10 and A1R57, isolate A1Q3 and A1Q4 from the high voltage in the control grid circuit of the CRT write gun in the event of a grid or cathode short to ground. The output from A1Q3 and A1Q4 is differentiated by A1C13, A1R22 and A1R23, and coupled through A1Q5 and the positive clipper, A1CR11, to the Vertical Plug-In for alternate triggering purposes.

#### 4-65. HORIZONTAL AMPLIFIER.

4-66. The block diagram, Figure 4-9, illustrates the major circuit functions. The horizontal amplifier can be driven by either an internally derived signal or by an external signal applied to the HORIZONTAL EXT INPUT front panel BNC jack. Positioning the HORIZONTAL DISPLAY control to INT disconnects the external signal input and grounds the horizontal preamplifier input. The Internal Sweep signal is connected through the HORIZONTAL DISPLAY switch to the horizontal output amplifier.

4-67. The EXT INPUT BNC, J4, is connected to the input of the preamplifier when either EXT SENS or EXT CAL is selected; the preamplifier, in turn, is coupled to the output amplifier. Selections of EXT SENS permits varying the amplitude of the preamplifier output by adjustment of the HORIZONTAL DISPLAY con-

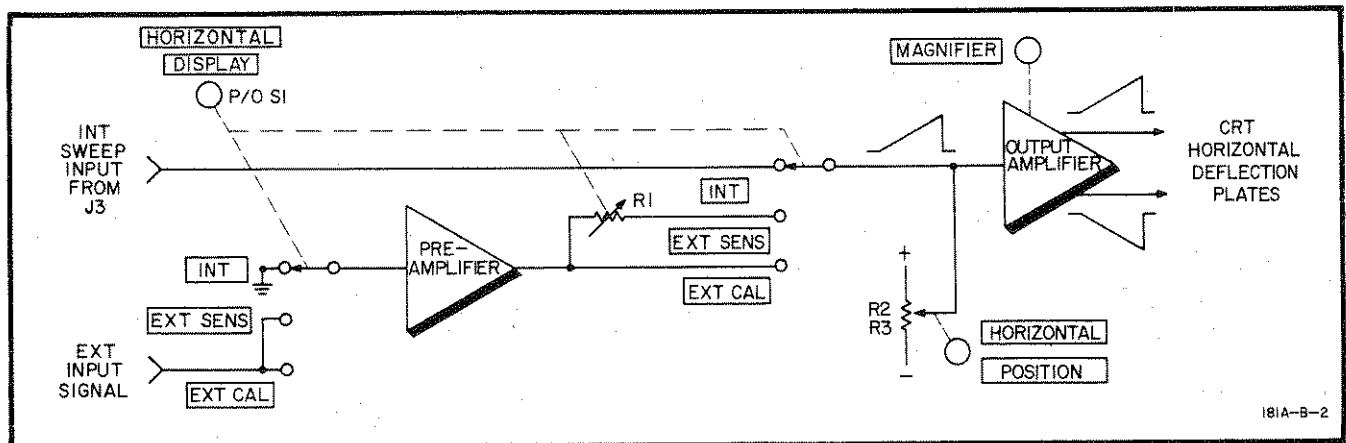

Figure 4-9. Horizontal Amplifier Block Diagram.

trol. When EXT CAL is selected, this control, R1, is shorted; the output amplitude, therefore, is determined by the amplitude of the input signal.

4-68. The signal selected is fed into the output amplifier where it is summed with a current established by the HORIZONTAL POSITION controls. The resultant current is converted to a differential signal, amplified, and applied to the CRT horizontal deflection plates.

4-69. External input signals are preamplified by A3Q1 and A3Q2 (refer to Figure 8-10). The high input impedance of A3Q1 minimizes loading of the external input source. Diode A3CR1 protects A3Q1 from high level inputs. A3Q2 has a low output impedance suitable for driving A3Q3. The BANDWIDTH/PHASE Switch, A3S1, would be positioned in PHASE when accurate X-Y measurement is desired. In the PHASE position, A3C2 and A3C3 are switched in, decreasing the preamplifier bandwidth. The total horizontal amplifier signal delay is therefore made equal to signal delay in the Vertical Plug-In. The vernier balance, A3R7, is adjusted so that 0 vdc appears across the HORIZONTAL DISPLAY control, thus eliminating any horizontal dc shift as the control is operated.

4-70. Input signals to A3Q3 are summed in the low impedance emitter circuit with a current established by the setting of the POSITION controls A3R2 and A3R3. A3Q6 is driven by the low impedance of emitter follower A3Q4. The input signal to A3Q6 is coupled through the MAGNIFIER switch, S4, to the complementary driver A3Q7. S4 provides for selection of incremental gain levels by selecting the amount of emitter degeneration employed with A3Q6 and A3Q7. Increasing degeneration decreases gain. Adjustment A3R30 along with A3R31 controls the gain when in the X10 position, A3R32/A3R33 control the X5 gain, and A3R34/A3R35 determine the X1 horizontal gain. The dc balance of A3Q6 and A3Q7 is adjusted by A3R37 which controls the emitter potentials. Transistor A3Q5 provides a low impedance voltage source for the base of A3Q7. The differential signal at the collectors of A3Q6 and A3Q7 is applied to the complementary feedback amplifiers (current-fed amplifiers), A3Q8-Q10 and A3Q11-Q13, converted to a voltage, and coupled to the horizontal deflection plates of the CRT. A3CR3 prevents A3Q6 from saturating, while A3CR6 serves the same purpose for A3Q7. Diodes A3CR2/CR4 and

A3CR7/CR8 limit the amplifier output to the CRT deflection plates to within +6v and +94v regardless of the amplitude of the input signal.

4-71. Depressing FIND BEAM switch S3 disables limiter A3CR7/CR8 and blocks the input signal to A3Q11. The differential gain is effectively reduced by half and the electron beam is confined to the horizontal limits of the CRT screen.

4-72. The gain of the complementary feedback amplifier is made very stable by coupling a generous amount of negative feedback from the collectors of A3Q9/Q10 to the base of A3Q8, and from the collectors of A3Q12/Q13 to the base of A3Q11. The high frequency feedback of each amplifier is adjusted by A3C6 or A3C19 individually, while A3C9 adjusts the feedback for both. Diodes A3CR5 and A3CR9 provide temperature compensation for A3Q10 and A3Q13.

#### 4-73. PULSE CIRCUIT.

4-74. Pulses of adjustable level and width are used to control the variable persistence and storage capability of the Model 181A/AR Oscilloscope. They are applied to the CRT storage mesh when operating in the WRITE and MAX WRITE modes, applied to the flood gun accelerator in the STORE mode, and used to key the gate amplifier for CRT unblinking.

4-75. VARIABLE PERSISTENCE. The multivibrator circuit, (Figure 8-17), is the source of a 1 kHz square wave signal. This signal, in turn, is applied to the pulse circuit which modifies the width and level of the pulse. A -100v square wave is obtained from the junction of A1C14 and A1R28 and fed to the base of A6Q3 through A6R8. Inverted and level-shifted by A6Q3, the resultant +15v square wave at the collector of A6Q3 is applied through A6C2 and differentiated by A6R13/A6C2. Applied to the base of A6Q4 through A6CR3, the amplitude of the pulse at the anode of A6CR3 is established by the ratio of A6R12 and the PERSISTENCE control setting, R9. As a result of the charging time constant of A6C2/A6R13, the variable amplitude signal is felt as a variation in width (i. e. duration) at the base of A6Q4. By varying the conduction time of A6Q4, the time required to erase a trace has been controlled. In other words, varying the erase time is essentially the same as varying the display time, and this, in turn, is known as variable persistence.

4-76. **NORMAL.** Selection of this mode permits the Model 181A/AR to be employed as a conventional oscilloscope. With **NORMAL** activated, the junction of A6R16/A6R19 is grounded and the storage mesh falls to -25v. Because of this negative potential, the variable persistence and storage capabilities are therefore disabled.

4-77. **WRITE** and **MAX WRITE.** Operating in these modes allows normal viewing of the display and prepares it for storing. **MAX WRITE** is used only when necessary, such as in viewing fast single-shot signals.

4-78. To obtain display uniformity in the **MAX WRITE** mode, the CRT collimator voltage should be readjusted in this mode. To do so, a multivibrator consisting of A6Q16 and A6Q17 is used.

4-79. When the **MAX W.** push button is depressed, one side of the multivibrator conducts. Current flow through A6R47 and A6R46 holds A6Q16 on and A6Q17 off. Thus, the **MAX WRITE ADJ** pot A6R17 is paralleled with **WRITE ADJ.** At the same time, A6R9 is disabled and **MAX WRITE COLLIMATION ADJ** (A6R29) is enabled. The multivibrator is necessary so that proper collimation voltage is retained when the **VIEW** or **STORE** mode is selected.

4-80. The setting of the **WRITE** adjust, A6R18, adjusts the positive pulse level at the collector of A6Q4 when operating in the **WRITE** mode, while A6R18 in parallel with the **MAX WRITE** adjust, A6R17, adjusts the level in the **MAX WRITE** mode. Pulse level control of the 1 kHz pulses to the storage mesh affords depth of erasure control which directly affects writing rate. In other words, the more negative the storage surface becomes, the longer it will take it to build up to a level high enough to store a trace (refer to Figure 4-4).

4-81. **STORE.** When the **STORE** function is selected, the base of A6Q1 is grounded, turning it off. This allows the current flow through A6R2 and A6CR1 to turn A6Q2 on. Meanwhile, the +15v square wave signal at the collector of A6Q3 is differentiated by A6C1/A6R2 and applied to the base of A6Q2 through A6CR1. Thus A6Q2 has a negative voltage developed at its base during the charging time of A6C1 which turns it off. The time constant of A6C1/A6R2 is such that A6Q2 is off for about 50 microseconds each millisecond, and only during this short interval will a positive potential be applied to the flood gun accelerator grid.

4-82. While A6Q2 is on, the flood gun accelerator voltage is established by voltage divider network, A6R5/A6R6, at -9v. With A6Q2 switched off by the differentiated 1 kHz pulse, the accelerator voltage is +43v set by the divider network A6R4, and A6R6.

4-83. With the accelerator grid held at -9v, the flood gun electrons are repelled. Thus, when in the **STORE** mode, the flood guns are always on, but electrons are attracted to the storage mesh only when the accelerator grid is at a positive potential, about 5% of the time. This reduces the display brightness and provides for greatly increased storage time.

4-84. **VIEW.** Depressing the **VIEW** push button allows viewing a previously stored display at a brightness level determined by the intensity and persistence settings during the writing process. At least one minute

of aggregate viewing is available without trace degradation.

4-85. When in **VIEW**, **NORMAL**, **WRITE** or **MAX WRITE** mode of operation, A6Q1 is turned on by the current flow through A6R1 to its base. This effectively grounds the base of A6Q2, holding it off and keeping the flood gun accelerator potential at +43v.

4-86. The flood gun grid level is set to provide an optimum flood gun electron distribution at the storage mesh. This is adjustable and is determined by the setting of A6R42, which is in series with A6R7 and the -100v supply. Stray ac signals on the flood gun grid lead are decoupled from the flood gun by A6C4.

4-87. **ERASE.** The push button operating mode selector switch does not permit energizing the erase circuitry unless the **WRITE** or **MAX WRITE** mode of operation has been selected. Activation of the **ERASE** switch S7 (refer to Figure 8-12) in either of these modes applies +156v to the CRT storage mesh and to the junction of A6R36 and A6CR6. The diode A6CR6 prevents application of this +156v to the collector of A6Q4 during **ERASE**, while A6CR4 prevents the collector from rising above +15v because of the +100v applied through the voltage divider formed by A6R15, A6CR5, A6R16 and A6R19. Normally nonconducting, A6Q13 is turned on by application of the +156v which in turn shuts off A6Q12. This permits A6C6 to charge positive through A6R33 and A6R37 to about +4.7v. The resultant current through A6R37 causes A6Q14 to conduct and A6Q15 to cease conduction. Current flowing through A6R43, A1CR15, A1R10 and into the emitter of A1Q1 causes the Gate Amplifier to operate so as to blank the CRT write gun. A clean erasure of the storage mesh is thereby assured since nonwriting of an input signal can take place during erasure.

4-88. Releasing the **ERASE** switch removes the +156v from the CRT storage mesh and from A6R36. Current no longer flows through the base of A6Q13 and conduction ceases. This permits A6Q12 to conduct due to the current flow through A6R34 into its base. The resulting 4.7v negative step at the collector of A6Q12 is differentiated by A6C6/A6R32 and applied to the base of A6Q11, causing it to cease conduction. As a result of the charging time constant of A6R32 and A6C6, A6Q11 will remain in a nonconducting state for approximately 100 milliseconds. During this time, A6C5 is being charged to +4.7v through A6R31, A6R38, and A6R27. Current flow through A6R38 and A6CR7 causes the Blanking Control Amplifier A6Q14/A6Q15 and the Gate Amplifier to operate and blank the CRT write gun.

4-89. Control of the voltage applied to the CRT collimator is desired during storage mesh erasure. A portion of the current through A6R31 also flows through A6R27, placing A6Q8 in a conducting state, and causing A6Q9 to cease conduction. The voltage on the base of A6Q10, therefore, rises to nearly +120v, causing heavy conduction through A6Q10. This results in its emitter rising to about +120v due to the voltage drop across A6R30. Since the collimator is connected to the emitter of A6Q10, the +120v developed across A6R30 is applied to the collimator while erasing. This ensures a more uniform erasure of the storage mesh, particularly of the periphery of the display area.

4-90. At the end of the 100 millisecond initial erasing period, A1Q11 again starts conducting. The resulting 4.7v negative step at the collector of A6Q11 is differentiated by A6R26/A6C5 and applied to the base of A6Q7, turning it off. A6Q7 will be nonconducting for approximately 200 milliseconds, while A6Q7 is off. The current flow through A6R25, A6R39, and A6Q14 causes the CRT write gun to remain blanked. Also, the current flow through A6R24 into the base of A6Q6 drives it into conduction, effectively grounding the base of A6Q4. With A6Q4 in an off condition for the 200 millisecond period, the CRT storage mesh rises to about +13.3v when operating in the WRITE mode, and to about +7.5v in the MAX WRITE mode.

4-91. When the 200 millisecond interval is terminated, A6Q7 again conducts and turns off A6Q6. This allows current to flow through A6R13, A6CR3 and the base of A6Q4, turning it on, and reducing the storage mesh to the +3.3v level. Variable-width erase pulses are again applied to the storage mesh at the 1 kHz rate.

4-92. It is desirable to provide for inhibiting the CRT WRITE function for a short interval after erasing. The

discharging time constant of A1C6/A1R10 through A1Q1 accomplishes this, and keeps the write gun turned off momentarily.

4-93. STORAGE PROTECTION. It is possible to manipulate the operating mode selector switch so that multiple functions or no function at all may be selected. This switch is interconnected to provide several operational features which protect the stored display from inadvertent erasure of overwriting. For instance, if no function is selected, the CRT write gun is blanked and the PERSISTENCE control is inoperative.

4-94. The write gun blanking is provided by current flow through A6R22 and A6R40 into the base of A6Q14, thus causing the Gate Amplifier to turn off the write gun.

4-95. The disabling of the PERSISTENCE control is obtained by utilizing the current flowing through A6R22 and A6R23 into the base of A6Q4. This holds A6Q4 in conduction and keeps the storage mesh at +3.3v. Current flowing into the base of A6Q4 prevents the variable amplitude 1 kHz pulse from turning off A6Q4.

Table 5-1. Required Test Equipment

Recommended Type	Test Equipment Model	Required Characteristics
Voltmeter Calibrator	hp Model 738AR or 6920B	1, 2, 10v pk-pk $\pm 0.2\%$
Test Oscilloscope	hp Model 180A/AR w/1801A & 1820A	Sensitivity 1v/div Sweep Speed 1 $\mu$ sec Risetime 3 $\mu$ sec Sweep output
10:1 Divider Probe	hp Model 10001A	$\pm 3\%$
Constant Amplitude Signal Generator	Tektronix Type 190B	50 kHz-50 MHz at 10v pk-pk
Digital Voltmeter	hp Model 3440A w/3444A	$\pm 100$ vdc $\pm 0.5\%$ 2.5 ma $\pm 2\%$
100:1 Divider Probe	hp Model 11044A	300vdc
Square Wave Generator	hp Model 211A/B	200 kHz 1v pk-pk Risetime 30 $\mu$ sec
Current Source		2.5 ma $\pm .3\%$
Oscillator	hp Model 200CD	10 kHz 10v pk-pk

## Free Manuals Download Website

<http://myh66.com>

<http://usermanuals.us>

<http://www.somanuals.com>

<http://www.4manuals.cc>

<http://www.manual-lib.com>

<http://www.404manual.com>

<http://www.luxmanual.com>

<http://aubethermostatmanual.com>

Golf course search by state

<http://golfingnear.com>

Email search by domain

<http://emailbydomain.com>

Auto manuals search

<http://auto.somanuals.com>

TV manuals search

<http://tv.somanuals.com>