

Valuetronics International, Inc.
1-800-552-8258
MASTER COPY

Getting Started Guide

HP 54501A, HP 54502A and HP 54503A

Digitizing Oscilloscopes



©Copyright Hewlett-Packard Company 1989

Publication 5958-0351

Printed in the U.S.A. April 1989

Table of Contents

About this book ...

Chapter 1: **Introduction**

Chapter 2:

| | |
|-----|--------------------------|
| | Layout and Setup |
| 2-1 | Front Panel Layout |
| 2-2 | Rear Panel Layout |
| 2-3 | Start Up |
| 2-3 | Connecting Power |
| 2-3 | Applying Power |
| 2-4 | Resetting the Instrument |

Chapter 3:

| | |
|-----|----------------------|
| | Instant Setup |
| 3-2 | Autoscale |
| 3-3 | Vertical Setup |
| 3-5 | Timebase Setup |
| 3-7 | Trigger Setup |

Chapter 4:

| | |
|-----|--------------------------------------|
| | Making Automatic Measurements |
| 4-2 | Making the Measurements |
| 4-5 | Clearing the Measurements |
| 4-5 | Measuring Other Sources |

**HP 54501A, HP 54502A and HP 54503A
Getting Started Guide**

Chapter 5:

- Making Manual Measurements**
5-2 Making Voltage Measurements
5-6 What are Time Interval Measurements?
5-6 Measuring a Waveform Period
-

Chapter 6:

- Storing Setups and Waveforms**
6-2 Storing Front-Panel Set Ups
6-3 Storing a Waveform
-

Chapter 7:

- Making a Hardcopy Output**
7-2 Setting Up the HP-IB
7-3 Hardcopy Output
-

Chapter 8:

- Dual Timebase Windowing**
8-2 Using the Window
8-4 Making Measurements in the Window

HP 54501A, HP 54502A and HP 54503A
Getting Started Guide

Introduction

1

The HP 54501A, HP 54502A, and HP 54503A are affordable general purpose digitizing oscilloscopes. These oscilloscopes are portable and completely HP-IB programmable.

All three digitizing oscilloscopes have the following features:

- Ability to view signal events prior to trigger
- Instant Hardcopy Output
- Autoscale for Automatic Setup
- Full HP-IB Programmability
- Automatic Measurements with User Defined and Statistics
- Measurement Limit Test
- Waveform Math (+, -, X, vs, invert, only)
- 4 Nonvolatile Set-up Memories
- 4 Nonvolatile Waveform Memories
- 2 Volatile Pixel Memories
- Dual Timebase Windowing
- Advance Logic Triggering
- TV Triggering

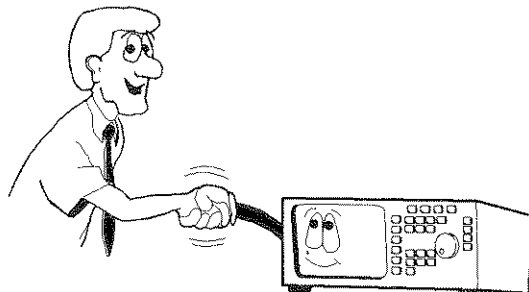

HP 54501A, HP 54502A and HP 54503A
Getting Started Guide

Introduction
1-1

Each model has separate features that make it different from the other two models.

The HP 54501A features:

- Repetitive Bandwidth - dc to 100 MHz
- Single Shot Bandwidth - dc to 1 MHz
- Maximum Vertical Sensitivity - 5 mV/div
- Sample Rate - 10 MSa/s
- Number of Channels - 2 + 2
- Memory Depth - 1K/channel

The HP 54502A features:

- Repetitive Bandwidth - dc to 400 MHz
- Single Shot (Realtime) Bandwidth - dc to 100 MHz
- Maximum Vertical Sensitivity - 2mV/div
- Maximum Sample Rate - 400 MSa/s
- Number of Channels - 2
- Memory Depth - 2K/channel
- External Trigger - 1 channel

The HP 54503A features:

- Repetitive Bandwidth - 500 MHz
- Single Shot Bandwidth - dc to 2 MHz
- Maximum Vertical Sensitivity 1 mV/div
- Maximum Sample Rate - 20 MSa/s
- Number of Channels - 4
- Memory Depth 1K/channel

Complete specifications and characteristics are listed in appendix A of the *Front-Panel Reference* for each oscilloscope model.

Front Panel Layout

The oscilloscope front panel is organized into six functional areas. Typical front panel operation consists of these three main steps.

- select a menu (MENU Select),
- select a function (Function keys),
- enter numeric value (Entry Devices).

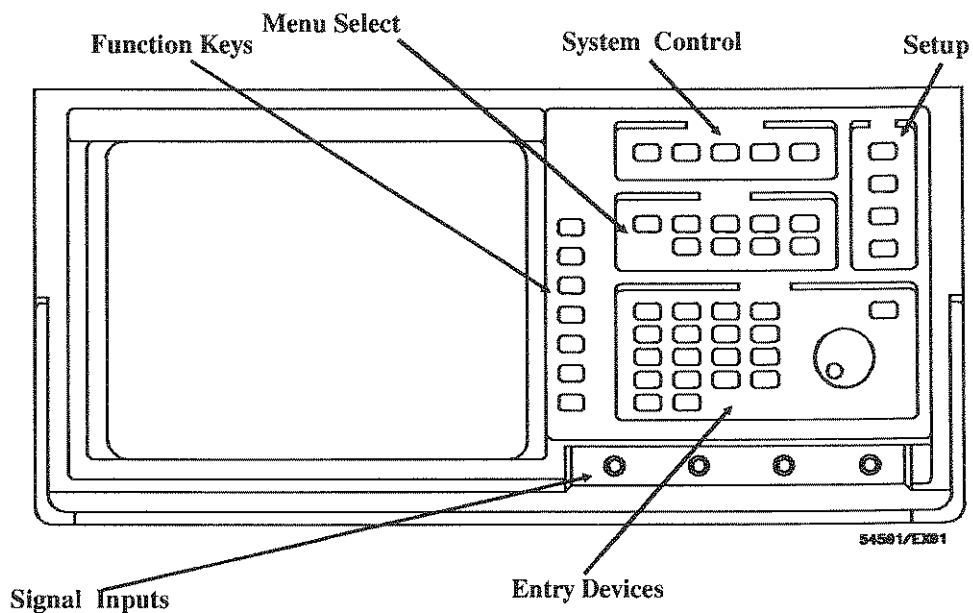

Rear Panel Layout

The rear panel of the instrument contains the power input, voltage selector module, and power switch.

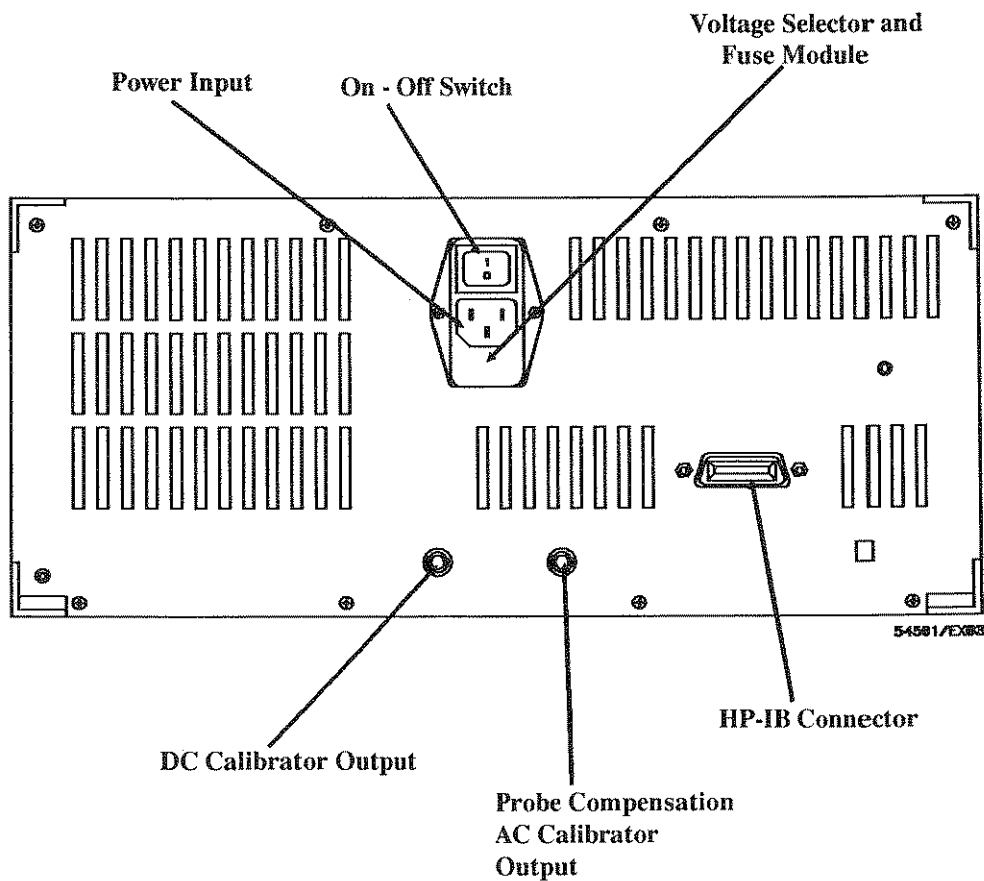

Start Up

Refer to the *Front-Panel Reference* for complete installation instructions.

Connecting Power

To ensure safe operation, the following items should be checked before power is applied to the instrument:

- Before connecting the instrument to an ac power source, ensure that the line voltage selector module is installed for the correct voltage. On the voltage selector module, the correct voltage selection must be at the bottom.
- Make sure that the correct power cord is supplied with the oscilloscope to provide chassis ground for the instrument when it is plugged into the power receptacle.

Applying Power

After the power cord has been connected to the instrument and appropriate power source, set the rear-panel power switch ON to start instrument operation (0 indicates OFF and 1 indicates ON).

Resetting the Instrument

This instrument stores all settings in nonvolatile memory when power is removed or turned off. These settings are remembered on power-up. In order to get all settings and keys to a known starting position, for the following procedures, reset the instrument.

- Press the front panel **RECALL** key and then the **CLEAR** key.

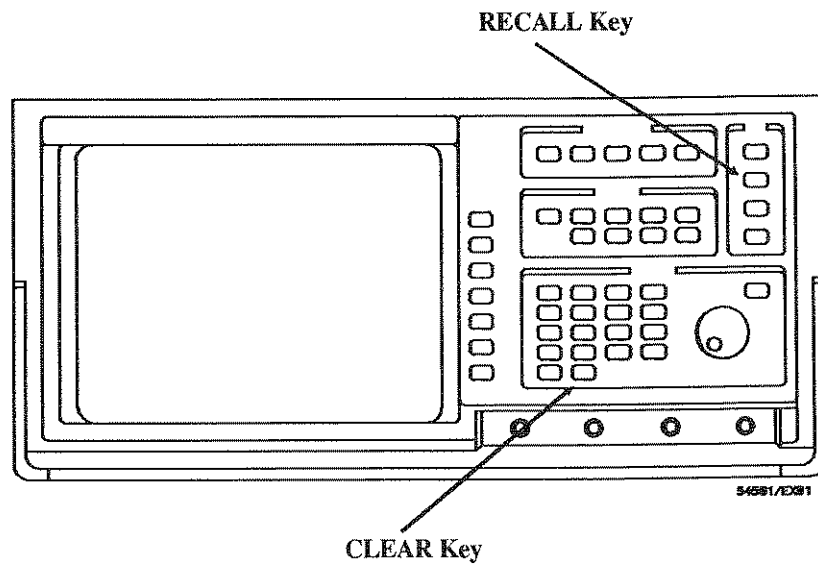

Instant Setup

3

In this chapter a basic oscilloscope setup is performed. The oscilloscope is set up automatically and manually. Generally, the automatic setup is used on an unknown signal or signals, then adjusted (fine tuned) manually.

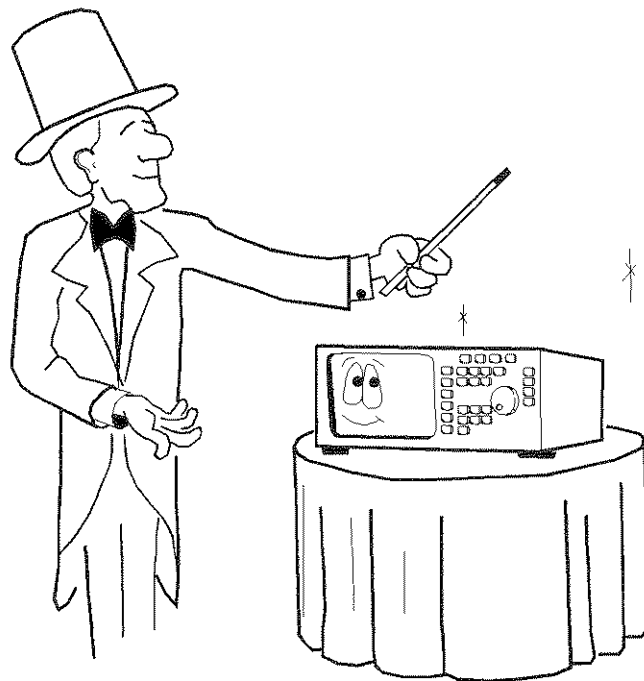

Autoscale

Autoscale automatically finds, scales, and displays the input waveform.

- Connect the ac calibrator output, on the rear panel of the oscilloscope to channel 1 input with the supplied probe and probe-to-BNC adapter.
- Press **AUTOSCALE** key.

hp running

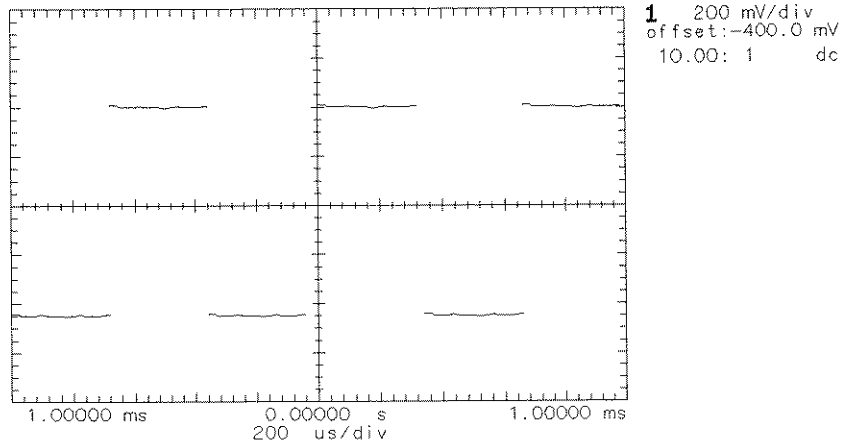

54501/WF29

The channel settings and trigger information are displayed along the right edge of the display.

Vertical Setup

The vertical setup displays the signal at most amplitude levels.

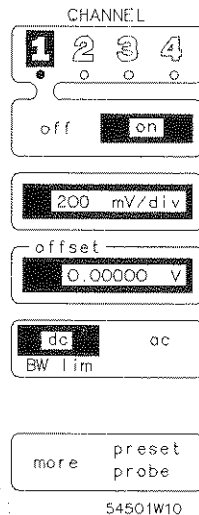

- Press CHAN Menu key.

Channel menu is displayed along the right edge of the display and volts/division is active function (displayed in full-bright inverse video.)

- Press more key.
- Change probe attenuation to 10:1 (attenuation of probe supplied with oscilloscope) with keypad or knob.

Notice the voltage information changes but the displayed waveform does not.

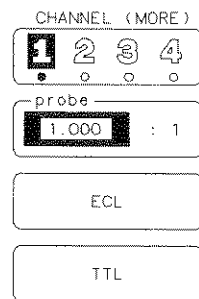

- Press more key again to return to the first channel menu and rotate the knob slowly.

The volts/division changes and the waveform amplitude on the display changes.

Notice the volts/division changes in much smaller increments because of the change in probe attenuation.

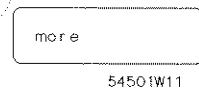

- Enter 250 mvolts.

Press 2, 5, 0, mV keys in order. The unit key completes the entry.

- Press **channel ON/OFF** function key.

Turn channel 1 display off.

The dot below the channel selection changes from inverse video to an outlined dot. This indicates that the channel is turned off.

- Press **channel On/Off** function key again.

Turn the channel 1 display back on and the dot becomes an inverse video display.

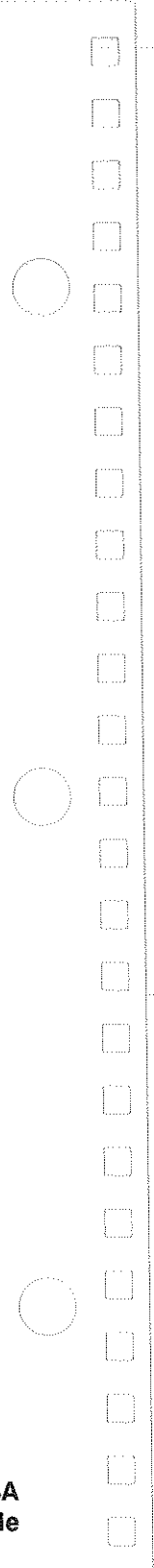

Timebase Setup

Setting the timebase displays the signal at different time/division settings (Remember the frequency of the HP 54502A is different than the HP 54501A and HP 54503A and will have different values displayed.)

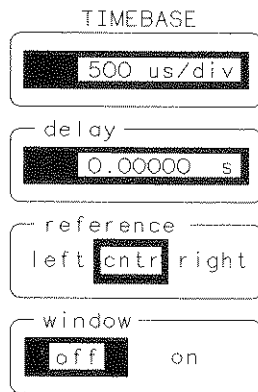

54501W08

- Press **TIMEBASE** menu key.

The displayed menu changes to the timebase menu.

The selected function is time/division (top key in menu, displayed in full bright).

- Rotate the knob.

The time/division changes in a 1, 2, 5 sequence as the knob is rotated.

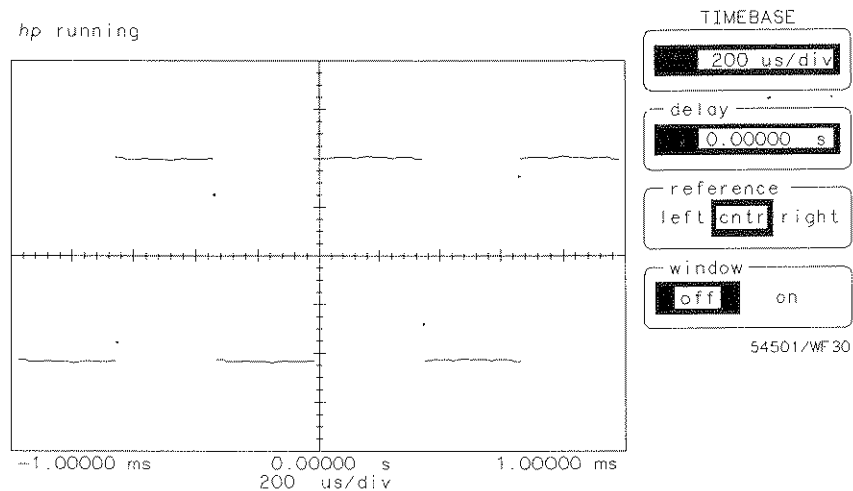

- Enter 500 μ seconds.

Press 5, 0, 0, μ s keys in order.

When using the keypad, press a units key (s, ms, μ s, or ns) to complete the entry.

hp running

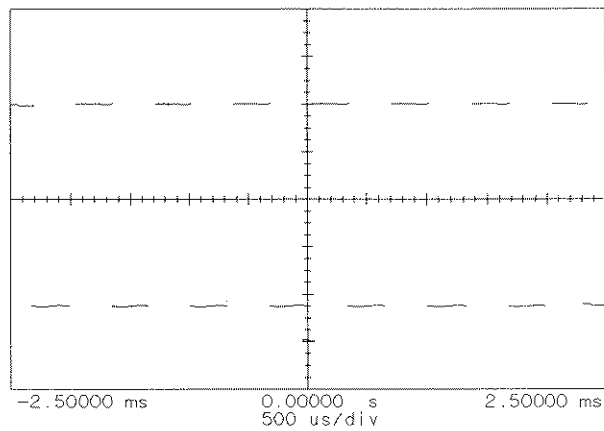

TIMEBASE

500 us/div

delay

0.00000 s

reference

left **cntr** right

window

off on

54501/WF 31

Trigger Setup

The oscilloscope can be set to trigger at any threshold level with the trigger level function.

- Press **TRIG** menu entry key.

The trigger menu is displayed on the right edge of the display.

The level function is selected (full-bright).

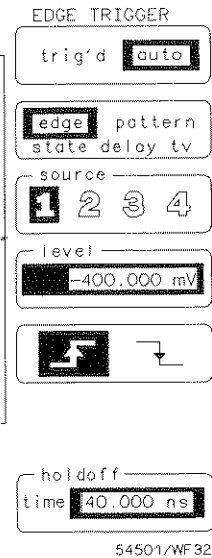
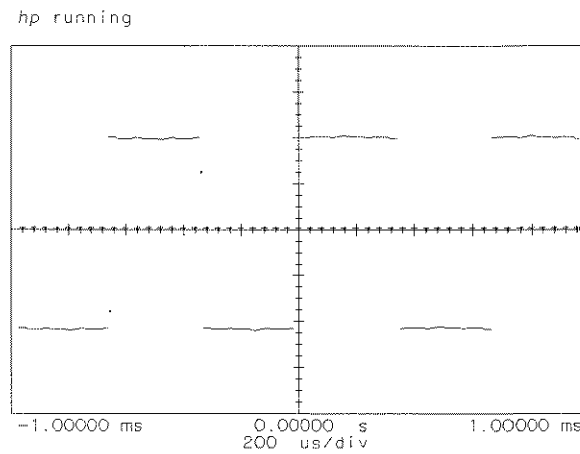
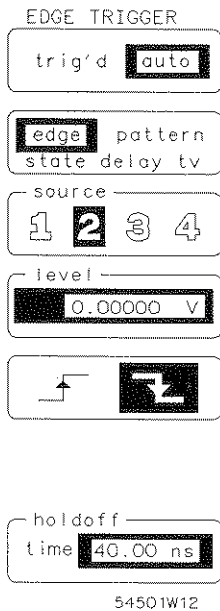

- Rotate the knob.

As the knob is turned the trigger level value is changed.

The trigger level is a horizontal dotted line that moves up and down as the knob is turned.

- Set trigger level to -650 mvolts.

Enter this value with the keypad.

- Press **SHOW** key.

Key is located at the right of the oscilloscope in the **SETUP** section.

Channel and trigger setup information is displayed.

- Press **SHOW** key.

Return to trigger menu.

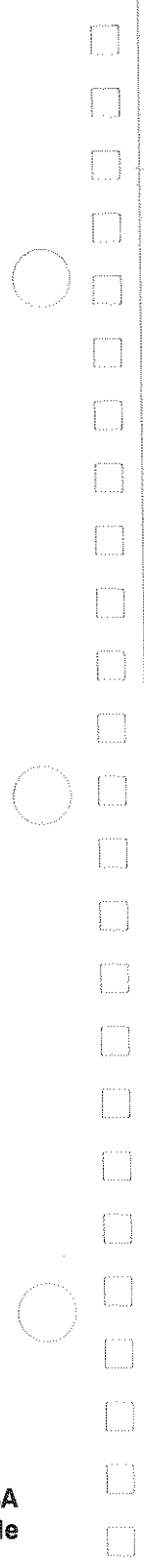

Making Automatic Measurements 4

There are 16 parametric measurements these oscilloscopes can make automatically. These measurements are made with preset (standard) measurement definitions or by user defined measurement thresholds. This chapter performs measurements using the standard measurement definitions. For more information on user defined measurements, refer to the Define Measure Menu chapter of the *Front-Panel Reference*.

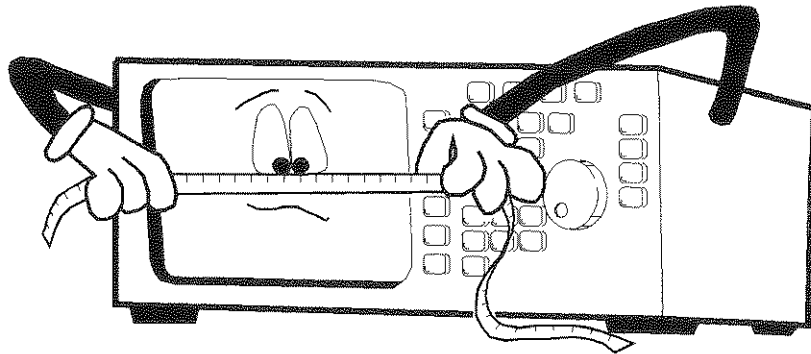

Making the Measurements

This exercise measures frequency and peak-to-peak voltage of the displayed waveform.

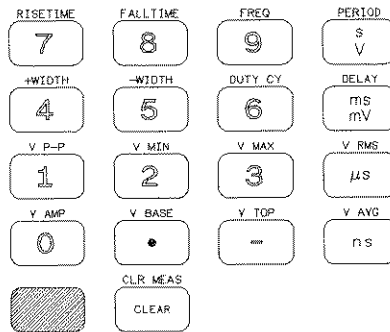

- Connect the ac calibrator signal from the rear panel to channel 1.
- Press **AUTOSCALE**.

Display and trigger the signal from channel 1.

- Press **SHIFT** (blue) entry key.

Select the alternate (blue letter) functions of the keypad.

- Press **FREQ [9]** entry key.

Select frequency as the measurement to be made.

At least one complete cycle of the signal must be displayed.

- Press the **1** entry key to select channel 1 as measurement source.
- The result of the frequency measurement is displayed as in figure below. (Frequency of HP 54502A rear panel calibrator signal is approximately 500 Hz rather than the approximate 1.515 kHz of HP 54501A and HP 54503A.)

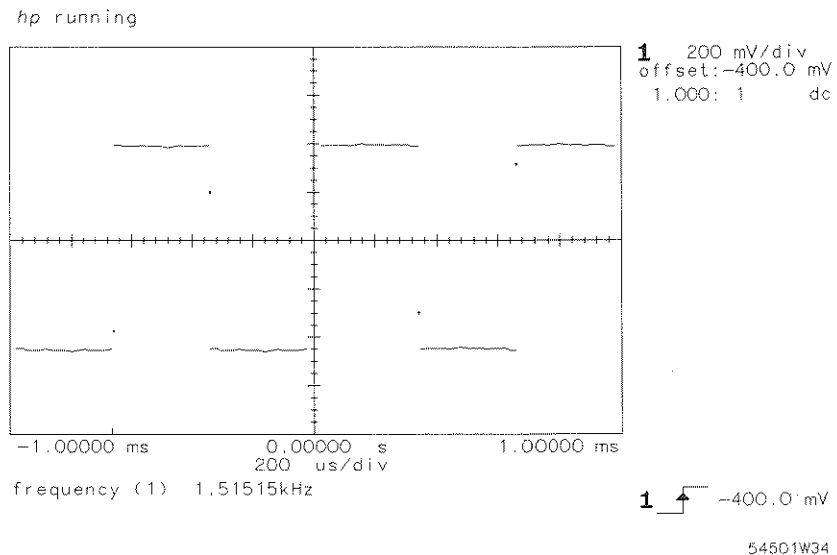

- Press **SHIFT** key.

Select the measurement functions.

- Press **Vp-p [1]** entry key.

Select peak-to-peak voltage as the measurement.

- Press the **1** entry key.

To select channel 1 as the measurement source.

Time and voltage markers would be displayed showing where the measurement was made if

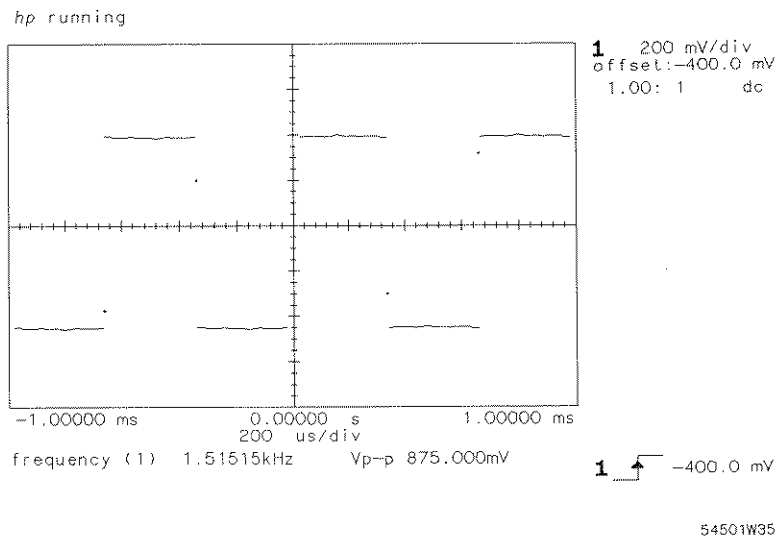

continuous measurements were turned off.

- Read the measurement results.

Measurement results are displayed below the waveforms. Up to eight measurements can be displayed at a time.

If another measurement is made, after the screen is full, it is placed on the bottom display line and the top set of measurements are erased from the display.

Clearing the Measurements

This portion of the exercise shows how to eliminate the measurements from the display.

- Press **SHIFT** entry key then the **CLEAR** entry key.

All measurement results are erased from the display.

Measuring Other Sources

Measurements can also be made on a waveform that is stored in a Waveform Memory or on the results of a mathematical calculation, a Waveform Function.

- Press **SHIFT** entry key then the **V P-P [1]** entry key.

At this time the measurement source prompt is **c#**
(for channel number).

- Rotate the knob slowly.

The measurement source prompt cycles through **m#**,
f#, and **c#**.

When **m#** is selected a waveform
memory number can be selected as
the measurement source, and when
f# is selected a waveform function
number can be selected as the
measurement source.

- Press **SHIFT** entry key.

The measurement is cancelled.

Making Manual Measurements 5

Two sets of markers (cursors) are available on the oscilloscopes to make manual time and voltage measurements. These procedures make voltage and time measurements with the voltage markers and time markers.

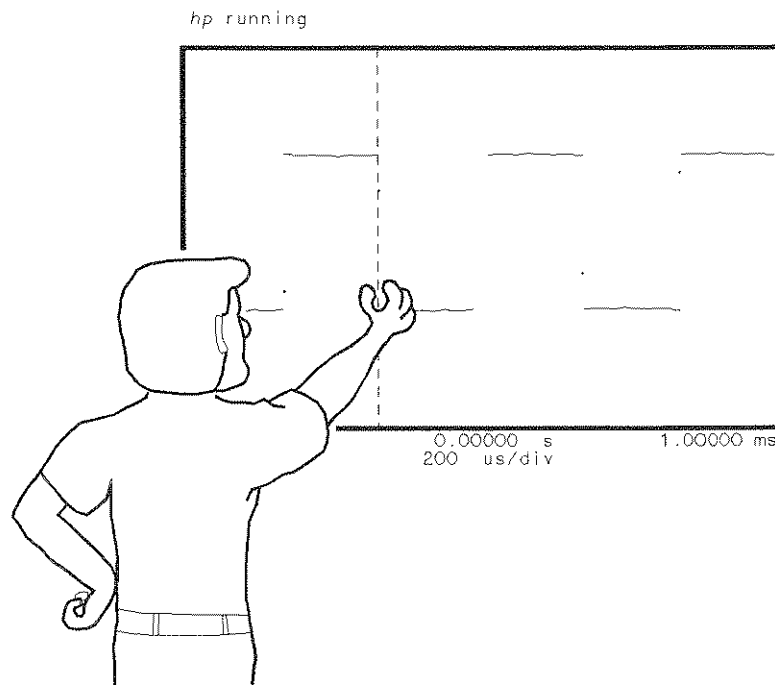

Making Voltage Measurements

Voltage measurements are made with a pair of voltage markers to determine 1 or 2 specific voltage points on a waveform.

The oscilloscope automatically calculates the voltage difference between the two markers and displays that difference as the delta voltage value.

The following procedure makes a peak-to-peak voltage measurement, then a positive peak measurement with the voltage markers.

- Connect the ac calibrator output to the channel 1 input.
- Press the **AUTOSCALE** key (or set up the channel display manually).

Display and trigger the waveform.

- Press $\Delta t/\Delta V$ menu key.

hp running

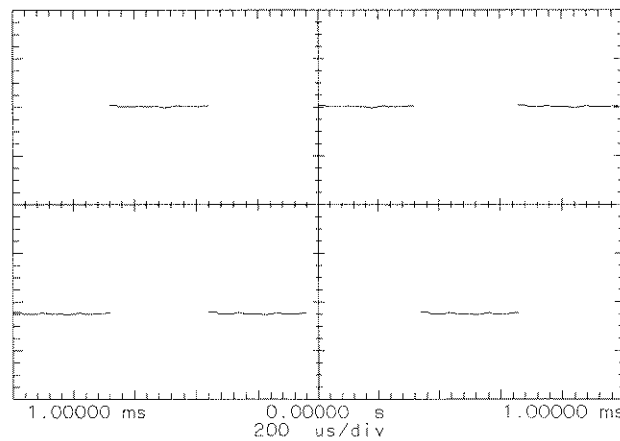

54501W29

1 \uparrow -400.0 mV

Selects the Δt and ΔV function.

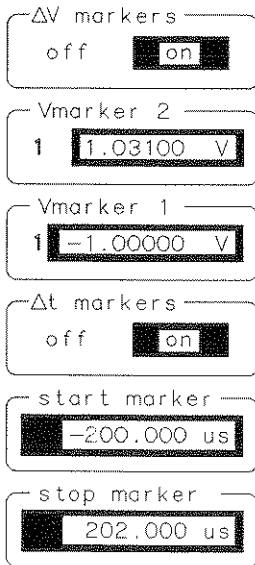

54501W05

The $\Delta t/\Delta V$ markers are off by default. Turn the Δt markers off if they are on.

- Press ΔV markers function key to select **on** to enable the two markers.
- Press **Vmarker 2** function key several times.

The selected function (intensified display) toggles between the Vmarker 2 source and the Vmarker 2 voltage.

- Select the source function for control and slowly rotate the knob clockwise.

The selected source changes.

As the knob is rotated all sources are displayed one at a time (channels, waveform memories, and waveform functions).

- Set the source selection to **1** (channel 1) using the knob.
- Press the **Vmarker 2** function key to select the Vmarker 2 voltage function.
- Rotate the knob.

Vmarker 2 is at the top of the waveform.

- Read the voltage at Vmarker 2.

The actual voltage at Vmarker 2 with respect to the voltage reference is displayed as "Vmarker2(1) XXXX V."

The number in parentheses is the source for the measurement.

- Ensure the Vmarker 1 source is set to 1 (channel 1).

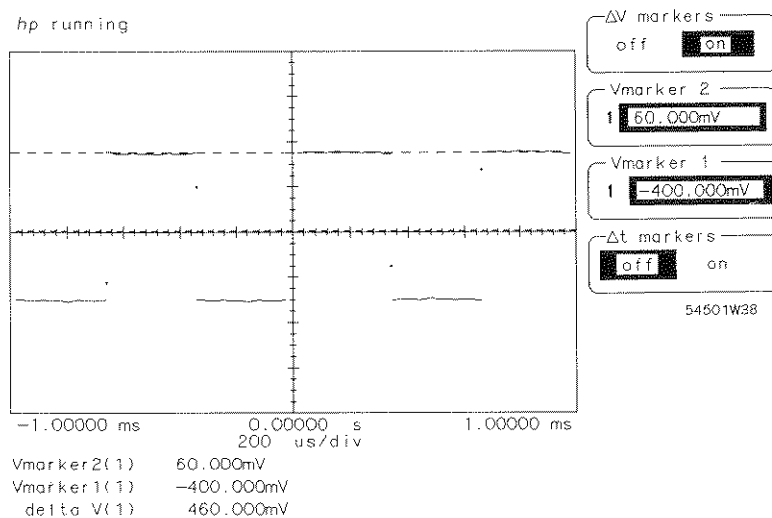

This key also toggles between a measurement source and a voltage level.

- Press the **Vmarker 1** function key to select the Vmarker 1 voltage.
- Rotate the knob until Vmarker is at bottom of waveform.
- Read the voltage at Vmarker 1.

Vmarker1 (1) XXXX V.

- Read the peak-to-peak voltage.

What are Time Interval Measurements?

Time interval measurements are made with one or both of the time markers to determine the relationship of a specific point on a waveform to the trigger point. The oscilloscope automatically calculates the time difference between the two markers. The "delta t" calculation is always made by subtracting the time at the "start marker" from the time at the "stop marker." Therefore it is possible to obtain negative time readings on "delta t" if the "stop marker" is placed on the display before the "start marker."

After an Autoscale, the trigger point is displayed at the center of the display. When a time marker is placed on the left half of the display the time for that marker is negative, indicating it is before the trigger. Any marker to the right of the trigger point is after the trigger and its time reading is positive. The reference for the display (trigger point) can be changed to left, cntr (center), or right of the display in the TIMEBASE menu.

Measuring a Waveform Period

The following procedure measures the period of a complete cycle of the calibrator signal.

- Connect the ac calibrator output to the channel 1 input.
- Press **AUTOSCALE** (or set up the oscilloscope display manually).
- Press $\Delta t/\Delta V$ menu key.
- Press Δt markers function key to turn on the markers.

- Press **start marker** function key.

The **start marker** is now controlled by the ENTRY devices. Full-bright inverse video indicates a function is selected.

- Rotate the knob.

Set the start marker on the first displayed negative-going waveform edge.

- Press **stop marker** key.

Select the stop marker as the active function.

- Rotate the knob.

Place the stop marker on the second displayed negative-going waveform edge.

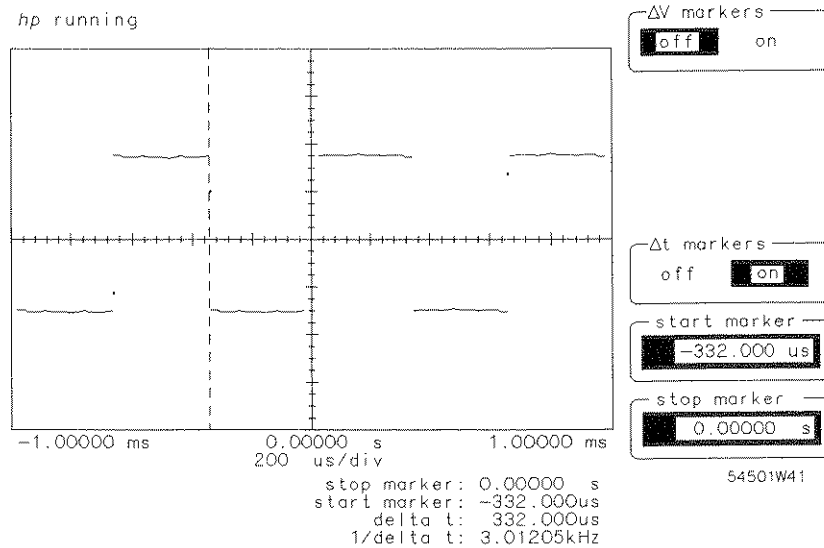

- Read the start marker time, stop marker time, and delta t time.

The delta t value is the time at the stop marker minus the time at the start marker. At this time the delta t value is the period of the waveform.

The 1/delta t reading displays the frequency of the selected period.

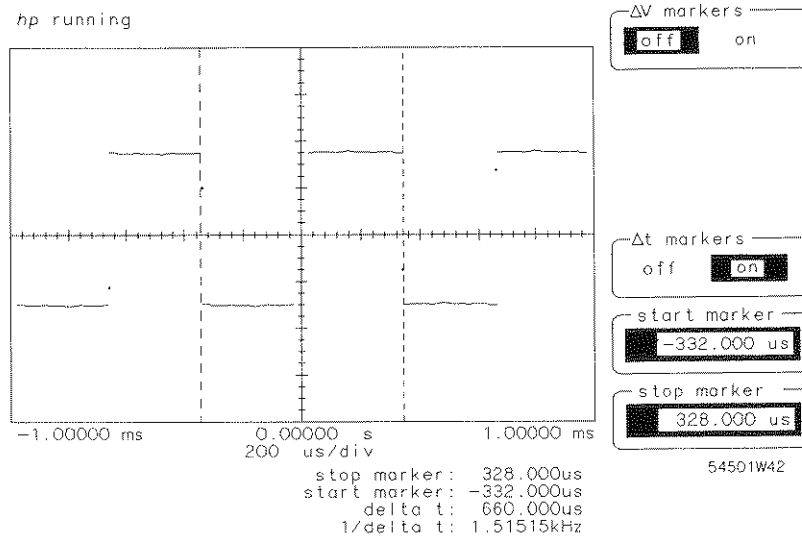

Storing Setups and Waveforms 6

The oscilloscope stores and recalls up to four front-panel setups and four waveforms in nonvolatile memories. These procedures save and recall front-panel setups and waveforms.

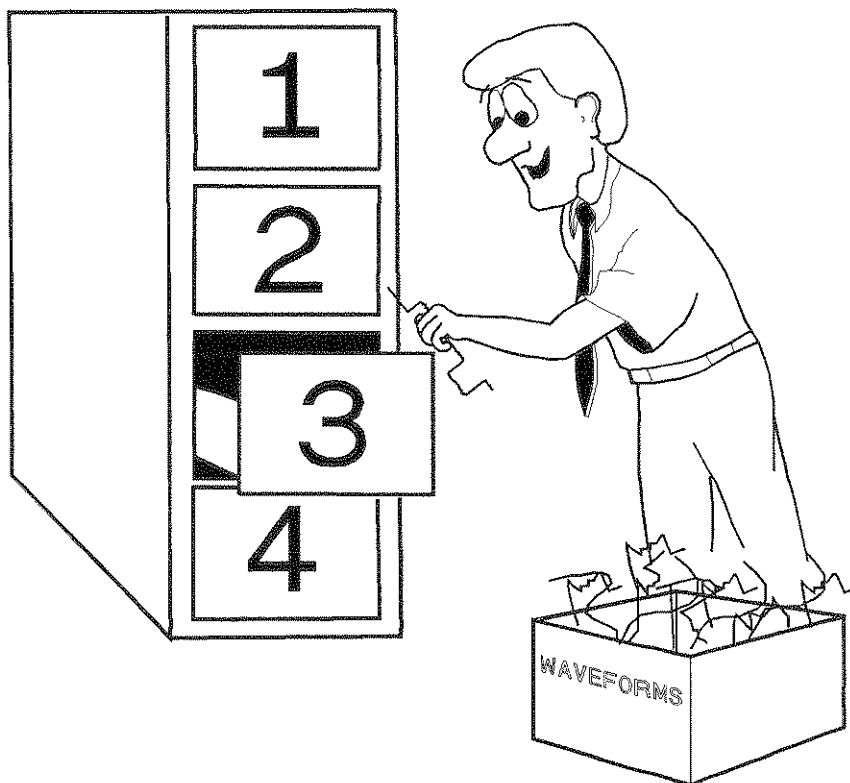

Storing Front-Panel Set Ups

Connect a signal to the channel 1 input.

Use the ac calibrator or any other handy signal.

- Set the oscilloscope to display the waveform.

Use **AUTOSCALE** for ease.

- Press **SAVE** key then the **4** key.

This saves the current front-panel setup in **SAVE/RECALL** register number 4. There are four **SAVE/RECALL** memories numbered 1 through 4. Any one can be selected.

- Change some front-panel settings.

For example, change the time/division in the **TIMEBASE** menu and the volts/division in the **CHAN** menu.

- Press the **RECALL** key, then the **4** key.

The instrument returns to the set up that was saved.

The **SAVE/RECALL** registers save all front-panel selections and settings. It will not cause any actions to take place, for example when a front-panel setting is recalled, it cannot initiate a measurement.

Storing a Waveform

This procedure stores a waveform, changes the offset setting, then recalls the stored waveform and compares it to the currently displayed waveform.

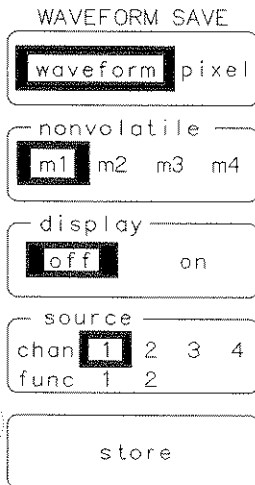

54501W20

- Connect a signal to the channel 1 input.
- Set the oscilloscope to display a waveform.

Use **AUTOSCALE**.

- Press **WFORM SAVE** menu key.

Select the waveform save menu.

- Select **waveform** with **waveform/pixel** function key.

- Press **nonvolatile** function key and select memory 3 (**m3**).

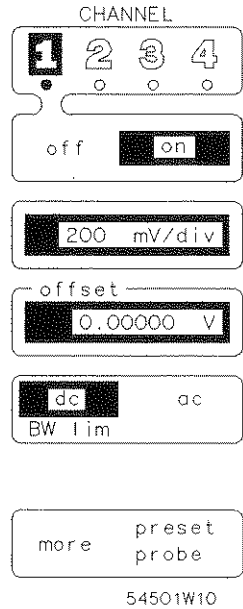

- Press **source** of store function key.

Select 1 (channel 1).

This selects channel 1 waveform to be stored. If waveform is displayed on channel 2, 3, or 4, select that source at this point.

- Press **store** function key.

The channel 1 (or selected) waveform is now stored in nonvolatile memory.

- Press **CHAN** menu key.

- Press **offset** function key.

- Rotate knob to move the displayed waveform up or down.

This step changes the currently displayed waveform to make it easier to tell the difference.

- Reselect **WFORM SAVE** menu.

- If **nonvolatile m3** is not selected, select it at this time.

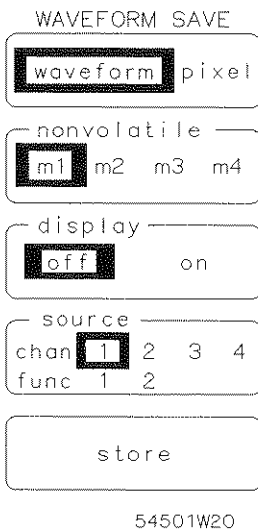

- Press **display** function key in the waveform save menu.

Display the memory 3 (m3) waveform.

At this time two waveforms are displayed, the one that has the offset changed is the current waveform (displayed in fullbright) and the other the stored waveform (displayed in halfbright).

To see the stored waveform better, select the **CHAN** menu and turn the active display off.

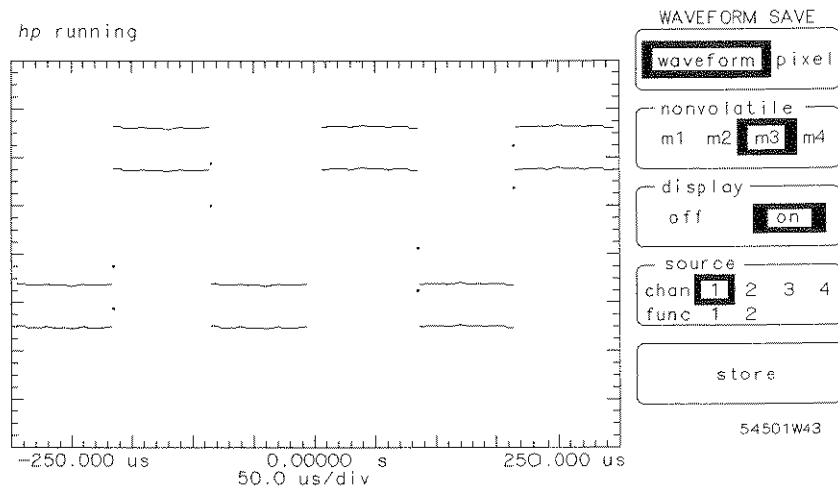

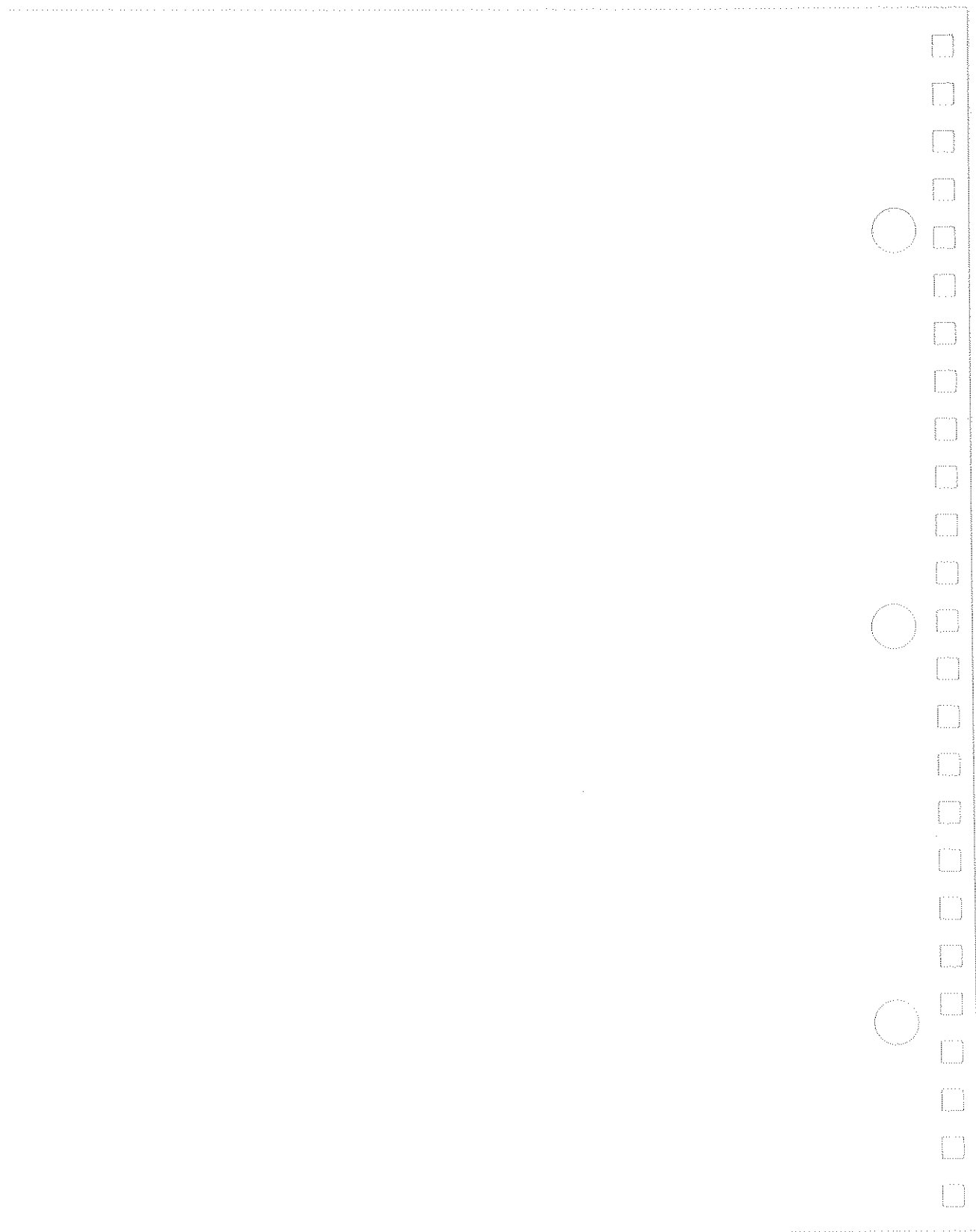

Making a Hardcopy Output

7

The procedures in this chapter demonstrate how to get a hardcopy output of the oscilloscope display. An HP-IB compatible printer or plotter can be used with the HP 54502A and HP 54503A. This procedure uses an @HP THINKJET printer as the output device. The first portion of the procedure sets up the HP-IB interface for proper operation between the printer and oscilloscope.

If the oscilloscope and plotter or printer are already operating together, skip to the second portion of this procedure.

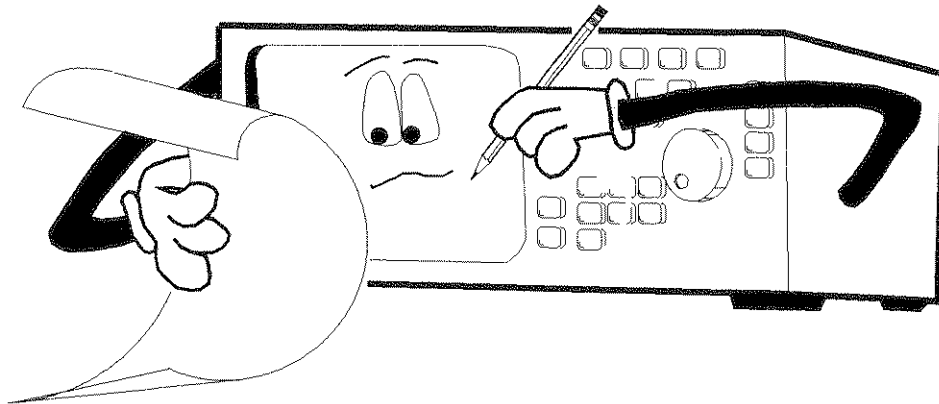

Setting Up the HP-IB

Connect the printer to the oscilloscope with a standard HP-IB cable. The menus in this procedure are from the HP 54502A. Plotter compatibility is not available with HP 54501A.

UTILITY

HP-IB menu

self test menu

probe cal menu

self cal menu

service menu

clicker
off on

ac BNC probe comp
trigger out

rev date 54502W38

HP-IB

talk only
 addressed

EOI
off on

form feed
off on

paper length
 11in. 12in.

device mode
 print plot

exit menu

54503W01

- Set the printer to LISTEN ALWAYS.

Switch 2 on the printer must be set to the up position.

- Apply power to the printer.

If any printer switches have been changed, the printer power must be cycled so the new settings are read.

- Press UTIL key on the oscilloscope.

Selects the Utility menu functions.

- Press the top function key to select the HP-IB functions.

Shows a second level function to set the talk only/addressed mode.

- If talk only is not selected, press the talk only/addressed key.

This sets the oscilloscope to the talk only mode. In this mode, the oscilloscope becomes an HP-IB talker.

- If print is not selected in HP 54502A and HP 54503A device mode function, select it now.

The oscilloscope and printer are now set to operate together.

Making a Hardcopy Output 7-2

HP 54501A, HP 54502A and HP 54503A Getting Started Guide

Hardcopy Output

Connect a signal to the oscilloscope input.

- Use AUTOSCALE or set up the oscilloscope to display the input signal manually.
- Make some automatic measurements.

This is only to demonstrate the output.

- Press **SHOW** key.

Displays the setup information. Again this is not required to make the hardcopy.

- Press **HARDCOPY** key (front panel SYSTEM CONTROL section).

The printer receives a copy of the oscilloscope display, including the measurements and setup information.

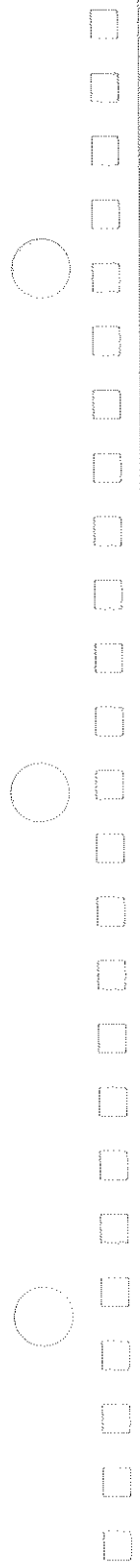

Dual Timebase Windowing

8

This chapter uses the TIMEBASE WINDOW function to make waveform parametric measurements. Also, a risetime measurement is made with the oscilloscope.

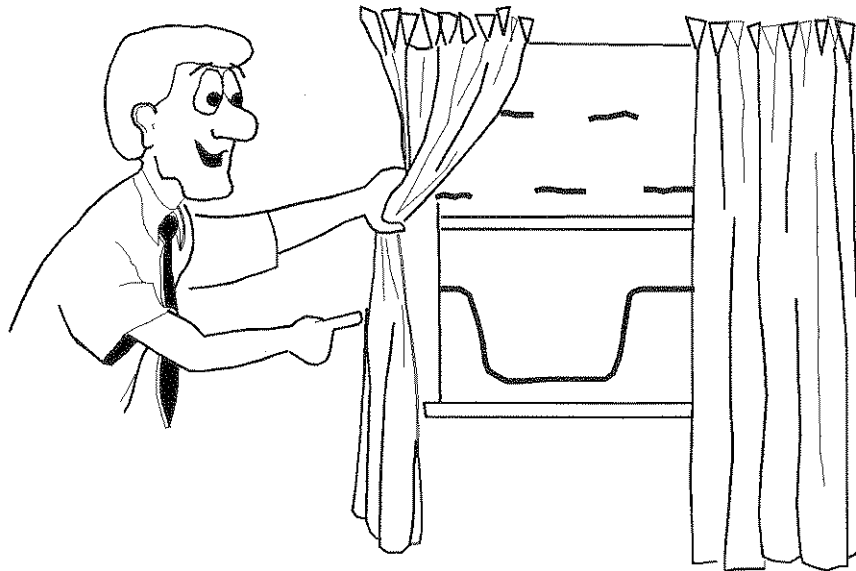

Using the Window

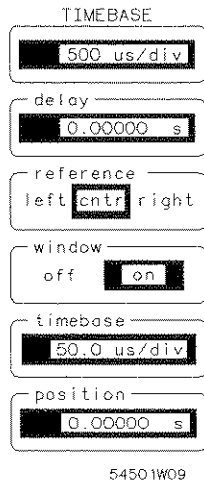
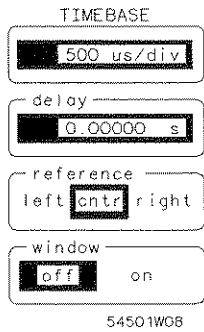

This procedure uses the TIMEBASE WINDOW function to measure the risetime of the signal generator output.

The Timebase window function is similar to dual timebase in analog oscilloscopes. This function picks a portion of the main sweep and display it below the main sweep waveform. The display can contain up to four main sweep waveforms and four timebase window waveforms, using two sweep speeds.

- Connect the input signal to channel 1 input.
- Press AUTOSCALE (or set up the oscilloscope display manually).
- Select **TIMEBASE** menu.
- Press **window** function key.

Until **on** is selected.

- Press window **timebase** function key.
- Rotate knob to display an entire positive pulse.
- Press window **position** key.

Assigns ENTRY devices to control the width of the window.

Assigns ENTRY devices to control the window position.

- Rotate knob.

Position the window markers around the positive-going waveform edge of the main sweep.

While window position value changes, the expanded positive-going waveform edge moves horizontally on the lower (windowed) display.

The window position and window timebase functions should be positioned to display the entire positive pulse.

All waveform information displayed is based on the windowed waveform.

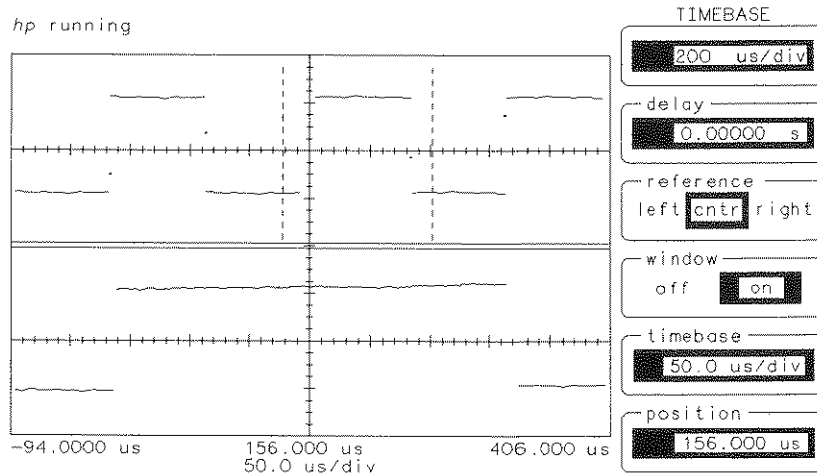

54501W44

Making Measurements in the Window

- Press **SHIFT** (blue) entry key.

Selects the measurement functions.

- Press the **+ WIDTH [4]** entry key.

Tells the instrument which measurement to make.

- Press the **1** entry key.

Selects the measurement source.

If delta t and delta v markers are still on from the previous example in this guide, then they will appear in the window display. The measurement is made on the windowed waveform any time the window function is turned on.

Free Manuals Download Website

<http://myh66.com>

<http://usermanuals.us>

<http://www.somanuals.com>

<http://www.4manuals.cc>

<http://www.manual-lib.com>

<http://www.404manual.com>

<http://www.luxmanual.com>

<http://aubethermostatmanual.com>

Golf course search by state

<http://golfingnear.com>

Email search by domain

<http://emailbydomain.com>

Auto manuals search

<http://auto.somanuals.com>

TV manuals search

<http://tv.somanuals.com>