



OPERATING AND SERVICE MANUAL

MODEL 1111A

SERIAL PREFIXED: 422-

AC CURRENT AMPLIFIER

**CENTRAL ENGINEERING
INSTRUMENT POOL**

COPYRIGHT HEWLETT-PACKARD COMPANY 1963
1501 PAGE MILL ROAD, PALO ALTO, CALIFORNIA, U.S.A.



01862-2

Printed: JULY 1964

TABLE OF CONTENTS

Section	Page	Section	Page
I GENERAL INFORMATION	1-1	V MAINTENANCE	5-1
1-1. Description and Applications	1-1	5-1. Test Equipment Required	5-1
1-4. Instrument Identification	1-1	5-4. Performance Check	5-1
II PREPARATION FOR USE	2-1	5-6. Sensitivity and Accuracy	5-2
2-1. Incoming Quality Control Inspection	2-1	5-7. Noise	5-2
2-4. AC Power Considerations	2-1	5-8. Bandwidth	5-2
2-5. Power Requirements	2-1	5-9. Rise Time	5-2
2-7. Three-Conductor Connector	2-1	5-10. Adjustments	5-3
2-9. Rack Installation	2-1	5-11. Amplifier Gain Set	5-3
2-11. Repackaging for Shipment	2-1	5-12. Pulse and High Frequency Response	5-3
III OPERATING INSTRUCTIONS	3-1	5-14. Troubleshooting	5-4
3-1. Introduction	3-1	5-15. Circuit Voltages	5-4
3-3. Panel Description and Operating Procedure	3-1	5-17. No Operation	5-4
3-5. Operating Considerations	3-1	5-18. Excessive Square-Wave Sag	5-4
3-14. Amplifier Gain	3-2	5-19. Excessive Square-Wave Overshoot	5-5
3-15. Input Impedance	3-2	5-21. Out of Calibration	5-5
IV PRINCIPLES OF OPERATION	4-1	5-23. Repair and Replacement	5-5
4-1. Introduction	4-1	5-24. Component Location	5-5
4-3. Input Amplifier	4-1	5-26. Replacing Etched Circuit Board Components	5-5
4-5. Circuit Operation	4-1	VI REPLACEABLE PARTS	6-1
4-10. DC Biasing	4-2	6-1. Introduction	6-1
4-13. Output Amplifier	4-2	6-4. Ordering Information	6-1
4-15. Power Supply	4-2		

LIST OF ILLUSTRATIONS

Number	Title	Page
1-1.	Model 1111A AC Current Amplifier	1-0
3-1.	Front Panel Description and Operation Procedure	3-1
3-2.	Peak-to-Peak Current vs Frequency	3-2
4-1.	Simplified Input Amplifier Schematic	4-1
5-1.	Special 600 Ω Load	5-2
5-2.	Oscillator - Voltmeter Test Setup	5-2
5-3.	Signal Generator - RF Millivoltmeter Test Setup	5-3
5-4.	Rise Time Check Setup	5-3
5-5.	Pulse and High Frequency Response Test Setup	5-4
5-6.	Power Supply Assembly	5-5
5-7.	Front Panel and Sensitivity Switch Components	5-5
5-8.	Etched Circuit Board Components	5-6
5-9.	AC Current Amplifier Schematic	5-9

LIST OF TABLES

Number	Title	Page
1-1.	Specifications	1-0
3-1.	Amplifier Gain	3-2
5-1.	Test Equipment Required	5-1
5-2.	Sensitivity and Accuracy Check	5-2
5-3.	Calibration and Component Replacement Record	5-7
6-1.	Reference Designation Index	6-2
6-2.	Replaceable Parts	6-5
6-3.	Code List of Manufacturers	6-7

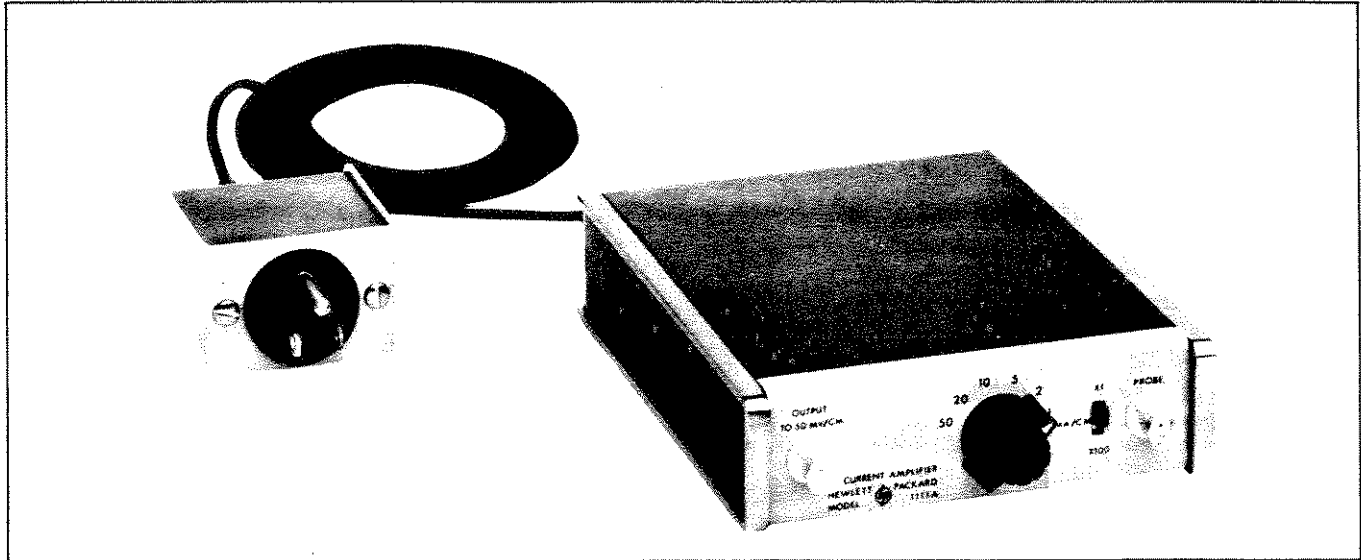

Figure 1-1. Model 1111A AC Current Amplifier

Table 1-1. Specifications for Model 1111A with Model 1110A Probe

SENSITIVITY: 1 ma/cm to 50 ma/cm in X1 100 ma/cm to 5 amps/cm in X100, 1, 2, 5 sequence for X1 or X100	MAXIMUM AC CURRENT: Above 700 cps: 50 amps pk-pk Below 700 cps: decreases at 1.4 amps/20 cps
ACCURACY: ±3% on X1 sensitivity ±4% on X100 sensitivity	OUTPUT IMPEDANCE: 50 ohms
BANDWIDTH: 50 cps to 20 Mc	DIMENSIONS: 1-1/2 in. high, 5-1/8 in. wide, 6 in. deep
RISE TIME: 18 nsec	WEIGHT: Approximately 2 lb
NOISE: Less than 100 μ a pk-pk, referred to input	POWER: 115 or 230 volts \pm 10%, 50 to 1000 cps, 1.5 watts

SECTION I

GENERAL INFORMATION

1-1. DESCRIPTION AND APPLICATIONS.

1-2. The Hewlett-Packard Model 1111A AC Current Amplifier, shown in Figure 1-1, is a stable, wide-band amplifier to be used with the hp Model 1110A Probe. The Model 1111A amplifies the Probe output, extends the low frequency response to 50 cps, and provides 12 ranges of sensitivity from 1 ma/cm to 5 amps/cm (used with 50 mv/cm sensitivity oscilloscope). Complete specifications are given in Table 1-1.

1-3. The Model 1111A is designed for use with an oscilloscope which has a calibrated vertical amplifier with 50 mv/cm sensitivity. When used with this sensitivity oscilloscope, the Model 1111A's attenuator may be read directly in milliamperes per centimeter

deflection on the CRT. The Model 1111A may be used with an oscilloscope having different sensitivity, but the conversion ratio must then be used.

1-4. INSTRUMENT IDENTIFICATION.

1-5. The Hewlett-Packard Company uses a two-section, eight-digit serial number to identify instruments (e.g. 000-00000). The serial number is located on a plate attached to the instrument rear panel. The first three digits are a serial prefix number, also appearing on the title page of this manual, and the last five digits identify a specific instrument. If the first three digits of the instrument serial number are not the same as those appearing on the title page, change sheets included with the manual will define differences between other instruments and the Model 1111A described herein. If the change sheets are missing, your hp Field Engineer can supply the information.

SECTION II

PREPARATION FOR USE

2-1. INCOMING QUALITY CONTROL INSPECTION.

2-2. MECHANICAL INSPECTION. Upon receipt of your Model 1111A, check that the contents are intact and as ordered. Inspect the instrument for any damage incurred in shipping. If the instrument is damaged, notify the carrier immediately (refer to the warranty which appears on the inside back cover of this manual).

2-3. PERFORMANCE CHECK. Check the performance of the Model 1111A by making the tests as outlined in Paragraph 5-4 of this manual. This check may be used to verify instrument specifications and as part of an incoming quality control inspection.

2-4. AC POWER CONSIDERATION.

2-5. POWER REQUIREMENTS.

2-6. The Model 1111A requires an AC power source of 115 or 230 volts $\pm 10\%$, single phase, 50 to 1000 cps. The power required is approximately 1.5 watts. The Model 1111A is normally shipped from the factory for use from a 115-volt power source. To convert the instrument for use from a 230-volt source, slide the 115-230 switch to the "230" position. This switch is located on the power plug assembly.

2-7. THREE-CONDUCTOR CONNECTOR.

2-8. To protect operating personnel the National Electrical Manufacturers Association (NEMA) recommends that the instrument panel and cabinet be

grounded. This instrument is equipped with a three-pin power plug which, when plugged into an appropriate receptacle, grounds the instrument. The offset round pin on the plug is the ground connection. To retain the protection feature when operating the instrument from a two-contact outlet, use a three-conductor to two-conductor adapter and connect the adapter wire to ground.

2-9. RACK INSTALLATION.

2-10. The Model 1111A may be placed in a hp 1051A combining case which may then be installed in an instrument rack. The Combining Case may also be mounted in the rack space of a hp Model 1117A Testmobile for convenience of keeping related-use instruments together (the hp 1051A also adapts 1/3 width modular instruments to a rack).

2-11. REPACKAGING FOR SHIPMENT.

2-12. The following is a general guide for packaging an instrument for shipment. If there are any questions regarding packaging methods, contact your Hewlett-Packard Field Office.

a. Wrap the instrument in heavy paper or plastic before placing it in the shipping container.

b. Use plenty of packing material around all sides of the instrument and protect surfaces with cardboard strips.

c. Place the instrument in a heavy cardboard carton or wooden box. Seal the container with heavy tape or metal straps.

d. Mark the packing container "FRAGILE-DELICATE INSTRUMENT".

2-13. If an instrument is being returned to Hewlett-Packard Company for servicing or repair, attach a tag to the instrument specifying owner, desired action, model number, and serial number. Ship the instrument to Hewlett-Packard Customer Service at the address on the warranty page. All correspondence should refer to an instrument by model number and the full (eight-digit) serial number.

SECTION III OPERATING INSTRUCTIONS

3-1. INTRODUCTION.

3-2. The Model 1111A provides amplification of the output of the Model 1110A Probe, and calibrated control of the sensitivity. Front-panel controls set the sensitivity in milliamperes/centimeter when used with an oscilloscope with 50 mv/cm sensitivity.

3-3. PANEL DESCRIPTION AND OPERATING PROCEDURE.

3-4. Figure 3-1(a) provides a brief description of front panel controls and connectors, keyed by number to the panel illustration. A step-by-step operating procedure is provided in Figure 3-1(b). Additional operating considerations are given in Paragraph 3-5.

3-5. OPERATING CONSIDERATIONS.

3-6. GENERAL. The following paragraphs contain information about making measurements using the Model 1111A with the Model 1110A Current Probe. While most of the considerations relate to the Model 1110A, the information is provided here since the two instruments are designed for use together.

3-7. DIRECTION OF CURRENT FLOW. The arrow on the probe body indicates the direction of conventional current flow which produces a positive output from the probe and amplifier. Thus there is a "sense of polarity" when observing current waveforms on the

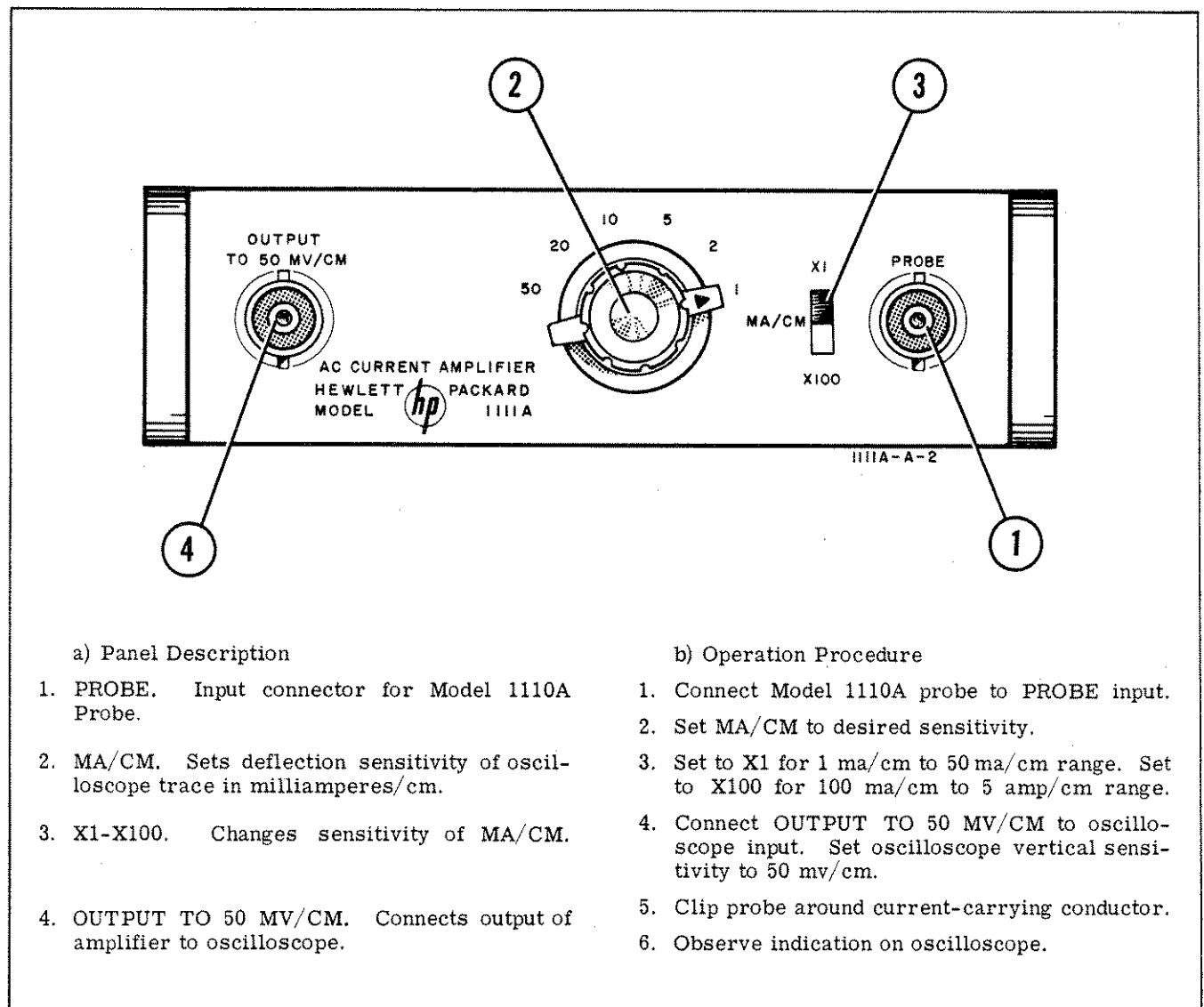

Figure 3-1. Front Panel Description and Operation Procedure

oscilloscope, and the polarity can be reversed by removing the probe from any wire, rotating the probe 180°, and clipping it around the wire again.

3-8. INCREASING SENSITIVITY. The sensitivity of the probe may be increased by looping the wire through two or more times. The increase in sensitivity is directly proportional to the number of loops; i.e., 2 loops = twice sensitivity. However, the increase in sensitivity is accompanied by an increase in the series loading effect due to the probe, which increases as the square of the number of loops. Also, the looped wire itself adds inductance and shunt capacitance to ground which may be significant at high frequencies.

3-9. SUMMING CURRENTS. The probe may be clipped around wires carrying different currents as well as around loops of the same wire. In either case the instantaneous output of the probe is the algebraic sum of the instantaneous currents through the probe. In this way currents may be balanced (in push-pull circuits, for example) by clipping the probe around two wires in which the currents are 180° out of phase as they pass through the probe, and adjusting the circuit for minimum output from the probe.

3-10. EFFECTS OF EXTERNAL FIELDS. The probe is magnetically shielded to minimize the effects of external magnetic fields. However, strong fields near power transformers or electric motors may cause an unwanted output from the probe and amplifier. To check for such fields, hold the probe with jaws closed and no wire through it in the region in which you intend to make the measurement. If the probe output is excessive compared to the expected measurement, make the measurement at some other point along the wire farther from the source of the field, or orient the probe lead for minimum undesired output. If there is little or no output from the probe and amplifier the field will not affect the measurement.

3-11. PEAK CURRENT. The maximum peak-to-peak current which the probe and amplifier will accept is a function of frequency. Figure 3-2 shows a plot of peak-to-peak current vs frequency.

3-12. MAXIMUM DC CURRENT. The Current Amplifier and Probe will perform as specified in Table 1-1 if the DC current present is less than 0.5 amps. Above 0.5 amperes DC, performance is derated since the DC current acts to decrease Probe head inductance and to raise the low frequency -3 db point.

3-13. HIGH FREQUENCY RESPONSE. Performance of Current Amplifier and Probe will be within specifications if the load capacitance presented to the output of the Model 1111A is less than 30 pf. The high frequency -3 db point is determined by the capacitive load at the input. The typical high frequency oscilloscope has an input capacitance of 28 pf, hence high frequency operation of the Probe and Amplifier is not affected.

3-2

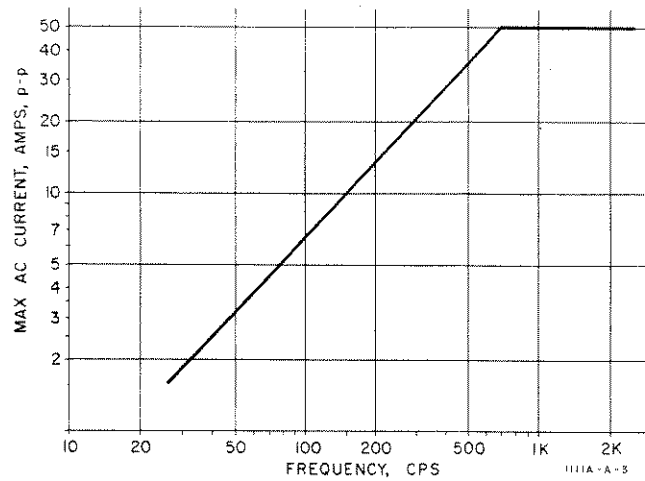

Figure 3-2. Peak-to-Peak Current vs Frequency

3-14. AMPLIFIER GAIN. The gain of interest for the Model 1111A is a transresistance, or output millivolts per milliampere of current at the input, which is the dimension of ohms (mv/ma = ohms). Since the input impedance varies somewhat with range and frequency (see Paragraph 3-15), this does not correspond to a stable voltage gain E_{out}/E_{in} . For convenience in using the Model 1111A amplifier in other applications, Table 3-1 lists gains for all sensitivity ranges.

3-15. INPUT IMPEDANCE. The X100 range is a constant 0.5 ohms ($\pm 3\%$) in series with an inductance of about 30×10^{-9} H (about 2" of wire). In the X1 position, input impedance is more complex, but up to about 100 kc can be approximated by a 2000 microfarad capacitor in series with a resistance of between 0.2 and 0.5 ohms, depending on sensitivity setting. At higher frequencies, the input impedance becomes dependent on feedback factor changes with frequency.

Table 3-1. Amplifier Gain

Range	MV _{out} /MA _{in} (1111A only)	MV _{out} /MA _{in} (with probe)
1	5000	50
2	2500	25
5	1000	10
10	500	5
20	250	2
50	100	1
Switching to X100 attenuates all ranges 100 times.		

01862-2

SECTION IV

PRINCIPLES OF OPERATION

4-1. INTRODUCTION.

4-2. The Model 1111A is a current amplifier which is specifically designed for use with the Model 1110A Current Probe. As described in the following paragraphs, the Model 1111A consists of an input amplifier, an output amplifier, and a power supply. Refer to the instrument schematic, Figure 5-9, for circuit references.

4-3. INPUT AMPLIFIER.

4-4. To obtain the maximum low-frequency potential of the probe, as well as optimum linearity and large-signal performance, the probe should have a load impedance which is much lower than the winding resistance of the current transformer in the probe. The input amplifier provides such a load, and also accomplishes the current-to-voltage conversion necessary for oscilloscope display. Circuit operation is described in Paragraph 4-5, and the biasing arrangement is described in Paragraph 4-10.

4-5. CIRCUIT OPERATION.

4-6. The input amplifier consists of a grounded-base amplifier Q1 and cascode amplifier Q2/Q3. The cascode amplifier combination, using two transistors, gives a lower effective collector-base capacitance than that of one transistor. The simplified schematic in Figure 4-1 shows the conditions for the 1 MA/CM range, and omits a bias-setting adjustment (R14) at the base of Q3.

4-7. An ac signal current from the probe is split between Q1 emitter (impedance of about 15 ohms to ground) and R20 (about 2000 ohms). However, due to the unity current gain of grounded-base amplifier Q1, any portion of the input signal current flowing into Q1 emitter is applied directly to Q2 base, causing about 100 times as much current to flow through R20. Therefore, because of this feedback, about 99% of the input signal current flows through R20, and only 1% into Q1 emitter. This action has two results: 1) since only 1% of the signal current flows into the 15-ohm emitter impedance of Q1, the input voltage developed is only 1% of what this current would develop in a 15-ohm resistor, meaning that the input impedance is reduced by a factor of 100, down to .15 ohm; 2) since 99% of input signal current (i_s) flows through R20, and because the input emitter is very close to ground potential, the output from Q3 is a voltage equal to $(.99i_s)(R20)$, which is almost independent of transistor parameters. If current gain of the cascode amplifier were to drop to 50 (a 2:1 change) then 98% of the input signal current would flow through R20, and gain would change only 1%.

4-8. Capacitor C6 is used for high-frequency gain stabilization by introducing a local negative feedback loop around the cascode amplifier. This capacitor reduces the total effect of transistors Q2 and Q3 and all their stray capacitances to that of a single -6 db/octave gain slope at high frequencies. The gain-crossover frequency (at which gain = 1) of the cascode amplifier is adjusted by varying this capacitance. The proper setting is determined on the basis of optimum

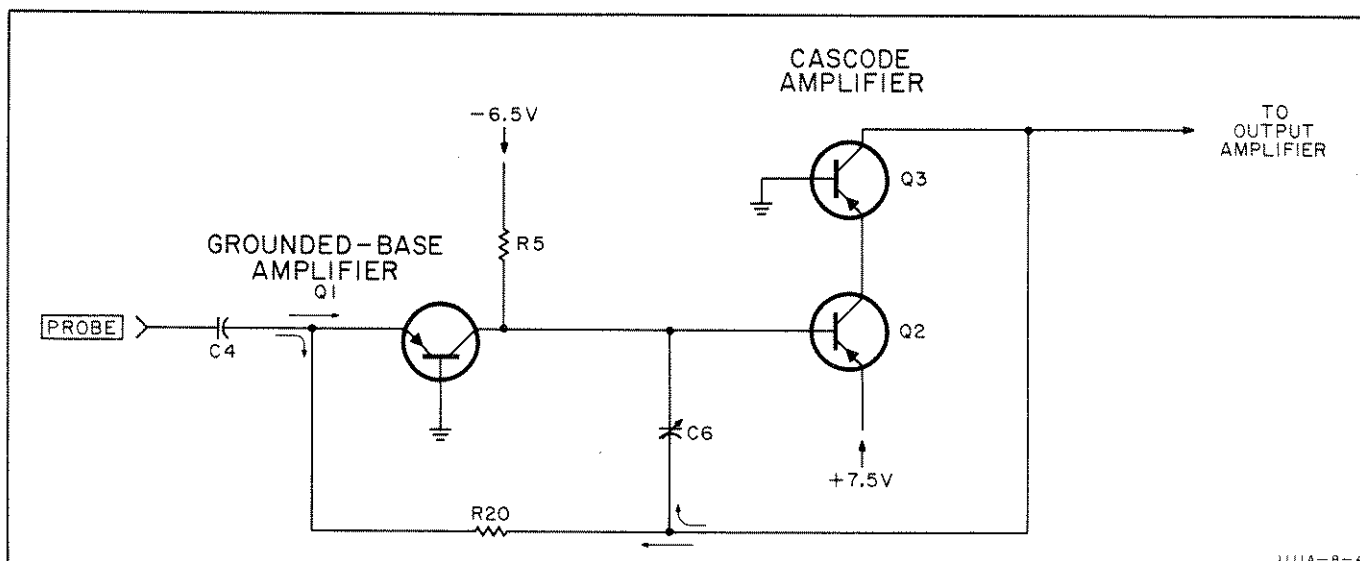

Figure 4-1. Simplified Input Amplifier Schematic

overall transient response (overshoot and rise time). Pulse Rounding Adjust R14 varies the collector voltage of the lower half of the cascode amplifier, altering the high-frequency response of the local feedback loop. Adjustment is made for optimum pulse response.

4-9. Sensitivity range is changed by switching in other values of feedback resistance (R20 in Figure 4-1). Since about 99% of input signal current flows in the feedback resistor, the gain function $\frac{E_{out}}{i_s}$ is approximately numerically equal to the feedback resistor in ohms. As the resistor is changed to smaller values, more bias current is required to provide adequate maximum output voltage. For this reason, R6 and R7 are switched in to reduce the Q1 collector load.

4-10. DC BIASING.

4-11. The dc voltages and currents are set as follows: the base of Q2 operates at about +7.0 volts (constant 0.5 volt base-emitter drop from +7.5 volt supply). Due to the 10-volt drop across breakdown diode CR7, the collector of Q1 must run at -3.0 volts, 10 volts negative from +7 volts. Since Q1 collector is at -3 volts, R5 has -6.5 volts at one end and -3 volts at the other, and so has 3.5 volts across it. This causes a current of $3.5/2400$, or 1.4 ma to flow in R5. The 1.4 ma dc current flows 99% through Q1 collector and 1% through Q2 base, due to the current gain of 100 in the cascode amplifier and gain of unity in Q1. (About .0138 ma in Q2 base causes about 1.38 ma in Q3 collector, which then flows through R20 and Q1, and joins with the .0138 ma base current to make the 1.4 ma in R20). Thus for a given set of dc voltages, R5 sets the current in all three transistors, and R20 affects only the dc voltage at the cascode amplifier output, which must be between +7 volts and ground for proper operation of the cascode stage.

4-12. Resistor R11 is switched in on the two most sensitive ranges to augment the bias current in Q2.

4-13. OUTPUT AMPLIFIER.

4-14. Following the input amplifier is a voltage divider, emitter follower, and straight common-emitter output amplifier, in that order. The voltage divider is used to reduce the gain for the 20 MA/CM and 50 MA/CM ranges (rather than further reduction of feedback resistance in the input amplifier). The output stage emitter resistor, R34, is unbypassed except for R35 and C19, which are switched in to compensate frequency response on the 1 and 2 MA/CM ranges against stray capacities. Calibration is set by R40, which forms a current divider with R41. Output impedance is 50 ohms, so the Model 1111A will drive any length of 50-ohm cable with flat response, independent of termination.

4-15. POWER SUPPLY.

4-16. The supplies, although labelled +7.5 and -6.5, are actually generated by one floating 14 volt regulated supply. The split to +7.5 and -6.5 is done by Q4 and Q5 in the final amplifier. The total 14 volt supply is tapped by R32 and R38, which places the base of Q4 approximately centered on the supply. Transistors Q4 and Q5 then act as dc emitter followers to solidly place ground at 7.5 volts from the positive end of the supply, and 6.5 volts from the negative end.

4-17. Resistor R33 (200 ohms) is really the emitter resistor for Q5, and sets the dc current in Q5, but has no effect on the voltage split between the positive and negative supplies.

4-18. When the interstage attenuator is switched in (on 20 and 50 MA/CM ranges), current from the +7.5 volt supply (through Q3 collector) would flow to ground through R29 (201 ohms) or R28 (50 ohms), subtracting from the available collector current of Q5. To obviate this, R8 (1200 ohms) is switched in, which passes this current directly to the -6.5 volt supply, rebalancing the load on the positive and negative supplies. Output transistor thus still gets all the bias current established by R33.

SECTION V MAINTENANCE

5-1. TEST EQUIPMENT REQUIRED.

5-2. INSTRUMENTS. Table 5-1 lists the test instruments required for the performance checks and for making the Model 1111A adjustments. Substitute equipment should provide performance according to the specifications listed in Table 5-1. Be sure test equipment has been recently calibrated and always allow manufacturer's suggested warmup period to obtain full accuracy.

5-3. SPECIAL LOADS. Three special loads are required: 50 Ω , 600 Ω , and 22 pf. These may be made by using the appropriate connector-adaptor and component required. Figure 5-1 illustrates the 600 Ω load required. The 50 Ω load may be made using a 50 \pm 0.5 Ω resistor and either the dual banana plug

connector or a BNC-banana plug adapter. For the capacitive load, use a 22 pf capacitor (hp Stock No. 0140-0145) and a BNC connector (hp Stock No. 1250-0079). Solder the capacitor between center conductor (on rear of connector) and the shield (next to threaded section).

5-4. PERFORMANCE CHECK.

5-5. The procedure of Paragraphs 5-6 through 5-9 should determine if the Model 1111A is operating within its specifications. If performance is out of specifications, refer to Paragraphs 5-10 through 5-13 for the adjustment procedure or to the troubleshooting suggestions of Paragraph 5-14. In the procedures using the Model 1110A Probe, always be sure the head surfaces are clean and that the jaws close firmly.

Table 5-1. Test Equipment Required

No.	Description	Important Specifications	Use	Recommended Equipment
1	Signal Generator	Output: 1 volt into 50 Ω , constant with frequency Frequency: 50 Kc-20 Mc	Check sensitivity, accuracy and bandwidth	hp Model 606A
2	AC Voltmeter	Accuracy: 1% Range: 0.1 volts	Check sensitivity accuracy and bandwidth	hp Model 400H
3	Current Probe	Bandwidth: 45 Mc Rise Time: 8 nsec Output: 1 mv/ma	Check sensitivity, accuracy and bandwidth Adjust pulse response	hp Model 1110A
4	Audio Oscillator	Range: 50 cps - 50 Kc Output: 1.5 volts into 600 Ω constant with frequency	Check bandwidth Adjust gain	hp Model 200CD
5	R. F. Millivoltmeter	Range: 0.1 volts Bandwidth: 1 Mc - 20 Mc Accuracy: \pm 3% full scale	Check bandwidth	hp Model 411A
6	Sampling Oscilloscope and plug-in	Bandwidth: 100 Mc Sync Pulse: 1.5 volts into 50 Ω , 1.5 nsec risetime Sensitivity: 10 mv/cm	Adjust pulse response	hp Model 185B and Model 187B
7	High Frequency Oscilloscope and plug-in	Bandwidth: 50 Mc Sensitivity: .05 v/cm	Check noise	hp Model 175A and Model 1751A
8	Square Wave Generator	Frequency: 400 Kc Rise Time: 3 nsec Output: 0.5 volts into 50 Ω	Adjust pulse and high frequency response	Tektronix Model 107 Square Wave Generator
9	Special Loads	50 Ω : 50 \pm 0.5 Ω Resistor 600 Ω : See Figure 5-1 22 PF: Capacitor and BNC connector	See Paragraph 5-3	

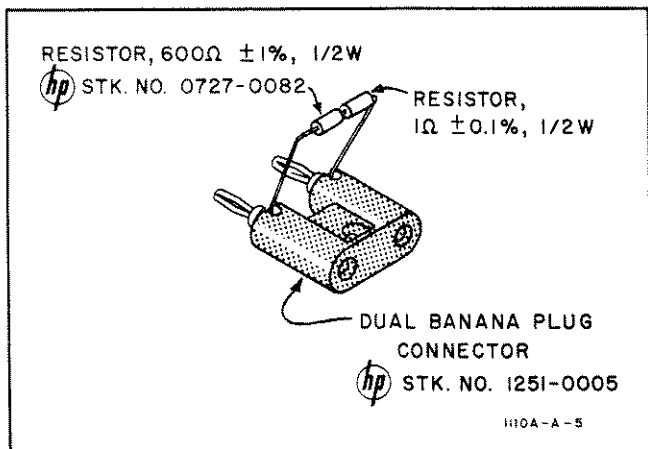

Figure 5-1. Special 600 Ω Load

5-6. SENSITIVITY AND ACCURACY.

- a. Refer to Table 5-1 and Figure 5-2 and connect test equipment. Items required are 2, 3, 4 and 9.
- b. Set Voltmeter range to 0.1 volts.
- c. Set Oscillator frequency to 50 kc.
- d. Disconnect Voltmeter from Model 1111A output and reconnect Voltmeter across the 600 Ω load.
- e. Set Oscillator output for a Voltmeter reading of 0.1 volts.
- f. Disconnect the Voltmeter from the load and reconnect it to the Model 1111A output.
- g. Set the Model 1111A sensitivity to 1 MA/CM, X1.
- h. Check Model 1111A output according to Table 5-2.
- i. Disconnect Voltmeter from Model 1111A output and reconnect it across the 600 Ω load.
- j. Set the Oscillator output for a Voltmeter reading of 1.0 volts.
- k. Disconnect the Voltmeter from the 600 Ω load and connect it to the Model 1111A output.
- m. Set the Model 1111A sensitivity to 1 MA/CM, X100.
- n. The Voltmeter reading should be 0.01 volts ±4%.

5-7. NOISE.

- a. Connect the Probe (item 3 in Table 5-1) to the Model 1111A input.

- b. Connect the Model 1111A output to the Oscilloscope plug-in (item 7 in Table 5-1).

- c. Set oscilloscope and plug-in SENSITIVITY to .05 VOLTS/CM, SWEEP TIME to 50 μSEC/CM, SWEEP MODE to PRESET, and TRIGGER SOURCE to LINE.

- d. Set Model 1111A sensitivity to 1 MA/CM, X1.

- e. Position the Probe and Amplifier (no input to probe) so the external field coupling is minimum as viewed on CRT.

- f. With oscilloscope trace intensity set for normal, look closely at the high frequency random noise displayed. Any noise should be less than 1 mm peak-to-peak, which corresponds to less than 100 μa p-p.

5-8. BANDWIDTH.

- a. Refer to Table 5-1 and Figure 5-2 and connect test equipment. Items requires are 2, 3, 4 and 9.
- b. Set Model 1111A sensitivity to 1 MA/CM, X1.
- c. Set Voltmeter range to 0.1 volts.
- d. Set Oscillator frequency to 10 Kc and amplitude for a zero db reading on the Voltmeter.
- e. Set Oscillator frequency to 50 cps.
- f. Voltmeter reading should be -3 db or greater.

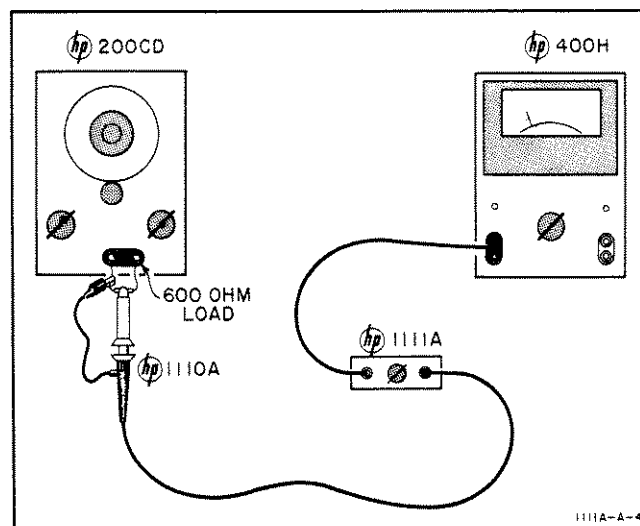

Figure 5-2. Oscillator-Voltmeter Test Setup

Table 5-2. Sensitivity and Accuracy Check

Model 1111A Sensitivity, MA/CM	Voltmeter Range, Volts	Voltmeter Reading, Volts
1	.1	0.1 ±3%
2	.1	0.05 ±3%
5	.03	0.02 ±3%
10	.01	0.01 ±3%
20	.01	0.005 ±3%
50	.003	0.002 ±3%

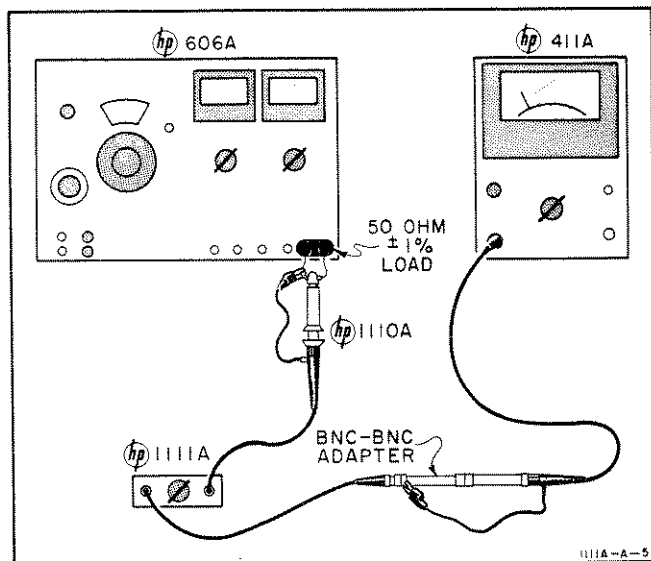

Figure 5-3. Signal Generator - RF Millivoltmeter Test Setup

g. Repeat procedure starting with step b, using appropriate Voltmeter range, and checking other Model 1111A sensitivity ranges.

h. Disconnect test setup. Refer to Figure 5-3 and Table 5-1 and connect test equipment specified, using items 1, 3, 5 and 9.

i. Set Model 1111A sensitivity to 1 MA/CM, X1.

j. Set the Millivoltmeter range to 0.1 volts.

k. Set the Signal Generator frequency to 1 Mc and the output amplitude for a zero db reading on the Millivoltmeter.

m. Set the Signal Generator frequency to 20 Mc.

n. Millivoltmeter reading should be -3 db or greater.

p. Repeat procedure starting with step j, using appropriate Millivoltmeter range, and checking the other Model 1111A sensitivity ranges.

5-9. RISE TIME.

a. Refer to Table 5-1 and Figure 5-4 and connect specified equipment, items 3, 6, and 9. The 50 Ω load is connected to the oscilloscope sync pulse output.

b. Set Oscilloscope MODE to FREE RUN and switch on SYNC PULSE.

c. Set Model 1111A sensitivity to 1 MA/CM, X1.

d. Adjust Oscilloscope and plug-in SENSITIVITY, TIME SCALE and MAGNIFIER controls to display leading edge of pulse.

e. The rise time (between 10% and 90% amplitude points) should be 18 nanoseconds or less.

f. Check other Model 1111A sensitivity ranges for the same rise time specification.

5-10. ADJUSTMENTS.

5-11. AMPLIFIER GAIN SET.

a. Refer to Table 5-1 and Figure 5-2 and connect specified equipment, items 2, 3, 4 and 9.

b. Set Oscillator frequency to 50 Kc.

c. Set Model 1111A sensitivity to 1 MA/CM, X1.

d. Disconnect Voltmeter from Model 1111A output and reconnect Voltmeter across Oscillator output.

e. Set Oscillator output for reading of 0.1 volts.

f. Reconnect Voltmeter to Model 1111A output.

g. Adjust R40 for Voltmeter reading of 0.1 volts.

h. Refer to Table 5-2 to check the Model 1111A output on other sensitivity settings.

5-12. PULSE AND HIGH FREQUENCY RESPONSE.

5-13. The adjustments for pulse and high frequency response will have some interaction, requiring a repeat of the procedure to optimize the performance. When an adjustment affects more than one sensitivity range, a compromise setting may be necessary. The objective for these adjustments is to obtain the best pulse response combination possible; this means best rise time within specifications with least ringing and overshoot.

a. Refer to Table 5-1 and Figure 5-5, and connect specified equipment, items 3, 6, 7, and 8. One additional item is required: a capacitive load, described in Paragraph 5-3. Use a BNC tee connector to connect the capacitive load and oscilloscope probe to the Model 1111A output.

b. Set the Square Wave Generator amplitude control fully clockwise (output approximately 0.5 volts) and frequency control to about 400 kc.

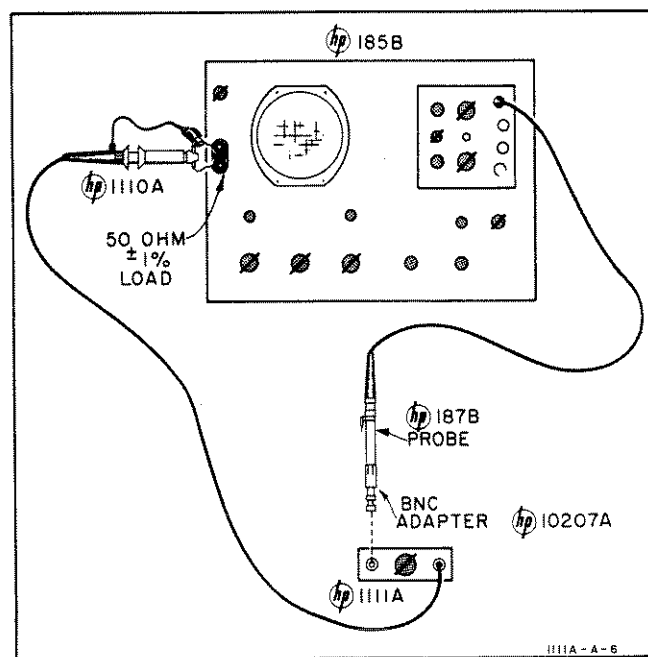

Figure 5-4. Rise Time Check Setup

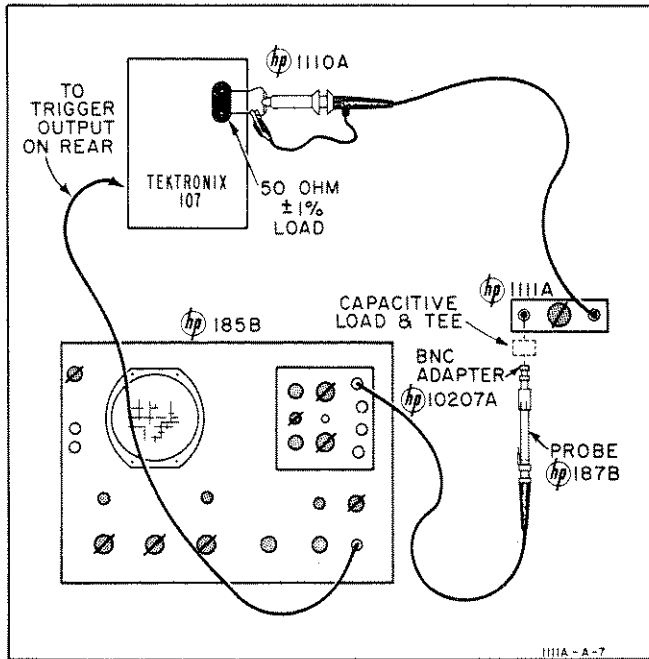

Figure 5-5. Pulse and High Frequency Response Test Setup

- c. Set Model 1111A sensitivity to 1 MA/CM, X1.
- d. Set Oscilloscope and plug-in controls as follows: TIME SCALE to 200 NSEC/CM, TIME SCALE MAGNIFIER to X2, TRIGGER SLOPE to -, SENSITIVITY to 200 MILLIVOLTS/CM, and SCANNING control to INTERNAL.
- e. Adjust controls to obtain a good display of the positive pulse.
- f. Set Pulse Rounding Adjust R14 for best leading edge on square wave.
- g. Adjust C6 for best leading edge.
- h. Set sensitivity control to 2 MA/CM, X1.
- i. Adjust C13 for best leading edge.
- j. Set sensitivity control to 5 MA/CM, X1.
- k. Adjust C12 for best leading edge.
- m. Set sensitivity to 10 MA/CM, X1.
- n. Adjust C11 for best leading edge.
- p. Check pulse response on all ranges, and make compromise readjustments if necessary.

5-14. TROUBLESHOOTING.

5-15. CIRCUIT VOLTAGES.

5-16. The schematic diagram, Figure 5-9, gives typical dc voltages and ac waveforms for troubleshooting. Conditions of measurement are listed on page 5-8.

5-4

5-17. NO OPERATION.

- a. Check ac power.
- b. Be sure X100 attenuator has not inadvertently been switched in.
- c. Check Model 1110A probe separately.
- d. Measure +7.5 and -6.5 volt supplies. If correct proceed to step e; if not proceed to step g.
- e. Check bias voltages within the amplifiers. If biases are considerably off in the input amplifier, check Q1, Q2, Q3, and CR7. Also check for proper switch contacting. If trouble persists, proceed to step f.
- f. If all biases are right, clip the probe on a sinusoidal current of about 60 ma, 50 kc. Set sensitivity to 10 MA/CM, X1. Then trace the signal, using a 10:1 scope probe, from Q3 collector through Q4 and Q5 to the output. (Signal voltages within the input amplifier are small and not significant for troubleshooting. If biases are right, and C4 is good, the input amplifier should work.)

g. If the +7.5 or -6.5 volt supplies are in error, measure total voltage from -6.5 to +7.5 volts with a floating (ungrounded) dc voltmeter. This voltage should be 14 volts \pm 1 volt, and it should not change visibly from 102 to 128 volt ac line voltage. If above 15 volts dc check regulator transistor Q6 and breakdown diode CR10. If below 13 volts, proceed to step h. If between 13 and 15 volts, power supply is operating correctly; proceed to step j.

h. Check unregulated dc voltage across C1 (black and white wires) with a floating (ungrounded) dc voltmeter. At 115 volts ac line, this should read approximately 20 to 30 volts dc. If low, check current through R47 with a dc milliammeter. The current should be about 37 to 50 ma. If above 50 ma, proceed to step k. If below 37 ma, with low unregulated voltage, check transformer, rectifiers, and power cable. If the unregulated voltage is above 35 volts dc, proceed to step i.

i. Check dc current into Q6 emitter. Current should be about 36 ma to 48 ma. If low, and 14 volt supply is still low (from step g), supply regulator is at fault. If high, the load has excessive drain, which must be corrected before the supply will regulate properly. Check filter and bypass capacitors for shorts, and test amplifier transistors.

j. If 14 volt measurement is correct (step g) but -6.5 or +7.5 voltages are wrong, check amplifier transistors Q5 and Q5, then Q3 and Q2. Then check filter and bypass capacitors for shorts.

k. If unregulated voltage is low and current through R47 is high, measure Q6 emitter current, which should be 36 to 48 ma. If emitter current is high, load (amplifier or filter capacitors) is shorted. If low, Q6 or CR10 may be shorted.

5-18. EXCESSIVE SQUARE-WAVE SAG.

- a. Check low-frequency response of Model 1110A probe against its specifications. Clean probe jaw mating surfaces with a pencil eraser for perfect contact.

01862-2

b. Make sure the input impedance of the oscilloscope used with the Model 1111A is about 100K ohms, or sag will result from the output coupling capacitor (0.1 microfarads) in the Model 1111A.

c. If sag persists, clip a 10:1 scope probe on Test Point 1, with the current probe clipped on a square wave peak-to-peak current of approximately 10 times the MC/CM of the range in use. If sag appears here, replace C4. Check power supply capacitors.

d. If sag does not exist at Test Point 1, trace the signal through the resistive divider (on switch), through C18, Q4, and Q5. Check C20 in Q5 collector circuit, and center pin of J2.

5-19. EXCESSIVE SQUARE-WAVE OVERSHOOT.

5-20. This is very unlikely except in cases of transistor replacement. In any case, be sure the trouble is not in the test set-up. See adjustment procedure for calibration method. If excessive overshoot actually is present, carry out the pulse response adjustment procedure fully, for all ranges.

5-21. OUT OF CALIBRATION.

5-22. Use the calibration procedure to be sure the trouble is really due to the Model 1111A. Small variations can be adjusted with R40, but any large discrepancy may be due to a faulty probe, or some amplifier or power supply problem. A check of dc voltages should locate the faulty components.

5-23. REPAIR AND REPLACEMENT.

5-24. COMPONENT LOCATION.

5-25. Figure 5-6, 5-7, and 5-8 identify all the components of the Model 1111A which have reference designators. These components, and those miscellaneous parts having no designators, are listed in Section VI with replacement stock information.

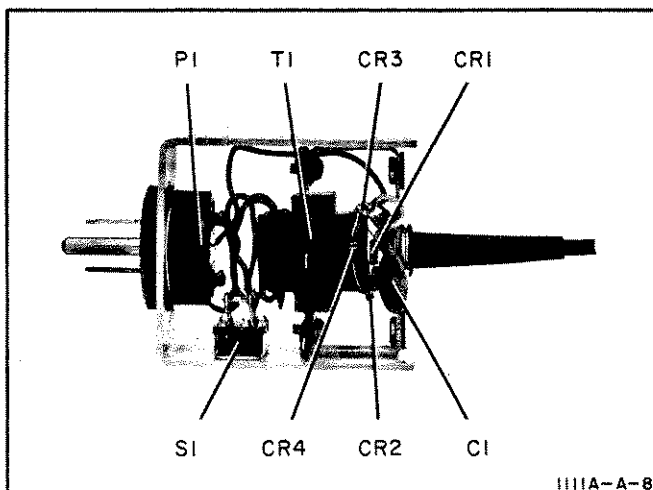

Figure 5-6. Power Supply Assembly

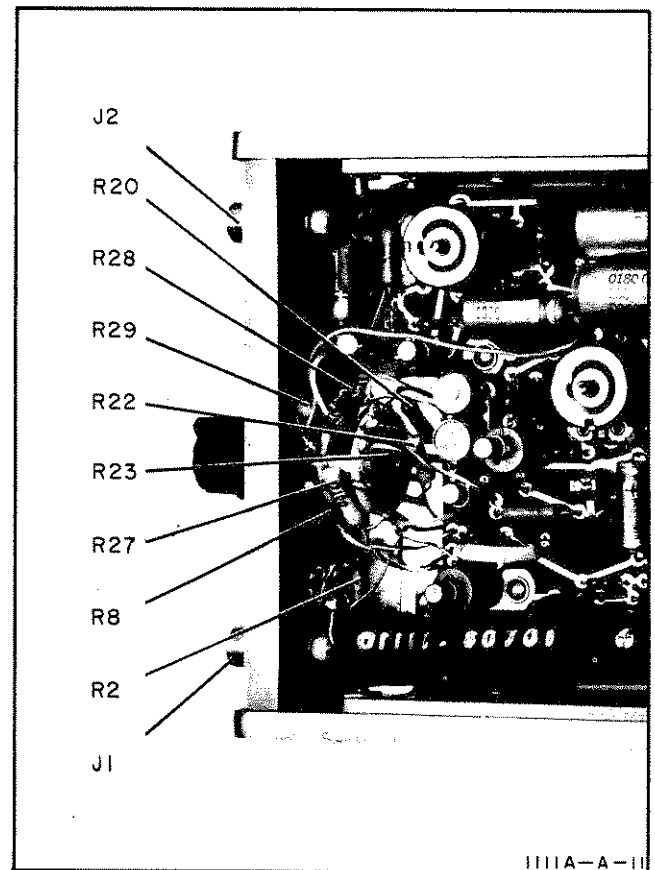

Figure 5-7. Front Panel and Sensitivity Switch Components

5-26. REPLACING ETCHED CIRCUIT BOARD COMPONENTS.

5-27. The etched circuit board, assembly A101, has components on one side of the board and the etched circuit conducting paths on the opposite side. The connection between sides of the board is completed by a plated conductive layer of metal through component holes. Hewlett-Packard Service Note M-20D also contains useful information on etched circuit repair. The important steps and considerations are:

a. Use a low heat (37 to 47.5 watts, less than 800° F idling temperature), slightly bent chisel tip (1/16 to 1/8 inch diameter) soldering iron, and a small diameter, high tin content solder. If a rosin solder is used, clean the area thoroughly after soldering.

b. Components may be removed by placing the soldering iron on the component lead on either side of the board, and pulling up on the lead. If heat is applied to the component side of the board, greater care is required to avoid damage to the component (especially true for diodes). If heat damage may occur, grip the lead with a pair of pliers to provide a heat sink between the soldering iron and component.

c. If a component is obviously damaged or faulty, clip the leads close to the component and then unsolder the leads from the board.

d. Large components such as potentiometers and tube sockets may be removed by rotating the soldering iron from lead to lead and applying steady pressure to lift the part free (the alternative is to clip the leads of a damaged part).

e. Since the conductor part of the etched circuit board is a metal plated surface, covered with solder, use care to avoid overheating and lifting the conductor from the board. A conductor may be cemented back

in place with a quick drying acetate base cement (use sparingly) having good insulating properties. Another method for repair is to solder a section of good conducting wire along the damaged area.

f. Clear the solder from the circuit board hole before inserting a new component lead. Heat the solder in the hole, remove the iron, and quickly insert a pointed non-metallic object, such as a toothpick.

g. Shape the new component leads and clip to proper length. Insert the leads in the holes and apply heat and solder, preferably on the conductor side.

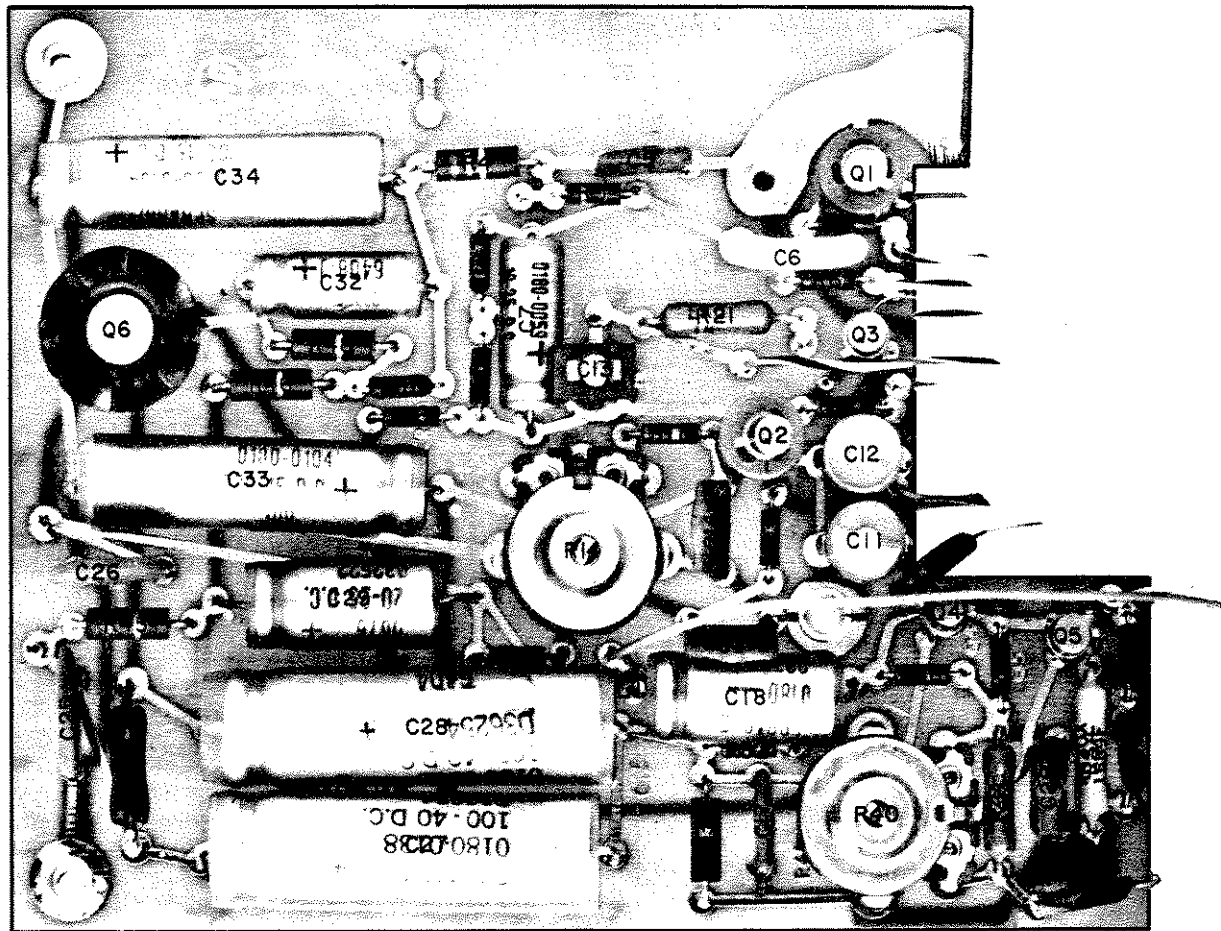

1111A-A-12

Figure 5-8. Etched Circuit Board Components

Table 5-3. Calibration and Component Replacement Record
For Hewlett-Packard Company Model 1111A Current Amplifier

Instrument Serial No. _____

CALIBRATION

Date	Description of Calibration Made	Paragraph Procedure(s) Used

COMPONENT REPLACEMENT

Date	Component Designator	Nature of Failure

CONDITIONS OF MEASUREMENT

DC Measurements

Sensitivity set to: 10 MA/CM, X1.

Waveform Measurements

- a. Sensitivity set to: 10 MA/CM, X1.
- b. For Test Points 1 through 4, clip current probe around wire carrying sinusoidal current of 60 ma, 50 kc.
- c. No input signal for Test Points 5 and 6.

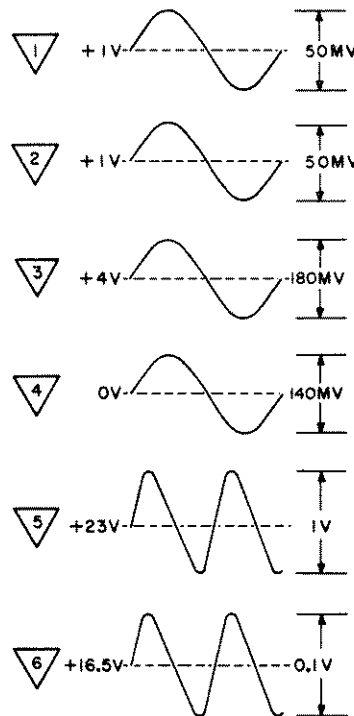

1111A-A-13

- NOTES**
1. UNLESS OTHERWISE INDICATED, ALL VALUES IN OHMS AND MICROFARADS
 2. P/O INDICATES SIGNAL PATH
 3. SHADED AREA INDICATES ETCHED CIRCUIT ASSEMBLY, A2
 4. SWITCH S3 SHOWN FULLY CCW.
 5. WAFERS NUMBERED FROM FRONT PANEL. F = FRONT. R = REAR
 6. SEE FACING PAGE FOR DC VOLTAGE AND WAVEFORM MEASUREMENT CONDITIONS
 7. *DC VOLTAGE +4.99 TO +6.84 VOLTS WHEN R14 IS VARIED BETWEEN LIMITS

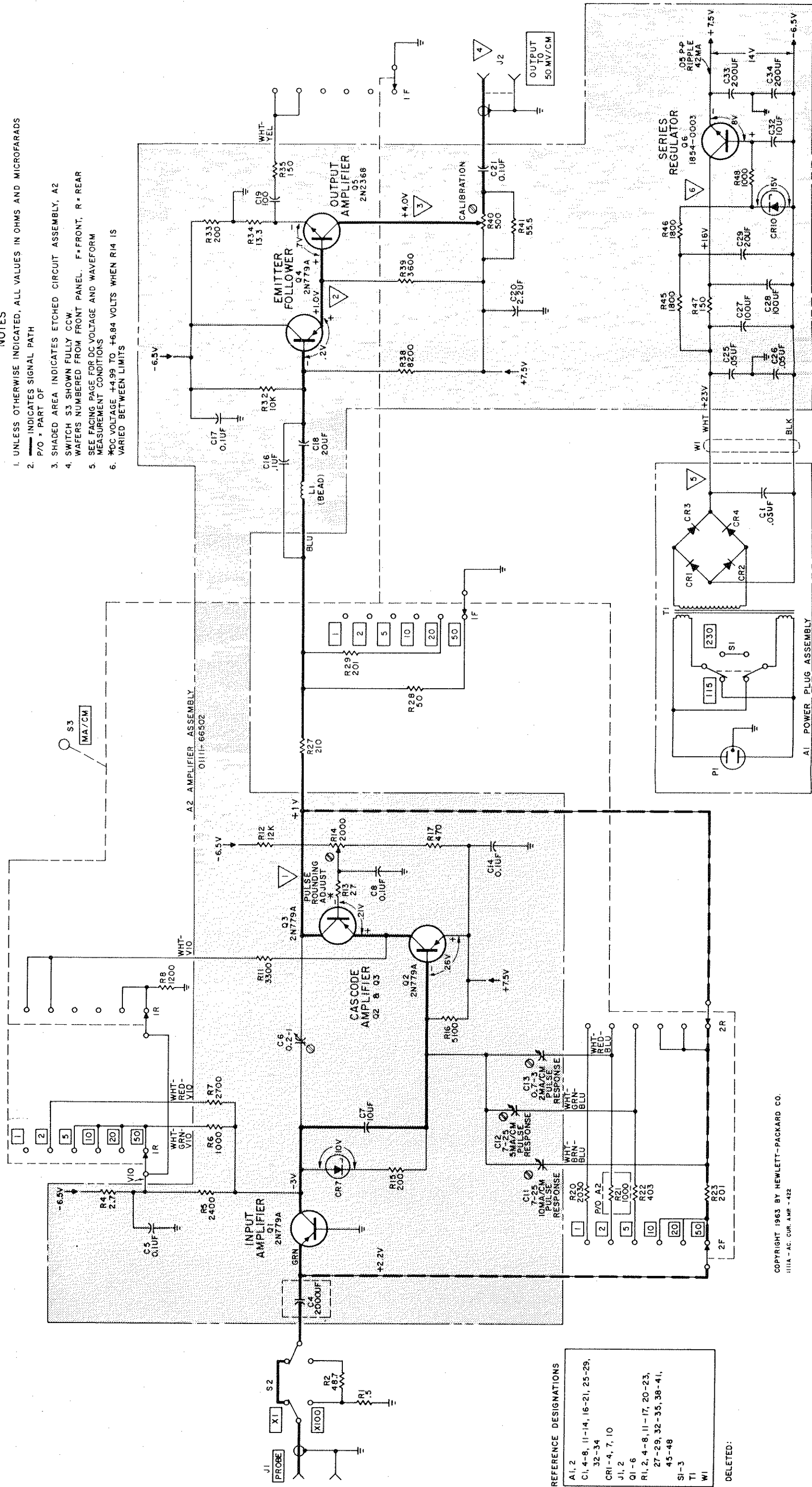

REFERENCE DESIGNATIONS

A1, 2	C1, 4-8, 11-14, 16-21, 25-29, 32-34
CR1-4, 7, 10	J1, 2
Q1-6	R1, 2, 4-8, 11-17, 20-23, 27-29, 32-35, 38-41, 45-48
SI-3	T1
WI	

DELETED:

COPYRIGHT 1963 BY HEWLETT-PACKARD CO.
1111A - AC. CUR. AMP - 422

Figure 5-9. AC Current Amplifier Schematic

SECTION VI REPLACEABLE PARTS

6-1. INTRODUCTION.

6-2. This section contains information for ordering replacement parts. Table 6-1 lists parts in alpha-numerical order of their reference designators and indicates the description and ϕ stock number of each part, together with any applicable notes. Table 6-2 lists parts in alpha-numerical order of their ϕ stock numbers and provides the following information on each part:

- a. Description of the part (see list of abbreviations below).
- b. Typical manufacturer of the part in a five-digit code; see list of manufacturers in appendix.
- c. Manufacturer's stock number.
- d. Total quantity used in the instrument (TQ column).
- e. Recommended spare part quantity for complete maintenance during one year of isolated service (RS column).

6-3. Miscellaneous and cabinet parts not indexed by reference designators are listed at the end of Table 6-1.

6-4. ORDERING INFORMATION.

6-5. To order a replacement part, address order or inquiry either to your nearest Hewlett-Packard field office or to

CUSTOMER SERVICE
Hewlett-Packard Company
395 Page Mill Road
Palo Alto, California

or, in Western Europe, to

Hewlett-Packard S.A.
54 Route des Acacias
Geneva, Switzerland

6-6. Specify the following information for each part:

- a. Model and complete serial number of instrument.
- b. Hewlett-Packard stock number.
- c. Circuit reference designator.
- d. Description.

6-7. To order a part not listed in Tables 6-1 and 6-2, give a complete description of the part and include its function and location.

REFERENCE DESIGNATORS

A = assembly	F = fuse	P = plug	V = vacuum tube, neon bulb, photocell, etc.
B = motor	FL = filter	Q = transistor	W = cable
C = capacitor	J = jack	R = resistor	X = socket
CR = diode	K = relay	RT = thermistor	Y = crystal
DL = delay line	L = inductor	S = switch	Z = network
DS = device signaling (lamp)	M = meter	T = transformer	
E = misc electronic part	MP = mechanical part		

ABBREVIATIONS

A = amperes	F = farads	NC = normally closed	S-B = slow-blow
BP = bandpass	FXD = fixed	NE = neon	SE = selenium
BWO = backward wave oscillator	GE = germanium	NO = normally open	SECT = section(s)
CER = ceramic	GL = glass	NPO = negative positive zero (zero temperature coefficient)	SI = silicon
CMO = cabinet mount only	GRD = ground(ed)	NSR = not separately replaceable	SIL = silver
COEF = coefficient	H = henries	OBD = order by description	SL = slide
COM = common	HG = mercury	OX = oxide	SPL = special
COMP = composition	HR = hour(s)	P = peak	TA = tantalum
CONN = connection	IMPG = impregnated	PC = printed circuit board	TD = time delay
CRT = cathode-ray tube	INCD = incandescent	PF = picofarads = 10^{-12} farads	TI = titanium dioxide
DEPC = deposited carbon	INS = insulation(ed)	PP = peak-to-peak	TOG = toggle
EIA = Tubes or transistors meeting Electronic Industries' Association standards will normally result in instrument operating within specifications; tubes and transistors selected for best performance will be supplied if ordered by ϕ stock numbers.	K = kilo = 1000	PIV = peak inverse voltage	TOL = tolerance
ELECT = electrolytic	LIN = linear taper	POR = porcelain	TRIM = trimmer
ENCAP = encapsulated	LOG = logarithmic taper	POS = position(s)	TWT = traveling wave tube
	MEG = meg = 10^6	POLY = polystyrene	U = micro = 10^{-6}
	M = milli = 10^{-3}	POT = potentiometer	VAC = vacuum
	MINAT = miniature	RECT = rectifier	VAR = variable
	METFLM = metal film	ROT = rotary	W/ = with
	MFR = manufacturer	RMS = root-mean-square	W = watts
	MOM = momentary	RMO = rack mount only	WW = wirewound
	MTG = mounting		W/O = without
	MY = mylar		* = optimum value selected at factory, average value shown (part may be omitted)

01194-7

Table 6-1. Reference Designation Index

Reference Designation	Stock No.	Description #	Note
A1	01111-67601	POWER PLUG ASSEMBLY	
A2	01111-66502	AMPLIFIER ASSEMBLY	
A3	01111-61902	SWITCH ASSEMBLY	
C1	0150-0096	C:FXD CER 0.05 UF 100VDCW	
C2 AND			
C3		NOT ASSIGNED	
C4	01111-80701	ASSY:CAPACITOR 2000 UF	
C5	0150-0121	C:FXD CER 0.1 UF +80-20% 50VDCW	
C6	0180-0059	N.S.R PART OF A2	
C7		C:FXD ELECT 10 UF +100-10% 25VDCW	
C8		C:FXD CER 0.1 UF +80-20% 50VDCW	
C9 AND	0150-0121		
C10		NOT ASSIGNED	
C11	0121-0037	C:VAR CER 7-25 PF N300	
C12	0121-0037	C:VAR CER 7-25 PF N300	
C13	0132-0005	C:VAR POLY 0.7-3.0 PF 350VDCW	
C14	0150-0121	C:FXD CER 0.1 UF +80-20% 50VDCW	
C15		NOT ASSIGNED	
C16	0150-0121	C:FXD CER 0.1 UF +80-20% 50VDCW	
C17	0150-0121	C:FXD CER 0.1 UF +80-20% 50VDCW	
C18	0180-0076	CFXD ELECT 20 UF 25VDCW	
C19	0150-0073	C:FXD CER 100 PF 10% 500VDCW	
C20	0160-0128	C:FXD CER 2.2 UF 20% 25VDCW	
C21	0150-0121	C:FXD CER 0.1 UF +80-20% 50VDCW	
C22 THRU			
C24		NOT ASSIGNED	
C25	0150-0096	C:FXD CER 0.05 UF 100VDCW	
C26	0150-0096	C:FXD CER 0.05 UF 100VDCW	
C27	0180-0138	C:FXD ELECT 100 UF +100-10% 40VDCW	
C28	0180-0138	C:FXD ELECT 100 UF +100-10% 40VDCW	
C29	0180-0049	C:FXD ELECT 20 UF 50VDCW	
C30 THRU			
C31		NOT ASSIGNED	
C32	0180-0059	C:FXD ELECT 10 UF +100-10% 25VDCW	
C33	0180-0104	C:FXD ELECT 200 UF 15VDCW	
C34	0180-0104	C:FXD ELECT 200 UF 15VDCW	
CR1 THRU			
CR4	1901-0025	SEMICON DEVICE:DIODE SILICON	
CR5 AND			
CR6		NOT ASSIGNED	
CR7	1902-0025	SEMICON DEVICE:DIODE ZENER 10V	
CR8 AND			
CR9	1902-0078	NOT ASSIGNED	
CR10		SEMICON DEVICE:DIODE ZENER 14.7V	
J1	1250-0123	CONNECTOR:FEMALE BNC	
J2	1250-0123	CONNECTOR:FEMALE BNC	
L1	9170-0016	SHIELDING BEAD	
P1	1251-0348	PLUG 125VOLT	

= See list of abbreviations in introduction to this section

Table 6-1. Reference Designation Index (Cont'd)

Reference Designation	Stock No.	Description #	Note
Q1 THRU Q4 Q5 Q6	1850-0075 1854-0019 1854-0003	TRANSISTOR:GERMANIUM PNP 2N779A TRANSISTOR:SILICON NPN 2N2368 TRANSISTOR:SILICON NPN	
R1 R2 R3 R4 R5	0727-0899 0721-0028 0699-0001 0683-2425	R:FXD DEPC .5 OHM 2% 1/2W R:FXD DEPC 48.7 OHM 1% 1/8W NOT ASSIGNED R:FXD COMP 2.7 OHM 10% 1/2W R:FXD COMP 2400 OHM 5% 1/4W	
R6 R7 R8 R9 R10	0683-1025 0683-2725 0683-1225 AND	R:FXD COMP 1K OHM 5% 1/4W R:FXD COMP 2.7K OHM 5% 1/4W R:FXD COMP 1.2K OHM 5% 1/4W NOT ASSIGNED	
R11 R12 R13 R14 R15	0683-3325 0683-1235 0683-2705 2100-0090 0683-2015	R:FXD COMP 3.3K OHM 5% 1/4W R:FXD COMP 12K OHM 5% 1/4W R:FXD COMP 27 OHM 5% 1/4W R:VAR COMP 2000 OHM 30% LIN 1/3W R:FXD COMP 200 OHM 5% 1/4W	
R16 R17 R18 R19 R20	0683-5125 0683-4715 AND 0727-0116	R:FXD COMP 5.1K OHM 5% 1/4W R:FXD COMP 470 OHM 5% 1/4W NOT ASSIGNED R:FXD DEPC 2.03K OHM 1% 1/2W	
R21 R22 R23 R24 R27	0727-0100 0727-0072 0727-0055 THRU	R:FXD DEPC 1K OHM 1% 1/2W R:FXD DEPC 403 OHM 1% 1/2W R:FXD DEPC 201 OHM 1% 1/2W NOT ASSIGNED	
R28 R29 R30 R31 R32	0727-0023 0727-0055 AND 0683-1035	R:FXD DEPC 50 OHM 1% 1/2W R:FXD DEPC 201 OHM 1% 1/2W NOT ASSIGNED R:FXD COMP 10K OHM 5% 1/4W	
R33 R34 R35 R36 R37	0686-2015 0727-0709 0683-1515 AND	R:FXD COMP 200 OHM 5% 1/2W R:FXD DEPC 15.4 OHM 5% 1/2W R:FXD COMP 150 OHM 5% 1/4W NOT ASSIGNED	
R38 R39 R40 R41 R42 R44	0683-8225 0683-3625 2100-0151 0727-0031 THRU	R:FXD COMP 8.2K OHM 5% 1/4W R:FXD COMP 3.6K OHM 5% 1/4W R:VAR COMP 500 OHM 20% LIN 2/10W R:FXD DEPC 60 OHM 1% 1/2W NOT ASSIGNED	
R45 R46 R47 R48	0687-1821 0687-1821 0760-0027 0687-1021	R:FXD COMP 1.8K OHM 10% 1/2W R:FXD COMP 1.8K OHM 10% 1/2W R:FXD MET OX 150 OHM 2% 1W R:FXD COMP 1K OHM 10% 1/2W	
S1 S2 S3	3101-0033 3101-0070	SWITCH:SLIDE DPDT(115-230V) SWITCH:SLIDE DPDT N.S.R. PART OF A3	
T1	9100-0183	TRANSFORMER:POWER	

See list of abbreviations in introduction to this section

Table 6-1. Reference Designation Index (Cont'd)

Reference Designation	Stock No.	Description #	Note
W1	01111-61601	CABLE:POWER	
		MISCELLANEOUS	
	5000-0023	BODY:CABINET	
	5000-0101	COVER:CABINET SIDE	
	5060-0213	FRAME:CABINET SIDE	
1205-0011	HEAT SINK		
0370-0104	KNOB: SENSITIVITY		
01111-00201	PANEL		
01111-46101	TERMINAL BOOT-CABLE		

= See list of abbreviations in introduction to this section

Table 6-2. Replaceable Parts

Stock No.	Description #	Mfr.	Mfr. Part No.	TQ
0121-0037	C:VAR CER 7-25 PF N300	28480	0121-0037	2
0132-0005	C:VAR POLY 0.7-3.0 PF 350VDCW	72982	535-031-4R	1
0150-0073	C:FXD CER 100 PF 10% 500VDCW	56289	40C 200A2	1
0150-0096	C:FXD CER 0.05 UF 100VDCW	91418	TA	3
0150-0121	C:FXD CER 0.1 UF +80-20% 50VDCW	56289	5C50A	6
0160-0128	C:FXD CER 2.2 UF 20% 25VDCW	56289	5C15	1
0180-0049	C:FXD ELECT 20 UF 50VDCW	56289	D33909	1
0180-0059	C:FXD ELECT 10 UF +100-10% 25VDCW	56289	300 106G 025	2
0180-0076	C:FXD ELECT 20 UF 25VDCW	56289	400 181 A2	1
0180-0104	C:FXD ELECT 200 UF 15VDCW	56289	300 174 A1	2
0180-0138	C:FXD ELECT 100 UF +100-10% 40VDCW	56289	D36254	2
0370-0104	KNOB: SENSITIVITY	28480	0370-0104	1
0683-1025	R:FXD COMP 1K OHM 5% 1/4W	01121	CB 1025	1
0683-1035	R:FXD COMP 10K OHM 5% 1/4W	01121	CB 1035	1
0683-1225	R:FXD COMP 1.2K OHM 5% 1/4W	01121	CB 1225	1
0683-1235	R:FXD COMP 12K OHM 5% 1/4W	01121	CB 1235	1
0683-1515	R:FXD COMP 150 OHM 5% 1/4W	01121	CB 1515	1
0683-2015	R:FXD COMP 200 OHM 5% 1/4W	01121	CB 2015	1
0683-2425	R:FXD COMP 2400 OHM 5% 1/4W	01121	CB 2425	1
0683-2705	R:FXD COMP 27 OHM 5% 1/4W	01121	CB 2705	1
0683-2725	R:FXD COMP 2.7K OHM 5% 1/4W	01121	CB 2725	1
0683-3325	R:FXD COMP 3.3K OHM 5% 1/4W	01121	CB 3325	1
0683-3625	R:FXD COMP 3.6K OHM 5% 1/4W	01121	CB 3625	1
0683-4715	R:FXD COMP 470 OHM 5% 1/4W	01121	CB 4715	1
0683-5125	R:FXD COMP 5.1K OHM 5% 1/4W	01121	CB 5125	1
0683-8225	R:FXD COMP 8.2K OHM 5% 1/4W	01121	CB 8225	1
0686-2015	R:FXD COMP 200 OHM 5% 1/2W	01121	EB 2015	1
0687-1021	R:FXD COMP 1K OHM 10% 1/2W	01121	EB 1021	1
0687-1821	R:FXD COMP 1.8K OHM 10% 1/2W	01121	EB 1821	2
0699-0001	R:FXD COMP 2.7 OHM 10% 1/2W	01121	EB 27G1	1
0721-0028	R:FXD DEPC 48.7 OHM 1% 1/8W	19701	DC 1/8A	1
0727-0023	R:FXD DEPC 50 OHM 1% 1/2W	19701	DC 1/2C	1
0727-0031	R:FXD DEPC 60 OHM 1% 1/2W	19701	DC 1/2C	1
0727-0055	R:FXD DEPC 201 OHM 1% 1/2W	19701	DC 1/2C	2
0727-0072	R:FXD DEPC 403 OHM 1% 1/2W	19701	DC 1/2C	1
0727-0100	R:FXD DEPC 1K OHM 1% 1/2W	19701	DC 1/2C	1
0727-0116	R:FXD DEPC 2.03K OHM 1% 1/2W	19701	DC 1/2C	1
0727-0709	R:FXD DEPC 15.4 OHM 5% 1/2W	19701	DC 1/2A	1
0727-0899	R:FXD DEPC .5 OHM 2% 1/2W	28480	0727-0899	1
0760-0027	R:FXD MET OX 150 OHM 2% 1W	07115	C32	1
01111-00201	PANEL	28480	01111-00201	1
01111-46101	TERMINAL BOOT-CABLE	28480	01111-46101	1
01111-61601	CABLE:POWER	28480	01111-61601	1
01111-61902	SWITCH ASSEMBLY	28480	01111-61902	1
01111-66502	AMPLIFIER ASSEMBLY	28480	01111-66502	1
01111-67601	POWER PLUG ASSEMBLY	28480	01111-67601	1
01111-80701	ASSY:CAPACITOR 2000 UF	28480	01111-80701	1
1205-0011	HEAT SINK	28480	1205-0011	1
1250-0123	CONNECTOR:FEMALE BNC	91737	UG-1094/U	2

= See list of abbreviations in introduction to this section

Table 6-2. Replaceable Parts (Con't)

Stock No.	Description #	Mfr.	Mfr. Part No.	TQ
1251-0348	PLUG 125 VOLT	02660	160-11	1
1850-0075	TRANSISTOR:GERMANIUM PNP 2N779A	87216	2N779A	4
1854-0003	TRANSISTOR:SILICON NPN	28480	1854-0003	1
1854-0019	TRANSISTOR:SILICON NPN 2N2368	07263	2N2368	1
1901-0025	SEMICON DEVICE:DIODE SILICON	28480	1901-0025	4
1902-0025	SEMICON DEVICE:DIODE ZENER 10V	28480	1902-0025	1
1902-0078	SEMICON DEVICE:DIODE ZENER 14.7V	28480	1902-0078	1
2100-0090	R:VAR COMP 2000 OHM 30% LIN 1/3W	28480	2100-0090	1
2100-0151	R:VAR COMP 500OHM 20% LIN 1/5W	28480	2100-0151	1
3101-0033	SWITCH:SLIDE DPDT (115-230V)	42190	4633	1
3101-0070	SWITCH:SLIDE DPDT	79727	126-B	1
5000-0023	BODY:CABINET	28480	5000-0023	1
5000-0101	COVER:CABINET SIDE	28480	5000-0101	2
5060-0213	FRAME:CABINET SIDE	28480	5060-0213	2
9100-0183	TRANSFORMER:POWER	28480	9100-0183	1
9170-0016	SHIELDING BEAD	28480	9170-0016	1

See introduction to this section

TABLE 6-3. CODE LIST OF MANUFACTURERS

The following code numbers are from the Federal Supply Code for Manufacturers Cataloging Handbooks H4-1 (Name to Code) and H4-2 (Code to Name) and their latest supplements. The date of revision and the date of the supplements used appear at the bottom of each page. Alphabetical codes have been arbitrarily assigned to suppliers not appearing in the H4 handbooks.

Code No.	Manufacturer	Address	Code No.	Manufacturer	Address	Code No.	Manufacturer	Address	Code No.	Manufacturer	Address
00000	U. S. A. Common	Any supplier of U. S.	07263	Fairchild Semiconductor Corp.	Mountain View, Calif.	63743	Ward Leonard Electric	Mt. Vernon, N. Y.	74861	Industrial Condenser Corp.	Chicago, Ill.
00136	McCoy Electronics	Mount Holly Springs, Pa.	07322	Minnesota Rubber Co.	Minneapolis, Minn.	64294	Shallcross Mfg. Co.	Salina, N. C.	74868	R. F. Products Division of Ampheno-	Danbury, Conn.
00234	Humboldt Co.	Colton, Calif.	07700	Technical Wire Products	Springfield, N. J.	55026	Simpson Electric Co.	Chicago, Ill.	74970	E. F. Johnson Co.	Waseca, Minn.
00335	Westrex Corp.	New York, N. Y.	07910	Continental Device Corp.	Hawthorne, Calif.	55953	Sonotone Corp.	Elmsford, N. Y.	75842	International Resistance Co.	Philadelphia, Pa.
00373	Garlock Packing Co., Electronic Products Div.	Canden, N. J. New Bedford, Mass.	07953	Rheem Semiconductor Corp.	Mountain View, Calif.	56137	Spaulding Fibre Co., Inc.	So. Norwalk, Conn.	75173	Jones, Howard B., Division of Cinch Mfg. Corp.	Chicago, Ill.
00656	Aerovox Corp.	Harrisburg, Pa.	07966	Shockley Semi-Conductor Laboratories	Palo Alto, Calif.	56289	Sprague Electric Co.	Tonawanda, N. Y.	75378	James Knights Co.	Sandwich, Ill.
00719	Amp, Inc.	Boonton, N. J.	07980	Boustan Radio Corp.	Boonton, N. J.	59446	Telex, Inc.	St. Paul, Minn.	75382	Kulka Electric Corporation	Mt. Vernon, N. Y.
00818	Aircraft Radio Corp.	Boonton, N. J.	08145	U. S. Engineering Co.	Los Angeles, Calif.	59730	Thomas & Betts Co.	Elizabeth 1, N. J.	75818	Lenz Electric Mfg. Co.	Chicago, Ill.
00815	Northern Engineering Laboratories, Inc.	Burlington, Wis.	08358	Buigess Battery Co.	Niagara Falls, Ontario, Canada.	60741	Tripplett Electrical Inc.	Bluffton, Ohio	75915	Littelfuse Inc.	Des Plaines, Ill.
00853	Sangamo Electric Company, Ordinal Division (Capacitors)	Marion, Ill.	08717	Sloan Company	Burlbank, Calif.	61775	Union Switch and Signal, Div. of Westinghouse Air Brake Co.	Swissvale, Pa.	75905	Lord Mfg. Co.	Erie, Pa.
00866	Goe Engineering Co.	Los Angeles, Calif.	08718	Cannon Electric Co., Phoenix Div.	Phoenix, Ariz.	62119	Universal Electric Co.	Dwssso, Mich.	76210	C. W. Marwedel	San Francisco, Calif.
00895	Carl E. Holmes Corp.	Los Angeles, Calif.	08792	CBS Electronics Semiconductor Operations Div. of C. B. S. Inc.	Lowell, Mass.	63743	Ward-Leonard Electric Co., Inc.	Mt. Vernon, N. Y.	76433	Micamold Electronic Mfg. Corp.	Brooklyn, N. Y.
01121	Allen Bradley Co.	Milwaukee, Wis.	08984	Mel-Rain	Indianapolis, Ind.	64959	Western Electric Co., Inc.	New York, N. Y.	76487	James Millen Mfg. Co., Inc.	Malden, Mass.
01255	Liton Industries, Inc.	Beverly Hills, Calif.	09026	Babcock Relays, Inc.	Costa Mesa, Calif.	65097	Western Inst. Div. of Daystrom, Inc.	Newark, N. J.	76493	J. W. Miller Co.	Los Angeles, Calif.
01281	General Semiconductors, Inc.	Culver City, Calif.	09134	Texas Capacitor Co.	Houston, Texas	65295	Wirtex Manufacturing Co.	Chicago 23, Ill.	76530	Monadnock Mills	San Leandro, Calif.
01295	Texas Instruments, Inc. Transistor Products Div.	Dallas, Texas	09250	Electro Assemblies, Inc.	Chicago, Ill.	66346	Wellenack Optical Co.	Rochester, N. Y.	76545	Mueller Electric Co.	Cleveland, Ohio
01349	The Alliance Mfg. Co.	Alliance, Ohio	09569	Mallory Battery Co. of Canada, Ltd.	Toronto, Ontario, Canada	70209	Allied Control Co., Inc.	Hartford, Conn.	76664	Oak Manufacturing Co.	Crystal Lake, Ill.
01561	Chassis-Trak Corp.	Indianapolis, Ind.	09569	Mallory Battery Co. of Canada, Ltd.	Toronto, Ontario, Canada	70319	Alhmelat Screw Prod. Co., Inc.	New York, N. Y.	76808	Bendix Pacific Division of Bendix Corp.	Mo. Holywood, Calif.
01589	Pacific Relays, Inc.	Van Nuys, Calif.	09564	The Bristol Co.	Waterbury, Conn.	70485	Atlantic India Rubber Works, Inc.	Chicago, Ill.	77075	Pacific Metals Co.	San Francisco, Calif.
01930	Amerock Corp	Rockford, Ill.	10214	General Transistor Western Corp.	Los Angeles, Calif.	70563	Amperite Co., Inc.	New York, N. Y.	77221	Phoastan Instrument and Electronic Co.	South Pasadena, Calif.
01961	Pulse Engineering Co.	Santa Clara, Calif.	10411	Tri-Tal, Inc.	Berkeley, Calif.	70503	Beiden Mfg. Co.	Chicago, Ill.	77250	Phoeil Mfg. Co.	Chicago, Ill.
02114	Ferrocube Corp. of America	Palo Alto, Calif.	10646	Carborundum Co.	Niagara Falls, N. Y.	70998	Bird Electronic Corp.	Cleveland, Ohio	77252	Philadelphia Steel and Wire Corp.	Philadelphia, Pa.
02286	Cole Mfg. Co.	Palo Alto, Calif.	11236	CTS of Berne, Inc.	Berne, Ind.	71002	Birnbach Radio Co.	New York, N. Y.	77342	Potter and Brunfield, Div. of American Machine and Foundry	Pinceton, Ind.
02660	Amphenol-Borg Electronics Corp.	Chicago, Ill.	74237	Chicago Telephone of California, Inc.	So. Pasadena, Calif.	71218	Bud Radio, Inc.	Quincy, Mass.	77630	Radio Condenser Co.	Canden, N. J.
02735	Radio Corp. of America, Semiconductor and Materials Div.	Somerville, N. J.	11532	Microwave Electronics Corp.	Palo Alto, Calif.	71286	Camloc Fastener Corp.	Cleveland, Ohio	77638	Radio Receptor Co., Inc.	Brooklyn, N. Y.
02771	Vocaline Co. of America, Inc.	Old Saybrook, Conn.	11534	Duncan Electronic, Inc.	Santa Ana, Calif.	71313	Allen D. Cardwell Electronic Prod. Corp.	Plainville, Conn.	77754	Resistance Products Co.	Harrisburg, Pa.
02777	Hopkins Engineering Co.	San Fernando, Calif.	11711	General Instrument Corporation Semiconductor Division	Newark, N. J.	71400	Bussmann Fuse Div. of McGraw- Edison Co.	St. Louis, Mo.	78189	Shakeproof Division of Illinois Tool Works	Elgin, Ill.
03508	G. E. Semiconductor Products Dept.	Syracuse, N. Y.	11717	Imperial Electronic, Inc.	Boena Park, Calif.	71435	Chicago Condenser Corp.	Chicago, Ill.	78283	Signal Indicator Corp.	New York, N. Y.
03705	Apex Machine & Tool Co.	Dayton, Ohio	11870	Melabs, Inc.	Palo Alto, Calif.	71450	CTS Corp.	Chicago, Ill.	78290	Struthers-Dunn Inc.	Pittman, N. J.
03747	Eldema Corp.	El Monte, Calif.	12697	Claroast Mfg. Co.	Dover, N. H.	71450	CTS Corp.	Chicago, Ill.	78452	Thompson-Bremer & Co.	Chicago, Ill.
03877	Transistor Electronic Corp.	Wakefield, Mass.	12859	Nippon Electric Co., Ltd.	Tokyo, Japan	71468	Cannam Electronic Co.	Los Angeles, Calif.	78471	Tilley Mfg. Co.	San Francisco, Calif.
03888	Pyrofilm Resistor Co.	Morrisstown, N. J.	12859	Delta Semiconductor, Inc.	Newport Beach, Calif.	71471	Cinema Engineering Co.	Burbank, Calif.	78488	Stackpole Carbon Co.	St. Marys, Pa.
03954	Air Marine Motors, Inc.	Los Angeles, Calif.	13100	Thermatray	Dallas, Texas	71482	C. P. Clare & Co.	Chicago, Ill.	78493	Standard Thomson Corp.	Waltham, Mass.
04009	Aerow, Hart and Hegeman Elect. Co.	Hartford, Conn.	13596	Teleturken (G. M. B. H.) Sem-Tech	Hannover, Germany Newbury Park, Calif.	71590	Centralab Div. of Globe Union Inc.	Chicago, Ill.	78553	Tinnerman Products, Inc.	Cleveland, Ohio
04062	Elmenco Products Co.	New York, N. Y.	14059	Calif. Resistor Corp.	Santa Monica, Calif.	71700	The Cornish Wire Co.	Milwaukee, Wis.	78790	Transformer Engineers	Pasadena, Calif.
04227	H-Q Division of Aerovox	Myrtle Beach, S. C.	14193	American Components, Inc.	Conshohocken, Pa.	71744	Chicago Miniature Lamp Works	New York, N. Y.	78947	Uconite Co.	Newtonville, Mass.
04298	Air National Watch Co., Electronics Division	Burbank, Calif.	14298	Cornell Bubblet Elec. Corp.	So. Plainfield, N. J.	71753	A. G. Smith Corp., Crowley Div.	Chicago, Ill.	79142	Veeder Root, Inc.	Hartford, Conn.
04404	Dymec Division of Hewlett-Packard Co.	Palo Alto, Calif.	14655	The Daven Co.	Livingston, N. J.	71785	Cinch Mfg. Corp.	Chicago, Ill.	79251	Wesco Mfg. Co.	Chicago, Ill.
04651	Sylvania Electric Prods., Inc. Electronic Tube Div.	Mountain View, Calif.	16588	De Jui-Ansco Corporation	Long Island City 1, N. Y.	71984	Dow Corning Corp.	Midland, Mich.	79272	Continental-Wirt Electronics Corp.	Philadelphia, Pa.
04713	Molovia, Inc., Semiconductor Prod. Div.	Phoenix, Arizona	16758	Delco Radio Div. of G. M. Corp.	Kokomo, Ind.	72092	Eitel-McCullough, Inc.	San Bruno, Calif.	79963	Zierick Mfg. Corp.	New Rochelle, N. Y.
04732	Filtrol Co., Inc., Western Div.	Culver City, Calif.	18873	E. I. DuPont and Co., Inc.	Wilmington, Del.	72136	Electro Motive Mfg. Co., Inc.	Williamstic, Conn.	80031	Neppo Division of Sessions Clock Co.	Morrisstown, N. J.
04773	Automatic Electric Co.	Northlake, Ill.	19315	Eclipse Pioneer, Div. of Bendix Aviation Corp.	Westboro, N. J.	72707	Coto Coil Co., Inc.	Providence, R. I.	80120	Schnitzer Alloy Products	Elizabeth, N. J.
04777	Automatic Electric Sales Corp.	Northlake, Ill.	19500	Thomas A. Edison Industries, Div. of McGraw-Edison Co.	West Orange, N. J.	72354	John E. Fast & Co.	Chicago, Ill.	80130	Times Facsimile Corp.	New York, N. Y.
04796	Sequoa Wire & Cable Co.	Redwood City, Calif.	19701	Electra Manufacturing Co.	Kansas City, Mo.	72619	Dialight Corp.	Brooklyn, N. Y.	80131	Electronic Industries Association, tube meeting EIA standards	Washington, D. C.
04870	P. M. Molot Company	Chicago 44, Ill.	20183	Electronic Tube Corp.	Philadelphia, Pa.	72656	General Ceramics Corp.	Keasbey, N. J.	80207	Unimaz Switch, Div. of W. L. Maxson Corp.	Wallingford, Conn.
05006	Twentieth Century Plastics, Inc.	Los Angeles, Calif.	21228	Executive, Inc.	New York, N. Y.	72699	General Instrument Corp., Semiconductor Div.	Newark, N. J.	80223	United Transformer Corp.	New York, N. Y.
05277	Westinghouse Electric Corp., Sem-Conductor Dept.	Youngwood, Pa.	21520	Fanstel Metallurgical Corp.	No. Chicago, Ill.	72758	Guard-Hopkins	Oakland, Calif.	80248	Oxford Electric Corp.	Chicago, Ill.
05347	Ultrason, Inc.	San Mateo, Calif.	21335	The Fafar Bearing Co.	New Britain, Conn.	72785	Drake Mfg. Co.	Chicago, Ill.	80294	Bourns Laboratories, Inc.	Riverside, Calif.
05593	Illuminonic Engineering Co.	Sunnyvale, Calif.	21964	Fed. Telephone and Radio Corp.	Cititron, N. J.	72825	Hugh H. Eby Inc.	Philadelphia, Pa.	80411	Acro Div. of Robertshaw Flaton Controls Co.	Columbus 16, Ohio
05624	Barber Colman Co.	Rockford, Ill.	24446	General Electric Co.	Schenectady, N. Y.	72928	Gudeman Co.	Chicago, Ill.	80486	All Star Products Inc.	Deliance, Ohio
05728	Tiffen Optical Co.	Roslyn Heights, Long Island, N. Y.	24455	G. E., Lamp Division	Nela Park, Cleveland, Ohio	72964	Robert M. Hadley Co.	Los Angeles, Calif.	80583	Hammerland Co., Inc.	New York, N. Y.
05729	Metropolitan Telecommunications Corp., Metro Cap. Division	Brooklyn, N. Y.	24555	General Radio Co.	West Concord, Mass.	72982	Eise Resistor Corp.	Erie, Pa.	80640	Stevens, Arnold, Co., Inc.	Boston, Mass.
05783	Stewart Engineering Co.	Santa Cruz, Calif.	26365	Gries Reproducer Corp.	New Rochelle, N. Y.	73061	Hansen Mfg. Co., Inc.	Princeton, Ind.	81030	International Instruments, Inc.	New Haven, Conn.
06004	The Bassick Co.	Bridgeport, Conn.	26462	Grobet Fire Co. of America, Inc.	Carlsbad, N. J.	73076	N. M. Hesper Co.	Chicago, Ill.	81073	Grayhill Co.	LaGrange, Ill.
06175	Bausch and Lomb Optical Co.	Rochester, N. Y.	26992	Hamilton Watch Co.	Lancaster, Pa.	73138	Helipot Div. of Beckman Instruments, Inc.	Fullerton, Calif.	81095	Triad Transformer Corp.	Venice, Calif.
06402	E. T. A. Products Co. of America	Chicago, Ill.	28480	Hewlett-Packard Co.	Palo Alto, Calif.	73293	Hughes Products Division of Hughes Aircraft Co.	Newport Beach, Calif.	81312	Winchester Electronics Co., Inc.	Newark, Conn.
06555	Beede Electrical Instrument Co., Inc.	Penacook, N. H.	32173	G. E. Receiving Tube Dept.	Owensboro, Ky.	73445	Amperex Electronic Co., Div. of North American Philips Co. Inc.	Newport Beach, Calif.	81349	Military Specification Products, Inc.	Cleveland, Ohio
06751	U. S. Semicor Division of Nuclear Corp. of America	Phoenix, Arizona	35434	Lectrom Inc.	Chicago, Ill.	73506	Bradley Semiconductor Corp.	Hamden, Conn.	81453	Raytheon Mfg. Co., Industrial Components Div., Indus. Tube Operations	Newton, Mass.
06812	Torrington Mfg. Co., West Div.	Van Nuys, Calif.	37942	P. R. Mallory & Co., Inc.	Indianapolis, Ind.	73559	Carling Electric, Inc.	Hartford, Conn.	81541	International Rectifier Corp.	El Segundo, Calif.
07115	Corning Glass Works Electronic Components Dept.	Bradford, Pa.	42190	Meter Co.	Chicago, Ill.	73682	George K. Garrett Co., Inc.	Philadelphia, Pa.	81541	The Airpac Products Co.	Cambridge, Mass.
07126	Digifran Co.	Pasadena, Calif.	43990	C. A. Rogren Co.	Englewood, Colo.	73734	Federal Screw Prod. Co.	Chicago, Ill.	81860	Baty Controls, Inc.	Watertown, Mass.
07137	Transistor Electronics Corp.	Minneapolis, Minn.	44655	Ohmite Mfg. Co.	Skokie, Ill.	73743	Fischer Special Mfg. Co.	Cincinnati, Ohio	82042	Carter Parts Co.	Skokie, Ill.
07138	Westinghouse Electric Corp. Electronic Tube Div.	Elmira, N. Y.	46620	Precision Thermometer and Inst. Co.	Philadelphia, Pa.	73753	The General Industries Co.	Elyria, Ohio	82142	Jeffers Electronics Division of Speer Carbon Co.	Do Bois, Pa.
07261	Avnet Corp.	Los Angeles, Calif.	49956	Raytheon Company	Lexington, Mass.	73905	Jennings Radio Mfg. Co.	San Jose, Calif.	82170	Allen B. DuMont Labs, Inc.	Clifton, N. J.

00015-35
Revised: March 9, 1964

From: F. S. C. Handbook Supplements
H4-1 Dated March 1963
H4-2 Dated March 1962

TABLE 6-3. CODE LIST OF MANUFACTURERS (CONT'D)

Code No.	Manufacturer	Address	Code No.	Manufacturer	Address	Code No.	Manufacturer	Address	Code No.	Manufacturer	Address
82209	Maguire Industries, Inc.	Greenwich, Conn.	88220	Gould-National Batteries, Inc.	St. Paul, Minn.	95228	Continental Connector Corp.	Woodside, N. Y.	THE FOLLOWING H-P VENDORS HAVE NO NUMBER ASSIGNED IN THE LATEST SUPPLEMENT TO THE FEDERAL SUPPLY CODE FOR MANUFACTURERS HANDBOOK.		
82219	Sylvania Electric Prod., Inc.		88698	General Mills, Inc.	Buffalo, N. Y.	95263	Leecraft Mfg. Co., Inc.	New York, N. Y.			
82376	Astron Co.	East Newark, N. J.	89231	Graybar Electric Inc. Co.	Oakland, Calif.	95264	Lercio Electronics, Inc.	Burbank, Calif.			
82389	Switchcraft, Inc.	Chicago, Ill.	89473	General Electric Distributing Corp.	Schenectady, N. Y.	95265	National Coil Co.	Sheridan, Wyo.			
82647	Metals and Controls, Inc., Div. of Texas Instruments, Inc., Spencer Prods.	Attleboro, Mass.	89636	Carter Parts Div. of Economy Baler Co.	Chicago, Ill.	95275	Vitramon, Inc.	Bridgeport, Conn.			
82866	Research Products Corp.	Madison, Wis.	89665	United Transformer Co.	Chicago, Ill.	95348	Gordas Corp.	Bloomfield, N. J.			
82877	Rotron Manufacturing Co., Inc.	Woodstock, N. Y.	90179	U. S. Rubber Co., Mechanical Goods Div.	Passaic, N. J.	95354	Methode Mfg. Co.	Chicago, Ill.			
82895	Vector Electronic Co.	Glendale, Calif.	90970	Bearing Engineering Co.	San Francisco, Calif.	95367	Weckesser Co.	Chicago, Ill.			
83053	Western Washer Mfr. Co.	Los Angeles, Calif.	91260	Common Spring Mfg. Co.	San Francisco, Calif.	96095	Huggins Laboratories	Sunnyvale, Calif.			
83058	Carr Fastener Co.	Cambridge, Mass.	91345	Miller Dial & Nameplate Co.	El Monte, Calif.	96256	Hi-Q Division of Aerovox	Olean, N. Y.			
83086	New Hampshire Ball Bearing, Inc.	Peterborough, N. H.	91418	Radio Materials Co.	Chicago, Ill.	96296	Solar Manufacturing Co.	Los Angeles, Calif.			
83125	Pyramid Electric Co.	Darlington, S. C.	91506	August Brothers, Inc.	Attleboro, Mass.	96330	Cariton Screw Co.	Chicago, Ill.			
83148	Electric Cards Co.	Los Angeles, Calif.	91637	Dale Electronics, Inc.	Columbus, Nebr.	96381	Microwave Associates, Inc.	Burlington, Mass.			
83186	Victory Engineering Corp.	Union, N. J.	91662	Eico Corp.	Philadelphia, Pa.	96501	Excel Transformer Co.	Oakland, Calif.			
83298	Bendix Corp., Red Bank Div.	Red Bank, N. J.	91737	Grenar Mfg. Co., Inc.	Wakefield, Mass.	97454	Industrial Retaining Ring Co.	Livingston, N. J.			
83315	Hubbell Corp.	Mundelein, Ill.	91827	K F Development Co.	Redwood City, Calif.	97539	Automatic and Precision Mfg. Co.	Yonkers, N. Y.			
83330	Smith, Herman H., Inc.	Brooklyn, N. Y.	91929	Minneapolis-Honeywell Regulator Co., Microswitch Div.	Freeport, Ill.	97966	CBS Electronics, Div. of C. B. S., Inc.	Danvers, Mass.			
83385	Central Screw Co.	Chicago, Ill.	92196	Universal Metal Prod., Inc.	Bassett Pointe, Calif.	97979	Reon Resistor Corp.	Yonkers, N. Y.			
83501	Gavitt Wire and Cable Co., Div. of Amerace Corp.	Brookfield, Mass.	92367	Elgeet Optical Co., Inc.	Rochester, N. Y.	98141	Axel Brothers Inc.	Jamaica, N. Y.			
83594	Burroughs Corp., Electronic Tube Div.	Plainfield, N. J.	92697	Tinsclite Insulated Wire Co.	Tarrytown, N. Y.	98159	Rubber Teck, Inc.	Gardena, Calif.			
83740	Eveready Battery	New York, N. Y.	93232	Sylvania Electric Prod., Inc., Semiconductor Div.	Woburn, Mass.	98220	Francis L. Mesley	Pasadena, Calif.			
83777	Model Eng. and Mfg., Inc.	Huntington, Ind.	93369	Robbins and Myers, Inc.	New York, N. Y.	98278	Microdot, Inc.	So. Pasadena, Calif.			
83821	Lloyd Scruggs Co.	Festus, Mo.	93410	Stevens Mfg. Co., Inc.	Mansfield, Ohio	98291	Seafectro Corp.	Hamaroneck, N. Y.			
84171	Arco Electronics, Inc.	New York, N. Y.	93788	Howard J. Smith Inc.	Port Monmouth, N. J.	98405	Carac Corp.	Redwood City, Calif.			
84296	A. J. Glesener Co., Inc.	San Francisco, Calif.	93929	G. V. Controls	Livingston, N. J.	98731	General Mills	Minneapolis, Minn.			
84411	Good All Electric Mfg. Co.	Ogallala, Neb.	93983	Insuline-Van Norman Ind., Inc., Electronic Division	Manchester, N. H.	98821	North Hills Electric Co.	Mineola, N. Y.			
84970	Sarkes Tarzian, Inc.	Bloomington, Ind.	34144	Raytheon Mfg. Co., Industrial Components Div., Receiving Tube Operation	Quincy, Mass.	98925	Clevite Transistor Prod. Div. of Clevite Corp.	Waltham, Mass.			
85454	Boonton Molding Company	Boonton, N. J.	94145	Raytheon Mfg. Co., Semiconductor Div., California Street Plant	Newton, Mass.	98978	International Electronic Research Corp.	Burbank, Calif.			
85471	A. B. Boyd Co.	San Francisco, Calif.	94148	Scientific Radio Products, Inc.	Loveland, Colo.	99109	Columbia Technical Corp.	New York, N. Y.			
85474	R. M. Bracamonte & Co.	San Francisco, Calif.	94154	Tung-Sol Electric, Inc.	Newark, N. J.	99313	Varian Associates	Palo Alto, Calif.			
85660	Koiled Kords, Inc.	New Haven, Conn.	94197	Curtiss-Wright Corp., Electronics Div.	East Paterson, N. J.	99515	Marshall Industries, Electron Products Division	Pasadena, Calif.			
85911	Seamless Rubber Co.	Chicago, Ill.	94222	Southco Div. of S. Chester Corp.	Lesler, Pa.	99707	Control Switch Division, Controls Co. of America	El Segundo, Calif.			
86197	Chifton Precision Products	Citlton Heights, Pa.	94310	Trie Ohm Prod. Div. of Model Engineering and Mfg. Co.	Chicago, Ill.	99800	Delevan Electronics Corp.	East Aurora, N. Y.			
86579	Precision Rubber Products Corp.	Dayton, Ohio	94662	Worcester Pressed Aluminum Corp.	Worcester, Mass.	99848	Wilco Corporation	Indianapolis, Ind.			
86684	Radio Corp. of America, RCA Electronic Tube Div.	Harrison, N. J.	95023	Philbrick Researchers, Inc.	Boston, Mass.	99934	Reinbrandt, Inc.	Boston, Mass.			
87216	Phitico Corporation (Lansdale Division)	Lansdale, Pa.	95236	Alites Products Corp.	Miami, Fla.	99942	Hoffman Semiconductor Div. of Hoffman Electronics Corp.	Evanston, Ill.			
87473	Western Fibrous Glass Products Co.	San Francisco, Calif.				99957	Technology Instrument Corp. of Calif.	Newbury Park, Calif.			
87664	Van Waters & Rogers Inc.	Seattle, Wash.									
88140	Cutler-Hammer, Inc.	Lincoln, Ill.									

00015-35
Revised: March 9, 1964

From: F. S. C. Handbook Supplements
H4-1 Dated March 1963
H4-2 Dated March 1962

HEWLETT-PACKARD SALES AND SERVICE OFFICES IN NORTH AMERICA

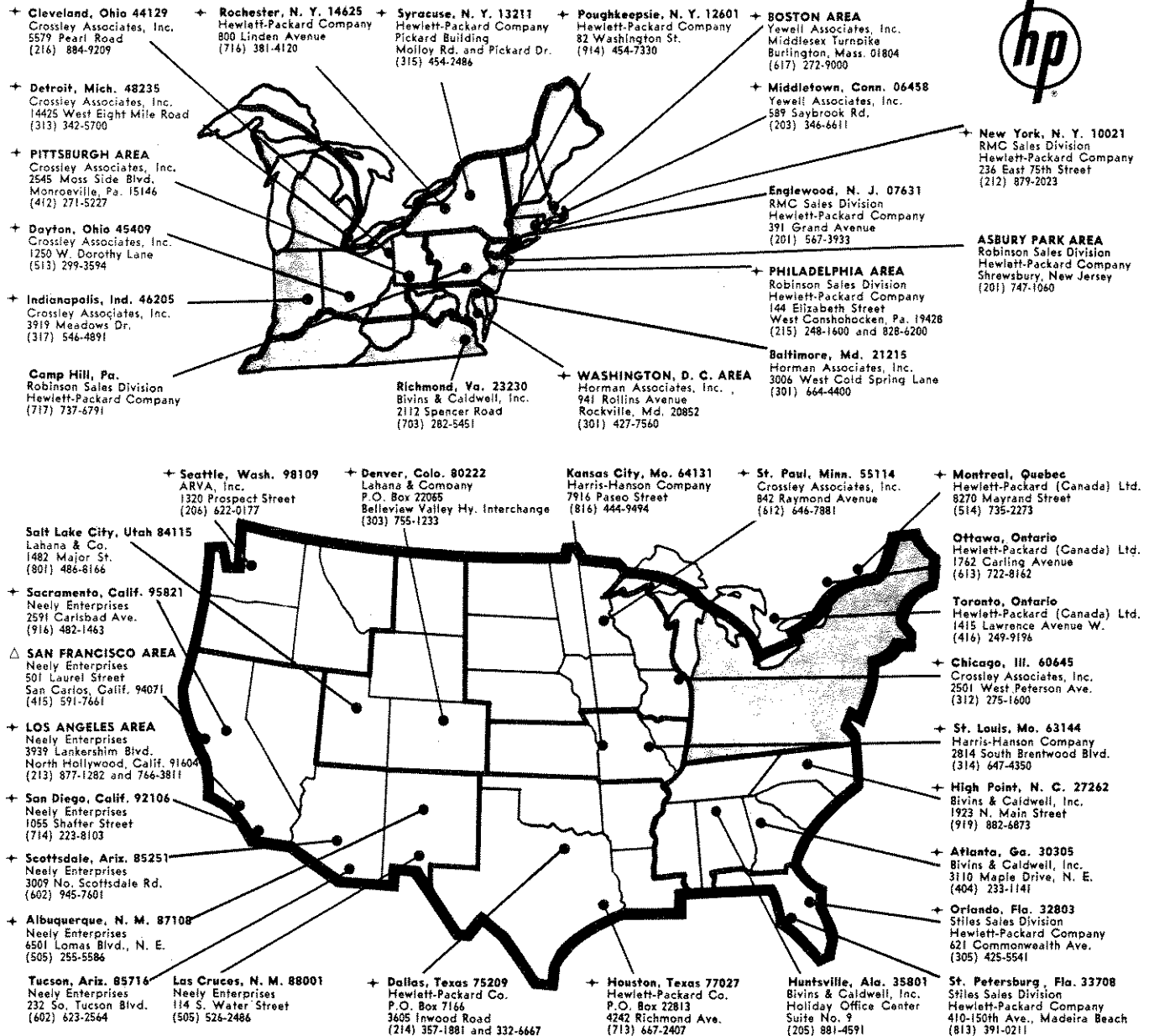

△ For replacement parts and repair services in the San Francisco area, please contact Hewlett-Packard Company, 395 Page Mill Road, Palo Alto, California, Tel: (415) 326-3950.
+ Indicates Instrument Repair Stations.

HEWLETT-PACKARD COMPANY

1501 Page Mill Road • Palo Alto, California 94304
Tel: (415) 326-7000 • TWX: 415-492-9200 • Cable: HEWPACK

DYMEC DIVISION

395 Page Mill Road • Palo Alto, California 94306
Tel: (415) 326-1755 • TWX: 415-492-9363

BOONTON RADIO COMPANY

Green Pond Road • Rockaway, New Jersey 07866
Tel: (201) 627-6400 • Cable: BOONRACO

HARRISON LABORATORIES

41 Industrial Road • Berkeley Heights, N. J. 07922
Tel: (201) 464-1234 • TWX: Summit, N. J.

SANBORN COMPANY

175 Wyman St., Waltham, Mass. 02154
Tel: (617) 894-6300 • TWX: 617-894-0789

F. L. MOSELEY CO.

409 N. Fair Oaks Ave. • Pasadena, Calif. 91102 • Tel: (213) 681-0208 • TWX: PASA CAL 7687 • Cable: MOCOPAS

MARCH 64

AUTHORIZED SALES AND SERVICE OFFICES IN WESTERN EUROPE



HEWLETT-PACKARD S.A.
54 Route des Acacias
Geneva, Switzerland
Telephone: (022) 42.81.50
Telex: 2.24.86
Cable: HEWPACKSA

Sweden
+ H-P Instrument AB
Centralvägen 28
Söna Centrum
Tel: 08-83.08.30

Norway
Morgenstjerne & Co.
+ Wessels Gate 6, Oslo
Tel: 42.99.93

Netherlands
Hewlett-Packard Benelux
+ 23, Burg, Roellstraat, Amsterdam W
Tel: 13 28 98 and 13 54 99

United Kingdom
Hewlett-Packard Ltd.
+ Dallas Road
Bedford, England
Tel: Bedford 68052

Belgium
Hewlett-Packard Benelux
+ 20-24 Rue de l'Hopital, Brussels I
Tel: 11.22.20

France
Hewlett-Packard (France)
+ Boulevard Massena 150
Paris 13e
Tel: 707.97.19

Portugal
TELECTRA
Rua Rodrigo da Fonseca 103
P.O. Box 2531
Lisbon I
Tel: 68 60 72
68 60 73
68 60 74

Spain
ATAIO, Ingenieros
A. Aguilera, No. 8, Madrid 15
Tel: 223.27.42
223.41.71 and 224.84.97

Italy
Dott. Ing. Mario Vianello
+ Via L. Anelli 13, Milan
Tel: 553-081 and 553-811

Via S. Croce in Gerusalemme 97, Rome
Tel: 7.567.250 & 7.567.941

Switzerland
Max Paul Frey
+ Wankdorffstrasse 66, Bern
Tel: (031) 42.00.78

Greece
K. Karayannis
Kliffmonos Square, Athens 124
Tel: 230.301 (5 Lines)

Finland
INTO O/Y
P.O. Box 153
+ II Merihullinkatu, Helsinki
Tel: 66.39.09 and 35.125

Denmark
Tage Olsen A/S
+ Cantungården, Room-133
6D, Vesterbrogade, Copenhagen V.
Tel: Minerva 6838

Germany
Hewlett-Packard V.m.b.H.

Steindamm 35, Hamburg
Tel: 24-05-51

+ Kurhessenstrasse 95
& Frankfurt am Main
Tel: 52.00.36

Reginfriedstrasse 13
8 Munich 9
Tel: 49.51.21

Austria
Hewlett-Packard S.A.
Geneva

Yugoslavia
Belram Electronics
83 Av. des Mimosas
Brussels 15, Belgium
Tel: 35.29.58

Turkey
TELEKOM Engineering Bureau
P.O. Box 376 — Galata
Istanbul
Tel: 49.40.40

Authorized Sales and Service Offices in Other Areas

Argentina
Mauricio A. Suarez
Telecomunicaciones
Carlos Calvo 224, Buenos Aires
Tel: 30-6312

Australia
Sample Electronics Pty. Ltd.
+ 9-11 Cremorne Street
Richmond, E. I., Victoria
Tel: 42-4757 (3 lines)

48 Chippen Street, Sydney
New South Wales
Tel: 69-6338 (6 lines)

FOR SALES AND SERVICE ASSISTANCE IN AREAS NOT LISTED CONTACT:

International Marketing Department
Hewlett-Packard Company
+ 1501 Page Mill Road
Palo Alto, California 94304, U.S.A.
Telephone: (415) 326-7000
TWX: 415-492-9200
Telex: 033811
Cable: HEWPACK

+ Indicates Instrument Repair Stations

India
The Scientific Instrument Company, Ltd.
6, Tej Bahadur Sapru Road, Allahabad I
Tel: 2451

240, Dr. Dadabhai Naoroji Road,
Bombay I
Tel: 26-2642

11, Esplanade East, Calcutta I
Tel: 23-4129

30, Mount Road, Madras 2
Tel: 86339

8-7, Aimeri Gate Extn., New Delhi I
Tel: 271053

Iran
Telecom Ltd.
P.O. Box 1812, Tehran
Tel: 43850, 48111

Israel
Electronics & Engineering Ltd.
+ 16 Kremenetski St., Tel Aviv
Tel: 35021 (3 lines)

Japan
+ Yokogawa-Hewlett-Packard, Ltd.
2-9, Nakacho, Musashino-shi, Tokyo
Tel: Ogikubo (391) 1901
Musashino (0422)-2 3701

Korea
American Trading Company, Korea, Ltd.
Song Bo Building
112-35 Sokong-Dong, Seoul
Seoul P.O. Box 1103
Seoul
Tel: 3-7049, 3-7613

New Zealand
Sample Electronics (N. Z.) Ltd.
8 Matipo Street
Onehunga S. E. 5, Auckland
Tel: 565-361

Puerto Rico & Virgin Islands
San Juan Electronics, Inc.
P.O. Box 5167
Pta. de Tierra Sta., San Juan
Tel: 722-3342, 724-4406

South Africa
F. H. Planter & Co. (Pty.), Ltd.
Rosella House
Buitencingle Street, Cape Town
Tel: 3-3817

Taiwan (Formosa)
Hwa Sheng Electronic Co., Ltd
21 Nanking West Road, Taipei
Tel: 4-6076, 4-5936

**CENTRAL ENGINEERING
INSTRUMENT POOL**



01111-99002

PRINTED IN U.S.

Free Manuals Download Website

<http://myh66.com>

<http://usermanuals.us>

<http://www.somanuals.com>

<http://www.4manuals.cc>

<http://www.manual-lib.com>

<http://www.404manual.com>

<http://www.luxmanual.com>

<http://aubethermostatmanual.com>

Golf course search by state

<http://golfingnear.com>

Email search by domain

<http://emailbydomain.com>

Auto manuals search

<http://auto.somanuals.com>

TV manuals search

<http://tv.somanuals.com>