



**BIPOLAR
POWER SUPPLY/AMPLIFIER
MODELS 6826A AND 6827A**

Valuetronics International, Inc.
1-800-552-8258
MASTER COPY

OPERATING AND SERVICE MANUAL
FOR SERIALS 1317A-00101 AND ABOVE*

*For Serials Above 1317A-00101
a change page may be included.

HEWLETT-PACKARD

SECTION I GENERAL INFORMATION

1-1 DESCRIPTION

1-2 This instruction manual contains operating and service instructions for two Bipolar Power Supply/Amplifiers (Models 6826A and 6827A). The Bipolar Power Supply/Amplifier (BPS/A) is a general purpose instrument useful in any laboratory engaged in the research and development of electronic systems, circuitry, or components. The BPS/A can be operated as a power supply or as an amplifier. Terminals on the rear terminal strip permit access to various internal control points to further expand the operational capabilities of the unit. The resulting flexibility lends the BPS/A to an almost unlimited number of applications. Some of these applications are outlined in Section III of this manual. The following paragraphs describe some of the features of the BPS/A as a power supply and as an amplifier.

1-3 POWER SUPPLY FEATURES

1-4 The unit can be made to function as a regulated dc power supply by setting the front panel MODE switch to the POWER SUPPLY position. The supply can furnish either a Constant Voltage output or Constant Current output. The dc output is bi-polar and is continuously adjustable from its maximum rated positive value to an equal negative continuously through zero. A crossover feature automatically changes the supply from constant voltage to constant current operation at a preset or programmed voltage/current point. The front panel CURRENT MODE indicator lights for constant current operation. Both the supply and the load are protected against overvoltage and overcurrent conditions by internal circuits. Dual output voltage ranges are provided for better resolution. The front panel RANGE switch allows selection of the high (X10) or low (X1) output range.

1-5 The output voltage can be programmed locally using the front panel VOLTAGE control, or remotely, by means of a resistance connected to the appropriate rear terminals. The output current can be programmed locally using the front panel CURRENT control, or remotely, by means of a resistance or voltage source connected to the appropriate rear terminals. The BPS/A can be programmed (controlled) at a very high rate of speed (less than 50 μ sec for output voltage change over the entire voltage span). Local and remote programming connections are described in Section III. The output voltage and current ranges are as follows:

Model 6826A: -5V to +5V at 0 to 1.0A (low range)
-50V to +50V at 0 to 1.0A (high range)
Model 6827A: -10V to +10V at 0 to 0.5A (low range)
-100V to +100V at 0 to 0.5A (high range)

1-6 The BPS/A can sink, as well as source current, permitting it to serve as a variable load device. The BPS/A can sink up to 50% of the rated output current.

1-7 AMPLIFIER FEATURES

1-8 The unit can be made to function as a variable gain or a fixed gain amplifier by setting the MODE switch to the VAR GAIN AMP or FXD GAIN AMP position. When operating as an amplifier, the BPS/A can amplify externally applied ac or dc signals. Variable gain can be controlled locally (VOLTAGE control) or remotely and is accurate to 0.1%. The variable or fixed gain provided is as follows:

Model 6826A:	Variable Gain —	0-2 (low range), 0-20 (high range)
	Fixed Gain —	1X (low range) 10X (high range)
Model 6827A:	Variable Gain —	0-4 (low range), 0-40 (high range)
	Fixed Gain —	2X (low range), 20X (high range)

1-9 The variable gain amplifier is non-inverting and has a frequency response from dc to 15kHz. The fixed gain amplifier is inverting and has a frequency response from dc to 40kHz (6826A) or from dc to 30kHz (6827A). Total harmonic distortion is 0.1% (maximum).

1-10 METERS

1-11 A voltmeter and an ammeter on the front panel monitor the ac or dc output voltage and current respectively. Associated front panel VOLTAGE METER and CURRENT METER switches allow the meters to monitor either an ac or dc output and also provide dual range monitoring capability for better resolution. The dc meter accuracy is $\pm 3\%$ of full scale and the ac meter accuracy is $\pm 5\%$ of full scale.

1-12 SPECIFICATIONS

1-13 Detailed specifications for the two models are given in Table 1-1.

Table 1-1. Specifications, Models 6826A and 6827A

NOTE	
<i>Specifications apply to all models unless otherwise specified.</i>	
GENERAL SPECIFICATIONS	DC Output (Continued):
<p>Input Power: <u>Model 6826A:</u> 104-127/208-254Vac (switchable), 48-63Hz, 1.0A, 130W <u>Model 6827A:</u> 104-127/208-254Vac (switchable), 48-63Hz, 1.2A, 150W</p> <p>Meters: Individual voltage and current meters. DC accuracy is 3% of full scale. AC accuracy is 5% full scale with sinusoidal, 100Hz input.</p> <p>Meter Ranges (DC): <u>Model 6826A:</u> ±6V, ±60V ±0.12A, ±1.2A <u>Model 6827A:</u> ±12V, ±120V ±0.06A, ±0.6A</p> <p>Meter Ranges (AC): <u>Model 6826A:</u> 4V (uncal), 40V rms 0.08A rms, 0.8A rms <u>Model 6827A:</u> 8V (uncal), 80V rms 0.04A rms, 0.4A rms</p> <p>Temperature Ratings: Operating: 0 to 55°C. Storage: -40 to +75°C.</p> <p>Cooling: Convection cooling is employed. The supplies have no moving parts.</p> <p>Dimensions: See outline diagram, Figure 2-1.</p> <p>Weight: 18 lbs. (8.2 kg.) net, 21 lbs. (9.5 kg.) shipping.</p>	<p><u>Model 6827A:</u> X1 Range: -10V to +10V, 0 to 0.5A X10 Range: -100V to +100V, 0 to 0.5A</p> <p>Load Effect (Load Regulation): Voltage load effect is given for a load current change equal to the current rating of the supply. Current load effect is given for a load voltage change equal to the voltage rating of the supply. <u>Model 6826A:</u> Voltage (X1 Range): 0.01% + .5mV Voltage (X10 Range): 0.01% + 1mV Current: .01% + 250µA</p> <p>Load Effect (Load Regulation) Continued: <u>Model 6827A:</u> Voltage (X1 Range): .01% + .3mV Voltage (X10 Range): .01% + 1mV Current: .01% + 250µA</p> <p>Source Effect (Line Regulation): For a change in line voltage between 104 and 127Vac/208 and 254Vac at any output voltage and current within rating. <u>Model 6826A:</u> Voltage (X1 Range): .01% + .5mV Voltage (X10 Range): .01% + 5mV Current: .01% + 250µA <u>Model 6827A:</u> Voltage (X1 Range): .01% + 1mV Voltage (X10 Range): .01% + 10mV Current: .01% + 250µA</p> <p>PARD (Ripple and Noise): Rms/p-p (20Hz to 20MHz) at any line voltage and under any load condition within rating. <u>Model 6826A:</u> Voltage (X1 Range): 2mV rms/10mV p-p Voltage (X10 Range): 6mV rms/35mV p-p Current: .8mA rms/5mA p-p <u>Model 6827A:</u> Voltage (X1 Range): 2.5mV rms/15mV p-p Voltage (X10 Range): 10mV rms/50mV p-p Current: .4mA rms/5mA p-p</p>
POWER SUPPLY SPECIFICATIONS	
<p>DC Output: Voltage and current spans indicate range over which output may be varied. <u>Model 6826A:</u> X1 Range: -5V to +5V, 0 to 1.0A X10 Range: -50V to +50V, 0 to 1.0A</p>	

Table 1-1. Specifications, Models 6826A and 6827A (Continued)

<p>POWER SUPPLY SPECIFICATIONS (Continued)</p> <p>Temperature Coefficient: Output change per degree Centigrade change in ambient following 30 minutes warm-up.</p> <p><u>Model 6826A:</u> Voltage (X1 Range): .01% + .35mV Voltage (X10 Range): .01% + 3mV Current: .02% + 50μA</p> <p><u>Model 6827A:</u> Voltage (X1 Range): .01% + .7mV Voltage (X10 Range): .01% + 6mV Current: .02% + 50μA</p> <p>Drift (Stability): Change in output (dc to 20Hz) over 8 hour interval under constant line, load, and ambient following 30 minutes warm-up.</p> <p><u>Model 6826A:</u> Voltage (X1 Range): .03% + 1mV (Pot wiper jump effect may add 5mV) Voltage (X10 Range): .03% + 10mV (Pot wiper jump effect may add 50mV) Current: .1% + 200μA (Pot wiper jump effect may add 1.5mA)</p> <p><u>Model 6827A:</u> Voltage (X1 Range): .03% + 2mV (Pot wiper jump effect may add 5mV) Voltage (X10 Range): .03% + 20mV (Pot wiper jump effect may add 100mV) Current: .1% + 200μA (Pot wiper jump effect may add 1mA).</p> <p>Load Effect Transient Recovery (Load Transient Recovery): Time required for output voltage recovery to within the specified level of the nominal output voltage following a change in output current equal to the current rating of the supply.</p> <p><u>Model 6826A:</u> 100μsec is required for output voltage recovery within 50mV of nominal output voltage.</p> <p><u>Model 6827A:</u> 100μsec is required for output voltage recovery within 100mV of nominal output voltage.</p> <p>Resolution: Typical output voltage or current change that can be obtained using front panel controls.</p>	<p><u>Model 6826A:</u> Voltage (X1 Range): 10mV Voltage (X10 Range): 100mV Current: 3mA</p> <p><u>Model 6827A:</u> Voltage (X1 Range): 20mV Voltage (X10 Range): 200mV Current: 1.5mA</p> <p>Output Impedance (Typical to 50kHz): Approximated by a resistance in series with an inductance (constant voltage operation).</p> <p><u>Model 6826A:</u> 1mΩ & 1.5μH <u>Model 6827A:</u> 2mΩ & 4μH</p> <p>DC Output Isolation: Supply may be floated at up to 300V above ground.</p> <p>Remote Resistance Programming:</p> <p><u>Model 6826A (Resistance Coefficient):</u> Voltage (X1 Range): 2000Ω/V ± .1% Voltage (X10 Range): 200Ω/V ± .1% Current: 10Ω/mA ± .1%</p> <p><u>Model 6827A (Resistance Coefficient):</u> Voltage (X1 Range): 1000Ω/V ± .1% Voltage (X10 Range): 100Ω/V ± .1% Current: 10Ω/mA ± .1%</p> <p>Remote Programming Speed: 50μsec are required to change between 1% and 99% of the maximum + and - voltage limits.</p> <p>Remote Programming Temperature Coefficient: Output change per degree Centigrade change in ambient using an external control resistor (R_F) at output voltage (V_O) or current (I_O). % T.C. R_F is the temperature coefficient of the control resistance R_F.</p> <p><u>Model 6826A:</u> Voltage (X1 Range): .25mV + .007% (V_O) + % T.C. R_F (V_O + 5) Voltage (X10 Range): 2.2mV + .007% (V_O) + % T.C. R_F (V_O + 50) Current: .016% (I_O) + 33μA + % T.C. R_F (I_O)</p> <p><u>Model 6827A:</u> Voltage (X1 Range): .5mV + .007% (V_O) + % T.C. R_F (V_O + 10) Voltage (X10 Range): 4mV + .007% (V_O) + % T.C. R_F (V_O + 100) Current: .016% (I_O) + 33μA + % T.C. R_F (I_O)</p>
---	--

Table 1-1. Specifications, Models 6826A and 6827A (Continued)

POWER SUPPLY SPECIFICATIONS (Continued)

Sink Current Compliance:

Maximum current that the supply can sink when connected to an active load.

Model 6826A:

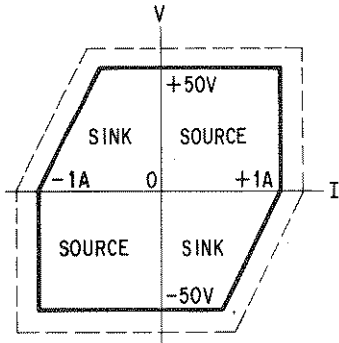

Sink current is limited to a value ranging linearly from 1A @ 0V to .5A @ 50V. Externally applied voltages to output terminals in excess of 60V could damage the instrument.

Model 6827A:

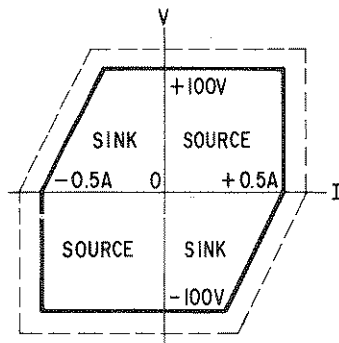

Sink current is limited to a value ranging linearly from .5A @ 0V to .25A @ 100V. Externally applied voltages to output terminals in excess of 125V could damage the instrument.

POWER AMPLIFIER SPECIFICATIONS

Output:

Model 6826A:

Voltage (X1 Range): 10V p-p
Voltage (X10 Range): 100V p-p
Current: 1A peak

Model 6827A:

Voltage (X1 Range): 20V p-p
Voltage (X10 Range): 200V p-p
Current: .5A peak

Voltage Gain (High/Low Range):

Model 6826A:

Fixed Amplifier (Inverting): 10X (high range)/ 1X (low range)
Variable Gain (Non-Inverting): 0-20 (high range)/ 0-2 (low range)

Model 6827A:

Fixed Amplifier (Inverting): 20X (high range)/ 2X (low range)
Variable Gain (Non-Inverting): 0-40 (high range)/ 0-4 (low range)

Frequency Response (+1, -3dB at full output):

Model 6826A:

Fixed Gain: dc - 40kHz
Variable Gain: dc - 15kHz

Model 6827A:

Fixed Gain: dc - 30kHz
Variable Gain: dc - 15kHz

Distortion:

Total harmonic distortion is .1% (maximum) at 100 Hz and full output.

Input Impedance:

10KΩ (Typical)

Fixed Gain Accuracy (at 100Hz):

Model 6826A:

Low Range (X1): .1% + .5mV
High Range (X10): .1% + 5mV

Model 6827A:

Low Range (X1): .1% + 1mV
High Range (X10): .1% + 10mV

Remote Resistance Programming Variable Gain (A_V):

$$A_V = \frac{KR_F}{10.24 \times 10^3 \Omega}, \text{ where K is the constant indicated and } R_F \text{ is the external control resistance.}$$

Model 6826A:

$$A_V \text{ at low range (X1): } \frac{R_F}{10.24 \times 10^3}$$

$$A_V \text{ at high range (X10): } \frac{10R_F}{10.24 \times 10^3}$$

Model 6827A:

$$A_V \text{ at low range (X1): } \frac{2R_F}{10.24 \times 10^3}$$

$$A_V \text{ at high range (X10): } \frac{20R_F}{10.24 \times 10^3}$$

Table 1-1. Specifications, Model s6826A and 6827A (Continued)

<p>Variable Accuracy: Accuracy in high range at 100Hz using an external control resistance (R_F) at output voltage (V_O). % R_F is the accuracy of the control resistance R_F.</p> <p><u>Model 6826A:</u> $(.05\% + \%R_F) V_O + 5mV$ <u>Model 6827A:</u> $(.05\% + \%R_F) V_O + 10mV$</p> <p>Remote Voltage Control Coefficient: Fixed gain amplifier mode, voltage coefficient:</p>	<p><u>Model 6826A:</u> Voltage (X1 Range): 1 volt/volt $\pm .1\%$ Voltage (X10 Range): 10 volts/volt $\pm .1\%$</p> <p><u>Model 6827A:</u> Voltage (X1 Range): 2 volts/volt $\pm .1\%$ Voltage (X10 Range): 20 volts/volt $\pm .1\%$</p> <p>Constant Current, voltage coefficient (the following applies to variable gain amplifier, fixed gain amplifier, and power supply modes of operation): Models 6826A and 6827A: 1 ampere/volt $\pm .5\%$</p>
---	--

1-14 OPTIONS

1-15 Options are customer-requested factory modifications of a standard instrument. The option described below applies to Models 6826A and 6827A.

Option No.	Description
007	<u>Ten-turn Output Voltage Control:</u> Replaces standard single-turn voltage control to allow greater resolution in setting the output voltage in gain of the BPS/A. Shunt resistor A1R53 as well as standard VOLTAGE control (HP Part No. 2100-3272) A5R2 must be removed when the ten-turn output voltage control (HP Part No. 2100-1867) is installed in the A5R2 location.

1-16 ACCESSORIES

1-17 The accessories listed in the following chart may be ordered with the instrument or separately from your local Hewlett-Packard sales office (refer to list at rear of manual for addresses).

HP Part No.	Description
5060-8762	Dual Rack Adapter: Kit for rack mounting one or two supplies in standard 19-inch rack.
5060-8760	Blank Panel: Filler panel to block unused half of rack when mounting only one supply.
11057A	Carrying handle easily attached for portability and handling convenience.
1052A	Combining Case for mounting one or two units in standard 19-inch rack.

5060-0789 Cooling kit for above combining case, 115 Vac, 50-60Hz.

5060-0796 Cooling kit for above combining case, 230 Vac, 50-60Hz.

1-18 INSTRUMENT IDENTIFICATION

1-19 Hewlett-Packard power supplies are identified by a three-part serial number. The first part is the power supply model number. The second part is the serial number prefix, consisting of a number-letter combination denoting the date of a significant design change and the country of manufacture. The first two digits indicate the year (12 = 1972, 13 = 1973, 20 = 1980, etc); the second two digits indicate the week (01 through 52); and the letter "A", "G", "J", or "U" designates the U.S.A., West Germany, Japan, or the United Kingdom, respectively, as the country of manufacture. The third part is the power supply serial number; a different 5-digit sequential number is assigned to each power supply, starting with 00101.

1-20 If the serial number prefix on your unit does not agree with the prefix on the title page of this manual, change sheets supplied with the manual or manual backdating changes in Appendix A define the differences between your instrument and the instrument described by this manual.

1-21 ORDERING ADDITIONAL MANUALS

1-22 One manual is shipped with each instrument. Additional manuals may be purchased from your local Hewlett-Packard field office (see list at rear of this manual for addresses). Specify the model number, serial number prefix, and HP part number shown on the title page.

SECTION II INSTALLATION

2-1 INITIAL INSPECTION

2-2 Before shipment, this instrument was inspected and found to be free of mechanical and electrical defects. As soon as the instrument is received, proceed as instructed in the following paragraphs.

2-3 MECHANICAL CHECK

2-4 If external damage to the shipping carton is evident, ask the carrier's agent to be present when the instrument is unpacked. Check the instrument for external damage such as broken controls or connectors, and dents or scratches on the panel surfaces. If the instrument is damaged, file a claim with the carrier's agent and notify your local Hewlett-Packard Sales and Service Office as soon as possible (see list at rear of this manual for addresses).

2-5 ELECTRICAL CHECK

2-6 Check the electrical performance of the instrument as soon as possible after receipt. Section V of this manual contains performance check procedures which will verify instrument operation within the specifications stated in Table 1-1. This check is also suitable for incoming quality control inspection. Refer to the inside front cover of the manual for the Certification and Warranty statements.

2-7 REPACKAGING FOR SHIPMENT

2-8 To insure safe shipment of the instrument, it is recommended that the package designed for the instrument be used. The original packaging material is reusable. If it is not available, contact your local Hewlett-Packard field office to obtain the materials. This office will also furnish the address of the nearest service office to which the instrument can be shipped. Be sure to attach a tag to the instrument specifying the owner, model number, full serial number, and service required, or a brief description of the trouble.

2-9 INSTALLATION DATA

2-10 The instrument is shipped ready for bench operation. It is necessary only to connect the instrument to a source of power and it is ready for operation.

2-11 LOCATION

2-12 This instrument is convection cooled. Sufficient space should be allotted so that a free flow of cooling air can reach the top and rear of the instrument when it is in operation. It should be used in an area where the ambient temperature remains between 0°C and +55°C.

2-13 OUTLINE DIAGRAM

2-14 Figure 2-1 illustrates the outline shape and dimensions of Models 6826A and 6827A.

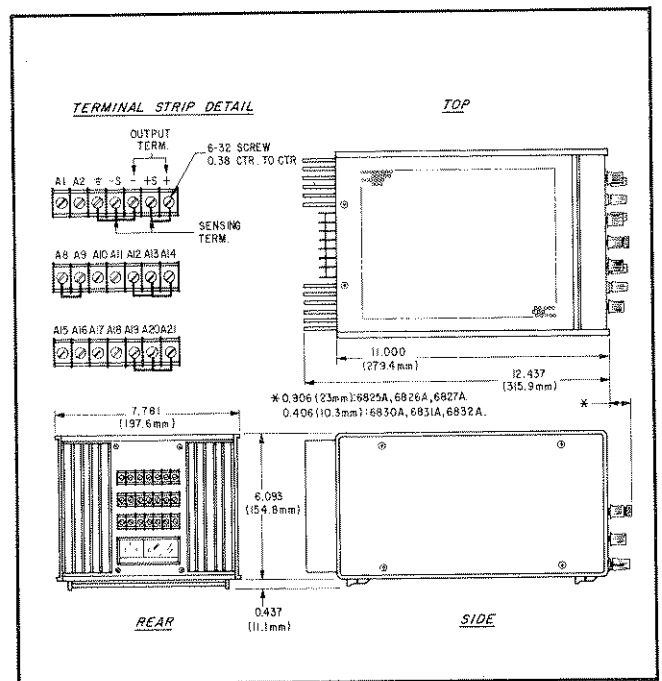

Figure 2-1. Outline Diagram

2-15 RACK MOUNTING

2-16 The Model 6826A and 6827A BPS/A's may be rack mounted using either the dual rack adapter kit or the combining case (with appropriate cooling kit) described in Paragraph 1-16. The necessary installation instructions are provided with the accessories. Refer to Paragraph 5-91 before proceeding with the rack mounting installation instructions.

2-17 INPUT POWER REQUIREMENTS

2-18 Models 6826A and 6827A may be operated continuously from either a nominal 120 volt or 240 volt, 48-63 Hz power source. A two-position selector switch (↓) located within the a-c power module on the rear panel selects the power source. Before connecting the instrument to the power source, check that the selector switch setting matches the nominal line voltage of the source. If required, move the switch to the other position. Note that the power cable must be removed, the plastic door on the power module must be moved aside, the fuse extractor must be pulled outward and the fuse must be removed in order to gain access to the selector switch.

2-19 When the instrument leaves the factory, the proper fuse is installed for 115 volt operation. An envelope containing a fuse for 230 volt operation is attached to the instrument. Make sure that the correct fuse is installed if the

position of the slide switch is changed (2A for 115 volt operation, and 1A for 230 volt operation).

2-20 POWER CABLE

2-21 To protect operating personnel, the National Electrical Manufacturers' Association (NEMA) recommends that the instrument panel and cabinet be grounded. This instrument is equipped with a three conductor power cable. The third conductor is the ground conductor and when the cable is plugged into an appropriate receptacle, the instrument is grounded. The offset pin on the power cable's three-prong connector is the ground connection.

2-22 To preserve the protection feature when operating the instrument from a two-contact outlet, use a three-prong to two-prong adapter and connect the green lead on the adapter to ground.

SECTION III OPERATING INSTRUCTIONS

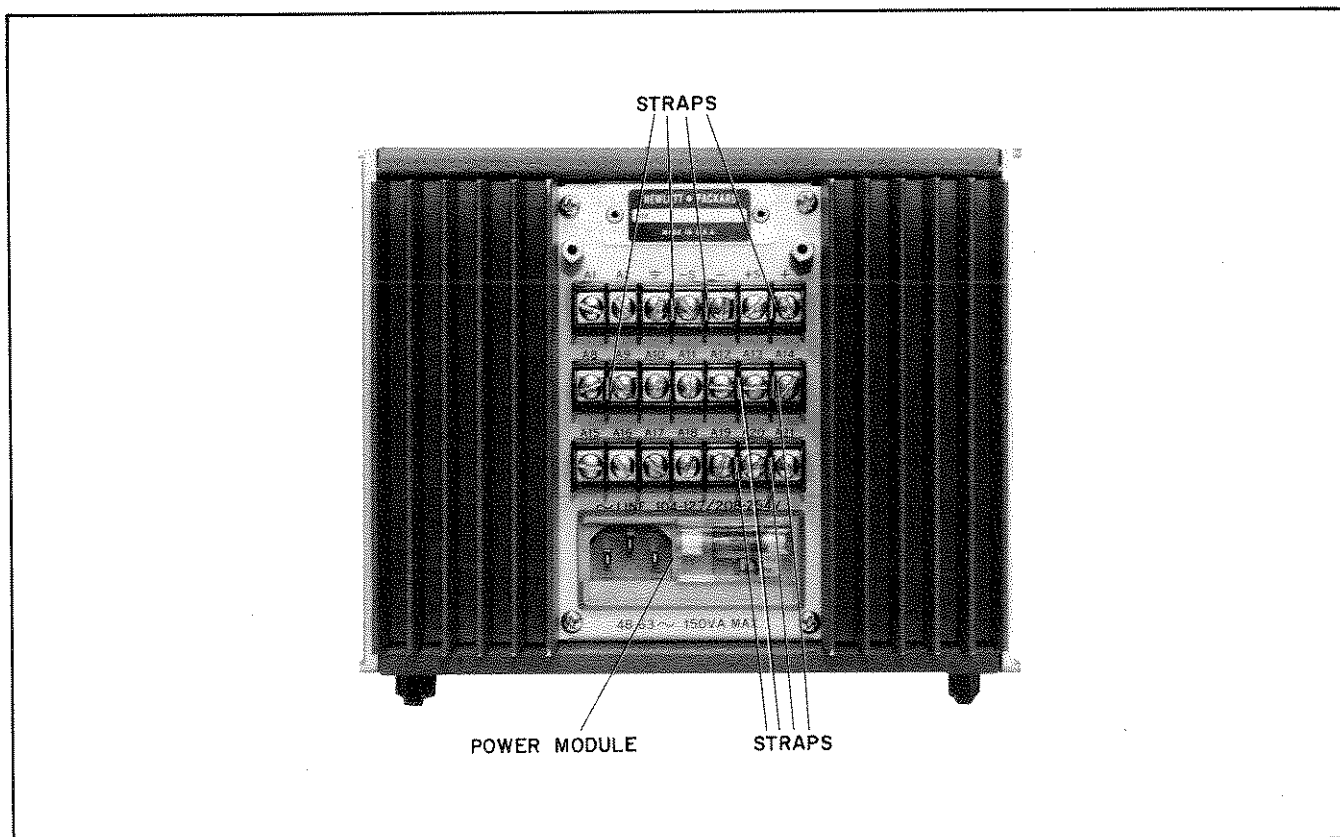

Figure 3-1. Bipolar Power Supply/Amplifier, Models 6826A and 6827A, Rear View

3-1 INTRODUCTION

3-2 This section describes the operating controls and indicators, the turn-on checkout sequence, and operating modes of Bipolar Power Supply/Amplifier (BPS/A) models 6826A and 6827A. Local and remote programming operations are also described.

3-3 REAR TERMINALS AND AC INPUT

3-4 The Bipolar Power Supply/Amplifier (BPS/A) is shipped with the rear terminals strapped for local programming (using front panel controls) as shown in Figure 3-1. Remote programming strapping requirements are described in subsequent paragraphs. The power module contains fuse F1 (2A for 115Vac or 1A for 230Vac) and a slide switch for connecting 115Vac or 230Vac input power to the instrument. To turn on the BPS/A, set the LINE switch (item ①, Figure 3-2) to ON. The LINE ON indicator ②

should light. Fuse F1 protects the main power supply. At initial turn-on, an internal circuit protects any loads connected to the BPS/A from turn-on transients by shorting the output terminals and disabling the BPS/A's power output circuits. This circuit operates similarly at turn-off to protect any loads from turn-off transients.

3-5 OPERATING CONTROLS AND INDICATORS

3-6 MODE SWITCH

3-7 The MODE switch ③ allows the BPS/A to operate as a power supply, variable gain amplifier, or a fixed gain amplifier. In the power supply operation, the BPS/A provides a variable bipolar dc output voltage dependent upon the RANGE switch ④ and VOLTAGE control ⑤ settings. The dc output voltage ranges are as follows:

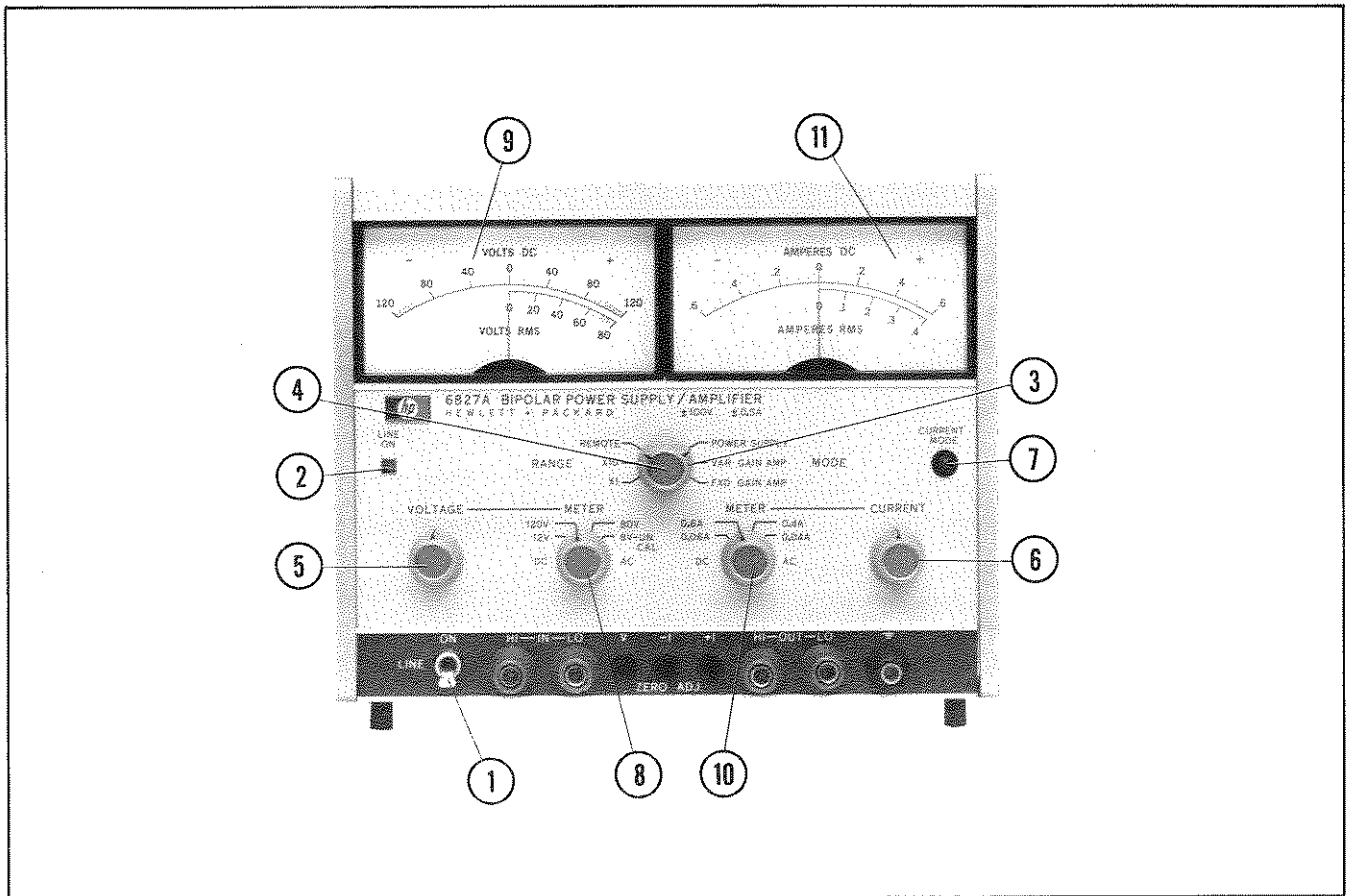

Figure 3-2. Operating Controls and Indicators

MODEL	DC OUTPUT VOLTAGE	
	HIGH RANGE	LOW RANGE
6826A	-50V to +50V	-5V to +5V
6827A	-100V to +100V	-10V to +10V

3-8 In variable gain amplifier operation, the BPS/A can amplify or attenuate an external input signal (dc to 15kHz) applied to the HI and LO IN terminals. The gain is variable from 0 to a maximum depending upon the RANGE switch (4) and VOLTAGE control (5) settings. The variable gain ranges are as follows:

MODEL	VARIABLE VOLTAGE GAIN	
	HIGH RANGE	LOW RANGE
6826A	0-20	0-2
6827A	0-40	0-4

3-9 In fixed gain amplifier operation, the BPS/A inverts

and amplifies an external input signal applied to the HI and LO IN terminals. For fixed gain amplifier operation, the 6826A has a frequency response from DC to 40kHz and the 6827A has a frequency response from DC to 30kHz. The fixed voltage gain provided in the high or low output range is as follows:

MODEL	FIXED VOLTAGE GAIN	
	HIGH RANGE	LOW RANGE
6826A	X10	X1
6827A	X20	X2

3-10 RANGE SWITCH

3-11 The RANGE switch (4) allows selection of the high (X10) or low (X1) output ranges for power supply, variable gain amplifier, or fixed gain amplifier operation. The REMOTE position allows the high or low range to be externally selected via the rear terminal strip (see Paragraph 3-45).

3-12 VOLTAGE CONTROL

3-13 The VOLTAGE control (5) controls the output level (power supply operation) or gain (variable gain amplifier operation) of the BPS/A. In power supply operation, the VOLTAGE control varies the output voltage from a maximum negative value (full counterclockwise) through zero (midposition) to a maximum positive value (full clockwise). In variable gain amplifier operation, the gain is variable from zero to the maximum gain as the VOLTAGE control is varied from full counterclockwise to full clockwise. In fixed gain amplifier operation, the VOLTAGE control does not control circuit operation.

3-14 CURRENT CONTROL

3-15 The CURRENT control (6) sets the constant current output of the BPS/A. This control is operable in all three modes of operation (power supply, variable gain amplifier, and fixed gain amplifier) and controls the output current from 0 to the maximum rated output (1.0A for the 6826A and 0.5A for the 6827A). When the instrument switches from constant voltage to constant current operation, the CURRENT MODE indicator (7) lights. Selection of constant voltage or constant current operation is described in Paragraphs 3-27 and 3-28.

3-16 VOLTAGE METERING

3-17 The VOLTAGE METER switch (8) permits monitoring the DC or AC output voltage on voltmeter (9). The shaded area on the voltmeter face indicates the amount of output voltage that is available in excess of the normal rated output. The voltmeter upper scale reads the bipolar DC voltage from a maximum negative value through 0V to a maximum positive value, DC accuracy is $\pm 3\%$ of full scale. The lower scale reads the RMS output voltage from 0 to a maximum level. AC accuracy is $\pm 5\%$ of full scale. The voltmeter ranges selected by the VOLTAGE METER switch are as follows:

MODEL	VOLTMETER RANGES	
	DC	AC (RMS)
6826A	0 to $\pm 6V$, 0 to $\pm 60V$	0-4V (uncal), 0-40V
6827A	0 to $\pm 12V$, 0 to $\pm 120V$	0-8V (uncal), 0-80V

3-18 CURRENT METERING

3-19 The CURRENT METER switch (10) permits monitoring the DC or AC output current on ammeter (11). The shaded area on the ammeter face indicates the amount of output current that is available in excess of the normal

rated output. The ammeter upper scale reads the bipolar DC current from a maximum negative value through 0A to a maximum positive value. DC accuracy is $\pm 3\%$ of full scale. The lower scale reads the RMS output current from 0 to a maximum level. AC accuracy is $\pm 5\%$ of full scale. The ammeter ranges selected by the CURRENT METER switch are as follows:

MODEL	AMMETER RANGES	
	DC	AC (RMS)
6826A	0 to $\pm 0.12A$, 0 to $\pm 1.2A$	0 to 0.08A, 0 to 0.8A
6827A	0 to $\pm 0.06A$, 0 to $\pm 0.6A$	0 to 0.04A, 0 to 0.4A

3-20 TURN-ON CHECKOUT PROCEDURES

CAUTION

Rear terminal strip cover must be in place when Instrument is in use. Also, the Local/Auto switch, located inside the unit on board A2 (see Figure 3-9), is in the Local position (toward rear of unit) as shipped from the factory. The Local position is used for normal operations. The Auto position is used only for auto-series and auto-parallel operations (see Paragraphs 3-57 through 3-61). If the switch is placed in the Auto position for normal operations, the BPS/A output voltage could latch up (maximum positive or negative output).

3-21 The following turn-on and checkout procedures are performed utilizing the front panel controls (Figure 3-2) and the normal rear terminal strapping connections as received from the factory.

POWER SUPPLY CHECKOUT PROCEDURE

- Set front panel controls as follows:
 MODE switch (3) – POWER SUPPLY
 RANGE switch (4) – X1
 VOLTAGE control (5) – midposition
 CURRENT control (6) – full clockwise
 VOLTAGE METER switch (8) – low range DC
 CURRENT METER switch (10) – high range DC
- Set LINE switch (1) to ON and observe that LINE ON indicator (2) lights.
- Adjust VOLTAGE control (5) from full counterclockwise (–) to full clockwise (+) range through 0V and note that maximum output is attained as indicated on meter (9).
- Set VOLTAGE-METER switch (8) to high range DC and RANGE switch (4) to X10 position.
- Adjust VOLTAGE control (5) clockwise and counterclockwise through entire bipolar output voltage

range through 0 and note that maximum output is attained as indicated on meter ⑨. Adjust output voltage to +50V.

f. To checkout the constant current circuit, first turn off BPS/A. Short circuit the front panel terminals (HI OUT to LO OUT).

g. Turn on supply and observe that CURRENT MODE indicator ⑦ lights and meter ⑨ indicates 0 volts.

h. Adjust CURRENT control ⑥ from full cw to full ccw and note that minimum current is attained as indicated on meter ⑪.

i. Turn off supply and remove short from output terminals.

j. Turn on supply and adjust VOLTAGE CONTROL ⑤ for an output of -50V.

k. Turn off supply and reconnect short across the HI and LO OUT terminals.

l. Turn on supply and note that CURRENT MODE indicator ⑦ lights and meter ⑨ indicates 0 volts.

m. Adjust CURRENT control ⑥ from full cw to full ccw and note that minimum current is attained as indicated on meter ⑪.

n. Turn off BPS/A and remove short from output terminals.

VARIABLE GAIN AMPLIFIER CHECKOUT PROCEDURE

o. Set front panel controls as follows:

MODE switch ③ - VAR GAIN AMP

RANGE switch ④ - X1

VOLTAGE control ⑤ - midposition

CURRENT control ⑥ - full clockwise

VOLTAGE METER switch ⑧ - low range AC

CURRENT METER switch ⑩ - high range AC

p. Connect a 1.75V rms, 100Hz input signal to the front panel input terminals (HI and LO IN).

q. Turn on supply and adjust VOLTAGE control ⑤ through entire RMS range and note that maximum voltage is attained as indicated on meter ⑨.

r. Set VOLTAGE METER switch ⑧ to high range AC, RANGE switch ④ to X10, and adjust VOLTAGE control ⑤ through entire RMS range and note that maximum voltage is attained as indicated on meter ⑨.

FIXED GAIN AMPLIFIER CHECKOUT PROCEDURES

s. Set MODE switch ③ to FXD GAIN AMP position and increase input signal to 3.5V rms.

t. Adjust VOLTAGE control ⑤ through entire RMS range and note that maximum voltage is attained as indicated on meter ⑨.

3-22 OPERATING MODES

CAUTION

Rear terminal strip cover must be in place when instrument is in use.

3-23 The position of the front panel MODE switch determines whether the instrument will be used as a power supply or an amplifier. In addition, the instrument may be controlled locally using the front panel VOLTAGE and CURRENT controls or remotely via terminals on the rear of the unit. The front panel output terminals (HI and LO OUT) and input terminals (HI and LO IN) are repeated as (+ and -) and (A1 and A2) respectively on the rear terminal strip. The rear terminal strip includes sensing (+S and -S) terminals and other terminals for remote control of the BPS/A as shown in Figure 3-3. These terminals connect to various control points within the instrument and allow strapping connections to be made which enable the power supply or amplifier to be utilized in many applications. The following paragraphs describe the procedures for utilizing the various operational capabilities of the power supply. A more theoretical description concerning the operational features of this supply is contained in Application Note 90 and in various Tech. Letters. Copies of these can be obtained from your local Hewlett-Packard field office.

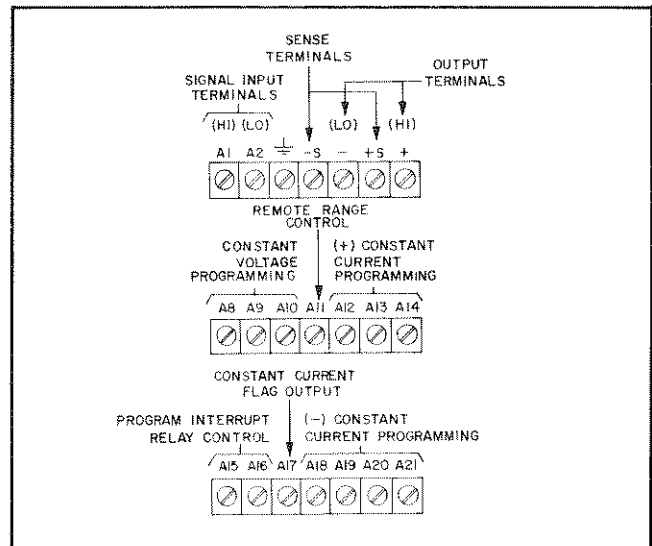

Figure 3-3. Rear Terminal Strip

3-24 LOCAL PROGRAMMING

3-25 The BPS/A is shipped with its rear terminal strapping connections arranged for constant voltage/constant current, local programming, local sensing, single unit mode of operation. This strapping pattern is illustrated in Figure 3-4. Also, the Local/Auto switch on board A2 (see Paragraph 3-54) is in the Local position when the instrument is shipped from the factory. This switch must be in the Local position for single unit mode of operation.

3-26 The operator selects either power supply, variable gain amplifier, or fixed gain amplifier operation (MODE

switch) and also selects either constant voltage or a constant current output using the front panel VOLTAGE and CURRENT controls (for local programming, no strapping changes are required). Constant voltage or constant current operation are selected as described in the following paragraphs.

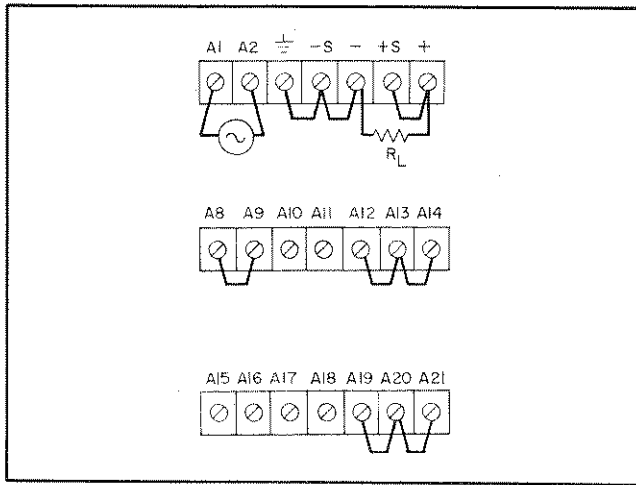

Figure 3-4. Normal Strapping Pattern (LOCAL Programming)

3-27 Constant Voltage. To select a constant voltage output, proceed as follows:

- a. Remove load from output terminals; turn-on supply and adjust VOLTAGE control for desired output voltage.
- b. Short output terminals and adjust CURRENT control for maximum output current allowable (current limit) as determined by load conditions and voltage range selected in step (a). If a load change takes place and causes the output current to exceed this setting, the power supply will automatically crossover to constant current mode and output current will be constant at the level set by the CURRENT control. The CURRENT MODE indicator will come on and output voltage will drop proportionately to maintain constant current.

3-28 Constant Current. To select a constant current output, proceed as follows:

- a. Short output terminals and adjust CURRENT control for desired output current.
- b. Open output terminals and adjust VOLTAGE control for maximum output voltage allowable as determined by load conditions and current selected in step (a). If a load change causes the voltage to rise, the power supply will automatically crossover to constant voltage at the voltage setting and output current will drop proportionately.

3-29 OPERATION OF SUPPLY BEYOND RATED OUTPUT

3-30 The shaded area on the front panel meters indicate

the amount of output voltage and current that is available in excess of normal rated output. Although, the BPS/A can be operated in this region without damage, it cannot be guaranteed to meet all of its performance specifications.

3-31 REACTIVE LOAD CONSIDERATIONS

3-32 The life and performance of the instrument can be preserved if the following simple precaution is observed when driving reactive loads. Always set/program the VOLTAGE control for zero output before removing a capacitive load or interrupting an inductive load.

3-33 CONNECTING LOAD

3-34 Each load should be connected to the power supply output terminals (front or rear) using separate pairs of connecting wires. This will minimize mutual coupling effects between loads and will retain full advantage of the low output impedance of the power supply. Each pair of connecting wires should be as short as possible and twisted or shielded to reduce noise pickup. (If a shielded pair is used, connect the shield to ground at the power supply and leave the other end unconnected.)

3-35 If load considerations require that the output power distribution terminals be remotely located from the power supply, then the power supply output terminals should be connected to the remote distribution terminals via a pair of twisted or shielded wires and each load should be separately connected to the remote distribution terminals. For this case, remote sensing should be used. (Refer to Paragraph 3-39).

3-36 Always use two leads to connect the load to the supply, regardless of where the setup is grounded. This will eliminate any possibility of output current return paths through the power source ground. The supply can also be operated up to 300Vdc above ground if neither output terminal is grounded.

3-37 REMOTE SENSING

3-38 Remote sensing is used to maintain good regulation at the load and reduce the degradation of regulation which would occur due to the voltage drop in the leads between the power supply and the load. Remote sensing is accomplished by utilizing the strapping pattern shown in Figure 3-5. The power supply should be turned off before changing strapping patterns. The leads from the sensing ($\pm S$) terminals to the load will carry much less current than the load leads and it is not required that these leads be as heavy as the load leads. However, they must be twisted or shielded to minimize noise pickup.

CAUTION

Observe polarity when connecting sense leads to the load.

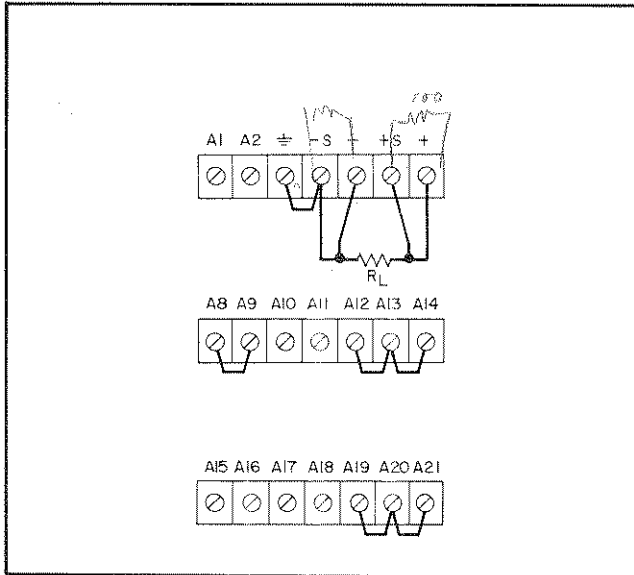

Figure 3-5. Remote Load Sensing

3-39 For reasonable load lead lengths, remote sensing limits degradation of the performance of the supply. However, if the load is located a considerable distance from the supply, added precautions must be observed to obtain satisfactory operation. Notice that the voltage drop in the load leads subtracts directly from the available output voltage. Because of this, it is recommended that the drop in each load lead not exceed 1.0 volt. If a larger drop must be tolerated, please consult an HP Sales Engineer.

NOTE

Due to the voltage drop in the load leads, it may be necessary to readjust the constant current crossover limit setting in the remote sensing mode.

3-40 REMOTE PROGRAMMING

CAUTION

External programming resistors must be connected to the appropriate rear terminals before power is applied to the instrument.

3-41 The constant voltage and constant current outputs of the BPS/A can be programmed (controlled) from a remotely located device such as HP 6940A Multiprogrammer

or HP 6941A Multiprogrammer Extenders. Either a resistance or voltage source can be used as the programming device. The wires connecting the programming terminals on the rear of the BPS/A to the remote programming device should be twisted or shielded to reduce noise pickup.

3-42 Resistance Programming Constant Voltage. A programming resistor (R_{PV}), connected as shown in Figure 3-6, can be used to control the voltage output or gain provided that the MODE switch is in the POWER SUPPLY or the VARIABLE GAIN AMP position. Resistance programming of the constant voltage output is is not applicable in the FXD GAIN AMP mode of operation. The VOLTAGE control on the front panel is disconnected (disabled) for the strapping connections shown in Figure 3-6. To maintain the stability and temperature coefficient of the instrument, use programming resistors that have stable low noise and low temperature characteristics (less than 20 ppm/ $^{\circ}$ C.). Also, they should operate at less than 1/30th of their wattage rating to minimize short term temperature effects.

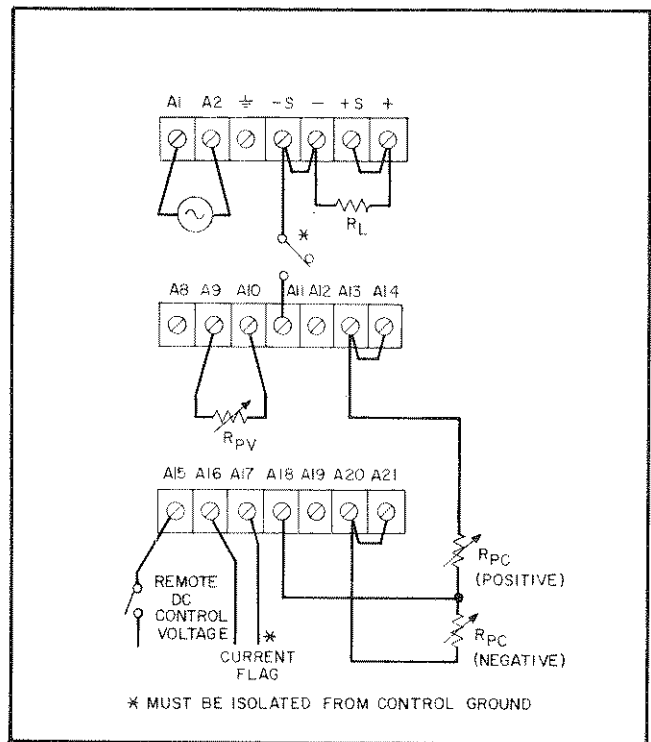

Figure 3-6. Remote Resistance Programming, Constant Voltage/Constant Current

3-43 Power Supply. For power supply operation, the bipolar output voltage varies linearly from a maximum negative value through zero to a maximum positive value according to the value of the programming resistance R_{PV} . The voltage output ranges and corresponding values of R_{PV} are as follows:

R _{PV} VALUE	6826A		6827A	
	HIGH RANGE	LOW RANGE	HIGH RANGE	LOW RANGE
0	-51.2V	-5.12V	-102.4V	-10.24V
10.24KΩ	0V	0V	0V	0V
20.48KΩ	+51.2V	+5.12V	+102.4V	+10.24V

3-44 As noted above, the output voltage should be zero volts with 10.24K connected to the programming terminals. The output may be adjusted to zero by adjusting the V ZERO ADJ potentiometer as described in Paragraph 5-104. The output voltage varies from the maximum negative value to the maximum positive value through 0 at a rate determined by the resistance programming coefficient as follows:

MODEL	* PROGRAMMING COEFFICIENT	
	HIGH RANGE	LOW RANGE
6826A	200 ohms/volt ± .1%	2000 ohms/volt ± .1%
6827A	100 ohms/volt ± .1%	1000 ohms/volt ± .1%

* Precision programming resistors (±0.05%) must be used.

CAUTION

When remote control programming is employed, the FLAG (A17) and REMOTE RANGE (A11) programming connections must be isolated from the computer ground.

3-45 The switch connected between the A11 and -S terminals allows remote selection of the high (X10) or low (X1) range. Note that the front panel RANGE switch must be in the REMOTE position in order to utilize the remote selection feature. The remote dc control voltage connections between terminals A15 and A16 activate an internal relay. When the control voltage is applied, the internal relay is energized momentarily disabling the input driver to the BPS/A error amplifier. This feature is used to prevent transients from affecting the output when the programming input is changed. Terminal A17 provides an indication to the external programming device when the BPS/A is in constant current operation.

3-46 Variable Gain Amplifier. For variable gain amplifier operation, an external input signal (dc to 15kHz), applied to terminals A1 (HI IN) and A2 (LO IN), is amplified or attenuated. The gain is variable from 0 to a maximum value as the value of R_{PV} varies from 0 to 20.48K ohms. The variable gain at the high and low ranges is as follows:

MODEL	VARIABLE GAIN	
	HIGH RANGE	LOW RANGE
6826A	0-20	0-2
6827A	0-40	0-4

CAUTION

The voltage applied to the input terminals, HI IN (A1) and LO IN (A2), must not exceed 50V (maximum) or the instrument may be damaged.

3-47 Resistance Programming, Constant Current. Programming resistors (R_{PC}), connected as shown in Figure 3-6, can be used to control the constant current output. The front panel CURRENT control is disconnected (disabled) when the remote R_{PC} resistors are connected as indicated. Resistance programming of the constant current output can be accomplished in all three modes of operation (power supply, variable gain amplifier, and fixed gain amplifier). Individual R_{PC} resistors control positive and negative constant current outputs respectively. The positive or negative output current is variable at a rate determined by the programming coefficient as follows:

MODEL	OUTPUT CURRENT	* PROGRAMMING COEFFICIENT
6826A	0 to 1.024A	10 ohms/mA ± .1%
6827A	0 to .512A	10 ohms/mA ± .1%

* Precision programming resistors (±0.05%) must be used.

CAUTION

A load must be maintained at all times during constant current operation. The load can be a 100KΩ resistor for the 6826A or a 400KΩ resistor for the 6827A.

3-48 Zero output current for zero programming resistance can be assured through proper adjustment of the front panel +I and -I ZERO ADJ potentiometers (see Paragraph 5-107).

3-49 Voltage Programming, Constant Voltage. Voltage programming of the output voltage can be accomplished in the variable gain or fixed gain amplifier mode of operation. Voltage programming is not applicable in the power supply mode.

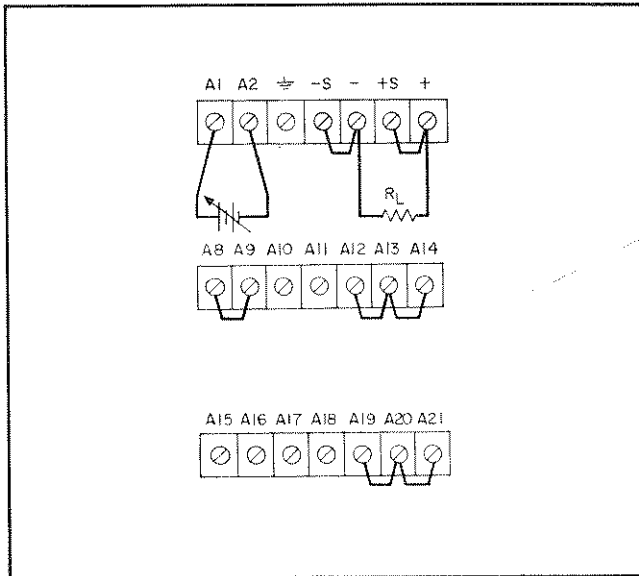

Figure 3-7. Remote Voltage Programming, Constant Voltage

3-50 Variable Gain Amplifier. AC signals or a dc level (positive or negative) can be amplified or attenuated in the variable gain amplifier mode. Figure 3-7 shows a variable dc level (programming voltage) applied to the input terminals A1 (HI IN) and A2 (LO IN). Since the BPS/A is non-inverting in the variable gain amplifier mode, a positive input (A1 positive, A2 negative) results in a positive output and a negative input (A1 negative, A2 positive) results in a negative output. The other connections on Figure 3-7 are shown for local control using front panel controls, however, remote control using external controls may also be employed. The front panel or remote voltage controls can be used to attenuate or amplify the input as required. With the front panel VOLTAGE control or remote programming resistor set for maximum output, the programming coefficient is as follows:

MODEL	MAXIMUM OUTPUT		*PROGRAMMING COEFFICIENT	
	HIGH RANGE	LOW RANGE	HIGH RANGE	LOW RANGE
6826A	±50V	±5V	20 volts/volt	2 volts/volt
6827A	±100V	±10V	40 volts/volt	4 volts/volt

*With front panel VOLTAGE control or remote programming resistor set for maximum rated output.

3-51 Fixed Gain Amplifier. AC signals up to 40kHz (6826A) or 30kHz (6827A) or a dc level (positive or negative) can be amplified in the fixed gain amplifier mode.

Figure 3-7 shows a variable dc level (programming voltage) applied to the HI (A1) and LO (A2) input terminals. Since the BPS/A provides an inverted output in the fixed gain amplifier mode, a positive input (A1 positive, A2 negative) results in a negative output and a negative input (A1 negative, A2 positive) results in a positive output. The front panel or remote programming voltage controls are not applicable in this mode. The programming coefficient in the fixed gain amplifier mode is as follows:

MODEL	MAXIMUM OUTPUT		PROGRAMMING COEFFICIENT	
	HIGH RANGE	LOW RANGE	HIGH RANGE	LOW RANGE
6826A	±50V	±5V	10 volts/volt	1 volt/volt
6827A	±100V	±10V	20 volts/volt	2 volts/volt

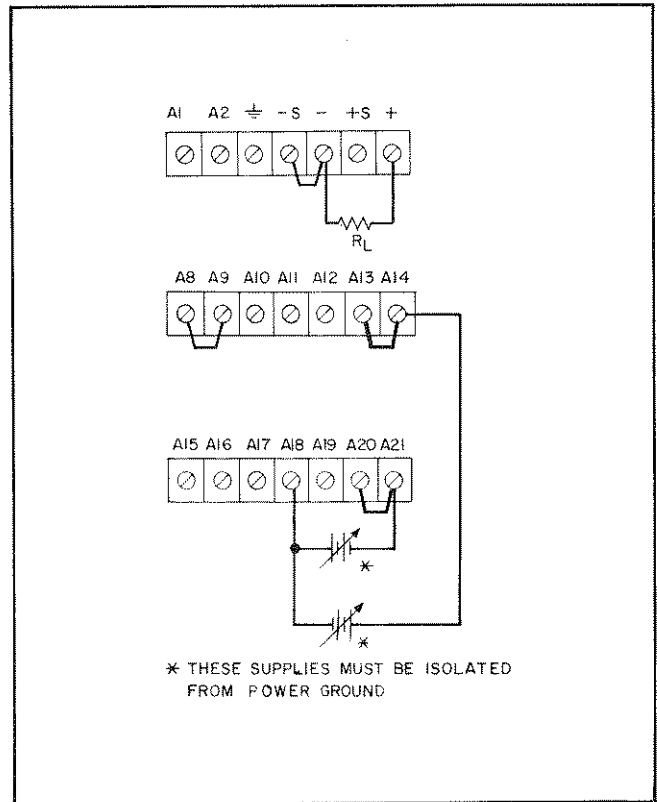

Figure 3-8. Remote Voltage Programming, Constant Current

3-52 Voltage Programming, Constant Current. Voltage programming of the output current can be accomplished in all three operating modes (power supply, variable gain amplifier, and fixed gain amplifier). Positive and negative dc

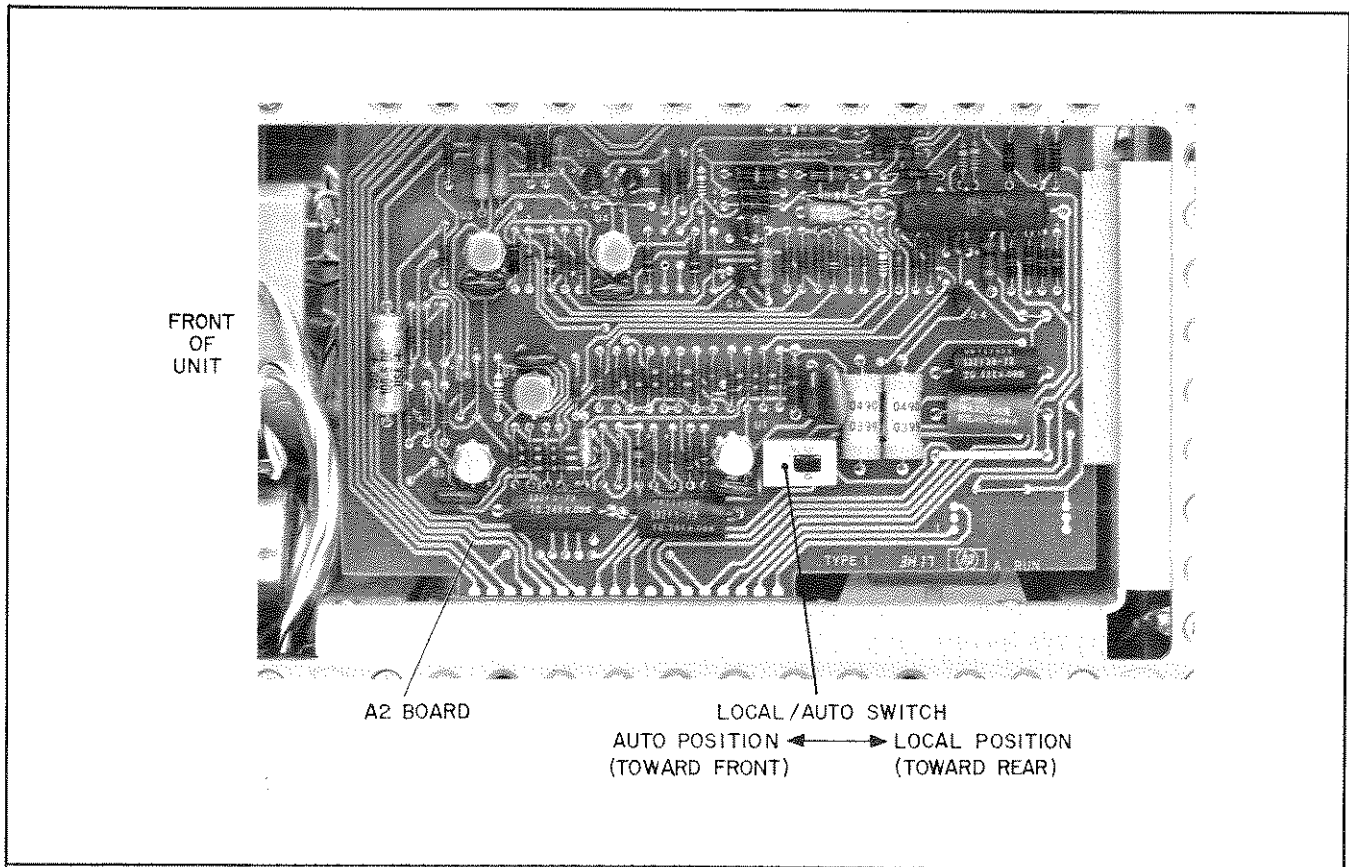

Figure 3-9. Local/Auto Switch

programming voltages are connected to terminals A14 and A21 respectively as shown in Figure 3-8. The positive or negative output current will vary linearly with changes in the programming voltages. The output current varies at a rate determined by the programming coefficient. For models 6826A and 6827A, the programming coefficient is 1 amp/1 volt. The maximum rated output current for the 6826A is 1A, therefore, the maximum programming voltage for 6826A is 1 volt. The maximum rated output current for the 6827A is 0.5A, therefore, the maximum programming voltage for 6827A is 0.5V.

3-53 SERIES AND PARALLEL CONNECTIONS

3-54 The following paragraphs describe the connections required for combining BPS/A's for series and parallel operations. These connections are employed whenever it is required to extend the voltage/gain or current capability beyond one supply. For series operation, the total output voltage/gain is the sum of the voltages/gains of the individual supplies. For parallel operation, the total output current is the sum of the output current from the individual supplies. For series or parallel operation, the BPS/A's must be operated in the same mode (power supply, variable gain amplifier, or fixed gain amplifier). Also, each supply must have its

Auto/Local switch A2S1 (see Figure 3-9) in the Local position (pushed toward the rear of the instrument). Note that the external signal applied to the A1 and A2 terminals is internally disconnected when the BPS/A's are in the power supply mode.

3-55 **Series Connections.** Two or more supplies may be connected in series to obtain a higher voltage/gain than is available from a single supply. Figure 3-10 illustrates the series connections for three supplies. Each of the supplies must be adjusted in order to obtain the desired output/voltage gain.

3-56 **Parallel Connections.** Parallel operation of BPS/A is possible because of the constant voltage/constant current crossover feature. Two or more power supplies can be connected in parallel to obtain a total output current greater than that available from one power supply. The total output current is the sum of the output currents of the individual power supplies. The load must be selected so that the current limit of one supply is exceeded allowing it to operate in the constant current mode. The output CURRENT controls of each power supply can be separately set. The output voltage controls of one power supply should be set to the desired output voltage; the other power supply should be set for a

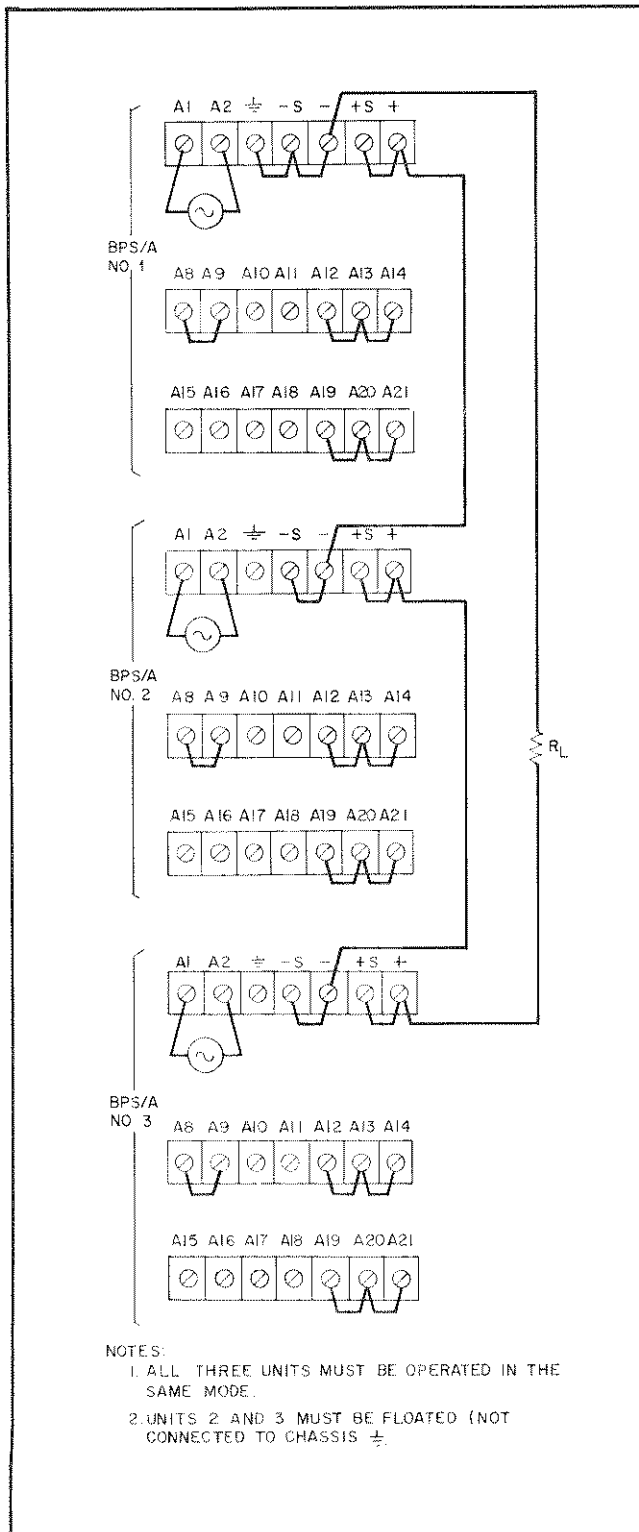

Figure 3-10. Series Connections

slightly larger output voltage. The supply set to the lower output voltage will act as a constant voltage source; the supply set to the higher output will act as a constant current source, dropping its output voltage until it equals that of the other supply. The constant voltage source will deliver only

that fraction of its total rated output current which is necessary to fulfill the total current demand. Figure 3-11 illustrates the parallel connections for three units.

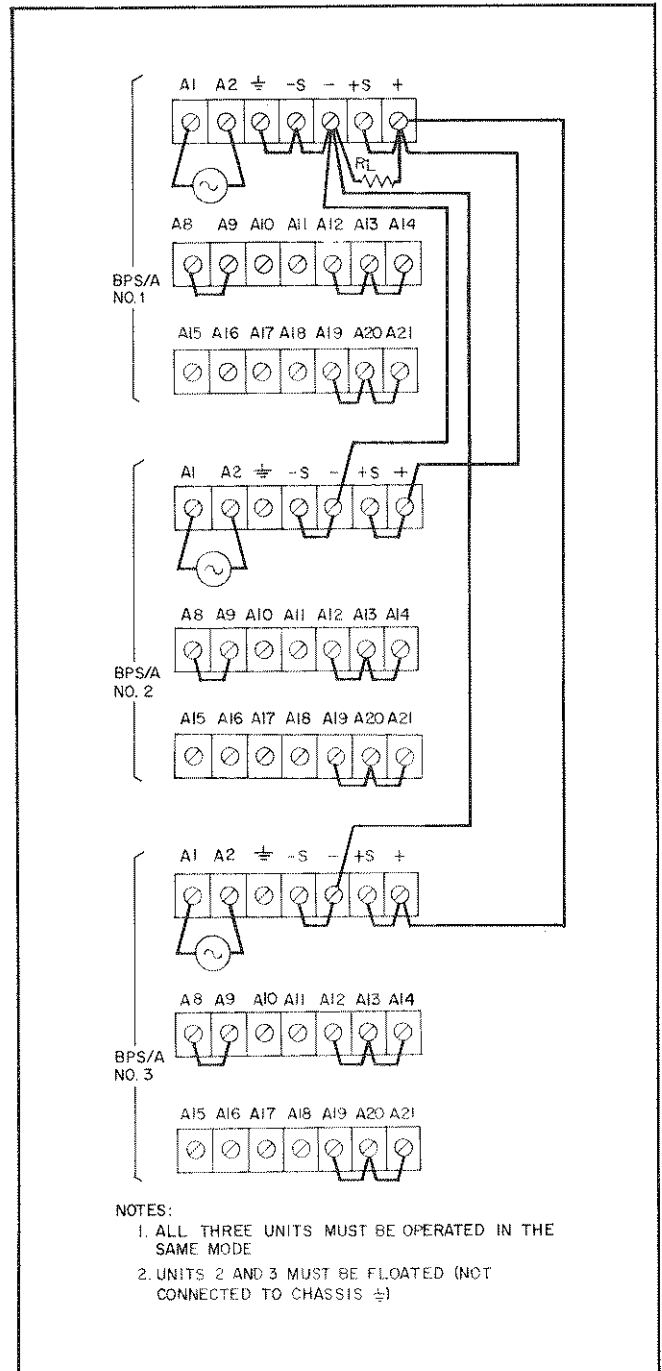

Figure 3-11. Parallel Connections

3-57 AUTO-SERIES AND AUTO-PARALLEL CONNECTIONS

3-58 The following paragraphs describe the connections required for combining BPS/A's in auto-series and auto-

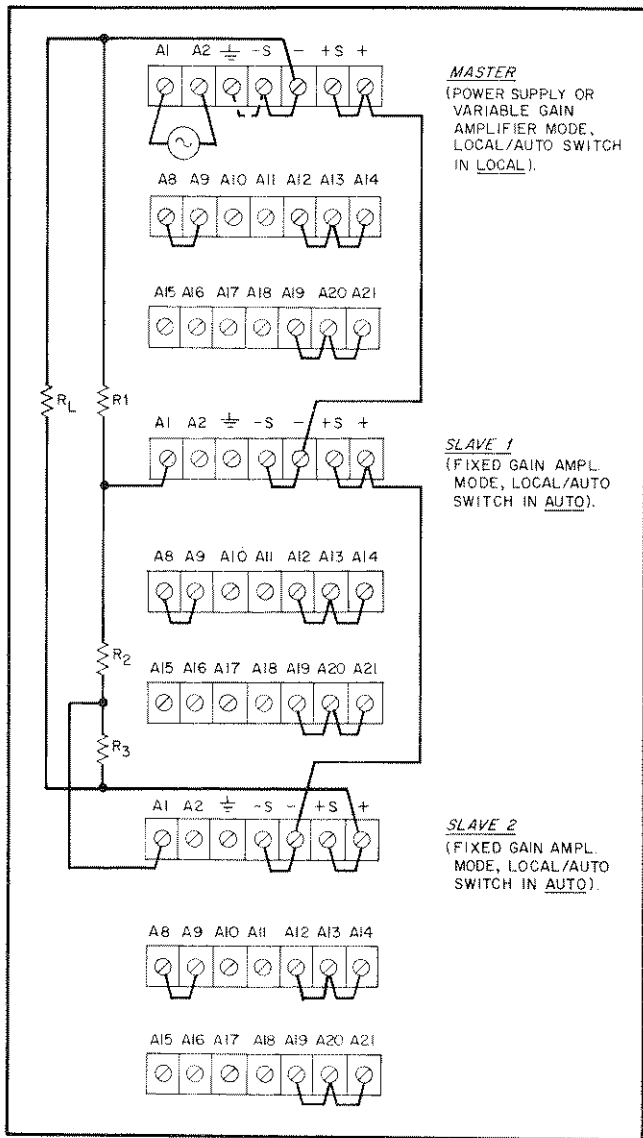

Figure 3-12. Auto-Series Connections, Three Units

parallel. These connections are employed whenever it is required to extend the voltage/gain or current capability beyond one supply. For auto-series operation, the output voltage of each slave supply varies in accordance with that of the master supply. For auto-parallel operation, complete control of the output current from one master is allowed. Diagrams are included for the strapping connections required between master and slaves for both auto-series and auto-parallel operations. In either case, the master must be in the power supply or variable gain amplifier mode and the slaves must be in the fixed gain amplifier mode. Also, for auto-series or parallel operation, the master supply's Local/Auto switch A2S1 (see Figure 3-9) must be in the Local position and each slave supply must have its Local/Auto switch in the Auto position. The diagrams show the master strapped

for local programming and with an external signal applied to the amplifier input terminals. However, the same auto-series or auto-parallel connections could be used with the master strapped for remote programming. Also, with the master supply in the power supply mode, the external signal applied to the A1 and A2 terminals is internally disconnected.

3-59 Auto-Series Operation. Two or more BPS/A's can be connected in an auto-series arrangement to obtain a higher output voltage than that available from a single supply. Figure 3-12 illustrates the auto-series connections for three supplies. When this arrangement is used, the output voltage of each slave supply varies in accordance with that of the master supply; thus, the total output voltage of the combination is determined by the master supply's front panel VOLTAGE control (or remote programming input). The front panel CURRENT controls (or remote programming inputs) of all three units are operative and the current limit is equal to the lowest setting. The slave units must be floated off ground. Instruments can be operated floating up to 300 volts off ground whether operated singly or in series. This limits model 6826A ($\pm 50V @ 1.0A$) to six units in series and model 6827A ($\pm 100V @ 0.5A$) to three units in series.

3-60 For instantaneous equal voltage sharing, resistors R_1 , R_2 , or R_3 must be equal. Since any variation in R_1 , R_2 , or R_3 will result in a change in the voltage divider ratio and hence the output of the slave supply, it is important that these resistors be stable, low temperature coefficient ($20 \text{ ppm}/^\circ\text{C}$ or better). Also, they should have power rating of at least 10X, their actual power dissipation. The resistors should be selected at the normal operating voltage levels so that the current through them is about 1 to 2mA.

3-61 Auto-Parallel Operation. Two or more BPS/A's can be connected in auto-parallel arrangement to obtain an output current greater than that available from a single supply. Figure 3-13 illustrates the auto-parallel connections for three supplies to allow increased output current in constant voltage operation. When this arrangement is used, current sharing under all load conditions is permitted under control (front panel CURRENT control or remote programming) of the master supply. Because the CURRENT controls (or remote programming) of each slave are operative, they should be set to a maximum to prevent the slave reverting to constant current operation; this could occur if the master output current setting exceeded the slave's. For equal current sharing, the leads from R_M to the load and to the (-) terminals should be approximately equal in length. To maintain instrument accuracy and stability, R_M should be a stable, low temperature coefficient resistor of sufficient rating to prevent any appreciable self-heating (typically 1Ω , $8W$, $\pm 20 \text{ ppm}/^\circ\text{C}$, $\pm 1\%$).

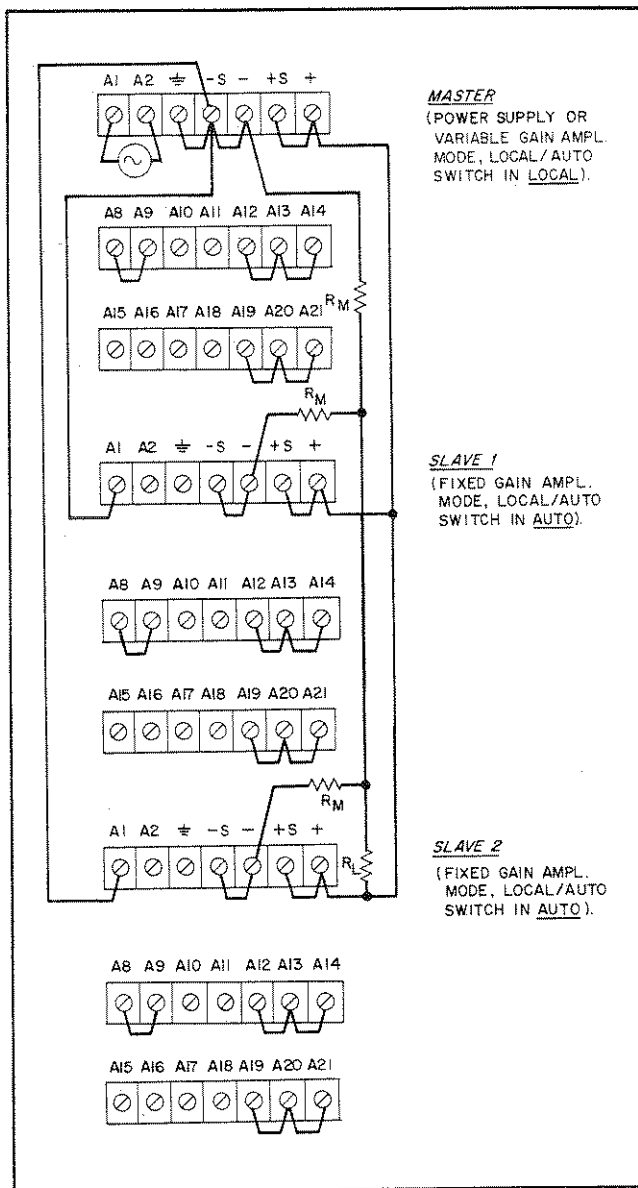

Figure 3-13. Auto-Parallel Connections, Three Units

3-62 BIPOLAR OVERVOLTAGE AND OVERCURRENT LIMIT

3-63 Bipolar overvoltage and overcurrent limit circuits prevent excessive BPS/A voltage or current outputs. The voltage limiting circuit prevents the output voltage from exceeding approximately ± 55 volts (6826A) or ± 110 volts (6827A). The current limiting circuit limits the transient output current to a value approximately two times the maximum rated output of 1.0A (6826A) or 0.5A (6827A).

3-64 REVERSE VOLTAGE AND CURRENT LOADING

3-65 Current limit circuits also protect the BPS/A from active loads that force energy in or out of the BPS/A (sink condition). This can appear as current flow into the HI OUT (+) terminal when the terminal is positive, or current flow out of the terminal when it is negative. Figure 3-14 shows the normal operating locus of the BPS/A. As shown, the 6826A BPS/A will limit the sink current to a value ranging linearly from 1A at 0V to 0.5A at 50V and the 6827A BPS/A will limit sink current to a value ranging linearly from 0.5A at 0V to 0.25A at 100V.

3-66 An active load can easily be accommodated by the BPS/A as long as the following precautions are adhered to:

- The active load must not be applied unless the BPS/A is in its active state.
- Program to zero output before disconnecting load.

CAUTION

Externally applied voltage to output terminals in excess of 60V (6826A) or 125V (6827A) could damage the instrument.

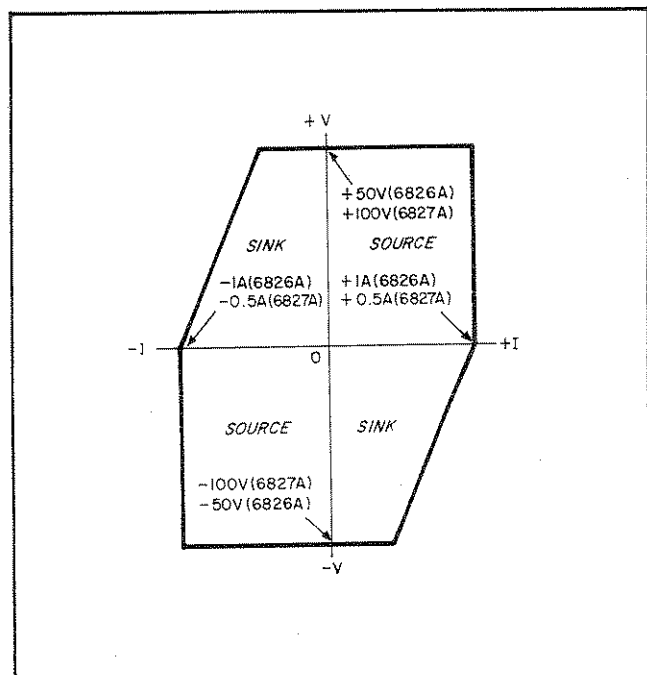

Figure 3-14. 6826A/6827A Output Ranges

Free Manuals Download Website

<http://myh66.com>

<http://usermanuals.us>

<http://www.somanuals.com>

<http://www.4manuals.cc>

<http://www.manual-lib.com>

<http://www.404manual.com>

<http://www.luxmanual.com>

<http://aubethermostatmanual.com>

Golf course search by state

<http://golfingnear.com>

Email search by domain

<http://emailbydomain.com>

Auto manuals search

<http://auto.somanuals.com>

TV manuals search

<http://tv.somanuals.com>