

HP 11713A ATTENUATOR/SWITCH DRIVER

SERIAL NUMBERS

This manual applies directly to instruments with serial numbers prefixed 2508A.

With the changes described in Section VII, this manual also applies to instruments with serial numbers prefixed 1850A, 1946A, 2135A, 2223A, 2335A, and 2421A.

For additional important information about serial numbers, see INSTRUMENTS COVERED BY MANUAL in Section I.



© Copyright HEWLETT-PACKARD COMPANY 1979, 1980, 1982, 1985
1501 PAGE MILL ROAD, PALO ALTO, CALIFORNIA, U.S.A.

MANUAL PART NUMBER. 11713-90011
Microfiche Part No. 11713-90012

Printed: JULY 1985

Downloaded from Somanuals.com

CONTENTS

Section	Page	Section	Page
I GENERAL INFORMATION	1-1	Receiving the Local Message	3-14
Introduction	1-1	Receiving the Local Lockout Message	3-14
Specifications	1-1	Receiving the Clear Lockout/Set Local Message	3-14
Safety Considerations	1-1	Receiving the Pass Control Message	3-14
Instruments Covered by Manual	1-1	Sending the Require Service Message	3-14
Description	1-1	Sending the Status Byte Message	3-14
Options	1-2	Sending the Status Bit Message	3-14
Accessories Supplied	1-2	Receiving the Abort Message	3-14
Equipment Available	1-2	Operator Maintenance	3-14
Recommended Test Equipment	1-2	Connections to 11713A Attenuator Drivers	3-14
II INSTALLATION	2-1	General	3-14
Introduction	2-1	Driving Additional Coaxial Switches	3-15
Initial Inspection	2-1	Connections for Four-Section Attenuator	3-16
Preparation For Use	2-1	Relay Drivers	3-16
Power Requirements	2-1	IV PERFORMANCE TESTS	4-1
⚠ Line Voltage and Fuse Selection	2-1	Introduction	4-1
Power Cable	2-1	Performance Test	4-1
HP-IB Address Selection	2-3	Operational Verification	4-1
Mating Connectors	2-3	V ADJUSTMENTS	5-1
Interconnections	2-3	VI REPLACEABLE PARTS	6-1
Operating Environment	2-3	Introduction	6-1
Bench Operation	2-3	Abbreviations	6-1
Rack Mounting	2-5	Replaceable Parts	6-1
Storage and Shipment	2-5	Ordering Information	6-1
Environment	2-5	VII MANUAL CHANGES	7-1
Packaging	2-5	Introduction	7-1
III OPERATION	3-1	Manual Changes	7-1
Introduction	3-1	Manual Change Instructions	7-1
Local Operation	3-1	VIII SERVICE	8-1
Panel Features	3-1	Introduction	8-1
Operator's Check	3-1	⚠ Safety Considerations	8-1
Remote Operation (HP-IB)	3-1	Service	8-1
HP-IB Compatibility	3-1	Principles of Operation	8-1
Remote Mode	3-1	Troubleshooting	8-5
Local Mode	3-2		
Addressing	3-2		
Data Messages	3-2		
Receiving the Data Message	3-10		
Sending the Data Message	3-10		
Receiving the Trigger Message	3-14		
Receiving the Clear Message	3-14		
Receiving the Remote Message	3-14		

ILLUSTRATIONS

Figure	Page	Figure	Page
1-1. HP Model 11713A, Accessories Supplied, and Options 907 and 908	1-0	7-5. A1 Interconnect and Power Supply Component Locations (P/O Change B).....	7-4
2-1. Line Voltage Selection	2-2	7-6. A1 Interconnect and Power Supply Component Locations (P/O Change C).....	7-5
2-2. Power Cable and Mains Plug Part Numbers	2-2		
2-3. HP-IB Address Selection	2-3	8-1. Schematic Diagram Notes	8-2
2-4. Hewlett-Packard Interface Bus Connection	2-4	8-2. Model 11713A Simplified Block Diagram	8-7
3-1. Front Panel Features	3-3	8-3. A7 Switch Board Assembly Component Locations	8-9
3-2. Rear Panel Features	3-4	8-4. Switch Board Schematic Diagram	8-9
3-3. Connections for HP 8761B Switch	3-12	8-5. A5 HP-IB Handshake and Data Input Assembly Component Locations	8-11
3-4. Connections for HP 33311 Series Switches	3-13	8-6. HP-IB Handshake and Data Input Schematic Diagram	8-11
3-5. Typical Connections for Programmable Four-Section Attenuator	3-16	8-7. A4 Remote Local Logic Assembly Component Locations	8-13
3-6. Relay Driving Circuit	3-16	8-8. Remote Local Logic Schematic Diagram	8-13
4-1. Operational Verification Test Setup	4-1	8-9. A3 Latch Assembly Component Locations	8-15
6-1. Front Panel Mechanical Parts	6-10	8-10. Latch Schematic Diagram	8-15
6-2. Rear Panel Mechanical Parts	6-10	8-11. A6 Interface Assembly Component Locations	8-16
6-3. Top Internal Mechanical Parts and Hardware	6-11	8-12. A2 Driver Assembly Component Locations	8-17
6-4. Bottom Internal Mechanical Parts and Hardware	6-12	8-13. Driver Schematic Diagram	8-17
6-5. Cabinet Parts	6-13	8-14. Typical Foldback Characteristics of +24 Volt Power supply	8-18
7-1. Reference Circuit Schematic Backdating (Partial Diagram, P/O Change A)	7-1	8-15. A1 Interconnect and Power Supply Component Locations	8-19
7-2. A5 HP-IB Handshake and Data Input Assembly Component Locations (P/O Change A)	7-2	8-16. Interconnect and Power Supply Schematic Diagram	8-19
7-3. Rear Panel Mechanical Parts (P/O Change B)	7-2	8-17. Top Internal View Assembly and Component Locations	8-21
7-4. A6 Interface Assembly Component Locations (P/O Change B)	7-3		

TABLES

Table	Page	Figure	Page
1-1. Specifications	1-2	3-5. Attenuation Levels and Corresponding Data Strings	3-11
1-2. Supplemental Characteristics	1-3	3-6. Attenuator Cable Connector Pin Numbers and Wire Color Codes	3-15
1-3. Recommended Test Equipment	1-3		
2-1. Line Fuse Part Number	2-3	4-1. Performance Check Program Using 9825A Controller	4-2
2-2. ASCII Address Codes to Decimal Equivalents	2-3		
3-1. Operator's Check	3-5	6-1. Reference Designations and Abbreviations	6-2
3-2. Operator's HP-IB Interface Checks	3-6	6-2. Replaceable Parts	6-4
3-3. HP-IB Message Reference Table	3-9	6-3. Code List of Manufacturer's	6-14
3-4. HP-IB Control Statement Results	3-10	8-1. Troubleshooting Hints	8-5

SAFETY CONSIDERATIONS

GENERAL

This product and related documentation must be reviewed for familiarization with safety markings and instructions before operation.

This product is a Safety Class I instrument (provided with a protective earth terminal).

BEFORE APPLYING POWER

Verify that the product is set to match the available line voltage and the correct fuse is installed.

SAFETY EARTH GROUND

An uninterruptible safety earth ground must be provided from the main power source to the product input wiring terminals, power cord, or supplied power cord set.

WARNINGS

Any interruption of the protective (grounding) conductor (inside or outside the instrument) or disconnecting the protective earth terminal will cause a potential shock hazard that could result in personal injury. (Grounding one conductor of a two conductor outlet is not sufficient protection). In addition, verify that a common ground exists between the unit under test and this instrument prior to energizing either unit.

Whenever it is likely that the protection has been impaired, the instrument must be made inoperative and be secured against any unintended operation.

If this instrument is to be energized via an auto-transformer (for voltage reduction) make sure the common terminal is connected to neutral (that is, the grounded side of the mains supply).

Servicing instructions are for use by service-trained personnel only. To avoid dangerous electric shock, do not perform any servicing unless qualified to do so.

Adjustments described in the manual are performed with power supplied to the instrument

while protective covers are removed. Energy available at many points may, if contacted, result in personal injury.

Capacitors inside the instrument may still be charged even if the instrument has been disconnected from its source of supply.

For continued protection against fire hazard, replace the line fuse(s) only with 250V fuse(s) of the same current rating and type (for example, normal blow, time delay, etc.). Do not use repaired fuses or short circuited fuseholders.

SAFETY SYMBOLS



Instruction manual symbol: the product will be marked with this symbol when it is necessary for the user to refer to the instruction manual (see Table of Contents for page references).



Indicates hazardous voltages.



Indicates earth (ground) terminal.

WARNING

The WARNING sign denotes a hazard. It calls attention to a procedure, practice, or the like, which, if not correctly performed or adhered to, could result in personal injury. Do not proceed beyond a WARNING sign until the indicated conditions are fully understood and met.

CAUTION

The CAUTION sign denotes a hazard. It calls attention to an operating procedure, practice, or the like, which, if not correctly performed or adhered to, could result in damage to or destruction of part or all of the product. Do not proceed beyond a CAUTION sign until the indicated conditions are fully understood and met.

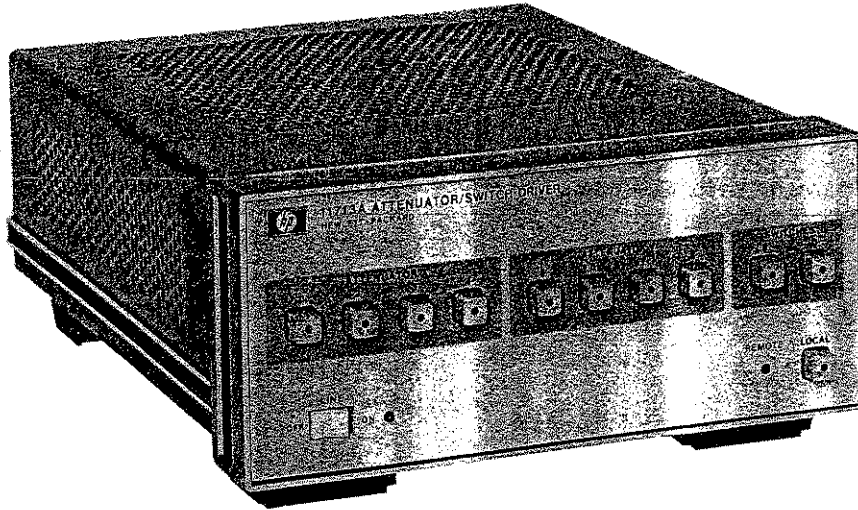

MODEL 11713A

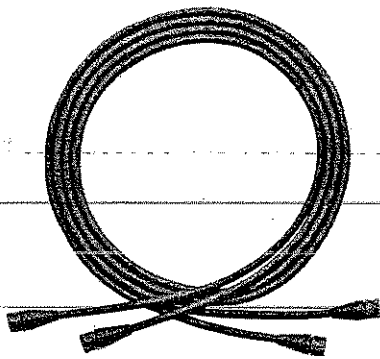

ATTENUATOR CABLES
(HP Part Number 8120-2703)

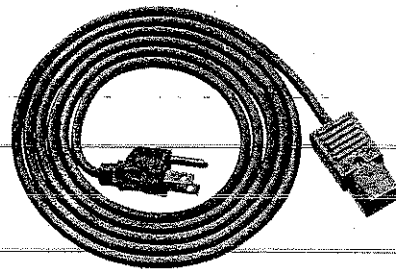

LINE POWER CABLE
(See Figure 2-2 for HP Part Numbers)

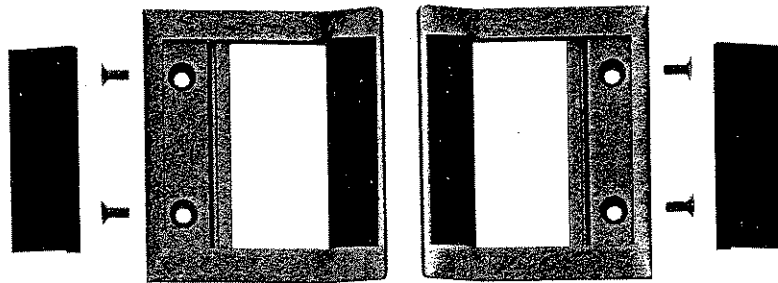

OPTION 907 FRONT HANDLE KIT

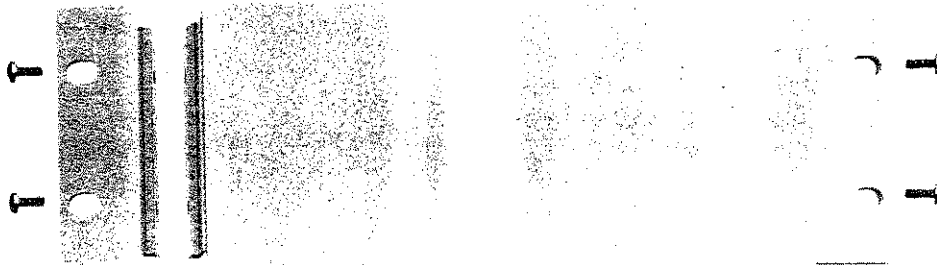

OPTION 908 RACK ADAPTER KIT

Figure 1-1. HP Model 11713A, Accessories Supplied, and Options 907 and 908

SECTION I

GENERAL INFORMATION

INTRODUCTION

This operating and service manual contains information required to install, operate, test, and service the Hewlett-Packard 11713A. The Hewlett-Packard 11713A Attenuator/Switch Driver is designed to drive electromagnetic solenoid operated coaxial attenuators and RF coaxial switches. The 11713A will be referred to as the Driver throughout this manual. The Driver is an HP-IB* compatible instrument that provides the current needed to control step attenuators or coaxial switches. Figure 1-1 shows the Driver and all supplied accessories.

Listed on the title page of this manual (below the manual part number) is a Microfiche part number. This number can be used to order 10 x 15 cm (4 x 6 inch) microfilm transparencies of the manual. Each microfiche contains up to 96 photo-duplicates of the manual pages. The microfiche package also includes the latest Manual Changes supplement as well as pertinent Service Notes.

SPECIFICATIONS

Instrument specifications are listed in Table 1-1. These specifications are the performance standards or limits against which the instrument is tested. Supplemental Characteristics listed in Table 1-2 are not warranted specifications but included as additional information for the user.

SAFETY CONSIDERATIONS

The Driver is a Safety Class I instrument (provided with a protective earth terminal). This instrument and all related documentation must be reviewed for familiarization with safety markings and instructions before operation. A safety considerations sheet is found at the beginning of this manual. Safety information pertinent to the task at hand (installation, operation, performance testing, or service) is found throughout this manual.

INSTRUMENTS COVERED BY MANUAL

Attached to the instrument is a serial number plate. The serial number is in the form: 0000A00000. It

*Hewlett-Packard Interface Bus is the Hewlett-Packard implementation of the IEEE Std. 488.

is in two parts: the first four digits and the letter are the serial prefix and the last five digits are the suffix. The prefix is the same for all identical instruments; it changes only when a change is made to the instrument. The suffix, however, is assigned sequentially and is different for each instrument. The contents of this manual apply to instruments with the serial number prefix(es) listed under SERIAL NUMBERS on the title page.

An instrument manufactured after the printing of this manual may have a serial number prefix that is not listed on the title page. This unlisted serial number prefix indicates the instrument is different from those described in this manual. The manual for this newer instrument is accompanied by a yellow Manual Changes supplement. This supplement contains "change information" that explains how to adapt the manual to the newer instrument.

In addition to change information, the supplement may contain information for correcting errors in the manual. To keep this manual as current and accurate as possible, Hewlett-Packard recommends that you periodically request the latest Manual Changes supplement. The supplement for this manual is identified with the manual print date and part number, both of which appear on the manual title page. Complimentary copies of the supplement are available from Hewlett-Packard.

For information concerning a serial number prefix that is not listed on the title page or in the Manual Changes supplement, contact your nearest Hewlett-Packard office.

DESCRIPTION

The Hewlett-Packard 11713A Attenuator/Switch Driver is an HP-IB compatible instrument designed to provide control of up to two four-section programmable step attenuators and two microwave coaxial switches. Control is easily accomplished manually from front panel pushbuttons or automatically over the Hewlett-Packard Interface Bus. Programming via the HP-IB can be accomplished in simple one line statements. The Driver features

DESCRIPTION (Cont'd)

front panel status monitoring, and a self-contained power supply with current limiting. The Driver is designed to provide in a single enclosure a convenient interface control unit.

OPTIONS

Option 907, Front Handle Kit. This kit contains front panel handles that can be added to the Driver cabinet (Figure 1-1). Order HP Part No. 5061-9688.

Option 908, Rack Adapter Kit. This kit contains the flange and hardware for mounting the Driver in a standard rack of 48.3 cm (19 inches). Order HP Part No. 5061-9672 Rack Adapter Kit Half Module (Figure 1-1).

ACCESSORIES SUPPLIED

The accessories supplied with the Driver are shown in Figure 1-1. The power cable is selected at the factory according to the voltage available in the country of destination.

Precision Microwave Coaxial Attenuators. The HP Models 8494, 8495, and 8496 Programmable Step Attenuators provide for control of microwave signal levels. The HP Models 33320, 33321, and 33322 are equivalent versions of the above attenuators for OEM applications.

Microwave Coaxial Switches. The HP Model 8761B SPDT RF Switch and 33311B/C Coaxial Switches provide switchable microwave signal paths, with the un gated ports terminated in 50 ohms.

To connect two of the programmable step attenuators in series use HP 11716A (Type N connectors) or HP 11716B (APC-7® connectors) Interconnection Kit. To rack mount attenuators or RF switches use HP 11717A Attenuator/Switch Rack Mount Support Kit. If the Driver is to be used on the bench in a position that requires setting it on the rear panel a kit is available that includes feet with mounting screws. Order HP part number 5061-0095.

EQUIPMENT AVAILABLE

Accessories and equipment may be ordered or information about them may be obtained by contacting your nearest Hewlett-Packard office. Refer to the HP model number.

RECOMMENDED TEST EQUIPMENT

Test equipment required to maintain the Driver is listed in Table 1-3. Equipment other than the recommended models can be used provided the minimum specifications are satisfied.

Table 1-1. Specifications

<p>Operating Temperature: 0 to +55°C.</p> <p>Driver Power Supply Capability:</p> <p>Voltage: +24 ±2.0 Vdc.</p> <p>Current: 1.3A maximum peak for 1 second. 0.65A maximum continuous current. Contact pairs 1 through 8, 9, and 0, maximum current of 0.65A; continuous through one or all contacts.</p>

Table 1-2. Supplemental Characteristics

<p>Power: 100 or 120 Vac, +5% -10% at 48 to 440 Hz. 200 or 240 Vac, +5% -10% at 48 to 66 Hz. 80 VA maximum.</p> <p>Response Time: 10 μs maximum for contact pairs 1 through 8. 20 ms maximum for contact pairs 9 and 0.</p> <p>Driver Life: > 2 000 000 switchings at maximum current for contact pairs 9 and 0.</p> <p>Maximum Load Inductance: 500 mH.</p> <p>Maximum Load Capacitance: <0.01 μF for contact pairs 9 and 0.</p> <p>Net Weight: 4.1 kg (9 lbs).</p> <p>Dimensions¹: Height: 102 mm (4 inches including feet). Rack Height: 89 mm (3½ inches, half width module). Width: 213 mm (8.4 inches). Depth: 295 mm (11.6 inches).</p>	
<p>¹Dimensions are for general information only.</p>	

Table 1-3. Recommended Test Equipment

Instrument Type	Critical Specifications	Suggested Model	Use*
Logic Probe	Responds to TTL levels	HP 545A	T
Digital Voltmeter	0 to +30 Vdc	HP 3456A	T
Attenuators (2 req.)	Programmable, 4 section	HP 8495K	P, T
Switches (2 req.)	+24 Vdc drive source	HP 8761B	P, T
Controller HP-IB	HP-IB compatible	HP 9825A	P, T

*P = Performance; T = Troubleshooting.

SECTION II INSTALLATION

INTRODUCTION

This section provides the information needed to install the Driver. Included is information pertinent to initial inspection, power requirements, line voltage selection, power cables, interconnection, environment, instrument mounting, storage, and shipment.

INITIAL INSPECTION

WARNING

To avoid hazardous electrical shock, do not perform electrical tests when there are signs of shipping damage to any portion of the outer enclosure (covers, panels, connectors).

Inspect the shipping container for damage. If the shipping or cushioning material is damaged, it should be kept until the contents of the shipment have been checked for completeness and the instrument has been checked mechanically and electrically. The contents of the shipment should be as shown in Figure 1-1. A procedure for checking the electrical performance is given in Section IV. If the contents are incomplete, if there is mechanical damage or defect, or if the instrument does not pass the electrical performance test, notify the nearest Hewlett-Packard office. If the shipping container is damaged, or the cushioning material shows signs of stress, notify the carrier as well as the Hewlett-Packard office. Keep the shipping material for the carrier's inspection.

PREPARATION FOR USE

WARNINGS

This is a Safety Class I product (provided with a protective earthing terminal). An uninterruptible safety earth ground must be provided from the main power source to the product input wiring terminals, power cord, or supplied power cord set. Whenever it is likely that the protection has been impaired,

the product must be made inoperative and be secured against any unintended operation.

If this instrument is to be energized via an autotransformer for voltage reduction, make sure the common terminal is connected to the earthed pole power source.

Power Requirements

The Driver requires a power source of 100 to 120 volts (+5%, -10%) from 48 to 440 Hz; or 220 to 240 volts (+5, -10%) from 48 to 66 Hz, single phase. Power consumption is 80 VA max.



Line Voltage and Fuse Selection

Figure 2-1 provides instructions for line voltage and fuse selection. Table 2-1 gives line fuse part numbers.

WARNING

To avoid the possibility of hazardous electrical shock, do not operate this instrument at line voltages greater than 126.5 Vac with line frequencies greater than 66 Hz. Leakage currents at these line settings may exceed 3.5 mA.

CAUTION

Before the instrument is switched on, it must be set to the voltage of the power source, or damage to the instrument may result.

Power Cable

In accordance with international safety standards, this instrument is equipped with a three-wire power cable. When connected to an appropriate ac power receptacle, this cable grounds the instrument cabinet. The type of power cable plug shipped with each instrument depends on the country of destination. See Figure 2-2 for the part numbers of the power cable plugs available.

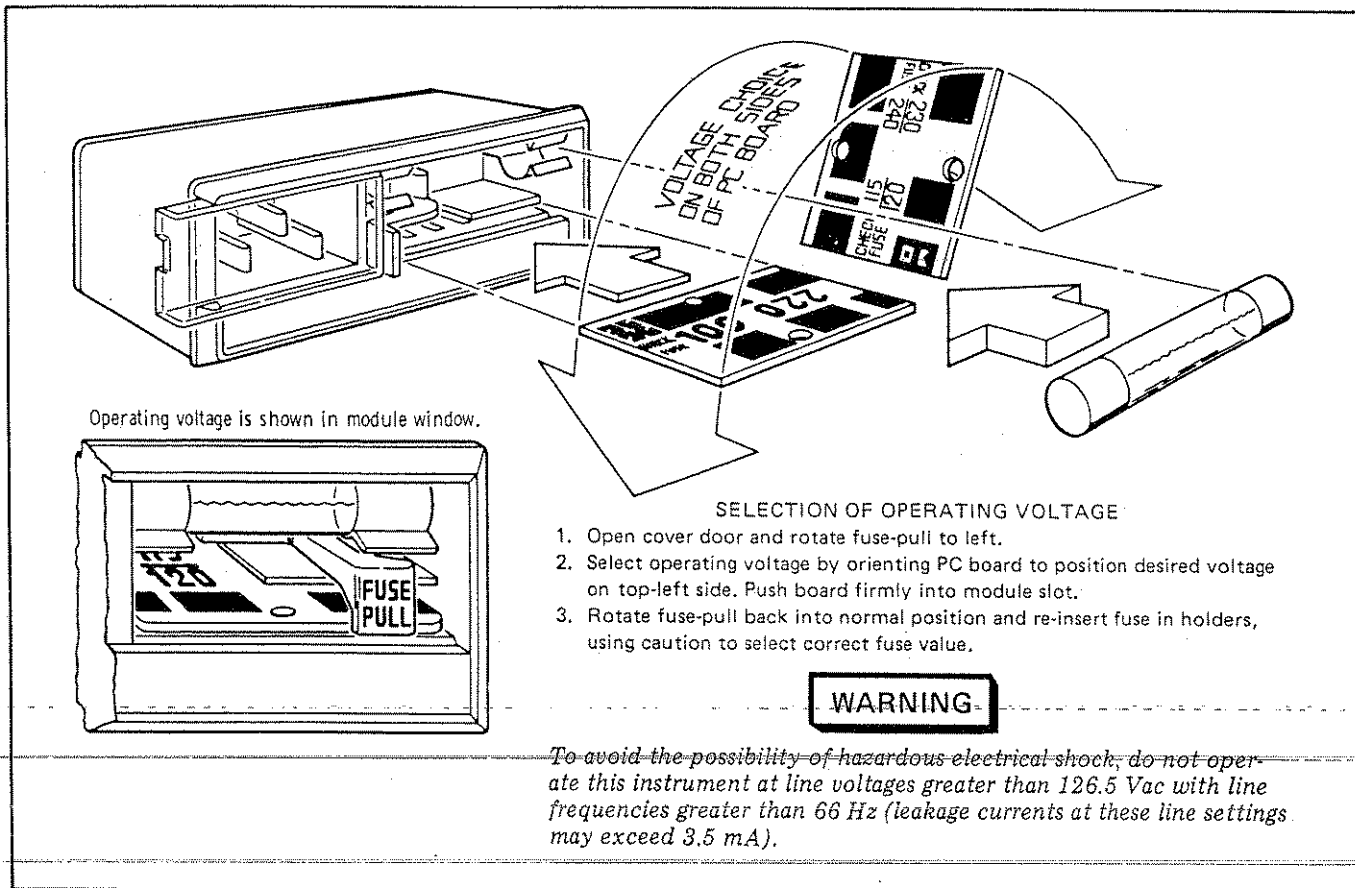

Figure 2-1. Line Voltage Selection

<p>220/240V OPERATION</p>  <p>PLUG*: SEV 1011.1959-24507 TYPE 12 CABLE*: HP 8120-2104</p>	<p>220/240V OPERATION</p>  <p>PLUG*: NZSS 198/AS C112 CABLE*: HP 8120-1369</p>	<p>100/120V OPERATION</p>  <p>PLUG*: NEMA 5-15P CABLE*: 8120-1378</p>	<p>220/240V OPERATION</p>  <p>PLUG*: NEMA 6-15P CABLE*: HP 8120-0698</p>
<p>220/240V OPERATION</p>  <p>PLUG*: CEE7-VII CABLE*: HP 8120-1689</p>	<p>220/240V OPERATION</p>  <p>PLUG*: DHCK 107 CABLE*: HP 8120-2956</p>	<p>220/240V OPERATION</p>  <p>PLUG*: BS 1363A CABLE: HP 8120-1351</p>	
<p>*The number shown for the plug is the industry identifier for the plug only. The number shown for the cable is an HP part number for a complete cable including the plug.</p>			

Figure 2-2. Power Cable and Mains Plug Part Numbers

Table 2-1. Line Fuse Part Numbers

Line Voltage	Line Fuse	HP Part Number
100V/120V	Fast Blow 1.25A	2110-0094
220V/240V	Fast Blow 750 mA	2110-0063

WARNING

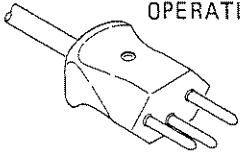
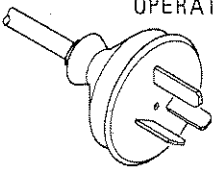
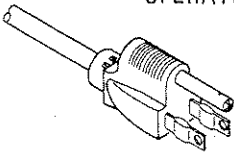
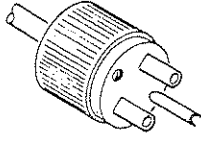
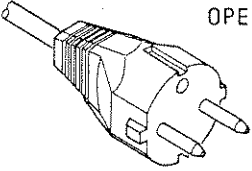
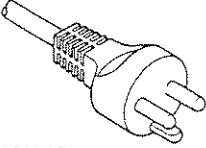
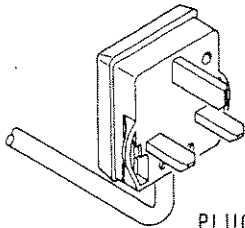
The protection provided by grounding the instrument cabinet may be lost if any power cable other than the three-pronged type supplied is used to couple the ac line voltage to the instrument.

HP-IB Address Selection

In the Driver, the HP-IB listen address is switch selectable. The switches are located on the rear panel as shown in Figure 3-2. Select the desired address as shown in Table 2-2. Address is set to decimal 28 at the factory, as shown in Figure 2-3.

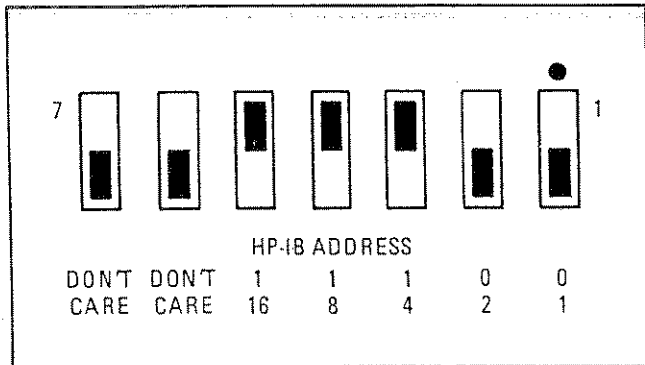

Figure 2-3. HP-IB Address Selection

Mating Connectors

Mating connectors used with the Driver should be the 24-pin HP-IB male, the 12-pin Viking Industries connector, (TKP12-102-P-TS-100-AU) and the Banana type male.

Interconnections

Interconnection data for the Hewlett-Packard Interface Bus is provided in Figure 2-4.

Operating Environment

The operating environment should be within the following limits:

Table 2-2. ASCII Address Codes to Decimal Equivalents

ASCII Address Codes LISTEN	Decimal Equivalents
SP	00
!	01
"	02
#	03
\$	04
%	05
&	06
'	07
(08
)	09
*	10
+	11
,	12
-	13
.	14
/	15
0	16
1	17
2	18
3	19
4	20
5	21
6	22
7	23
8	24
9	25
:	26
;	27
<	28†
=	29
>	30

†indicates factory set address.

Temperature 0°C to +55°C
 Humidity <90% relative at 65°C
 Altitude <4570 metres (15 000 feet)

Bench Operation

The Driver cabinet is equipped with plastic feet and fold-away tilt stands for convenience in bench operation. (The plastic feet are shaped to ensure self-alignment of the instruments when stacked.) The tilt stands raise the front of the instrument for easier viewing of the control panel. If the Driver is to be used in a position that requires setting it on the rear panel a kit is available that includes feet with mounting screws. Order HP part number 5061-0095.

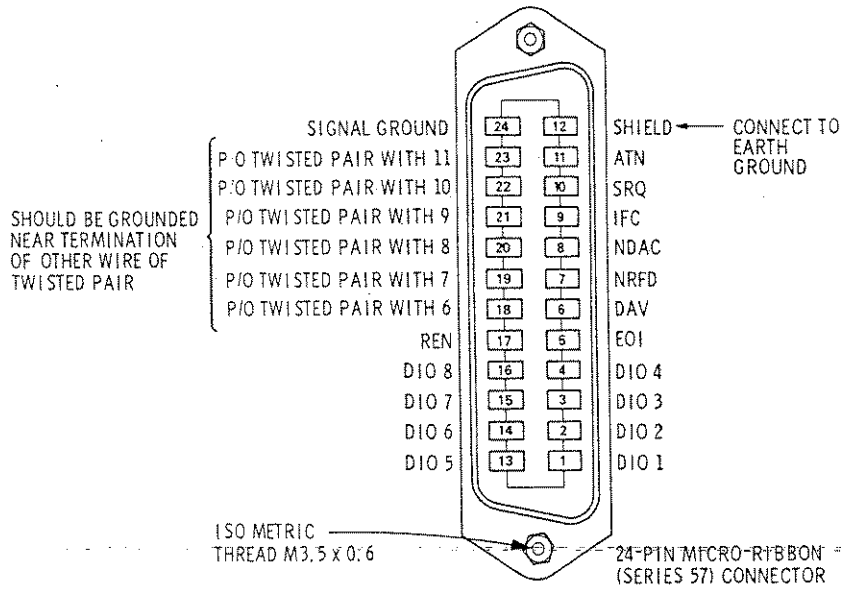

Logic Levels

The Hewlett-Packard Interface Bus logic levels are TTL compatible, i.e., the true (1) state is 0.0 to +0.4 Vdc and the false (0) state is +2.5 to +5.0 Vdc.

Programming and Output Data Format

Refer to Section III, Operation.

Mating Connector

HP 1251-0293; Amphenol 57-30240.

Mating Cables Available¹

HP 10833A, 1 metre (3.3 ft.), HP 10833B, 2 metres (6.6 ft.).
 HP 10833C, 4 metres (13.2 ft.), HP 10833D, 0.5 metre (1.6 ft.)

Cabling Restrictions

1. A Hewlett-Packard Interface Bus system may contain no more than 2 metres (6.6 ft.) of connecting cable per instrument.
2. The maximum accumulative length of connecting cable for any Hewlett-Packard Interface Bus system is 20 metres (65.6 ft.).

¹ The 10834A Adapter is required with these cables to provide additional clearance for the cable connectors.

Figure 2-4. Hewlett-Packard Interface Bus Connection

Rack Mounting

The instrument can be rack mounted by using an adapter frame. The adapter frame is a rack frame that accepts several combinations of sub-modular units. To rack mount the Driver use rack adapter kit half module HP Part No. 5061-0072 (Figure 1-1, Option 908). To install the kit:

- a. Remove feet and tilt stands.
- b. Remove side trim strips.
- c. Attach rack mount flange and flange adapter.

For additional information, address inquiries to your nearest Hewlett-Packard office.

STORAGE AND SHIPMENT

Environment

The instrument should be stored in a clean, dry, environment. The following environmental limitations apply to both storage and shipment:

- Temperature -55°C to +75°C
- Humidity <90% relative
- Altitude <15 300 metres (50 000 feet)

Packaging

Original Packaging. Containers and materials identical to those used in factory packaging are avail-

able through Hewlett-Packard offices. If the instrument is being returned to Hewlett-Packard for servicing, attach a tag indicating the type of service required, return address, model number, and full serial number. Also, mark the container FRAGILE to assure careful handling. In any correspondence, refer to the instrument by model number and full serial number.

Other Packaging. The following general instructions should be used for repackaging with commercially available materials:

- a. Wrap the instrument in heavy paper or plastic. (If shipping to a Hewlett-Packard office or service center, attach a tag indicating the type of service required, return address, model number, and full serial number.)
- b. Use a strong shipping container.
- c. Use a layer of shock-absorbing material 75 to 100 mm (3 to 4 inches) thick around all sides of the instrument to provide a firm cushion and prevent movement inside the container. Protect the control panel with cardboard.
- d. Seal the shipping container securely.
- e. Mark the shipping container FRAGILE to assure careful handling.
- f. In any correspondence, refer to instrument model number and full serial number.



SECTION III OPERATION

INTRODUCTION

This section explains how to operate the Hewlett-Packard Model 11713A. Included in this section are the descriptions of front and rear panel controls, connectors and indicators, operator's checks, operating instructions, and operator maintenance. The last part of this section contains descriptions and diagrams explaining available rear panel connections for rf and coaxial switches, attenuators, and relays.

Local operating instructions and remote operation with the Hewlett-Packard Interface Bus (HP-IB) are explained below.

LOCAL OPERATION

This section contains information on the front panel features and the operator's check. When the Driver LINE switch is set to ON, the Driver comes up in LOCAL and all numbered front panel switches are illuminated.

WARNINGS

Before the instrument is switched on, all protective earth terminals, extension cords, auto-transformers, and devices connected to it should be connected to a protective earth grounded socket. Any interruption of the protective earth grounding will cause a potential shock hazard that could result in personal injury.

Only fuses with the required rated current and specified type should be used. Do not use repaired fuses or short circuited fuseholders. To do so could cause a shock or fire hazard.

Panel Features

The front and rear panel features are given in Figures 3-1 and 3-2. These include explanations of the controls, connectors and indicators.

Operator's Check

The operator's check is described in Table 3-1. This check provides the initial Driver turn-on procedure and local operation.

REMOTE OPERATION

The Driver can be operated through the Hewlett-Packard Interface Bus (HP-IB). Bus compatibility, operator's interface checks, programming, and data format are described in the following paragraphs.

Remote-only functions and all front panel functions (except the LINE switch) are programmable through the HP-IB.

The operator's HP-IB interface checks in Table 3-2 provide a test of the HP-IB to verify that the Driver can function with each of the applicable bus messages. The bus messages are described in Table 3-3.

For more information about HP-IB, refer to IEEE Std 488, ANSI Std MC1.1, the Hewlett-Packard Electronic Systems and Instruments catalog, and the booklet, "Tutorial Description of the Hewlett-Packard Interface Bus" (HP part number 5952-0156).

HP-IB Compatibility

The Driver's complete bus compatibility (as defined by IEEE Standard 488, and the identical ANSI Standard MC1.1) is described below Table 3-3. Table 3-3 also summarizes, in the left-hand column, the Driver's HP-IB capabilities in terms of the twelve bus messages. Foremost among these messages is the Data message. Data messages contain the program codes that set the Driver's outputs.

Remote Mode

Remote Capability. The Driver accepts commands from the bus in the remote mode. In remote, its front panel controls are disabled (except for the



Remote Mode (Cont'd)

LINE switch and the LOCAL pushbutton). The LOCAL pushbutton can be disabled by a local lockout command. The driver can be addressed to listen and when addressed to listen, the Driver will respond to the following messages: Data, Remote, Local Lockout, Clear Lockout/Set Local, and Abort.

Local-to-Remote Mode Changes. The Driver switches to remote operation upon receipt of the Remote message. The Remote message has two parts. They are:

- Remote enable bus control line (REN) set true
- Device listen address (MLA) received once (while REN is true).

The Driver's outputs and all control settings remain unchanged with the Local-to-Remote transition. The REMOTE LED is on when the Driver is in the remote state.

Local Mode

Local Capability. In local, the Driver's front-panel controls are fully operational and the instrument will respond to the Remote message. Whether addressed or not, it will also respond to the Local Lockout, Clear Lockout/Set Local, and the Abort messages.

Remote-to-Local Mode Changes. The Driver returns to local control upon receipt of the Clear Lockout/Set Local message (REN). If the Driver is

not in Local Lockout, it switches to local from remote when the front panel LOCAL key is pressed. With the remote-to-local transition, the Driver's outputs remain unchanged.

Local Lockout. The local lockout condition disables the front panel LOCAL key so that pressing the LOCAL key will not return the Driver to local mode. When local lockout is in effect, the Driver is returned to local under program control (sending Clear Lockout/Set Local) or by turning the Driver LINE switch OFF then ON.

NOTE

Returning to local by switching to OFF then ON, will defeat the purpose of local lockout and the system controller will lose control.

Addressing

The Driver's listen address is set by the slide switches on the rear panel. Refer to the paragraph on HP-IB Address Selection in Section II.

Data Messages

The state of the Driver is controlled by Data messages on the HP-IB. Data messages include the Driver's HP-IB Program Codes. The HP-IB Program Codes contain information for programming the front panel functions (except for the LINE switch). The driver receives data messages when addressed to listen.

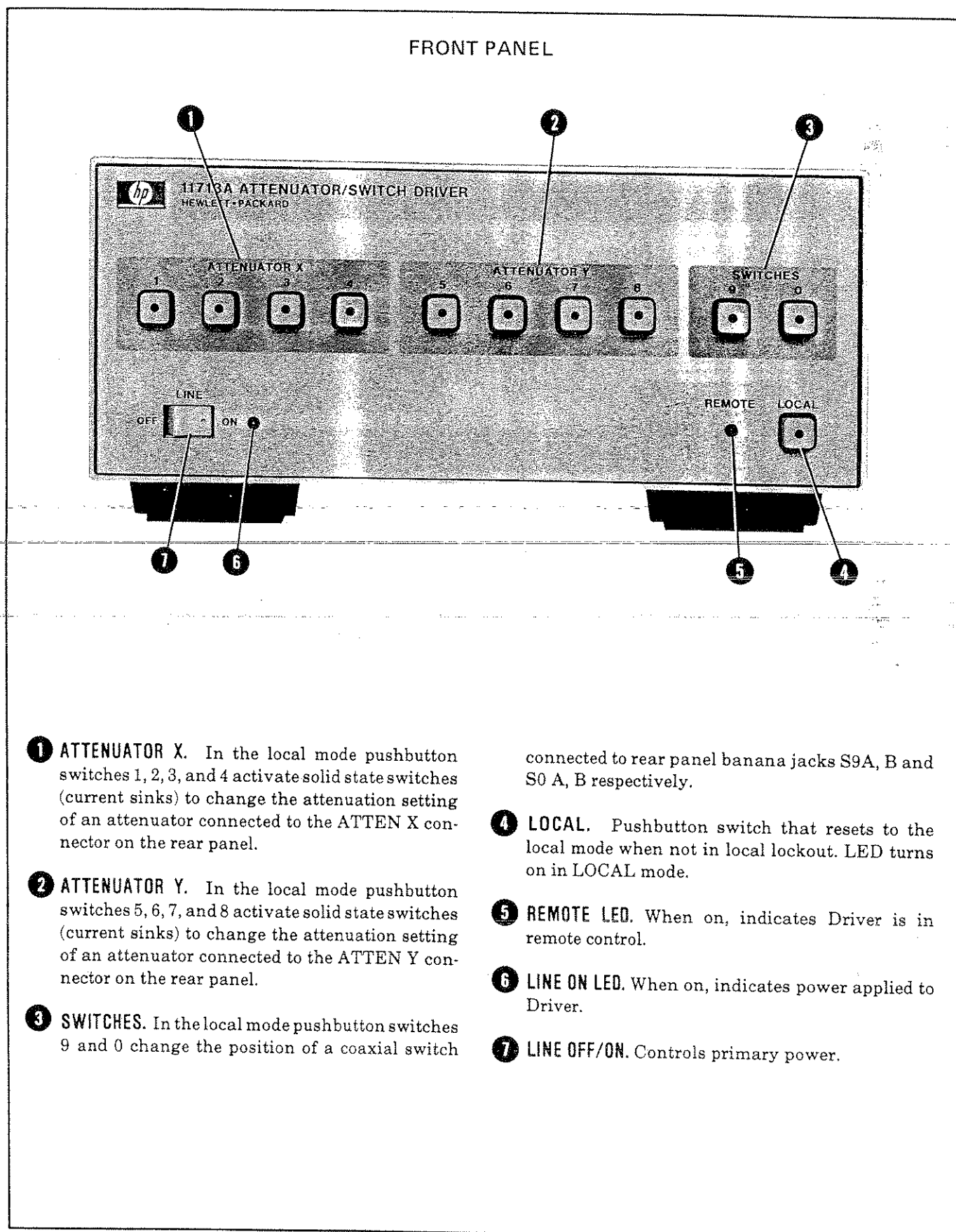

Figure 3-1. Front Panel Features

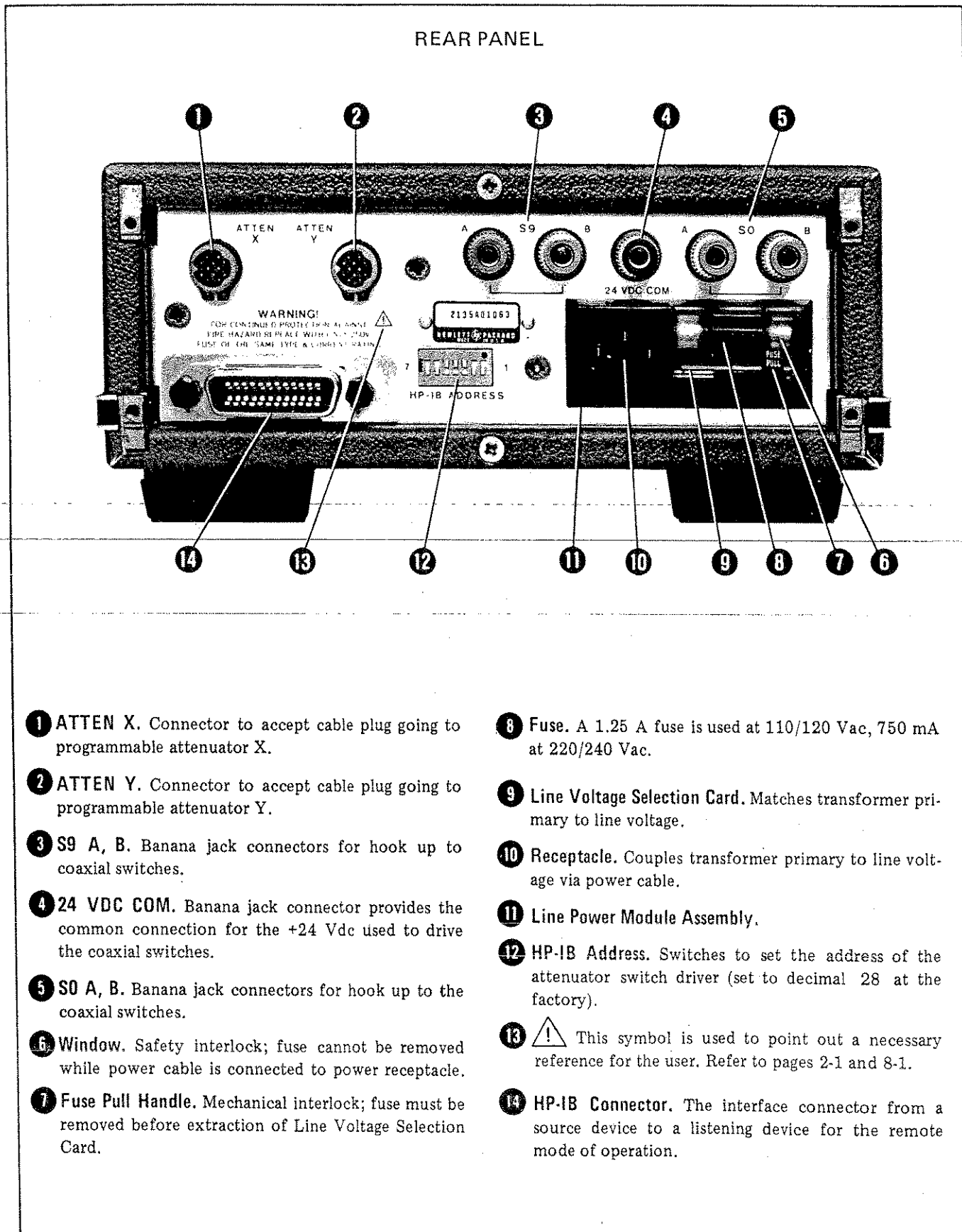

Figure 3-2. Rear Panel Features

Table 3-1. Operator's Check

INITIAL CONDITIONS

1. Verify that Driver power transformer primary is matched to line voltage by Line Voltage Selection Card.
2. Check Driver power fuse for correct rating. Correct fuse ratings for various line voltages are given on Line Power Module on rear panel. (See also Figure 2-1 and Table 2-1.)
3. Connect power cable to power receptacle.

LOCAL OPERATION

1. Connect equipment, which is to be used in your application, as shown below.

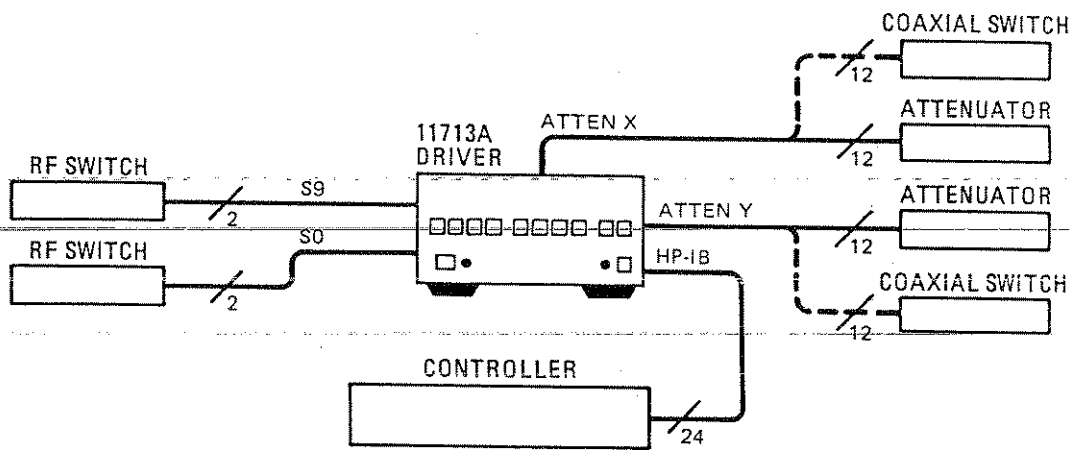

Local Operation Test Setup

2. Press LINE ON/OFF switch to ON. Switch should remain in ON position and green switch indicator LED should illuminate. All numbered pushbutton LEDs should be on and LOCAL LED should be on.
3. Depress 10 numbered pushbuttons on Driver front panel. Each LED should alternate between off and on as each key is pressed. In addition, if any equipment is connected (attenuators, relays or switches), an audible click should be heard from the unit actuated. Pressing any numbered pushbutton should not cause any other pushbutton to change state.



Table 3-2. Operator's HP-IB Interface Checks (2 of 3)

Remote Message

NOTE

This check assumes that the Driver is in the local state. If the Driver is in the remote state (front panel REMOTE light on), switch the Driver off, then on again.

Description	HP 9825A (HPL)	HP 9835A and 9845A (BASIC)
Remote: Send Remote Message to Driver	rem 7	REMOTE 7
Send select code-address combination to complete Remote message and address Driver to listen.	wrt 728	OUTPUT 728

OPERATOR'S RESPONSE

Check that Driver's REMOTE light turns on. If it does not, the Driver failed to process the Remote Message.

Receiving the Data Message

NOTE

This check determines if the Driver receives Data messages. The Driver must be in the remote state.

OPERATOR'S RESPONSE

Check that when the Driver first comes on and is set to the Remote state, that all front panel LEDs are on except LOCAL.

Description	HP 9825A (HPL)	HP 9835A and 9845A (BASIC)
Address Driver to listen and send Data messages.	wrt 728, "b1234567890"	OUTPUT 728, "B1234567890"
	wrt 728, "a1234567890"	OUTPUT 728, "A1234567890"

OPERATOR'S RESPONSE

After first Data Message ("b...") is sent, check that front-panel LEDs (digits) are off. After second Data Message ("a...") is sent, check that digit LEDs are on. If not, the Driver failed to process the Data Message.

Local Lockout and Clear Lockout/Set Local Messages

NOTE

This check requires the Bus to be in the remote state.

OPERATOR'S RESPONSE

Check that the Driver's REMOTE light is on.

Description	HP 9825A (HPL)	HP 9835A and 9845A (BASIC)
Local Lockout: Send Local Lockout Message.	llo 7	LOCAL LOCKOUT 7



Table 3-2. Operator's HP-IB Interface Checks (3 of 3)

Local Lockout and Clear Lockout/Set Local Messages (Cont'd)

OPERATOR'S RESPONSE Press LOCAL key on Driver's front panel. The REMOTE LED should remain on. If not, the Driver failed to process the Local Lockout Message.

Description	HP 9825A (HPL)	HP 9835A and 9845A (BASIC)
Clear Lockout/Set Local: Send Clear Lockout/Set Local message to clear Local Lockout messages and set all devices to Local (REN).	lcl 7	LOCAL 7

OPERATOR'S RESPONSE Check that LOCAL light is on and REMOTE light is off. Press numbered pushbutton switches and check that switches change status (LEDs on and off). If not, the Driver failed to process the Clear Lockout/Set Local Message.

Abort Message

NOTE This check determines if Driver is unaddressed by the Abort message. The Driver must be in remote state, be able to handshake, recognize its own address, and make remote/local changes. Do not use numbers "9" and "0". Enter and run the following applicable program.

The alpha code "a..." followed by a string of numbers indicates which attenuator sections are selected. The code "b..." and string of numbers indicates attenuator sections not selected.

HP 9825A

```
0: rem 7
1: wrt 728, "a12345678"
2: wrt 728, "b12345678"
3: gto 0
4: end
```

HP 9835A and HP 9845A

```
10 REMOTE 7
20 OUTPUT 728; "A12345678"
30 OUTPUT 728; "B12345678"
40 GOTO 10
50 END
```

Description	HP 9825A (HPL)	HP 9835A and 9845A (BASIC)
Send Abort Message to unaddress Driver.	cli 7	ABORT IO 7

OPERATOR'S RESPONSE Check that driver's front panel LEDs 1 through 8 blink each time Abort Message is sent. If not, then Driver is not processing Abort Message.



Table 3-3. HP-IB Message Reference Table

HP-IB Message	Applicable	Response	Related Commands and Controls*	Interface Functions*
Data	Yes	All front panel functions, except LINE ON/OFF switch, are programmable. The front panel REMOTE indicator turns on when addressed.		T0, L2, AH1, SH0
Trigger	No	The Driver does not respond to the trigger message.	GET	DT0
Clear	No	The Driver does not respond to the clear message.	DCL, SDC	DC0
Remote	Yes	The Driver remote mode is enabled when the REN bus line is true. However, it remains in local (i.e., the front panel is active) until it is addressed to listen the first time. The output signal is unchanged. The front panel REMOTE indicator turns on when in remote mode.	REN	RL1**
Local	No	The Driver does not respond to the Local message. See Clear Lockout/Set Local.	GTL	RL1**
Local Lockout	Yes	LOCAL key is disabled. Only the controller can return the Driver to local.	LLO	RL1**
Clear Lockout/Set Local	Yes	Driver goes to local and local lockout is cleared when REN goes false.	$\overline{\text{REN}}$	RL1**
Pass Control/Take Control	No	The Driver has no controller capability		C0
Require Service	No	The Driver cannot generate a service request command.	SRQ	SR0
Status Byte	No	The Driver does not respond to a serial poll.	SPE, SPD	T0
Status Bit	No	The Driver does not respond to a parallel poll.		PP0
Abort	Yes	The Driver stops listening.	IFC	T0, L2
<p>*Commands, Control lines and Interface Functions are defined in IEEE Std 488 and ANSI Std MC1.1. Knowledge of these might not be necessary if your controller's manual describes programming in terms of the twelve HP-IB Messages shown in the left column.</p> <p>**The Driver does not have complete RL1 capability since it can not process the Go-To-Local (GTL) message.</p>				

Complete HP-IB capability as defined in IEEE Std 488 and ANSI Std MC1.1 is:
SH0, AH1, T0, TE0, L2, LE0, DC0, DT0, RL1, C0, SR0, PP0.

Receiving the Data Message

The Driver responds to Data Messages when in remote and addressed to listen.

Data Message Input Format. The programming data string for the Driver consists of a string of ASCII coded characters composed of one or both of the following fields:

[Adm] [Bdn]

where A or a = general on command
 B or b = general off command
 dm = any digits 0—9 (excluding dn)
 dn = any digits 0—9 (excluding dm)

The Driver responds to an alphanumeric data string such as "A12B34" when the Driver is in the Remote state and addressed to listen. (The alpha characters in the data string can be either upper or lower case.)

The data string is further defined as follows:

Ax Bx Ay By A/B 9 A/B 0

where Ax Bx = Data string for ATTEN X; where x can be none, one or more of the digits 1, 2, 3 or 4.

Ay By = Data string for ATTEN Y; where y can be none, one or more of the digits 5, 6, 7 or 8. If Ax (Ay) uses a digit, then that digit may not be used in Bx (By).





A/B 9 = HP-IB Command for switch S9, and
 A/B 0 = HP-IB Command for switch S0.

e.g., "A12B34 A56B78 A9 B0"

The data string contains the operation selected by the operator (desired contact closure, value of attenuation, etc.). The coded command from the controller is converted by the Driver into control voltages. The output control voltages drive the device and illuminate front panel lights that indicate the operation selected. Table 3-4 shows the relationship between each programming code and the effect it has on the output at each connector/pin. Table 3-5 shows the programming strings required to set up various three- and four-section attenuators to the desired levels of attenuation.

Figures 3-3 and 3-4 show the rear panel connections and the HP-IB commands necessary to change the position of the SPDT RF Switch and the Coaxial Switch.

Table 3-4. HP-IB Control Statement Results

Front Panel Digits	Connector	Connector Pin Numbers	Command Result	
			A	B
1	ATTEN X	5	H	L
		6	L	H
		7	H	L
		8	L	H
2		9	H	L
		10	L	H
		11	H	L
		12	L	H
3	ATTEN Y	5	H	L
		6	L	H
		7	H	L
		8	L	H
		9	H	L
		10	L	H
		11	H	L
		12	L	H
4	S9	A		+24V
		B	+24V	
0	S0	A		+24V
		B	+24V	

H = Open (High)
 L = Closed (Low) — current sink to chassis ground
 = Connected to chassis ground.

For sample programs and explanations using the 9825A Desktop Computer, refer to the Programming Note, Index Number 11713A/9825A-1, an Introductory Operating Guide for the 11713A Attenuator/Switch with the 9825 Desktop Computer.

Program Execution Time. The response time for the Driver is defined as the time between data valid (DAV) changing from a high to a low and the output signal at the rear panel connector changing state. The switching speed of the Hewlett-Packard programmable attenuators is 20 ms including 10 μ s for the Driver (ATTEN outputs). The switching speed for the RF switches is 50 ms plus 20 ms for the driver (S9 and S0 outputs).

Sending the Data Message

The Driver does not have the capability of sending a Data message.



Table 3-5. Attenuation Levels and Corresponding Data Strings

0—11 dB or 0—110 dB Attenuation							
4-Section Attenuator (e.g., HP 8494 or HP 8496)							
ATTENUATOR X (Pushbuttons): 1 2 3 4				ATTENUATOR Y (Pushbuttons): 5 6 7 8			
Attenuator Section (dB): 1 2 4 4				Attenuator Section (dB): 10 20 40 40			
Attenuation (in dB)		Program Codes		Attenuation (in dB)		Program Codes	
X	Y	ATTEN X	ATTEN Y	X	Y	ATTEN X	ATTEN Y
0	0	B1234	B5678	6	60	A24B13	A68B57
1	10	A1B234	A5B678	7	70	A124B3	A568B7
2	20	A2B134	A6B578	8	80	A34B12	A78B56
3	30	A12B34	A56B78	9	90	A134B2	A578B6
4	40	A4B123	A8B567	10	100	A234B1	A678B5
5	50	A14B23	A58B67	11	110	A1234	A5678
0—70 dB Attenuation							
3-Section Attenuator (e.g., HP 8495)							
ATTENUATOR X (Pushbuttons): 1 2 3 4				ATTENUATOR Y (Pushbuttons): 5 6 7 8			
Attenuator Section (dB): 10 20 40 Not Used				Attenuator Section (dB): 10 20 40 Not Used			
Attenuation (in dB)		Program Codes		Attenuation (in dB)		Program Codes	
X or Y		ATTEN X	ATTEN Y	X or Y		ATTEN X	ATTEN Y
0		B123	B567	40		A3B12	A7B56
10		A1B23	A5B67	50		A13B2	A57B6
20		A2B13	A6B57	60		A23B1	A67B5
30		A12B3	A56B7	70		A123	A567
0—70 dB Attenuation							
4-Section Attenuator (e.g., HP 8495K)							
ATTENUATOR X (Pushbuttons): 1 2 3 4				ATTENUATOR Y (Pushbuttons): 5 6 7 8			
Attenuator Section (dB): 10 20 20 20				Attenuator Section (dB): 10 20 20 20			
Attenuation (in dB)		Program Codes		Attenuation (in dB)		Program Codes	
X or Y		ATTEN X	ATTEN Y	X or Y		ATTEN X	ATTEN Y
0		B1234	B5678	40		A24B13	A68B57
10		A1B234	A5B678	50		A124B3	A568B7
20		A4B123	A8B567	60		A234B1	A678B5
30		A14B23	A58B67	70		A1234	A5678



HP-IB COMMAND B9

HP-IB COMMAND "B9" CONNECTS PORT C AND PORT 2, ALSO TURNS FRONT PANEL LED FOR PUSHBUTTON 9 OFF.

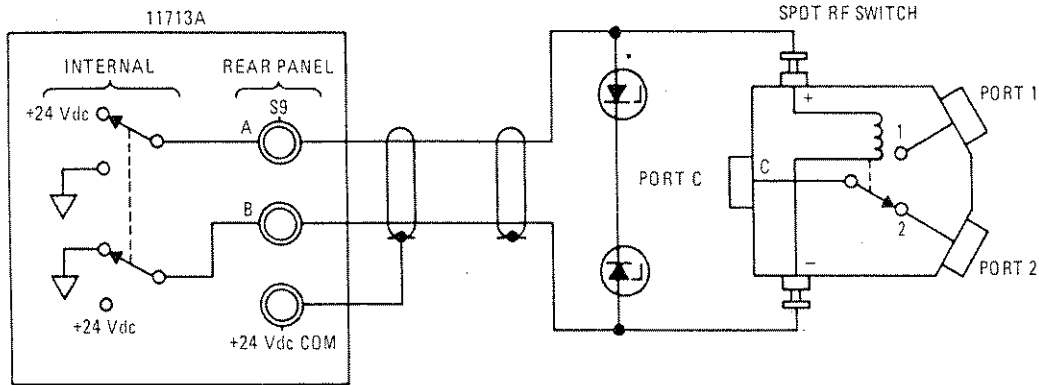

HP-IB COMMAND A9

HP-IB COMMAND "A9" CONNECTS PORT C AND PORT 1, ALSO TURNS FRONT PANEL LED FOR PUSHBUTTON 9 ON.

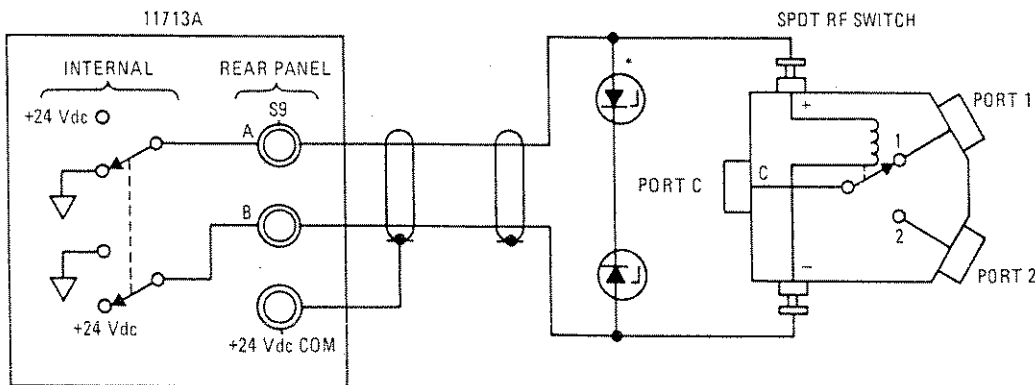

**When driving the HP 8671B, it is recommended that two 28.7V zener diodes be connected back to back across the terminals (HP Part No. 1902-0572).*

Figure 3-3. Connections for HP 8761B Switch

HP-IB COMMAND B0

HP-IB COMMAND "B0" CONNECTS PORT C AND PORT 1, ALSO TURNS FRONT PANEL LED FOR PUSHBUTTON 0 OFF.

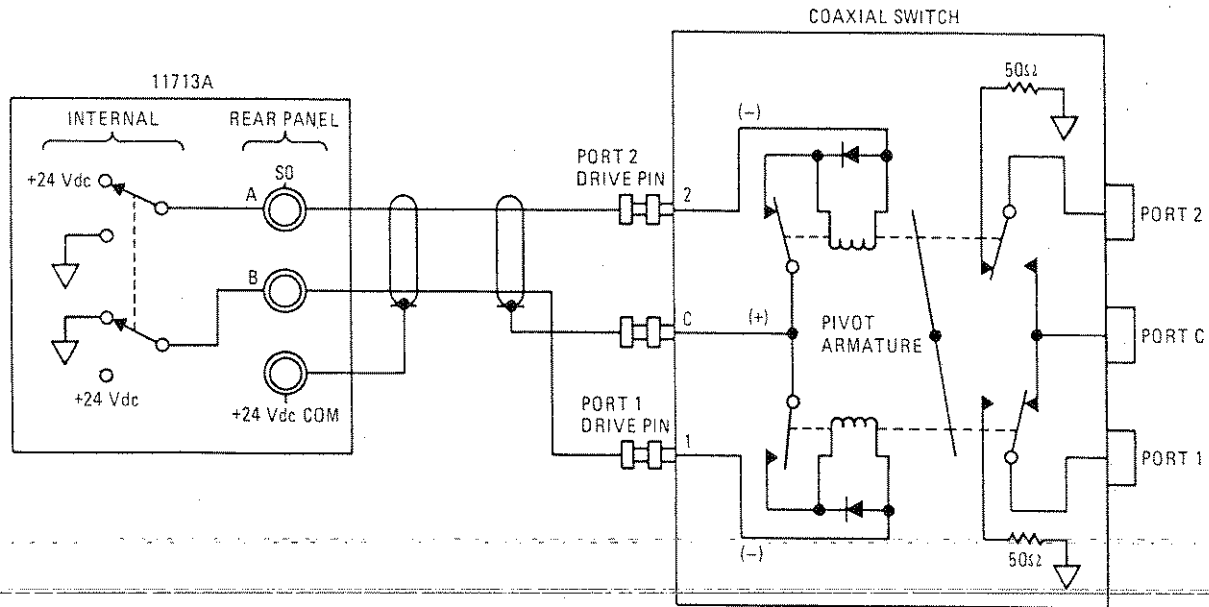

HP-IB COMMAND A0

HP-IB COMMAND "A0" CONNECTS PORT C AND PORT 2, ALSO TURNS FRONT PANEL LED FOR PUSHBUTTON 0 ON.

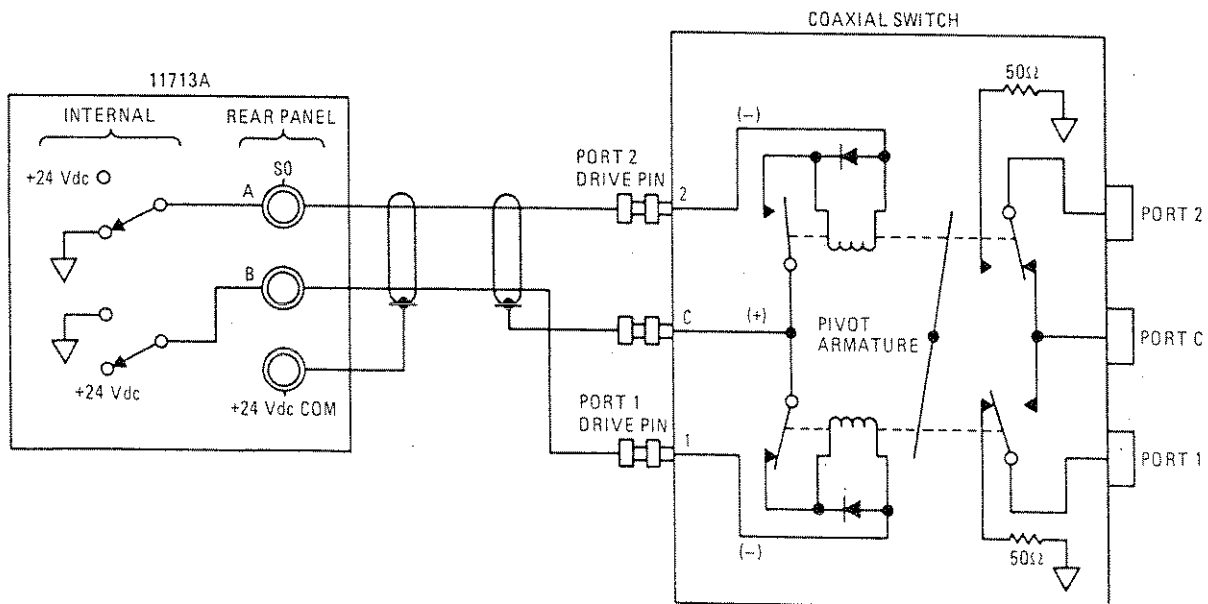

Figure 3-4. Connections for HP 33311 Series Switches

HP-IB**Receiving the Trigger Message**

The Driver does not respond to the Trigger message.

Receiving the Clear Message

The Driver does not respond to the Clear message.

Receiving the Remote Message

The Remote message causes the Driver to switch to the remote mode. The Remote message has two parts: the remote enable (REN) and address-to-listen. The Driver's outputs do not change with the local-to-remote transition. The REMOTE LED turns on when the Driver is in remote mode.

Receiving the Local Message

The Driver does not respond to the Local message. When the Driver is in remote mode, it can be returned to local mode with a Clear Lockout/Set Local message.

The front panel LOCAL key can also return the Driver to local mode. However, pressing the LOCAL key might interrupt a data message to the Driver. This would leave the Driver in a state unknown to the controller. This situation would be undesirable and is avoided by setting the Local Lockout condition which disables the LOCAL key.

Receiving the Local Lockout Message

The LOCAL pushbutton switch is disabled with Local Lockout in effect. The Driver is returned to local through program control by the controller.

NOTE

The Driver may also be returned to local by turning the Driver LINE switch OFF then ON, but this defeats the purpose of the Local Lockout and the system controller loses control.

Receiving the Clear Lockout/Set Local Message

The system controller sends a Clear Lockout/Set Local message to clear the Local Lockout condition and return all devices to local. No instrument settings are changed when going from local lockout (remote control) to local control.

Receiving the Pass Control Message

The Driver does not respond to the Pass Control message because it cannot act as a controller.

Sending the Require Service Message

The Driver cannot send a Require Service Message.

Sending the Status Byte Message

The Driver does not respond to a serial poll and as a result does not send the Status Byte message.

Sending the Status Bit Message

The Driver does not respond to a parallel poll and as a result does not send the Status Bit message.

Receiving the Abort Message

The Driver stops listening when it receives the Abort message. The Abort message is the means by which the controller sets the Interface Clear (IFC) bus line true.

OPERATOR MAINTENANCE

Operator maintenance is limited to replacement of the rear panel fuse. The main ac line fuse is located on the rear panel in the Line Power Module (see Figure 3-2). To remove the fuse, first remove the line power cable from its jack. Slide the fuse compartment cover to the left, then pull the handle marked FUSE PULL and remove the fuse.

WARNING

Be sure to select the correct fuse rating for the selected line voltage. Do not use repaired fuses or short circuited fuseholders. To do so could cause a shock or fire hazard. Fuse ratings are listed on the label attached to the Line Power Module.

CONNECTIONS TO 11713A ATTENUATOR DRIVERS**General**

In the 11713A circuitry, each front panel ATTENUATOR X or ATTENUATOR Y pushbutton controls a pair of transistor drivers (see Figures 3-6 and 8-13). (The front panel pushbuttons are also separately programmable.) While one transistor is saturated and its output is grounded, the other transistor is cutoff and floats at a high impedance. A common 24V line provides the driving power for the external devices. The devices controlled may total up to ten if the total load current is equal to or less than 650 mA. No one device may sink more than 650 mA.

NOTE

To drive ten devices, the 11713A requires attenuator cables connected at ATTEN X and Y and switch cables connected to S9 and S0.

It is recommended that two 28.7V zener diodes be connected back-to-back across the relay coils to reduce voltage transients (HP Part No. 1902-0572).

The attenuator cables (see Figure 3-5) are supplied with 12-pin connectors that may not be useable on some equipment. In these instances, the cables may be modified by removing a connector. (A 9-wire cable with only one connector is available under HP part number 8120-2178.) Table 3-6 describes the cable wire colors/connector pin numbers and corresponding status of the front panel pushbutton indicators. To drive a simple non-latching relay, only one wire in a pair needs to be used for the ground (Figure 3-6).

Driving Additional Coaxial Switches

Figure 3-4 shows the rear panel connections and the HP-IB commands necessary to change the position of HP 33311 series coaxial switches. These connections are made to the S0 outputs. (Connections to the S9 output can also be used.) However, control for the HP 33311 coaxial switches may also come from the rear panel ATTEN X output or ATTEN Y output. Figure 3-5 illustrates the connections/pin numbers for each connector: ATTEN X or ATTEN Y. By using these same connections to 33311 switches, control can be extended to four additional switches or eight switches if both outputs are used and to 10 switches if the S9 and S0 outputs are also used.

NOTE

Because of voltage and current limitations this application applies to the standard 33311B and not to Option 011.

Table 3-6. Attenuator Cable Connector Pin Numbers and Wire Color Codes

Front Panel Pushbuttons*		Rear Panel connectors ATTEN X or Y, and Attenuator Cable	
ATTENUATOR X, Y and SWITCHES		Pin Numbers	Attenuator Cable Wire Color Code
Pushbutton Number	Pushbutton LEDs		
SWITCHES		1	Red (24 Vdc)
		2	White/Brown (Gnd)
		3,4	
		(Connected to S9 and S0 outputs)	
9	ON	ATTEN X 3 (S9-A)	Gray
9	OFF	ATTEN X 4 (S9-B)	White/Red
0	ON	ATTEN Y 3 (S0-A)	Gray
0	OFF	ATTEN Y 4 (S0-B)	White/Red
ATTENUATOR			
X	Y		
1	5	5	Violet
		6	Yellow
2	6	7	Black
		8	Green
3	7	9	Orange
		10	Blue
4	8	11	Brown
		12	White

*The ON/OFF status of the pushbutton lamps indicates which cable wire or pin on the rear panel connector is grounded. For example, if ATTENUATOR X pushbutton 3 is illuminated, pin 10 of the ATTEN X connector (blue wire of the cable) is grounded and pin 9 floats at a high impedance. For the SWITCHES, if pin 3 is grounded (lamp on), pin 4 is connected to +24V.

Connections for Four-Section Attenuator

A typical connection for a programmable four-section attenuator is provided in Figure 3-5. To use one four-section attenuator assembly, an attenuator cable is connected to either the ATTEN X output (A6J1) or ATTEN Y output (A6J2); both outputs must be connected to have more than four attenuator segments.

simple non-latching relays. With connections to both the attenuator and switch outputs on the rear panel, a total of 10 relays may be on at one time (if total current is less than 650 mA). However, since there are dual transistor and relay drivers, where one driver is on while the other is off, a total of 20 relays may be controlled.

Relay Drivers

Figure 3-6 shows the connections for a simplified relay driving circuit. This circuit is adaptable for

CAUTION

If the total continuous load current of 650 mA is exceeded, damage may result.

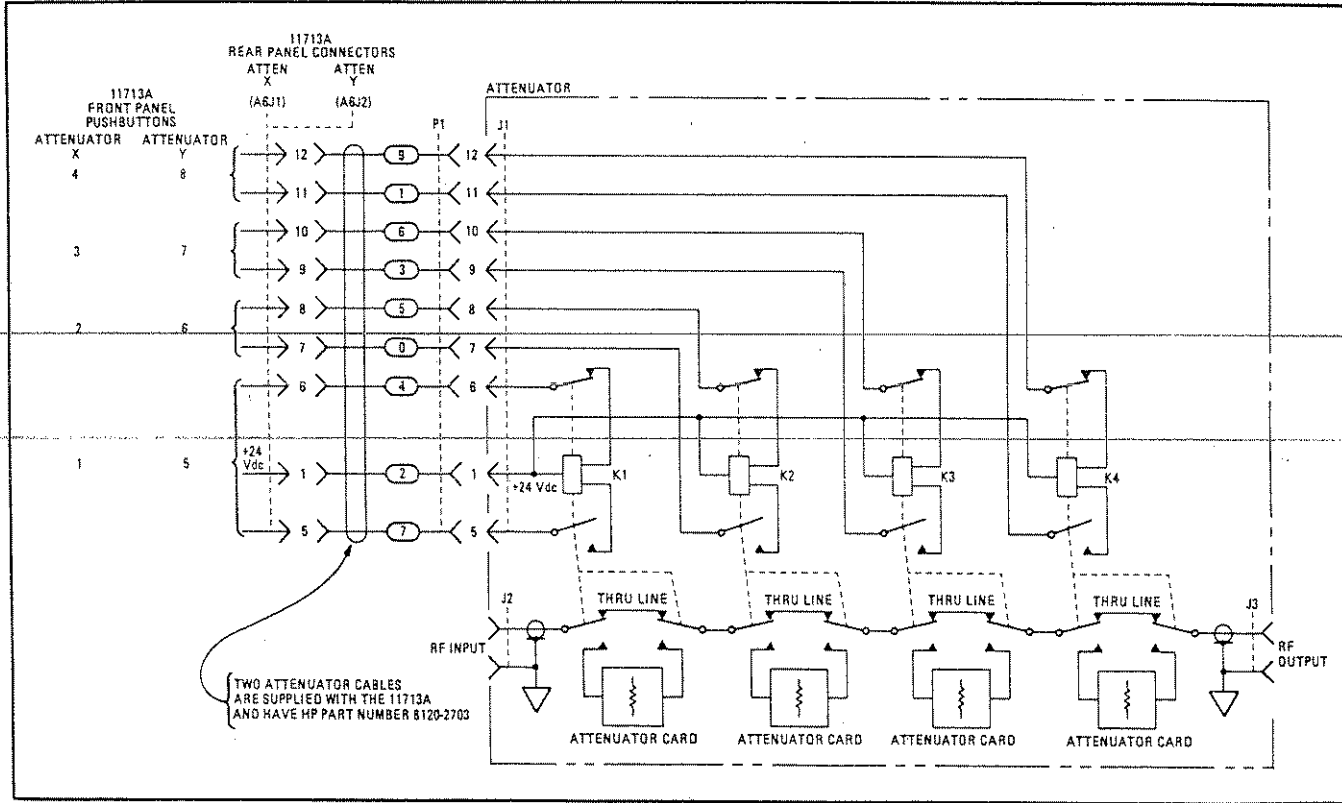

Figure 3-5. Typical Connections for Programmable Four-Section Attenuator

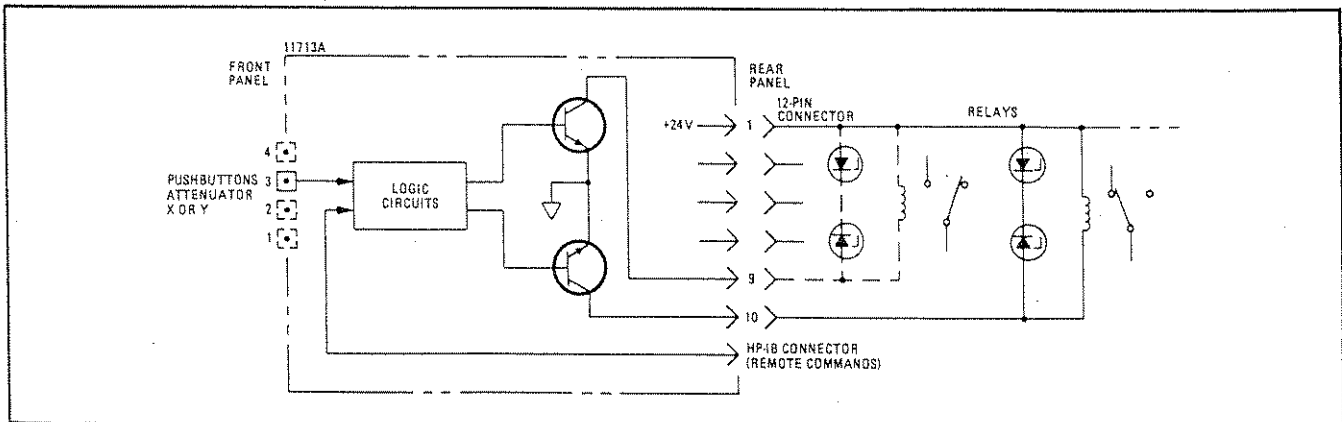

Figure 3-6. Relay Driving Circuit

SECTION IV PERFORMANCE TESTS

INTRODUCTION

The procedure in this section tests the instrument's electrical performance.

The test can be performed without access to the interior of the instrument.

PERFORMANCE TEST

Test equipment and accessories required to perform the test are listed in Table 1-3. Equipment other than the recommended models can be used provided the minimum specifications are satisfied.

PERFORMANCE TESTS

OPERATIONAL VERIFICATION

DESCRIPTION This procedure checks the Driver to give reasonable assurance that it is working properly by performing checks on major functions. This test and the local operator's check in Section III will ensure that the Driver is operational.

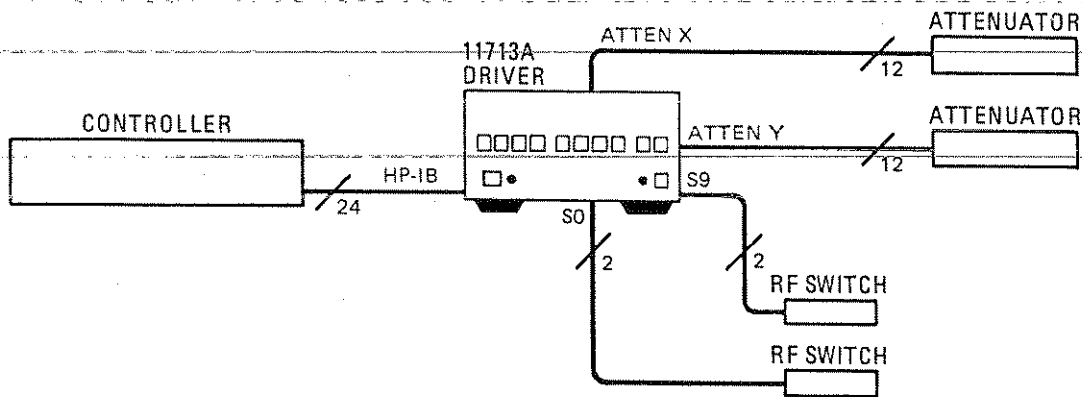

Figure 4-1. Operational Verification Test Setup

EQUIPMENT:

Controller	HP 9825A
Attenuators (2)	HP 8495K
RF Switches (2)	HP 8761B

- PROCEDURE:**
1. Connect equipment as shown.
 2. Key in program shown in Table 4-1.
 3. Run the program following instructions given in the display of the controller.

Table 4-1. Performance Check Program Using 9825A Controller (1 of 3)

```

0: "11713A OPERATOR'S CHECK":
1: dim Y$(3)
2: dev "ASD",703;fxd 0;spc 4
3: "X=time between switching commands":100+X
4: "E=Error counter":0+E
5:
6: beep;dsp "SET Address Switches to 0000011";stp ;rem 7
7:
8: cll 'LdOf';beep;dsp "REMOTE LED ON and #'s OFF?(y/n)"
9: cll 'chkerr'
10: cll 'LdOn';beep;dsp "REMOTE LED ON and #'s ON?(y/n)"
11: cll 'chkerr'
12: lcl 7;rem 7;beep;dsp "LOCAL LED ON and #'s ON?(y/n)"
13: cll 'chkerr'
14: cll 'LdOf';beep;dsp "REMOTE LED ON and #'s OFF?(y/n)"
15: cll 'chkerr'
16: cll 'LdOf';beep;dsp "REMOTE LED ON and #'s OFF?(y/n)"
17: cll 'chkerr'
18: beep;dsp "Depress 11713A LOCAL BUTTON";stp
19: beep;dsp "11713A LOCAL LED ON?(y/n)"
20: cll 'chkerr'
21: beep;dsp "Press LOCAL button for 20seconds";llo 7
22: wait 8500;500+X
23: beep;dsp "Did #'s change state?(y/n)"
24: cll 'LdOn';cll 'LdOf'
25: cll 'chkerr'
26:
27: beep;dsp "SET Address Switches to 0011100";stp
28:
29: 1234567890+J;for K=1 to 10
30: wrt 728,"a"&str(J);wait X
31: wrt 728,"b"&str(J);wait X
32: dsp "All #'s LED should Switch ON&OFF"
33: next K
34: beep;dsp "Did #'s LEDS switch ON&OFF?(y/n)"
35: cll 'chkerr'
36: if E=0;prt "NO ERRORS","END OF CHECK"
37: if E#0;prt "NUMBER ERRORS=",E,"","END OF CHECK"
38: end
39:
40: "LdOn":for J=1 to 10;wrt "ASD","A"&str(10frc(J/10));gto +2
41: "LdOf":for J=1 to 10;wrt "ASD","B"&str(10frc(J/10))
42: wait X;next J;ret
43: "chkerr":ent "",Y$;if pos(cap(Y$),"Y")=1;ret
44: l+E+E;ret

```

Table 4-1. Performance Check Program Using 9825A Controller (2 of 3)

- 0: Comment line identifying Driver number and type of check.
- 1: Dimension a (1×3) array for yes or no response.
- 2: Device "ASD" attenuator switch driver with address 703; fixed format for zero digits to right of decimal point; space four lines.
- 3: Comment setting time of 100 ms between switching commands and place in variable X.
- 4: Comment and setting counter "E" for error count.
- 6: Calculator outputs audible tone and an instruction in calculator display; stops program, waiting for continue button to be pressed; remote message (REN) to Driver.
- 8: Calls subroutine LED off; calculator outputs audible tone; comment question in calculator display, is REMOTE LED on and numbered pushbutton LEDs off? Press y or n (yes or no).
- 9: Calls subroutine labeled check error; a no response is stored here.
- 10: Calls subroutine labeled LED on; calculator outputs audible tone; comment question in calculator display, is REMOTE LED on and numbered pushbutton LEDs off? Press y or n (yes or no).
- 11: Same as 9.
- 12: Sets bus to local (REN); then sends remote message (REN) to Driver; calculator outputs audible tone; comment question in calculator display, is LOCAL LED on and numbered pushbutton LEDs on? Press y or n (yes or no).
- 13: Same as 9.
- 14: Call subroutine LEDs off; calculator outputs audible tone; comment question in calculator display, is REMOTE LED on and numbered pushbutton LEDs off? Press y or n (yes or no).
- 15: Same as 9.
- 16: Calls subroutine LEDs off; calculator outputs audible tone; comment question in calculator display, is REMOTE LED on and numbered pushbutton LEDs off? Press y or n (yes or no).
- 17: Same as 9.
- 18: Calculator outputs audible tone; comment instruction in calculator display, press LOCAL pushbutton; causes program to stop.
- 19: Calculator outputs audible tone; comment question in calculator display, is LOCAL LED on? Press y or n (yes or no).
- 20: Same as 9.
- 21: Calculator outputs audible tone; comment instruction in calculator display; sends local lockout to Driver and, holding LOCAL pushbutton, checks to see if return to local is defeated.
- 22: Causes program to wait 8500 ms; assigns 500 to variable X.

Table 4-1. Performance Check Program Using 9825A Controller (3 of 3)

- 23: Calculator outputs audible tone; comment question in calculator display, did numbered pushbutton LEDs change state? Press y or n (yes or no).
- 24: Calls subroutine LEDs on and subroutine LEDs off.
- 25: Same as 9.
- 27: Calculator outputs audible tone; comment instruction in calculator display, set Driver address switches to binary 0011100 or decimal 28; causes program to stop.
- 29: Assign string values to variable "J" corresponding to front panel switch numbers; set up counter "K" for 1 to 10.
- 30: Addressed to listen message sent to Driver; use lower case "a" and the string in "J" to turn pushbutton LEDs on; wait assigned time in variable X.
- 31: Addressed to listen message sent to Driver; use lower case "b" and the string in "J" to turn pushbutton LEDs off; wait assigned time variable X.
- 32: Comment in calculator display noting all of the numbered pushbutton LEDs should switch on and off.
- 33: Repeat for next value of "K".
- 34: Calculator outputs audible tone; comment question in calculator display, did numbered pushbutton LEDs change state? Press y or n (yes or no).
- 35: Same as 9.
- 36: If counter "E" is equal to zero, print "NO ERRORS" and "END OF CHECK" on calculator printer.
- 37: If counter "E" does not equal zero, then print "NUMBER ERRORS" in "E" and "END OF CHECK" on calculator printer.
- 38: Causes program to stop and resets program line counter to zero.
- 40: Label for subroutine to turn LEDs on, as the counter "J" increments from 1 to 10; address Driver to listen; use upper case A and the string of 10 times the fraction of "J" over 10 to turn LEDs on. Go to line 42.
- 41: Label for subroutine to turn LEDs off, as the counter "J" increments from 1 to 10; address Driver to listen; use upper case B and the string of 10 times the fraction of "J" over 10 to turn LEDs off.
- 42: Causes program to wait for time in "X"; repeat for next value of "J"; returns program execution at end of a subroutine to line following the statement that called the subroutine.
- 43: Label for subroutine to count errors; prompt causing program to wait for entry of (values of variables) y or n from keyboard; this entry goes into the array. Take first letter entered, convert it to capitals. It is Y, then return. If it is N, then next statement.
- 44: Increment error counter "E" return.

SECTION V ADJUSTMENTS

The 11713A has no internal electrical or mechanical adjustments.



SECTION VI REPLACEABLE PARTS

INTRODUCTION

This section contains information for ordering parts. Table 6-1 lists abbreviations used in the parts list and throughout the manual. Table 6-2 lists all replaceable parts in reference designator order. Table 6-3 contains the names and addresses that correspond to the manufacturer's code numbers.

ABBREVIATIONS

Table 6-1 lists abbreviations used in the parts list, schematics and throughout the manual. In some cases, two forms of the abbreviation are used, one all capital letters, and one partial or no capitals. This occurs because the abbreviations in the parts list are always all capitals. However, in the schematics and other parts of the manual, other abbreviation forms are used with lower case and upper case letters.

REPLACEABLE PARTS

Table 6-2 lists all replaceable parts in reference designator order. Table 6-3 contains the names

and addresses that correspond to the manufacturer's code numbers.

ORDERING INFORMATION

To order a part listed in the replaceable parts table, quote the Hewlett-Packard part number with the check digit (CD), indicate the quantity required, and address the order to the nearest Hewlett-Packard office (see NOTE below). The check digit will ensure accurate and timely processing of your order. To order a part that is not listed in the replaceable parts table, include the instrument model number, instrument serial number, the description and function of the part, and the number of parts required.

NOTE

Within the USA, it is better to order directly from the HP Parts Center in Mt. View, California. Ask your nearest HP office for information and forms for the "Direct Mail Order System."

Table 6-1. Reference Designations and Abbreviations (1 of 2)

REFERENCE DESIGNATIONS

A assembly	E miscellaneous electrical part	P electrical connector (movable portion); plug	U integrated circuit; microcircuit
AT attenuator; isolator; termination	F fuse	Q transistor; SCR; triode thyristor	V electron tube
B fan; motor	FL filter	R resistor	VR voltage regulator; breakdown diode
BT battery	H hardware	RT thermistor	W cable; transmission path; wire
C capacitor	HY circulator	S switch	X socket
CP coupler	J electrical connector (stationary portion); jack	T transformer	Y crystal unit (piezo-electric or quartz)
CR diode; diode thyristor; varactor	K relay	TB terminal board	Z tuned cavity; tuned circuit
DC directional coupler	L coil; inductor	TC thermocouple	
DL delay line	M meter	TP test point	
DS annunciator; signaling device (audible or visual); lamp; LED	MP miscellaneous mechanical part		

ABBREVIATIONS

A ampere	COEF coefficient	EDP electronic data processing	INT internal
ac alternating current	COM common	ELECT electrolytic	kg kilogram
ACCESS accessory	COMP composition	ENCAP encapsulated	kH _z kilohertz
ADJ adjustment	COMPL complete	EXT external	kΩ kilohm
A/D analog-to-digital	CONN connector	F farad	kV kilovolt
AF audio frequency	CP cadmium plate	FET field-effect transistor	lb pound
AFC automatic frequency control	CRT cathode-ray tube	F/F flip-flop	LC inductance-capacitance
AGC automatic gain control	CTL complementary transistor logic	FH flat head	LED light-emitting diode
AL aluminum	CW continuous wave	FIL H fillister head	LF low frequency
ALC automatic level control	cm centimeter	FM frequency modulation	LG long
AM amplitude modulation	D/A digital-to-analog	FP front panel	LH left hand
AMPL amplifier	dB decibel	FREQ frequency	LIM limit
APC automatic phase control	dBm decibel referred to 1 mW	FXD fixed	LIN linear taper (used in parts list)
ASSY assembly	dc direct current	g gram	lin linear
AUX auxiliary	deg degree (temperature interval or difference)	GE germanium	LK WASH lock washer
avg average	° degree (plane angle)	GHz gigahertz	LO low; local oscillator
AWG American wire gauge	°C degree Celsius (centigrade)	GL glass	LOG logarithmic taper (used in parts list)
BAL balance	°F degree Fahrenheit	GND ground(ed)	log logarithm(ic)
BCD binary coded decimal	°K degree Kelvin	H henry	LPF low pass filter
BD board	DEPC deposited carbon	h hour	LV low voltage
BE CU beryllium copper	DET detector	HET heterodyne	m metre (distance)
BFO beat frequency oscillator	diam diameter	HEX hexagonal	mA milliampere
BH binder head	DIA diameter (used in parts list)	HD head	MAX maximum
BKDN breakdown	DIFF AMPL differential amplifier	HDW hardware	MΩ megohm
BP bandpass	div division	HF high frequency	MEG meg (10 ⁶) (used in parts list)
BPF bandpass filter	DPDT double-pole, double-throw	HG mercury	MET FLM metal film
BRS brass	DR drive	HI high	MET OX metallic oxide
BWO backward-wave oscillator	DSB double sideband	HP Hewlett-Packard	MF medium frequency; microfarad (used in parts list)
CAL calibrate	DTL diode transistor logic	HPPF high pass filter	MFR manufacturer
ccw counter-clockwise	DVM digital voltmeter	HR hour (used in parts list)	mg milligram
CER ceramic	ECL emitter coupled logic	HV high voltage	MHz megahertz
CHAN channel	EMF electromotive force	H _z Hertz	mH millihenry
cm centimeter		IC integrated circuit	mho mho
CMO cabinet mount only		ID inside diameter	MIN minimum
COAX coaxial		IF intermediate frequency	min minute (time)
		IMPG impregnated	.' minute (plane angle)
		IN inch	MINAT miniature
		INCD incandescent	mm millimeter
		INCL include(s)	
		INP input	
		INS insulation	

NOTE

All abbreviations in the parts list will be in upper-case.

Table 6-1. Reference Designations and Abbreviations (2 of 2)

MOD modulator	OD outside diameter	PWV peak working voltage	TD time delay
MOM momentary	OH oval head	RC resistance-capacitance	TERM terminal
MOS metal-oxide semiconductor	OP AMPL operational amplifier	RECT rectifier	TFT thin-film transistor
ms millisecond	OPT option	REF reference	TGL toggle
MTG mounting	OSC oscillator	REG regulated	THD thread
MTR meter (indicating device)	OX oxide	REPL replaceable	THRU through
mV millivolt	oz ounce	RF radio frequency	TI titanium
mVac millivolt, ac	Ω ohm	RFI radio frequency interference	TOL tolerance
mVdc millivolt, dc	P peak (used in parts list)	RH round head; right hand	TRIM trimmer
mVpk millivolt, peak	PAM pulse-amplitude modulation	RLC resistance-inductance-capacitance	TSTR transistor
mVp-p millivolt, peak-to-peak	PC printed circuit	RMO rack mount only	TTL transistor-transistor logic
mVrms millivolt, rms	PCM pulse-code modulation; pulse-count modulation	RMS root-mean-square	TV television
mW milliwatt	PDM pulse-duration modulation	RND round	TVI television interference
MUX multiplex	pF picofarad	ROM read-only memory	TWT traveling wave tube
MY mylar	PH BRZ phosphor bronze	R&P rack and panel	U micro (10^6) (used in parts list)
μ A microampere	PHL Phillips	RWV reverse working voltage	UF microfarad (used in parts list)
μ F microfarad	PIN positive-intrinsic-negative	S scattering parameter	UHF ultrahigh frequency
μ H microhenry	PIV peak inverse voltage	s second (time)	UNREG unregulated
μ mho micromho	pk peak	" second (plane angle)	V volt
μ s microsecond	PL phase lock	S-B slow-blow (fuse) (used in parts list)	VA voltampere
μ V microvolt	PLO phase lock oscillator	SCR silicon controlled rectifier; screw	Vac volts, ac
μ Vac microvolt, ac	PM phase modulation	SE selenium	VAR variable
μ Vdc microvolt, dc	PNP positive-negative-positive	SECT sections	VCO voltage-controlled oscillator
μ Vpk microvolt, peak	P/O part of	SEMICON semiconductor	Vdc volts, dc
μ Vp-p microvolt, peak-to-peak	POLY polystyrene	SHF superhigh frequency	VDCW volts, dc, working (used in parts list)
μ Vrms microvolt, rms	PORC porcelain	SI silicon	V(F) volts, filtered
μ W microwatt	POS positive; position(s) (used in parts list)	SIL silver	VFO variable-frequency oscillator
nA nanoampere	POSN position	SL slide	VHF very-high frequency
NC no connection	POT potentiometer	SNR signal-to-noise ratio	Vpk volts, peak
N/C normally closed	P-P peak-to-peak	SPDT single-pole, double-throw	VP-p volts, peak-to-peak
NE neon	PP peak-to-peak (used in parts list)	SPG spring	Vrms volts, rms
NEG negative	PPM pulse-position modulation	SR split ring	VSWR voltage standing wave ratio
nF nanofarad	PREAMPL preamplifier	SPST single-pole, single-throw	VTO voltage-tuned oscillator
NI PL nickel plate	PRF pulse-repetition frequency	SSB single sideband	VTVM vacuum-tube voltmeter
N/O normally open	PRR pulse repetition rate	SST stainless steel	V(X) volts, switched
NOM nominal	ps picosecond	STL steel	W watt
NORM normal	PT point	SQ square	W/ with
NPN negative-positive-negative	PTM pulse-time modulation	SWR standing-wave ratio	WIV working inverse voltage
NPO negative-positive zero (zero temperature coefficient)	PWM pulse-width modulation	SYNC synchronize	WW wirewound
NRFR not recommended for field replacement		T timed (slow-blow fuse)	W/O without
NSR not separately replaceable		TA tantalum	YIG yttrium-iron-garnet
ns nanosecond		TC temperature compensating	Z ₀ characteristic impedance
nW nanowatt			
OBD order by description			

NOTE

All abbreviations in the parts list will be in upper-case.

MULTIPLIERS

Abbreviation	Prefix	Multiple
T	tera	10^{12}
G	giga	10^9
M	mega	10^6
k	kilo	10^3
da	deka	10
d	deci	10^{-1}
c	centi	10^{-2}
m	milli	10^{-3}
μ	micro	10^{-6}
n	nano	10^{-9}
p	pico	10^{-12}
f	femto	10^{-15}
a	atto	10^{-18}

Table 6-2. Replaceable Parts

Reference Designation	HP Part Number	C D	Qty	Description	Mfr Code	Mfr Part Number
A1†	11713-60012	1	1	INTERCONNECT & POWER SUPPLY ASSEMBLY	28480	11713-60012
A1C1	0180-2181 2680-0129 2190-0011	4 8 8	1 8 8	CAPACITOR-FXD 1300UF+75-10% 50VDC AL SCREW-MACH 10-32 .312-IN-LG PAN-HD-POZI WASHER-LK INTL T NO. 10 .195-IN-ID	00853 00000 28480	539-7471-02 ORDER BY DESCRIPTION 2190-0011
A1C2	0180-2221 2680-0129 2190-0011	3 8 8	1 8 8	CAPACITOR-FXD 7200UF+75-10% 15VDC AL SCREW-MACH 10-32 .312-IN-LG PAN-HD-POZI WASHER-LK INTL T NO. 10 .195-IN-ID	28480 00000 28480	0180-2221 ORDER BY DESCRIPTION 2190-0011
A1C3	0180-0291	3	1	CAPACITOR-FXD 1UF+-10% 35VDC TA	56289	150D105X9035A2
A1C4	0180-2141	6	1	CAPACITOR-FXD 3.3UF+-10% 50VDC TA	56289	150D335X9050B2
A1C5	0180-0197	8	1	CAPACITOR-FXD 2.2UF+-10% 20VDC TA	56289	150D225X9020A2
A1CR1	1901-0159	3	4	DIODE-PWR RECT 400V 750MA DO-41	28480	1901-0159
A1CR2	1901-0200	5	2	DIODE-PWR RECT 100V 1.5A	28480	1901-0200
A1CR3	1901-0159	3	3	DIODE-PWR RECT 400V 750MA DO-41	28480	1901-0159
A1CR4	1901-0159	3	3	DIODE-PWR RECT 400V 750MA DO-41	28480	1901-0159
A1CR5	1901-0200	5	5	DIODE-PWR RECT 100V 1.5A	28480	1901-0200
A1CR6	1901-0159	3	3	DIODE-PWR RECT 400V 750MA DO-41	28480	1901-0159
A1J1	1251-3283	1	1	CONNECTOR 24-PIN F MICRORIBBON	28480	1251-3283
A1J2	1251-5316	5	4	CONNECTOR, 34-PIN	28480	1251-5316
A1J3	1251-5316	5	5	CONNECTOR, 34-PIN	28480	1251-5316
A1J4	1251-3898	4	1	CONNECTOR 10-PIN M POST TYPE	28480	1251-3898
A1MP1	11713-80001 2200-0147 2260-0009	0 4 3	2 2 2	CLEVIS, MODIFIED SCREW-MACH 4-40 .5-IN-LG PAN-HD-POZI NUT-HEX-W/LKWR 4-40-THD .094-IN-THK (ATTACHES J1 TO MOTHER BOARD (A1))	28480 28480 00000	11713-80001 2200-0147 ORDER BY DESCRIPTION
A1MP2	11713-80001 2200-0147 2260-0009	0 4 3	0 4 3	CLEVIS, MODIFIED SCREW-MACH 4-40 .5-IN-LG PAN-HD-POZI NUT-HEX-W/LKWR 4-40-THD .094-IN-THK	28480 28480 00000	11713-80001 2200-0147 ORDER BY DESCRIPTION
A1MP3†	11713-00014	7	1	SUPPORT INTERCONNECT BOARD	28480	11713-00014
A1Q1†	1884-0244	9	1	THYRISTOR-SCR VRRM=400	3L585	S2600D
A1R1	1810-0136	3	2	NETWORK-RES 10-SIP MULTI-VALUE	28480	1810-0136
A1R2	1810-0136	3	3	NETWORK-RES 10-SIP MULTI-VALUE	28480	1810-0136
A1R3	1810-0041	9	1	NETWORK-RES 9-SIP2.7K OHM X 8	28480	1810-0041
A1R4	0698-0082	7	1	RESISTOR 464 1% .125W F TC=0+-100	24546	C4-1/8-T0-4640-F
A1R5	0757-0438	3	3	RESISTOR 5.11K 1% .125W F TC=0+-100	24546	C4-1/8-T0-5111-F
A1TP1	1251-0600	0	2	CONNECTOR-SGL CONT PIN 1.14-MM-BSC-SZ SQ	28480	1251-0600
A1TP2	1251-0600	0	0	CONNECTOR-SGL CONT PIN 1.14-MM-BSC-SZ SQ	28480	1251-0600
A1U1	1826-0181 2360-0205 2190-0008 3050-0066 2190-0006 2420-0002 1400-0017 2360-0121	1 3 3 8 1 6 0 2	1 1 1 3 3 3 4 1	IC V RGLTR T0-3 SCREW-MACH 6-32 .75-IN-LG PAN-HD-POZI WASHER-LK EXT T NO. 6 .141-IN-ID WASHER-FL MTLG NO. 6 .147-IN-ID WASHER-LK HLCL NO. 6 .141-IN-ID NUT-HEX-DBL-CHAM 6-32-THD .109-IN-THK CLAMP-CABLE .312-DIA .375-WD NYL SCREW-MACH 6-32 .5-IN-LG PAN-HD-POZI	27014 00000 28480 28480 28480 28480 28480 00000	LM323K ORDER BY DESCRIPTION 2190-0008 3050-0066 2190-0006 2420-0002 1400-0017 ORDER BY DESCRIPTION
A1U2	1826-0559 2360-0117 8150-0035 2420-0001 8150-0141	7 6 8 5 7	1 6 4 6 4	IC 340 V RGLTR T0-3 SCREW-MACH 6-32 .375-IN-LG PAN-HD-POZI WIRE 22AWG W/G 300V PVC 7X30 105C NUT-HEX-W/LKWR 6-32-THD .109-IN-THK WIRE 22AWG W/Y 300V PVC 7X30 105C	27014 00000 28480 00000 28480	LM340K-24 ORDER BY DESCRIPTION 8150-0035 ORDER BY DESCRIPTION 8150-0141
A1VR1	1902-3326	4	1	DIODE-ZNR 43.2V 5% D0-35 PD=.4W TC=+.08%	28480	1902-3326
A1XA1				NOT ASSIGNED		
A1XA2	1251-1365	6	4	CONNECTOR-PC EDGE 22-CONT/ROW 2-ROWS	28480	1251-1365
A1XA3	1251-1365	6	6	CONNECTOR-PC EDGE 22-CONT/ROW 2-ROWS	28480	1251-1365
A1XA4	1251-1365	6	6	CONNECTOR-PC EDGE 22-CONT/ROW 2-ROWS	28480	1251-1365
A1XA5	1251-1365	6	6	CONNECTOR-PC EDGE 22-CONT/ROW 2-ROWS	28480	1251-1365
A2	11713-60002	9	1	DRIVER ASSEMBLY	28480	11713-60002
A2C1	0160-4084	8	16	CAPACITOR-FXD .1UF +-20% 50VDC CER	28480	0160-4084
A2C2	0180-0374	3	4	CAPACITOR-FXD 10UF+-10% 20VDC TA	56289	150D106X9020B2
A2C3	0160-4084	8	8	CAPACITOR-FXD .1UF +-20% 50VDC CER	28480	0160-4084

See introduction to this section for ordering information
 †Indicates factory selected value
 †Backdating information in Section VII

Table 6-2. Replaceable Parts

Reference Designation	HP Part Number	C D	Qty	Description	Mfr Code	Mfr Part Number
A2CR1	1901-0050	3	42	DIODE-SWITCHING 80V 200MA 2NS DO-35	28480	1901-0050
A2CR2	1901-0050	3		DIODE-SWITCHING 80V 200MA 2NS DO-35	28480	1901-0050
A2CR3	1901-0050	3		DIODE-SWITCHING 80V 200MA 2NS DO-35	28480	1901-0050
A2CR4	1901-0050	3		DIODE-SWITCHING 80V 200MA 2NS DO-35	28480	1901-0050
A2CR5	1901-0050	3		DIODE-SWITCHING 80V 200MA 2NS DO-35	28480	1901-0050
A2CR6	1901-0050	3		DIODE-SWITCHING 80V 200MA 2NS DO-35	28480	1901-0050
A2CR7	1901-0050	3		DIODE-SWITCHING 80V 200MA 2NS DO-35	28480	1901-0050
A2CR8	1901-0050	3		DIODE-SWITCHING 80V 200MA 2NS DO-35	28480	1901-0050
A2CR9	1901-0050	3		DIODE-SWITCHING 80V 200MA 2NS DO-35	28480	1901-0050
A2CR10	1901-0050	3		DIODE-SWITCHING 80V 200MA 2NS DO-35	28480	1901-0050
A2CR11	1901-0050	3		DIODE-SWITCHING 80V 200MA 2NS DO-35	28480	1901-0050
A2CR12	1901-0050	3		DIODE-SWITCHING 80V 200MA 2NS DO-35	28480	1901-0050
A2CR13	1901-0050	3		DIODE-SWITCHING 80V 200MA 2NS DO-35	28480	1901-0050
A2CR14	1901-0050	3		DIODE-SWITCHING 80V 200MA 2NS DO-35	28480	1901-0050
A2CR15	1901-0050	3		DIODE-SWITCHING 80V 200MA 2NS DO-35	28480	1901-0050
A2CR16	1901-0050	3		DIODE-SWITCHING 80V 200MA 2NS DO-35	28480	1901-0050
A2CR17	1901-0050	3		DIODE-SWITCHING 80V 200MA 2NS DO-35	28480	1901-0050
A2CR18	1901-0050	3		DIODE-SWITCHING 80V 200MA 2NS DO-35	28480	1901-0050
A2CR19	1901-0050	3		DIODE-SWITCHING 80V 200MA 2NS DO-35	28480	1901-0050
A2CR20	1901-0050	3		DIODE-SWITCHING 80V 200MA 2NS DO-35	28480	1901-0050
A2CR21	1901-0050	3		DIODE-SWITCHING 80V 200MA 2NS DO-35	28480	1901-0050
A2CR22	1901-0050	3		DIODE-SWITCHING 80V 200MA 2NS DO-35	28480	1901-0050
A2CR23	1901-0050	3		DIODE-SWITCHING 80V 200MA 2NS DO-35	28480	1901-0050
A2CR24	1901-0050	3		DIODE-SWITCHING 80V 200MA 2NS DO-35	28480	1901-0050
A2CR25	1901-0050	3		DIODE-SWITCHING 80V 200MA 2NS DO-35	28480	1901-0050
A2CR26	1901-0050	3	DIODE-SWITCHING 80V 200MA 2NS DO-35	28480	1901-0050	
A2CR27	1901-0050	3	DIODE-SWITCHING 80V 200MA 2NS DO-35	28480	1901-0050	
A2CR28	1901-0050	3	DIODE-SWITCHING 80V 200MA 2NS DO-35	28480	1901-0050	
A2CR29	1901-0050	3	DIODE-SWITCHING 80V 200MA 2NS DO-35	28480	1901-0050	
A2CR30	1901-0050	3	DIODE-SWITCHING 80V 200MA 2NS DO-35	28480	1901-0050	
A2CR31	1901-0050	3	DIODE-SWITCHING 80V 200MA 2NS DO-35	28480	1901-0050	
A2CR32	1901-0050	3	DIODE-SWITCHING 80V 200MA 2NS DO-35	28480	1901-0050	
A2CR33	1901-0050	3	DIODE-SWITCHING 80V 200MA 2NS DO-35	28480	1901-0050	
A2CR34	1901-0050	3	DIODE-SWITCHING 80V 200MA 2NS DO-35	28480	1901-0050	
A2CR35	1901-0050	3	DIODE-SWITCHING 80V 200MA 2NS DO-35	28480	1901-0050	
A2CR36	1901-0050	3	DIODE-SWITCHING 80V 200MA 2NS DO-35	28480	1901-0050	
A2CR37	1901-0050	3	DIODE-SWITCHING 80V 200MA 2NS DO-35	28480	1901-0050	
A2CR38	1901-0050	3	DIODE-SWITCHING 80V 200MA 2NS DO-35	28480	1901-0050	
A2CR39	1901-0050	3	DIODE-SWITCHING 80V 200MA 2NS DO-35	28480	1901-0050	
A2CR40	1901-0050	3	DIODE-SWITCHING 80V 200MA 2NS DO-35	28480	1901-0050	
A2CR41	1901-0050	3	DIODE-SWITCHING 80V 200MA 2NS DO-35	28480	1901-0050	
A2CR42	1901-0050	3	DIODE-SWITCHING 80V 200MA 2NS DO-35	28480	1901-0050	
A2K1	0490-1190	0	2	RELAY 2C 5VDC-COIL .5A 125VAC	28480	0490-1190
A2K2	0490-1190	0		RELAY 2C 5VDC-COIL .5A 125VAC	28480	0490-1190
A2MP1	5040-6847	6	1	BOARD EXTRACTOR, RED	28480	5040-6847
	5000-9043	6		PIN:P.C. BOARD EXTRACTOR	28480	5000-9043
A2MP2	11713-20009	2		DRIVER-TRANSISTOR SUPPORT	28480	11713-20009
	2200-0107	6		SCREW-MACH 4-40 .375-IN-LG PAN-HD-POZI	00000	ORDER BY DESCRIPTION
	3050-0105	6		WASHER-FL MTL C NO. 4 .125-IN-ID	28480	3050-0105
A2Q1	1854-0810	2	16	TRANSISTOR NPN SI PD=625MW FT=200MHZ	28480	1854-0810
A2Q2	1854-0810	2		TRANSISTOR NPN SI PD=625MW FT=200MHZ	28480	1854-0810
A2Q3	1854-0633	7		TRANSISTOR NPN SI DARL PD=40W	04713	MJE800
A2Q4	1854-0633	7		TRANSISTOR NPN SI DARL PD=40W	04713	MJE800
A2Q5	1854-0633	7		TRANSISTOR NPN SI DARL PD=40W	04713	MJE800
A2Q6	1854-0633	7		TRANSISTOR NPN SI DARL PD=40W	04713	MJE800
A2Q7	1854-0633	7		TRANSISTOR NPN SI DARL PD=40W	04713	MJE800
A2Q8	1854-0633	7		TRANSISTOR NPN SI DARL PD=40W	04713	MJE800
A2Q9	1854-0633	7		TRANSISTOR NPN SI DARL PD=40W	04713	MJE800
A2Q10	1854-0633	7		TRANSISTOR NPN SI DARL PD=40W	04713	MJE800
A2Q11	1854-0633	7		TRANSISTOR NPN SI DARL PD=40W	04713	MJE800
A2Q12	1854-0633	7		TRANSISTOR NPN SI DARL PD=40W	04713	MJE800
A2Q13	1854-0633	7		TRANSISTOR NPN SI DARL PD=40W	04713	MJE800
A2Q14	1854-0633	7		TRANSISTOR NPN SI DARL PD=40W	04713	MJE800
A2Q15	1854-0633	7		TRANSISTOR NPN SI DARL PD=40W	04713	MJE800

See introduction to this section for ordering information
 *Indicates factory selected value
 †Backdating information in Section VII

Table 6-2. Replaceable Parts

Reference Designation	HP Part Number	C D	Qty	Description	Mfr Code	Mfr Part Number
A2Q16	1854-0633	7		TRANSISTOR NPN SI DARL PD=40W	04713	MJE800
A2Q17	1854-0633	7		TRANSISTOR NPN SI DARL PD=40W	04713	MJE800
A2Q18	1854-0633	7		TRANSISTOR NPN SI DARL PD=40W	04713	MJE800
A2Q19	1854-0810	2		TRANSISTOR NPN SI PD=625MW FT=200MHZ	28480	1854-0810
A2Q20	1854-0810	2		TRANSISTOR NPN SI PD=625MW FT=200MHZ	28480	1854-0810
A2R1	0757-0289	2	2	RESISTOR 13.3K 1% .125W F TC=0+-100	19701	MF4C1/8-T0-1332-F
A2R2	0698-0084	9	16	RESISTOR 2.15K 1% .125W F TC=0+-100	24546	C4-1/8-T0-2151-F
A2R3	0698-0084	9		RESISTOR 2.15K 1% .125W F TC=0+-100	24546	C4-1/8-T0-2151-F
A2R4	0698-0084	9		RESISTOR 2.15K 1% .125W F TC=0+-100	24546	C4-1/8-T0-2151-F
A2R5	0698-0084	9		RESISTOR 2.15K 1% .125W F TC=0+-100	24546	C4-1/8-T0-2151-F
A2R6	0757-0289	2		RESISTOR 13.3K 1% .125W F TC=0+-100	19701	MF4C1/8-T0-1332-F
A2R7	0698-0084	9		RESISTOR 2.15K 1% .125W F TC=0+-100	24546	C4-1/8-T0-2151-F
A2R8	0698-0084	9		RESISTOR 2.15K 1% .125W F TC=0+-100	24546	C4-1/8-T0-2151-F
A2R9	0698-0084	9		RESISTOR 2.15K 1% .125W F TC=0+-100	24546	C4-1/8-T0-2151-F
A2R10	0698-0084	9		RESISTOR 2.15K 1% .125W F TC=0+-100	24546	C4-1/8-T0-2151-F
A2R11	0698-0084	9		RESISTOR 2.15K 1% .125W F TC=0+-100	24546	C4-1/8-T0-2151-F
A2R12	0698-0084	9		RESISTOR 2.15K 1% .125W F TC=0+-100	24546	C4-1/8-T0-2151-F
A2R13	0698-0084	9		RESISTOR 2.15K 1% .125W F TC=0+-100	24546	C4-1/8-T0-2151-F
A2R14	0698-0084	9		RESISTOR 2.15K 1% .125W F TC=0+-100	24546	C4-1/8-T0-2151-F
A2R15	0698-0084	9		RESISTOR 2.15K 1% .125W F TC=0+-100	24546	C4-1/8-T0-2151-F
A2R16	0698-0084	9		RESISTOR 2.15K 1% .125W F TC=0+-100	24546	C4-1/8-T0-2151-F
A2R17	0698-0084	9		RESISTOR 2.15K 1% .125W F TC=0+-100	24546	C4-1/8-T0-2151-F
A2R18	0698-0084	9		RESISTOR 2.15K 1% .125W F TC=0+-100	24546	C4-1/8-T0-2151-F
A2U1	1820-1873	8	2	IC BFR TTL LS INV OCTL 2-INP	27014	DM81LS98N
A2U2	1820-1873	8		IC BFR TTL LS INV OCTL 2-INP	27014	DM81LS98N
				A2 MISCELLANEOUS PARTS		
	6040-0239	9	1	THERMAL COMPOUND(FOR TRANSISTOR MOUNTING	05820	120
	0590-0076	1	8	NUT-HEX-PLSTC LKG 4-40-THD .143-IN-THK	28480	0590-0076
A3	11713-60003	0	1	LATCH ASSEMBLY	28480	11713-60003
A3C1	0160-4084	8		CAPACITOR-FXD .1UF +-20% 50VDC CER	28480	0160-4084
A3C2	0160-4084	8		CAPACITOR-FXD .1UF +-20% 50VDC CER	28480	0160-4084
A3C3	0160-4084	8		CAPACITOR-FXD .1UF +-20% 50VDC CER	28480	0160-4084
A3C4	0180-0229	7	2	CAPACITOR-FXD 33UF+-10% 10VDC TA	56289	150D336X9010B2
A3C5	0160-4084	8		CAPACITOR-FXD .1UF +-20% 50VDC CER	28480	0160-4084
A3C6	0180-0229	7		CAPACITOR-FXD 33UF+-10% 10VDC TA	56289	150D336X9010B2
A3C7	0180-0374	3		CAPACITOR-FXD 10UF+-10% 20VDC TA	56289	150D106X9020B2
A3CR1	1901-0040	1	1	DIODE-SWITCHING 30V 50MA 2NS DO-35	28480	1901-0040
A3MP1	5040-6852	3	1	BOARD EXTRACTOR, ORANGE	28480	5040-6852
	5000-9043	6		PIN:P.C. BOARD EXTRACTOR	28480	5000-9043
A3Q1	1854-0810	2		TRANSISTOR NPN SI PD=625MW FT=200MHZ	28480	1854-0810
A3R1	0757-0444	1	2	RESISTOR 12.1K 1% .125W F TC=0+-100	24546	C4-1/8-T0-1212-F
A3R2	0757-0444	1		RESISTOR 12.1K 1% .125W F TC=0+-100	24546	C4-1/8-T0-1212-F
A3R3	0757-0280	3	2	RESISTOR 1K 1% .125W F TC=0+-100	24546	C4-1/8-T0-1001-F
A3U1	1820-1212	9	5	IC FF TTL LS J-K NEG-EDGE-TRIG	01295	SN74LS112AN
A3U2	1820-1212	9		IC FF TTL LS J-K NEG-EDGE-TRIG	01295	SN74LS112AN
A3U3	1820-1212	9		IC FF TTL LS J-K NEG-EDGE-TRIG	01295	SN74LS112AN
A3U4	1820-1212	9		IC FF TTL LS J-K NEG-EDGE-TRIG	01295	SN74LS112AN
A3U5	1820-1212	9		IC FF TTL LS J-K NEG-EDGE-TRIG	01295	SN74LS112AN
A3U6	1820-0683	6	1	IC INV TTL S HEX 1-INP	01295	SN74504N
A3U7	1820-0681	4	1	IC GATE TTL S NAND QUAD 2-INP	01295	SN74500N
A3VR1	1902-3070	5	1	DIODE-ZNR 4.22V 5% DO-35 PD=.4W	28480	1902-3070
A4	11713-60004	1	1	REMOTE LOCAL LOGIC ASSEMBLY	28480	11713-60004
A4C1	0160-2055	9	17	CAPACITOR-FXD .01UF +80-20% 100VDC CER	28480	0160-2055
A4C2	0160-2055	9		CAPACITOR-FXD .01UF +80-20% 100VDC CER	28480	0160-2055
A4C3	0160-2055	9		CAPACITOR-FXD .01UF +80-20% 100VDC CER	28480	0160-2055
A4C4	0160-2055	9		CAPACITOR-FXD .01UF +80-20% 100VDC CER	28480	0160-2055
A4C5	0160-2055	9		CAPACITOR-FXD .01UF +80-20% 100VDC CER	28480	0160-2055

See introduction to this section for ordering information
 *Indicates factory selected value
 †Backdating information in Section VII

Table 6-2. Replaceable Parts

Reference Designation	HP Part Number	C D	Qty	Description	Mfr Code	Mfr Part Number
A4C6	0160-2055	9		CAPACITOR-FXD .01UF +80-20% 100VDC CER	28480	0160-2055
A4C7	0160-2055	9		CAPACITOR-FXD .01UF +80-20% 100VDC CER	28480	0160-2055
A4C8	0180-0374	3		CAPACITOR-FXD 10UF+-10% 20VDC TA	56289	150D106X9020B2
A4MP1	5040-6848	7	1	BOARD EXTRACTOR, YELLOW	28480	5040-6848
	5000-9043	6		PIN:P.C. BOARD EXTRACTOR	28480	5000-9043
A4R1	0757-0280	3		RESISTOR 1K 1% .125W F TC=0+-100	24546	C4-1/8-T0-1001-F
A4U1	1820-1428	9	3	IC MUXR/DATA-SEL TTL LS 2-TO-1-LINE QUAD	01295	SN74LS158N
A4U2	1820-1216	3	2	IC DCDR TTL LS 3-TO-8-LINE 3-INP	01295	SN74LS138N
A4U3	1820-1428	9		IC MUXR/DATA-SEL TTL LS 2-TO-1-LINE QUAD	01295	SN74LS158N
A4U4	1820-1202	7	1	IC GATE TTL LS NAND TPL 3-INP	01295	SN74LS10N
A4U5	1820-1204	9	1	IC GATE TTL LS NAND DUAL 4-INP	01295	SN74LS20N
A4U6	1820-1112	8	3	IC FF TTL LS D-TYPE POS-EDGE-TRIG	01295	SN74LS74AN
A4U7	1820-1428	9		IC MUXR/DATA-SEL TTL LS 2-TO-1-LINE QUAD	01295	SN74LS158N
A4U8	1820-1216	3		IC DCDR TTL LS 3-TO-8-LINE 3-INP	01295	SN74LS138N
A4U9	1820-1112	8		IC FF TTL LS D-TYPE POS-EDGE-TRIG	01295	SN74LS74AN
A4U10	1820-1199	1	2	IC INV TTL LS HEX 1-INP	01295	SN74LS04N
A4U11	1820-1197	9	1	IC GATE TTL LS NAND QUAD 2-INP	01295	SN74LS00N
A5	11713-60005	2	1	HP-IB HANDSHAKE & DATA INPUT ASSEMBLY	28480	11713-60005
A5C1	0160-2055	9		CAPACITOR-FXD .01UF +80-20% 100VDC CER	28480	0160-2055
A5C2	0160-2055	9		CAPACITOR-FXD .01UF +80-20% 100VDC CER	28480	0160-2055
A5C3	0160-2055	9		CAPACITOR-FXD .01UF +80-20% 100VDC CER	28480	0160-2055
A5C4	0160-2055	9		CAPACITOR-FXD .01UF +80-20% 100VDC CER	28480	0160-2055
A5C5	0160-2226	6	2	CAPACITOR-FXD 2200PF +-5% 300VDC MICA	28480	0160-2226
A5C6	0160-2055	9		CAPACITOR-FXD .01UF +80-20% 100VDC CER	28480	0160-2055
A5C7	0160-3533	0	1	CAPACITOR-FXD 470PF +-5% 300VDC MICA	28480	0160-3533
A5C8	0160-2226	6		CAPACITOR-FXD 2200PF +-5% 300VDC MICA	28480	0160-2226
A5C9	0180-0374	3		CAPACITOR-FXD 10UF+-10% 20VDC TA	56289	150D106X9020B2
A5C10	0140-0192	9	2	CAPACITOR-FXD 68PF +-5% 300VDC MICA	72136	DM15E680J0300UV1CR
A5C11	0140-0192	9		CAPACITOR-FXD 68PF +-5% 300VDC MICA	72136	DM15E680J0300UV1CR
A5MP1	5040-6851	2	1	BOARD EXTRACTOR, GREEN	28480	5040-6851
	5000-9043	6		PIN:P.C. BOARD EXTRACTOR	28480	5000-9043
A5R1	0698-3444	1	5	RESISTOR 316 1% .125W F TC=0+-100	24546	C4-1/8-T0-316R-F
A5R2	0698-3444	1		RESISTOR 316 1% .125W F TC=0+-100	24546	C4-1/8-T0-316R-F
A5R3	0698-3444	1		RESISTOR 316 1% .125W F TC=0+-100	24546	C4-1/8-T0-316R-F
A5R4	0757-0199	3	3	RESISTOR 21.5K 1% .125W F TC=0+-100	24546	C4-1/8-T0-2152-F
A5R5	0757-0199	3		RESISTOR 21.5K 1% .125W F TC=0+-100	24546	C4-1/8-T0-2152-F
A5R6	0757-0199	3		RESISTOR 21.5K 1% .125W F TC=0+-100	24546	C4-1/8-T0-2152-F
A5R7†	0757-0438	3	3	RESISTOR 5.11K 1% .125W F TC=0+-100	24546	C4-1/8-T0-5111-F
A5R8†	0757-0438	3		RESISTOR 5.11K 1% .125W F TC=0+-100	24546	C4-1/8-T0-5111-F
A5U1†	1820-0621	2	1	IC BFR TTL NAND QUAD 2-INP	01295	SN7438N
A5U2	1820-1112	8		IC FF TTL LS D-TYPE POS-EDGE-TRIG	01295	SN74LS74AN
A5U3	1820-1207	2	1	IC GATE TTL LS NAND 8-INP	01295	SN74LS30N
A5U4	1820-0515	3	1	IC HV TTL MONOSTBL RETRIG/RESET DUAL	04713	MC8602P
A5U5	1820-0904	4	1	IC COMPTN TTL L MAGTD 5-BIT	07263	93L24PC
A5U6	1820-1416	5	2	IC SCHMITT-TRIG TTL LS INV HEX 1-INP	01295	SN74LS14N
A5U7	1820-1416	5		IC SCHMITT-TRIG TTL LS INV HEX 1-INP	01295	SN74LS14N
A5U8	11713-80002	1	1	IC, PROM	28480	11713-80002
A5U9	1820-1199	1		IC INV TTL LS HEX 1-INP	01295	SN74LS04N
A6†	11713-60010	9	1	INTERFACE ASSEMBLY	28480	11713-60010
A6J1	1251-5399	4	2	CONNECTOR 12-PIN M CIRCULAR THORKOM	28480	1251-5399
A6J2	1251-5399	4		CONNECTOR 12-PIN M CIRCULAR THORKOM	28480	1251-5399
A6J3	1251-5316	5		CONNECTOR, 34-PIN	28480	1251-5316
A6MP1	0380-0111	0	3	STANDOFF-RVT-ON .25-IN-LG 6-32THD	00000	ORDER BY DESCRIPTION
A6MP2	0380-0111	0		STANDOFF-RVT-ON .25-IN-LG 6-32THD	00000	ORDER BY DESCRIPTION
A6MP3	0380-0111	0		STANDOFF-RVT-ON .25-IN-LG 6-32THD	00000	ORDER BY DESCRIPTION
A6S1	3101-1973	7	1	SWITCH-SL 7-1A DIP-SLIDE-ASSY .1A 50VDC (HP-IB ADDRESS)	28480	3101-1973

See introduction to this section for ordering information
 *Indicates factory selected value
 †Backdating information in Section VII

Table 6-2. Replaceable Parts

Reference Designation	HP Part Number	C D	Qty	Description	Mfr Code	Mfr Part Number
A6 MISCELLANEOUS PARTS						
	8150-0448	7	3	WIRE 24AWG BR 300V PVC 7X32 80C	28480	8150-0448
	8150-0449	8	2	WIRE 24AWG R 300V PVC 7X32 80C	28480	8150-0449
	8150-0450	1	4	WIRE 24AWG O 300V PVC 7X32 80C	28480	8150-0450
	8150-0451	2	1	WIRE 24AWG Y 300V PVC 7X32 80C	28480	8150-0451
	8150-0452	3	2	WIRE 24AWG G 300V PVC 7X32 80C	28480	8150-0452
A7	11713-60007	4	1	SWITCH BOARD ASSEMBLY	28480	11713-60007
A7C1	0160-4084	8		CAPACITOR-FXD .1UF +-20% 50VDC CER	28480	0160-4084
A7C2	0160-4084	8		CAPACITOR-FXD .1UF +-20% 50VDC CER	28480	0160-4084
A7C3	0160-2055	9		CAPACITOR-FXD .01UF +80-20% 100VDC CER	28480	0160-2055
A7C4	0160-2055	9		CAPACITOR-FXD .01UF +80-20% 100VDC CER	28480	0160-2055
A7C5	0160-0127	2	10	CAPACITOR-FXD 1UF +-20% 25VDC CER	28480	0160-0127
A7C6	0160-0127	2		CAPACITOR-FXD 1UF +-20% 25VDC CER	28480	0160-0127
A7C7	0160-2055	9		CAPACITOR-FXD .01UF +80-20% 100VDC CER	28480	0160-2055
A7C8	0160-2055	9		CAPACITOR-FXD .01UF +80-20% 100VDC CER	28480	0160-2055
A7C9	0160-2055	9		CAPACITOR-FXD .01UF +80-20% 100VDC CER	28480	0160-2055
A7C10	0160-4084	8		CAPACITOR-FXD .1UF +-20% 50VDC CER	28480	0160-4084
A7C11	0160-4084	8		CAPACITOR-FXD .1UF +-20% 50VDC CER	28480	0160-4084
A7C12	0160-0127	2		CAPACITOR-FXD 1UF +-20% 25VDC CER	28480	0160-0127
A7C13	0160-0127	2		CAPACITOR-FXD 1UF +-20% 25VDC CER	28480	0160-0127
A7C14	0160-4084	8		CAPACITOR-FXD .1UF +-20% 50VDC CER	28480	0160-4084
A7C15	0160-4084	8		CAPACITOR-FXD .1UF +-20% 50VDC CER	28480	0160-4084
A7C16	0160-4084	8		CAPACITOR-FXD .1UF +-20% 50VDC CER	28480	0160-4084
A7C17	0160-0127	2		CAPACITOR-FXD 1UF +-20% 25VDC CER	28480	0160-0127
A7C18	0160-0127	2		CAPACITOR-FXD 1UF +-20% 25VDC CER	28480	0160-0127
A7C19	0160-0127	2		CAPACITOR-FXD 1UF +-20% 25VDC CER	28480	0160-0127
A7C20	0160-4084	8		CAPACITOR-FXD .1UF +-20% 50VDC CER	28480	0160-4084
A7C21	0160-4084	8		CAPACITOR-FXD .1UF +-20% 50VDC CER	28480	0160-4084
A7C22	0160-4084	8		CAPACITOR-FXD .1UF +-20% 50VDC CER	28480	0160-4084
A7C23	0160-0127	2		CAPACITOR-FXD 1UF +-20% 25VDC CER	28480	0160-0127
A7C24	0160-0127	2		CAPACITOR-FXD 1UF +-20% 25VDC CER	28480	0160-0127
A7C25	0160-0127	2		CAPACITOR-FXD 1UF +-20% 25VDC CER	28480	0160-0127
A7DS1	1990-0665	3	11	LED-LAMP LUM-INT=1MCD IF=20MA-MAX BVR=5V	28480	1990-0665
A7DS2	1990-0665	3		LED-LAMP LUM-INT=1MCD IF=20MA-MAX BVR=5V	28480	1990-0665
A7DS3	1990-0665	3		LED-LAMP LUM-INT=1MCD IF=20MA-MAX BVR=5V	28480	1990-0665
A7DS4	1990-0665	3		LED-LAMP LUM-INT=1MCD IF=20MA-MAX BVR=5V	28480	1990-0665
A7DS5	1990-0665	3		LED-LAMP LUM-INT=1MCD IF=20MA-MAX BVR=5V	28480	1990-0665
A7DS6	1990-0665	3		LED-LAMP LUM-INT=1MCD IF=20MA-MAX BVR=5V	28480	1990-0665
A7DS7	1990-0665	3		LED-LAMP LUM-INT=1MCD IF=20MA-MAX BVR=5V	28480	1990-0665
A7DS8	1990-0665	3		LED-LAMP LUM-INT=1MCD IF=20MA-MAX BVR=5V	28480	1990-0665
A7DS9	1990-0665	3		LED-LAMP LUM-INT=1MCD IF=20MA-MAX BVR=5V	28480	1990-0665
A7DS10	1990-0665	3		LED-LAMP LUM-INT=1MCD IF=20MA-MAX BVR=5V	28480	1990-0665
A7DS11	1990-0665	3		LED-LAMP LUM-INT=1MCD IF=20MA-MAX BVR=5V	28480	1990-0665
A7DS12	1990-0486	6	1	LED-LAMP LUM-INT=1MCD IF=20MA-MAX BVR=5V	28480	5082-4684
A7DS13	1990-0835	9	1	LED-LAMP LUM-INT=6MCD IF=30MA-MAX BVR=5V	28480	HLMP-1523
A7J1	1251-5316	5		CONNECTOR, 34-PIN	28480	1251-5316
A7Q1†	1854-0810	2	7	TRANSISTOR NPN SI PD=625MW FT=200MHZ	28480	1854-0810
A7Q2†	1854-0810	2		TRANSISTOR NPN SI PD=625MW FT=200MHZ	28480	1854-0810
A7R1	0698-3450	9	20	RESISTOR 42.2K 1% .125W F TC=0+-100	24546	C4-1/8-T0-4222-F
A7R2	0698-3450	9		RESISTOR 42.2K 1% .125W F TC=0+-100	24546	C4-1/8-T0-4222-F
A7R3	0757-0442	9	13	RESISTOR 10K 1% .125W F TC=0+-100	24546	C4-1/8-T0-1002-F
A7R4	0757-0442	9		RESISTOR 10K 1% .125W F TC=0+-100	24546	C4-1/8-T0-1002-F
A7R5	0757-0442	9		RESISTOR 10K 1% .125W F TC=0+-100	24546	C4-1/8-T0-1002-F
A7R6	0757-0442	9		RESISTOR 10K 1% .125W F TC=0+-100	24546	C4-1/8-T0-1002-F
A7R7	0698-3450	9		RESISTOR 42.2K 1% .125W F TC=0+-100	24546	C4-1/8-T0-4222-F
A7R8	0698-3450	9		RESISTOR 42.2K 1% .125W F TC=0+-100	24546	C4-1/8-T0-4222-F
A7R9	0698-3447	4	11	RESISTOR 422 1% .125W F TC=0+-100	24546	C4-1/8-T0-422R-F
A7R10	0757-0442	9		RESISTOR 10K 1% .125W F TC=0+-100	24546	C4-1/8-T0-1002-F
A7R11	0698-3444	1		RESISTOR 316 1% .125W F TC=0+-100	24546	C4-1/8-T0-316R-F
A7R12	0698-3450	9		RESISTOR 42.2K 1% .125W F TC=0+-100	24546	C4-1/8-T0-4222-F
A7R13	0698-3450	9		RESISTOR 42.2K 1% .125W F TC=0+-100	24546	C4-1/8-T0-4222-F
A7R14	0698-3444	1		RESISTOR 316 1% .125W F TC=0+-100	24546	C4-1/8-T0-316R-F
A7R15	0757-0442	9		RESISTOR 10K 1% .125W F TC=0+-100	24546	C4-1/8-T0-1002-F

See introduction to this section for ordering information

*Indicates factory selected value

†Backdating information in Section VII

Table 6-2. Replaceable Parts

Reference Designation	HP Part Number	C D	Qty	Description	Mfr Code	Mfr Part Number
A7R16	0757-0442	9		RESISTOR 10K 1% .125W F TC=0+-100	24546	C4-1/8-T0-1002-F
A7R17	0698-3450	9		RESISTOR 42.2K 1% .125W F TC=0+-100	24546	C4-1/8-T0-4222-F
A7R18	0698-3450	9		RESISTOR 42.2K 1% .125W F TC=0+-100	24546	C4-1/8-T0-4222-F
A7R19	0698-3450	9		RESISTOR 42.2K 1% .125W F TC=0+-100	24546	C4-1/8-T0-4222-F
A7R20	0698-3450	9		RESISTOR 42.2K 1% .125W F TC=0+-100	24546	C4-1/8-T0-4222-F
A7R21	0698-3450	9		RESISTOR 42.2K 1% .125W F TC=0+-100	24546	C4-1/8-T0-4222-F
A7R22	0757-0442	9		RESISTOR 10K 1% .125W F TC=0+-100	24546	C4-1/8-T0-1002-F
A7R23	0757-0442	9		RESISTOR 10K 1% .125W F TC=0+-100	24546	C4-1/8-T0-1002-F
A7R24	0757-0442	9		RESISTOR 10K 1% .125W F TC=0+-100	24546	C4-1/8-T0-1002-F
A7R25	0698-3450	9		RESISTOR 42.2K 1% .125W F TC=0+-100	24546	C4-1/8-T0-4222-F
A7R26	0698-3450	9		RESISTOR 42.2K 1% .125W F TC=0+-100	24546	C4-1/8-T0-4222-F
A7R27	0698-3450	9		RESISTOR 42.2K 1% .125W F TC=0+-100	24546	C4-1/8-T0-4222-F
A7R28	0698-3450	9		RESISTOR 42.2K 1% .125W F TC=0+-100	24546	C4-1/8-T0-4222-F
A7R29	0698-3450	9		RESISTOR 42.2K 1% .125W F TC=0+-100	24546	C4-1/8-T0-4222-F
A7R30	0698-3450	9		RESISTOR 42.2K 1% .125W F TC=0+-100	24546	C4-1/8-T0-4222-F
A7R31	0757-0442	9		RESISTOR 10K 1% .125W F TC=0+-100	24546	C4-1/8-T0-1002-F
A7R32	0757-0442	9		RESISTOR 10K 1% .125W F TC=0+-100	24546	C4-1/8-T0-1002-F
A7R33	0757-0442	9		RESISTOR 10K 1% .125W F TC=0+-100	24546	C4-1/8-T0-1002-F
A7R34	0698-3450	9		RESISTOR 42.2K 1% .125W F TC=0+-100	24546	C4-1/8-T0-4222-F
A7R35	0698-3450	9		RESISTOR 42.2K 1% .125W F TC=0+-100	24546	C4-1/8-T0-4222-F
A7R36	0698-3450	9		RESISTOR 42.2K 1% .125W F TC=0+-100	24546	C4-1/8-T0-4222-F
A7R37	0698-3447	4		RESISTOR 422 1% .125W F TC=0+-100	24546	C4-1/8-T0-422R-F
A7R38	0698-3447	4		RESISTOR 422 1% .125W F TC=0+-100	24546	C4-1/8-T0-422R-F
A7R39	0698-3447	4		RESISTOR 422 1% .125W F TC=0+-100	24546	C4-1/8-T0-422R-F
A7R40	0698-3447	4		RESISTOR 422 1% .125W F TC=0+-100	24546	C4-1/8-T0-422R-F
A7R41	0698-3447	4		RESISTOR 422 1% .125W F TC=0+-100	24546	C4-1/8-T0-422R-F
A7R42	0698-3447	4		RESISTOR 422 1% .125W F TC=0+-100	24546	C4-1/8-T0-422R-F
A7R43	0698-3447	4		RESISTOR 422 1% .125W F TC=0+-100	24546	C4-1/8-T0-422R-F
A7R44	0698-3447	4		RESISTOR 422 1% .125W F TC=0+-100	24546	C4-1/8-T0-422R-F
A7R45	0698-3447	4		RESISTOR 422 1% .125W F TC=0+-100	24546	C4-1/8-T0-422R-F
A7R46	0698-3447	4		RESISTOR 422 1% .125W F TC=0+-100	24546	C4-1/8-T0-422R-F
A7S1	5060-9436	7	11	PUSHBUTTON SWITCH P.C. MOUNT	28480	5060-9436
A7S2	5060-9436	7		PUSHBUTTON SWITCH P.C. MOUNT	28480	5060-9436
A7S3	5060-9436	7		PUSHBUTTON SWITCH P.C. MOUNT	28480	5060-9436
A7S4	5060-9436	7		PUSHBUTTON SWITCH P.C. MOUNT	28480	5060-9436
A7S5	5060-9436	7		PUSHBUTTON SWITCH P.C. MOUNT	28480	5060-9436
A7S6	5060-9436	7		PUSHBUTTON SWITCH P.C. MOUNT	28480	5060-9436
A7S7	5060-9436	7		PUSHBUTTON SWITCH P.C. MOUNT	28480	5060-9436
A7S8	5060-9436	7		PUSHBUTTON SWITCH P.C. MOUNT	28480	5060-9436
A7S9	5060-9436	7		PUSHBUTTON SWITCH P.C. MOUNT	28480	5060-9436
A7S10	5060-9436	7		PUSHBUTTON SWITCH P.C. MOUNT	28480	5060-9436
A7S11	5060-9436	7		PUSHBUTTON SWITCH P.C. MOUNT	28480	5060-9436
A7U1	1820-1423	4	5	IC MV TTL LS MONOSTBL RETRIG DUAL	01295	SN74LS123N
A7U2	1820-1423	4		IC MV TTL LS MONOSTBL RETRIG DUAL	01295	SN74LS123N
A7U3	1820-1423	4		IC MV TTL LS MONOSTBL RETRIG DUAL	01295	SN74LS123N
A7U4	1820-1423	4		IC MV TTL LS MONOSTBL RETRIG DUAL	01295	SN74LS123N
A7U5	1820-1423	4		IC MV TTL LS MONOSTBL RETRIG DUAL	01295	SN74LS123N
A8	0960-0443	1	1	POWER MODULE/LINE FILTER	28480	0960-0443
ABC1	0160-4065	5	1	CAPACITOR-FXD .1UF +-20% 250VAC(RMS)	28480	0160-4065

See introduction to this section for ordering information

*Indicates factory selected value

†Backdating information in Section VII

Table 6-2. Replaceable Parts

Reference Designation	HP Part Number	C D	Qty	Description	Mfr Code	Mfr Part Number
CHASSIS PARTS						
F1	2110-0094	9	1	FUSE 1.25A 250V NTD 1.25X.25 UL IEC (FOR 100/120V OPERATION)	28480	2110-0094
	2110-0063	2	1	FUSE .75A 250V NTD 1.25X.25 UL (FOR 220/240V OPERATION)	28480	2110-0063
MP1- MP15				MP PARTS 1 THRU 15 SEE CABINET PARTS	28480	5041-1418
MP16	5041-1418	9	1	ROCKER	28480	5041-0285
MP17	5041-0285	6	11	KEY CAP, LIGHT GREY	28480	5041-0285
MP18	5041-0285	6		KEY CAP, LIGHT GREY	28480	5041-0285
MP19	5041-0285	6		KEY CAP, LIGHT GREY	28480	5041-0285
MP20	5041-0285	6		KEY CAP, LIGHT GREY	28480	5041-0285
MP21	5041-0285	6		KEY CAP, LIGHT GREY	28480	5041-0285
MP22	5041-0285	6		KEY CAP, LIGHT GREY	28480	5041-0285
MP23	5041-0285	6		KEY CAP, LIGHT GREY	28480	5041-0285
MP24	5041-0285	6		KEY CAP, LIGHT GREY	28480	5041-0285
MP25	5041-0285	6		KEY CAP, LIGHT GREY	28480	5041-0285
MP26	5041-0285	6		KEY CAP, LIGHT GREY	28480	5041-0285
MP27	5041-0285	6		KEY CAP, LIGHT GREY	28480	5041-0285
MP28	7120-4835	0	2	LABEL, INFO	28480	7120-4835
MP29				NOT ASSIGNED		
MP30†	0380-1627	5	2	STANDOFF-HEX .335-IN-LG 6-32-THD	28480	0380-1627
MP31	0510-0079	6		RETAINER-RING BSC EXT .5-IN-DIA STL	28480	0510-0079
MP32	1510-0091	3	1	BINDING POST SGL SGL-TUR JGK RED	28480	1510-0091
MP33	1510-0090	2	4	BINDING POST SGL SGL-TUR JGK	28480	1510-0090
MP34	1510-0090	2		BINDING POST SGL SGL-TUR JGK	28480	1510-0090
MP35	1510-0090	2		BINDING POST SGL SGL-TUR JGK	28480	1510-0090
MP36	1510-0090	2		BINDING POST SGL SGL-TUR JGK	28480	1510-0090
MP38	7120-1160	8	1	LABEL, INFO	28480	7120-1160
MP39	11713-00003	4	1	HEATSINK	28480	11713-00003
	2360-0117	6		SCREW-MACH 6-32 .375-IN-LG PAN-HD-POZI	00000	ORDER BY DESCRIPTION
	2420-0001	5		NUT-HEX-W/LKUR 6-32-THD .109-IN-THK	00000	ORDER BY DESCRIPTION
MP40	5040-0170	6	8	GUIDE:PLUG-IN PC BOARD	28480	5040-0170
MP41	5040-0170	6		GUIDE:PLUG-IN PC BOARD	28480	5040-0170
MP42	5040-0170	6		GUIDE:PLUG-IN PC BOARD	28480	5040-0170
MP43	5040-0170	6		GUIDE:PLUG-IN PC BOARD	28480	5040-0170
MP44	5040-0170	6		GUIDE:PLUG-IN PC BOARD	28480	5040-0170
MP45	5040-0170	6		GUIDE:PLUG-IN PC BOARD	28480	5040-0170
MP46	5040-0170	6		GUIDE:PLUG-IN PC BOARD	28480	5040-0170
MP47	5040-0170	6		GUIDE:PLUG-IN PC BOARD	28480	5040-0170
MP48	1251-3537	8	1	CONNECTOR 10-PIN F POST TYPE	28480	1251-3537
MP49	1400-0017	0		CLAMP-CABLE .312-DIA .375-WD NYL	28480	1400-0017
MP50†				NOT ASSIGNED		
MP51†	11713-00013	6	1	SUPPORT, TRANSFORMER	28480	11713-00013
MP52	7120-4163	7	1	LABEL, ID	28480	7120-4163
MP53	7120-4835	0		LABEL, INFO	28480	7120-4835
MP54†	11713-00009	0	1	LOCKING SIDE PLATE	28480	11713-00009
S1	3101-2080	9	1	SWITCH-RKR BASIC DPDT 3A 250VAC SLDR-LUG	28480	3101-2080
T1	9100-4080	7	1	TRANSFORMER-POWER 100/120/220/240V	28480	9100-4080
	2580-0004	6	7	NUT-HEX-DBL-CHAM 8-32-THD .125-IN-THK	00000	ORDER BY DESCRIPTION
	2190-0017	4	7	WASHER-LK HLCL NO. 8 .168-IN-ID	28480	2190-0017
	3050-0011	3	11	WASHER-FL NM NO. 5 .13-IN-ID .25-IN-OD	28480	3050-0011
	2810-0135	7	4	SCREW-MACH 8-32 2.25-IN-LG PAN-HD-POZI	00000	ORDER BY DESCRIPTION
	1400-0017	0		CLAMP-CABLE .312-DIA .375-WD NYL	28480	1400-0017
W1	8120-2703	8	2	CABLE ASSEMBLY, 10-CONDUCTOR	28480	8120-2703
W2	8120-2703	8		CABLE ASSEMBLY, 10-CONDUCTOR	28480	8120-2703
W3	8120-2811	9	2	CABLE ASSEMBLY, 34-CONDUCTOR	28480	8120-2811
W4	8120-2811	9		CABLE ASSEMBLY, 34-CONDUCTOR	28480	8120-2811
W5	8120-1378	1	1	CABLE ASSY 18AWG 3-CNDCT JGK-JKT	28480	8120-1378
W6	11713-60009	6	1	CABLE ASSEMBLY, LINE ON/OFF (INCLUDES S1)	28480	11713-60009

See introduction to this section for ordering information
 *Indicates factory selected value
 †Backdating information in Section VII

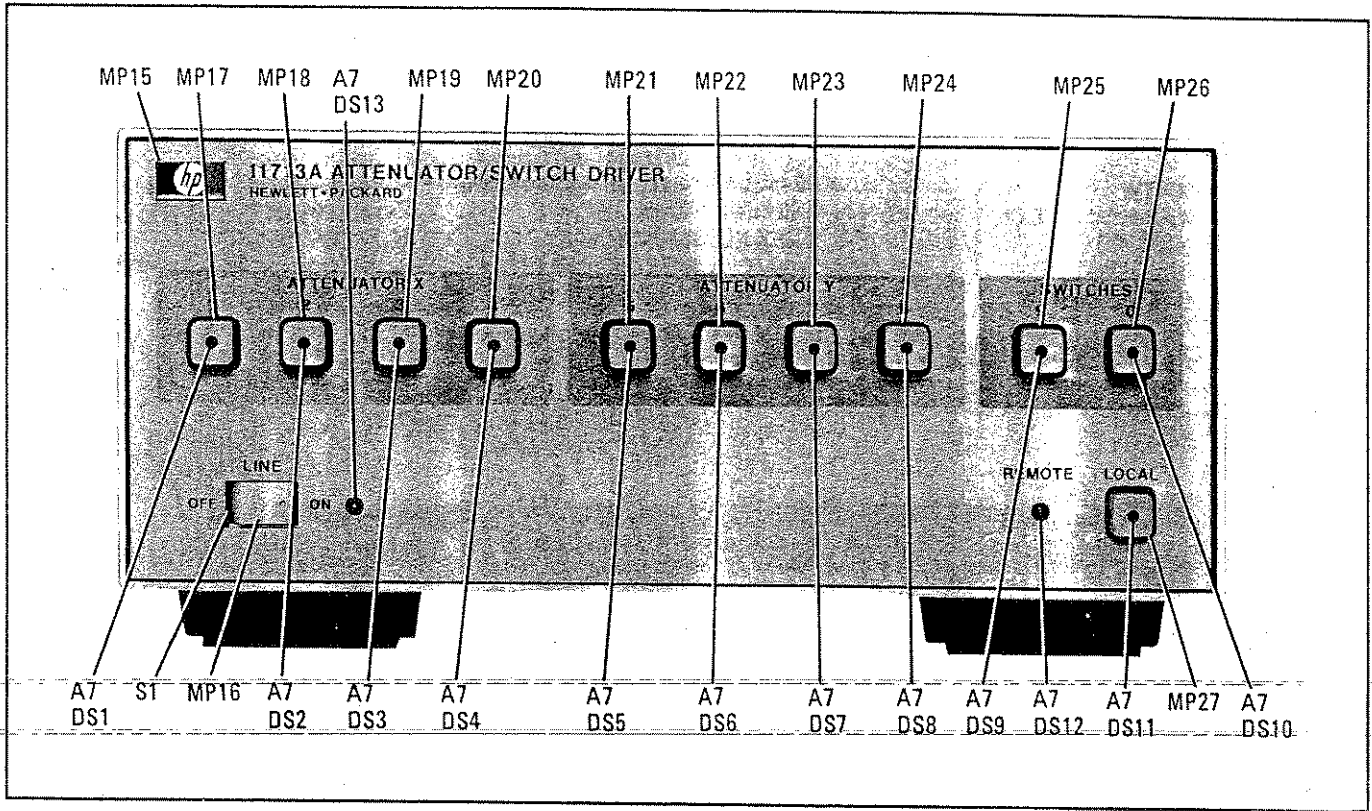

Figure 6-1. Front Panel Mechanical Parts

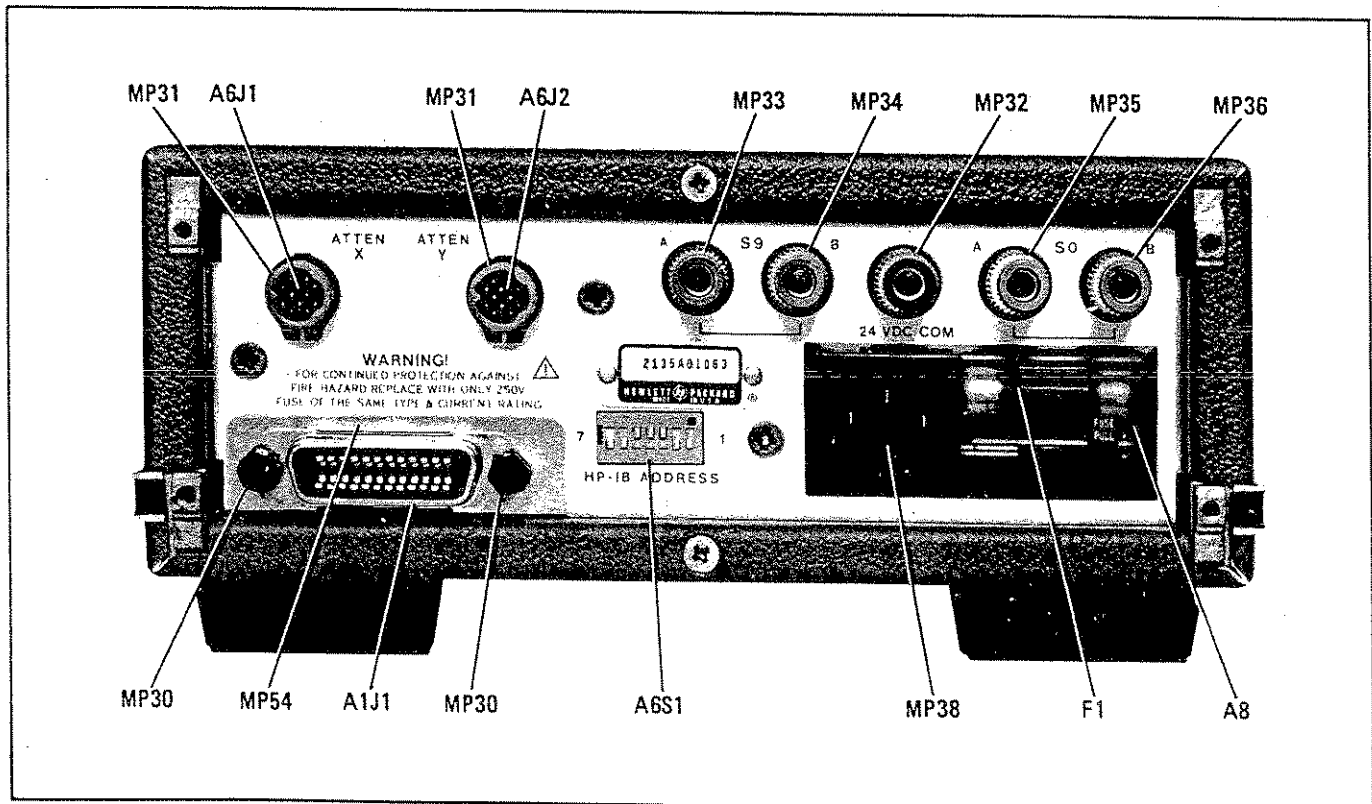

Figure 6-2. Rear Panel Mechanical Parts

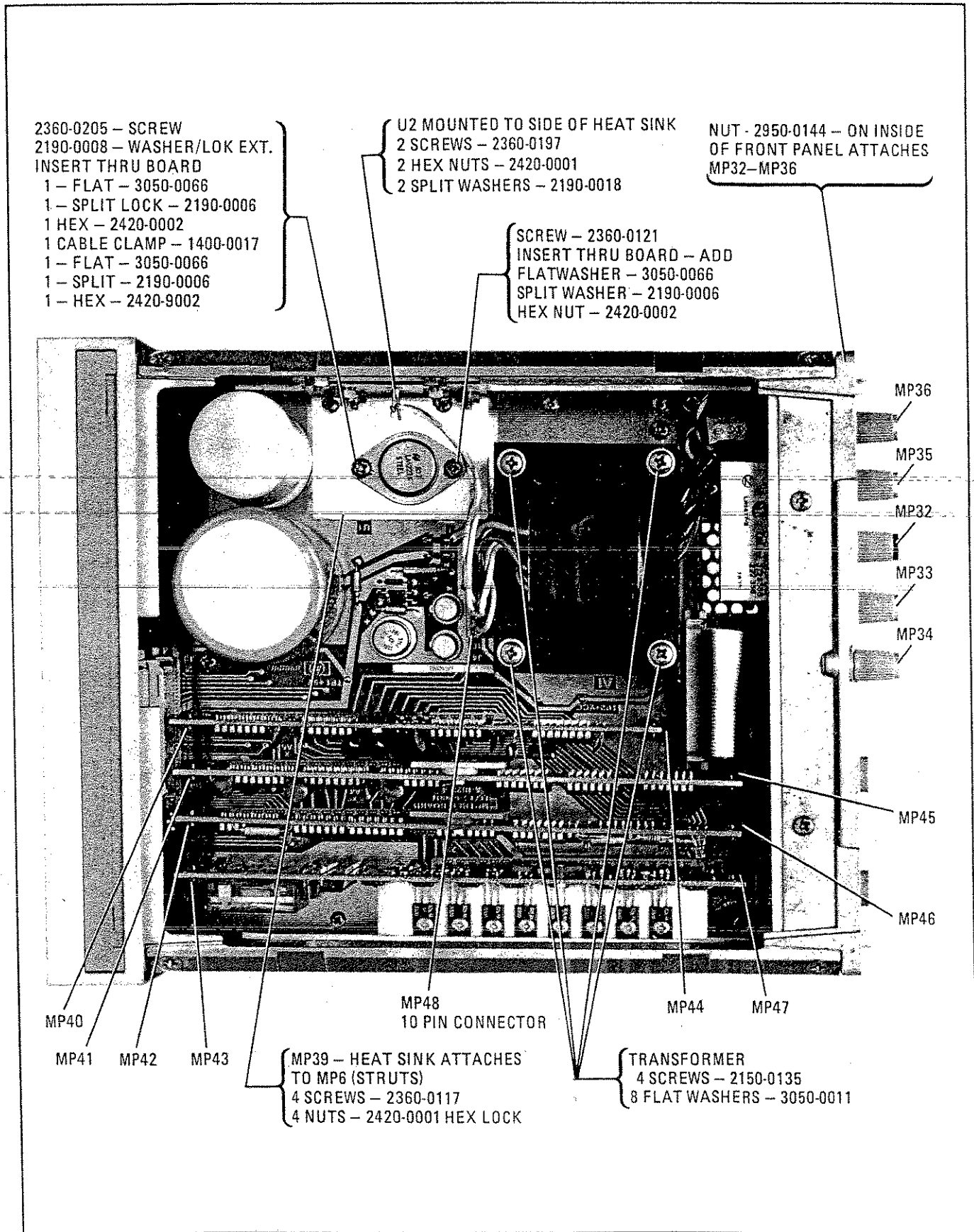

Figure 6-3. Top Internal Mechanical Parts and Hardware

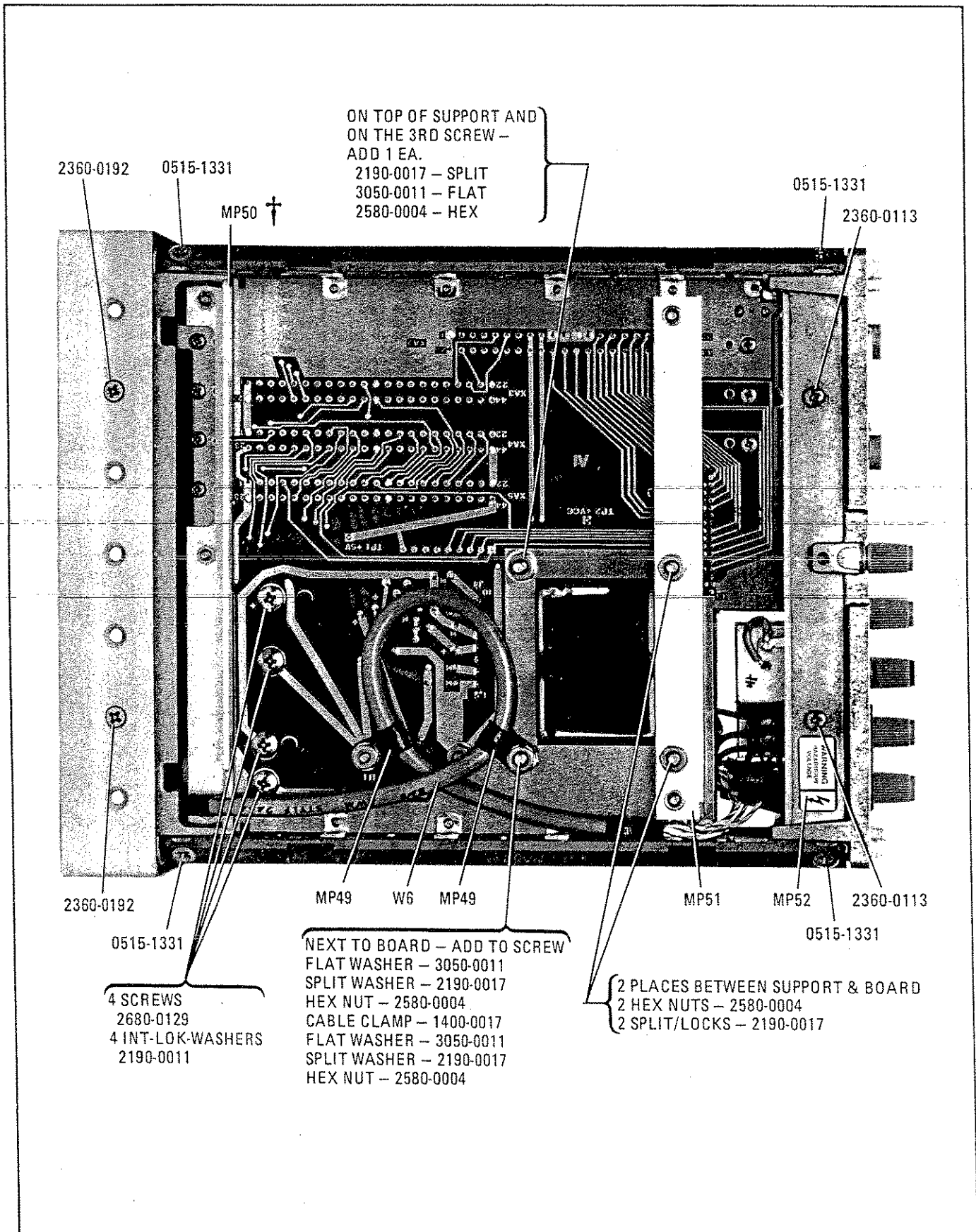

Figure 6-4. Bottom Internal Mechanical Parts and Hardware

Table 6-2. Replaceable Parts

Reference Designation	HP Part Number	C D	Qty	Description	Mfr Code	Mfr Part Number
CABINET PARTS						
MP1	11713-00001	2	1	PANEL, FRONT	28480	11713-00001
	2200-0138	3	2	SCREW-MACH 4-40 .188-IN-LG 100 DEG	28480	2200-0138
	2200-0103	2	5	SCREW-MACH 4-40 .25-IN-LG PAN-HD-POZI	28480	2200-0103
	0510-1148	2	4	RETAINER-PUSH ON KB-TO-SHFT EXT	28480	0510-1148
MP1E	2360-0192	7	4	SCREW-MACH 6-32 .25-IN-LG 100 DEG	28480	2360-0192
MP2†	5021-5813	4	1	FRAME, FRONT	28480	5021-5813
MP3	11713-00002	3	1	PANEL, SUB	28480	11713-00002
MP4†	5021-5814	5	1	FRAME, REAR	28480	5021-5814
MP5†	11713-00012	5	1	PANEL, REAR	28480	11713-00012
	2360-0113	2	4	SCREW-MACH 6-32 .25-IN-LG PAN-HD-POZI	00000	ORDER BY DESCRIPTION
	2360-0198	3	3	SCREW-MACH 6-32 .438-IN-LG 100 DEG	00000	ORDER BY DESCRIPTION
	2950-0144	0	5	NUT-HEX-DBL-CHAM 3/8-32-THD .188-IN-THK	00000	ORDER BY DESCRIPTION
	0510-0079	6	4	RETAINER-RING BSC EXT .5-IN-DIA STL	28480	0510-0079
	0380-0644	4	2	STANDOFF-HEX .327-IN-LG 6-32THD	00000	ORDER BY DESCRIPTION
	0515-1331	5	8	SCREW-METRIC SPECIALTY M4 X 0.7 THD; 6	28480	0515-1331
MP6†	5021-5829	2	2	STRUT, SIDE 3-1/2H X 11D	28480	5021-5829
MP7†	5021-4542	4	1	TOP COVER, PERFORATED	28480	5021-4542
MP8†	5061-9571	3	1	COVER, PERFORATED, BOTTOM	28480	5061-9571
MP9	5040-7201	8	2	FOOT (STANDARD)	28480	5040-7201
MP10	5040-7222	3	2	FOOT, NON-SKID FM, 1/2H	28480	5040-7222
MP11	5040-7203	0	1	TRIM-TOP 1/2	28480	5040-7203
MP12	5001-0438	7	2	TRIM-SIDE	28480	5001-0438
MP13	1460-1345	5	1	TILT STAND SST	28480	1460-1345
MP14†	7120-4294	5	1	LABEL, WARNING	28480	7120-4294
MP15	7120-1254	1	1	NAMEPLATE .312-IN-WD .54-IN-LG AL	28480	7120-1254

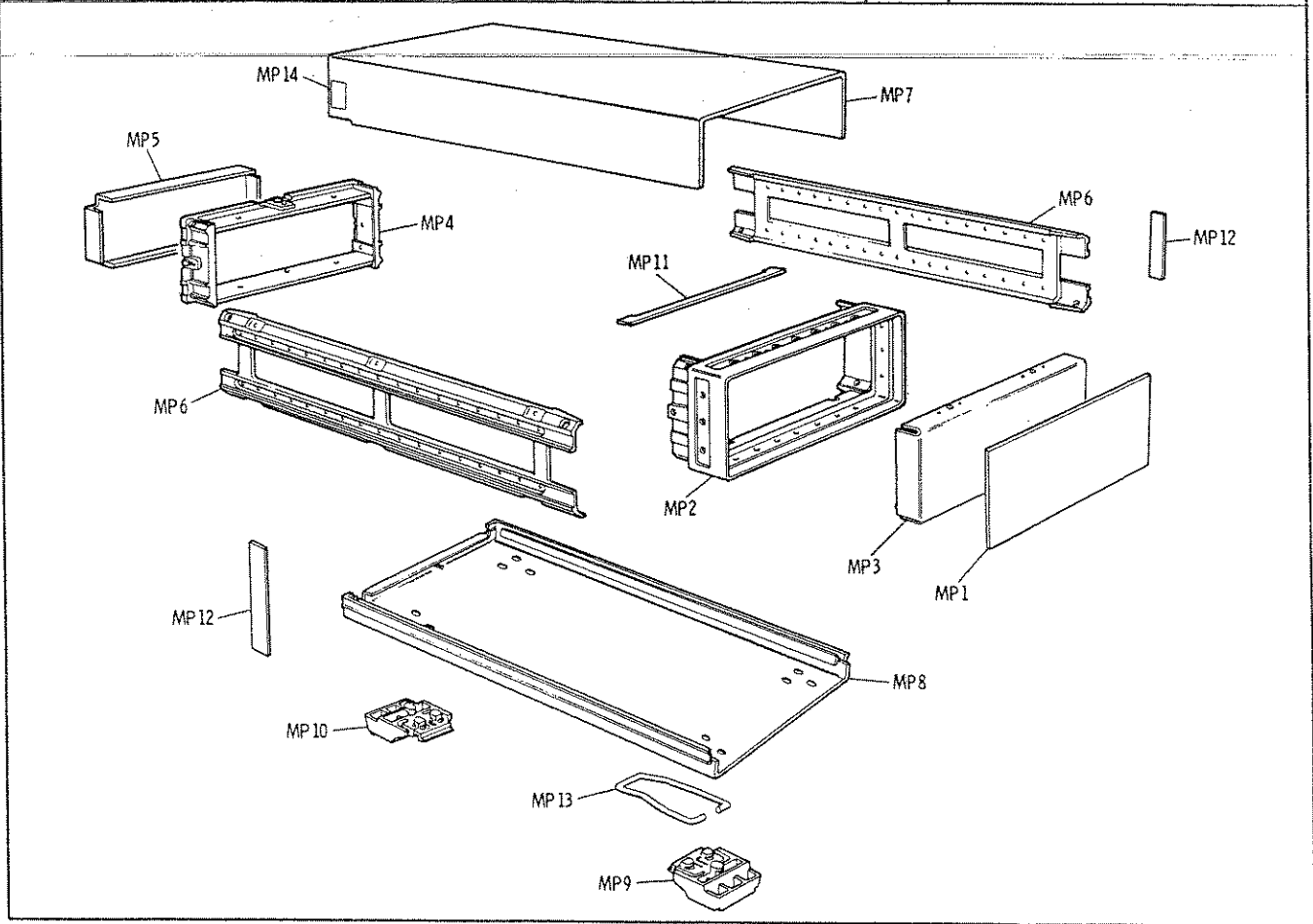

Figure 6-5. Cabinet Parts

See introduction to this section for ordering information
 *Indicates factory selected value
 †Backdating information in Section VII

Table 6-3. Code List of Manufacturers

Mfr Code	Manufacturer Name	Address	Zip Code
00000	ANY SATISFACTORY SUPPLIER		
00853	SANGAMO ELEC CO S CAROLINA DIV	PICKENS SC	29671
01295	TEXAS INSTR INC SEMICOND CMPNT DIV	DALLAS TX	75222
04713	MOTOROLA SEMICONDUCTOR PRODUCTS	PHOENIX AZ	85008
05820	WAKEFIELD ENGINEERING INC	WAKEFIELD MA	01880
07263	FAIRCHILD SEMICONDUCTOR DIV	MOUNTAIN VIEW CA	94042
19701	MEPCO/ELECTRA CORP	MINERAL WELLS TX	76067
24546	CORNING GLASS WORKS (BRADFORD)	BRADFORD PA	16701
27014	NATIONAL SEMICONDUCTOR CORP	SANTA CLARA CA	95051
28480	HEWLETT-PACKARD CO CORPORATE HQ	PALO ALTO CA	94304
3L585	RCA CORP SOLID STATE DIV	SOMERVILLE NJ	
56289	SPRAGUE ELECTRIC CO	NORTH ADAMS MA	01247
72136	ELECTRO MOTIVE CORP	FLORENCE SC	06226

SECTION VII MANUAL CHANGES

INTRODUCTION

This section contains manual change instructions for backdating this manual for HP Model 11713A Attenuator/Switch Driver with serial number prefixes lower than 2508A.

MANUAL CHANGES

To adapt this manual to your instrument, refer to Table 7-1 and make the manual changes listed opposite your instrument's serial number prefix. The manual changes are listed in serial number prefix sequence and should be made in the sequence listed.

If your instrument's serial number prefix is not listed on the title page of this manual or in Table 7-1, it may be documented in a MANUAL CHANGES supplement. For additional important information about serial number coverage, refer to

INSTRUMENTS COVERED BY MANUAL in Section I.

Table 7-1. Manual Changes by Serial Number Prefix

Serial Number Prefix	Make Manual Changes
1850A	F, E, D, C, B, A
1946A	F, E, D, C, B
2135A	F, E, D, C
2223A	F, E, D
2335A	F, E
2421A	F

MANUAL CHANGES

MANUAL CHANGE INSTRUCTIONS

CHANGE A

Page 6-7, Table 6-2:

- Delete A5R7 and A5R8 0757-0438 RESISTOR-FXD 5.11K 1% .125W
- Change A5U1 to 1820-1197.

Page 8-11 Figure 8-5:

Replace with Figure 7-2.

Page 8-11, Figure 8-6, Service Sheet 3:

Change A5 schematic diagram to configuration in Figure 7-1.

Change part number for U1 to 1820-1197 in TRANSISTORS AND INTEGRATED CIRCUIT PART NUMBERS box (right-hand side).

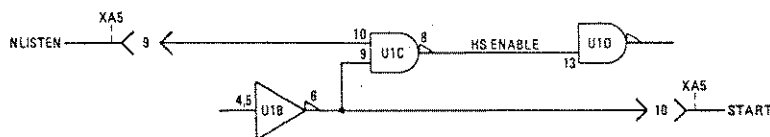

Figure 7-1. Reference Circuit Schematic Backdating (Partial Diagram, Part of Change A)

MANUAL CHANGES

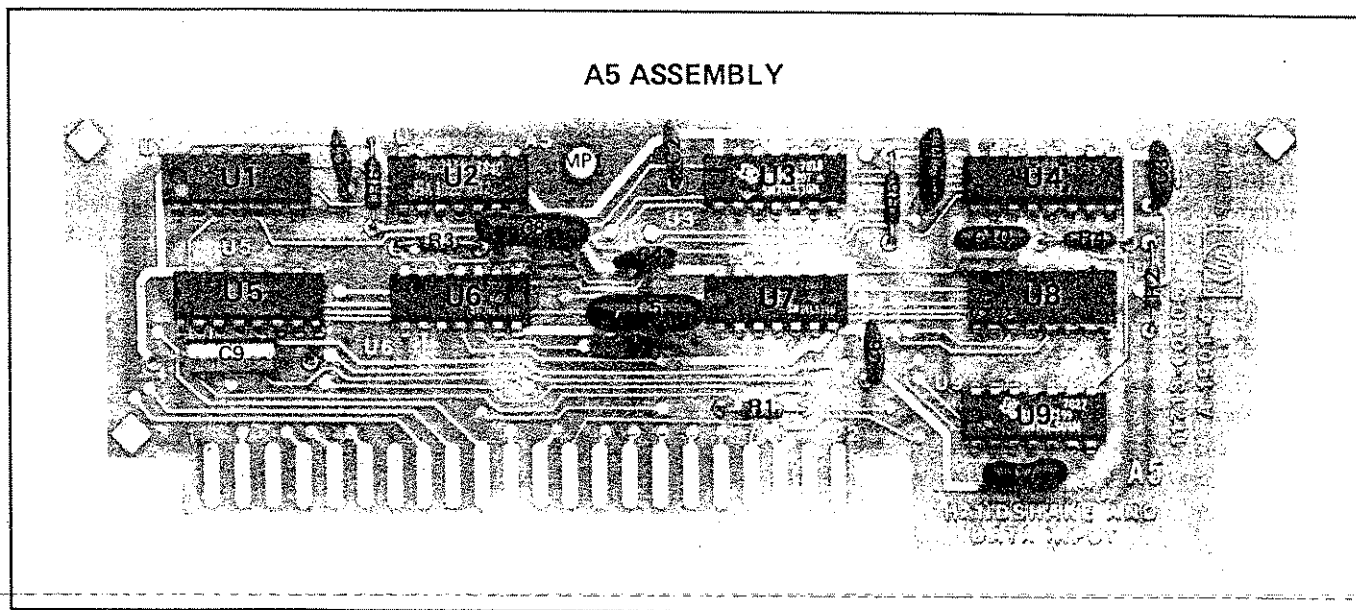

Figure 7-2. A5 HP-IB Handshake and Data Input Assembly Component Locations (P/O CHANGE A)

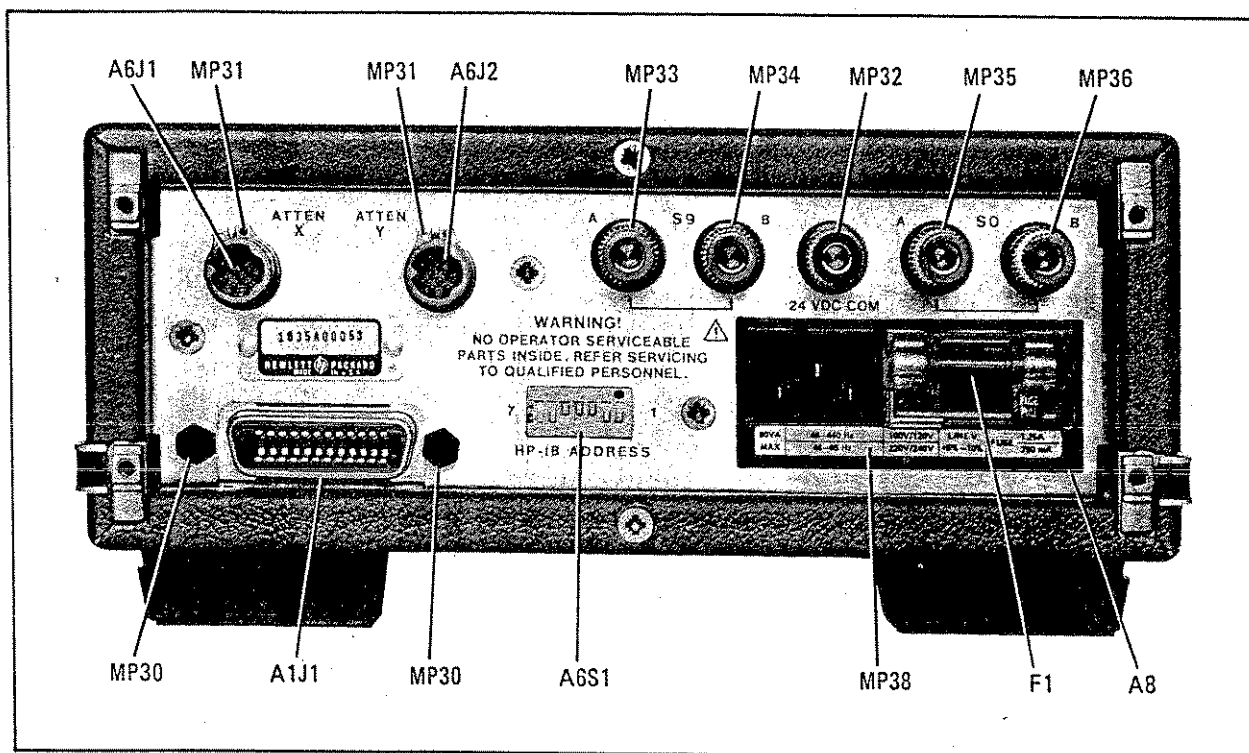
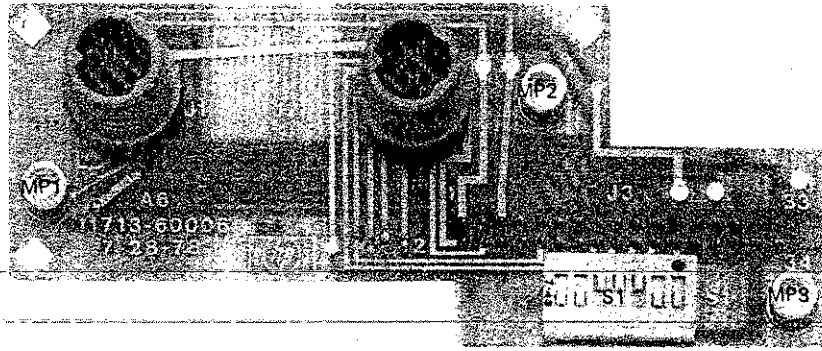

Figure 7-3. Rear Panel Mechanical Parts (P/O CHANGE B)

A6 ASSEMBLY
COMPONENT SIDE



CIRCUIT SIDE

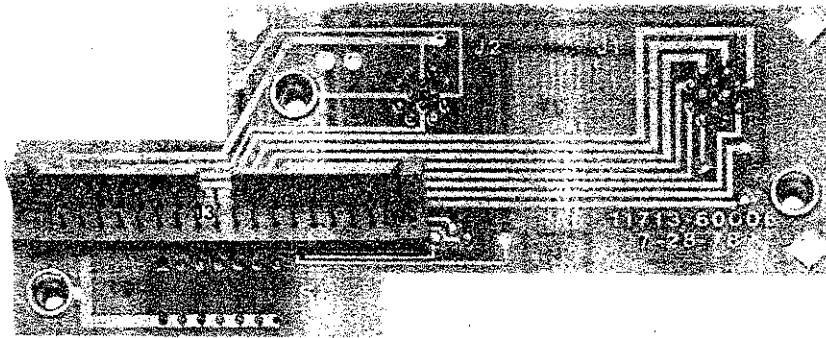

Figure 7-4. A6 Interface Assembly Component Locations (P/O CHANGE B)

A1 ASSEMBLY

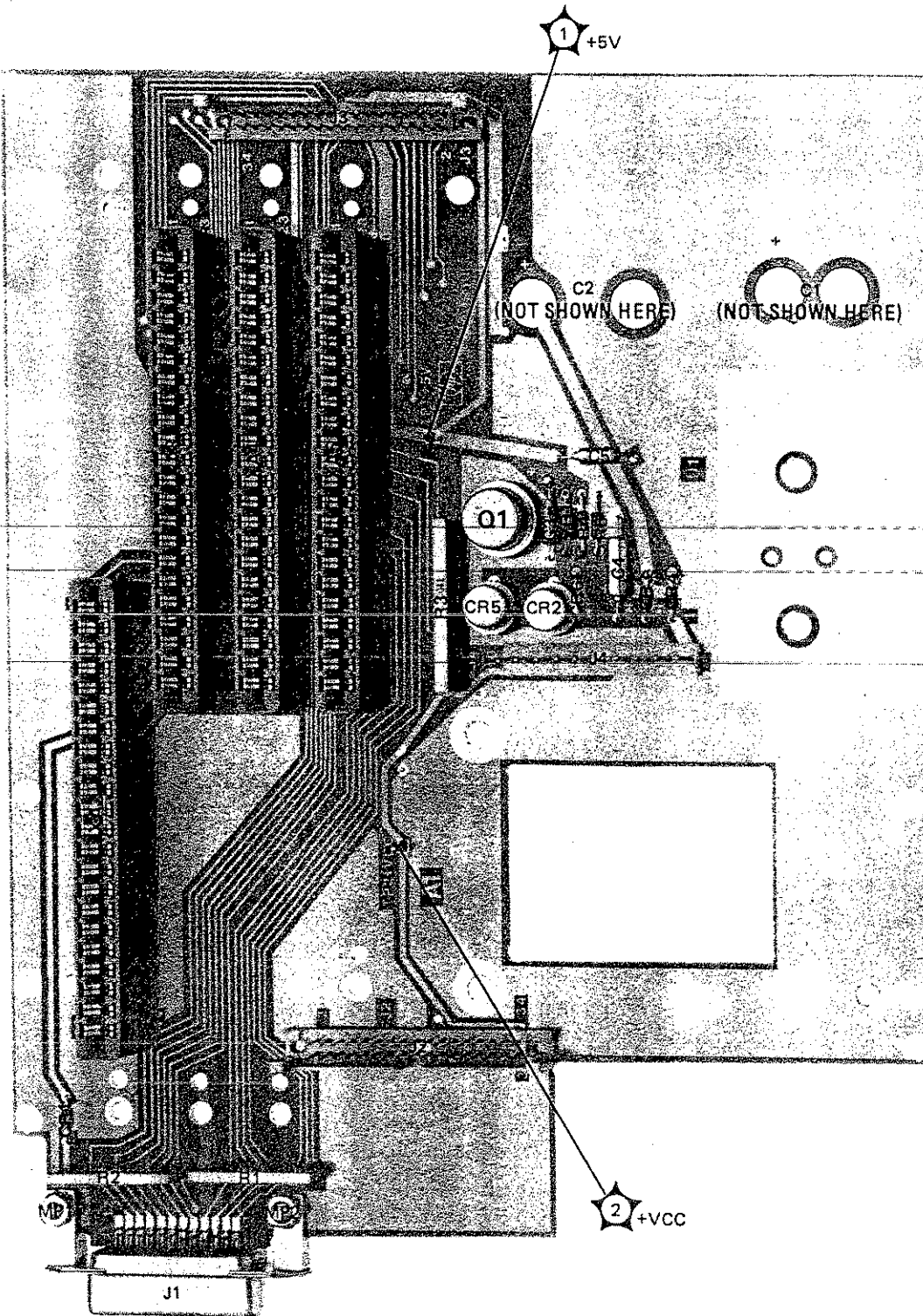

Figure 7-5. A1 Interconnect and Power Supply Component Locations (P/O CHANGE B)

MANUAL CHANGE INSTRUCTIONS (Cont'd)

CHANGE B

Table 6-2:

Change A1 to 11713-60001 CD8 same description.

Table 6-2:

Change A6 to 11713-60006 CD3 same description.

Table 6-2:

Change MP51 to 11713-00006 CD7 same description.

Delete MP54 11713-00009 CD0 LOCKING SLIDE PLATE.

Figure 6-2:

Change to Figure 7-3 (P/O CHANGE B) found in this section.

Table 6-2:

Change MP5 to 11713-00005 CD6 PANEL, REAR.

Change MP14 to 7120-8053 CD2 LABEL, WARNING.

Page 8-9 through 8-20, (Service Sheets 2, 3, 4, 5 and 6):

Change A1 Interconnect Assembly part number to 11713-60001.

Page 8-11, Figure 8-6 (Service Sheet 3):

Change A6 Interface Assembly part number to 11713-60006.

Page 8-16, Figure 8-11:

Change to Figure 7-4 (P/O CHANGE B) found in this section.

Page 8-17, Figure 8-13 (Service Sheet 6):

Change A6 Interface Assembly part number to 11713-60006.

Page 8-19/8-20, Figure 8-15:

Change to Figure 7-5 (P/O CHANGE B) found in this section.

Page 8-19/8-20, Figure 8-16 (Service Sheet 7):

Change A1 Interconnect and Power Supply Assembly to 11713-60001.

CHANGE C

Table 6-2:

Change A1 to 11713-60011 CD0 same description.

Delete A1MP3 11713-00014 CD7 Interconnect Board Support.

Table 6-3:

Change A7Q1 and A7Q2 to 1854-0810 CD2 TRANSISTOR NPN S1 PD = 625 MW FT = 200 MHz (Recommended Replacement).

Table 6-2:

Add MP50 11713-00004, Support, Motherboard.

Page 8-9 through 8-20 (Service Sheets 2, 3, 4, 5, 6 and 7):

Change A1 Interconnect Assembly part number to 11713-60011.

Page 8-19/8-20, Figure 8-15 (Service Sheet 7)

Change to Figure 7-6 (P/O CHANGE C) found in this supplement.

MANUAL CHANGE INSTRUCTIONS (cont'd)**CHANGE D**

Table 6-2:

Change MP30 to 0380-0643 CD3 STANDOFF-HEX 0.255 IN-LG 6-32 THD.

NOTE

This change applies directly to serial number prefix 2335A, and is the recommended replacement for serial number prefix 2223A. It cannot be used for serial number prefixes prior to 2223A. There are two standoffs per instrument and both should be replaced on serial number prefix 2223A.

CHANGE E

Table 6-2:

Change A1Q1 to 1884-0012 CD9 THYRISTOR-SCR TO-5 2N3528; MFR CODE 01928; MFR PART NUMBER 2N3528.

Table 6-2:

Add 11713-00008 CLAMP, SWITCH.

CHANGE F

Page 1-2, OPTIONS paragraph:

Change Option 907 HP Part No. to 5061-0088 CD9.

Change Option 908 HP Part No. to 5061-0072 CD1.

Figure 6-4:

Change 2360-0192 to 2360-0181 two places. This screw is used in four places, only two are shown in this figure.

Change 0515-1331 to 2510-0182 four places. This screw is used in eight places, only four are shown in this figure.

Table 6-2:

Change under MP1 2360-0192 to 2360-0181 CD4 SCREW-MACH 6-32 X 0.25-IN-LG.

Change MP2 to 5020-8813 CD8 FRAME: FRONT.

Change MP4 to 5020-8814 CD9 FRAME: REAR.

Change under MP5 0515-1331 to 2510-0192 CD6 SCREW MACH 8-32 0.25 IN LG 100 DEG.

Change MP6 to 5020-8829 CD6 STRUT, SIDE 2-½ H X 11 D.

Change MP7 to 5021-0835 CD0 TOP COVER, PERFORATED.

Change MP8 to 5060-9971 CD5 BOTTOM COVER, PERFORATED.

SECTION VIII SERVICE

INTRODUCTION

This section provides information on service related subjects. Safety considerations include warnings to be observed while servicing the instrument. The arrangement of the principles of operation and troubleshooting is explained.

The service sheets are in the following foldout section. Each service sheet includes a schematic diagram, with accompanying principles of operation. Usually a component location diagram is also included. Figure 8-1 Schematic Diagram Notes provides general information which relates to block and schematic diagram symbols.

~~Other pertinent service information is included throughout the section.~~

SAFETY CONSIDERATIONS

This section contains warnings and cautions which must be followed for your protection and to avoid damage to the equipment.

WARNINGS



Maintenance described herein is performed with power supplied to the instrument and with protective covers removed. Such maintenance should be performed only by service-trained personnel who are aware of the hazards involved.

Where maintenance can be performed without power supplied, the power should be removed.

Any maintenance, and repair of the opened instrument under voltage should be avoided as much as possible and, when inevitable, should be carried out only by a skilled person who is aware of the hazard involved.

Capacitors inside the instrument may still be charged even if the instrument

has been disconnected from its source of supply.

Make sure that only fuses with the required 250V rating, correct current rating, and of the specified type (normal blow, time delay, etc) are used for replacement. The use of repaired fuses and the short-circuiting of fuseholders must be avoided.

Whenever it is likely that this protection has been impaired, the instrument must be made inoperative and be secured against any unintended operation.

SERVICE

Service instructions consist of principles of operation, troubleshooting, and repair.

PRINCIPLES OF OPERATION

The HP 11713A Attenuator/Switch Driver has a self-contained power supply to provide the drive requirements for programmable attenuators and coaxial switches. The instrument includes solenoid arc suppression diodes and has common terminal supplies of +24 Vdc. The driver may be controlled remotely by simple HP-IB commands or locally from the front panel. Connections are made at the rear panel to the ten pairs of current sinking transistors that are provided. Two sets of four contact pairs per set are present at each rear panel multi-pin plug. This plug mates with the attenuator drive cable. The remaining two contact pairs are connected to the banana jacks mounted on the rear panel. The banana jacks are available for driving the coaxial switches or for optional applications. Each pair of contacts is individually programmable via HP-IB bus or from the front panel pushbutton. The contact pair status is indicated by front panel LED's in the appropriate pushbuttons. The contact pairs 9 & 0 can be used to switch between one of two loads or to reverse the current through a single load.

SCHEMATIC DIAGRAM NOTES

- *

Asterisk denotes a factory-selected value. Value shown is typical. Part may be omitted.
 - Encloses front-panel designation.
 - Encloses rear-panel designation.
 - Circuit assembly borderline.
 - Other assembly borderline. Also used to indicate mechanical interconnection (ganging).
 - Heavy line with arrows indicates path and direction of main signal.
 - Heavy dashed line with arrows indicates path and direction of main feedback.
-
- | | |
|--|---|
| <p> 1</p> <p>Numbered Test Point.
Measurement aid provided.</p> | <p> A</p> <p>Lettered Test Point.
No measurement aid provided.</p> |
|--|---|
 - Encloses wire color code. Code used is the same as the resistor color code. First number identifies the base color, second number identifies the wider stripe, and the third number identifies the narrower stripe, e.g., **(947)** denotes white base, yellow wide stripe, violet narrow stripe.
 - A conducting connection to a chassis or frame.
 - Common connections. All like-designated points are connected.
 - A** Letters = off page connection, e.g., **A**
 - 2** Number = Service Sheet number for off-page connection, e.g., **2**
 - 1** THIS PAGE
Number (only) = on page connection.
 - Indicates multiple paths represented by only one line. Letters or names identify individual paths. Numbers indicate number of paths represented by the line.
 - Coaxial or shielded cable.

Figure 8-1. Schematic Diagram Notes (1 of 3)

SCHMATIC DIAGRAM NOTES

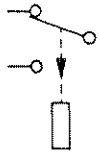

Relay contact moves in direction of arrow when energized

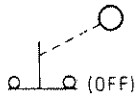

Indicates a pushbutton switch with a momentary (ON) position.



NSTOR

Signals that are active-low, are identified by the letter N followed by a signal mnemonic (such as NSTOR).

STOR

Signals that are active-high are identified by a signal mnemonic (such as STOR).

Figure 8-1. Schematic Diagram Notes (2 of 3)

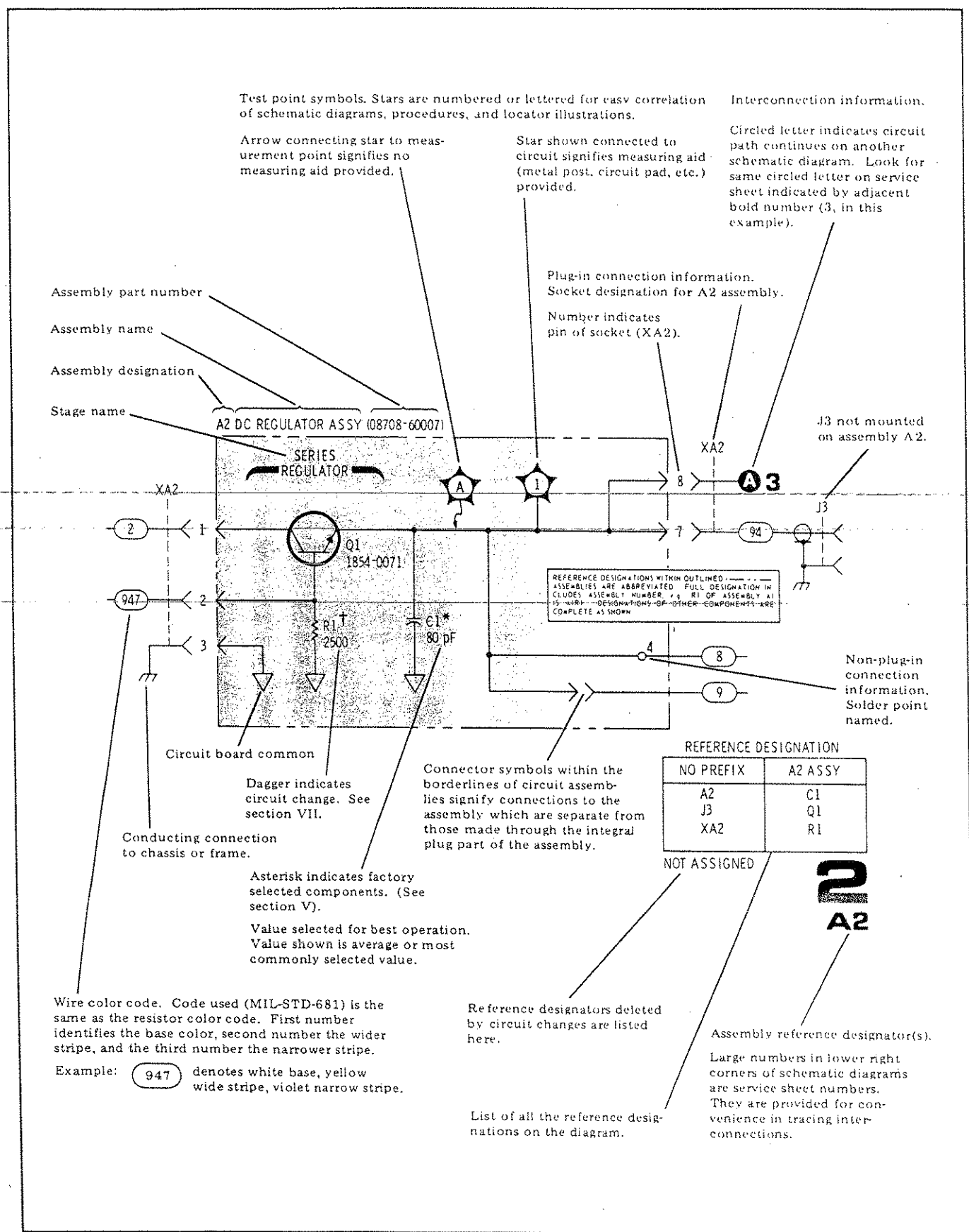

Figure 8-1. Schematic Diagram Notes (3 of 3)

TROUBLESHOOTING

The Driver circuits are conventional and straight forward. Significant circuit stage functions are

identified on the schematic diagrams. Use the information on the schematics and the procedure in Table 8-1 to isolate a malfunction.

Table 8-1. Troubleshooting Hints

1. Remove the Driver top cover.
2. Turn on the Driver and verify that the proper power up status is reached. The Driver comes up in local with all pushbutton LED's on which corresponds to maximum attenuation settings.
3. Measure the voltages at A1TP1 and A1TP2.
 - TP1 = +5.0 ±0.5 Vdc
 - TP2 = +24.0 ±1.0 Vdc
4. Verify that the +24.0 ±1.0 Vdc is present at the rear panel red banana jack.
5. If an attenuator or switch buzzes when actuated by the front panel pushbutton, the output transistor may be shorted, or one of the protection diodes may be shorted.
6. If one of the pushbutton LED's does not light. First determine if the pushbutton is operational by checking to see if the circuitry drives an attenuator or switch properly. If the switching click of the relay in the attenuator or switch can be heard, this indicates that only the LED may be defective.
7. Check the Driver in full local operation before testing in remote operation.
8. If a pushbutton does not actuate an attenuator section or change the position of a coaxial switch:
 - a. Check the output pulses of the A7 Switch Board Assembly either at the A7 outputs or on the multiplexer inputs of the A4 Remote Local Logic Assembly.
 - b. If the pulses are present when the corresponding front panel button is pushed, check the output of the A4 multiplexers. Verify that the multiplexers are in the local mode of operation.
 - c. Verify that the pulse reaches the clock input of A3 Latch Assembly driver storage register flip-flops. Verify that the Q and NQ outputs change state as the corresponding pushbutton is exercised.
 - d. Measure input and output levels of inverting drivers on the A2 Driver Assembly.
 - e. If all logic levels up to the Darlington transistors operate, check for shorted or open Darlington transistors. For proper operation the voltage across the series base resistor to the Darlington transistors should be ≥ 0.5 Vdc when that transistor is on.
9. To check the Driver in remote operation with no external loads connected, use a logic probe with the following 9825A controller program:

```

0: wrt 728, "A12345678"
1: wait 10,
2: wrt 728, "B12345678"
3: wait 10
4: gto 0
5: end

```

 - a. Probe A5U4 pin 6 and 9 with the logic probe to verify that the one shot is operating.
 - b. Probe A4U2 pin 5 to verify the presence of a pulse that triggers the decoders.
 - c. Verify that the A4U9B Listen flip-flop is set High.
 - d. Verify that the A4U4A pin 12 Remote Local logic is set High.
 - e. Verify that the A5U5 pin 14 Address Comparator is set High.



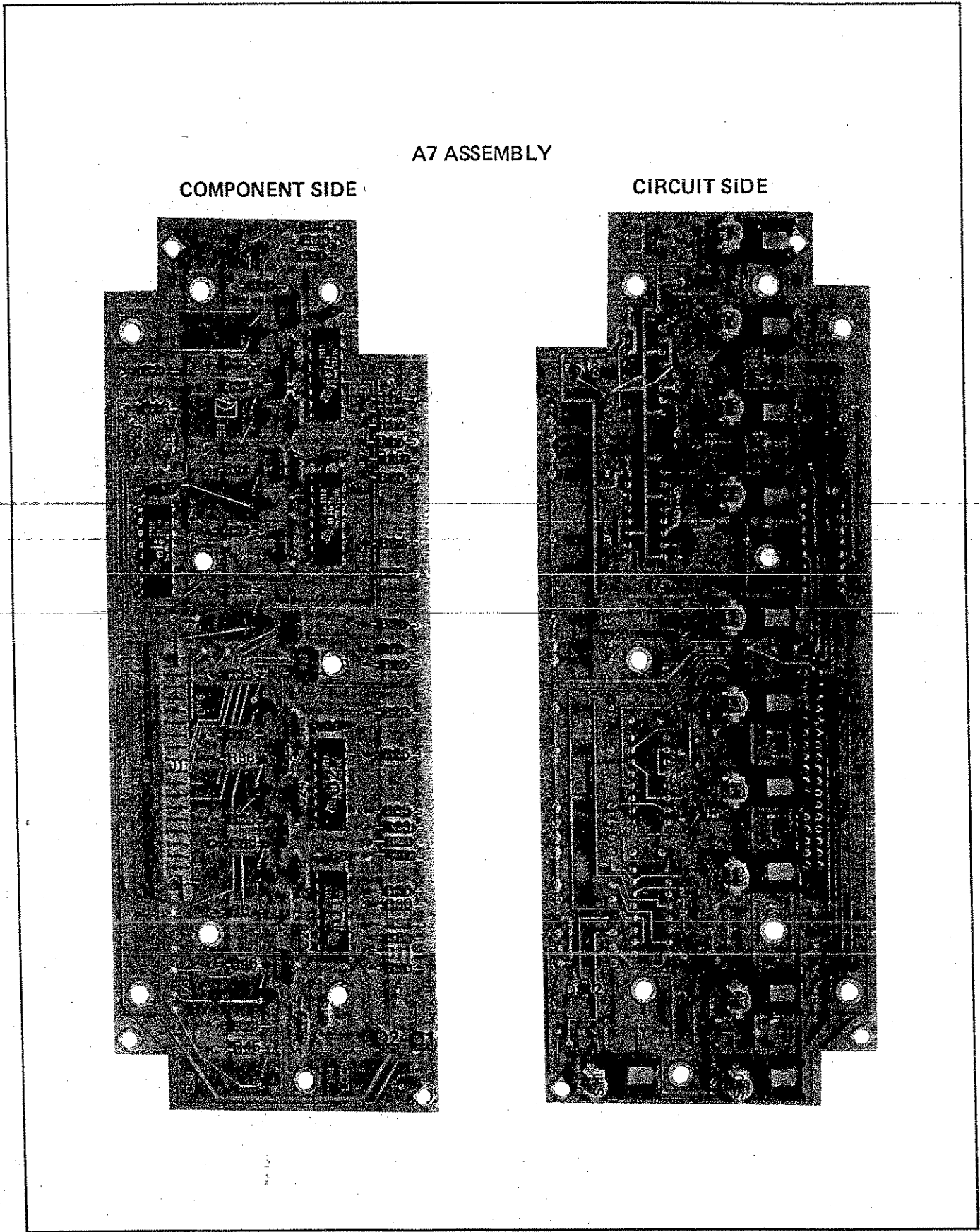

Figure 8-3. A7 Switch Board Assembly Component Locations

SERVICE SHEET 2

PRINCIPLES OF OPERATION

The A7 Switch Board Assembly (front panel) consists of 10 non-retriggerable monostable multivibrators. The resistor connected to the +5 volts keeps the input to the multivibrators at a logic high. The voltage across the input capacitor (e.g., C1) is 0 volts when the front panel pushbutton switches are open. When a button is pressed, the input voltage on the one shot instantaneously drops to 0 volts and starts the output pulse. The output pulse width is controlled by a resistor and capacitor (e.g., C5 and R7). Nominal pulse width is 17 ms. The pulses are sent to the local/remote multiplexers on the A4 assembly and become the clock inputs for the flip-flops on the A3 Latch Assembly.

LED's behind the front panel switches indicate the present output state of the Driver as seen by the flip-flops on the A3 Latch Assembly. The Driver is in the "A" state when LEDs are on and in the "B" state when they are off.

LOCAL and REMOTE LED's signify the operating mode of the Driver. A Reset circuit clears the LOCAL-REMOTE flip-flop on the A4 Remote Local Assembly to the local state unless the instrument is in Local Lockout. The ON-OFF LED is operated from the +5 Vdc supply.

In Remote operation, i.e., HP-IB control, Bus command directed at the Driver sets the Listen flip-flop to allow further Bus commands to be accepted until a Local command is given which resets the Listen flip-flop.

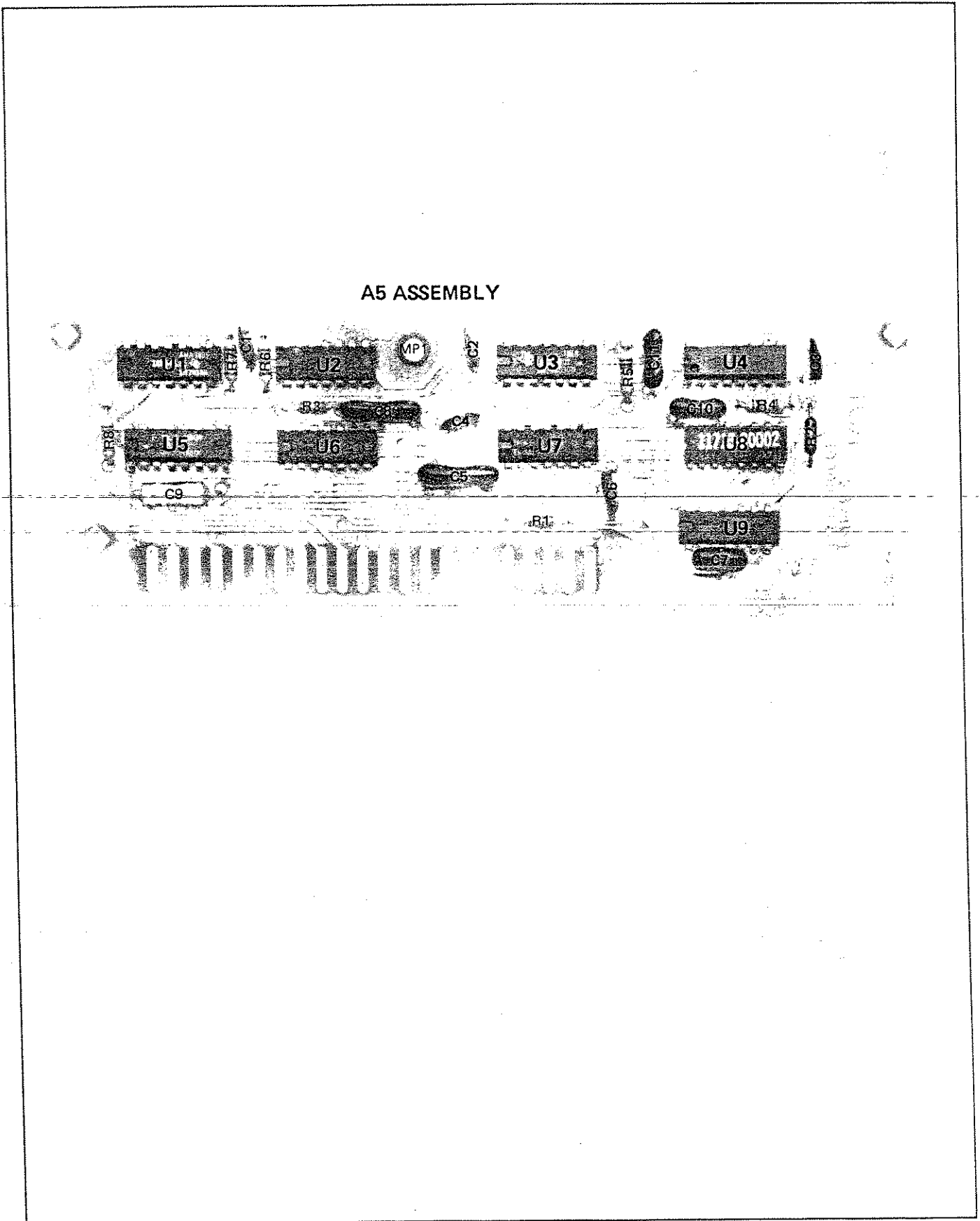

Figure 8-5. A5 HP-IB Handshake and Data Input Assembly Component Locations

SERVICE SHEET 3

PRINCIPLES OF OPERATION

The A5 HP-IB Handshake and Data Input Assembly provides the interface between the bus and the Driver. The three-wire handshake lines to the Handshake Logic circuits synchronize the operation of the Driver Remote operation. The lines are Ready For Data (NRFD), Data Valid (DAV), and Data Accepted (NDAC). The Handshake logic processes the DAV signal and produces the Handshake Out (HS OUT) signal passed to the Bus Logic and the Local Lockout Logic. The DAV signal and the Handshake Enable (HS ENABLE) signal combine to output the NRFD and NDAC signals on the bus. The basic purpose of this logic is to signal the other Driver circuits that the DIO lines contain a character for possible processing to interface the circuits to the HP Interface Bus three-wire handshake system.

The bus logic accepts inputs from the Data Input/Output (DIO) lines and the Attention (ATN) signal from the Interface Bus. These inputs, in conjunction with the HS OUT signal, enable the Remote/Local Logic and the Local Lockout Logic.

In addition, the Bus Logic processes the Attenuator/Switch state codes and select codes present on the DIO lines. It then combines them with Handshake Out (HS OUT) and Remote Signals to Output the NCLK Signal from U11A on the A4 Remote/Local Assembly.

The Bus Logic serves the additional function, in conjunction with the Remote/Local Logic, of placing the Driver into Remote operation or Local operation on command from the Interface Bus.

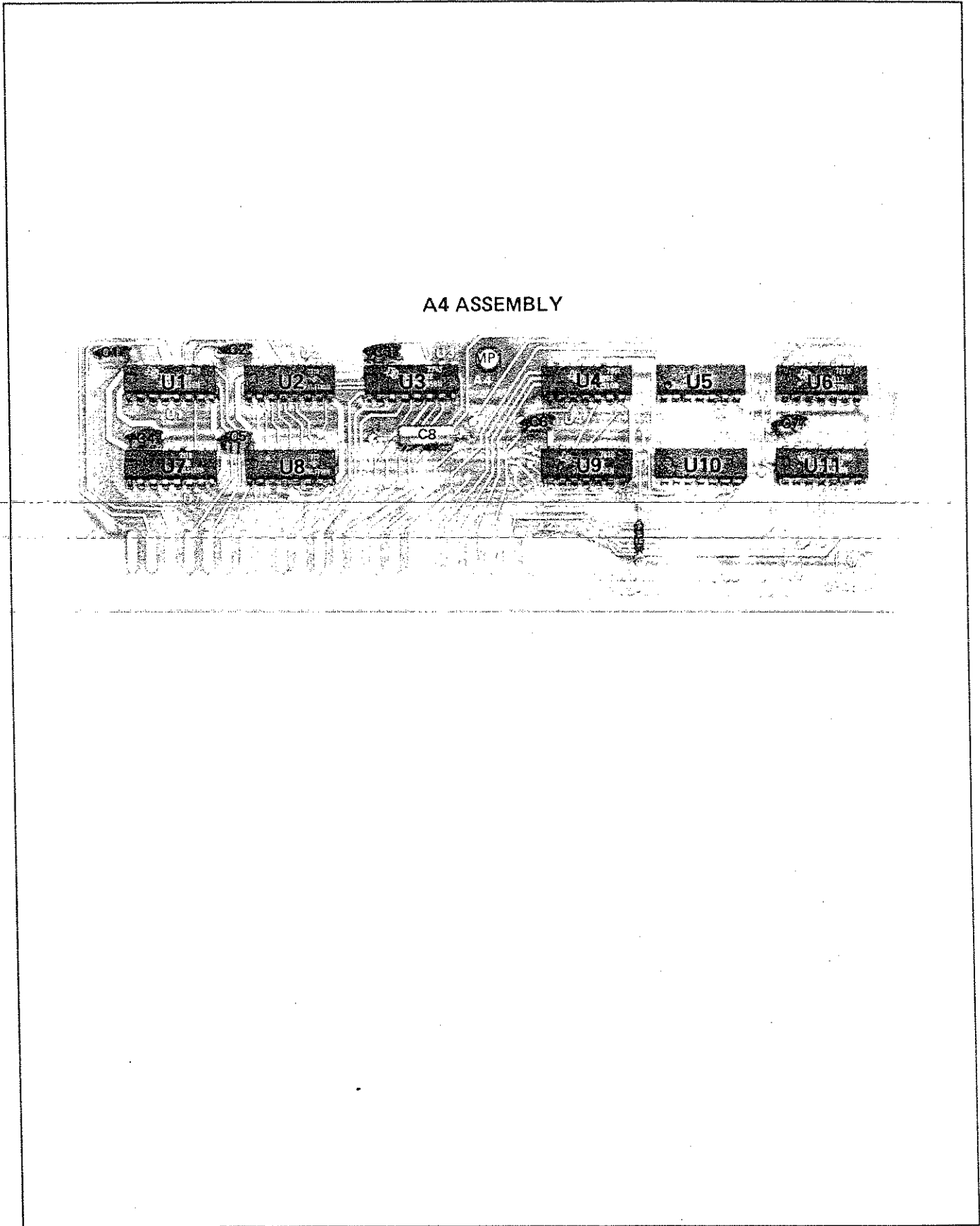

Figure 8-7. A4 Remote Local Logic Assembly Component Locations

SERVICE SHEET 4

PRINCIPLES OF OPERATION

The A4 Remote Local Logic Assembly contains a Remote/Local flip-flop, an "A" or "B" flip-flop, a 4 line to 10 line decoder, a Local Lockout flip-flop, Listen flip-flop, 10 two line to one line multiplexers and the required circuitry to generate a clock signal to control the operation of the 4 to 10 line decoder.

The Remote/Local flip-flop is programmed through the HP-IB circuitry on the A5 Handshake and Data Input Assembly. If the Local Lockout flip-flop is set to a high the Remote/Local flip-flop cannot be set to Local via the A7 front panel LOCAL pushbutton. In all other cases the A7 Local pushbutton will set the instrument to Local. In Local operation the 10 two line to one-line multiplexers are set to propagate and invert the outputs of the monostable multivibrators from the A7 front panel board. The outputs become the clocks for the A3 Latch Assembly flip-flops. Bus commands determine the state of the "A" or "B" flip-flop which controls the output state of the instrument. (See A3 description.)

The data inputs (DI01—DI04) set up the 10 possible output states of the 4 line to 10 line decoder. With the Listen flip-flop set, the Remote flip-flop set, Handshake output flip-flop set on the A5 assembly, the attention (ATN) line at a logic high from the controller and DI07 set to a logic high from the controller, a pulse is generated (NCLK) which switches the output of the decoder to the 2 line to 1 line multiplexer and sets or clears the flip-flops on the A3 Latch Assembly.

This pulse width is approximately equal to the pulse width of U4A on the A5 Handshake and Data Input Assembly ≈ 750 ns. One pulse is required every time one switch is set or cleared.

A3 ASSEMBLY

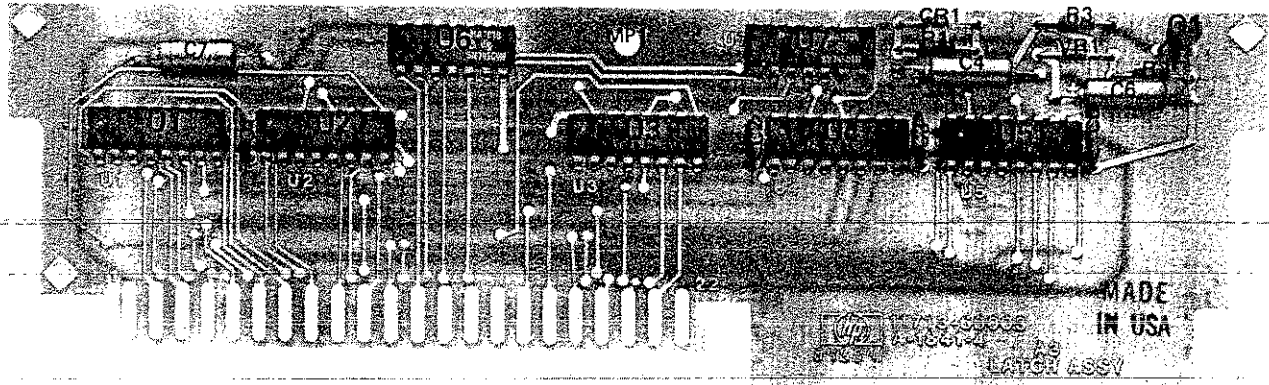

Figure 8-9. A3 Latch Assembly Component Locations

SERVICE SHEET 5

PRINCIPLES OF OPERATION

The A3 Latch Assembly contains 10 J-K flip-flops and a power up circuit. When the Driver is in the Local mode, the J and K inputs to all ten flip-flops are in the logic high state. The flip-flops then operate as "toggle" flip-flops and respond to the front panel pushbuttons. The pushbuttons function as clock pulses for the flip-flops. In the Remote state, the A4 A or B flip-flop controls the J, K inputs. In the A state, the J inputs are in the logic low state and the K inputs are logic high. The decoder on the A4 assembly generates the clock pulses for each flip-flop. In the A state, flip-flops 1-10 are set so that $Q=1$ and $NQ=0$. In the B state J inputs = 1 and K inputs = 0. Clock pulses from the decoder set flip-flops 1 through 10 on the negative edge as commanded by the bus.

The power-up circuit sets the state of all flip-flops so that the instrument powers up in the Local state and with all switches set to the "A" (LED's on) condition. Any Hewlett-Packard attenuators connected to the Driver are set to maximum attenuation on power up.

A2 ASSEMBLY

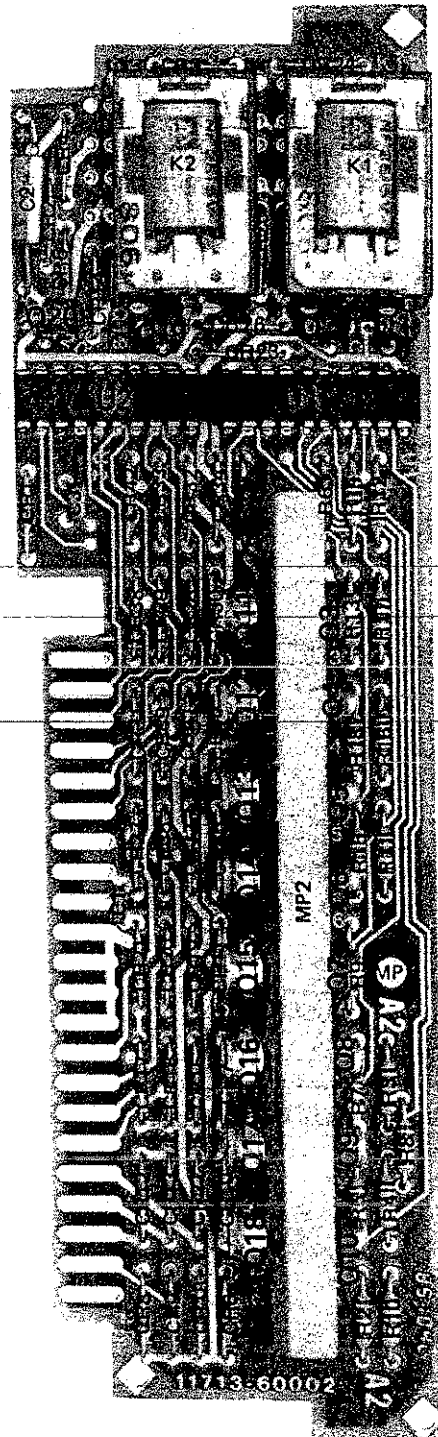
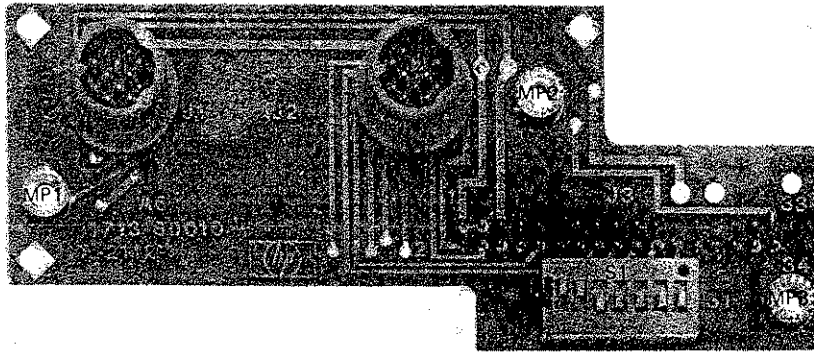

Figure 8-12. A2 Driver Assembly Component Locations

COMPONENT SIDE



CIRCUIT SIDE

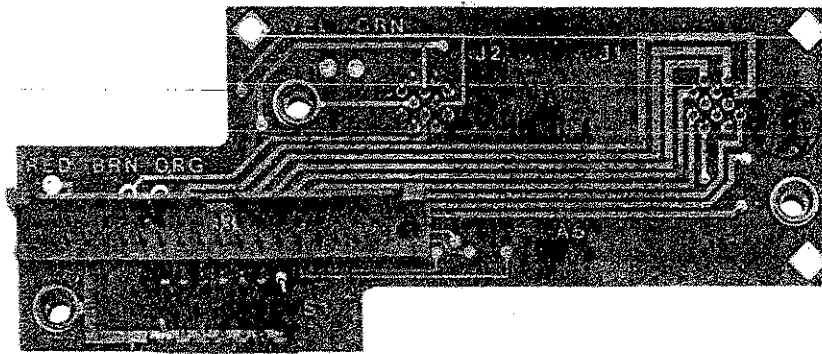

Figure 8-11. A6 Interface Assembly Component Locations

A1 ASSEMBLY

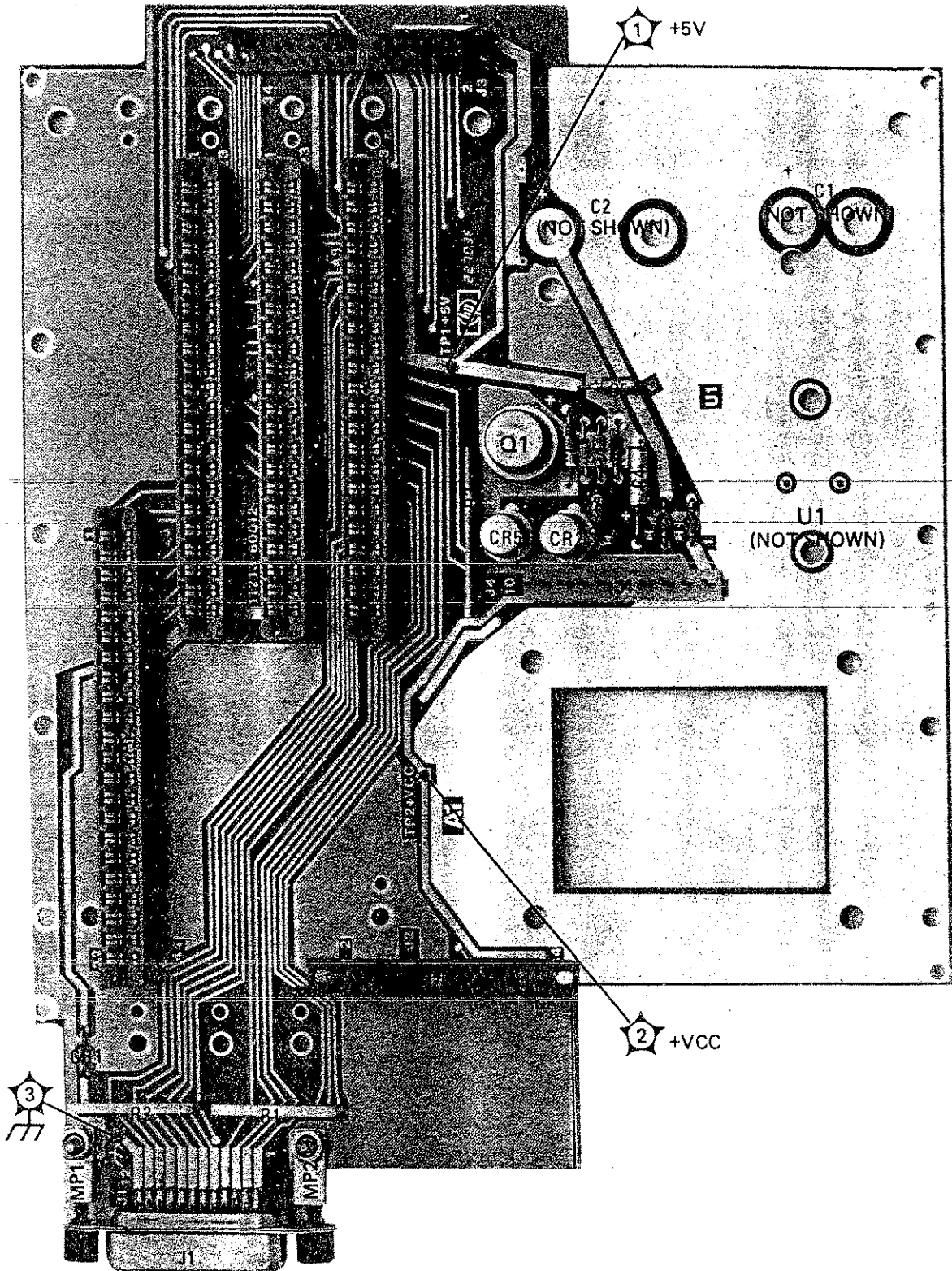

Figure 8-15. A1 Interconnect and Power Supply Component Locations

SERVICE SHEET 7

PRINCIPLES OF OPERATION

The A1 Interconnect Assembly contains the power supply and connectors for other major assemblies.

The power supply is enabled when the LINE ON-OFF switch is set to the ON position. The power supply provides +5 Vdc for the logic circuits, and +24 Vdc at 0.650 amperes continuous to drive attenuators, relays or switches connected to the Driver. Figure 8-14 shows the typical foldback characteristics of the +24 Vdc supply. A "Crowbar" circuit is incorporated that causes the primary line fuse to blow if the ac input voltage exceeds the ratings on the Power Mains Line Module.

In addition, the A1 assembly provides HP-IB lines level shifting to meet the IEEE specifications for a Listener Device.

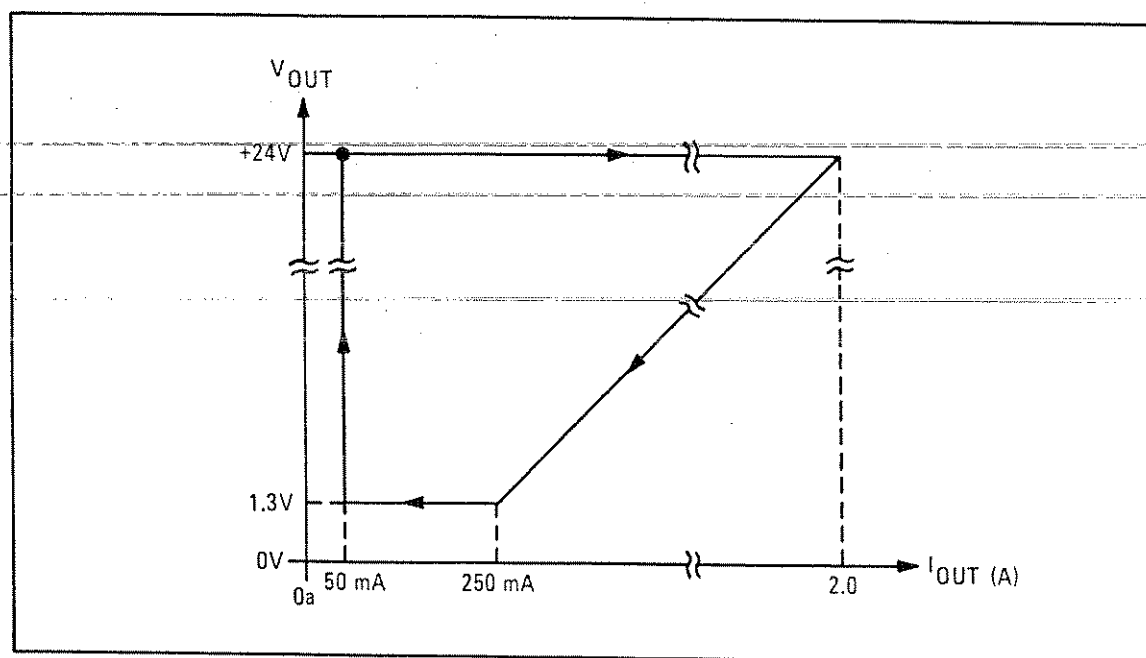

Figure 8-14. Typical Foldback Characteristics of +24 Volt Power Supply

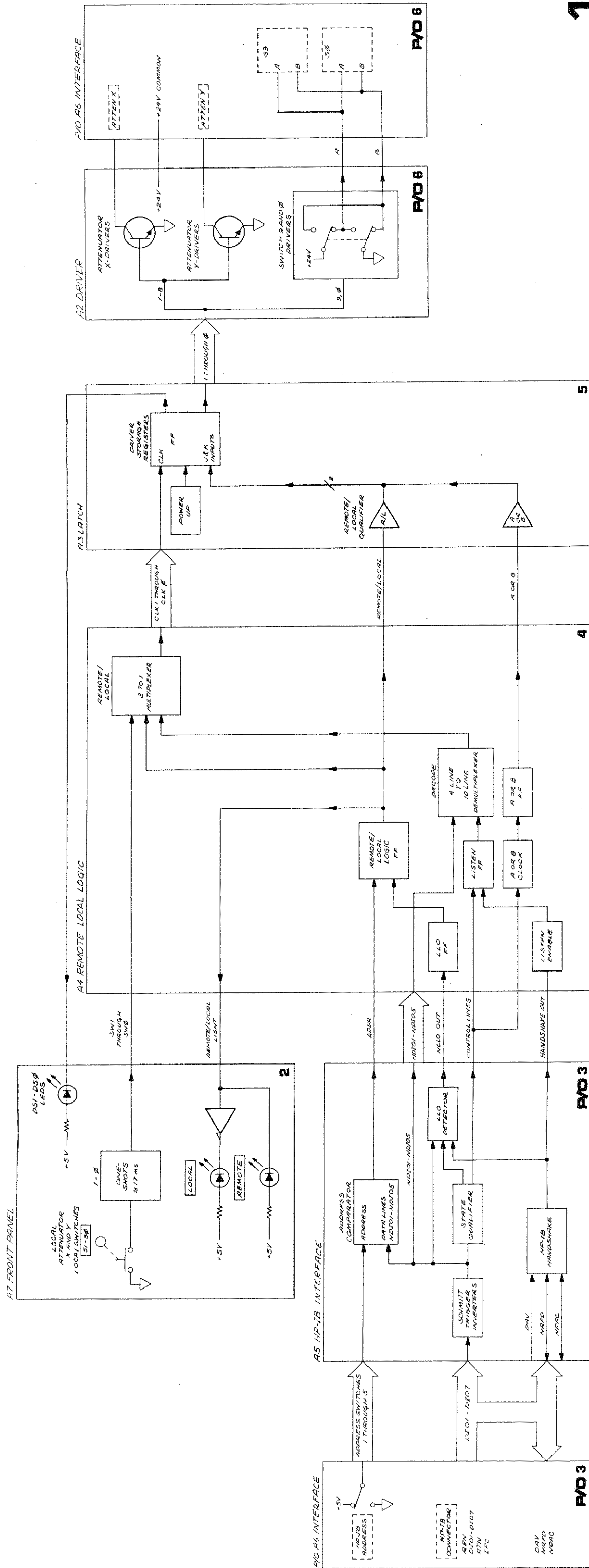

Figure 8-2. Model 11713A Simplified Block Diagram 8-7

P10 A1 SWITCH BOARD ASSEMBLY (11713-60007)

- NOTES**
1. SEE FIGURE 8-1 FOR SCHEMATIC DIAGRAM NOTES.
 2. † BACKLOGGING INFORMATION IN SECTION XII.

REFERENCE DESIGNATIONS

NO PREFIX	A7
W3	C1-25 DSH-13
A1	J1 G1,2 S1-16
J3	S1-16 U1-5

LOGIC LEVELS

TTL	
HIGH	> 2V
LOW	< 0.8V
< IS MORE NEG. THAN	
> IS MORE POS. THAN	
OPEN	HIGH
GROUND	LOW

TRANSISTOR AND INTEGRATED CIRCUIT PART NUMBERS

REFERENCE DESIGNATIONS	PART NUMBERS
G1,2	1854-0071
U1-5	1820-1423

INTEGRATED CIRCUIT VOLTAGE AND GROUND CONNECTIONS

REFERENCE DESIGNATIONS	PIN NUMBERS
U1-5	+5V - 16
	△ - 8

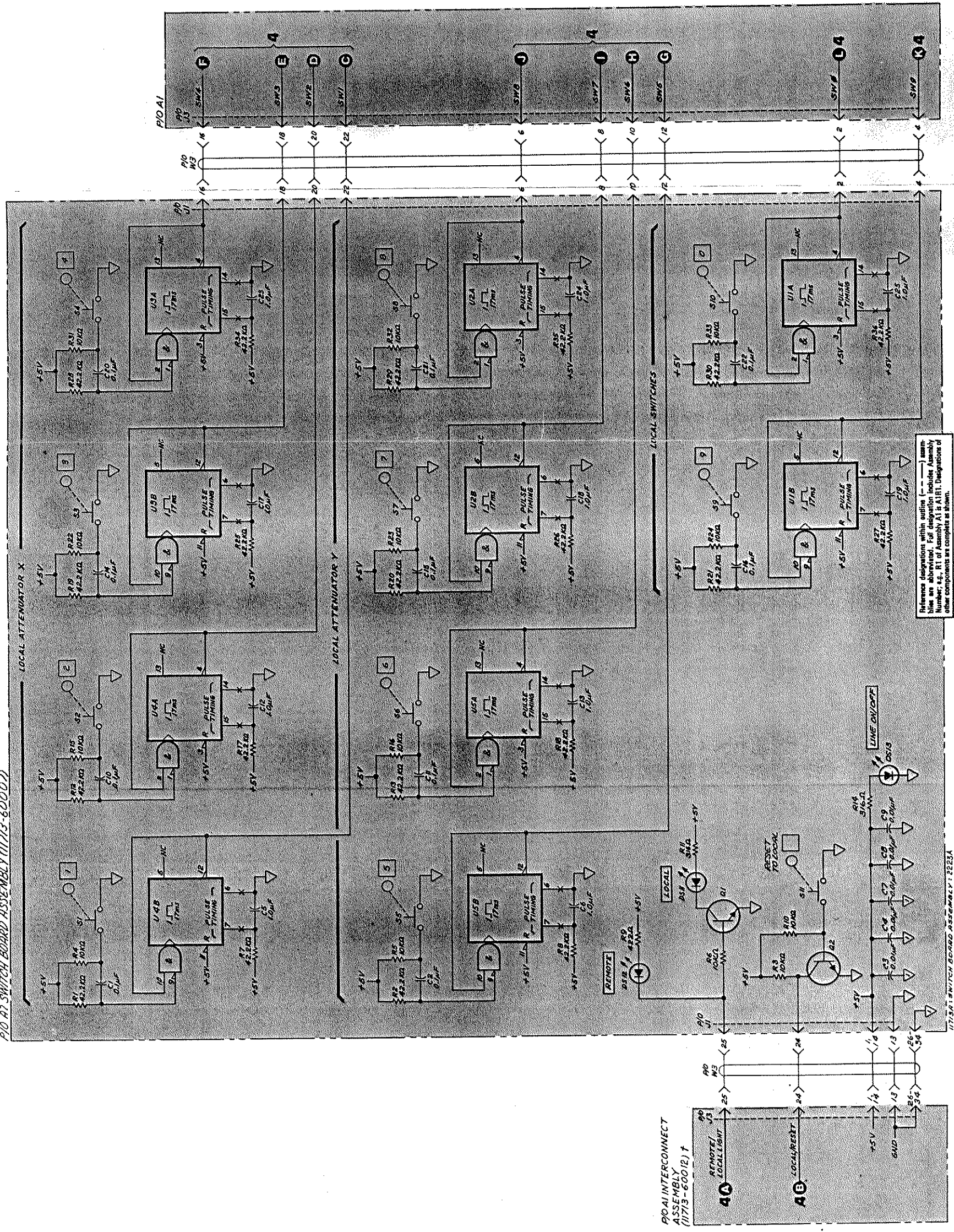
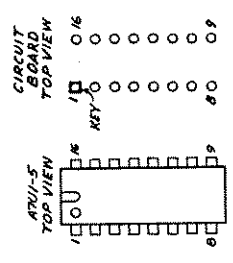

Reference designations within outline (---) same as those in abbreviated. Full designation includes Assembly Number, e.g., R1 of Assembly A1 is A1R1. Designations of other components are complete as shown.

11713-60007 SWITCH BOARD ASSEMBLY (11713-60007)

Figure 8-4. Switch Board Schematic Diagram

NOTES
 1. SEE FIGURE 8-1 FOR SCHEMATIC DIAGRAM NOTES.
 2. FOR BACKDRIVING INFORMATION, SEE SECTION III.

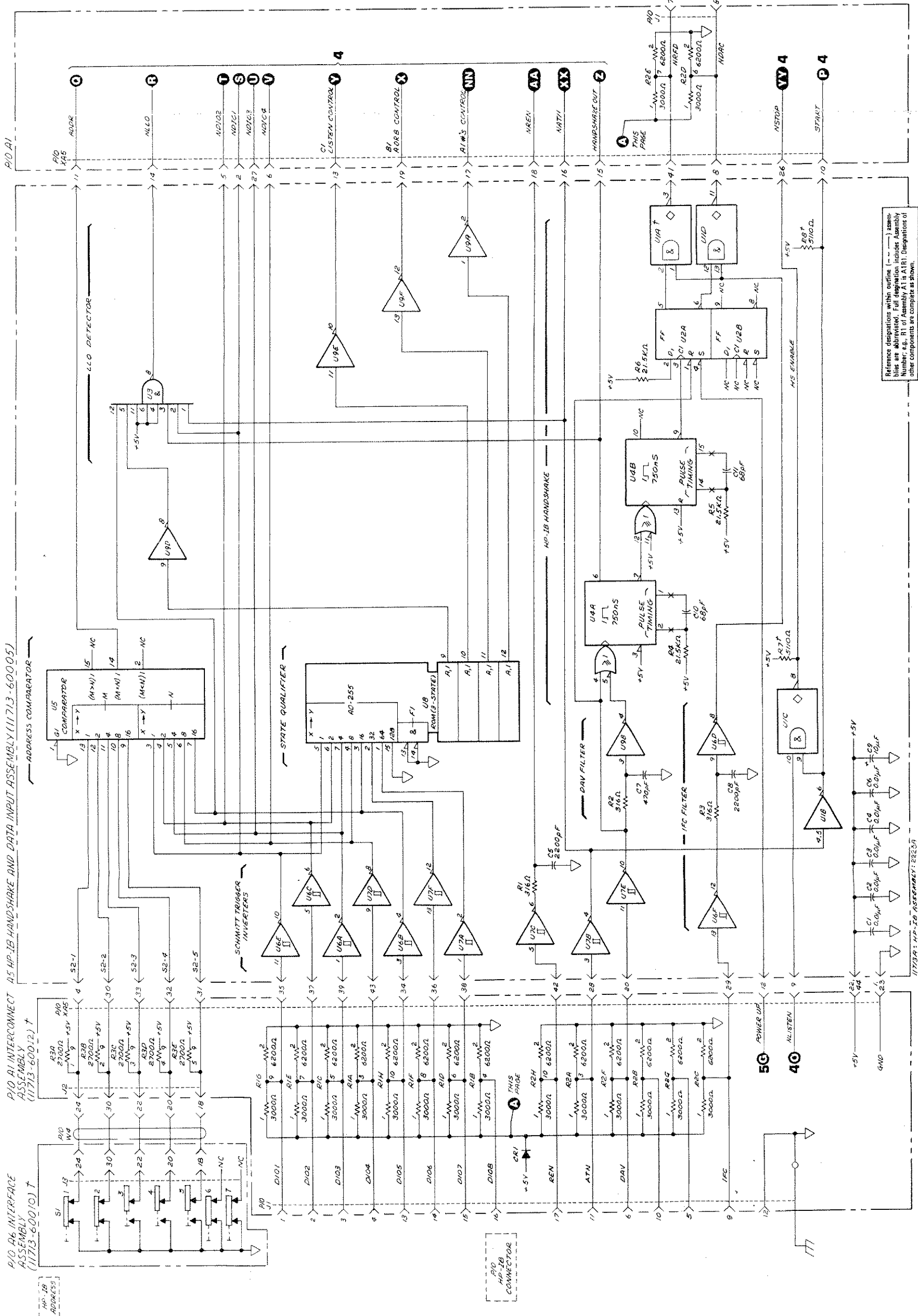

REFERENCE DESIGNATIONS

NO PREFIX	A5
HW	C1-11
AI	R1-B
	U1-9
CI	A6
P1-2	J3
KAS	S1

LOGIC LEVELS

TTL	
HIGH	> 2V
LOW	< 0.8V
< IS MORE NEG. THAN	
> IS MORE POS. THAN	
OPEN	HIGH
GROUND	LOW

TRANSISTORS AND INTEGRATED CIRCUIT PART NUMBERS

REFERENCE DESIGNATIONS	PART NUMBERS
U1	1820 - 081T
U2	1820 - 1112
U3	1820 - 1207
U4	1820 - 0515
U5	1820 - 0904
U6, 7	1820 - 1816
U8	1820 - 0102
U9	1820 - 1199

INTEGRATED CIRCUIT VOLTAGE AND GROUND CONNECTIONS

REFERENCE DESIGNATIONS	PIN CONNECTIONS
U1-3, 4, 7, 9	+5V -1A
U4, 5, 8	+5V -1B

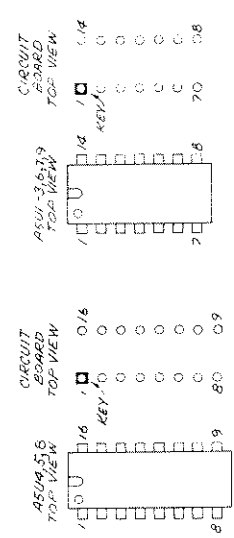
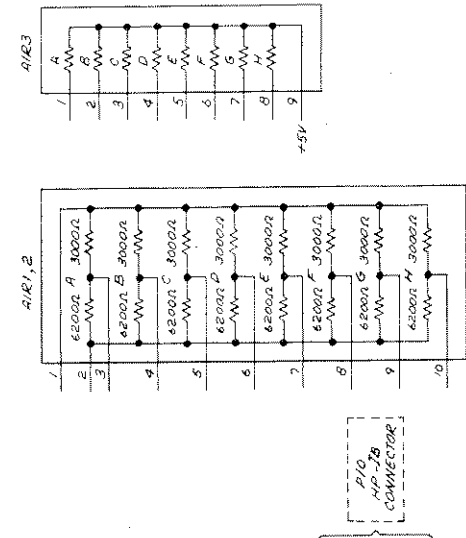

Reference designations within outline (---) assemblies are abbreviated. Full designation includes Assembly Number, e.g., R1 of Assembly A1 is AIR1. Designations of other components are complete as shown.

3
 A5, P10A6

Figure 8-6. HP-IB Handshake and Data Input Schematic Diagram

NOTES
 1. SEE FIGURE 8-1 FOR SCHEMATIC DIAGRAM NOTES.
 2. † BACKPORTING INFORMATION IN SECTION VIII

REFERENCE DESIGNATIONS

A1	A4
XA4	C1-B R1 U1-B

LOGIC LEVELS

TTL	
HIGH	> 2V
LOW	< 0.8V
< IS MORE NEG. THAN > IS MORE POS. THAN	
OPEN	HIGH
GROUND	LOW

TRANSISTOR AND INTEGRATED CIRCUIT PART NUMBERS

REFERENCE DESIGNATIONS	PART NUMBERS
U1, 3, 7	1820-1228
U2, 8	1820-1216
U3	1820-1204
U5	1820-1204
U6, 9	1820-1112
U10	1820-1199
U11	1820-1197

INTEGRATED CIRCUIT VOLTAGE AND GROUND CONNECTIONS

REFERENCE DESIGNATIONS	PIN NUMBERS
U1-3, 7, 8	+5V - 16
	-8
U4-6, 9-11	+5V - 14
	-7

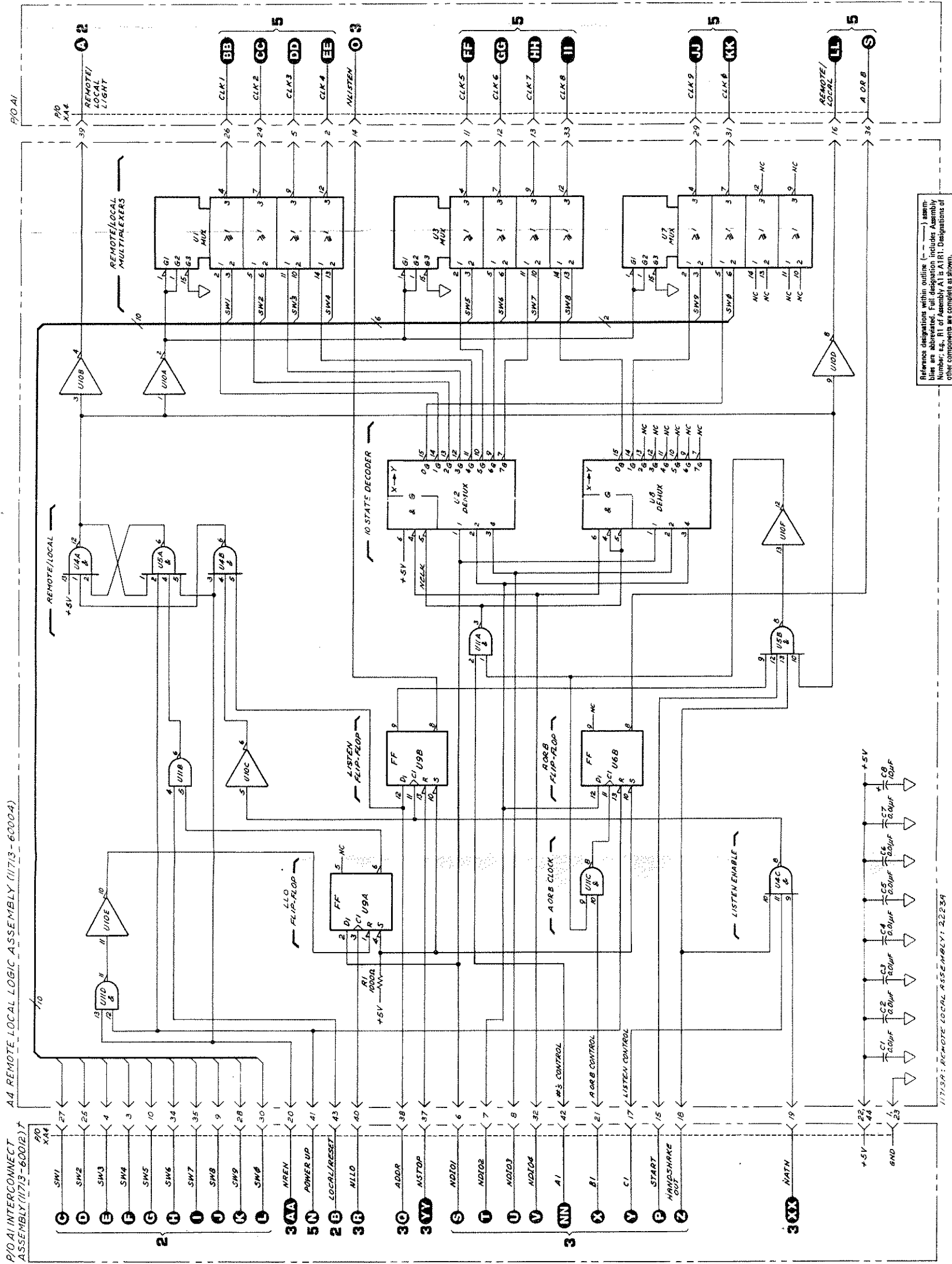
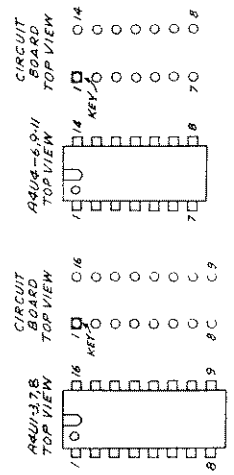

Reference designations within outline (---) assemblies are abbreviated. Full designation includes Assembly Number, e.g., R1 of Assembly A1 is A1R1. Designations of other components are complete as shown.

Figure 8-8. Remote Local Logic Schematic Diagram

NOTES
 1. SEE FIGURE B-7 FOR SCHEMATIC
 DIAGRAM NOTES.
 2. T BACKDATING INFORMATION IN
 SECTION VII

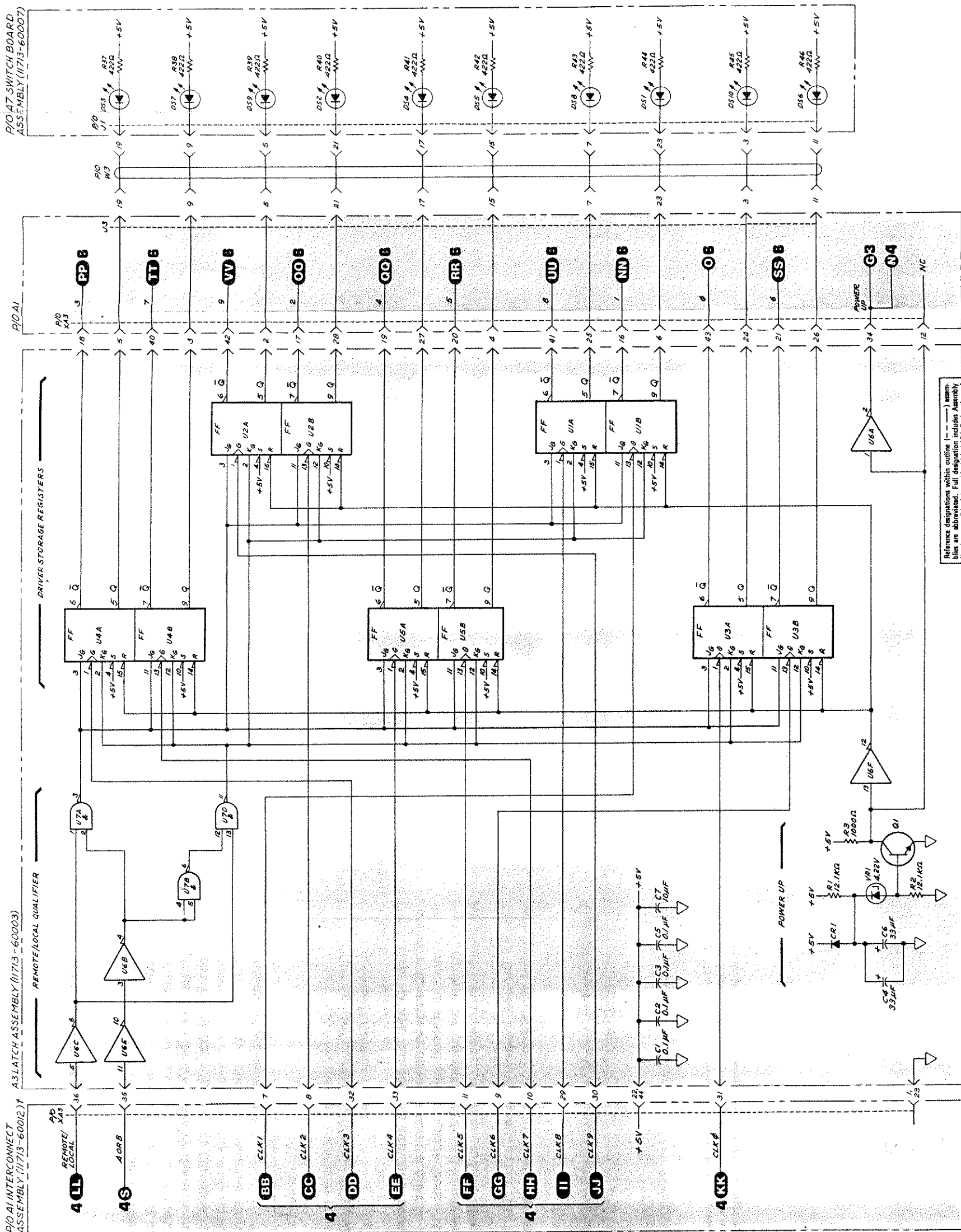

REFERENCE DESIGNATIONS

NO. PREFIX	A3
W3	CR-7
	CR-1
	CR-3
U3	UI-5
U4	UI-7
	UI-10
	UI-12
	UI-14
	UI-16
	UI-18
	UI-20
	UI-22
	UI-24
	UI-26
	UI-28
	UI-30
	UI-32
	UI-34
	UI-36
	UI-38
	UI-40
	UI-42
	UI-44
	UI-46
	UI-48
	UI-50
	UI-52
	UI-54
	UI-56
	UI-58
	UI-60
	UI-62
	UI-64
	UI-66
	UI-68
	UI-70
	UI-72
	UI-74
	UI-76
	UI-78
	UI-80
	UI-82
	UI-84
	UI-86
	UI-88
	UI-90
	UI-92
	UI-94
	UI-96
	UI-98
	UI-100

LOGIC LEVELS

TTL
HIGH > 2V
LOW < 0.8V
< IS MORE NEG. THAN > IS MORE POS. THAN
OPEN HIGH
GROUND LOW

TRANSISTOR AND INTEGRATED CIRCUIT PART NUMBERS

REFERENCE DESIGNATIONS	PART NUMBERS
Q1	1854-0810
U1-5	1820-1212
U6	1820-0663
U7	1820-0661

INTEGRATED CIRCUIT POLYMER GROUND CONNECTIONS

REFERENCE DESIGNATIONS	PIN NUMBERS
U1-5	+5 -16
	-18
U6,7	+5 -14
	-7

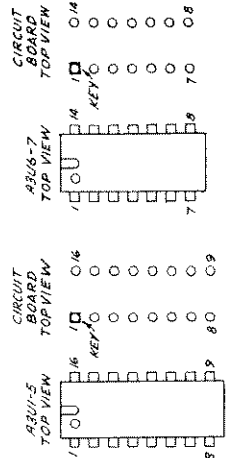

Reference designations within outline (---) assemblies are abbreviated. Full designation includes Assembly Number, e.g., R1 of Assembly A1 is A1R1. Designations of other components are complete as shown.

5
 A3, P/O A7

Figure 8-10. Latch Schematic Diagram
 8-15

SERVICE SHEET 6

PRINCIPLES OF OPERATION

General

The A2 Driver Assembly contains eight pairs of driver transistors and two driver relays. One transistor of each pair, e.g., Q9 and Q18, is in saturation while the other transistor is in cutoff. The saturated transistor sinks current from the +24 Vdc supply through the load connected to the rear panel of the Driver and returns it to ground. The open collector outputs are protected against spikes from inductive loads with clamp diodes to both ground and the +24 Vdc supply. The driver transistors each have a metal tab that is attached to a common heat sink.

CAUTION

When replacing a driver transistor, do not exceed 0.28 N·m¹ (40 ounce force inch) of torque when attaching the metal tab to the heat sink.

The relays K1 and K2 provide reversible polarity for ground and +24 Vdc necessary to drive switches similar to the HP 8761B. The relay contacts are also protected against spikes from inductive loads. The driver board is controlled by inputs from the A3 Latch Assembly which is clocked by either the A7 front panel switches or from the HP-IB via the A4 and A5 assemblies.

The A6 Interface Assembly contains the HP-IB Address Switch and the connectors for the X and Y Attenuators and the wiring for switch outputs 9 and 0.

The following is a list of the eight driver-transistor pairs:

1	Q18/Q9	5	Q14/Q4
2	Q16/Q17	6	Q11/Q3
3	Q8/Q7	7	Q6/Q5
4	Q15/Q10	8	Q13/Q12

¹The unit Newton metre (N·m) as a metric expression of torque, is a compound unit derived when a Newton (unit of force) and a metre (length) are multiplied together. The measure is expressed in kg force metre. It is written N·m or m·N to avoid confusion with millinewtons if it were written mN.

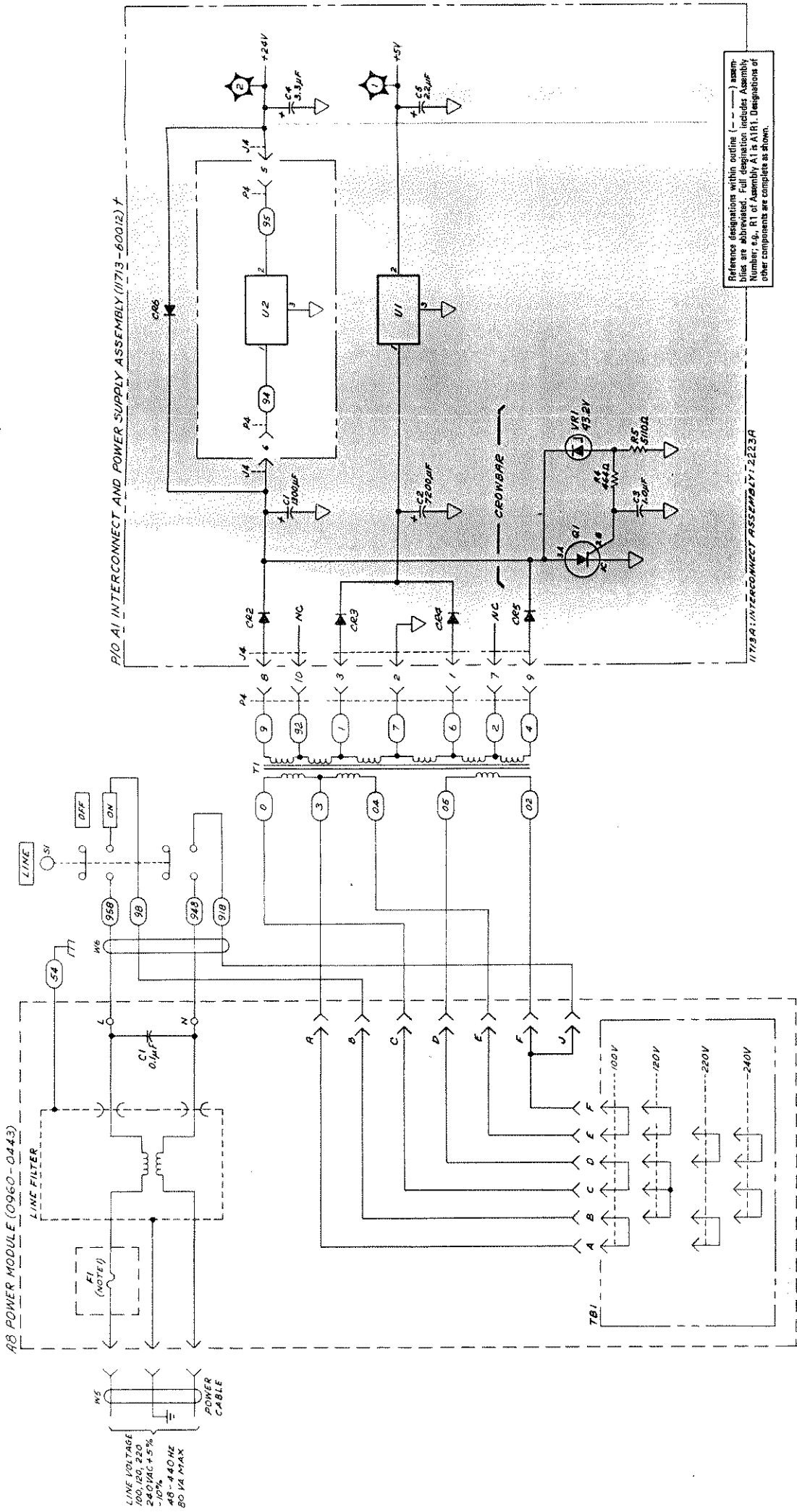

NOTES
 1. PRIMARY POWER FUSE FI IS 1.25A FOR 100VAC TO 170VAC AND 0.750A FOR 220VAC TO 240VAC.
 2. SEE FIGURE 8-1 FOR SCHEMATIC DIAGRAM NOTES.
 3. † BACKLOGGING INFORMATION SECTION VIII.

NO PREFIX	RI CONT
P4	R1,5
S4	T0,12
T1	U1,2
U2	V1
M3,6	AB
A1	C1
C1,2	F1
CR2-6	T1
J4	Q1

LOGIC LEVELS
TTL
HIGH > 2V
LOW < 0.8V
< IS MORE NEG THAN
> IS MORE POS THAN
OPEN HIGH
GROUND LOW

TRANSISTOR AND INTEGRATED CIRCUIT PART NUMBERS	REFERENCE DESIGNATIONS	PART NUMBERS
U1	1926-0181	
U2	1826-0559	

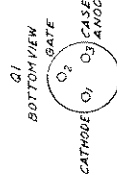
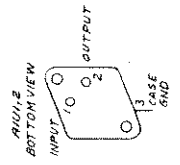

7
P/D A1, AB

Figure 8-16. Interconnect and Power Supply Schematic Diagram
 8-19/8-20

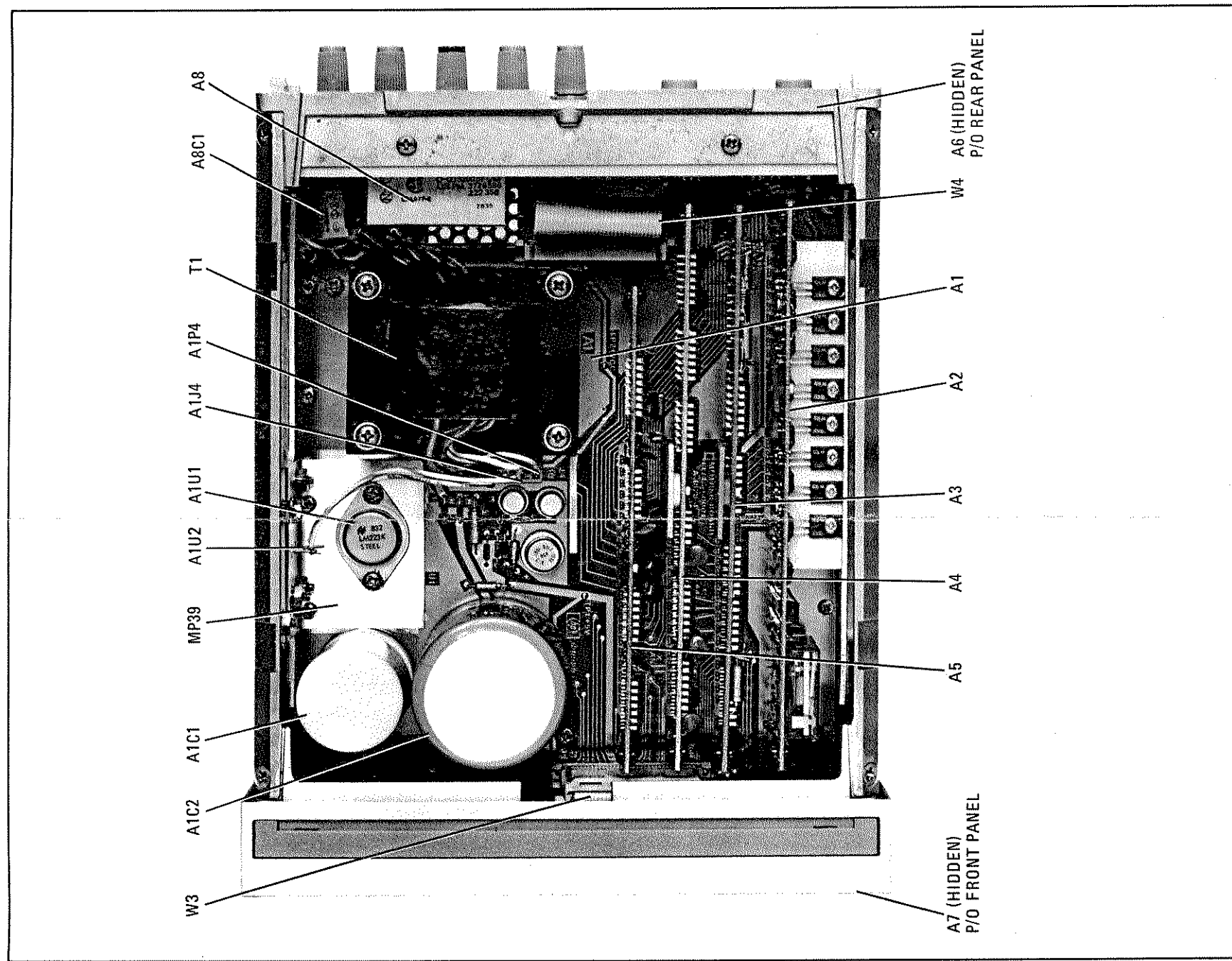
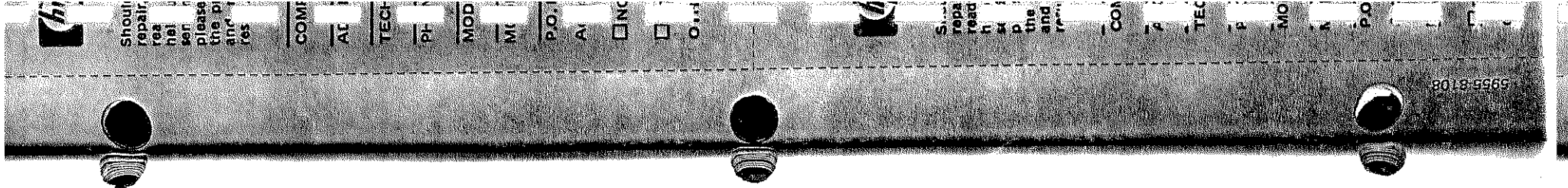

Figure 8-17. Top Internal View Assembly and Component Locations



5955-8108

Top Internal View

Free Manuals Download Website

<http://myh66.com>

<http://usermanuals.us>

<http://www.somanuals.com>

<http://www.4manuals.cc>

<http://www.manual-lib.com>

<http://www.404manual.com>

<http://www.luxmanual.com>

<http://aubethermostatmanual.com>

Golf course search by state

<http://golfingnear.com>

Email search by domain

<http://emailbydomain.com>

Auto manuals search

<http://auto.somanuals.com>

TV manuals search

<http://tv.somanuals.com>