

OPERATING AND SERVICE MANUAL

5363B Time Interval Probes

SERIAL PREFIX: 2510A

This manual applies to Serial Prefix 2510A, unless accompanied by a Manual Change Sheet indicating otherwise.

© Copyright HEWLETT-PACKARD COMPANY 1986
5301 STEVENS CREEK BOULEVARD, SANTA CLARA, CA 95051

MANUAL PART NUMBER 05363-90022
Microfiche Part Number 05363-90023

Printed: JANUARY 1986





WARNING

IF THIS INSTRUMENT IS TO BE ENERGIZED VIA AN AUTOTRANSFORMER (FOR VOLTAGE REDUCTION) MAKE SURE THE COMMON TERMINAL IS CONNECTED TO THE EARTHED POLE OF THE POWER SOURCE.

WARNING

BEFORE SWITCHING ON THE INSTRUMENT, THE PROTECTIVE EARTH TERMINALS OF THE INSTRUMENT MUST BE CONNECTED TO THE PROTECTIVE CONDUCTOR OF THE (MAINS) POWER CORD. THE MAINS PLUG SHALL ONLY BE INSERTED IN A SOCKET OUTLET PROVIDED WITH A PROTECTED EARTH CONTACT. THE PROTECTIVE ACTION MUST NOT BE NEGATED BY THE USE OF AN EXTENSION CORD (POWER CABLE) WITHOUT A PROTECTIVE CONDUCTOR (GROUNDING).

WARNING

THE SERVICE INFORMATION FOUND IN THIS MANUAL IS OFTEN USED WITH POWER SUPPLIED AND PROTECTIVE COVERS REMOVED FROM THE INSTRUMENT. ENERGY AVAILABLE AT MANY POINTS MAY, IF CONTACTED, RESULT IN PERSON INJURY.

CAUTION

BEFORE SWITCHING ON THIS INSTRUMENT:

1. MAKE SURE THE INSTRUMENT IS SET TO THE VOLTAGE OF THE POWER SOURCE.
2. ENSURE THAT ALL DEVICES CONNECTED TO THIS INSTRUMENT ARE CONNECTED TO THE PROTECTIVE (EARTH) GROUND.
3. ENSURE THAT THE LINE POWER (MAINS) PLUG IS CONNECTED TO A THREE-CONDUCTOR LINE POWER OUTLET THAT HAS A PROTECTIVE (EARTH) GROUND. (GROUNDING ONE CONDUCTOR OF A TWO-CONDUCTOR OUTLET IS NOT SUFFICIENT.)
4. MAKE SURE THAT ONLY FUSES WITH THE REQUIRED RATED CURRENT AND OF THE SPECIFIED TYPE (NORMAL BLOW, TIME DELAY, ETC.) ARE USED FOR REPLACEMENT. THE USE OF REPAIRED FUSES AND THE SHORT-CIRCUITING OF FUSE HOLDERS MUST BE AVOIDED.
5. AVOID STATIC DISCHARGE TO THE PROBE TIPS. DAMAGE TO THE PROBES MAY RESULT. FOLLOW CAUTIONS IN FIGURE 1-2.

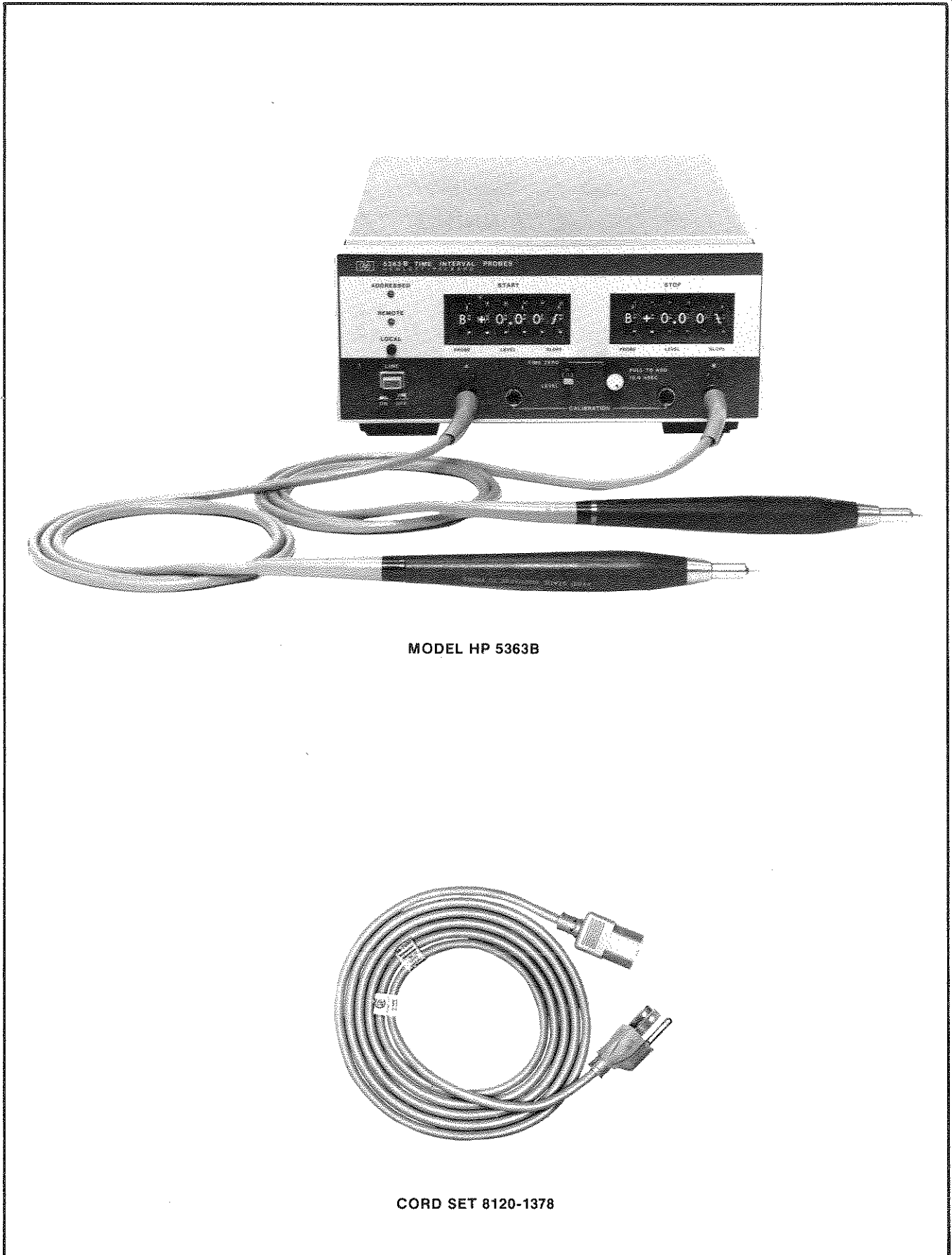

MODEL HP 5363B

CORD SET 8120-1378

Figure 1-1. Model HP 5363B and Equipment Supplied

SECTION I GENERAL INFORMATION

1-1. INTRODUCTION

1-2. This operating and service manual contains information needed to operate, test, and service the Hewlett-Packard Model 5363B Time Interval Probes. *Figure 1-1* shows the instrument identification, description, and accessories.

1-3. SPECIFICATIONS

1-4. Overall specifications for the HP 5363B are given in *Table 1-1*.

1-5. SAFETY CONSIDERATIONS

1-6. The 5363B Time Interval Probes is a Safety Class I instrument. This instrument has been designed according to international safety standards.

1-7. This operating and service manual contains information, cautions, and warnings which must be followed by the user to ensure safe operation and keep the instrument in safe condition.

1-8. INSTRUMENTS COVERED BY MANUAL

1-9. Attached to the instrument is a serial number plate. The serial number is in the form: 0000A00000. It is in two parts; the first four digits and the letter are the serial prefix and the last five digits are the suffix. The prefix is the same for all identical instruments; it changes only when a change is made to the instrument. The suffix however, is assigned sequentially and is different for each instrument. The contents of this manual apply to instruments with the serial number prefix(es) listed under SERIAL PREFIX on the title page.

1-10. An instrument manufactured after the printing of this manual may have a serial number prefix that is not listed on the title page. This unlisted serial number prefix indicates the instrument is different from those described in this manual. The manual for this newer instrument is accompanied by a yellow Manual Changes supplement. This supplement contains "change information" that explains how to adapt the manual to the newer instrument.

1-11. In addition to change information, the supplement may contain information for correcting errors in the manual. To keep this manual as current and accurate as possible, Hewlett-Packard recommends that you periodically request the latest Manual Changes supplement. The supplement for this manual is identified with the manual print date and part number, both of which appear on the manual title page. Complementary copies of the supplement are available from Hewlett-Packard.

1-12. For information concerning a serial number prefix that is not listed on the title page or in the Manual Changes supplement, contact your nearest Hewlett-Packard office.

Table 1-1. Model 5363B Specifications

INPUT REQUIREMENTS:
 Operating Range: $\pm 10V$
 Damage Level: $\pm 30V$
 Minimum Input Voltage: 100 mV above and below the trigger point.
 Minimum Pulse Width: Input signal must remain 100 mV below and above trigger point for at least 5 ns.

ABSOLUTE ACCURACY:

$$\pm 1 \text{ ns}^* \pm \frac{\text{START TLA} + \text{START NTE}}{\text{START slew rate}} \pm \frac{\text{STOP TLA} + \text{STOP NTE}}{\text{STOP slew rate}}$$
 where TLA denotes trigger level accuracy and NTE denotes noise trigger error, defined below.

TRIGGER LEVEL ACCURACY:

Trigger Level	-5V to +9V	-5V to -10V	+9V to -10V
1 Trigger Level Accuracy	$\pm 8 \text{ mV} \pm 0.4 \text{ mV}/^\circ\text{C}$ $\pm 0.15\%$ trigger voltage	$\pm 1\%$ trigger voltage	50 mV
1 Differential Trigger Level Accuracy	$\pm 3 \text{ mV} \pm 0.3\%$ trigger voltage	$\pm 1\%$ trigger voltage	100 mV

Differential trigger level accuracy applies when both START and STOP trigger level voltages are set equal and identical waveforms applied.

1 After calibration and within the range of 100 mV or 8% of signal peak whichever is greater.

NOISE TRIGGER ERROR: $\sqrt{e_i^2 + e_n^2}$ volts
 where e_n = effective rms noise of the 5363B input typically 125 μV
 e_i = rms input signal noise for a 350 MHz bandwidth

ENVIRONMENTAL: Operating temperature 0°C to 55°C.

SUPPLEMENTARY PERFORMANCE CHARACTERISTICS:
 (Describing nonwarranted typical performance parameters.)
 Effective Bandwidth: 350 MHz or 1 ns rise time.
 Impedance: 1M ohms shunted by <20 pF.
 Voltage Resolution: 10 mV.
 Delay Compensation Range: 2 ns adjustable about 0.0 or 10.0 ns.
 Outputs to Counter: Separate START and STOP outputs; -0.5V to +0.5V into 50 ohms, slew rate through zero volts exceeds 0.50V/ns.
 Trigger Level Outputs: Trigger point setting $\pm 75 \text{ mV}$.

GENERAL
 Power: 100, 120, 220, 240V ac (+5%, -10%), 48-440 Hz; 40 VA max.
 Weight: Net 3.0 kg (6.5 lbs). Shipping: 5.5 kg (12 lbs).
 Dimensions: 88.1 mm H \times 212 mm W \times 295 mm D (3.5" \times 8.4" \times 11.6")
 Probe length 122 cm (4 feet)

*Systematic error that can be eliminated with proper calibration and measurement techniques.

1-13. DESCRIPTION

1-14. The 5363B provides two high impedance, low capacitance time domain probes for the digital measurement of rise times and propagation delays with accuracies calibrated to <1 ns. These probes, used directly with an electronic counter's start and stop channels, provide a digital measurement.

1-15. Each probe contains two high-input impedance to low-output impedance converters. This allows the signal to be measured without loading it down. Because each probe contains two converters, each probe contains a potential start and stop channel. Therefore one probe can provide both a start and stop signal to a counter, or one probe can provide a start signal and the other can provide a stop signal for a rise time or time delay measurement, respectively.

1-16. The probes have an input impedance of 1 Meg ohm and an input capacitance of <15 pF. For use with either Hewlett-Packard or Tektronix® RF hardware, the tip of the probe unscrews to allow the tip to be changed to mate with the specific manufacturer's equipment, see *Figure 1-2*.

®Registered Trademark

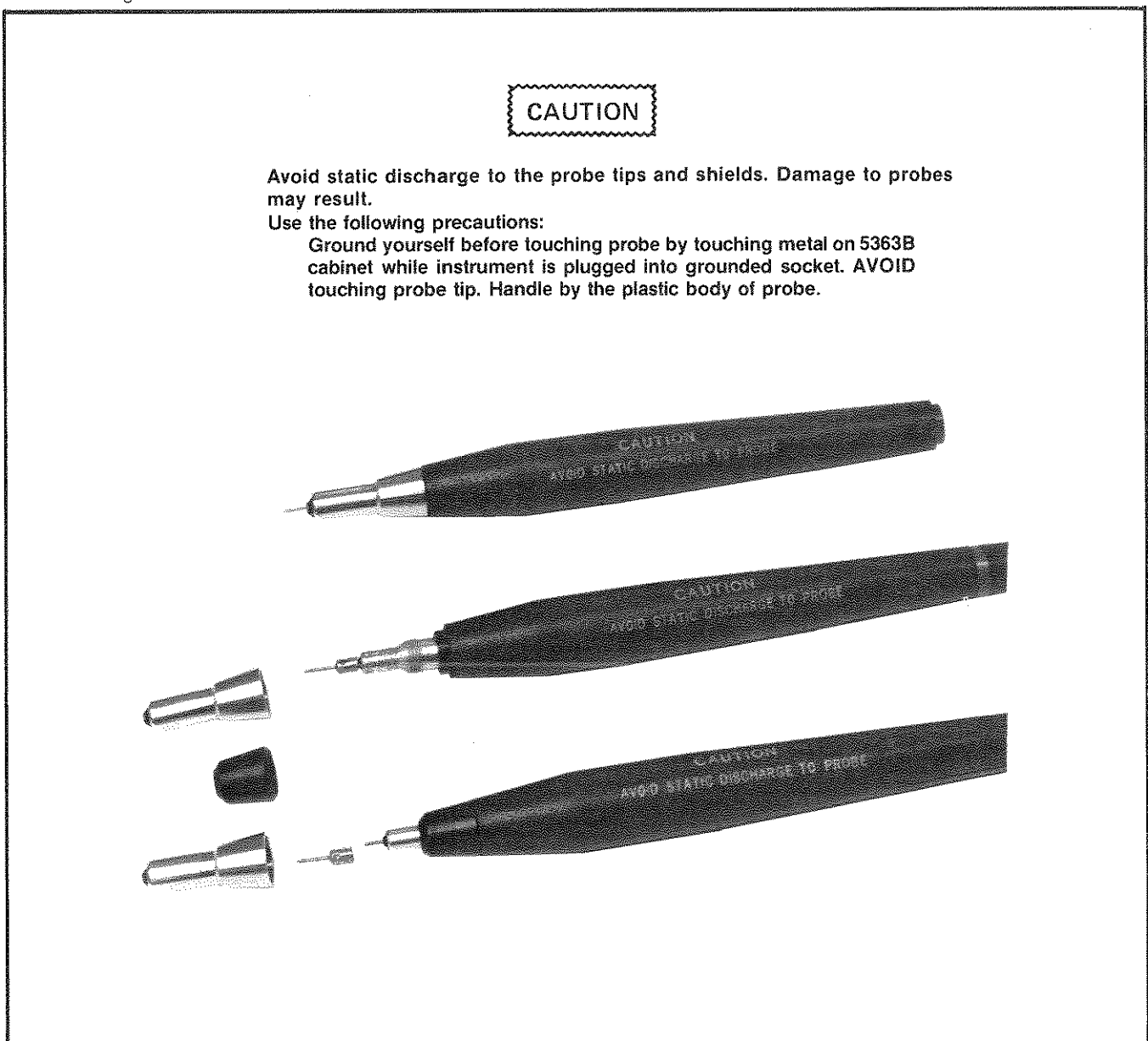

Figure 1-2. Changeable Probe Tips and Probe Cautions

1-17. APPLICATION

1-18. The HP 5363B is designed for use directly with an electronic counter's start and stop channels, in time interval mode to measure the time intervals. The instrument contains four channels, two in each probe, capable of rise time or time delay measurements. Trigger levels may be set in 10 mV steps from -9.99V to +9.99V. The probes can be set to trigger from either positive or negative edges. Outputs are available, on the rear panel, for the start and stop channels in a 50 ohm system. All functions and levels, except delay adjust are programmable via the HP-IB. Provisions for calibration are available on the front panel.

1-19. EQUIPMENT SUPPLIED AND ACCESSORIES AVAILABLE

1-20. *Table 1-2* lists the equipment supplied with the 5363B and *Table 1-3* lists accessories available. An accessory kit for the HP 5363B is available (see *Figure 1-3*) and may be obtained from Hewlett-Packard by ordering Accessory Kit Part No. 10821A.

Table 1-2. Equipment Supplied

DESCRIPTION	HP PART NUMBER
Detachable Power Cord 7 1/2-feet (229 cm) long	8120-1378
Tilt Stand	1460-1345
Ground Clip (2 required)	01123-61302
Ring Tip Adapter (2 required)	05363-20201
Probe Tip Shield (2 required)	05363-20204

1-21. EQUIPMENT REQUIRED BUT NOT SUPPLIED

1-22. The 5363B is designed for use with an electronic counter with time interval mode. Operation is described in Section III for use with HP 5335A, HP 5370A, or HP 5345A.

Table 1-3. Accessories Available

DESCRIPTION	HP PART NUMBER
BNC Tee to Probe Adapter	1250-0655
BNC to Probe Adapter	10218A
Hook Tip	10229A
50 Ohm Feedthrough Termination	10100C
HP-IB Cable	10631A
HP Probe Tip	8710-0661
Accessory Kit for 5363B	10821A

1-23. RECOMMENDED TEST EQUIPMENT

1-24. *Table 1-4* lists test equipment recommended for maintaining and checking the performance of the 5363B. Test equipment having equivalent characteristics may be substituted for the equipment listed. One of each unit is required unless otherwise noted.

Table 1-4. Recommended Test Equipment

INSTRUMENT	REQUIRED CHARACTERISTICS	RECOMMENDED
Precision Power Supply	0-50V \pm 3.5 mV	HP 6115A
Pulse Generator	Transition Time $>500V/\mu s$ Maximum Output 10V across 50 ohms	HP 8013A/B
Counter	Time Interval ≥ 10 ns	HP 5370A
Oscilloscope	50 MHz	HP 180A/1805A
Feedthrough Termination (2)	50 Ohms	HP 10100C
Digital Voltmeter	0 to 100V 0.01% accuracy	HP 3490A
Signature Analyzer		HP 5004A/5005A
Logic State Analyzer		HP 1600A
Logic Pulser		HP 10526T



Figure 1-3. Accessory Kit



SECTION II INSTALLATION

2-1. INTRODUCTION

2-2. This section provides information for unpacking, inspection, preparation for use, storage, and shipment of the 5363B.

2-3. UNPACKING AND INSPECTION

2-4. If the shipping carton is damaged, inspect the 5363B for visible damage (scratches, dents, etc.). If the instrument is damaged, notify the carrier and the nearest Hewlett-Packard Sales and Support Office immediately (offices are listed at the back of this manual). Keep the shipping carton and packing material for the carrier's inspection. The HP Sales and Support Office will arrange for repair or replacement of your instrument without waiting for the claim against the carrier to be settled.

CAUTION

The probes can be damaged by an electrostatic discharge through the probe tip. Keep the probe tip shield attached over the probe tips when they are not in use.

2-5. PREPARATION FOR USE

CAUTION

Before connecting this instrument to an ac power line, be sure that the line voltage selector switch on the rear panel is set to proper position as shown in *Figure 3-2*.

2-6. Power Requirements and Line Voltage

2-7. This instrument operates on single phase 100V, 120V, 220V, or 240V ac +5% -10% volts at 48-440 Hz. Maximum power requirement is 30 VA. *Figure 3-2* shows the line selectors and fuse holder. To avoid instrument damage, the line selectors must be set to the correct positions and the correct fuse (as labeled on the rear panel) must be installed. When shipped, the selectors are set for 120-volt operation.

2-8. Power Cables

WARNING

TO PROTECT OPERATING AND SERVICING PERSONNEL, THIS INSTRUMENT IS EQUIPPED WITH A THREE-PIN POWER RECEPTACLE. THE CENTER PIN OF THE RECEPTACLE CONNECTS THE INSTRUMENT CHASSIS AND PANELS TO EARTH GROUND WHEN USED WITH A PROPERLY WIRED THREE-CONDUCTOR OUTLET AND POWER CABLE. IMPROPERLY GROUNDED EQUIPMENT CAN RESULT IN HAZARDOUS POTENTIALS BETWEEN EQUIPMENT.

2-9. To accommodate the different power receptacles used throughout the world, this HP instrument is supplied with one of the power cables shown in *Figure 2-1*. The cable supplied for use in the United States meets the specifications established by the International Electrotechnical Commission (IEC). The male connector of this cable is a NEMA type and the female connector is C.E.E. type.

2-10. Connect the power cable to a power source that has a grounded third conductor. If the line power receptacle is a two-pin type instead of a three-pin receptacle, use a two- to three-pin type adaptor (HP Part No. 1251-0048 for USA applications) and connect the green lead on the adaptor to earth ground. See warning (Paragraph 2-8).

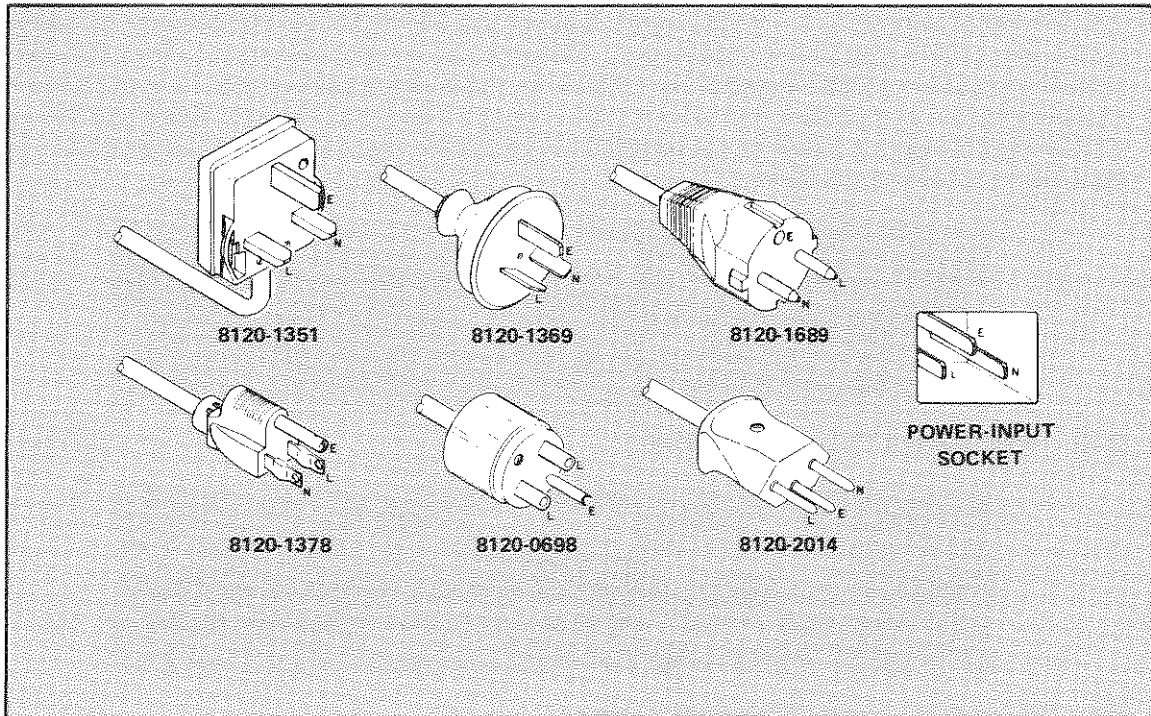

Figure 2-1. Power Cable HP Part Numbers versus Mains Plugs Available

2-11. Operating Environment

2-12. Maximum and minimum allowable operating temperatures are listed in *Table 1-1*. If these limits are exceeded at the installation site, auxiliary heating or cooling should be used to keep the environment within limits.

2-13. Operational Check

2-14. Refer to paragraph 3-10, Calibration Procedures.

2-15. Bench Operation

2-16. The instrument has plastic feet and a fold-away tilt stand for convenience in bench operation. The tilt stand permits inclining the instrument for ease in using front-panel controls and indicators. The plastic feet are shaped to provide clearance for air circulation and to make modular cabinet width instruments self-aligning when stacked.

2-17. PACKAGING FOR RESHIPMENT

2-18. Original Packaging

2-19. The same containers and materials used in factory packaging can be obtained through the Hewlett-Packard Sales and Support Offices listed at the rear of this manual.

2-20. If the instrument is being returned to Hewlett-Packard for service, attach a tag indicating the type of service required, your return address, HP model number and full serial number. Mark the container FRAGILE to assure careful handling.

2-21. In any correspondence refer to the instrument by HP model number and full serial number.

2-22. Other Packaging Methods

2-23. If it becomes necessary to reship an instrument, good commercial packing should be used. Contract packaging companies in many cities can provide dependable custom packaging on short notice. The following general instructions should be followed when repackaging with commercially available materials.

- a. If shipping to a Hewlett-Packard Service Office or Center, attach a tag indicating the type of service required, your return address, HP model number, and full serial number.
- b. Wrap the instrument in heavy paper or plastic.
- c. Use a strong shipping container. A double-wall carton made of 350 pound test material is adequate.
- d. Use enough shock-absorbing material (3- to 4-inch layer) around all sides of the instrument to provide a firm cushion and prevent movement inside the container. Protect the control panel with cardboard.
- e. Seal the shipping container securely.
- f. Mark the shipping container FRAGILE to assure careful handling.

2-24. STORAGE

2-25. If the instrument is to be stored for an extended period of time, it should be enclosed in a clear, sealed container.

2-17. PACKAGING FOR RESHIPMENT

2-18. Original Packaging

2-19. The same containers and materials used in factory packaging can be obtained through the Hewlett-Packard Sales and Support Offices listed at the rear of this manual.

2-20. If the instrument is being returned to Hewlett-Packard for service, attach a tag indicating the type of service required, your return address, HP model number and full serial number. Mark the container FRAGILE to assure careful handling.

2-21. In any correspondence refer to the instrument by HP model number and full serial number.

2-22. Other Packaging Methods

2-23. If it becomes necessary to reship an instrument, good commercial packing should be used. Contract packaging companies in many cities can provide dependable custom packaging on short notice. The following general instructions should be followed when repackaging with commercially available materials.

- a. If shipping to a Hewlett-Packard Service Office or Center, attach a tag indicating the type of service required, your return address, HP model number, and full serial number.
- b. Wrap the instrument in heavy paper or plastic.
- c. Use a strong shipping container. A double-wall carton made of 350 pound test material is adequate.
- d. Use enough shock-absorbing material (3- to 4-inch layer) around all sides of the instrument to provide a firm cushion and prevent movement inside the container. Protect the control panel with cardboard.
- e. Seal the shipping container securely.
- f. Mark the shipping container FRAGILE to assure careful handling.

2-24. STORAGE

2-25. If the instrument is to be stored for an extended period of time, it should be enclosed in a clear, sealed container.



SECTION III OPERATION

3-1. INTRODUCTION

3-2. This operating section explains the functions of the controls and indicators of the 5363B. It describes typical operating modes in a measurement system, self-calibration procedures and programming information for remote operation via the HP-IB.

3-3. CONTROLS, INDICATORS, AND CONNECTORS

3-4. *Figure 3-1* describes and illustrates the front panel controls, indicators, and connectors. *Figure 3-2* delineates the rear panel controls and connectors.

3-5. TYPES OF OPERATION

3-6. The 5363B may be operated under local (front panel) control or under remote (controller) programming control. All front panel functions can be programmed via the HP-IB, except the setting of the TIME ZERO delay adjustment control.

3-7. OPERATION UNDER LOCAL CONTROL

3-8. The following paragraphs describe preliminary set-up procedures for operation under local control.

3-9. Perform the following procedures (refer to *Figure 3-1* for a description of front panel controls and *Figure 3-2* for a description of rear panel controls):

- a. Press LINE PUSH ON/OFF pushbutton. When pushbutton is in, power is ON. Power ON status is also indicated by the probes selection indicators.
- b. Press LOCAL pushbutton. This will return the 5363B to manual control of the front panel.

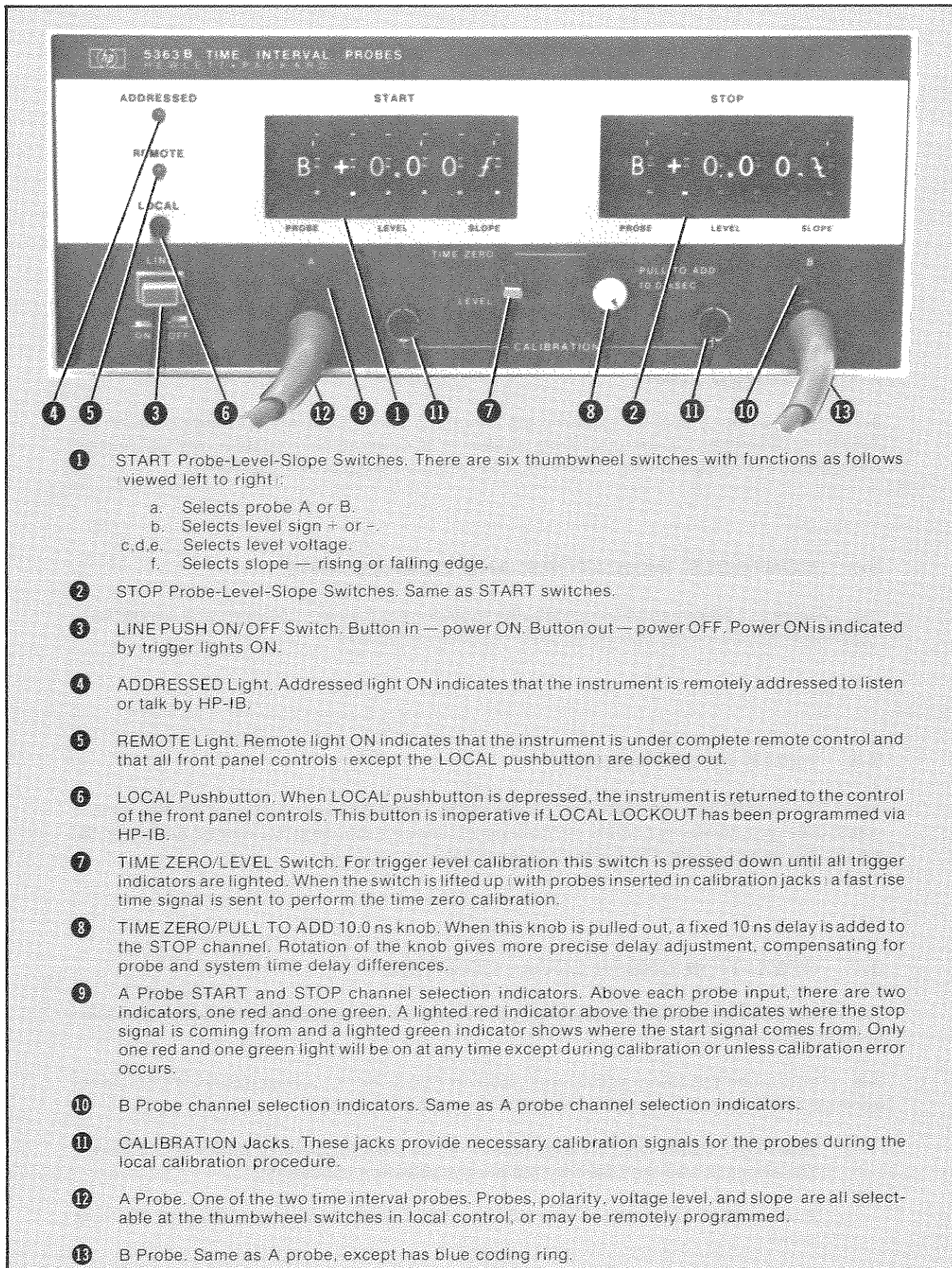

- ① START Probe-Level-Slope Switches. There are six thumbwheel switches with functions as follows viewed left to right:
 - a. Selects probe A or B.
 - b. Selects level sign + or -.
 - c, d, e. Selects level voltage.
 - f. Selects slope — rising or falling edge.
- ② STOP Probe-Level-Slope Switches. Same as START switches.
- ③ LINE PUSH ON/OFF Switch. Button in — power ON. Button out — power OFF. Power ON is indicated by trigger lights ON.
- ④ ADDRESSSED Light. Addressed light ON indicates that the instrument is remotely addressed to listen or talk by HP-IB.
- ⑤ REMOTE Light. Remote light ON indicates that the instrument is under complete remote control and that all front panel controls (except the LOCAL pushbutton) are locked out.
- ⑥ LOCAL Pushbutton. When LOCAL pushbutton is depressed, the instrument is returned to the control of the front panel controls. This button is inoperative if LOCAL LOCKOUT has been programmed via HP-IB.
- ⑦ TIME ZERO/LEVEL Switch. For trigger level calibration this switch is pressed down until all trigger indicators are lighted. When the switch is lifted up (with probes inserted in calibration jacks) a fast rise time signal is sent to perform the time zero calibration.
- ⑧ TIME ZERO/PULL TO ADD 10.0 ns knob. When this knob is pulled out, a fixed 10 ns delay is added to the STOP channel. Rotation of the knob gives more precise delay adjustment, compensating for probe and system time delay differences.
- ⑨ A Probe START and STOP channel selection indicators. Above each probe input, there are two indicators, one red and one green. A lighted red indicator above the probe indicates where the stop signal is coming from and a lighted green indicator shows where the start signal comes from. Only one red and one green light will be on at any time except during calibration or unless calibration error occurs.
- ⑩ B Probe channel selection indicators. Same as A probe channel selection indicators.
- ⑪ CALIBRATION Jacks. These jacks provide necessary calibration signals for the probes during the local calibration procedure.
- ⑫ A Probe. One of the two time interval probes. Probes, polarity, voltage level, and slope are all selectable at the thumbwheel switches in local control, or may be remotely programmed.
- ⑬ B Probe. Same as A probe, except has blue coding ring.

Figure 3-1. Front Panel Connectors, Controls, and Indicators

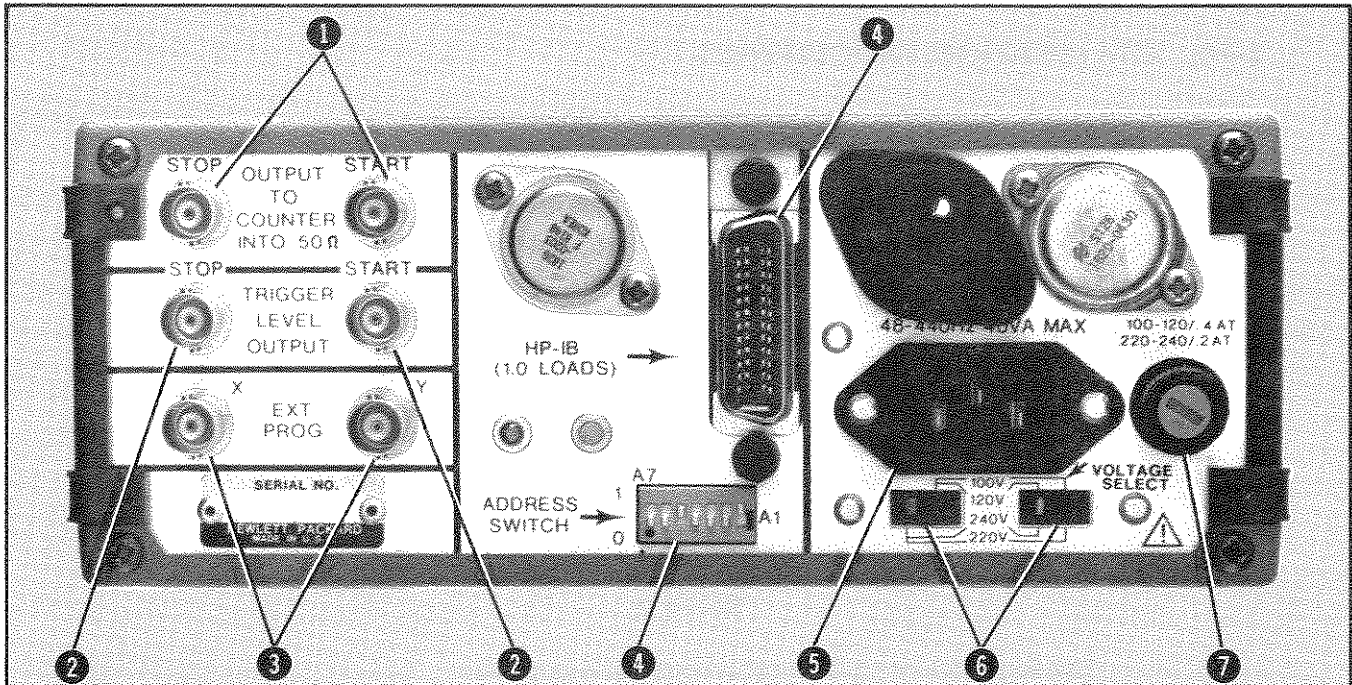

- 1 START & STOP OUTPUT TO COUNTER. These outputs drive, in a 50 ohms environment, the inputs to the counter required to measure the time intervals. These outputs range nominally from -0.5 volts to +0.5 volts so that the preset level of the counter can be used. The slew rate through zero is greater than 0.25V/ns.
- 2 START & STOP TRIGGER LEVEL OUTPUT. Both START and STOP output levels are available. These output levels may be offset from the actual trigger points by up to ±75 mV. These output levels will drive 10 K ohms loads and will be unstable during calibration.
- 3 X-Y EXT PROG. These input connectors are for remote programming by other HP products and respond according to the following table:

INPUT X Y	PROBE	START ACCORDING TO SWITCH		USE	PROBE	STOP ACCORDING TO SWITCH	
		SLOPE	LEVEL			SLOPE	LEVEL
High Low	A	L	L	Delay Width	B	R	R
Low Low	B	R	R		B	R	R
Low Low	B	R	R	Correction Factor	B	R	R
High High	As set by Front Panel or Remote						

L = Left - START - Thumbwheel Switch
R = Right - STOP - Thumbwheel Switch

- 4 HP-IB connector/ADDRESS SWITCH. Remote programming is accomplished via the HP-IB through this connector. The Listen address is set by selecting the ASCII address on five of the rocker switches (A1 through A5) within the ADDRESS SWITCH. More complete description and instructions are provided starting in Paragraph 3-24.
- 5 Input AC Power Connector. Line voltages of 100V, 120V, 220V, and 240V at frequencies from 48 to 440 Hz may be used; 30 VA max.
- 6 VOLTAGE SELECT Switches. Two slide switches permit line voltage settings to accommodate 100V, 120V, 220V, or 240V inputs.
- 7 FUSE. A 0.4A SLO-BLO fuse is required for 100V or 120V inputs; a 0.20A SLO-BLO fuse is required for 220V or 240V.

Figure 3-2. Rear Panel Controls and Connectors

3-10. CALIBRATION PROCEDURES

NOTE

HP Model 5363B ac ground must be at the same potential as instrument under test. Inaccuracies in trigger level calibration and test measurements will occur if this precaution is not observed.

3-11. Trigger Level Calibration

NOTE 1

Trigger level calibration is necessary when a trigger level error of less than 150 mV is required. IT SHOULD BE PERFORMED WHEN THE SLOPES OR PROBES ARE CHANGED.

NOTE 2

The sequence of calibration procedure is important.

- a. Select desired probe and slope configuration.
- b. Insert probe or probes to be calibrated into CALIBRATION jacks or connect to ground through ≤ 50 ohms.
- c. Press TIME ZERO/LEVEL switch down until all red and green trigger indicators are lighted.
- d. Release TIME ZERO/LEVEL switch.
- e. Check that probe channel selection indicators of selected probes are lighted. (This is the indication that the Trigger Level Calibration is completed.)

NOTE

If all four probe select indicators are flashing, the calibration has NOT been accomplished.

3-12. Sources of calibration errors are:

- a. Probes not inserted in CALIBRATION jacks (or otherwise grounded).
- b. TIME ZERO/LEVEL switch not depressed long enough.
- c. Circuit malfunction.

Items a and b can be corrected and, when the TIME ZERO/LEVEL switch is pressed again, a proper calibration will occur. For item c, refer to Section VIII.

3-13. Time Zero Calibration Procedure

- a. Connect the 5363B START/STOP outputs to the 5370A START and STOP channels. Refer to *Figure 3-3*.

NOTE

The two cables used to connect the 5363B START/STOP outputs to the 5370A must be of equal length.

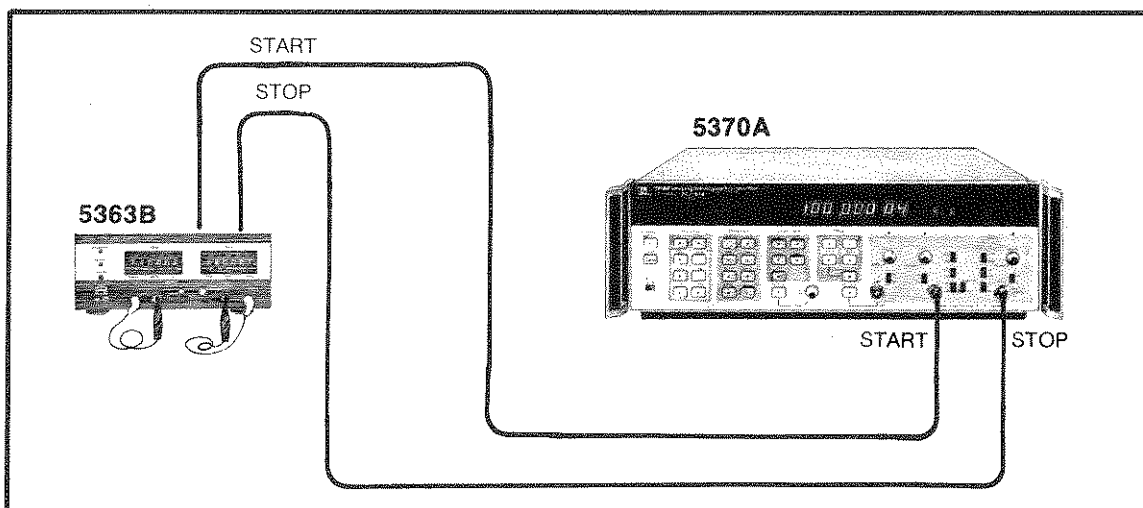

Figure 3-3. 5363B Time Zero Calibration Setup

- b. Insert the 5363B probes, A and B, into their adjacent calibration jacks.
- c. Set the 5363B A channel thumbwheel switches to read A; 0.00; \mathcal{F} .
- d. Set the 5363B B channel thumbwheel switches to read B; 0.00; \mathcal{F} .

NOTE

SLOPE sections of START and STOP thumbwheel switches must be alike; i.e., both set at \mathcal{F} .

- e. Set the 5370A Counter controls as follows:

FUNCTION	TI
STATISTICS	MEAN
SAMPLE SIZE	100
DISPLAY RATE	12 O'clock position
ARMING	\pm TI
INPUTS START/STOP:	
LEVEL	PRESET
INPUT IMPEDANCE	50 ohm
\div 1/ \div 10	\div 1
AC/DC	DC
START COM/SEP	SEP
SLOPE	\mathcal{F}

- f. Lift and hold TIME ZERO/LEVEL switch.
- g. Adjust PULL TO ADD 10.0 ns knob until 5370A Counter display reads approximately 0.00 ns.

NOTE

If the delay cannot be zeroed out because of the nature of the test setup (different cable lengths, etc.), store the delay by pressing the SET REF key of the 5370A Counter. In the SET REF mode the delay is subtracted or added automatically from the next subsequent readings.

Probe select indicators for selected START and STOP probes will NOT flash during calibration.

3-14. MINIMUM REQUIREMENTS FOR SIGNAL MEASUREMENTS

3-15. Figure 3-4 illustrates a waveform showing minimum input signal requirements for conducting measurements with HP 5363B Time Interval Probes.

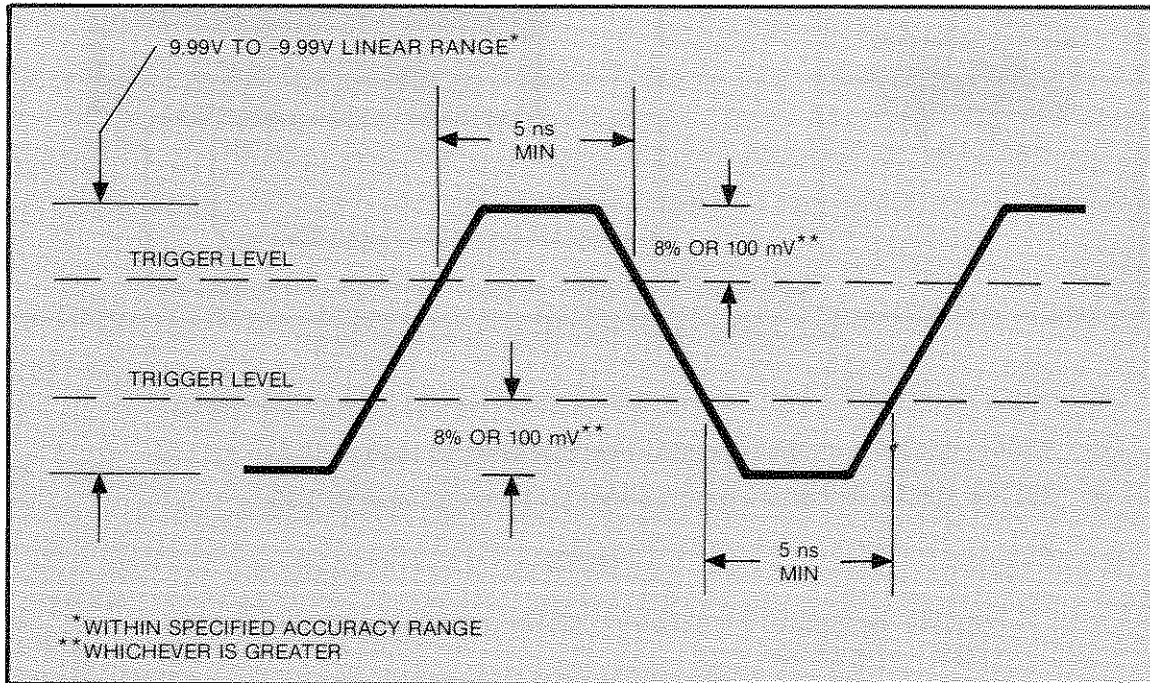

Figure 3-4. Minimum Input Signal Requirements

3-16. PROCEDURES FOR OPERATION UNDER LOCAL CONTROL

3-17. The following paragraphs describe measurement procedures for rise time, fall time, and pulse delay using HP 5345A, HP 5370A, and HP 5335A counters.

3-18. Rise Time (20/80%) Measurement Procedure

3-19. Instrument Setup: HP 5363B Time Interval Probes, HP 182C Oscilloscope, HP 8013B Pulse Generator, and HP 5345A Counter (or HP 5370A Counter, or HP 5335A Counter) are connected as shown in Figure 3-5. Except for HP 5363B, all instrument controls are set as shown in Table 3-1. HP 5363B controls are set as follows:

START/STOP switches	1	2	3	4	5	6
START	A	+	0	.1	0	F
STOP	A	+	0	.4	0	F

TIME ZERO/PULL TO ADD 10.00 ns: OUT (for HP 5345A)

TIME ZERO/PULL TO ADD 10.00 ns: IN (for HP 5370A or HP 5335A)

- Perform Trigger Level Calibration procedure. (See paragraph 3-11.)
- Connect HP 5363B A probe to special T fitting (HP 1250-0655) BNC and adapter HP 1250-0216 at HP 8013A OUTPUT (+) connector.
- Measurement displayed on counter (HP 5345A) is rise time plus 10 ns. Measurement displayed on HP 5370A or HP 5335A is actual rise time.

3-20. Fall Time (20/80%) Measurement Procedure

3-21. Instrument Setup: HP 5363B Time Interval Probes, HP 182C Oscilloscope, HP 8013B Pulse Generator, and HP 5345A Counter (or HP 5370A Counter, or HP 5335A) are connected as shown in *Figure 3-5*. Except for HP 5363B instrument controls are set as shown in *Table 3-1*. HP 5363B controls are set as follows:

START/STOP switches	1	2	3	4	5	6
START	A	+	0	.4	0	∞
STOP	A	+	0	.1	0	∞

TIME ZERO/PULL TO ADD 10.00 ns: OUT (for HP 5345A)

TIME ZERO/PULL TO ADD 10.00 ns: IN (for HP 5370A or HP 5335A)

- Perform Trigger Level Calibration procedure. (See paragraph 3-11.)
- Connect HP 5363B A probe to special T fitting (HP 1250-0655) BNC and adapter HP 1250-0216 at HP 8013A OUTPUT (+) connector.
- Measurement displayed on HP 5345A Counter is fall time plus 10 ns. Measurement displayed on HP 5370, or HP 5335A is actual fall time.

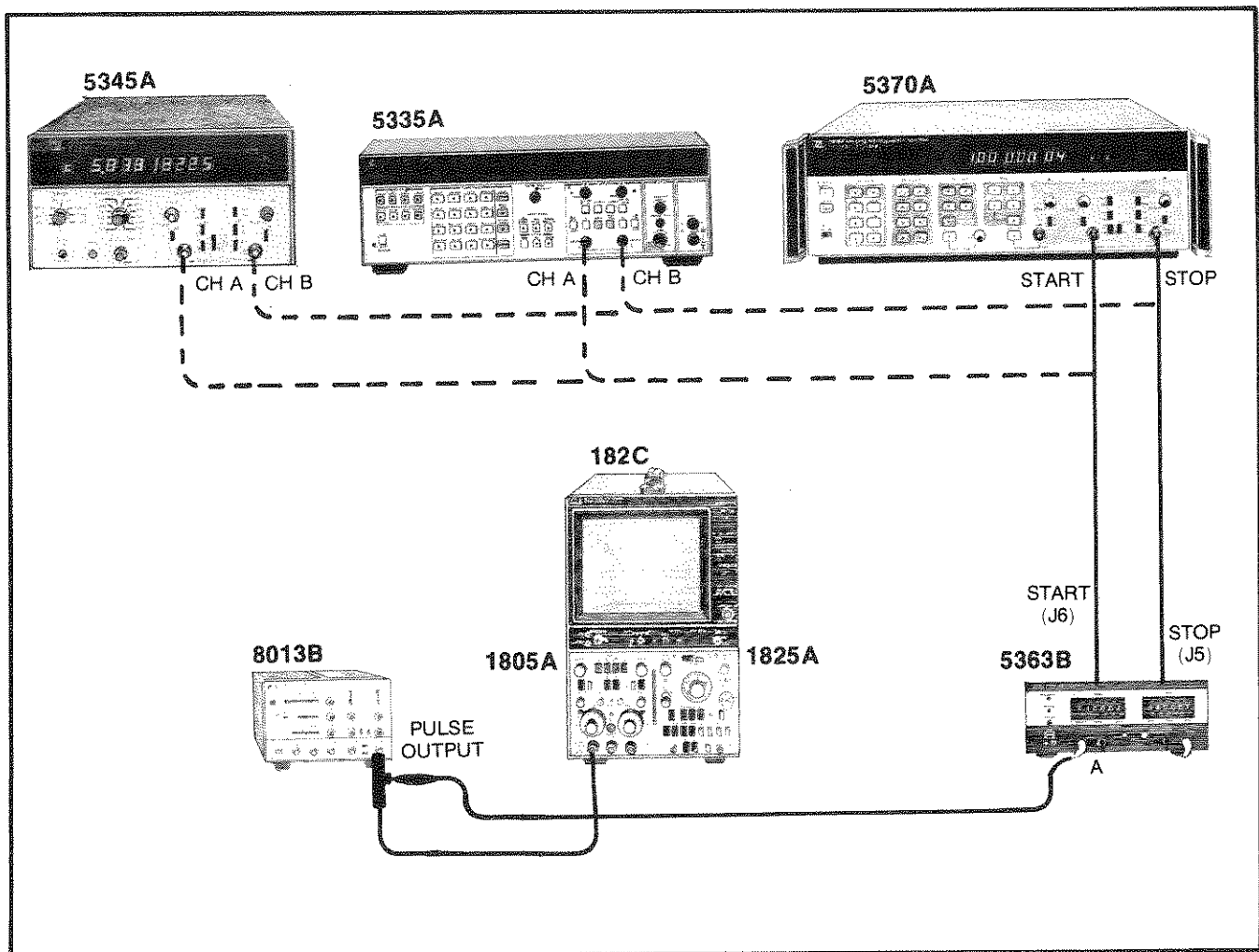

Figure 3-5. Rise Time and Fall Time Measurement Instrument Connections

3-22. Measurement of Pulse Delay Between TRIGGER OUTPUT (+) and OUTPUT on HP 8013B Pulse Generator

3-23. Instrument Setup: HP 5363B Time Interval Probes, HP 182C Oscilloscope, HP 8013B Pulse Generator, and HP 5345A Counter (or HP 5370A Counter, or HP 5335A Counter) are connected as shown in *Figure 3-6*. Except for HP 5363B and HP 8013B control settings specified below, all instrument controls are set as shown in *Table 3-1*. HP 5363B controls are set as follows:

START/STOP switches	1	2	3	4	5	6
START	A	+	0	1	0	$\bar{1}$
STOP	B	+	0	1	0	$\bar{1}$

HP 8013B PULSE DELAY switch is set as follows: 35 n-1.

- Perform Trigger Level Calibration procedure (See paragraph 3-11). (START and STOP slope settings must be set as they will be used.)
- Connect HP 5363B A probe to HP 8013B TRIGGER OUTPUT (+).
- Connect HP 5363B B probe to HP 8013B OUTPUT (+).
- Measurement displayed on HP 5345A Counter is actual pulse delay time plus 10 ns. Model 5370A or 5335A display is actual pulse delay time.

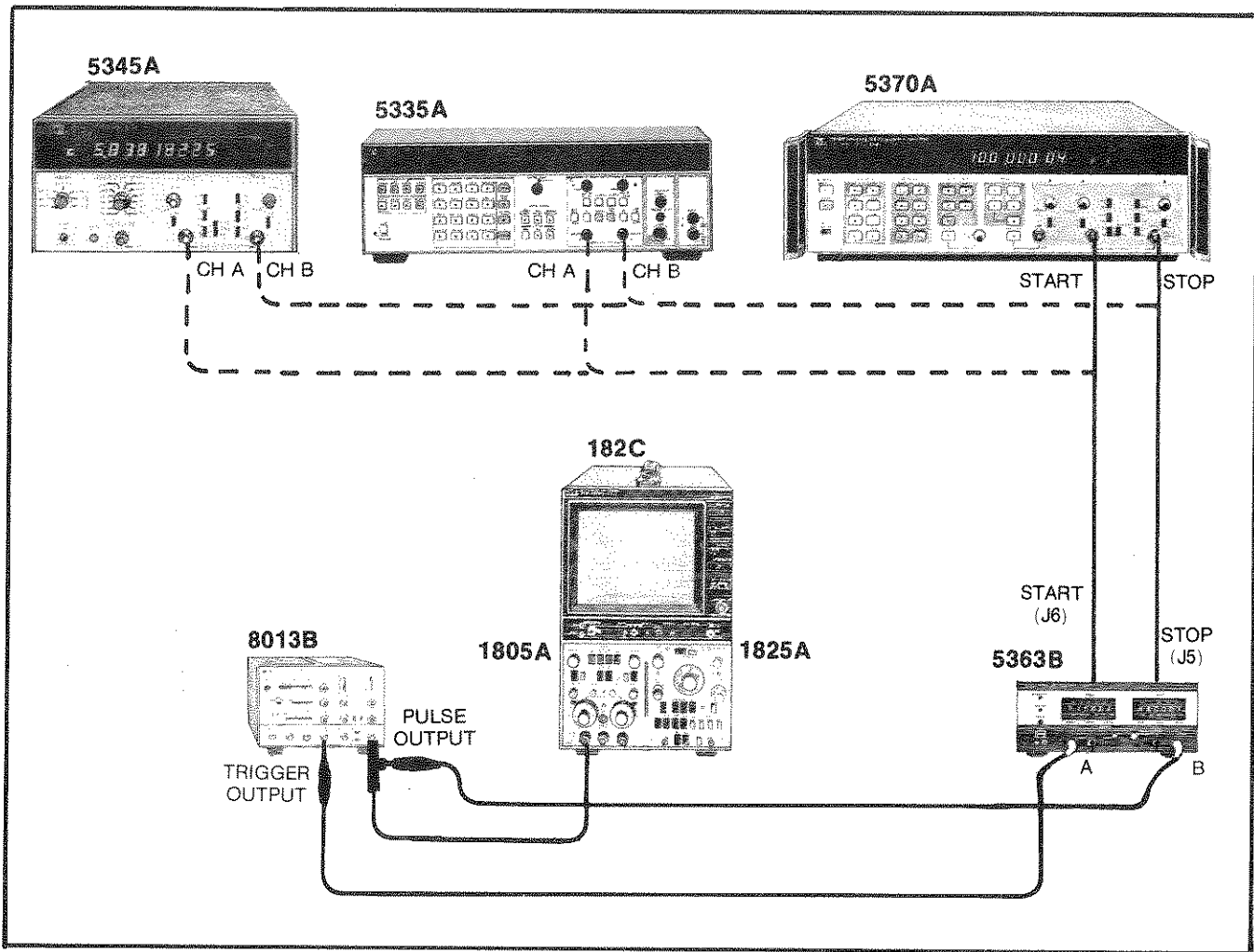

Figure 3-6. Pulse Delay Measurement Instrument Connections

Table 3-1. Instrument Settings for Measurement Examples

MODEL 5345A	FUNCTION	TIME INT A TO B	
	GATE TIME	100 μ s	
	DISPLAY POSITION	AUTO	
	SAMPLE RATE	Set as desired	
	CHANNEL A & CHANNEL B		
	LEVEL	PRESET	
	50 OHMS/1M OHM	50 OHM	
	AC/DC	DC	
	CHECK/COM A/SEP	SEP	
	ATTEN	X1 or X10*	
	SLOPE	+	
	MODEL 5370A	FUNCTION	TI
		STATISTICS	MEAN
SAMPLE SIZE		1K	
ARMING		\pm TI	
DISPLAY RATE		Set as desired	
START & STOP CHANNELS			
LEVEL		PRESET	
50 OHMS/1M OHM		50 OHM	
\pm 1/ \pm 10		\pm 1	
START COM/SEP		SEP	
AC/DC		DC	
SLOPE		+	
MODEL 8013B		PULSE PERIODS	1 μ -0.1m
	VERNIER	MIDRANGE	
	PULSE DOUBLE/NORM	NORM	
	PULSE DELAY & VERNIER	N/A	
	PULSE WIDTH	1-0.1m	
	VERNIER	CCW	
	OFFSET	OFF	
	OUTPUT	(+)	
	AMPLITUDE V	0.5-1.0	
	VERNIER	Set for +0.5 pulse on scope	
	NORM/COMPL	NORM	
	INT LOAD	IN	
	MODEL 5335A	FUNCTION	TIME A-B
GATE MODE		MIN (NO DELAY)	
MATH FUNCTIONS		All off	
STATISTICS FUNCTIONS		MEAN	
CHANNEL A & B INPUTS			
LEVEL		PRESET	
1 M OHM/50 OHMS		50 OHMS	
SLOPE		+	
X10 ATTN, AC, COM A, and AUTO TRIG		Disabled	
MODEL 182C		1805A VERTICAL AMPLIFIER (PLUG-IN)	
		DISPLAY	A
		+UP/-UP	+UP
		DC OFFSET	OFF
	VERNIER TO CAL	CAL	
	VOLTS/DIV	0.1 (50 OHMS)	
	1825A TIME BASE (PLUG-IN)		
	TIME/DIV	0.05	
	POS/NEG	POS	
	AUTO/NORM	NORM	
	INT/EXT	INT	
	REJECT	LF	
	AC/DC	DC	
DELAYED TRIGGER	OFF		

*X10 for 5345A Prefix 1644A and above.

3-28. HP-IB Programming

3-29. DESCRIPTION. Programming of the 5363B is accomplished by sending a sequence of program codes via the HP-IB. Because of the Bus structure, the HP 5363B must be designated as the device to receive the program codes. This is done by addressing it to Listen. To complete the remote programming process, the 5363B must be told to respond to the programming codes instead of its local control, by switching it to remote control. This is done by the combination of a Bus Remote Enable and addressing the 5363B to listen. Generally, the remote operation is similar to operating the 5363B from its front panel controls, with a few exceptions as noted in the following description of remote programming.

3-30. PROGRAMMING PROCEDURE. The following steps are necessary to completely determine the 5363B operating modes, using the remote programming codes:

- a. Put the Bus into the Remote Enable state by sending the Remote Enable Command (set REN low).

NOTE

The techniques for sending the Remote Enable Command is a function of the particular controller devices (i.e., calculator, computer, etc.).

- b. Address the 5363B to Listen by sending the Listen Address assigned to it during setup. (The Listen Address switches the 5363B to REMOTE and the REMOTE indicator will be lighted.)

- c. TRIGGER. Select the desired trigger by sending one of the following codes:

PROGRAMMING CODES			
TRIGGER	ASCII	OCTAL	DECIMAL
START	G	107	71
STOP	R	122	82

- d. Probe Selection. Select the desired probe by sending one of the following codes:

PROGRAMMING CODES			
PROBES	ASCII	OCTAL	DECIMAL
A	A	101	65
B	B	102	66

- e. Voltage Sign. Select the desired polarity by sending one of the following codes:

PROGRAMMING CODES			
SIGN	ASCII	OCTAL	DECIMAL
+	+	53	43
-	-	55	45

- f. Trigger Level. Select the trigger level voltage in the following format: 000. Three characters must be sent. The most significant digit is at the left. Voltage digit codes are as follows:

PROGRAMMING CODES			
VOLTAGE DIGIT	ASCII	OCTAL	DECIMAL
0	0	060	48
1	1	061	49
2	2	062	50
3	3	063	51
4	4	064	52
5	5	065	53
6	6	066	54
7	7	067	55
8	8	070	56
9	9	071	57

- g. Slope. Select the desired slope by sending one of the following codes:

PROGRAMMING CODES			
SLOPE	ASCII	OCTAL	DECIMAL
f	U	125	85
∞	D	104	68

- h. Zero Delay. When the additional 10 ns delay is required for the 5345A counter the following program code is sent:

PROGRAMMING CODES			
ZERO DELAY ADD 10 ns DELAY	ASCII	OCTAL	DECIMAL
	L	114	76

When zero delay is programmed with the 5370A counter, the following program code is sent:

PROGRAMMING CODES			
ZERO DELAY ZERO DELAY	ASCII	OCTAL	DECIMAL
	S	123	83

- i. Calibrate (HP 5363B must be in REMOTE). Prior to sending the calibrate commands the probe tips must be grounded. The following program codes are required:

PROGRAMMING CODES			
CALIBRATE LEVEL	ASCII	OCTAL	DECIMAL
	@	100	64

3-31. Refer to *Table 3-3* for a complete list of 5363B Programming Codes.

Table 3-3. 5363B Programming Codes

FUNCTION	ASCII	BINARY DIO LINES							OCTAL	DECIMAL
		7	6	5	4	3	2	1		
TRIGGER*										
START	G	1	0	0	0	1	1	1	107	71
STOP	R	1	0	1	0	0	1	0	122	82
PROBES										
A	A	1	0	0	0	0	0	1	101	65
B	B	1	0	0	0	0	1	0	102	66
VOLTAGE SIGN										
+	+	0	1	0	1	0	1	1	053	43
OR -	SP	0	1	0	0	0	0	0	040	32
-	-	0	1	0	1	1	0	1	055	45
TRIGGER LEVEL LEVEL IN VOLTS D.DD	SEE VOLTAGE DIGIT CODES									
VOLTAGE DIGIT CODES										
0	0	0	1	1	0	0	0	0	060	48
1	1	0	1	1	0	0	0	1	061	9
2	2	0	1	1	0	0	1	0	062	50
3	3	0	1	1	0	0	1	1	063	51
4	4	0	1	1	0	1	0	0	064	52
5	5	0	1	1	0	1	0	1	065	53
6	6	0	1	1	0	1	1	0	066	54
7	7	0	1	1	0	1	1	1	067	55
8	8	0	1	1	1	0	0	0	070	56
9	9	0	1	1	1	0	0	1	071	57
SLOPE										
f	U	1	0	1	0	1	0	1	125	85
$\frac{1}{f}$	D	1	0	0	0	1	0	0	104	68
TIME ZERO DELAY ADD 10.00 NS DELAY ZERO DELAY	L S	1 1	0 0	0 1	0 0	1 0	1 1	0 1	114 123	76 83
CALIBRATE LEVEL	@	1	0	0	0	0	0	0	100	64
CLEAR CODES										
UNLISTEN	?	0	1	1	1	1	1	1	077	63
UNTALK	— (underscore)	1	0	1	1	1	1	1	137	95
INITIALIZE**	P	1	0	1	0	0	0	0	120	80

*Trigger selection must precede all other program codes for selected channel.
**When 5363B is sent the INITIALIZE code, the following program is selected. B probes START and STOP, 0.00V, -SLOPE.

3-32. UNIVERSAL COMMANDS

3-33. The 5363B obeys the following Universal Commands:

BUS COMMAND	ASCII	OCTAL	DECIMAL
LOCAL LOCKOUT (LLO)	DC1	021	17
GO TO LOCAL (GTL)	SOH	001	1
SERIAL POLL ENABLE (SPE)	CAN	030	24
SERIAL POLL DISABLE (SPD)	EM	031	25

- a. Local Lockout (LLO). Local Lockout is a universal command. All responding devices in a bus system will obey a universal command whether they are addressed to listen or not. Thus, the controller does not need to address devices on the bus before sending a universal command.

Local Lockout (LLO) disables the front panel LOCAL switch so that the unit will remain under remote control even if the switch is pressed. LLO protects the instrument from accidental return to local control during system operation.

Once the 5363B has been given the LLO command, it can return to local control if any of the following occur:

1. REN high
 2. Go To Local (GTL) command
 3. Power Up
- b. Go To Local (GTL). The addressed Command GTL provides a convenient way to return control of selected devices to the system operator. GTL allows the operator to perform tasks that cannot be done solely under remote control.
 - c. Serial Poll Enable (SPE). The 5363B responds to the universal command SERIAL POLL ENABLE. The command is required when it is desired to output a Status byte, to determine the status of the 5363B level calibration. See REMOTE CALIBRATION.
 - d. Serial Poll Disable (SPD). Disables any status byte output from any device on the bus. This command should be issued after a status byte has been output onto the bus.

3-34. Refer to *Table 3-4* for a list of Universal Programming Codes.

3-35. REMOTE CALIBRATION

3-36. Level calibration is necessary when a trigger level error of less than 150mV is required. IT SHOULD BE PERFORMED WHEN THE SLOPES OR PROBES ARE CHANGED. Calibration is accomplished by grounding the probes through 50 ohms or less and sending the level calibration programming code (ASCII @). After sending calibration command, the 5363B causes the Service Request (SRQ) bus control line to become active.

NOTE

For convenience, the probes may be inserted into the front panel CALIBRATION jacks; however, the TIME ZERO/LEVEL switch must be depressed before and during the time the level calibration code is placed onto the bus.

Table 3-4. Universal Programming Codes

FUNCTION	ASCII	BINARY DIO LINES						OCTAL	DECIMAL	
		7	6	5	4	3	2			1
UNIVERSAL CODES (ATN MUST BE LOW)										
LOCAL LOCKOUT (LLO)	DC1	0	0	1	0	0	0	1	021	17
GO TO LOCAL (GTL)	SOH	0	0	0	0	0	0	1	001	1
SERIAL POLL ENABLE (SPE)	CAN	0	0	1	1	0	0	0	030	24
SERIAL POLL DISABLE (SPD)	EM	0	0	1	1	0	0	1	031	25

3-37. CALIBRATION VERIFICATION. Upon completion of a remote level calibration it may be desired to verify that the 5363B did accomplish calibration. This may be done by sending the SERIAL POLL ENABLE command (ASCII CAN), and then addressing the 5363B to its talk address. When this is complete and the controller is switched back to its data mode (ATN=H) a status byte is output onto the bus. The status byte indicates the following:

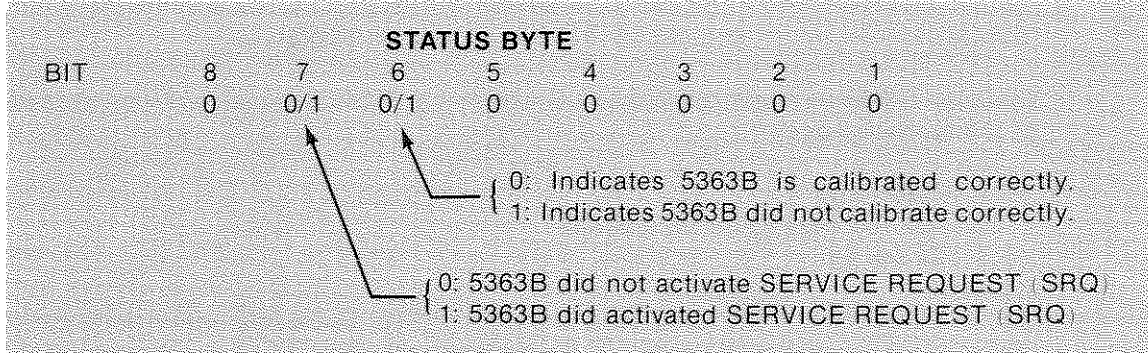

NOTE

The SERVICE REQUEST control line is cleared upon outputting the status byte.

3-38. TIME ZERO DELAY. When programming Time Zero Delay (add 10.00 ns "L", or zero delay "S"), a fast edge (slew rate through 0.0V $\geq 250V/\mu s$, pulse width ≥ 5 ns) must be supplied to the probes. The 5363B trigger threshold should then be set to midpoint of the leading edge. The TIME ZERO pot cannot be remotely programmed; it must be considered in the controller software. An example of how the program can do this is shown in Example 1. As a convenience, it is possible to check and set the TIME ZERO pot after it has been remotely programmed, by locally holding the TIME ZERO/LEVEL switch in the raised position with probes inserted in the front panel CALIBRATE jacks. The TIME ZERO pot may also be set to adjust out any delay.

3-39. PROGRAMMING NOTES

- All remote programming codes and commands are only effective if the 5363B is in REMOTE.
- The REMOTE indicator lighted indicates that the instrument is under complete remote control and that the front panel controls (except the LOCAL pushbutton) are locked out.
- When the ADDRESSED indicator is lighted, it indicates that the 5363B is addressed to listen or talk.
- The order of steps a through g in paragraph 3-30 is arbitrary. A new programming sequence may omit any one or more, steps a through g. The previous value will remain in effect. If a previous value has not been sent, the 5363B will assume its respective INITIALIZE program.
- Universal Bus commands (LLO, GTL, SPE, SPD) can only be given when the bus is in the address mode (ATN LOW).

- f. When the LOCAL pushbutton is depressed, the 5363B is returned to the front panel control. This pushbutton is inoperative if LOCAL LOCKOUT is in effect.
- g. The pot on the PULL TO ADD 10.00 ns control is not programmable. The calibration of this pot can be considered in a software program.

3-40. LISTEN FUNCTION. The programmable functions of the 5363B can be controlled via the HP-IB when the HP 5363B is addressed to listen. An address is set on the rear panel ADDRESS switch as shown in *Table 3-2*. When the ASCII listen address on the bus corresponds to the switch setting, as shown in *Table 3-2*, the ADDRESSED indicator lights. The 5363B will then respond to the programming codes listed in *Table 3-3*.

3-41. HP MODEL 9825A CALCULATOR PROGRAMMING EXAMPLES

3-42. TIME ZERO DELAY Programs

3-43. The following example employs the 5345A Electronic Counter and the 9825A Calculator programmed to instruct the 5363B Time Interval Probes via HP-IB to remotely determine the TIME ZERO DELAY. The measured delay is input to the calculator which computes and prints the time zero offset. This offset can then be added to or subtracted from the 5363B measurement, thereby assuring maximum accuracy. Connect equipment as in *Figure 3-7*.

Equipment required:

- HP 5345A Electronic Counter (with Options 011 and 012)
- HP 9825A Calculator (with HP 98034A HP-IB Interface)
- HP 5363B Time Interval Probes

NOTE

Set HP-IB address switches on 5345A counter to 10010 (decimal 18) and on 5363B to 10000 (decimal 16). The 5345A TALK ONLY/ ADDRESSABLE switch should also be set to the ADDRESSABLE position. Set the 5345A front panel CHANNEL A and B controls to PRESET, 50 ohms, dc, SEP, X1, + (both A and B channels).

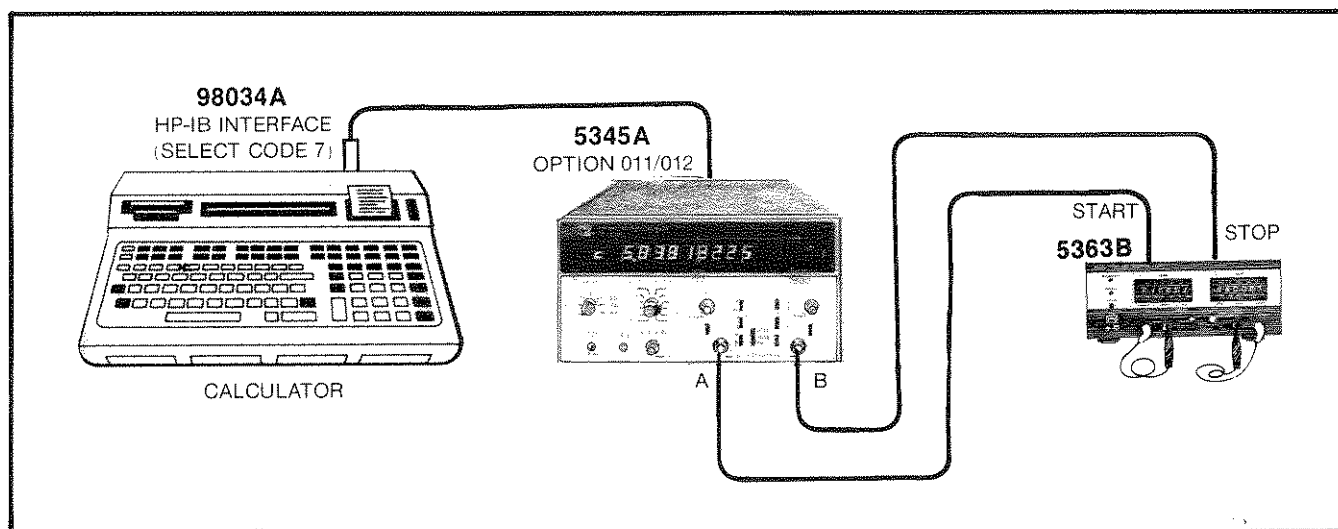

Figure 3-7. Time Zero Measurement Instrument Connections

- 3-44. **LOADING THE PROGRAM.** Load the program as listed in Example 1.
- 3-45. **VERIFYING THE PROGRAM.** Run a program list after loading the program and check the list with the example program list.
- 3-46. **RUNNING THE PROGRAM.** Hold the TIME ZERO/LEVEL switch up (applies pulses to the probes) and press RUN on the 9825A. The calculator should display and print time intervals of approximately 10 ns, depending on the rotation of the PULL TO ADD 10.00 ns potentiometer. To stop the program press RESET.

The image shows a screenshot of a calculator's program list and its execution output. The program list consists of the following lines:

```
0: wrt 718, "I2F3  
G<E0I1";wait 50  
1: wrt 716, "GA+  
0000DLRB+0000DL"  
2: red 718,A  
3: dsp A*1e9  
4: prt A*1e9  
5: eto 2  
6: stp  
*31033
```

Annotations with arrows point to specific parts of the program list:

- Lines 0 and 1: Programs 5345A for INITIALIZE, TIME INT, 100 μ s GATE, REMOTE, RESET. The 50 ms wait is needed to insure that the 5345A is ready.
- Lines 2 and 3: Programs 5363B for A channel = START, +000V, NEG Slope, B channel = STOP, +000V, NEG slope, 10 ns delay.
- Line 4: Read counter.
- Line 5: Display T.I. in ns.

The execution output shows the following values:

```
13.01  
13.01  
13.01  
13.02  
13.02  
13.03  
13.02  
13.02  
13.02  
13.02  
13.01
```

An annotation with a bracket points to the output values: Print T.I. in ns.

Program Example 1

3-47. **REMOTE CALIBRATION PROGRAM:** The following example shows a remote calibration of the 5363B. The 5363B goes into calibrate routine and then requests service (sets SRQ low). The program serial polls the 5363B which outputs a status byte. This status byte is tested to determine if the calibration was correct, incorrect, or incomplete. Service Request is cleared when the status byte is input to the calculator. The calculator displays the result of the calibration and beeps.

Equipment required:

HP 9825A Calculator (with HP 98034A HP-IB Interface Assembly); HP 5363B Time Interval Probes

NOTE

Set Address switch on 5363B to 10000 (decimal 16).

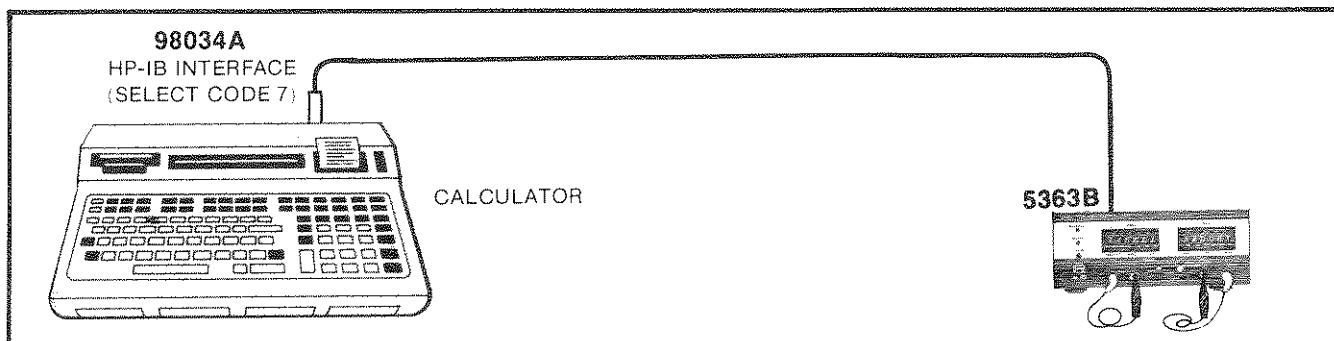

Figure 3-8. Remote Calibration Measurement Instrument Connections

3-48. LOADING THE PROGRAM: Load the program as listed in Example 2.

3-49. VERIFYING THE PROGRAM: Run a program list after loading the appropriate program and check the list with the example program list.

3-50. RUNNING THE PROGRAM: Press RUN on the 9825A. The Calculator will display "CAL BAD" and the value of the status byte in octal (140). The Calculator continuously loops through the program and beeps each time the status byte is read. Press and hold TIME ZERO/LEVEL switch down, to ground the probe tips*. The calculator will display "CAL OK" and the value of the status byte in octal (100).

<pre> 0: fxd 0 1: dim A#[5], B#[5] 2: for I=1 to 2 3: if I=1;"GA"→A #;"RB"→B# 4: if I=2;"GB"→A #;"RA"→B# 5: wrt 716,A#&"+" 000UL"&B#&"+" 000UL@ 6: rds(7)→A 7: if bit(7,A)=1 ;ato 9 8: ato 6 9: rds(716)→S; beep 10: if S=96;dsp "CAL BAD";dtoS; ato 14 11: next I 12: if S=64;dsp "CAL OK";dtoS; ato 14 13: dsp "STATUS BYTE INVALID"; dtoS 14: stop *23207 </pre>	<p>Programs 5363B for A channel START, +000V, POS slope; B channel for STOP, +000V, POS slope; 10 ns delay, CALIBRATE, on first pass through Program (I=1). Then reprograms 5363B for A channel STOP; B channel START (other parameters the same), and CALIBRATE, on the second pass (I=2).</p> <p>Checks SRQ.</p> <p>Reads status byte after SRQ set LOW.</p> <p>Prints calibration message depending on value of the status byte.</p>
------------------------------------------------------------------------------------------------------------------------------------------------------------------------------------------------------------------------------------------------------------------------------------------------------------------------------------------------------------------------------------------------------------------------------	-----------------------------------------------------------------------------------------------------------------------------------------------------------------------------------------------------------------------------------------------------------------------------------------------------------------------------------------------------------------------------------------------------------------------------------------

Program Example 2

*If probe tips are externally grounded, the TIME ZERO/LEVEL switch need not be activated.

Free Manuals Download Website

<http://myh66.com>

<http://usermanuals.us>

<http://www.somanuals.com>

<http://www.4manuals.cc>

<http://www.manual-lib.com>

<http://www.404manual.com>

<http://www.luxmanual.com>

<http://aubethermostatmanual.com>

Golf course search by state

<http://golfingnear.com>

Email search by domain

<http://emailbydomain.com>

Auto manuals search

<http://auto.somanuals.com>

TV manuals search

<http://tv.somanuals.com>