



USER INSTRUCTIONS

MHP-TN centrifugal pump

Single-stage, axial suction, vertical discharge type centrifugal pump

PCN=71576313 – 02/07 (E)

Installation Operation Maintenance

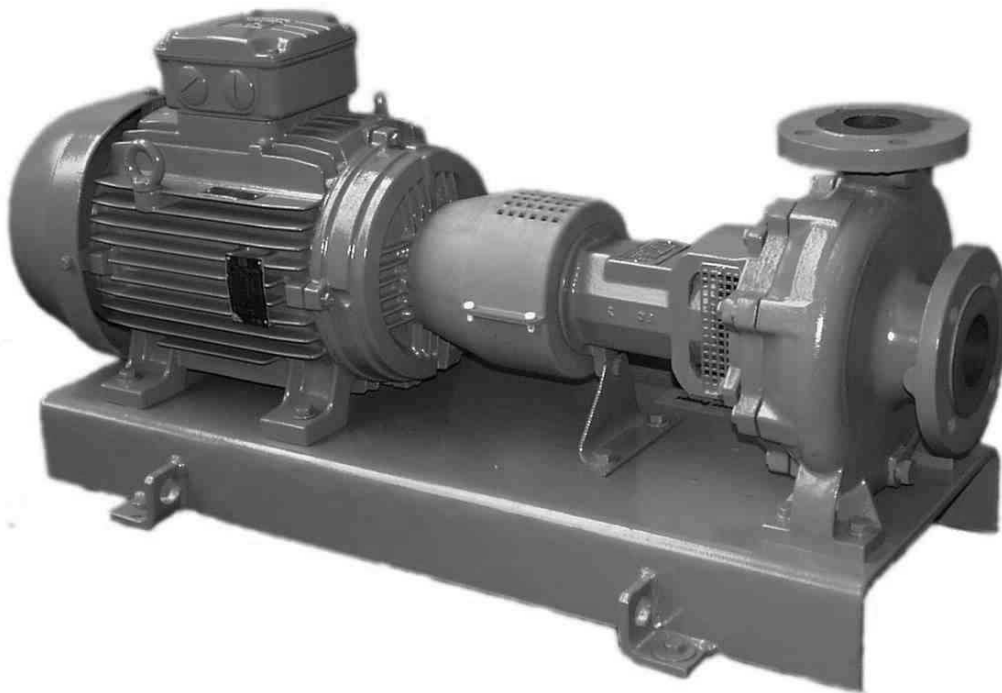

These instructions must be read prior to installing, operating, using and maintaining this equipment.

CONTENTS

	Page		Page
1 INTRODUCTION AND SAFETY	4	6 MAINTENANCE	21
1.1 General	4	6.1 General.....	21
1.2 CE marking and approvals.....	4	6.2 Maintenance schedule.....	22
1.3 Disclaimer.....	4	6.3 Spare parts.....	24
1.4 Copyright.....	4	6.4 Recommended spares and consumable items	24
1.5 Duty conditions.....	4	24
1.6 Safety	5	6.5 Disassembly.....	24
1.7 Nameplate and safety labels	8	7 FAULTS; CAUSES AND REMEDIES	25
1.8 Specific machine performance.....	8	8 PARTS LIST AND DRAWINGS	26
1.9 Noise level.....	9	8.1 Sectional drawings	26
2 TRANSPORT AND STORAGE	10	8.2 Sectional drawings part list.....	27
2.1 Consignment receipt and unpacking	10	8.3 General arrangement drawing	27
2.2 Handling.....	10	9 CERTIFICATION.....	27
2.3 Lifting.....	10	10 OTHER RELEVANT DOCUMENTATION AND	
2.4 Storage.....	11	MANUALS	27
2.5 Recycling and end of product life	11	10.1 Supplementary User Instructions.....	27
3 PUMP DESCRIPTION	11	10.2 Change notes.....	27
3.1 Configurations	11	10.3 Additional sources of information.....	27
3.2 Nomenclature	12		
3.3 Coverage charts	12		
4 INSTALLATION.....	13		
4.1 Location.....	13		
4.2 Foundation	13		
4.3 Grouting	14		
4.4 Initial alignment.....	14		
4.5 Piping	15		
4.6 Electrical connections	16		
4.7 Final shaft alignment check.....	17		
4.8 Protection systems	17		
5 COMMISSIONING, START-UP, OPERATION AND			
SHUTDOWN	17		
5.1 Direction of rotation.....	17		
5.2 Guarding.....	17		
5.3 Priming and auxiliary supplies	17		
5.4 Starting the pump.....	18		
5.5 Running the pump	19		
5.6 Stopping and shutdown	20		
5.7 Hydraulic, mechanical and electrical duty....	20		
5.8 Pumps for Food Use or Potable Water.....	21		

INDEX

Page	Page		
Additional sources (10.3).....	27	Sectional drawings (8.1).....	26
Alignment of shafting (see 4.2, 4.4 and 4.7)		Sound level (see 1.9, Noise level).....	9
ATEX marking (1.6.4.2).....	7	Sources, additional information (10.3).....	27
CE marking and approvals (1.2).....	4	Spare parts (6.3).....	24
Certification (9).....	27	Specific machine performance (1.8).....	8
Change notes (10.2).....	27	Standard maintenance (6.2.1).....	22
Cleaning prior to operation (5.8.1).....	21	Starting the pump (5.4).....	18
Commissioning, start-up, operation (5).....	17	Stop/start frequency (5.5.5).....	20
Compliance, ATEX (1.6.4.1).....	6	Stopping and shutdown (5.6).....	20
Configurations (3.1).....	11	Storage, pump (2.4).....	11
Copyright (1.4).....	4	Storage, spare parts (6.3.2).....	24
Coverage charts (3.3).....	12	Suction piping (4.5.2).....	15
Direction of rotation (5.1).....	17	Supplementary manuals or information sources ..	27
Disassembly (6.5).....	24	Thermal expansion (4.4.1).....	14
Discharge piping (4.5.3).....	16	Transport and storage (2).....	10
Disclaimer (1.3).....	4	Trouble-shooting (see 7).....	25
Dismantling (see 6.5, Disassembly).....	24	Vibration (5.5.4).....	19
Drawings (8.1).....	26		
Duty conditions (1.5).....	4		
Electrical connections (4.6).....	16		
End of product life (2.5).....	11		
Faults; causes and remedies (7).....	25		
Final checks (4.5.4).....	16		
First pump start up (5.4.2).....	18		
Foundation (4.2).....	13		
Forces and moments (see 4.5.1).....	15		
General arrangement drawing (8.3).....	27		
Gland packing (6.2.4).....	23		
Grouting (4.3).....	14		
Guarding (5.2).....	17		
Handling (2.2).....	10		
Hydraulic, mechanical and electrical duty (5.7).....	20		
Inspection (6.2.2 and 6.2.3).....	22		
Installation (4).....	13		
Internal coating (6.2.5).....	23		
Lifting (2.3).....	10		
Location (4.1).....	13		
Maintenance (6).....	21		
Maintenance schedule (6.2).....	22		
Nomenclature (3.2).....	11		
Nameplate (1.7.1).....	8		
Operating limits (see 3.1).....	12		
Ordering spare parts (6.3.1).....	24		
Parts lists (8.2).....	27		
Piping (4.5).....	15		
Protection systems (4.8).....	17		
Pump masses (2.2.2).....	10		
Receipt and unpacking (2.1).....	10		
Recommended spares (6.4).....	24		
Recycling (2.5).....	11		
Replacement parts (see 6.3 and 6.4).....	24		
Running the pump (5.5).....	19		
Safety action (1.6.3).....	5		
Safety labels (1.7.2).....	8		
Safety markings (1.6.1).....	5		
Safety, protection systems (see 1.6 and 4.8)			

1 INTRODUCTION AND SAFETY

1.1 General



These instructions must always be kept close to the product's operating location or directly with the product.

Flowserve products are designed, developed and manufactured with state-of-the-art technologies in modern facilities. The unit is produced with great care and commitment to continuous quality control, utilizing sophisticated quality techniques, and safety requirements.

Flowserve is committed to continuous quality improvement and being at service for any further information about the product in its installation and operation or about its support products, repair and diagnostic services.

These instructions are intended to facilitate familiarization with the product and its permitted use. Operating the product in compliance with these instructions is important to help ensure reliability in service and avoid risks. The instructions may not take into account local regulations; ensure such regulations are observed by all, including those installing the product. Always coordinate repair activity with operations personnel, and follow all plant safety requirements and applicable safety and health laws and regulations.



These instructions must be read prior to installing, operating, using and maintaining the equipment in any region worldwide. The equipment must not be put into service until all the conditions relating to safety noted in the instructions, have been met.

1.2 CE marking and approvals

It is a legal requirement that machinery and equipment put into service within certain regions of the world shall conform with the applicable CE Marking Directives covering Machinery and, where applicable, Low Voltage Equipment, Electromagnetic Compatibility (EMC), Pressure Equipment Directive (PED) and Equipment for Potentially Explosive Atmospheres (ATEX).

Where applicable the Directives and any additional Approvals cover important safety aspects relating to machinery and equipment and the satisfactory provision of technical documents and safety instructions. Where applicable this document incorporates information relevant to these Directives and Approvals.

To confirm the Approvals applying and if the product is CE marked, check the serial number plate markings and the Certification. (See section 9, *Certification*.)

1.3 Disclaimer

Information in these User Instructions is believed to be reliable. In spite of all the efforts of Flowserve Corporation to provide sound and all necessary information the content of this manual may appear insufficient and is not guaranteed by Flowserve as to its completeness or accuracy.

Flowserve manufactures products to exacting International Quality Management System Standards as certified and audited by external Quality Assurance organizations. Genuine parts and accessories have been designed, tested and incorporated into the products to help ensure their continued product quality and performance in use. As Flowserve cannot test parts and accessories sourced from other vendors the incorrect incorporation of such parts and accessories may adversely affect the performance and safety features of the products. The failure to properly select, install or use authorized Flowserve parts and accessories is considered to be misuse. Damage or failure caused by misuse is not covered by the Flowserve warranty. In addition, any modification of Flowserve products or removal of original components may impair the safety of these products in their use.

1.4 Copyright

All rights reserved. No part of these instructions may be reproduced, stored in a retrieval system or transmitted in any form or by any means without prior permission of Flowserve.

1.5 Duty conditions

This product has been selected to meet the specifications of your purchaser order. The acknowledgement of these conditions has been sent separately to the Purchaser. A copy should be kept with these instructions.



The product must not be operated beyond the parameters specified for the application. If there is any doubt as to the suitability of the product for the application intended, contact Flowserve for advice, quoting the serial number.

If the conditions of service on your purchase order are going to be changed (for example liquid pumped, temperature or duty) it is requested that the user seeks the written agreement of Flowserve before start up.

1.6 Safety

1.6.1 Summary of safety markings

These User Instructions contain specific safety markings where non-observance of an instruction would cause hazards. The specific safety markings are:

 **DANGER** This symbol indicates electrical safety instructions where non-compliance will involve a high risk to personal safety or the loss of life.

 This symbol indicates safety instructions where non-compliance would affect personal safety and could result in loss of life.

 This symbol indicates "hazardous substances and toxic fluid" safety instructions where non-compliance would affect personal safety and could result in loss of life.

 **CAUTION** This symbol indicates safety instructions where non-compliance will involve some risk to safe operation and personal safety and would damage the equipment or property.

 This symbol indicates explosive atmosphere zone marking according to ATEX. It is used in safety instructions where non-compliance in the hazardous area would cause the risk of an explosion.

 This symbol is used in safety instructions to remind not to rub non-metallic surfaces with a dry cloth; ensure cloth is damp. It is used where non-compliance in the hazardous area would cause the risk of an explosion.

Note: This sign is not a safety symbol but indicates an important instruction in the assembly process.

1.6.2 Personnel qualification and training

All personnel involved in the operation, installation, inspection and maintenance of the unit must be qualified to carry out the work involved. If the personnel in question do not already possess the necessary knowledge and skill, appropriate training and instruction must be provided. If required the operator may commission the manufacturer/supplier to provide applicable training.

Always coordinate repair activity with operations and health and safety personnel, and follow all plant safety requirements and applicable safety and health laws and regulations.

1.6.3 Safety action

This is a summary of conditions and actions to prevent injury to personnel and damage to the environment and to equipment. For products used in potentially explosive atmospheres section 1.6.4 also applies.

 **DANGER** NEVER DO MAINTENANCE WORK WHEN THE UNIT IS CONNECTED TO POWER

 **GUARDS MUST NOT BE REMOVED WHILE THE PUMP IS OPERATIONAL**

 **DRAIN THE PUMP AND ISOLATE PIPEWORK BEFORE DISMANTLING THE PUMP**

The appropriate safety precautions should be taken where the pumped liquids are hazardous.

 **FLUORO-ELASTOMERS** (When fitted.) When a pump has experienced temperatures over 250 °C (482 °F), partial decomposition of fluoro-elastomers (example: Viton) will occur. In this condition these are extremely dangerous and skin contact must be avoided.

 **HANDLING COMPONENTS** Many precision parts have sharp corners and the wearing of appropriate safety gloves and equipment is required when handling these components. To lift heavy pieces above 25 kg (55 lb) use a crane appropriate for the mass and in accordance with current local regulations.

 **THERMAL SHOCK** Rapid changes in the temperature of the liquid within the pump can cause thermal shock, which can result in damage or breakage of components and should be avoided.

 **NEVER APPLY HEAT TO REMOVE IMPELLER** Trapped lubricant or vapor could cause an explosion.

 **HOT (and cold) PARTS** If hot or freezing components or auxiliary heating supplies can present a danger to operators and persons entering the immediate area action must be taken to avoid accidental contact. If complete protection is not possible, the machine access must be limited to maintenance staff only, with clear visual warnings and indicators to those entering the immediate area. Note: bearing housings must not be insulated and drive motors and bearings may be hot.

If the temperature is greater than 68 °C (175 °F) or below 5 °C (20 °F) in a restricted zone, or exceeds local regulations, action as above shall be taken.



HAZARDOUS LIQUIDS

When the pump is handling hazardous liquids care must be taken to avoid exposure to the liquid by appropriate siting of the pump, limiting personnel access and by operator training. If the liquid is flammable and/or explosive, strict safety procedures must be applied.

Gland packing must not be used when pumping hazardous liquids.



PREVENT EXCESSIVE EXTERNAL PIPE LOAD

Do not use pump as a support for piping. Do not mount expansion joints, unless allowed by Flowserve in writing, so that their force, due to internal pressure, acts on the pump flange.



ENSURE CORRECT LUBRICATION

(See section 5, *Commissioning, startup, operation and shutdown.*)



START THE PUMP WITH OUTLET VALVE PART OPENED

(Unless otherwise instructed at a specific point in the User Instructions.)

This is recommended to minimize the risk of overloading and damaging the pump motor at full or zero flow. Pumps may be started with the valve further open only on installations where this situation cannot occur. Pump outlet valve shall may need to be adjusted to comply with the duty following the run-up process. (See section 5, *Commissioning start-up, operation and shutdown.*)



NEVER RUN THE PUMP DRY



INLET VALVES TO BE FULLY OPEN WHEN PUMP IS RUNNING

Running the pump at zero flow or below the recommended minimum flow continuously will cause damage to the seal.



DO NOT RUN THE PUMP AT ABNORMALLY HIGH OR LOW FLOW RATES

Operating at a flow rate higher than normal or at a flow rate with no backpressure on the pump may overload the motor and cause cavitation. Low flow rates may cause a reduction in pump/bearing life, overheating of the pump, instability and cavitation/vibration.

1.6.4 Products used in potentially explosive atmospheres



The following instructions for pumps and pump units when installed in potentially explosive atmospheres must be followed to help ensure explosion protection.

The terminology and procedures ensure that the installed pump is in compliance with the European Directive 94/9/EC, known as the ATEX Directive, which is mandatory in Europe and may also be specified in other countries. Where applicable, both electrical and non-electrical equipment must meet the requirements 94/9/EC.

Even if the installation is in a region where ATEX is not the applicable regulation, the general measures described shall be followed to ensure safe operation.

The measures are explained under the headings of:

- Avoiding excessive surface temperature
- Preventing build up of explosive mixtures
- Preventing the generation of sparks
- Preventing leakages
- Maintaining the pump to avoid hazard

1.6.4.1 Scope of compliance



Use equipment only in the zone for which it is appropriate. Always check that the driver, drive coupling assembly, seal and pump equipment are suitably rated and/or certified for the classification of the specific atmosphere in which they are to be installed.

Where Flowserve has supplied only the bare shaft pump, the Ex rating applies only to the pump. The party responsible for assembling the pump set shall select the coupling, driver and any additional equipment, with the necessary CE Declaration of Conformity establishing it is suitable for the area in which it is to be installed.

The output from a variable frequency drive (VFD) can cause additional heating affects in the motor and so, for pumps sets with a VFD, the ATEX Certification for the motor must state that it covers the situation where electrical supply is from the VFD. This particular requirement still applies even if the VFD is in a safe area.

1.6.4.2 Marking

An example of ATEX equipment marking is shown below. The actual classification of the pump will be engraved on the nameplate.



Equipment Group

- I = Mining
- II = Non-mining

Category

- 2 or M2 = High level protection
- 3 = normal level of protection

Gas and/or Dust

G = Gas; D= Dust

c = Constructional safety
(in accordance with EN 13463-5)

Gas Group (Equipment Category 2 only)

- IIA – Propane (typical)
- IIB – Ethylene (typical)
- IIC – Hydrogen (typical)

Maximum surface temperature (Temperature Class)
(see section 1.6.4.3)

1.6.4.3 Avoiding excessive surface temperatures



ENSURE THE EQUIPMENT TEMPERATURE CLASS IS SUITABLE FOR THE HAZARD ZONE

Pumps have a temperature class as stated in the ATEX Ex rating on the nameplate. These are based on a maximum ambient of 40 °C (104 °F); refer to Flowserve for higher ambient temperatures.

The surface temperature on the pump is influenced by the temperature of the liquid handled. The maximum permissible liquid temperature depends on the temperature class and must not exceed the values in the table that follows.

The temperature rise at the seals, bearings and due to the minimum permitted flow rate is taken into account in the temperatures stated.

Temperature class to EN 13463-1	Maximum surface temperature permitted	Temperature limit of liquid handled (* depending on material and construction variant - check which is lower)
T6	85 °C (185 °F)	Consult Flowserve
T5	100 °C (212 °F)	Consult Flowserve
T4	135 °C (275 °F)	115 °C (239 °F) *
T3	200 °C (392 °F)	180 °C (356 °F) *
T2	300 °C (572 °F)	275 °C (527 °F) *
T1	450 °C (842 °F)	400 °C (752 °F) *

The responsibility for compliance with the specified maximum liquid temperature is with the plant operator.

Temperature classification “Tx” is used when the liquid temperature varies and the pump could be installed in different hazardous atmospheres. In this case the user is responsible for ensuring that the pump surface temperature does not exceed that permitted in the particular hazardous atmosphere.

If an explosive atmosphere exists during the installation, do not attempt to check the direction of rotation by starting the pump unfilled. Even a short run time may give a high temperature resulting from contact between rotating and stationary components. Furthermore, confinement of liquid in the pump and pipes must be avoided (valve closed). If the liquid heats up this may cause excessive pressure and lead to bursting of pump components.

Where there is any risk of the pump being run against a closed valve generating high liquid and casing external surface temperatures it is recommended that users fit an external surface temperature protection device.

Avoid mechanical, hydraulic or electrical overload by using motor overload trips, temperature monitor or a power monitor and make routine vibration monitoring checks.

In dirty or dusty environments, regular checks must be made and dirt removed from areas around close clearances, bearing housings and motors.

1.6.4.4 Preventing the build up of explosive mixtures



ENSURE PUMP IS PROPERLY FILLED AND VENTED AND DOES NOT RUN DRY.

Ensure pump and relevant suction and discharge pipeline system is totally filled with liquid at all times during the pump operation, so that an explosive atmosphere is prevented. In addition it is essential to make sure that seal chambers, auxiliary shaft seal systems and any heating and cooling systems are properly filled.

If the operation of the system cannot avoid this condition the fitting of an appropriate dry run protection device is recommended (eg liquid detection or power monitor).

To avoid potential hazards from fugitive emissions of vapor or gas to atmosphere the surrounding area must be well ventilated.

1.6.4.5 Preventing sparks

To prevent a potential hazard from mechanical contact, the coupling guard must be non-sparking. To avoid the potential hazard from random induced current generating a spark the ground contact on the baseplate must be used.

Avoid electrostatic charge: do not rub non-metallic surfaces with a dry cloth, ensure cloth is damp.

Where applicable the coupling must be selected to comply with 94/9/EC and correct alignment must be maintained.

Additional requirements for metallic pumps on non-metallic baseplates

When metallic components are fitted on a non-metallic baseplate they must be individually earthed (grounded).

1.6.4.6 Preventing leakage

The pump must only be used to handle liquids for which it has been approved to have the correct corrosion resistance.

Avoid entrapment of liquid in the pump and associated piping due to closing of suction and discharge valves, which could cause dangerous excessive pressures to occur if there is heat input to the liquid. This can occur if the pump is stationary or running.

Bursting of liquid containing parts due to freezing must be avoided by draining or protecting the pump and ancillary systems.

Where there is the potential hazard of a loss of a seal barrier fluid or external flush, the fluid must be monitored.

If leakage of liquid to atmosphere can result in a hazard, the installation of a liquid detection device is recommended.

1.6.4.7 Maintenance to avoid the hazard

CORRECT MAINTENANCE IS REQUIRED TO AVOID POTENTIAL HAZARDS WHICH GIVE A RISK OF EXPLOSION

The responsibility for compliance with maintenance instructions is with the plant operator.

To avoid potential explosion hazards during maintenance, the tools, cleaning and painting materials used must not give rise to sparking or adversely affect the ambient conditions.

Where there is a risk from such tools or materials; maintenance must be conducted in a safe area. It is recommended that a maintenance plan and schedule is adopted. (See section 6, *Maintenance*.)

1.7 Nameplate and safety labels

1.7.1 Nameplate

For details of nameplate, see the *Declaration of Conformity*, or separate documentation included with these User Instructions.

1.7.2 Safety labels

		WARNING	J218JZ250
ESSENTIAL PROCEDURES BEFORE STARTING:			
INSTALL AND OPERATE EQUIPMENT IN ACCORDANCE WITH THE INSTRUCTION MANUAL SUPPLIED SEPARATELY.	ENSURE ALL EXTERNAL CONNECTIONS TO THE PUMP / SHAFT SEALING AND DRIVER ARE CONNECTED AND OPERATIONAL.	FULLY PRIME UNIT AND SYSTEM. DO NOT RUN UNIT DRY.	
ENSURE GUARDS ARE SECURELY IN PLACE.	FAILURE TO FOLLOW THESE PROCEDURES MAY RESULT IN PERSONAL INJURY AND / OR EQUIPMENT DAMAGE		
ENSURE CORRECT DIRECTION OF ROTATION.			

J218/268	
ENSURE UNIT ON A FIRM FOUNDATION AND THAT COUPLING FACES ARE IN CORRECT ALIGNMENT PRIOR TO AND AFTER BOLTING BASEPLATE DOWN AND FIXING PIPEWORK. SEE MANUAL FOR TOLERANCES.	PUMP MUSS AUF FESTEM FUNDAMENT STEHEN. KUPPLUNGSHÄLFTEN KORREKT AXIAL AUSRICHTEN. DANN PUMPE AUF GRUNDPLATTE FESTSPANNEN UND ANSCHLUSSLEITUNGEN BEFESTIGEN. TOLERANZEN S. BETRIEBSANLEITUNG.
S'ASSURER QUE LE GROUPE ELECTROPOMPE EST FERMEMENT INSTALLE SUR SON MASSIF. VERIFIER LE LIGNAGE DE L'ACCOUPEMENT AVANT ET APRES FIXATION DU SOCLE ET DE LA TUYAUTERIE. VOIR LES TOLERANCES D'ALIGNMENT SUR LA NOTICE	ZORG DAT POMPEENHEID OP EEN STEVIGE ONDERGROND OPGESTELD STAAT EN DAT KOPPELING CORRECT UITGELIJNT IS ZOWEL VOOR ALS NADAT DE GRONDPLAAT MET BOUTEN IS VASTGEZET EN DE LEIDINGEN GEINSTALLEERD ZIJN. ZIE HANDLEIDING VOOR TOELAABARE SPELINGEN.
CDC: 603 604 610 612 621 623 624	

Oil lubricated units only:

J218JZ262	
WARNING	THIS MACHINE MUST BE FILLED WITH OIL BEFORE STARTING
ATTENTION	CETTE MACHINE DOIT ÊTRE REMPLIE D'HUILE AVANT LA MISE EN MARCHÉ
ACHTUNG	DIESE MASCHINE IST VOR DEM STARTEN MIT ÖL ZÜ FULLEN
WAARSCHUWING	DEZE MACHINE MOET VOOR HET STARTEN MET OLIE GEVULD WORDEN
CDC: 603 604 610 612 621 623 624	

1.8 Specific machine performance

For performance parameters see section 1.5, *Duty conditions*. When the contract requirement specifies these to be incorporated into User Instructions these are included here. Where performance data has been supplied separately to the purchaser these should be obtained and retained with these User Instructions if required.

1.9 Noise level

Attention must be given to the exposure of personnel to the noise, and local legislation will define when guidance to personnel on noise limitation is required, and when noise exposure reduction is mandatory. This is typically 80 to 85 dBA.

The usual approach is to control the exposure time to the noise or to enclose the machine to reduce emitted sound.

You may have already specified a limiting noise level when the equipment was ordered, however if no noise requirements were defined, then attention is drawn to the following table to give an indication of equipment noise level so that you can take the appropriate action in your plant.

Pump noise level is dependent on a number of operational factors, flow rate, pipework design and acoustic characteristics of the building, and so the values given are subject to a 3 dBA tolerance and cannot be guaranteed.

Similarly the motor noise assumed in the “pump and motor” noise is that typically expected from standard and high efficiency motors when on load directly driving the pump. Note that a motor driven by an inverter may show an increased noise at some speeds.

If a pump unit only has been purchased for fitting with your own driver then the “pump only” noise levels in the table should be combined with the level for the driver obtained from the supplier. Consult Flowserve or a noise specialist if assistance is required in combining the values.

It is recommended that where exposure approaches the prescribed limit, then site noise measurements should be made.

The values are in sound pressure level L_{pA} at 1 m (3.3 ft) from the machine, for “free field conditions over a reflecting plane”.

For estimating sound power level LWA (re 1 pW) then add 17 dBA to the sound pressure value.

Motor size and speed kW (hp)	Typical sound pressure level L_{pA} at 1 m reference 20 μ Pa, dBA							
	3 550 r/min		2 900 r/min		1 750 r/min		1 450 r/min	
	Pump only	Pump and motor	Pump only	Pump and motor	Pump only	Pump and motor	Pump only	Pump and motor
< 0.55 (< 0.75)	72	72	64	65	62	64	62	64
0.75 (1)	72	72	64	66	62	64	62	64
1.1 (1.5)	74	74	66	67	64	64	62	63
1.5 (2)	74	74	66	71	64	64	62	63
2.2 (3)	75	76	68	72	65	66	63	64
3 (4)	75	76	70	73	65	66	63	64
4 (5)	75	76	71	73	65	66	63	64
5.5 (7.5)	76	77	72	75	66	67	64	65
7.5 (10)	76	77	72	75	66	67	64	65
11 (15)	80	81	76	78	70	71	68	69
15 (20)	80	81	76	78	70	71	68	69
18.5 (25)	81	81	77	78	71	71	69	71
22 (30)	81	81	77	79	71	71	69	71
30 (40)	83	83	79	81	73	73	71	73
37 (50)	83	83	79	81	73	73	71	73
45 (60)	86	86	82	84	76	76	74	76
55 (75)	86	86	82	84	76	76	74	76
75 (100)	87	87	83	85	77	77	75	77
90 (120)	87	88	83	85	77	78	75	78
110 (150)	89	90	85	87	79	80	77	80
150 (200)	89	90	85	87	79	80	77	80
200 (270)	①	①	①	①	85	87	83	85
300 (400)					87	90	85	86

① The noise level of machines in this range will most likely be of values which require noise exposure control, but typical values are inappropriate.

Note: for 1 180 and 960 r/min reduce 1 450 r/min values by 2 dBA. For 880 and 720 r/min reduce 1 450 r/min values by 3 dBA.

In areas where the staff has to intervene, remember that when the level of the sound pressure is:

- below 70 dBA: it is not necessary to take special precautions.
- above 70 dBA: people working continuously in the machine room must be supplied with protective devices against noise.
- below 85 dBA: no particular measures need to be taken for casual visitors staying in the room during a limited period.
- above 85 dBA: the room must be considered as a dangerous area because of the noise and a warning sign must be fixed at each entry warning the people coming into the room, even for a short period, that they must wear hearing protection.
- above 105 dBA: special hearing protection adapted to this noise level and to the spectral noise components must be installed and a warning sign to this effect erected at each entry. The staff in the room must wear ear protection.

Make sure that the noise, which travels through the walls and windows, does not generate too high noise levels in the machine room's surroundings.

2 TRANSPORT AND STORAGE

2.1 Consignment receipt and unpacking

Immediately after receipt of the equipment it must be checked against the delivery and shipping documents for its completeness and that there has been no damage in transportation.

Any shortage and or damage must be reported immediately to Flowserve and received in writing within one month of receipt of the equipment. Later claims cannot be accepted.

Check any crate, boxes and wrappings for any accessories or spare parts that may be packed separately with the equipment or attached to sidewalls of the box or equipment.

Each product has a unique serial number. Check that this number corresponds with that advised and always quote this number in correspondence as well as when ordering spare parts or further accessories.

2.2 Handling

2.2.1 General instructions concerning handling

Boxes, crates, pallets or cartons may be unloaded using forklift vehicles or slings dependent on their size and construction. See 2.3.1 for positioning of slings.

To lift heavy pieces above 25 kg (55 lb), use a winch adapted to the mass and in accordance with the current local regulations.

To lift machines or pieces with one or several suspension rings, only use hooks and chains in compliance with the local regulations concerning safety.

Never put cables, chains or ropes directly on or in the suspension rings. Cables, chains or lifting ropes must never present excessive bending.

Never bend the lifting hooks, suspension rings, chains, etc., which should only be made to endure stresses within, calculated limits. Remember that the capacity of a lifting device decreases when the direction of the lifting force direction makes an angle with the device axis.

To increase the safety and the efficiency of the lifting device, all the lifting elements must be as perpendicular as possible. If necessary a lifting beam can be placed between the winch and the load.

When heavy pieces are lifted up, never stay or work under the load or in the area, which could be in the path of the load if it were to swing or fall away. Never leave a load hanging from a winch. The acceleration or the slowing-down of lifting equipment must stay in the safety limits for the staff.

A winch must be positioned in such a way that the load will be raised perpendicularly. Where possible necessary precautions must be taken to avoid the swing of the load, using for example two winches making approximately the same angle, below 30°, with the vertical.

2.2.2 Pump masses

Pump type	Pump mass	
	kg	lb
MHP- TN 100-65-315	134	295
MHP- TN 125-100-315	152	335

 All motors (for masses see the motor description plate) must be handled with a winch.

 For masses above 25 kg (55 lb), manual handling is forbidden.

2.3 Lifting

2.3.1 Slings of motor pumps units

 Use handling means in accordance with motor pump unit mass mentioned on the CE plate. For the masses of the pumps bare end of shaft see table § 2.2.2 and nameplate.

 CAUTION To avoid distortion, the pump unit should be lifted as shown.

Motor pump unit

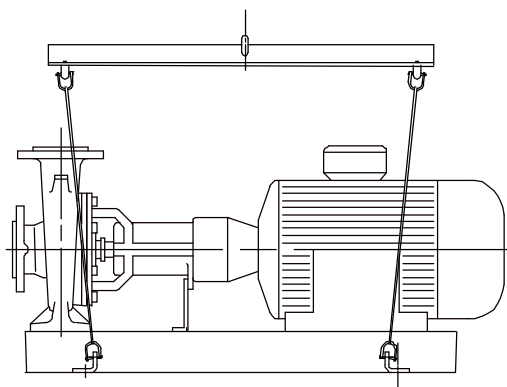

Bareshaft pump

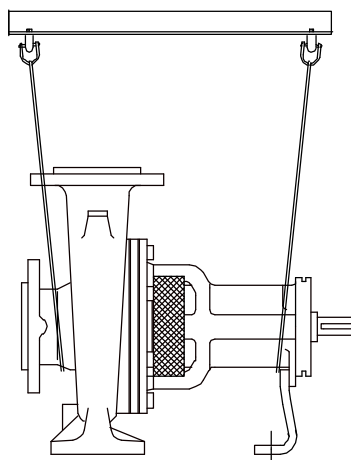

! When handling always wear gloves, safety boots and an industrial safety helmet.

! For masses above 25 kg (55 lb), manual handling is forbidden.

2.4 Storage

! **CAUTION** Store the pump in a clean, dry location away from vibration. Leave piping connection covers in place to keep dirt and other foreign material out of pump casing. Turn pump at intervals to prevent brinelling of the bearings and the seal faces, if fitted, from sticking.

Do not store pumps starting on the fan guard.

The pump may be stored as above for up to 6 months. Consult Flowserve for preservative actions when a longer storage period is needed.

2.5 Recycling and end of product life

At the end of the service life of the product or its parts, the relevant materials and parts should be recycled or disposed of using an environmentally acceptable method and local regulations. If the product contains substances which are harmful to the environment, these should be removed and disposed of in accordance with current regulations.

This also includes the liquids and or gases in the "seal system" or other utilities.

! Make sure that hazardous substances or toxic fluid are disposed of safely and that the correct personal protective equipment is used. The safety specifications must be in accordance with the current regulations at all times.

3 PUMP DESCRIPTION

3.1 Configurations

The centrifugal motor pump is designed for the pumping of cold water or all clear liquids which are not solid and liquid mixtures, non-corrosive, non-abrasive when in contact with the pump motor unit and its working parts (Important: for other liquids consult Flowserve for beforehand advice).

The MHP-TN pump is a centrifugal, single-stage pump with axial inlet and outlet in the vertical axis.

! The pump must be stored in a non explosive, ventilated location, sheltered from bad weather, dust and vibrations.

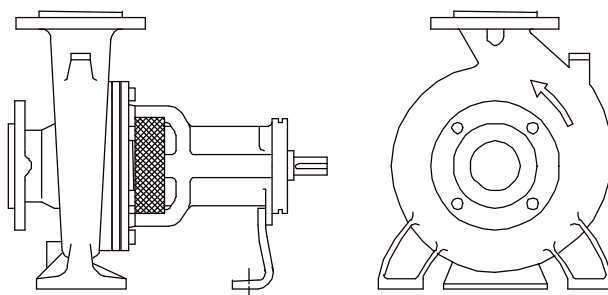

The reliability of the delivered machine can only be ensured if it is used according to the conditions given in this manual. The maximum values specified in this manual must never be exceeded.

- Maximum working pressure at discharge 16 bar (232 psi)
- Maximum working pressure at suction 10 bar (145 psi)
- Maximum pumped fluid temperature - Gland packing without cooling ≤ 105 °C (221 °F)
- Minimum pumped fluid temperature -10 °C (14 °F)
- Maximum ambient temperature 40 °C (104 °F)
- Maximum solid suspension 50 g/m³ (0.003 lbm/ft³)
- Density 1
- Viscosity 1 mm²/s (31 SSU)
- Maximum rotation speed (frequency 50 Hz) 2900 min⁻¹

! **CAUTION** The maximum speed is shown on the pump nameplate.

3.2 Nomenclature

Characteristics shown on the nameplate fixed on the pump are as shown below:

Each pump is supplied with the following nameplate:

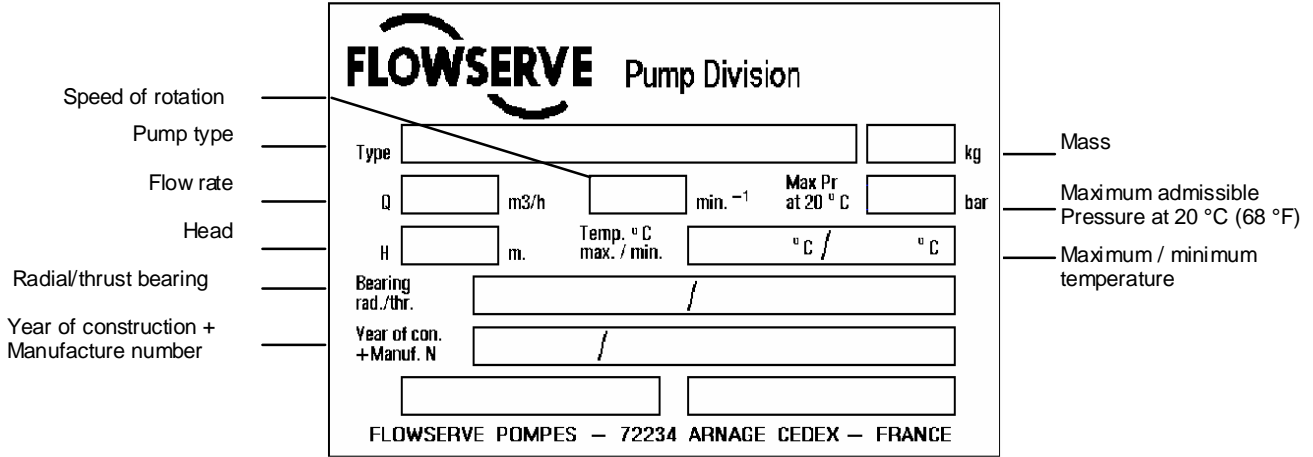

Each pump unit is supplied with the following nameplate:

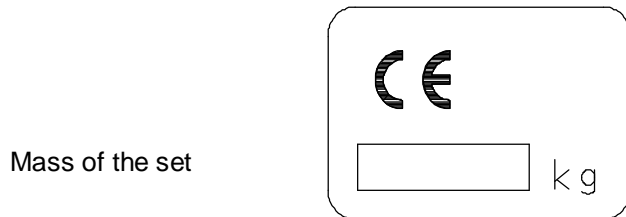

3.3 Coverage charts

3.3.1 2900 min⁻¹ (50 Hz): coverage charts (Q, H)

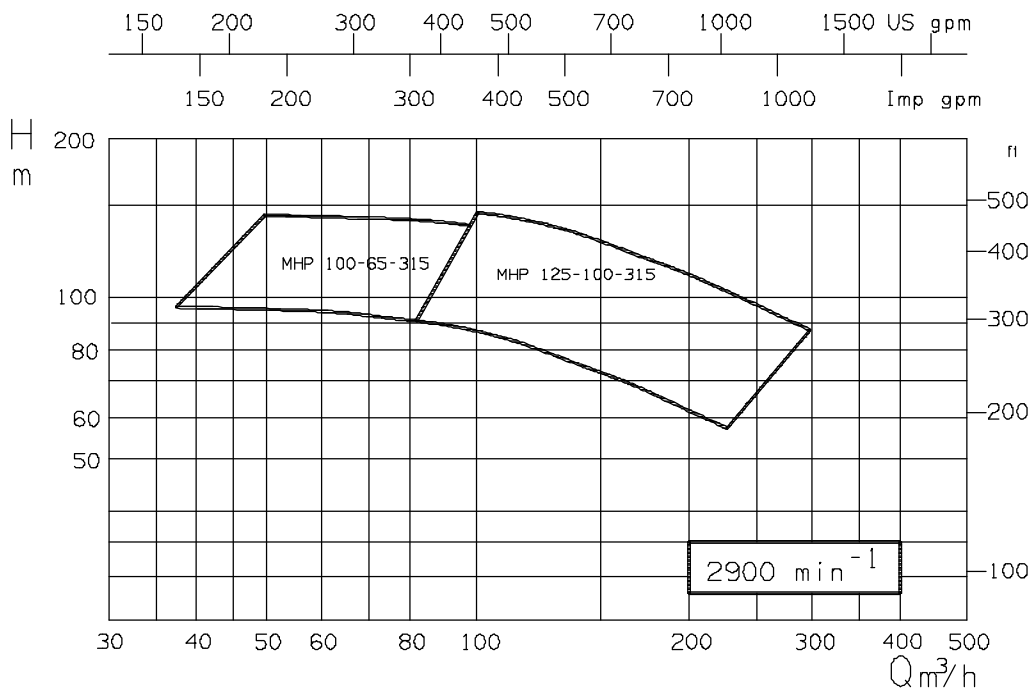

4 INSTALLATION



Equipment operated in hazardous locations must comply with the relevant explosion protection regulations. See section 1.6.4, *Products used in potentially explosive atmospheres*.



All equipment must be grounded.

4.1 Location

The pump should be located to allow room for access, ventilation, maintenance and inspection with ample headroom for lifting and should be as close as practicable to the supply of liquid to be pumped.

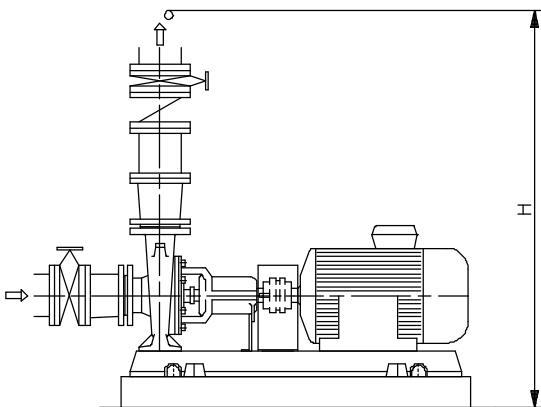

4.2 Foundation



There are many methods of installing pump units to their foundations. The correct method depends on the size of the pump unit, its location and noise vibration limitations. Non-compliance with the provision of correct foundation and installation may lead to failure of the pump and, as such, would be outside the terms of the warranty.

The base plate should be mounted onto a firm foundation, either an appropriate thickness of quality concrete or sturdy steel framework.

It should NOT be distorted or pulled down onto the surface of the foundation, but should be supported to maintain the original alignment.

Anchor bolts must be in accordance with the foot bolt holes. Use anchor bolts of accepted standards and sufficient to ensure a secure fitting in the foundation.

Particularly, this applies to individual plates where the anchor bolts have to withstand the driving torque.

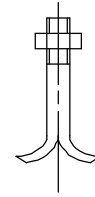

NFE 27 811

Provide sufficient space in the foundation to accommodate the anchor bolts. If necessary, provide concrete risers.

Usually the pump and its drive are mounted on a common base plate. If not, individual base plates underneath each machine foot shall be installed. Base plates are to be fully grouted.

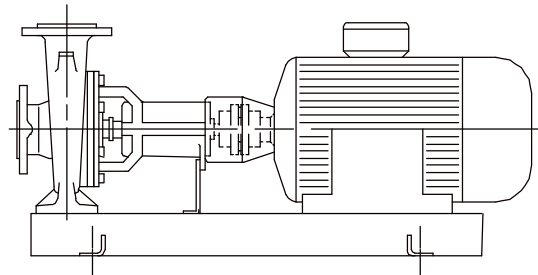

4.2.1 Setting the base plate for anchoring

- Clean the foundation surface thoroughly.
- Put shims on the foundation surface [approx 20-25 mm (0.79-0.98 in.) thick], one on each side of the bolt hole (as an alternative, leveling screws can be used).

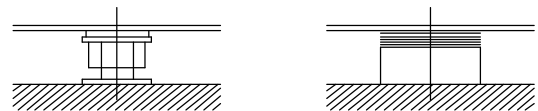

- Lay the base plate and level in both directions with extra shims. The base plate should be level to within 0.5 mm per 1 m (0.02 in. per 3.3 ft).

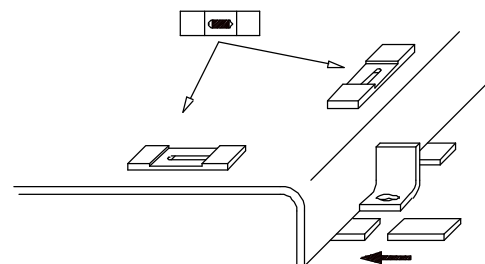

- If anchor bolts have been pre-cast in the foundation slightly tighten the anchor bolts. Otherwise let them hang in the foundation holes.

4.3 Grouting

4.3.1 Base plate grouting

- a) Prepare the site for grouting. Before grouting clean the foundation surface thoroughly and provide external barriers as shown:

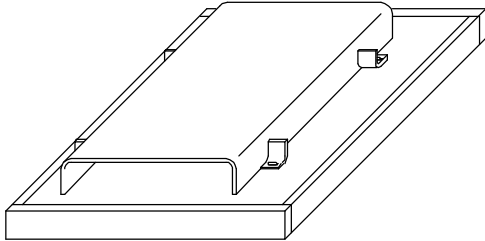

- b) Prepare grouting product (concrete, resin) in accordance with manufacturers' instructions.

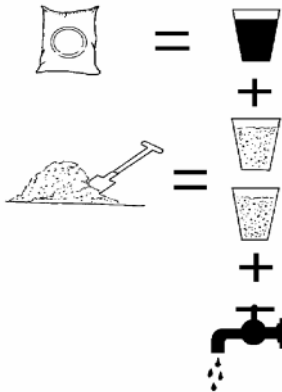

- c) Use grouting products with anti-shrinking components.
 d) To grout up to the required level. Polish surfaces. Take necessary precautions to avoid air bubbles.
 e) Lay-down the barrier, break external angles, and polish the different surfaces.
 f) After grout starts to cure, definitively tighten anchor bolts.
 g) Control the alignment such as described as follows.

4.4 Initial alignment

CAUTION Before connecting the couplings verify the motor rotation direction.

4.4.1 Thermal expansion

CAUTION The pump and motor will normally have to be aligned at ambient temperature and should be corrected to allow for thermal expansion at operating temperature. In pump installations involving high liquid temperatures, the unit should be run at the actual operating temperature, shut down and the alignment checked immediately.

4.4.2 Alignment methods

DANGER Ensure pump and driver are isolated electrically and the half couplings are disconnected. Ensure that the pump pipework, suction and discharge, is disconnected.

CAUTION The alignment **MUST** be checked.

Although the pump will have been aligned at the factory it is most likely that this alignment will have been disturbed during transportation or handling. If necessary, align the motor to the pump, not the pump to the motor.

Alignment

Parallelism and concentricity check:

CAUTION Check the alignment at three or four points, before piping assembly.

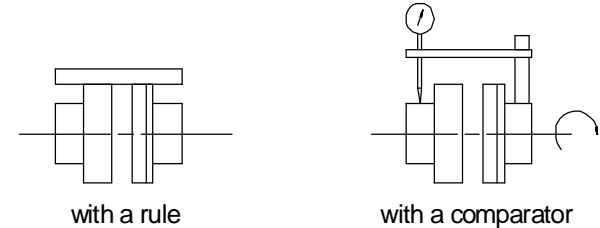

Admissible margin for a motor with roller bearings with European couplings:
 = 0.15 mm parallel checking
 = 0.1 mm angular checking

For US supplied couplings values to be used are:
 = 0.02 in. parallel checking
 = 0.05 in. angular checking

Check the couplings manual for further details.

Angular checking:

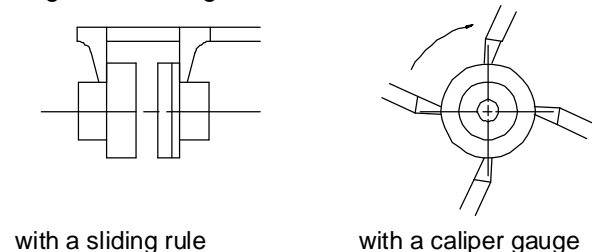

CAUTION The alignment will be definitive only after pipe connection (see § 4.5.4).

If necessary, improve the machine alignment:

→ *Complete unit mounted on common base plate:*
 The machines are first aligned accurately in our workshops. Usually, any misalignment observed on site is due to a wrong adjustment under the base plate (disturbed during transport or because of forces exerted by the piping).

It is only necessary to rectify the adjustment under base plate. If it proves to be insufficient, modify the motor and the piping.

→ Pump and motor mounted on individual base plates:

Machines are (or must be) first mounted on their own base plate in the workshop. Once the pump is set, it will be regarded as the fixed piece. Any alignment necessary shall be carried out on the motor.

DANGER Never connect the electric motor before the setting has been completely finished.

4.5 Piping

Ex The user must verify that the equipment is isolated from any external sources of vibration.

CAUTION Protective covers are fitted to the pipe connections to prevent foreign bodies entering during transportation and installation. Ensure that these covers are removed from the pump before connecting any pipes.

4.5.1 Suction and discharge piping

The dimensions of the pipes do not directly depend on suction and discharge diameters of the pump:

- First, choose a flow speed < 2 m/s (7 ft/s) at suction, and about 3 m/s (10 ft/s) at discharge.
- Take into account the available NPSH, which must be superior to the required NPSH of the pump.

CAUTION Never use pump as a support for piping.

CAUTION Do not mount expansion joints in such a way that their force, due to internal pressure, may act on the pump flange.

Maximum forces and moments allowed on the pump flanges vary with the pump size and type. These external strains may cause misalignment, hot bearings, worn couplings, vibrations and the possible failure of the pump casing.

When designing the pipes (§ 4.5.2.1, § 4.5.2.2, § 4.5.3.1) take necessary precautions in order not to exceed maximum allowed strains.

Forces and moments applied to the pump flanges must never exceed the values shown in the following table:

Pump type	Suction DNA	Discharge DNR	Forces		Moments
	mm (in.)	mm (in.)	Fv max daN (lbf)	Fh max daN (lbf)	Σ Mt max m.daN (lbf.ft)
MHP-TN 100-65-315	100 (4")	65 (2"1/2)	140 (315)	105 (236)	27 (199)
MHP-TN 125-100-315	125 (5")	100 (4")	180 (405)	125 (281)	47 (347)

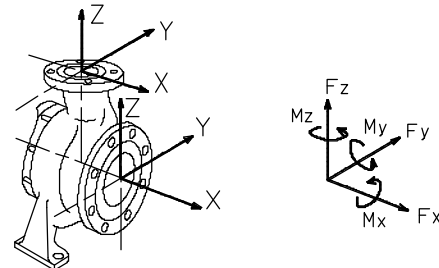

Forces and moments values are applied to the whole flanges and not flange-by-flange. For their sharing out on the pump flanges, refer to standard NFCA 13 931.

CAUTION Ensure piping and fittings are flushed before use.

! Ensure piping for hazardous liquids is arranged to allow pump flushing before removal of the pump.

4.5.2 Suction piping

4.5.2.1 Design of a flooded suction line

The suction line must be as short and direct as possible, never mount an elbow directly on the inlet flange of the pump.

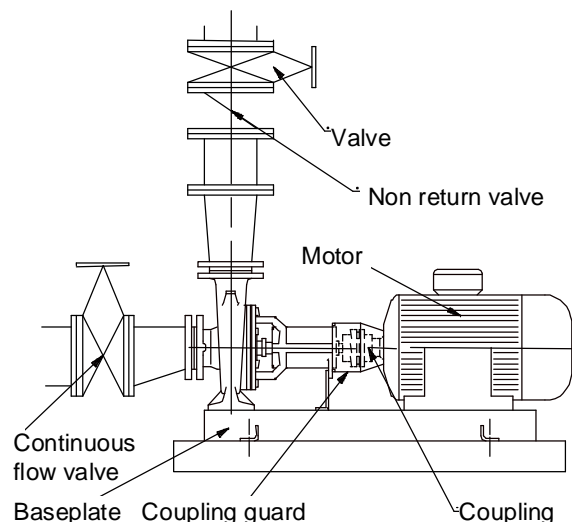

Flooded suction configuration

- Avoid sharp elbows or sudden narrowing. Use convergent ≤ 20° (total angle).
- Arrange the piping so that there are no air pockets (no bulges).

- c) If high points cannot be avoided in suction line, provide them with air relief cocks.
- d) If a strainer is necessary, its net area should be three or four times the area of the suction pipe.
- e) If an inlet valve is necessary, choose a model with direct crossing.

CAUTION Do not tighten flanges before the final check (see § 4.5.4).

4.5.2.2 Design of a suction lift line

The inlet pipe must be as short and as direct as possible, never place an elbow directly on the pump inlet nozzle.

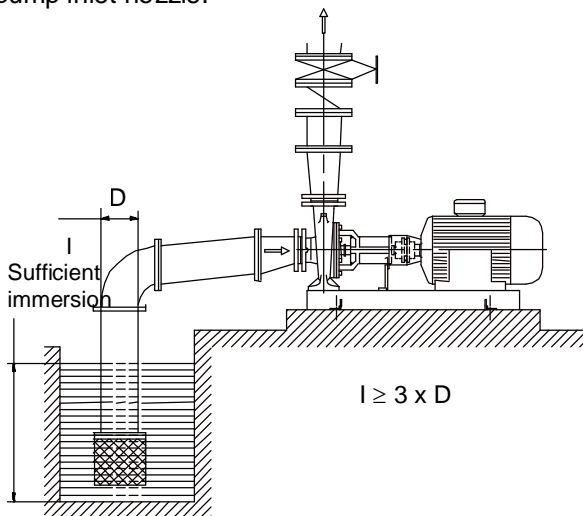

Sump suction configuration

- a) Avoid sharp elbows or sudden narrowing. Use convergent $\leq 20^\circ$ (total angle) with upright generating.
- b) Arrange that the suction piping is inclined upwards towards the pump ensuring that there are no peaks.
- c) If a foot valve is necessary, do not oversize it because it would generate pulsations (valve beating).

CAUTION Do not tighten flanges before the final check (see § 4.5.4).

4.5.3 Discharge piping

4.5.3.1 Design of a discharge line

- a) If discharge line is provided with a divergent, its total angle will be between 7° and 12° .
- b) Install the discharge valve after the non-return valve downstream.

The non-return valve will be set in the discharge pipe to protect the pump from any excessive pressure surge and from reverse rotation.

If necessary, a control manometer (pressure gauge) can be connected on the piping.

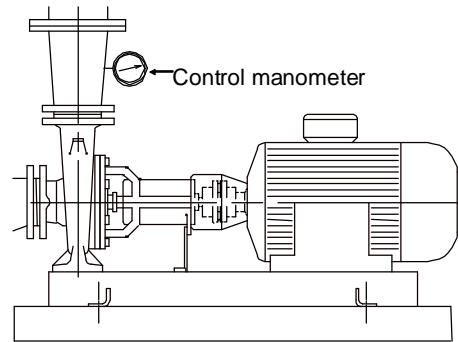

CAUTION Do not tighten flanges before the final check (see § 4.5.4).

4.5.4 Final checks

- a) Check the tightening of anchor bolts. Tighten them if necessary.
- b) Check that protective covers on suction and discharge flanges are removed.
- c) Check that holes of piping flanges are parallel and correspond to those of the pump.
- d) Tighten suction and discharge flanges.

4.6 Electrical connections

DANGER Electrical connections must be made by a qualified Electrician in accordance with relevant local national and international regulations. This includes any grounding.

Ex It is important to be aware of the EUROPEAN DIRECTIVE on potentially explosive areas where compliance with IEC60079-14 is an additional requirement for making electrical connections.

Ex Avoid mechanical, hydraulic or electrical overload by using motor overload trips or a power monitor and make routine vibration monitoring.

! It is important to be aware of the EUROPEAN DIRECTIVE on electromagnetic compatibility when wiring up and installing equipment on site. Attention must be paid to ensure that the techniques used during wiring/installation do not increase electromagnetic emissions or decrease the electromagnetic immunity of the equipment, wiring or any connected devices. If in doubt, contact Flowserve for advice.

DANGER The motor must be wired up in accordance with the motor manufacturer's instructions (normally supplied within the terminal box) including any temperature, earth leakage, current and other protective devices as appropriate.

The identification nameplate should be checked to ensure the power supply is appropriate. A device to provide emergency stopping shall be fitted.

Carry out the ground connections according to the current local regulations.

 To avoid any risk of jamming, the direction of rotation will be checked after priming of the pump (§ 5.3.1, 5.3.2) and before the first start (§ 5.4.2).

4.7 Final shaft alignment check

- Check the alignment pump-motor according to the procedure § 4.4.2. Rectify if necessary by adjusting the motor only.
- Check by hand that the pump turns freely. A binding indicates a distortion of the pump, which is due to excessive pipe strain. If necessary the pipe design must be re-examined.
- If it provided, connect auxiliary pipe systems (hydraulic, pneumatic, sealing system).
- Control tightness and functionality of auxiliary piping.

4.8 Protection systems

 The following protection systems are recommended particularly if the pump is installed in a potentially explosive area or is handling a hazardous liquid. If in doubt consult Flowserve. If there is any possibility of the system allowing the pump to run against a closed valve or below minimum continuous safe flow a protection device should be installed to ensure the temperature of the liquid does not rise to an unsafe level.

If there are any circumstances in which the system can allow the pump to run dry, or start up empty, a power monitor should be fitted to stop the pump or prevent it from being started. This is particularly relevant if the pump is handling a flammable liquid.

If leakage of product from the pump or its associated sealing system can cause a hazard it is recommended that an appropriate leakage detection system is installed.

To prevent excessive surface temperatures at bearings it is recommended that temperature or vibration monitoring are carried out. See sections 5.5.3 and 5.5.4.

If a defect of cooling can lead to temperature higher than those acceptable a system of cooling surveillance must be installed.

Except when explicitly required by the customer in the specifications, when a possibility of reverse rotation exists the customer must install a reverse rotation protection device.

The customer must install all equipment required to avoid water hammer.

5 COMMISSIONING, START-UP, OPERATION AND SHUTDOWN

 *These operations must be carried out by fully qualified personnel.*

5.1 Direction of rotation

 Starting or operating pumps with the wrong direction of rotation can be harmful to the pumps. Ensure that the pump rotation is the same as the arrow on the pump casing. It is preferable to check the direction of rotation before installing the coupling. If not, the pump must be filled in with the liquid before start-up.

 If maintenance work has been carried out to the site's electricity supply, the direction of rotation should be re-checked as above in case the supply phasing has been altered.

5.2 Guarding

 Guarding is supplied fitted to the pump set. If this has been removed or disturbed ensure that all the protective guards around the pump coupling and exposed parts of the shaft are securely fixed.

5.3 Priming and auxiliary supplies

 Where there is any risk of the pump being run against a closed valve generating high liquid and casing external surface temperatures it is recommended that users fit an external surface temperature protection device.

 Ensure all electrical, hydraulic, pneumatic, sealant and lubrication systems (as applicable) are connected and operational.

 Ensure the inlet pipe and pump casing are completely full of liquid before starting continuous duty operation.

These operations must be carried out by personnel with approved qualifications.

5.3.1 Priming of a flooded pump

- As discharge valve is closed, fill the pump by opening the valve at suction. Let air escape by removing the plugs located on the pump.
- The discharge pipe is headed and there is a by-pass valve on the check valve, open slightly the discharge valve and the by-pass of the check valve.
- When the pump is totally free of air bubbles, replace the plugs.

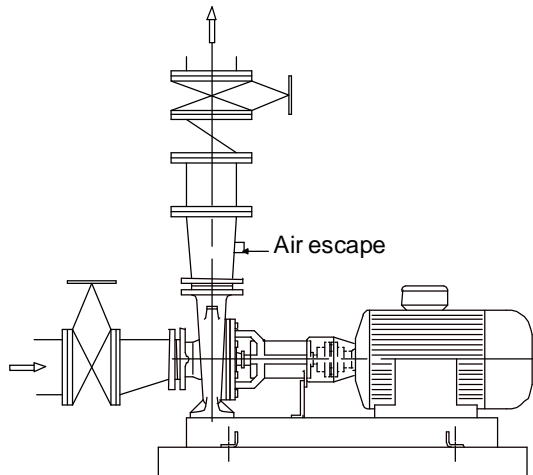

Priming of a flooded pump

5.3.2 Priming of a sump suction pump

* *With foot valve:*

- Fill suction pipe and casing with liquid from an independent source (pressure 1 to 2 bars or 15 to 30 psi).
- Let air escape by removing the plugs located on the pump.
- When the pump is totally free of air bubbles, replace the plugs.

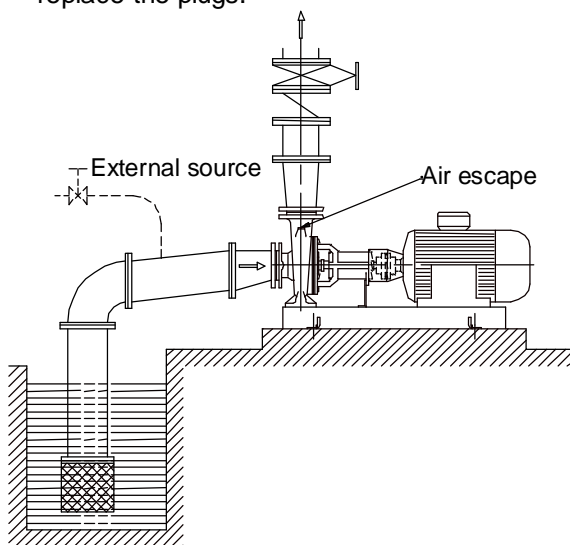

Priming of sump suction pump with foot valve

**Without foot valve:*

Priming may be accomplished by means of venting system.

Note:

Foot valves are not recommended when the pumped liquid has suspended solid particles. They may lodge between foot valve seat and shutter.

5.4 Starting the pump

5.4.1 Bring controls and preparation before the first starting and after each service call

Necessarily:

- Check the tightening of the different plugs.
- Check that the gland lightly tightens the packing rings.
- Risk of seal ring overheating.
- Check the direction of rotation of the motor. Refer to the rotation arrow of the pump.
- Install all protection systems and more particularly the coupling guard and the shield grid (reference [9331]) of the bearing.
- Open all suction valves (if existing).
- Close the outlet valve and the bypass valve.
- Ensure inlet pipe and pump casing are completely full of liquid.

5.4.2 First pump start-up

CAUTION

Suction valves must be fully open when pump is running. Never run the pump dry, it will cause damage.

- Start motor and check outlet pressure.
- If pressure is satisfactory, slowly OPEN outlet valve.
- Do not run the pump with the outlet valve closed for a period longer than 30 seconds.
- If NO pressure, or LOW pressure, STOP the pump. Refer to faultfinding chart for fault diagnosis.

The pump should run smoothly and without vibration.

The pump must never run at a capacity of less than 40 % of that at the best efficiency.



Never remove a plug when the pump is running.

5.5 Running the pump

5.5.1 Venting the pump

 Vent the pump to enable all trapped air to escape taking due care with hot or hazardous liquids.

Under normal operating conditions, after the pump has been fully primed and vented, it should be unnecessary to re-vent the pump.

5.5.2 Pump fitted with a stuffing box

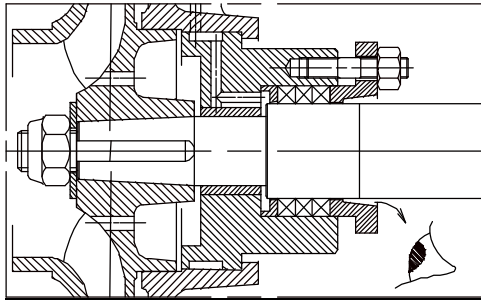

If the pump has a packed gland there must be some leakage from the gland. Gland nuts should initially be finger tight only. Leakage should take place soon after the stuffing box is pressurized. If no leakage takes place the packing will begin to overheat. If overheating takes place the pump should be stopped and allowed to cool before being restarted. When the pump is restarted it should be checked to ensure leakage is taking place at the packed gland.

 When adjusting an operating stuffing box (shield grids removed for this operation), the operator must be very careful. Safety gloves are compulsory and loose clothes are not allowed (above all to the arms) to avoid being caught by the pump shaft.

The pump should be run for ten minutes with steady leakage and the gland nuts tightened by 10 degrees at a time until leakage is reduced to an acceptable level.

The temperature of the gland should be checked after each round of tightening. If the temperature starts to climb rapidly then back off the gland nuts until the temperature drops down. Wait for the temperature to stabilize before tightening again. The leakage must not be reduced below a rate of 20 drops per minute. Bedding in of the packing may take several hours.

 Shield grids being removed during installation of the gland packing, it must be ensured that they are replaced as soon as this operation is completed.

SAFETY INSTRUCTIONS WHEN THE PUMP IS RUNNING:

 If hot or freezing components of the machine can present a danger to operators, they must be shielded to avoid accidental contact. If a 100 % protection is not possible, the machine access must be confined to the maintenance staff only.

 If the temperature is greater than 80 °C (176 °F), a warning plate must be clearly placed on the pump.

 **DANGER** It is strictly forbidden to open switch cupboards, switch boxes, or all other live electric equipment. If it is necessary to open them in order to take readings, to carry out tests or adjustments for example, only a skilled technician may do them with adapted tools. Make sure that physical protection against electrical risks are used.

5.5.3 Bearings

 If the pumps are working in a potentially explosive atmosphere, temperature or vibration monitoring at the bearings is recommended.

If bearing temperatures are to be monitored it is essential that a benchmark temperature is recorded at the commissioning stage and after the bearing temperature has stabilized.

- Record the bearing temperature (t) and the ambient temperature (ta)
- Estimate the likely maximum ambient temperature (tb)
- Set the alarm at $(t+tb-ta+5) \text{ } ^\circ\text{C}$ [$(t+tb-ta+10) \text{ } ^\circ\text{F}$] and the trip at 100 °C (212 °F) for oil lubrication and 105 °C (220 °F) for grease lubrication

It is important, particularly with grease lubrication, to keep a check on bearing temperatures. After start up the temperature rise should be gradual, reaching a maximum after approximately 1.5 to 2 hours. This temperature rise should then remain constant or marginally reduce with time.

5.5.4 Normal vibration levels, alarm and trip

For guidance, pumps generally fall under a classification for rigid support machines within the International rotating machinery standards and the recommended maximum levels below are based on those standards.

 **CAUTION** Alarm and trip values for installed pumps should be based on the actual measurements (N) taken on site on the bearing housings of the pump in the fully commissioned as new condition.

The example (N) value is given for the preferred operating flow region (typically this may extend to 70 to 120 % of the pump best efficiency point); outside the preferred flow region the actual vibration experienced may be multiplied by up to 2.

These standard values can vary with the rotational speed and the power absorbed by the pump. For any special case, do not hesitate to consult us. Measuring vibration at regular intervals will then show any deterioration in pump or system operating conditions.

Vibration Velocity - unfiltered		Horizontal Configuration mm/s (in./s) r.m.s.
Normal	N	≤ 5.6 (0.22)
Alarm	N x 1.25	≤ 7.1 (0.28)
Shutdown Trip	N x 2.0	≤ 11.2 (0.44)

5.5.5 Stop/start frequency

Pump sets are normally suitable for the number of equally spaced stop/starts per hour shown in the table below. Check actual capability of the driver and control/starting system before commissioning.

Motor rating kW (hp)	Maximum stop/starts per hour
Up to 15 (20)	15
Between 15 (20) and 90 (120)	10
90 (120) to 150 (200)	6
Above 150 (200)	Refer

Where duty and standby pumps are installed it is recommended that they are run alternately every week.

5.6 Stopping and shutdown

According to hydraulic conditions of the installation and its automation degree, stop and restart procedures can have different forms. Nevertheless all of them must respect imperatively the following rules:

5.6.1 Stopping < 1 hour

- a) Isolate motor.
- b) Avoid reverse rotation of the pump.
- c) Make sure that the discharge line pressure does not reach the foot valve.

5.6.2 Stopping < 1 month

- a) Isolate motor.
- b) Avoid reverse rotation of the pump.
- c) Make sure that the discharge line pressure does not reach the foot valve.
- d) Close the outlet valve. Eventually close the inlet valve.
- e) Switch off external power supply, flushing/quench, cooling liquid.

5.6.3 Shutdown > 1 month

- a) Isolate motor.
- b) Avoid reverse rotation of the pump.
- c) Make sure that the discharge line pressure does not reach the foot valve.
- d) Close the outlet valve. Eventually close the inlet valve.
- e) Switch off external power supply, flushing/quench, cooling liquid.
- f) Keep the pump fully filled with water. In case of pumped liquid other than water, drain the pump entirely.
- g) Turn once per week the pump shaft of one or two turns.
- h) Never restart the pump without carrying out the verifications recommended before starting (see § 5.4.1).

When ambient temperatures are likely to drop below freezing point, the pump and any cooling and flushing arrangements must be drained or otherwise protected.

5.6.4 Restarting in continuous running

- a) Ensure that the pump is completely full of liquid.
- b) Ensure a continuous supply with a sufficient available NPSH.
- c) Ensure a backpressure so that the motor power is not in excess.

Respect the starting frequency imposed by the motor manufacturer.

Protect the pump against water hammer when stopping or starting.

5.7 Hydraulic, mechanical and electrical duty

This product has been supplied to meet the performance specifications of your purchase order, however it is understood that during the life of the product these may change. The following notes may help the user decide how to evaluate the implications of any change. If in doubt contact your nearest Flowserve office.

5.7.1 Specific gravity (SG)

Pump capacity and total head in meters (feet) do not change with SG, however pressure displayed on a pressure gauge is directly proportional to SG. Power absorbed is also directly proportional to SG. It is therefore important to check that any change in SG will not overload the pump driver or over-pressurize the pump.

5.7.2 Viscosity

For a given flow rate the total head reduces with increased viscosity and increases with reduced viscosity.

Also for a given flow rate the power absorbed increases with increased viscosity, and reduces with reduced viscosity. It is important that checks are made with your nearest Flowserve office if changes in viscosity are planned.

5.7.3 Pump speed

Changing pump speed effects flow, total head, power absorbed, NPSH_R, noise and vibration. Flow varies in direct proportion to pump speed, head varies as speed ratio squared and power varies as speed ratio cubed. The new duty, however, will also be dependent on the system curve.

If increasing the speed, it is important therefore to ensure the maximum pump working pressure is not exceeded, the driver is not overloaded, NPSH_A > NPSH_R, and that noise and vibration are within local requirements and regulations.

5.7.4 Net positive suction head (NPSH_A)

NPSH available (NPSH_A) is the head available at the impeller inlet, above the vapor pressure of the pumped liquid.

NPSH required (NPSH_R) is the minimum head required at the impeller inlet, above the vapor pressure of the pumped liquid, to avoid excessive cavitation and extreme performance degradation.

It is important that NPSH_A > NPSH_R. The margin between NPSH_A > NPSH_R should be as large as possible.

If any change in NPSH_A is proposed, ensure these margins are not significantly eroded. Refer to the pump performance curve to determine exact requirements particularly if flow has changed.

If in doubt please consult your nearest Flowserve office for advice and details of the minimum allowable margin for your application.

5.7.5 Pumped flow

Flow must not fall outside the minimum and maximum continuous safe flow shown on the pump performance curve and or data sheet.

5.8 Pumps for Food Use or Potable Water

If the pump has not been specifically ordered for a food or drinking water application it must not be used for these types of applications. If it has been ordered for this type of application the following recommendations are to be followed.

5.8.1 Cleaning prior to operation

Pumps that are to be used for a food or drinking water application should be cleaned before being put into initial operation and after the installation of spare parts that are in contact with the liquid.

Cleaning once the pump has been commissioned will depend on the application and operating conditions. The user must ensure that the cleaning procedures are suitable for the application and operating conditions, and local regulations.

6 MAINTENANCE

6.1 General



If a belt drive is used, the assembly and tension of the belts must be verified during regular maintenance procedure.



In dirty or dusty environments, regular checks must be made and dirt removed from areas around close clearances, bearing housings and motors.



It is the plant operator's responsibility to ensure that all maintenance, inspection and assembly work is carried out by authorized and qualified personnel who have adequately familiarized themselves with the subject matter by studying this manual in detail (see also section 1.6.2).

Any work on the machine must be performed when it is at a standstill. It is imperative that the procedure for shutting down the machine is followed, as described in section 5.6.

On completion of work all guards and safety devices must be re-installed and made operative again. Before restarting the machine, the relevant instructions listed in section 5, *Commissioning, start up, operation and shut down* must be observed.

Oil and grease leaks may make the ground slippery. Machine maintenance must always begin and finish by cleaning the ground and the exterior of the machine.

If platforms, stairs and guardrails are required for maintenance, they must be placed for easy access to areas where maintenance and inspection are to be carried out. The positioning of these accessories must not limit access or hinder the lifting of the part to be serviced.

When air or compressed inert gas is used in the maintenance process, the operator and anyone in the vicinity must be careful and have the appropriate protection.

Do not spray air or compressed inert gas on skin.

Do not direct an air or gas jet towards other people.

Never use air or compressed inert gas to clean clothes.

Before working on the pump, take measures to prevent an uncontrolled start. Put a warning board on the starting device with the words:

"Machine under repair: do not start".

With electric drive equipment, lock the main switch open and withdraw any fuses. Put a warning board on the fuse box or main switch with the words:

"Machine under repair: do not connect".

Never clean equipment with inflammable solvents or carbon tetrachloride.

Protect yourself against toxic fumes when using cleaning agents.

6.2 Maintenance schedule



It is recommended that a maintenance plan and schedule is adopted, in line with these User Instructions. It should include the following:

- a) The pump must be completely vented and drained and rendered inert before any disassembly operation.
- b) Any auxiliary systems installed must be monitored, if necessary, to ensure they function correctly.
- c) During cleaning of the pump ensure the compatibility between the cleaning products and the gaskets.
- d) Verify the condition of the gaskets.
- e) Gland packings must be adjusted correctly to give visible leakage and concentric alignment of the gland follower to prevent excessive temperature of the packing or follower. Mechanical seals should present no leakage.
- f) Check for any leaks from gaskets and seals. The correct functioning of the shaft seal must be checked regularly.
- g) Check bearing lubricant level, and if the hours run show a lubricant change is required.
- h) Check that the duty condition is in the safe operating range for the pump.
- i) Check vibration, noise level and surface temperature at the bearings to confirm satisfactory operation.
- j) Check the tightness of the connections.

- k) Check dirt and dust is removed from areas around close clearances, bearing housings and motors.
- l) Check coupling alignment and re-align if necessary.
- m) Verify the correct operation of the system.

The equipment used for maintenance and disassembly in an ATEX zone must be in conformity with the requirements zone.

Our specialist service personnel can help with preventative maintenance records and provide condition monitoring for temperature and vibration to identify the onset of potential problems.

If any problems are found the following sequence of actions should take place:

- a) Refer to section 7, *Faults; causes and remedies*, for fault diagnosis.
- b) Ensure equipment complies with the recommendations in this manual.
- c) Contact Flowserve if the problem persists.

6.2.1 Standard maintenance

Roller bearing

The bearing housings are provided with sealed for life ball bearings. No maintenance is required.

6.2.2 Routine inspection (daily/weekly)



The following checks should be made and the appropriate action taken to remedy any deviations:

- a) Check operating behavior. Ensure noise, vibration and bearing temperatures are normal.
- b) Check that there are no abnormal fluid or lubricant leaks (static and dynamic seals) and that any sealant systems (if fitted) are full and operating normally.
- c) Pump fitted with a stuffing box: leakage of 20 drops per minute.
- d) Pump fitted with a mechanical seal: no leakage.
- e) Check the level and condition of oil lubricant. On grease lubricated pumps, check running hours since last recharge of grease or complete grease change.

6.2.3 Periodic inspection (six monthly)



- a) Check foundation bolts for security of attachment and corrosion.
- b) Check pump-running records for hourly usage to determine if bearing lubricant requires changing.
- c) The coupling should be checked for correct alignment and worn driving elements.

Note:

If a check shows a bad running of the motor pump unit, the user must:

- a) Refer to the "fault finding chart" chapter 7 of this leaflet to apply the recommended solutions.
- b) Ensure that your equipment corresponds to the arrangements of this leaflet.
- c) Contact Flowserve after-sales Department if the problem persists.

6.2.4 Gland packing

6.2.4.1 Pump fitted with a packed gland

A well run in and correctly adjusted packing gland requires little maintenance. If, after some time, the leakage becomes too great, the gland should be tightened again in order to return these to a normal level.

If re-tightening is not possible, new packing must be installed.

6.2.4.2 Gland packing inspection and removal

- a) Remove the shield guards.
- b) Slide back the gland.
- c) Remove the packing rings with an extractor designed for this purpose (including the lantern ring if it exists; note its position and its direction of rotation).
- d) Inspect the state of the sleeve surface; the presence of many marked grooves will indicate that it must be replaced.
- e) Carefully clean the different pieces of the packing gland.

6.2.4.3 Gland packing fitting

If the packing is supplied as cord the packing must be cut so that the external diameter is lightly tightened and there is an initial gap between the sleeve and the packing ring.

For that purpose, wind the packing helically around the shaft sleeve or a chuck of the same diameter. (Take precautions to avoid damaging sleeve).

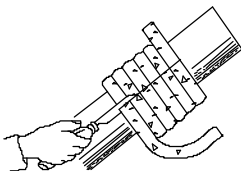

Example of straight cut

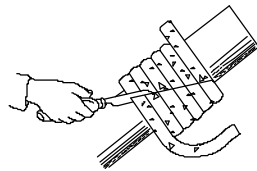

Example of bevel cut



Ensure a tightening on the stuffing box housing and not on the sleeve.

SETTING OF PACKING

Follow the instructions:

- a) Assemble of the packing in S.
- b) Stagger by about 90° between two rings.
- c) Assemble packing after packing.

After setting the last packing ring, secure the packing with the gland and tighten the nut by hand.

After tightening, the shaft should turn by hand as easily as before the setting of the packing.

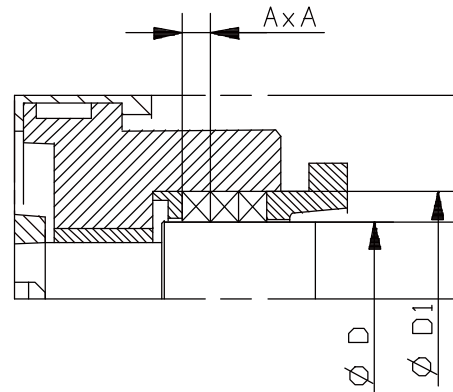

ϕ D	ϕ D1	A x A	Nb x length in mm (in.)
mm (in.)	mm (in.)	mm (in.)	
55 (2.17)	76 (2.99)	10 (0.39)	4 x 207 (4 x 8.15)

6.2.5 Internal coating

If the pump has an internal coating, this coating must be inspected periodically. Any wear or cracks of the coating found must be immediately repaired.

Failure to do this may lead to accelerated wear of the coating during operation and corrosion of the exposed base metal, depending on the material and pumped liquid.

Special attention must be paid to the coating edges. Any loss of coating material is considered to be normal wear and tear on the pump and is not considered as warranty.

Flowserve has applied the coatings according to the supplier's instructions but will not be held responsible for coating wear or cracks that may develop over time.

6.3 Spare parts

6.3.1 Ordering of spares

Flowserve keeps records of all pumps that have been supplied. When ordering spares the following information should be quoted:

- 1) Pump serial number.
- 2) Pump size.
- 3) Part name
- 4) Part number
- 5) Number of parts required.

The pump size and serial number are shown on the pump nameplate.

To ensure continued satisfactory operation, replacement parts to the original design specification should be obtained from Flowserve.

Any change to the original design specification (modification or use of a non-standard part) will invalidate the pump's safety certification.

6.3.2 Storage of spares

Spares should be stored in a clean dry area away from vibration. Inspection and re-treatment of metallic surfaces (if necessary) with preservative is recommended at 6 monthly intervals.

6.4 Recommended spares and consumable items

[1500], [2250], [3011], [4130], [4590-01], [4590-02], [4590-03]

- a) Destroy all the gaskets after dismantling, replace them when reassembling.
- b)  It is recommended that bearings are not reused after any removal from the shaft.
- c) After serving during two years, replace the gland packing.

6.5 Disassembly

 Refer to section 1.6, *Safety*, and section 6 *Maintenance*, before dismantling the pump.

 Before dismantling the pump for overhaul, ensure genuine Flowserve replacement parts are available. Refer to sectional drawings for part numbers and identification.

REPAIR OF THE PUMP



 If the pump presents abnormalities or a persistent malfunction, contact immediately:

FLOWSERVE

After-sales Service

Tel.: 02 43 40 57 57
 (33) 2 43 40 57 57
 Fax.: 02 43 40 58 17
 (33) 2 43 40 58 17

According to the After-sales Service instructions, disassembly will be limited to the dismantling of the pump.

- a)  **DANGER DISCONNECT THE UNIT FROM POWER.**
- b) Close the inlet valve (if fitted) and outlet valve.
- c) Wait for the moment when the pump casing is cooled and at ambient temperature.
- d)  **DRAIN PUMP.**
- e) Dismantle inlet and outlet pipeworks as well as all pipeworks.
- f)  **REMOVE PUMP TAKING INTO ACCOUNT SAFETY (§ 1) AND HANDLING (§ 2.2) PROCEDURES.**

 **ANY DISASSEMBLY, REPAIR OR REASSEMBLY WILL BE CARRIED OUT UNDER FLOWSERVE' RESPONSABILITY, EITHER DIRECTLY BY THE AFTER-SALES SERVICE OR BY OTHER FLOWSERVE-AGENTS WHO WILL GET THE REQUIRED INSTRUCTIONS AND APPROVALS. THIS IS THE CASE OF AUTHORIZED REPAIRERS WHOSE ADDRESSES AND TELEPHONE NUMBERS WILL BE GIVEN ON REQUEST.**

7 FAULTS; CAUSES AND REMEDIES

					Insufficient flow rate	
					Irregular pump running	
					Driver overloaded	
					Mechanical seal leak	
					Equipment vibration	
					Excessive pump casing temperature	
					POSSIBLE CAUSES	
					SOLUTIONS	
●	●			● ●	Pump or suction pipe not completely filled	- Check and complete filling
●	●			●	Air bubbles in pipes	- Check and desecrate the pipes
●				● ●	Suction level too low	- Check: the available NPSH > the required NPSH - Reduce geometrical suction lift - Reduce head losses in pipes and in fittings (diameter increase and appropriate fitting positions) - Check valves and strainers - Check the immersion head of the suction valve
●				●	Wrong rotation	- Reverse 2 phases on motor terminal boxes
●	●	●			The motor is running on 2 phases only	- Check and control the motor electrical power supply
●					Motor running too low	- Check the connection in the terminal box according to the voltage
●				●	Total manometric head system higher than pump differential head	- Check the discharge head - Check the head losses in discharge pipes (partly closed valve, foreign particles, back pressure too high) - Modify the installation or change the pump set
	●			●	Total manometric head system lower than pump differential head	- Throttle at discharge valve or trim the impeller (contact our local agent): CONSULT FLOWSERVE
●				● ●	Pipes (valves, filter...)	- Control, dismantle and clean
				● ●	Insufficient flow rate	- Check the suction and discharge pipes (valves, back pressure)
●					Worn wear-ring surfaces	- Foresee pump mending. CONSULT FLOWSERVE
●	●	●	●		Seizure, jamming	- CONSULT FLOWSERVE
●	●	●	●		Excessive strains on flanges	- Check the flange connections and eliminate strains (pipe positioning or elastic sleeves mounting)
			●		Defective gland packing on the shaft	- Check and replace all the gland-packing parts. - Mechanical seal: CONSULT FLOWSERVE
●	●	●	●		Defective motor bearings	- CONSULT FLOWSERVE
	●			●	Specific gravity or viscosity of liquid too high	- Consult our local agent to analyze the problem
				●	Misalignment	- Check the alignment of the pump and of its driver
				●	Foundations not sufficiently rigid	- Check the setting of base plates: tightening, bad adjustment, seal

					Insufficient pressure	
					Pump loses prime after starting	
					POSSIBLE CAUSES	
					SOLUTIONS	
●					Rotation speed too low (check the driver)	- Check the connection in the terminal box according to the voltage
●	●				Presence of air	- Check and de-aerate
●					Suction pressure insufficient	- Check: the available NPSH > the required NPSH
●					Mechanical defects	- CONSULT FLOWSERVE
●					Air leak in the suction pipe	- Check suction pipe is airtight
●					Restriction in suction pipe	- Check diameter of suction pipe
●					Suction level too low	- Check the NPSH > NPSH - Reduce geometrical suction lift - Reduce head losses in pipes and in fittings (diameter increase and appropriate fitting positions) - Check valves and strainers - Check the immersion head of the suction valve
●					Obstruction of suction pipe	- Check condition of pipe
●					Defective gland packing on the shaft	- Check and replace all the gland packing. - Mechanical seal: CONSULT FLOWSERVE
●					Defective gasket	- CONSULT FLOWSERVE

8 PARTS LIST AND DRAWINGS

8.1 Sectional drawings

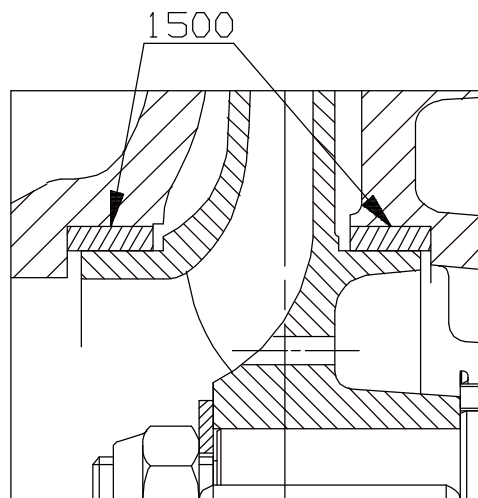
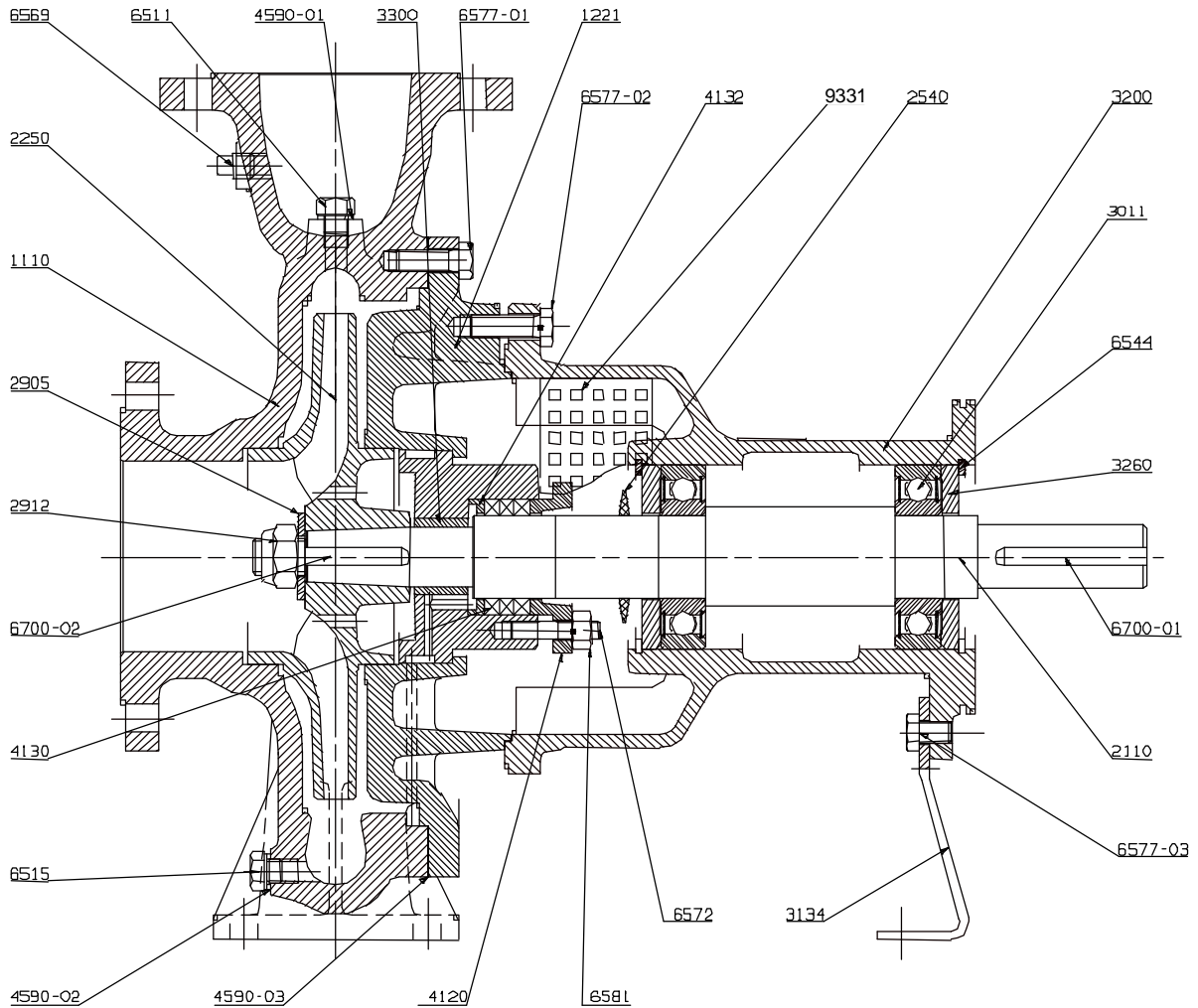

8.2 Sectional drawings part list

ITEM	DESIGNATION
1110	Pump casing
1221	Casing cover with stuffing box
1500	Wear ring
2110	Pump shaft
2250	Radial flow impeller
2450	Shaft sleeve
2540	Thrower
2905	Plain washer
2912	Self-braked nut
3011	Radial ball bearing
3134	Support foot
3200	Bearing housing
3260	Bearing cover
3300	Bearing bush
4120	Gland
4130	Gland packing
4132	Stuffing box neck bush
4590-01	Gasket
4590-02	Gasket
4590-03	Special ring
6511	Priming plug
6515	Drain plug
6544	Bore circlip
6569	Screwed plug
6572	Stud
6577-01	Hexagon bolt
6577-02	Hexagon bolt
6577-03	Hexagon bolt
6581	Hexagon nut
6700-01	Key
6700-02	Key
9331	Cover plate

8.3 General arrangement drawing

The typical general arrangement drawing and any specific drawings required by the contract will be sent to the Purchaser separately unless the contract specifically calls for these to be included into the User Instructions. If required, copies of other drawings sent separately to the Purchaser should be obtained from the Purchaser and retained with these User Instructions.

9 CERTIFICATION

Certificates determined from the Contract requirements are provided with these instructions where applicable. Examples are certificates for CE marking, ATEX marking etc. If required, copies of other certificates sent separately to the Purchaser should be obtained from the Purchaser for retention with these User Instructions.

10 OTHER RELEVANT DOCUMENTATION AND MANUALS

10.1 Supplementary User Instructions

Supplementary instructions such as for a driver, instrumentation, controller, seals, sealant system etc are provided as separate documents in their original format. If further copies of these are required they should be obtained from the supplier for retention with these User Instructions.

10.2 Change notes

If any changes, agreed with Flowserve, are made to the product after its supply, a record of the details should be maintained with these User Instructions.

10.3 Additional sources of information

Reference 1:

NPSH for Rotor dynamic Pumps: a reference guide, Euro pump Guide No. 1, Euro pump & World Pumps, Elsevier Science, United Kingdom, 1999.

Reference 2:

Pumping Manual, 9th edition, T.C. Dickenson, Elsevier Advanced Technology, United Kingdom, 1995.

Reference 3:

Pump Handbook, 2nd edition, Igor J. Karassik et al, McGraw-Hill Inc., New York, 1993.

Reference 4:

ANSI/HI 1.1-1.5, Centrifugal Pumps - Nomenclature, Definitions, Application and Operation.

Reference 5:

ANSI B31.3 - Process Piping.

Your Flowserve factory contacts:

Flowserve Pompes
13, rue Maurice Trintignant
72234 Arnage Cedex, France

Telephone (24 hours): +33 2 43 40 58 47
Sales & Admin: +33 2 43 40 57 57
Repair & Service Fax: +33 2 43 40 58 17

Local Flowserve factory representatives:

North America:

Flowserve Pump Division
5310 Taneytown Pike, PO Box 91
Taneytown, MD 21787-0091, USA

Telephone: +1 (410) 756 2602
Customer Service FAX: +1 (410) 756 2615
Parts inquiry/Order PH: +1 (800) 526 3569

South America:

Flowserve do Brasil Ltda
Av. Don Helder Camara, 5451
20771-001 Rio de Janeiro, Brasil

Telephone: +55-21-2108-4000
Fax: +55-21-2108-4184

To find your local Flowserve representative please use the Sales Support Locator System found at www.flowserve.com

FLOWSERVE REGIONAL SALES OFFICES:

USA and Canada

Flowserve Corporation
5215 North O'Connor Blvd.,
Suite 2300
Irving, Texas 75039-5421 USA
Telephone 1 972 443 6500
Fax 1 972 443 6800

Europe, Middle East, Africa

Worthing S.P.A.
Flowserve Corporation
Via Rossini 90/92
20033 Desio (Milan) Italy
Telephone 39 0362 6121
Fax 39 0362 303396

Latin America and Caribbean

Flowserve Corporation
6840 Wynnwood Lane
Houston, Texas 77008 USA
Telephone 1 713 803 4434
Fax 1 713 803 4497

Asia Pacific

Flowserve Pte. Ltd
200 Pandan Loop #06-03/04
Pantech 21
Singapore 128388
Telephone 65 6775 3003
Fax 65 6779 4607

Free Manuals Download Website

<http://myh66.com>

<http://usermanuals.us>

<http://www.somanuals.com>

<http://www.4manuals.cc>

<http://www.manual-lib.com>

<http://www.404manual.com>

<http://www.luxmanual.com>

<http://aubethermostatmanual.com>

Golf course search by state

<http://golfingnear.com>

Email search by domain

<http://emailbydomain.com>

Auto manuals search

<http://auto.somanuals.com>

TV manuals search

<http://tv.somanuals.com>