



HEWLETT
PACKARD

OPERATING MANUAL

MODEL 3586A/B/C

SELECTIVE LEVEL METER

(Including Options 001, 002, 003, and 004)

This manual applies to instruments with serial number prefixed 1927A, 1928A, and 1929A.

WARNING

To prevent potential fire or shock hazard, do not expose equipment to rain or moisture.

Manual Part No. 03586-90011

Microfiche Part No. 03586-90061

©Copyright Hewlett-Packard Company 1979
P.O. Box 301, Loveland, Colorado, 80537 U.S.A.

Printed: October 1980



CERTIFICATION

Hewlett-Packard Company certifies that this product met its published specifications at the time of shipment from the factory. Hewlett-Packard further certifies that its calibration measurements are traceable to the United States National Bureau of Standards, to the extent allowed by the Bureau's calibration facility, and to the calibration facilities of other International Standards Organization members.

WARRANTY

This Hewlett-Packard product is warranted against defects in material and workmanship for a period of one year from date of shipment [except that in the case of certain components listed in Section I of this manual, the warranty shall be for the specified period] . During the warranty period, Hewlett-Packard Company will, at its option, either repair or replace products which prove to be defective.

For warranty service or repair, this product must be returned to a service facility designated by -hp-. Buyer shall prepay shipping charges to -hp- and -hp- shall pay shipping charges to return the product to Buyer. However, Buyer shall pay all shipping charges, duties, and taxes for products returned to -hp- from another country.

Hewlett-Packard warrants that its software and firmware designated by -hp- for use with an instrument will execute its programming instructions when properly installed on that instrument. Hewlett-Packard does not warrant that the operation of the instrument, or software, or firmware will be uninterrupted or error free.

LIMITATION OF WARRANTY

The foregoing warranty shall not apply to defects resulting from improper or inadequate maintenance by Buyer, Buyer-supplied software or interfacing, unauthorized modification or misuse, operation outside of the environmental specifications for the product, or improper site preparation or maintenance.

NO OTHER WARRANTY IS EXPRESSED OR IMPLIED. HEWLETT-PACKARD SPECIFICALLY DISCLAIMS THE IMPLIED WARRANTIES OF MERCHANTABILITY AND FITNESS FOR A PARTICULAR PURPOSE.

EXCLUSIVE REMEDIES

THE REMEDIES PROVIDED HEREIN ARE BUYER'S SOLE AND EXCLUSIVE REMEDIES. HEWLETT-PACKARD SHALL NOT BE LIABLE FOR ANY DIRECT, INDIRECT, SPECIAL, INCIDENTAL, OR CONSEQUENTIAL DAMAGES, WHETHER BASED ON CONTRACT, TORT, OR ANY OTHER LEGAL THEORY.

ASSISTANCE

Product maintenance agreements and other customer assistance agreements are available for Hewlett-Packard products.

For any assistance, contact your nearest Hewlett-Packard Sales and Service Office. Addresses are provided at the back of this manual.



SAFETY SUMMARY

The following general safety precautions must be observed during all phases of operation, service, and repair of this instrument. Failure to comply with these precautions or with specific warnings elsewhere in this manual violates safety standards of design, manufacture, and intended use of the instrument. Hewlett-Packard Company assumes no liability for the customer's failure to comply with these requirements. This is a Safety Class 1 instrument.

GROUND THE INSTRUMENT

To minimize shock hazard, the instrument chassis and cabinet must be connected to an electrical ground. The instrument is equipped with a three-conductor ac power cable. The power cable must either be plugged into an approved three-contact electrical outlet or used with a three-contact to two-contact adapter with the grounding wire (green) firmly connected to an electrical ground (safety ground) at the power outlet. The power jack and mating plug of the power cable meet International Electrotechnical Commission (IEC) safety standards.

DO NOT OPERATE IN AN EXPLOSIVE ATMOSPHERE

Do not operate the instrument in the presence of flammable gases or fumes. Operation of any electrical instrument in such an environment constitutes a definite safety hazard.

KEEP AWAY FROM LIVE CIRCUITS

Operating personnel must not remove instrument covers. Component replacement and internal adjustments must be made by qualified maintenance personnel. Do not replace components with power cable connected. Under certain conditions, dangerous voltages may exist even with the power cable removed. To avoid injuries, always disconnect power and discharge circuits before touching them.

DO NOT SERVICE OR ADJUST ALONE

Do not attempt internal service or adjustment unless another person, capable of rendering first aid and resuscitation, is present.

DO NOT SUBSTITUTE PARTS OR MODIFY INSTRUMENT

Because of the danger of introducing additional hazards, do not install substitute parts or perform any unauthorized modification to the instrument. Return the instrument to a Hewlett-Packard Sales and Service Office for service and repair to ensure that safety features are maintained.

DANGEROUS PROCEDURE WARNINGS

Warnings, such as the example below, precede potentially dangerous procedures throughout this manual. Instructions contained in the warnings must be followed.

WARNING

Dangerous voltages, capable of causing death, are present in this instrument. Use extreme caution when handling, testing, and adjusting.

SAFETY SYMBOLS

General Definitions of Safety Symbols Used On Equipment or In Manuals.



Instruction manual symbol: the product will be marked with this symbol when it is necessary for the user to refer to the instruction manual in order to protect against damage to the instrument.



Indicates dangerous voltage (terminals fed from the interior by voltage exceeding 1000 volts must be so marked).

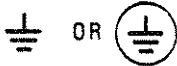

Protective conductor terminal. For protection against electrical shock in case of a fault. Used with field wiring terminals to indicate the terminal which must be connected to ground before operating equipment.



Low-noise or noiseless, clean ground (earth) terminal. Used for a signal common, as well as providing protection against electrical shock in case of a fault. A terminal marked with this symbol must be connected to ground in the manner described in the installation (operating) manual, and before operating the equipment.

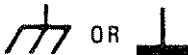

Frame or chassis terminal. A connection to the frame (chassis) of the equipment which normally includes all exposed metal structures.



Alternating current (power line).



Direct current (power line).



Alternating or direct current (power line).

WARNING

The **WARNING** sign denotes a hazard. It calls attention to a procedure, practice, condition or the like, which, if not correctly performed or adhered to, could result in injury or death to personnel.

CAUTION

The **CAUTION** sign denotes a hazard. It calls attention to an operating procedure, practice, condition or the like, which, if not correctly performed or adhered to, could result in damage to or destruction of part or all of the product.

NOTE :

The **NOTE** sign denotes important information. It calls attention to procedure, practice, condition or the like, which is essential to highlight.

SECTION I

GENERAL INFORMATION

1-1. INTRODUCTION.

1-2. This Operating and Service Manual contains information relative to the installation, operation, performance testing, adjustment and maintenance of the Hewlett-Packard Model 3586A/B/C Selective Level Meter. Figure 1-1 shows the Selective Level Meter and the accessories supplied with the instrument.

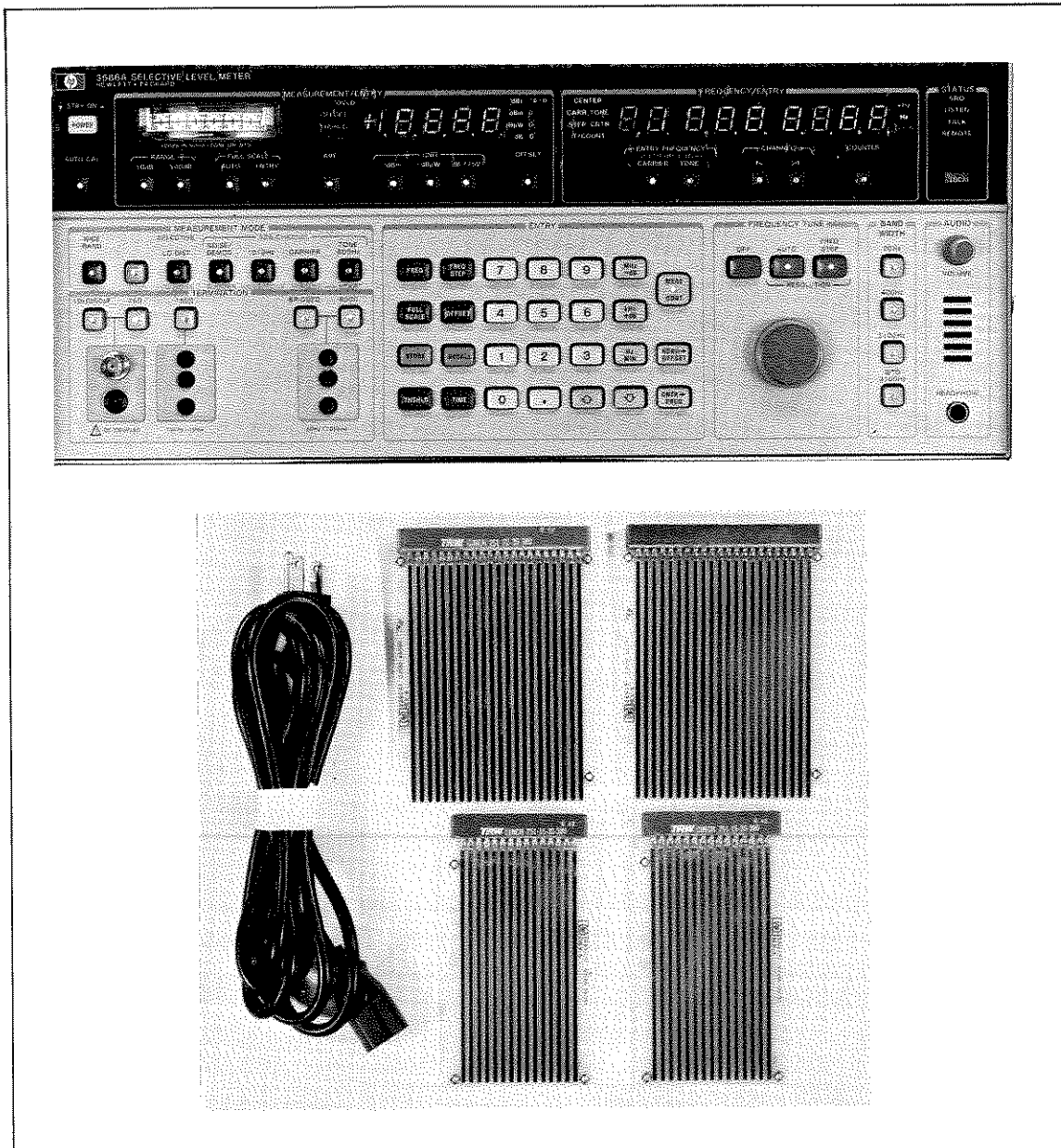

Figure 1-1. -hp- 3586A With Included Accessories.

1-3. Packaged with this instrument is an Operating Manual. This is simply a copy of the first four sections of the Operating and Service Manual. This manual should be kept with the instrument for use by the operator. Additional copies of the Operating Manual or the Operating and Service Manual can be ordered through your nearest Hewlett-Packard Sales and Service Office (a list of these offices is provided at the end of this manual). The part numbers are listed on the title page of this manual.

1-4. Also listed on the title page of this manual following the Operating and Service Manual and Operating Manual part numbers are Microfiche part numbers for these publications. These numbers can be used to order 4 x 6 inch microfilm transparencies of these publications. The Microfiche package includes the latest Manual Changes supplement and all pertinent Service Notes.

1-5. The manual is divided into eight sections, each covering a particular topic for the operating and service of the Selective Level Meter. The topics by section number are:

Section	Topic
I	General Information
II	Installation
III	Operation
IV	Performance Tests
V	Adjustments
VI	Replacement Parts
VII	Backdating
VIII	Service

1-6. This section contains general information about the Model 3586A/B/C Selective Level Meter. This information includes an instrument description, specifications, option and accessory information and instrument and manual identification.

1-7. DESCRIPTION 3586A/B/C.

1-8. The 3586A/B Selective Level Meter is designed for use in the design, manufacture, installation, and maintenance of Frequency Division Multiplex (FDM) systems and for general purpose wave analysis and frequency synthesis. The 3586A is available to meet the needs of C.C.I.T.T. requirements, while the 3586B meets North American (Bell) Standards. The 3586C is a general purpose instrument.

1-9. The 3586A/B provides the ability to make both carrier frequency measurements to 32.5MHz and voice channel measurements from 50Hz to 100kHz.

1-10. The Transmission Impairments Option 003 allows the user to quickly troubleshoot voice channel problems with phase jitter, noise-with-tone, signal-to-noise-with-tone-ratio, and single level impulse noise measurements, all with one instrument. The capability to make all these transmission impairment measurements combined with both FDM voice channel and carrier frequency measurements is available only on the 3586A/B. Standard models include a 1740Hz psophometric or 2000Hz C-message equivalent noise filter, or weighted noise measurements can be made directly with the 3100Hz channel filter and noise weighting filter provided with the Transmission Impairments Option 003. Filter shape factor of < 1.2 provides 60dB carrier and 75dB adjacent channel rejection..

1-11. Synthesizer accuracy and resolution is made possible with a fractional-n synthesized local oscillator. 0.1Hz resolution and $\pm 1 \times 10^{-5}$ /year stability ($\pm 2 \times 10^{-7}$ /year optional) provides the 3586A/B with high resolution tuning. The counter can be used to measure a frequency precisely; then tuned to with one keystroke.

1-12. The 3586A SLM uses an 800Hz tone frequency for entry reference and for 800Hz tone level measurements. A 1010 ± 15 Hz notch for noise with tone and impulse noise, and 1010 ± 50 Hz for phase jitter measurements is used when the Transmission Impairments Option 003 is included. The 3586B SLM uses 1004Hz for all tone and impairments measurements.

1-13. RMS wideband power measurements from +20 to -45dBm can be made from 20kHz to 10MHz with ± 1.0 dB accuracy, and from 200Hz to 32.5MHz with ± 2.0 dB accuracy.

1-14. The frequency of the 3336A/B companion synthesizer will automatically be set to the frequency of the 3586A/B Selective Level Meter when in the tracking mode and with HP-IB inputs connected together.

1-15. HP-IB control is standard, allowing automatic operation to be controlled by a desk top calculator such as the -hp- Model 9825A, 9835A, or by a mainframe computer such as the -hp- 1000.

1-16. The 3586C Selective Level Meter is designed specifically for users needing precise frequency selective measurements such as harmonic level and distortion analysis, line frequency and non-harmonic spurious testing, and production testing of HF radio systems. The 3586C is closely related to the A/B models, with 50, 75 and 600 ohm impedances and a 3100Hz channel filter. The 3586C does not include the Transmission Impairments option, equivalent noise filter or carrier/tone frequency reference entry. BNC connectors are standard except a dual banana connector is used for the 600 ohm input.

1-17. SPECIFICATIONS.

1-18. Table 1-1 is a complete list of the Model 3586A/B/C critical specifications that are controlled by tolerances. Specifications listed in this manual supersede all previous specifications for the Model 3586A/B/C.

1-19. ACCESSORIES SUPPLIED.

1-20. The following is a list of accessories supplied with the Model 3586A/B/C:

	Part Number
Accessory Kit:	03586-84401
This kit consists of:	
(2)Extender Boards	03586-66590
(2)Extender Boards	03586-66591

1-21. ACCESSORIES AVAILABLE.

1-22. The following is a list of -hp- accessories available for use with the Model 3586A/B/C:

Accessory	-hp- Part No.
124 Ω Return Loss Coupler (3586B only)	5061-1136
124 Ω Return Loss Coupler (3586B with opt. 001 only)	5061-1137
150 Ω Return Loss Coupler (3586A only)	5061-1135
Service Spare Parts Kit	Model No. 44486A

1-23. INSTRUMENT AND MANUAL IDENTIFICATION.

1-24. The instrument serial number is located on the rear panel. Hewlett-Packard uses a two-section serial number consisting of a four-digit prefix and a five-digit suffix. A letter between the prefix and suffix identifies the country in which the instrument was manufactured (A = USA, G = West Germany, J = Japan, U = United Kingdom). All correspondence with Hewlett-Packard concerning this instrument should include the complete serial number.

1-25. If the serial number of your instrument is lower than the serial number on the title page of this manual, you must modify your manual for agreement with your instrument. Refer to Section VII, Backdating, for the information that will adapt this manual to your instrument.

1-26. SAFETY CONSIDERATIONS.

1-27. The Selective Level Meter is a Safety Class I instrument and has been designed according to international safety standards. To ensure safe operation and to retain the instrument in a safe condition, the Operating and Service Manual contains information, cautions and warnings which must be adhered to by the user.

1-28. The 3586A/B/C front panel contains a  symbol which is an international symbol meaning "refer to the Operating and Service Manual". The symbol flags important operating instructions located in Section III required to prevent damage to the instrument. To ensure the safety of the operating and maintenance personnel and retain the operating condition of the instrument, these instructions must be adhered to.

1-29. RECOMMENDED TEST EQUIPMENT.

1-30. Equipment required to maintain the Model 3586A/B/C is listed in Table 1-2. Other equipment can be substituted if it meets or exceeds the critical specifications listed in the table.

NOTE

Calibration sheets for -hp- 355D, -hp- 355C, and -hp- 11049A, H01 are obtainable from Hewlett-Packard. Contact your nearest Hewlett-Packard Sales and Service Office for information.

1-31. CONFIGURATIONS OF MODELS AND OPTIONS.

1-32. Table 1-3 contains the configurations of the 3586A/B/C depending on the model and the options.

Table 1-1. 3586A/B/C Performance Specifications.

FREQUENCY				
Frequency Range And Signal Inputs:				
Signal Input	3586A	3586B	3586C	
75Ω/50Ω/10kΩ Unbalanced	50Hz to 32.5MHz			
124Ω Balanced		10kHz to 10MHz		
135Ω Balanced		10kHz to 1MHz		
150Ω Balanced	10kHz to 1MHz			
600Ω/ Bridged	50Hz to 100kHz			

The 124Ω, 135Ω, 150Ω and 600Ω inputs are usable over wider frequency ranges than specified.

Frequency Resolution:
0.1Hz

Center Frequency Accuracy:
 $\pm 1 \times 10^{-5}$ /year, ($\pm 2 \times 10^{-7}$)/year with option 004

Counter Accuracy:
 ± 1.0 Hz in addition to center frequency accuracy for signals within the 60dB bandwidth of the IF filter chosen or greater than -100dBm, (largest signal measured).

Frequency Display:
9 digit LED

SELECTIVITY

3dB Bandwidth, $\pm 10\%$:

3586A (CCITT)		3586B (No. American)		3586C (General)
Standard	Option 003	Standard	Option003	Standard
20Hz	20Hz	20Hz	20Hz	20Hz
400Hz	400Hz	400Hz	400Hz	400Hz
1740Hz*	3100Hz	2000Hz**	3100Hz	3100Hz
-	Psophometric Noise Weighting	-	C-Message Noise Weighting	

* Psophometric Equivalent Noise Weighting Filter.
** C-Message Equivalent Noise Weighting Filter.

Adjacent Channel Rejection:
75dB minimum at ± 2850 Hz, 3100Hz BW; ± 2500 Hz, 2000Hz BW; ± 2350 Hz, 1740Hz BW.

Carrier Rejection:

Bandwidth	60db Points (Max)
3100Hz	± 1850 Hz
2000Hz	± 1500 Hz
1740Hz	± 1350 Hz

400Hz Bandwidth 60dB Rejection:
 ± 1100 Hz

20Hz Bandwidth Rejection:
30dB, ± 45 Hz; 60dB, ± 90 Hz

Table 1-1. 3586A/B/C Performance Specifications (Cont'd).

Passband Flatness:

Bandwidth	Flatness Range	Flatness
3100Hz	± 1000Hz	± 0.3dB
2000Hz	± 650Hz	± 0.3dB
1740Hz	± 550Hz	± 0.3dB
400Hz	± 50Hz	± 0.3dB
20Hz	± 3Hz	± 0.3dB

AMPLITUDE

Measurement Range:
+ 20 to - 130dBm

Amplitude Resolution:
.01dB

Level Accuracy:
10dB auto range, low distortion mode, after calibration (For the 3586C; 75Ω, 50Ω, and 600Ω, inputs; below - 80dBm; these specifications apply only when using the 20Hz and 400Hz bandwidths).

75Ω/50Ω Input (3586A/B/C)

Input Level	+ 20	± .40dB	± .20dB	± .25dB
	- 80dBm	± .95dB		
	- 100dBm	50Hz	20kHz	18MHz
				32.5MHz

124Ω Input (3586B)

Input Level	+ 20dBm	± .50dB	± .35dB	± .50
	- 80dBm	± 1.0dB		
	- 100dBm	10kHz	50kHz	5MHz
				10MHz

150Ω Input (3586A) or 135Ω Input (3586B)

Input Level	+ 20dBm	± .50dB	± .35dB
	- 80dBm	± 1.0dB	
	- 100dBm	10kHz	50kHz
			1MHz

600Ω Input (3586A/B/C)

Input Level	+ 20dBm	± .30dB
	- 80dBm	± .75dB
	- 100dBm	100Hz
		108kHz

Table 1-1. 3586A/B/C Performance Specifications (Cont'd).

dB Below Full Scale		Accuracy Correction
0 to -20dB		± .25dB
-20 to -40dB		± .50dB
-40 to -80dB		± 2.0 dB

Level Accuracy:

100dB Range (after calibration); add correction to 10dB auto range accuracy for dB below full scale. (Not required when in 10dB autorange.)

DYNAMIC RANGE

Spurious Responses:

Image Rejection (100-132MHz):
-80dBc

IF Rejection:
15625Hz, -80dBc; 50MHz, -60dBc

Non-Harmonic Spurious Signals:
> 1600Hz offset; -80dBc
300Hz to 1600Hz offset; -75dBc

Residual Spurious Signals:
≥ 300Hz, -115dBm (-110dBm for a 3586C)
< 300Hz, -100dBm (-95dBm for a 3586C)

Distortion:

Harmonic Distortion:
70dB below full scale (-75dB for the 3586C), >4kHz on 75Ω and 600Ω inputs, Low Distortion Mode.

Intermodulation Distortion:
2nd and 3rd order, in band;
Separation 200Hz to 20kHz, or either tone ≥ 10MHz, 70dB below full scale
Separation 20kHz to 1MHz, and both tones < 10MHz, 75dB below full scale (78dB for the 3586C)

Wideband Power Accuracy:

After calibration, 100dB auto range, averaging on, -45 to +20dBm;

200Hz	± 2.0dB	20KHz	± 1.0dB	10MHz	± 2.0dB	32.5MHz
-------	---------	-------	---------	-------	---------	---------

Noise Floor (Full Scale Setting -35 to -120dBm, AVE On Low Distortion Mode):

Frequency	Input	Bandwidth	Noise Level
100kHz to 32.5MHz	75Ω	1740Hz, 2000Hz, or 3100Hz	-116dBm (-114dBm for a 3586C)
		400Hz or 20Hz	-120dBm
2kHz to 100kHz	75Ω, 600Ω	All	-105dBm
100kHz to 10MHz	124Ω	1740Hz, 2000Hz, or 3100Hz	-116dBm
		400Hz or 20Hz	-120dBm
100kHz to 1MHz	135Ω, 150Ω	1740Hz, 2000Hz, or 3100Hz	-116dBm
		400Hz or 20Hz	-120dBm
10kHz to 100kHz	124Ω, 135Ω, 150Ω	All	-105dBm

The noise floor for full scale settings of -30 to +25dBm will be 80dB below full scale for > 100kHz, or 60dB below full scale for < 100kHz. For the 3586C, these specifications do not apply to the 50Ω input.

Table 1-1. 3586A/B/C Performance Specifications (Cont'd).

SIGNAL INPUTS			
Model	Impedance	Frequency	Mating Connector
3586A	75 ohms unbalanced	50Hz to 32.5MHz	BNC
	150 ohms balanced	10kHz to 1MHz	Siemens 3-prong 9 Rel-GAC
	600 ohms balanced	50Hz to 100kHz	
3586B	75 ohms unbalanced	50Hz to 32.5MHz	WECO 439/440A
	124 ohms balanced	10 kHz to 10MHz	WECO 443A
	135 ohms balanced	10kHz to 1MHz	WECO 241A
	600 ohms balanced	50Hz to 100kHz	WECO 310
3586C	50/75 ohms unbalanced	50Hz to 32.5MHz	BNC
	600 ohms balanced	50Hz to 100kHz	Dual Banana Plug, 0.75 inch spacing

Return Loss:
 - 30dB (600 ohms - 25dB)

Balance:

Input	Frequency	Balance
124Ω	10kHz to 10MHz	- 36dB
135Ω or 150Ω	10kHz to 1MHz	- 36dB
600Ω	50Hz to 108kHz	- 40dB

DEMODULATED AUDIO OUTPUT

Demodulates an erect (USB) or inverted (LSB) SSB telephone channel, provides speaker or headphone output with volume control. Carrier is re-inserted at ± 1850Hz to align channel filter precisely on a voice channel.

Output Level:
 0dBm into 600Ω at full scale, adjustable

Output Connector:
 Front Panel, mates with WECO 347 or 1/4" phone plug

TRACKING GENERATOR:

Level 0dBm at 10kHz, ± .5dB
 Flatness 50Hz to 32MHz, ± .5dB

TRANSMISSION IMPAIRMENTS OPTION 003

Adds transmission impairment measurement capability to standard instrument. Measures phase jitter, noise with tone, single level impulse noise and weighted noise at voice channel and carrier frequencies. 3100Hz channel filter and C-message or psophometric weighted noise filter replaces the standard 2000Hz or 1740Hz equivalent noise filter.

Phase Jitter:

A phase jitter measurement can be made at any input signal frequency up to 32.5MHz that produces a 960-1060Hz tone in the demodulated output. Meets BSP 41009 and CCITT recommendation 0.91.

Demodulated Tone Frequency:	Accuracy:
960 to 1060Hz	± (10% + .5° p-p)
Input Signal Level:	Residual Phase Jitter:
≤ 30dB below full scale, - 65dBm minimum	≤ .5° p-p (50kHz to 32.5MHz)
Frequency Response:	
20 to 300Hz	

Table 1-1. 3586A/B/C Performance Specifications (Cont'd).

Power:
100/120/220/240V, +5%, -10% 48 to 66Hz, 150VA
Weight:
23Kg (50 lbs) net; 30Kg(65 lbs) shipping
Dimensions:
177mm high x 425.5mm wide x 466.7mm deep (7" high x 16.75" wide x 18.38" deep)

Table 1-2. Recommended Test Equipment.

Equipment	Critical Specifications	Application*	Recommended -hp- Model No.
Synthesizer/Level Generator	200Hz - 65MHz, +10dBm - 80dBm, 00.01dB level resolution, frequency stability of less than 1×10^{-7} /year, calibrated attenuator.	P,A,R	3335A opt. 001 (special) K06
Synthesizer/Level Generator	40Hz - 21MHz, +10dBm - 45dBm, frequency stability of less than 5×10^{-6} /year.	P,A,R	3325A
Oscilloscope	100MHz BW	P,A,R	180A/1808A/1821A
Spectrum Analyzer	1kHz - 32.5MHz, 60dB dynamic range.	P	141T/8553B/8552B
	1dB/Div Vertical Scale	A,R	3585A
Digital Multimeter	± 0.1 mV AC accuracy at 0.45V VRMS and 1kHz, $\pm 10\mu$ V DC accuracy at 6mV, $\pm 0.05\Omega$ accuracy at 20 Ω .	P,A,R	3455A opt. 001
RF Voltmeter		R	411A
RF Amplifier	+27dBm output, 15dB gain .5MHz to 32.5MHz.	P,A	Q-Bit, QB-188-2-BNC with case and supply. Available from: Q-Bit P.O. Box 2208 Melbourne, Florida 32901
Signature Analyzer		R	5004A
100kHz Low Pass Filter	≥ 48 dB/Octave Roll-off, 75 Ω input and output.	P	Available from: Allen Avionics 224E. 2nd St. Mineola, NY 11501
10MHz Low Pass Filter	≥ 48 dB/Octave Roll-off, 75 Ω input and output.	P	
Attenuator (Calibrated)	± 0.03 db with Cal. Sheet	P	355D
50 Ω Directional Bridge	≥ 30 dB Return Loss ≥ 40 dB Directivity	P	8721A
75 Ω Directional Bridge	≥ 30 db Return Loss ≥ 40 dB Directivity	P	8721A opt. 008
124 Ω Return Loss Coupler (3586B Standard)		P	Part No. 5061-1136
124 Ω Return Loss Coupler (3586B opt. 001)		P	Part No. 5061-1137
150 Ω Return Loss Coupler		P	Part No. 5061-1135
75 Ω .5V Thermal Converter	Must include Calibration sheet	P	11051A, H07 opt. 002

Table 1-2. Recommended Test Equipment.

Equipment	Critical Specifications	Application*	Recommended -hp- Model No.
50Ω 1V Thermal Converter	Must include Calibration sheet	P	11050A, opt. 002
Frequency Doubler		P	10515A
(2) 50Ω/75Ω Minimum Loss Pads	50Hz to 32.5MHz, 30dB return loss.	P	85428B
75Ω to balanced 124Ω matching pad, consisting of:		P	
10Ω Resistor	1%		0757-0346
20Ω Resistor	1%		0757-0384
121Ω Resistor	1%		0757-0403
68.1Ω Resistor	1%		0757-0397
20Ω Ten-Turn Potentiometer			2100-3315
200Ω Ten-Turn Potentiometer			2100-3095
2kΩ Ten-Turn Potentiometer			2100-3109
1kΩ Ten-Turn Potentiometer			2100-3154
Enclosure	Three (f) BNC, grounded		Pomona 3232
75Ω to Balanced 135Ω matching pad, consisting of:		P	
24.3Ω Resistor	1%		0757-0386
121Ω Resistor	1%		0757-0403
75Ω Resistor	1%		0757-0398
500Ω Ten-Turn Potentiometer			2100-3123
2kΩ Ten-Turn Potentiometer			2100-3109
1kΩ Ten-Turn Potentiometer			2100-3154
Enclosure	Three (f) BNC, grounded		Pomona 3232
75Ω to balanced 600Ω matching pad consisting of:		P	
10Ω Resistor	1%		0757-0346
619Ω Resistor	1%		0757-0418
110Ω Resistor	1%		0757-0402
10Ω Ten-Turn Potentiometer			2100-3164
10kΩ Ten-Turn Potentiometer			2100-3103
500Ω Ten-Turn Potentiometer			2100-3123
Enclosure	Two (f) BNC, grounded		Pomona 3230
75Ω to balanced 150Ω matching pad consisting of:			
10Ω Resistor	1%		0757-0346
36.5Ω Resistor	1%		0757-0390
110Ω Resistor	1%		0757-0402
82.5Ω Resistor	1%		0757-0399
10Ω Ten-Turn Potentiometer			2100-3164
500Ω Ten-Turn Potentiometer			2100-3123
(2) 2kΩ Ten-Turn Potentiometer			2100-3109
Enclosure	Two (f) BNC, isolated		Pomona 3239
Power Combiner Consisting of:	75Ω	P	
(3) 25Ω Resistors	0.1%		0698-8011
Enclosure	Three (f) BNC, grounded		Pomona 3232
124Ω Balance Testing Apparatus, consisting of:		P	
(2) 10Ω Resistors	1%		0757-0346
(2) 62Ω Resistors	0.1%		0698-6800
Enclosure	Three (f) BNC, one (m) BNC, grounded		Pomona 2426
135Ω Balance Testing Apparatus consisting of:		P	
(2) 10Ω Resistors	1%		0757-0346
(2) 67.3Ω Resistors	0.25%		0698-8558
Enclosure	Three (f) BNC, one (m) BNC, grounded		Pomona 2426

Table 1-2. Recommended Test Equipment (Cont'd).

Equipment	Critical Specifications	Application	Recommended -hp- Model No.
600Ω Balance Testing Apparatus consisting of:			
(2) 10Ω Resistors	1%		0757-0346
(2) 300Ω Resistors	0.1%		0698-6346
Enclosure	Three (f) BNC, isolated		Pomona 2102
150Ω Balance Testing Apparatus, consisting of:		P	
(2) 10Ω Resistors	1%		0757-0346
(2) 75Ω Resistors	0.1%		0698-7363
Enclosure	Three (f) BNC, isolated		Pomona 2102 Available from: Pomona Electronics P.O. Box 2767 Pomona, CA 91766
600Ω Feedthrough, consisting of:			
600Ω Resistor	0.1%		0698-7408
Connector	BNC		1250-0052
Connector	BNC		11048-27503
Connector	BNC		1250-0083
Threaded Sleeve	BNC		11048-27604
(3) 75Ω BNC Coaxial Cables	3'	P	11652-60014
(2) 75Ω BNC Coaxial Cables	2'	P	11652-60013
(3) 75Ω BNC Coaxial Cables	1'	P	11652-60012
(3) 50Ω BNC Coaxial Cables	1'	P	11170A
Siemens 3-prong to (m) BNC Cable (must be modified, see Table 4-4) (3586A only)		P,A,R	W & G, k164
Siemens 1.6/5.6mm to (f) BNC Adapter (3586A opt 001 only)		P,A,R	W & G, s230 Available from: W & G Instruments Inc. 119 Naylor Ave. Livingston, NJ 07039
(2) (m) BNC to single Banana jack adapter		P	Pomona 3430-0
(3) Mini-Weco to (f) BNC adapter (3586B standard)		P	1250-0556
(3) Large-Weco to (f) BNC adapter (3586B opt. 001)		P	1250-0591
(2) 1/4" Phone Plug to (f) BNC adapter (3586B)		P	1251-3759
Weco 310 plug to (f) BNC adapter (3586B)		P	1251-3757
Dual Banana to (f) BNC adapter (3586C)		P	1251-2277

Table 1-2. Recommended Test Equipment (Cont'd).

Equipment	Critical Specifications	Application	Recommended -hp- Model No.
(2) BNC "T"	P	1250-0781	
(m) BNC to (m) BNC adapter		P	1250-0216
75Ω Resistor	0.1%	P	0698-7363
50Ω Resistor	0.1%	P	0699-0064

* P-Performance Tests; A-Adjustments; R-Repair.

Table 1-3. -hp- 3586A/B/C Selective Level Meter Configurations.

	3586A (CCITT)	3586B (North American)	3586C (General Purpose)
Impedance:	75Ω Unbalanced 10kΩ 50pf Bridged (600Ω) 150Ω Balanced 600Ω Balanced	75Ω Unbalanced 10kΩ 50pf Bridged (600Ω) 124Ω Balanced 135Ω Balanced 600Ω Balanced	50Ω Unbalanced 75Ω Unbalanced 10kΩ pf(50Ω or 75Ω) Bridged (600Ω) 600Ω Balanced
Connectors:	75Ω, 10kΩ: BNC 150Ω, 600Ω Bridged: Accepts Siemens 3-prong 9 Rel	75Ω, 10kΩ: Accepts Weco 439A or 440A 124Ω: Accepts Weco 443 at 12.7mm (0.5 in) Spacings 135Ω: Accepts Weco 241A, 16mm (.625 in) Spacings 600Ω, 600Ω Bridged: Accepts Weco 310 Plug	50Ω, 75Ω, 10kΩ: BNC 600Ω, 600Ω Bridged: Banana
Bandwidth:	20Hz 400Hz 1740Hz (Psopho Equiv. Noise)	20Hz 400Hz 2000Hz (C-Message Equiv. Noise)	20Hz 400Hz 3100Hz
Option 001	Siemens Connector 75Ω, 10kΩ: Accepts Siemens 1.6/5.6mm	Weco Connectors 75Ω, 10kΩ: Accepts Weco 358A 124Ω: Accepts Weco 372A at 16mm (.625 in) spacing	No Option 001
Option 002	No Option 002	Bandwidth 1740Hz for psophometric wtd. equivalent noise (replaces 2000Hz).	No Option 002
Option 003	Impairment Functions include: impulse noise, phase jitter, Noise/Tone. Also includes: 3100Hz Bandwidth (replaces 1740Hz), and psophometric weighting.	Impairment Functions include: impulse noise, phase jitter, Noise/Tone. Also includes: 3100Hz Bandwidth (replaces 2000Hz), and C-Message weighting.	No Option 003
Option 004	High Stability Frequency Reference	High Stability Frequency Reference	High Stability Frequency Reference

SECTION II

INSTALLATION

2-1. INTRODUCTION.

2-2. This section contains installation instructions for the Model 3586A/B/C Selective Level Meter. These instructions consist of the following specific information:

- Initial Inspection Procedures
- Power and Grounding Requirements
- Environmental Requirements
- Cabinet Mounting and Preparation for Bench Use
- Turn-On Procedures
- How to Mechanically Interface with the HP-IB*
- Repackaging for Shipment

*HP-IB is Hewlett Packard's implementation of IEEE Std. 488-1975, "Standard Digital Interface for Programmable Instrumentation".

2-3. INITIAL INSPECTION.

2-4. This instrument was carefully inspected both mechanically and electrically before shipment. It should be free of marks or scratches and in perfect electrical order upon receipt. To confirm this, carefully inspect the instrument for signs of physical damage incurred in transit, check for supplied accessories (Paragraph 1-19) and, after completing the installation, test the electrical performance using the Performance Test procedures given in Section IV. If there is physical damage, if the contents are incomplete or if the instrument does not pass the Performance Tests, notify the nearest -hp- Sales and Service Office. If the shipping container is damaged or the cushioning material shows signs of stress, notify the carrier as well as the Hewlett-Packard Office. Keep the shipping materials for the carrier's inspection. A list of -hp- Sales and Service Offices is given at the back of this manual.

WARNING

To avoid the possibility of dangerous electrical shock, do not apply ac line power to the -hp- 3586A/B/C if there are signs of shipping damage to any portion of the outer enclosure.

2-5. POWER REQUIREMENTS.

CAUTION

Before applying ac line power to the -hp- 3586A/B/C, be sure that the VOLTAGE SELECTOR switch is set for the proper line voltage and the correct line fuse is installed in the rear-panel line FUSE holder (See Paragraphs 2-24 and 2-25).

2-6. The Model 3586A/B/C requires a single phase ac power source of

86 V to 127 V (48Hz to 66Hz)
or
189 V to 255 V (48Hz to 66Hz).

Maximum power consumption is less than 150 Watts and maximum line current is 2 amperes.

2-7. Power Cables.

2-8. Figure 2-1 illustrates the standard power-plug configurations that are used on -hp- power cables. The -hp- part number directly below each drawing is the part number for a power cable equipped with a power plug of that configuration. The type of power cable that is shipped with each instrument is determined by the country of destination. If the appropriate power cable is not included with your instrument, contact the nearest -hp- Sales and Service Office and the proper cable will be provided. A list of -hp- Sales and Service Offices is given at the back of this manual.

250 V OPERATION	250 V OPERATION	250 V OPERATION	250 V OPERATION	
PLUG*: CEE7-V11 CABLE*: HP 8120-1692	PLUG*: CEE22-V1 CABLE*: HP 8120-1860	PLUG*: DHCR 107 CABLE*: HP 8120-2956	PLUG*: SEV 1011.1959-24507 TYPE 12 CABLE*: HP 8120-2104	
125 V - 6A**	250 V OPERATION	250 V OPERATION	250 V - 6A**	125 V - 6A**
PLUG*: NEMA 1-15P CABLE*: HP 8120-0684	PLUG*: NZSS 198/AS C112 CABLE*: HP 8120-0696	PLUG*: BS 1363A CABLE*: HP 8120-1703	PLUG*: NEMA G-15P CABLE*: HP 8120-0698	PLUG*: NEMA 5-15P CABLE*: HP 8120-1521
STD-B-4195 (Rev.)				
*The number shown for the plug is the industry identifier for the plug only. The number shown for the cable is an HP part number for a complete cable including the plug. **UL listed for use in the United States of America				

Figure 2-1. Power Cables.

2-9. GROUNDING REQUIREMENTS.

2-10. To protect operating personnel, the instrument's panel and cabinet must be grounded. The Model 3586A/B/C is equipped with a three-wire power cord which, when plugged into an appropriate receptacle, grounds the instrument. The offset pin on the power plug is the ground connection.

WARNING

1. The power cable plug must be inserted into a socket outlet provided with a protective earth contact. The protection of the

grounded instrument cabinet must not be negated by the use of an extension cord without a protective ground conductor.

2. If this instrument is to be energized via an auto-transformer to reduce or increase the line voltage, make sure that the common terminal is connected to the earthed pole of the power source.

2-11. ENVIRONMENTAL REQUIREMENTS.

WARNING

To prevent potential electrical or fire hazard, do not expose equipment to rain or moisture.

2-12. Operating Environment.

2-13. In order for the -hp-3586A/B/C to meet the specifications listed in Table 1-1, the operating environment must be within the following limits:

Temperature	0°C to +55°C (+32°F to +131°F)
Relative Humidity	≤ 95%
Altitude	≤ 4600 metres (15,000 ft)
Magnetic Field Strength	≤ 0.1 gauss

2-14. Cooling System. The -hp-3586A/B/C uses a forced-air cooling system to maintain the proper internal operating temperature. The cooling fan is located on the rear panel. Air, drawn through the rear-panel fan filter, is circulated through the instrument and exhausted through holes in the left side panel. The instrument should be mounted to permit as much air circulation as possible, with at least one inch of clearance at the rear and on each side. The filter for the cooling fan should be removed and cleaned at least once every 30 days. To clean the fan filter, simply flush it with soapy water, rinse and then air dry.

2-15. Thermal Cutout. The -hp-3586A/B/C has a thermal cutout switch mounted on a bracket along with the power supply pass elements. The pass elements are normally the hottest components in the entire instrument. Whenever the temperature of the thermal cutout switch reaches about +100°C, the line voltage is internally disconnected from the instrument. The switch resets automatically when the instrument cools. If a thermal cutout occurs, check for fan stoppage, clogged fan ports and other conditions that could obstruct air flow or cause excessive heating.

2-16. Storage and Shipping Environment.

2-17. The -hp-3586A/B/C should be stored in a clean, dry environment. The following environmental limitations apply to both storage and shipment:

Temperature	-40°C to +75°C (-40°F to +158°F)
Relative Humidity	≤ 95%
Altitude	≤ 15,300 metres (50,000 ft.)

In high-humidity environments, the instrument must be protected from temperature variations that could cause internal condensation.

2-18. PREPARATION FOR USE

2-19. Mounting

2-20. Bench Mounting The -hp- 3586A/B/C has plastic feet attached to the bottom panel. The plastic feet are shaped to make full-width modular instruments self-align when they are stacked. Foldaway tilt stands are built into the front feet for convenient bench use. The tilt stand raises the front of the instrument for easier viewing of the control panel. A front handle kit, -hp- Part No. 5061-0090 (Option 907), can be installed for ease of handling the instrument on the bench (see Figure 2-2). The kit is shipped with the instrument if Option 907 is ordered. It is also available separately by its -hp- part number. The instructions for installing the front handles are included in the kit.

2-21. Rack Mounting. The -hp-3586A/B can be mounted in an EIA standard width cabinet of 19 inches. A Rack Mount Flange Kit or a Rack Flange and Front Handle Combination Kit (see Figure 2-2) extends the width of the instrument to 19 inches and provides holes so that the instrument can be fastened to the cabinet. A Standard Slide Kit or Instrument Support Rails (see Figure 2-2) *must* be used in addition to the flanges to support the weight of the instrument when it is rack mounted. The Standard Slide Kit permits the instrument to slide in and out of the cabinet like a drawer once the holding screws are removed from the flanges. A Standard Tilt Slide Kit is also available. In addition to the drawer-like action of the standard kit, the tilt kit permits the instrument to be tilted 90° in either direction after it is extended. A Slide Adapter Bracket is available to adapt the Standard Slide Kit for use in non-HP rack system enclosures.

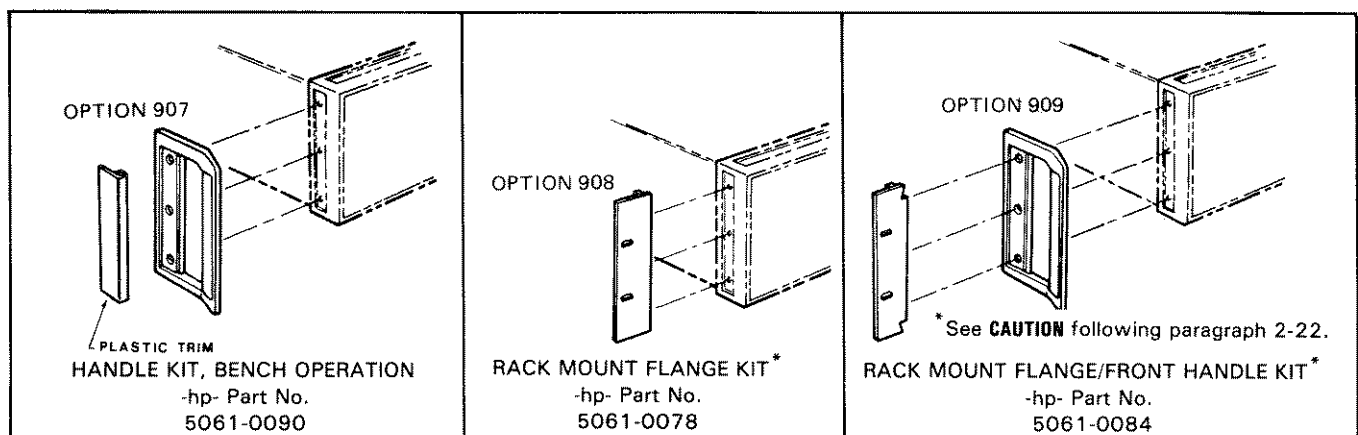
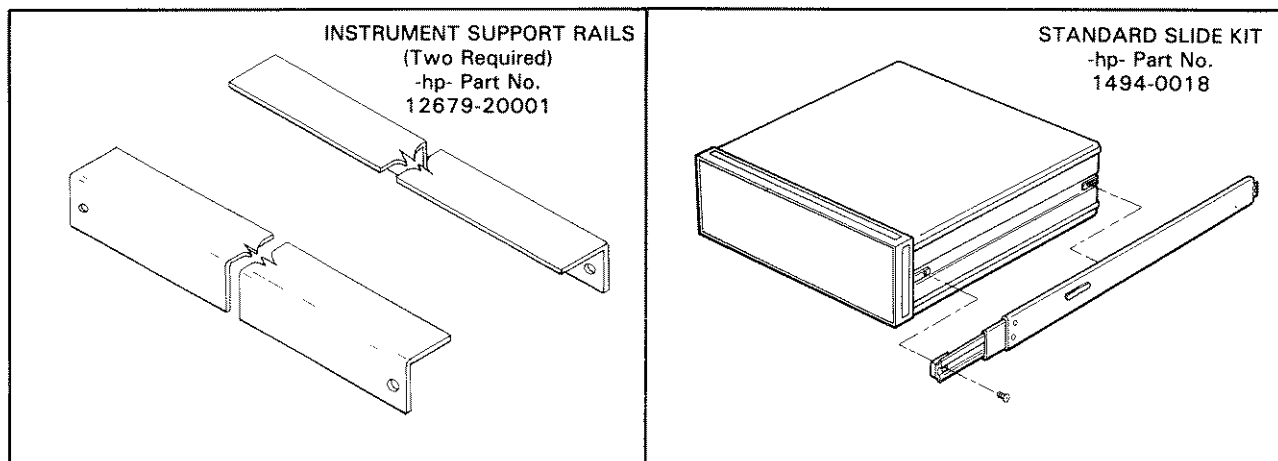

Figure 2-2. Rack Mount Hardware and Handle Kits.

2-22. All of the information required to order any of the rack mounting hardware is summarized in Table 2-1. The Rack Flange kit and the Rack Flange Front Handle Combination Kit are shipped with the instrument when ordered by their option number at the same time the instrument is ordered. The installation instructions for all rack mounting hardware are supplied with each kit.

CAUTION

The weight of the -hp-3586A/B/C must be supported by Instrument Support Rails or Slide Brackets when the instrument is mounted in a rack. DO NOT, under any circumstances, attempt to rack mount the -hp-3586A/B using only the front flanges.

Table 2-1. -hp- 3586A/B/C Rack Mounting Hardware.

Description	Option	-hp- Part Number
Rack Flange Kit	908	5061-0078
Rack Flange and Front Handle Combination Kit	909	5061-0084
Standard Slide Kit	—	1494-0018
Standard Tilt Slide Kit	—	1494-0025
Slide Adaptor Bracket	—	1494-0023
Instrument Support Rails	Accessory No. 12679B	

2-23. Initial Instrument Turn On.

CAUTION

Before applying ac line power to the -hp-3586A/B/C, be sure that the VOLTAGE SELECTOR switch is set for the proper line voltage and the correct line fuse is installed in the rear panel line FUSE holder (See paragraphs 2-24 and 2-25).

2-24. Line Voltage Selection Voltage selection switches on the rear panel are used to configure the instrument to operate on one of four input line voltage ranges. The range of input voltages for each configuration of the switches is illustrated in Figure 2-3. Set the switches to conform with the line voltage to be used with this instrument. The switch positions for each input voltage range are indicated on the rear panel and more explicitly in Figure 2-4.

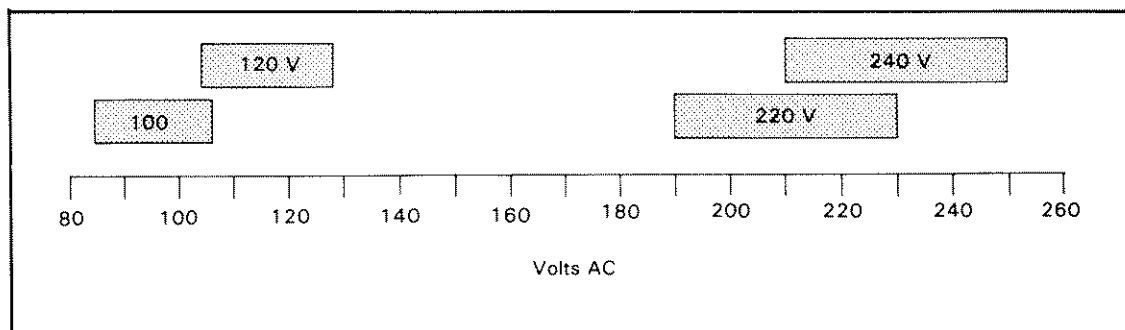

Figure 2-3. Input Range For Each Line Voltage Switch Selection.

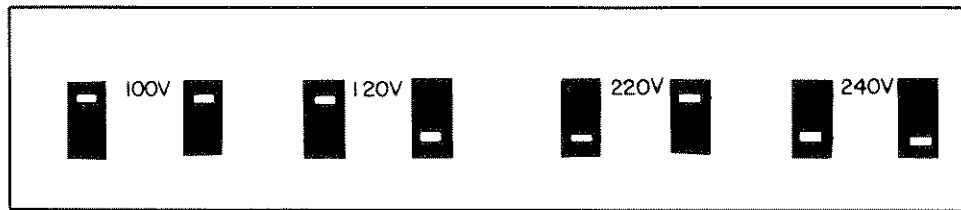

Figure 2-4. Switch Positions For Line Voltage Selection.

2-25. Fuse Selection. Verify that the line fuse selection corresponds to the input voltage range selection (see Table 2-2).

Table 2-2. Line Fuses.

Voltage Selector	Fuse Type	-hp- Part No.
100 V or 120 V	2 A, 250 V Fast BLO	2110-0002
220 V or 240 V	1 A, 250 V Fast BLO	2110-0001

2-26. Power Line Connection. With the front panel OFF/ON control OFF (out), connect the ac power cord to the rear panel LINE connector. Plug the other end of the power cord into a three terminal *grounded* power outlet.

WARNING

To protect operating personnel, the -hp-3586A/B/C chassis and cabinet must be grounded. The -hp-3586A/B/C is equipped with a three-wire power cord which, when plugged into an appropriate receptacle, grounds the instrument. The offset pin on the power plug is the ground connection. To preserve this protection feature, the power plug shall only be inserted in a three-terminal receptacle having a protective earth ground contact. The protective action must not be negated by the use of an extension cord or adapter that does not have the required earth ground connection. Grounding one conductor of a two-conductor outlet is not sufficient protection.

2-27. Reference Frequency Connection. An external frequency reference can be used to improve the frequency accuracy and stability of the -hp-3586A/B/C tuning. The external frequency reference must be 10 MHz or an integral submultiple of 10 MHz that is not less than 1 MHz (e.g. 5MHz, 2MHz, 1MHz). The amplitude of the external frequency reference signal must be at least -10 dBm. Connect the reference signal to the EXT REF INPUT 10 MHz ÷ N connector on the rear panel. If the reference signal source is an internal 10 MHz Crystal Oven (Optional 004), the 10 MHz Oven output on the rear panel should be connected to the EXT REF INPUT 10 MHz ÷ N input using the BNC to BNC adaptor packed with the accessories (see Figure 1-1).

NOTE

Valid measurements can be made while the -hp-3586A/B/C is unlocked from the external frequency reference. Only the ease of tuning and the accuracy of the counted frequency display will be affected.

2-28. Turn On Conditions. The -hp-3586A/B/C can now be turned on. All annunciators and displays will light and remain lit for approximately three seconds after turn on. At that time, the Frequency/Entry display will change to 1 000 000 Hz and all annunciators, except those indicated in Figure 2-5, will go out. Very soon after these changes, level readings will begin to appear in the Amplitude/Entry display. Check to be sure the fan, located on the rear panel, is operating. If the turn on sequence is incorrect, if the fan is not operating or if the initial operating conditions are different from those illustrated in Figure 2-5, turn off the instrument and contact the nearest -hp- Sales and Service Office or a qualified service technician. A list of -hp- Sales and Service Offices is given at the back of this manual.

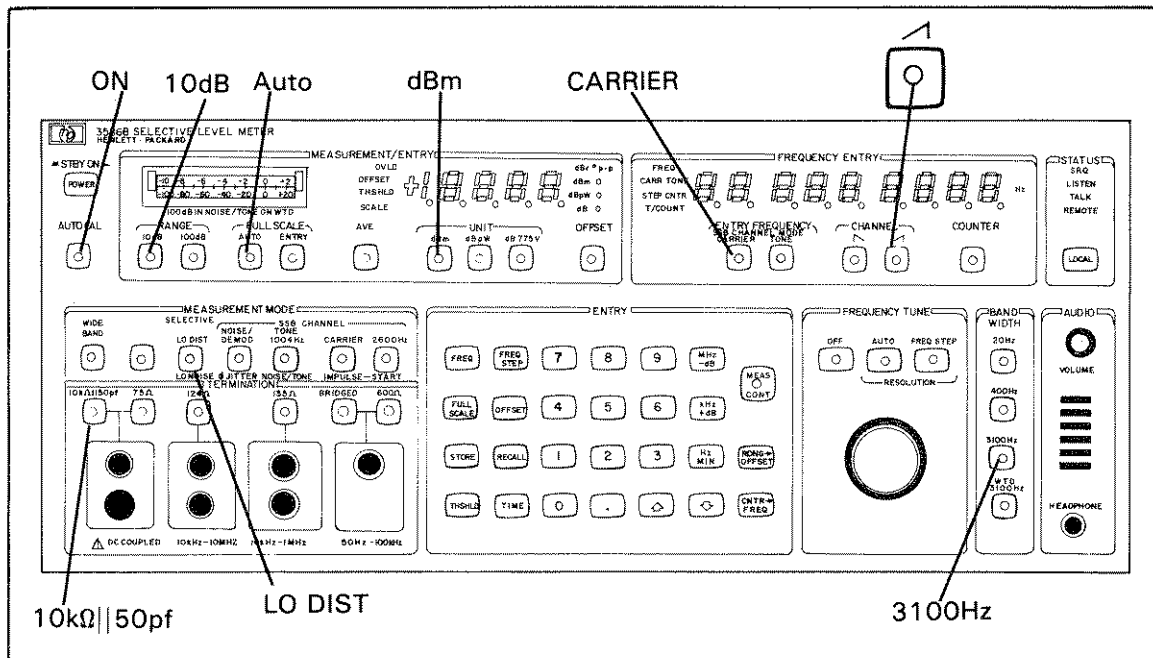

Figure 2-5. Turn-On Conditions.

2-29. HP-IB CONNECTIONS*.

02-30. The HP-IB connector on the rear of the -hp-3586A/B/C (Figure 2-6) is compatible with any -hp-10631 HP-IB interconnecting cable (see Table 2-3). The HP-IB cables have "piggyback" connectors on both ends that are identical to the standard HP-IB connector on the rear of the -hp-3586A/B/C. As a result of this design, several cables can be connected to a single source without special adaptors or switch boxes. Up to fourteen devices (including the controller) can be interconnected in a single system and the devices can be interconnected in virtually any configuration desired. There must, of course, be a path from the calculator (or other controller) to every device operating on the bus. As a practical matter, avoid stacking more than three or four cables on any one connector. If the stack gets too long, the force on the stack can produce sufficient leverage to damage the connector mounting. Be sure that each connector is firmly screwed in place to keep it from working loose (see CAUTION in Figure 2-6).

*Hewlett-Packard Interface Bus (HP-IB) is -hp-'s implementation of IEE Standard 488-1975, "Digital Interface for Programmable Instrumentation".

2-31. Cable Length Restrictions. To achieve design performance with the HP-IB, proper voltage levels and timing relationships must be maintained. If the system cables are too long, the lines cannot be driven properly and, consequently, the system will fail to perform. When interconnecting an HP-IB system, observe the following rules:

- a. The total cable length for the system must be less than or equal to 20 metres (65 feet).
- b. The total cable length for the system must be less than or equal to 2 metres (6 feet) times the total number of devices connected to the bus.

Table 2-3. -hp- 10631 HP-IB Interconnecting Cables.

-hp- 10631 HP-IB Cable	Length
A	1 Metre (3.3 ft.)
B	2 Metres (6.6 ft.)
C	4 Metres (13.2 ft.)
D	0.5 Metres (1.6 ft.)

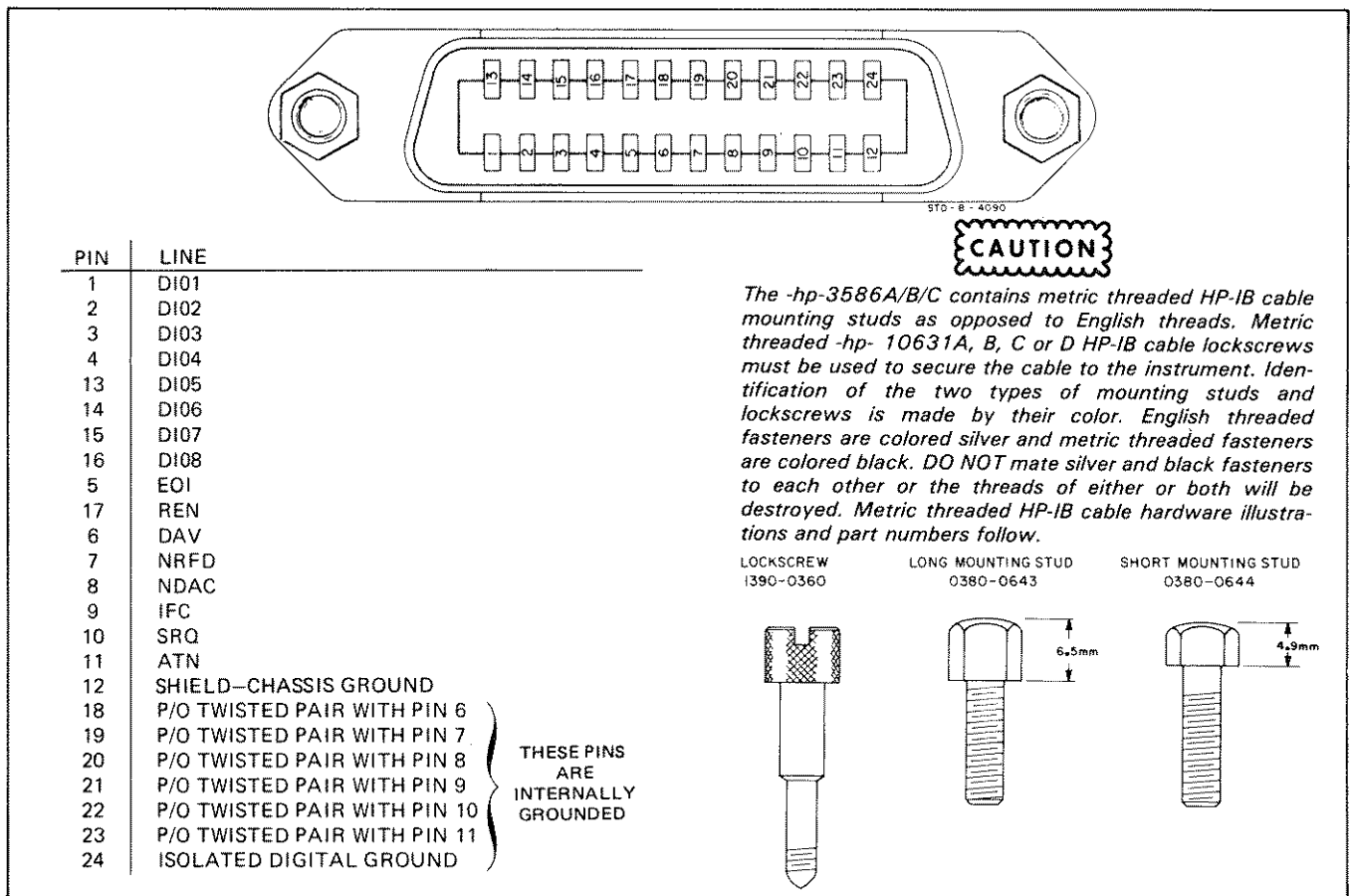

Figure 2-6. HP-IB Connector.

2-32. HP-IB Address Selection. The -hp-3586A/B/C is shipped from the factory with an ASCII listen address of 0 (zero) and a talk address of "P". These addresses correspond to a Select Code of sixteen. If another device with the same select code is used in the system, either its select code or that of the -hp-3586A/B/C must be changed. Changing the select code of the -hp-3586A/B/C is accomplished using the DIP switches on the rear panel (see Figure 2-7).

NORM/TEST - Instrument should always be operated with this switch in the NORM position. The instrument will not function properly in the TEST mode.

REM/TRK - In the REMOTE position, this switch enables the instrument to be remotely controlled via the HP-IB. In the TRK position, the instrument can control a separate tracking generator via the HP-IB.

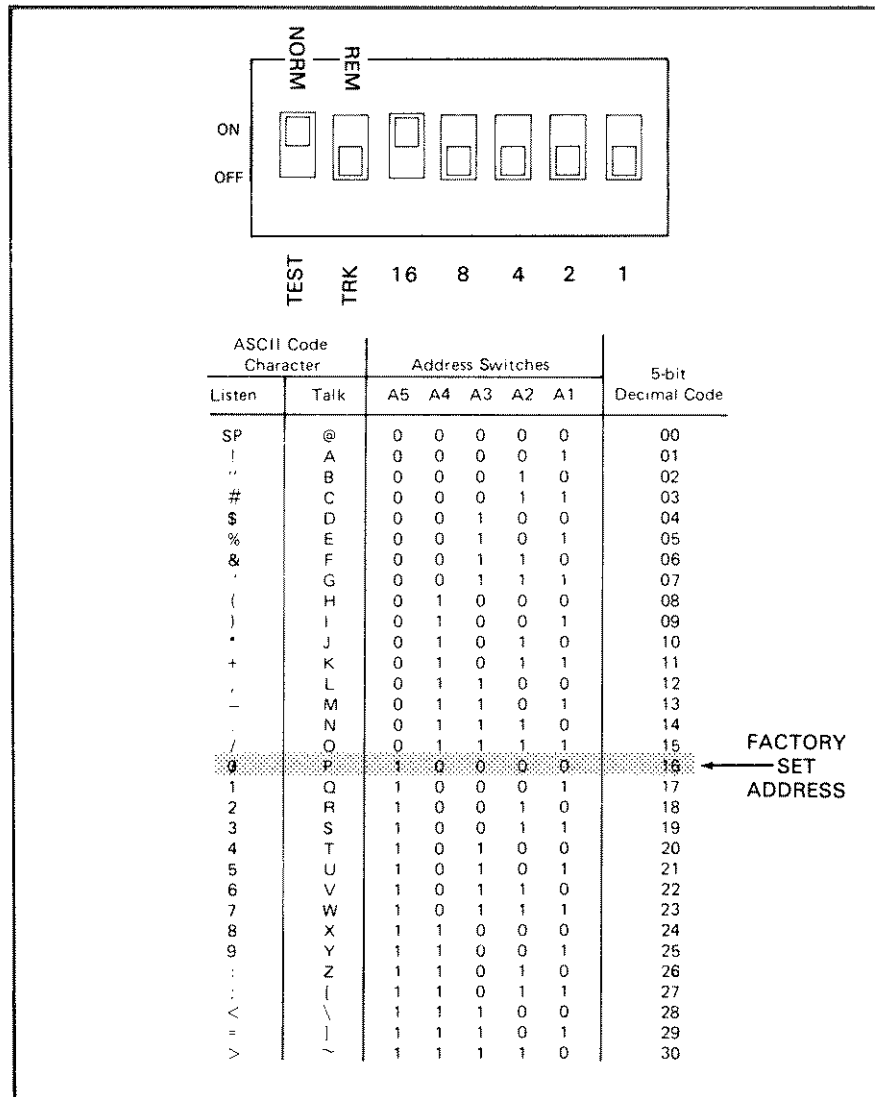

Figure 2-7. Address Selection.

2-33. REPACKAGING FOR SHIPMENT.

NOTE

If the instrument is to be returned to -hp- for service, attach a tag indicating the type of service required. Include any symptoms or details that may be of help to the service technician. Also include your return address, the instrument's model number and full serial number. In any correspondence, identify the instrument by model number and full serial number.

2-34. Original Packaging.

2-35. The instrument should be repackaged using the original shipping container and packing materials if they are available and in good condition. If they are not available or suitable for reuse, it is best to use equivalent containers and packing materials which can be obtained through -hp- Sales and Service Offices. A list of -hp- Sales and Service Offices is given at the back of this manual. If the original shipping materials are used, repack the instrument in the same manner it was packed when received. If other -hp- materials are used, be sure to allow 3 to 4 inches of packing material on all sides of the instrument and seal the container with strong tape or metal bands. Also mark the container "FRAGILE" to insure careful handling.

2-36. Other Packaging.

2-37. The following general instructions should be used for repackaging with commercially-available materials:

- a. Wrap the instrument in heavy paper or plastic.
- b. Use a strong shipping container. A doublewall carton made of 250-pound test material is adequate.
- c. Use enough shock-absorbing material (3-to-4 inch layer) around all sides of the instrument to provide firm cushion and prevent movement inside the container. Protect the control panel with cardboard.
- d. Seal the shipping container securely.
- e. Mark the shipping container FRAGILE to assure careful handling.

SECTION III

OPERATING INSTRUCTIONS

3-0-1. INTRODUCTION.

3-0-2. This section contains complete operating and programming instructions for the Hewlett-Packard Model 3586A/B/C Selective Level Meter.

3-0-3. The operating information in this section is divided into eleven chapters. Except for Chapters One and Eleven, each chapter corresponds to a measurement mode or a group of very similar measurement modes. Chapter One contains general operating information that is applicable to every mode. The chapters describing individual measurement modes are practically "mini" manuals. By following the information in these chapters sequentially, the instrument can be configured to measure any signal it is capable of measuring. Chapter Two describes the Selective Measurement modes. The Selective Measurement modes are used in general purpose selective measurements. All variations of selective measurements possible with this instrument are described exhaustively in this chapter. The other chapters describing individual measurement modes present the information needed for *typical* measurements in a particular mode. Most of these are telecommunications measurement modes and so the signal being measured is well understood. Variations from typical measurements are obtained through cross references to Chapter Two. Chapter Eleven describes how to operate the instrument over the HP-IB. It is assumed in this chapter that the operator is familiar with front panel operation of the instrument.

3-0-4. Contents.

Chapter	
1	General Operating Information
2	Selective
3	Wideband
4	Carrier
5	Noise/Demod
6	1010Hz, Tone 800Hz, Tone 1004Hz, 2600Hz
7	ϕ Jitter
8	Noise/Tone
9	Impulse
10	Network Analysis
11	HP-IB

3-0-5. Using This Section. Most operators use an operating manual only as a reference. Few, if any, read it sequentially from cover to cover. With this thought in mind, this operating section was designed so that specific information could be located quickly and with a minimum of searching. Some of the characteristics that contribute to this feature are 1) separate chapters for each measurement mode, 2) an identical format for each chapter where possible and 3) redundant information in the chapters to avoid frequent cross referencing. The redundancy can be burdensome if you are trying to read the section sequentially. Feel free to skip over those paragraphs that sound familiar.

CHAPTER ONE GENERAL OPERATING INFORMATION

3-1-1. This chapter consists of general operating information, an Operator's Check and Operator's Maintenance. The operating information consists of those aspects of the operation applicable to every measurement mode and the functional description of each control given in the Front and Rear Panel pictorial (Figure 3-1-1). The following is an index of the primary topics covered in this chapter:

Paragraph	
Front and Rear Panel Features.....	3-1-2
Turn On.....	3-1-4
Error Messages.....	3-1-6
Store/Recall of Front Panel Configurations.....	3-1-9
Operator's Check.....	3-1-11
Tracking Generator Operation.....	3-1-15
AUTOMATIC CALibration.....	3-1-17
Operator's Maintenance.....	3-1-20

3-1-2. Front and Rear Panel Pictorials.

3-1-3. The functions of the front and rear panel controls, indicators and connectors are described in Figure 3-1-1.

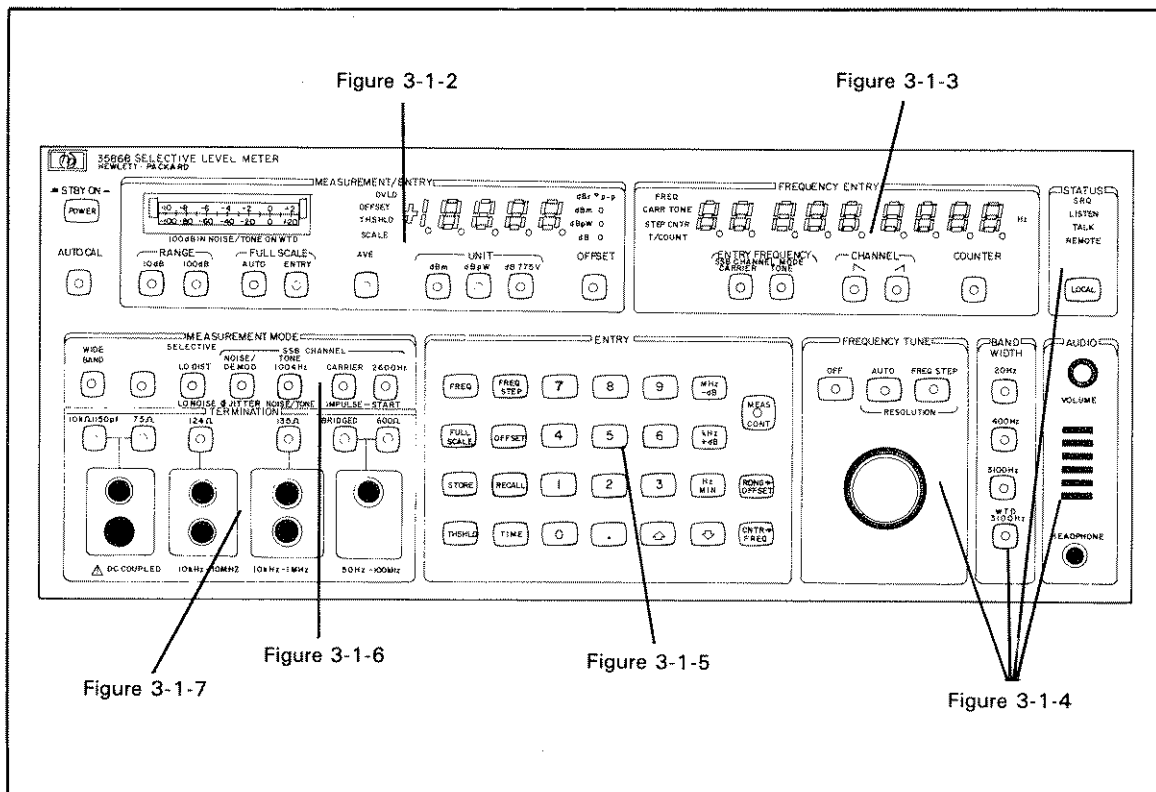

Figure 3-1-1. 3586 Front Panel.

3-1-8. Error Message Definitions. The format for all error messages, except calibration error messages, is

Err N
or
E N.N

where N is a number that indicates the specific error message.

- | | |
|---|---|
| N = 1 | The Full Scale level cannot be changed manually while the instrument is in Automatic Full Scale. |
| N = 1.2 | The 10dB Range cannot be used when the instrument is in the Wideband or Impulse measurement modes. |
| N = 2.2 | The ϕ Jitter cannot be measured because signal level is 40dB or more below Full Scale. |
| N = 2.3 | The ϕ Jitter cannot be measured because the 1kHz test tone is not present. |
| N = 2.9 | The ϕ Jitter out of Range. This can also indicate an instrument failure. |
| N = 5 | The instrument is in Remote and therefore will not respond to front panel controls. |
| or | |
| The LOCAL control has been disabled by a local Lockout message. | |
| N = 6.1 | Accurate Impulse Measurements are unlikely. The threshold level is 60dB or more below full scale. |
| N = 6.2 | The threshold level is above the full scale. This is a nonsensical instrument configuration. |
| N = 3.0 | Instrument Failure. At least one of the phase locked loops is unlocked. |
| N = 4.1 | Instrument Failure. The impulse counter did not start during CAL. |
| N = 4.2 | Instrument Failure. The impulse counter did not stop during CAL. |
| N = 7 | Instrument Failure. The Analog to digital convertor was unable to make a conversion within two seconds. |

Calibration Error messages are always instrument failures. the format for calibration error messages is:

CE - N

where N is an alphanumeric character that indicates which step of the calibration sequence failed.

3-1-9. STORE/RECALL OF INSTRUMENT CONFIGURATIONS.

3-1-10. All front panel control settings and entry parameter values comprising a particular front panel configuration can be stored and then recalled for use at a later date. Up to nine front panel configurations can be stored simultaneously. To store a configuration, press



and any digit key from 1 to 9. Similarly, to recall a configuration, press



and the digit selected when storing the configuration. Note that pressing



resets the instrument to its turn on state.

3-1-11. Tracking Generator Operation.

3-1-12. When configured to do so, the -hp- 3586 A/B/C can control the frequency of a synthesizer connected via the HP-IB. Any HP-IB compatible synthesizer that uses ASC II codes F or FF for the frequency entry preface function and H or HH for the hertz units termination can be controlled. Once the Tracking Generator operating mode has been implemented, the frequency of the synthesizer will track the tuned frequency of the 3586A precisely. Each time the 3586 tuned frequency is changed, the synthesizer is switched to remote, programmed to the new frequency, and then switched back to local. To implement the Tracking Generator operating mode, connect the synthesizer and the -hp- 3586 together using an HP-IB cable. Do not connect anything else to the system. Move the Tracking Generator switch, located on the rear panel, to the REM position (see Figure 2-7). Either lock the 3586 to the frequency reference of the synthesizer or visa vice versa (see Paragraph 2-27). This insures that the output frequency of the synthesizer and the tuned frequency of the synthesizer are actually equal.

3-1-13. AUTOMATIC CALIBRATION.

3-1-14. Automatic calibration compensates for minor frequency and amplitude offsets that are normally present in the instrument's analog section. This eliminates the need for external calibration adjustments. Auto Cal can be turned off and on using the AUTO CAL OFF/ON control. When Auto Cal is off, the last calibration constants stored are used to correct the measured level. Auto Cal should be left on in almost all applications. Turn it off only when the sole purpose of the instrument is to demodulate the signal for monitoring (listening) or for further testing with other instruments. Disabling Auto Cal eliminates the interruptions caused by periodic calibrations.

3-1-15. Here is a potpourri of questions often asked about Auto Cal.

Question: When does an automatic calibration take place?

Answer: —During the turn on sequence.
 —If Auto Cal is on, when the frequency is changed more than 1MHz.
 —If Auto Cal is on and the instrument is in local, approximately every three minutes.
 —When Auto Cal is turned on.
 —If Auto Cal is on and Wideband is chosen.

Question: How is a calibration indicated?

Answer: CAL appears in the Measurement/Entry display.

Question: What happens if the instrument cannot calibrate successfully?

Answer: An error code appears in the Measurement/Entry display. The format of the code is

CE - N

where N is number or letter that indicates to service trained personnel which calibration step failed.

Question: What should the operator do when a calibration error occurs?

Answer: Note the error code. This will be helpful to the service technician should the instrument need repair. Cycle the Auto Cal on and off several times. If the calibration error appears to be a transient condition, continue using the instrument. If the error reoccurs, even intermittently, the instrument should be evaluated by service trained personnel.

Question: What is the duration of a calibration cycle?

Answer: About three seconds.

Question: What happens if controls are actuated during a calibration cycle?

Answer: The instrument will ignore entries during the turn on calibration cycle. During all other calibrations, it will accept the entries and assume the new configuration at the end of the calibration cycle.

Question: When should Auto Cal be disabled?

Answer: Practically never! Disable automatic calibration only when monitoring a channel or using the -hp- 3586A/B/C to demodulate a channel for further testing with a different instrument.

Question: How does Auto Cal work?

Answer: During a calibration cycle, a very accurate amplitude signal is switched into the signal path at precisely the center of the instruments bandwidth. The instrument configuration is then cycled (not indicated by control annunciators) and calibration constants for each of the input attenuator settings and for each bandwidth are stored within the instrument. These calibration constants are then used to correct subsequent measurement data before they are displayed.

3-1-16. Operator's Maintenance.

3-1-17. The operator's maintenance consists of cleaning the air filter on the fan and replacing blown fuses.

3-1-18. Cleaning The Air Filter. The air filter must be clean to insure proper cooling of the instrument. Generally, cleaning the air filter once every thirty days of continuous operation is adequate; however, if the operating environment is especially dusty, more frequent cleaning may be required. Use the following procedure to clean the air filter.

- a. Unplug the -hp- 3586A/B/C.
- b. Remove the air filter.
- c. Wash the air filter with soapy water.
- d. Rinse the air filter and let it dry.
- e. Replace the air filter on the instrument.

3-1-19. Fuse Replacement.**WARNING**

The principal purpose of a fuse is to prevent fires in the event of a short circuit in the instrument. To a lesser degree, a fuse also reduces shock hazard and damage to the instrument if an internal short does occur. If a fuse with a larger than recommended ampere rating is used or if a fuse other than the recommended type is used, some or all of the protection afforded by the fuse will be lost.

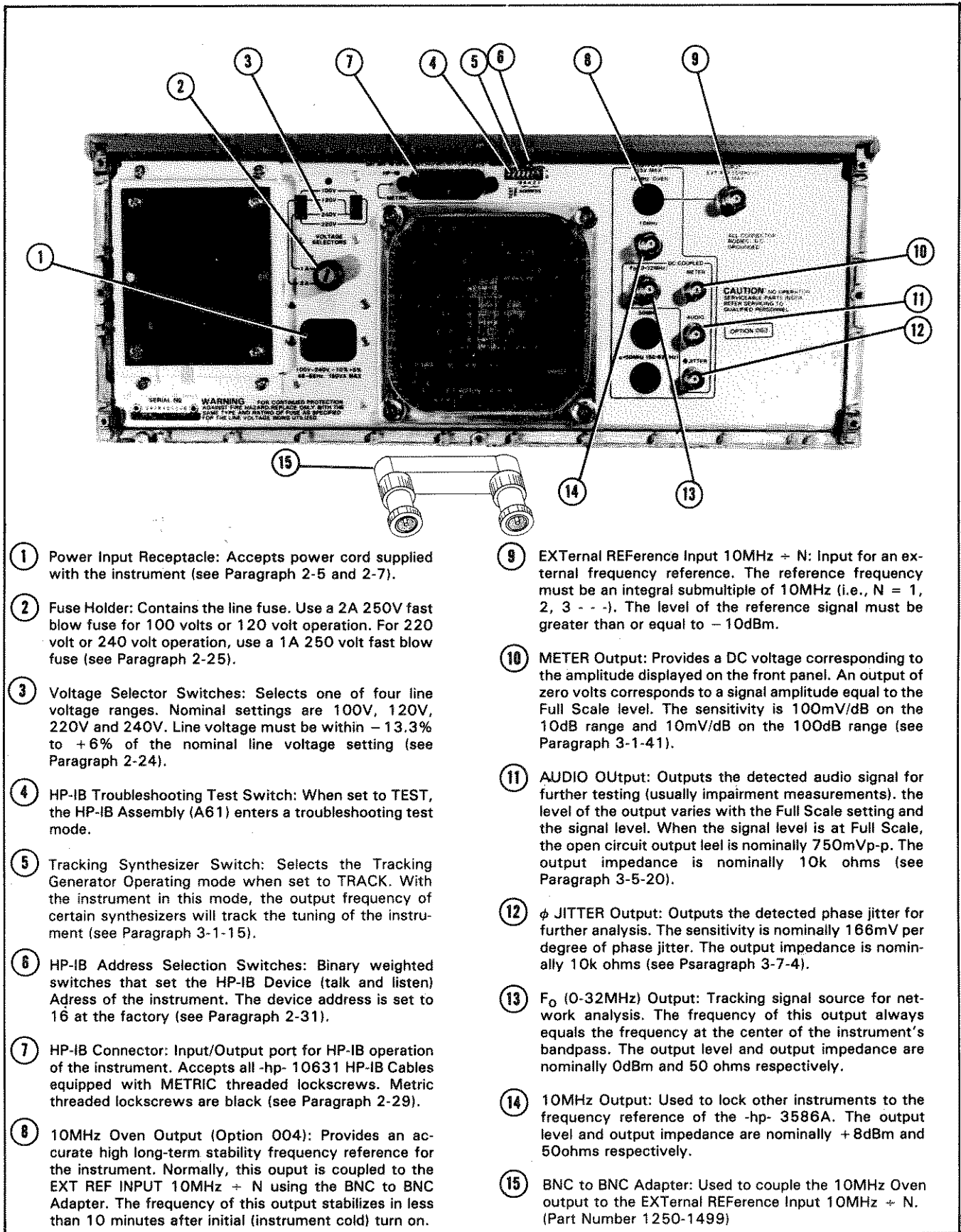

- ① Power Input Receptacle: Accepts power cord supplied with the instrument (see Paragraph 2-5 and 2-7).
- ② Fuse Holder: Contains the line fuse. Use a 2A 250V fast blow fuse for 100 volts or 120 volt operation. For 220 volt or 240 volt operation, use a 1A 250 volt fast blow fuse (see Paragraph 2-25).
- ③ Voltage Selector Switches: Selects one of four line voltage ranges. Nominal settings are 100V, 120V, 220V and 240V. Line voltage must be within -13.3% to +6% of the nominal line voltage setting (see Paragraph 2-24).
- ④ HP-IB Troubleshooting Test Switch: When set to TEST, the HP-IB Assembly (A61) enters a troubleshooting test mode.
- ⑤ Tracking Synthesizer Switch: Selects the Tracking Generator Operating mode when set to TRACK. With the instrument in this mode, the output frequency of certain synthesizers will track the tuning of the instrument (see Paragraph 3-1-15).
- ⑥ HP-IB Address Selection Switches: Binary weighted switches that set the HP-IB Device (talk and listen) Address of the instrument. The device address is set to 16 at the factory (see Paragraph 2-31).
- ⑦ HP-IB Connector: Input/Output port for HP-IB operation of the instrument. Accepts all -hp- 10631 HP-IB Cables equipped with METRIC threaded lock screws. Metric threaded lock screws are black (see Paragraph 2-29).
- ⑧ 10MHz Oven Output (Option 004): Provides an accurate high long-term stability frequency reference for the instrument. Normally, this output is coupled to the EXT REF INPUT 10MHz + N using the BNC to BNC Adapter. The frequency of this output stabilizes in less than 10 minutes after initial (instrument cold) turn on.
- ⑨ EXTERNAL REFERENCE INPUT 10MHz + N: Input for an external frequency reference. The reference frequency must be an integral submultiple of 10MHz (i.e., N = 1, 2, 3 - - -). The level of the reference signal must be greater than or equal to -10dBm.
- ⑩ METER Output: Provides a DC voltage corresponding to the amplitude displayed on the front panel. An output of zero volts corresponds to a signal amplitude equal to the Full Scale level. The sensitivity is 100mV/dB on the 10dB range and 10mV/dB on the 100dB range (see Paragraph 3-1-41).
- ⑪ AUDIO Output: Outputs the detected audio signal for further testing (usually impairment measurements). The level of the output varies with the Full Scale setting and the signal level. When the signal level is at Full Scale, the open circuit output level is nominally 750mVp-p. The output impedance is nominally 10k ohms (see Paragraph 3-5-20).
- ⑫ φ JITTER Output: Outputs the detected phase jitter for further analysis. The sensitivity is nominally 166mV per degree of phase jitter. The output impedance is nominally 10k ohms (see Paragraph 3-7-4).
- ⑬ F₀ (0-32MHz) Output: Tracking signal source for network analysis. The frequency of this output always equals the frequency at the center of the instrument's bandpass. The output level and output impedance are nominally 0dBm and 50 ohms respectively.
- ⑭ 10MHz Output: Used to lock other instruments to the frequency reference of the -hp- 3586A. The output level and output impedance are nominally +8dBm and 50ohms respectively.
- ⑮ BNC to BNC Adapter: Used to couple the 10MHz Oven output to the EXTERNAL REFERENCE INPUT 10MHz + N. (Part Number 1250-1499)

Figure 3-1-8. 3586 Rear Panel.



CHAPTER TWO

SELECTIVE

3-2-1. The Selective Measurement modes are LOW DISTORTION and LOW NOISE. They are normally used when measuring non-telecommunications signals.¹ With either selection, the instrument measures the power level of the signal in a narrow band of frequencies selected using the bandwidth and tuning controls.

3-2-2. Measurement Mode.

NOTE

When in doubt, use LOW DISTortion.

3-2-3. **Low Distortion.** This is the basic selective level measurement mode of the instrument. It provides the best overall performance. Spurious signals on the local oscillator, thermal noise and intermodulation distortion are all 80dB or more below Maximum Input Power² in this mode. Use LOW DISTortion unless you *need* the special advantage of the LOW NOISE measurement mode. Note that the instrument turns on in this mode.

3-2-4. *Selecting Low Distortion.* Press (no shift) LOW DISTortion.

3-2-5. **Low Noise.** The Low Noise Measurement Mode is most easily described by comparing the instrument performance in this mode with that of the Low Distortion Mode. When the total power is greater than -35dBm , the thermal noise with the instrument in Low Noise will be 5dB lower than when the instrument is in the Low Distortion Mode. Below input powers of -35dBm , the two measurement modes are identical. Reducing the thermal noise, when the total input power is relatively high, is valuable for two reasons. First, low level signals are more likely to be masked by thermal noise than by any other type of noise or interference. Second, in the applications for which the -hp- 3586A/B/C was designed, it is not uncommon for the input power to be much larger than the signal to be measured. As you might imagine, this improvement in signal to thermal noise ratio cannot be obtained without sacrificing some other performance parameter. Again, compared to Low Distortion, the intermodulation distortion products are increased from 80dB below Maximum Input Power (MIP) to 70dB below MIP. Spurious signals remain unaffected at greater than 80dB below MIP. With intermodulation distortion products fully 15dB higher than the thermal noise, a question naturally arises, "What good does it do to reduce the thermal noise to 85dB below MIP?" The answer to this question depends on the nature of the input signal. If the power of the input signal is sufficiently dispersed and the individual components of the composite signal are randomly related, the intermodulation distortion will *very likely* be much lower than the specified 70dB below MIP. Even if the input power is not dispersed, this measurement mode may still be useful since intermodulation distortion products do not fall evenly throughout the frequency spectrum. LOW NOISE measurements of both types of input signals are discussed in detail in the paragraphs that follow. A word of caution: this measurement mode is advantageous only when measuring low level components of relatively

¹Telecommunications signals can be measured if desired; however, it is usually more convenient to use one of the SSB Channel measurement modes for these signals.

²Since the input of the -hp- 3586A/B/C is untuned, the Maximum Input power is the maximum broadband power that can be applied to the input. Broadband power is the sum of the input power at all frequencies.

high level input signals. Furthermore, the intermodulation distortion specification is only 70dB below maximum input power. Obviously, there could be intermodulation distortion products with an amplitude greater than or equal to the signal to be measured. You must know how to evaluate the input signal in order to make reliable measurements in this mode.

3-2-6. Selecting Low Noise. Turn the shift function on and press LOW NOISE.

3-2-7. LOW NOISE Measurements of Dispersed Signals. The 70dB below maximum input power intermodulation distortion specification given for the low noise measurement mode is a worst case figure. For certain types of input signals, the intermodulation distortion is typically well below this level. The input signals for which this is true have two characteristics:

- a. The power of the input signal is sufficiently dispersed throughout a bandwidth much wider than that of the instrument (the largest single frequency component of the input signal is more than 5dB below the Maximum Input Power).
- b. The frequencies of the significant individual components of the input signal are randomly related.

White noise is one example of this kind of signal. Another example is a telecommunications signal consisting of several hundred channels. The operator is required to know quite a lot about the input signal when the characteristics described in a. and b. are used as criteria for selecting the LOW NOISE measurement mode. In many applications, *the composition of the input signal is unknown. When this is the case, use the LOW DISTORTION measurement mode or assume that the signal is not dispersed and treat it accordingly (Paragraph 3-2-9).* The criteria for selecting LOW NOISE is simple when measuring telecommunications signals. LOW NOISE should be used whenever a telecommunications input signal consists of 60 or more message channels. In most telecommunications systems, the Super Group is the lowest level signal in the Frequency Domain Multiplexing hierarchy that contains 60 or more channels. Further insight into the use of this mode can be gained by understanding why intermodulation distortion is low when the power of the input signal is dispersed.

3-2-8. When the power of the input signal is dispersed throughout a wide bandwidth, the individual component signals have a low amplitude compared to the total input power. The instrument cannot distinguish an input power level consisting of dispersed signals from an input power level consisting of a few large tones. As a result, the instrument configures itself (or is configured) to handle a few large signals near maximum input power without excessive intermodulation distortion (IM). The 70dB below MIP intermodulation distortion specification is really for signals of this kind. When the actual individual input signals have low amplitude compared to the MIP, the resulting IM distortion is much less than that anticipated. Basically, there are two mechanisms that reduce the IM distortion caused by signals of this type. It is well known that the amplitude of an intermodulation product is proportional to the amplitude of the originating signals. When the amplitudes of the originating signals are lowered, the amplitude of the IM products also drop. In fact, *most IM products will drop either two or three times faster than the originating signals.* In addition, the operating range of the input mixer is not as large as expected. Reducing the mixer operating range reduces the mixer non-linearity which, in turn, further reduces the amplitude of the IM products. Note that if the frequencies of the individual input signal components are not randomly related, they will repetitiously add together causing peaks near the maximum input power level. This will at least partially eliminate the improvement in IM distortion performance gained from having a dispersed input signal.

3-2-9. LOW Noise Measurements of Non-Dispersed Signals. Intermodulation distortion products are not spread evenly throughout the frequency spectrum. They fall at a few discrete frequencies determined by the frequencies of the originating signals and by the order of the intermodulation distortion. Because of this, LOW NOISE can be used even when the power of the input signal is not dispersed. As long as none of the intermodulation products fall within the instrument bandpass, the measurement is perfectly valid. The difference between making LOW NOISE measurements of dispersed and non-dispersed signals is that the operator must be especially careful when measuring non-dispersed signals. If one of the intermodulation products happens to fall within the instrument bandpass, the reading will very likely be totally erroneous. It is fairly easy to detect the presence of an intermodulation product in the instrument bandpass. When the instrument is switched from LOW DISTORTION to LOW NOISE, the reading should drop. If the reading increases, there very definitely is an intermodulation product in the bandpass of the instrument. An even more conclusive test is to change the input signal level 1dB with the instrument in LOW NOISE. If the displayed amplitude drops approximately 1dB, then there are no intermodulation products in the instrument bypass. If it changes more than 1dB, then the reading is being affected by an intermodulation product. When this happens, it is sometimes possible to eliminate the undesired signal by slightly mistuning the instrument. Some intermodulation products change frequency very rapidly with respect to tuning changes. If the intermodulation product cannot be eliminated, switch the instrument to LOW DISTORTION. It is not possible to make LOW NOISE measurements of all signals.

3-2-10. INPUT/OUTPUT CONNECTIONS.

3-2-11. 75/50 Ohm Input.

3-2-12. This is an unbalanced input which is calibrated to read absolute power levels referenced to 75 ohms. An input level of .274V, which is 1mw into 75 ohms, causes an amplitude level reading of 0dBm. Either 10k Ω ||50pf or terminated measurements may be made using this input (see Figure 3-2-1). When the 75 ohm impedance is furnished by the signal source circuitry, the 10k Ω ||50pf measurement mode is selected. The terminated or 75 ohm input is used whenever the signal source circuitry must be terminated in 75 ohms. All of the various connectors used on this input are illustrated and identified in Figure 3-2-2. If desired, an active probe can be connected to this input. On the 3586C, the 50 Ω input operates identically to the 75 Ω input including the 10k Ω ||50pf capability.

3-2-13. Grounding. Although a special power supply and ground isolation technique is used for the input circuitry of the -hp- 3586A, low level measurements can still be affected by ground loops. Usually, these ground loops are caused by poor grounding. To minimize the effect of ground loops, keep the cables as short as possible and in good repair. If possible, plug the -hp- 3586A into the same power outlet used to power the equipment under test.

3-2-14. 75 Ohm Terminated Input. The 75 ohm input is used whenever the signal source needs to be terminated in 75 ohms. When measuring telecommunications signals, the 75 ohm input usually terminates an attenuator pad placed between the operating circuits and the test point for isolation. In other applications, the input impedance replaces some portion of the system circuitry.



3-2-15. When making 75 ohm terminated measurements, the maximum input power is .5 watt. This limitation is determined by the 75 ohm terminating resistor. For AC signals this .5 watt limitation corresponds to an input level of +27dBm. Ordinarily, the input signal will

not have a DC component; however, if it does, the peak value of the composite waveform (AC+DC) may not exceed 10V.

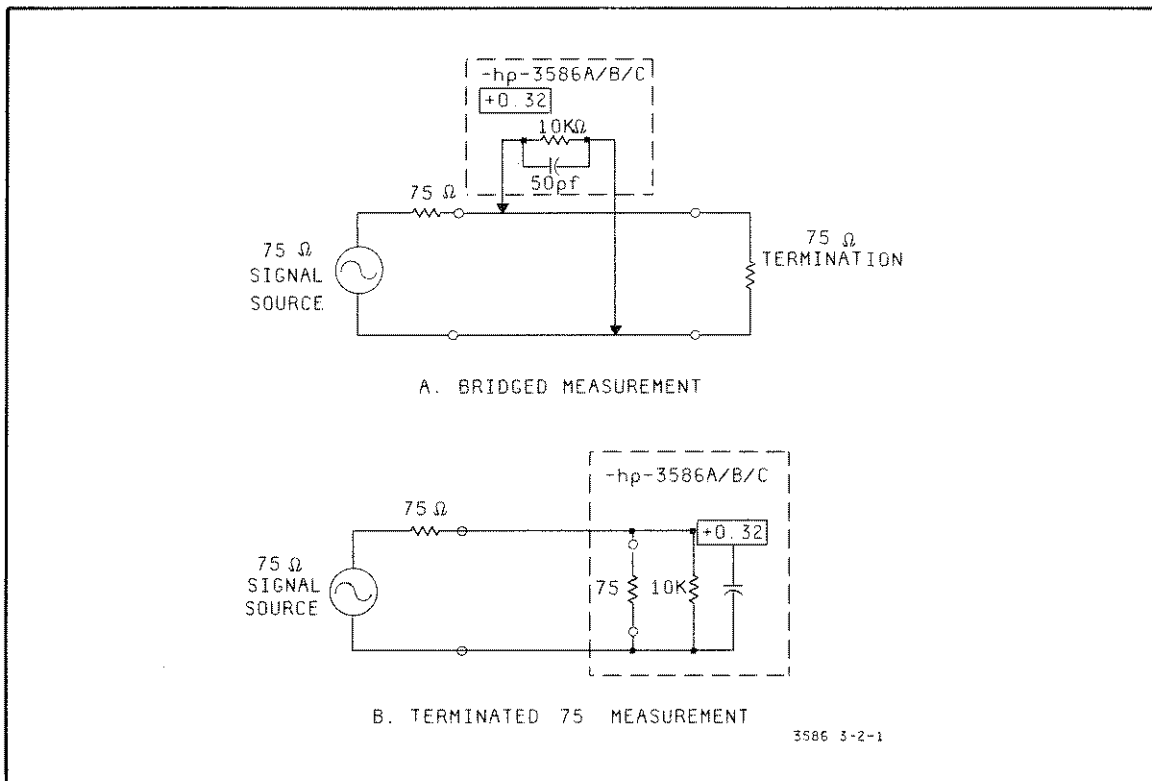

Figure 3-2-1. 75 Ohm Input Measurements.

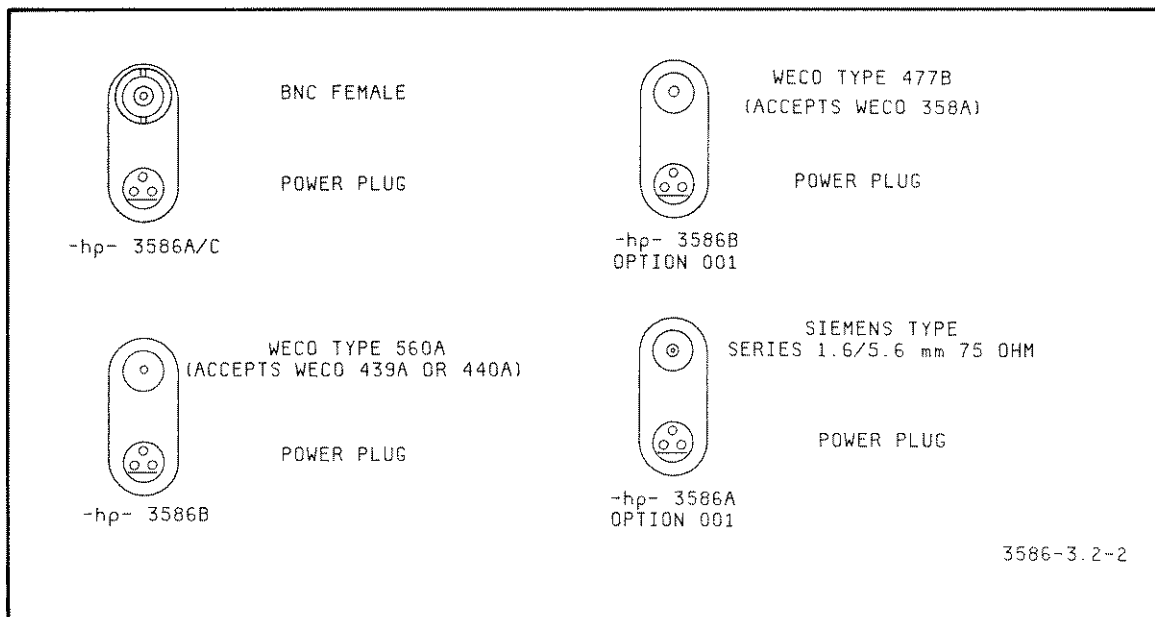

Figure 3-2-2. Connectors For The 75 Ohm Input.

3-2-16. 10k Ω ||50pf Termination. The 10k Ω ||50pf termination is used whenever the impedance level of the signal being measured is already 75 ohms. In this mode, the instrument is a high input impedance (10k ohms shunted by 50 pf) voltmeter calibrated to read absolute signal levels (power) in dBm, dBV or dBpw referenced to 75 ohms. Its relatively high input impedance in this mode prevents the instrument from seriously loading a 75 ohm signal source or altering a 75 ohm circuit impedance. For this reason measurements made directly across functioning circuits are often bridged measurements.

NOTE

Measurements of telecommunications signals in operating systems are almost always made using a terminated input. A pad isolates the operating system from the system test point. The pad is designed to have its indicated attenuation when properly terminated. This practice of isolating the system test point from the operation circuitry eliminates the chance that the signal will be disturbed by instruments connected to the test point.



3-2-17. In the 10k Ω ||50pf measurement mode the absolute maximum safe AC input power is +27dBm. Normally, there will not be a DC component to the input signal. However, if there is a DC component, the power of the composite signal (AC + DC) must not exceed .5 watts.

3-2-18. Measuring Other Impedances. Unterminated measurements can be made across impedances other than 75 ohms. When this is done, the displayed amplitude can be used directly for relative measurements, converted to volts or offset (recalibrated) to read absolute amplitude levels across the new circuit impedance. Relative measurements are those in which either a change in level or the difference between two levels is measured. For example, measuring the gain of an amplifier.



3-2-19. Absolute Level Measurements Across Other Impedances. The display can be calibrated to read absolute amplitude at different impedances by entering an offset. The required offset is found using the following equation:

$$\text{Offset} = 10 \log (R1/75)$$

3-2-20. The procedure for entering offsets is given below. If more than one offset is to be used, they must be combined first and entered as a single offset.

STEP 1: Press the OFFSET control located in the Entry group.

STEP 2: Enter the digits and decimal as required.

STEP 3: Press  or  as appropriate.

STEP 4: Press  to resume measurement.

NOTE

Do not change the Units selection after entering an offset. Offsets are not referenced to any particular impedance or level. Because of this, the magnitude of an entered offset does not change when the Units are changed.

3-2-21. Converting To Volts. The displayed absolute amplitude levels are calculated from the measured input voltage. The instrument simply assumes that the impedance is 75 ohms. Because of this, these readings can easily be converted to voltage using the following equation:

$$\text{Input Volts} = (.075) 10^{A/10} \quad A \text{ is the displayed amplitude.}$$

3-2-22. Probe Power Jack. The probe power jack, located just below the 75 ohm input, is compatible with several -hp- Active Probes. A pin out of the power jack is given in Figure 3-2-2. Two probes recommended for use with this instrument are the -hp- 15580 and -hp- 15578A. If a probe with an output impedance of 50 ohms is being used, enter an offset of +1.58dB to compensate for the mismatch. On the 3586C, simply select the 50Ω input.

3-2-23. 124 Ohm Input (3586B Only).

3-2-24. This balanced input is used whenever the signal source circuitry needs to be terminated in 124 ohms. An input of 1mw causes an amplitude reading of 0dBm. All of the various connectors used on this input are illustrated and identified in Figure 3-2-3. A brief description of balanced measurements can be found in Paragraph 3-2-31.

NOTE

Make no connections to the 135 Ohm Input while using the 124 Ohm Input. The two inputs share circuitry on the Input Multiplexer Board that causes them to interact. Signals on the 135 Ohm Input will affect the amplitude reading of the 124 Ohm Input. Any impedance connected across the 135 Ohm Input will alter the impedance of the 124 Ohm Input.



3-2-25. The absolute maximum signal that can be applied to the 124 Ohm Input is +27dBm. Levels above this amplitude may damage the input circuitry. Absolutely no DC voltage can be applied to this input. This is because one side of the input is practically shorted to ground at very low frequencies.

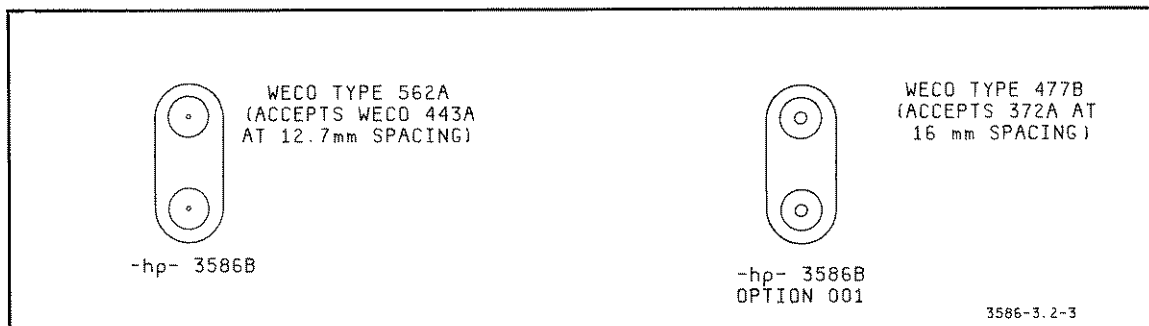

Figure 3-2-3. Connectors For The 124 Ohm Input.



The maximum amplitude AC signal on the 124 Ohm Input is +27dBm. DO NOT APPLY DC VOLTAGE TO THE 124 OHM INPUT.

3-2-26. 135/150 Ohm Input.

3-2-27. This input is either 135 or 150 ohms depending on the model selected. It is a balanced input that is used whenever the signal source circuitry needs to be terminated in either 135 or 150 ohms as appropriate. An input of 1mw causes a level reading of 0dBm. All of the various connectors used with this input are illustrated and identified in Figure 3-2-4. A brief description of balanced measurements can be found in Paragraph 3-2-31).

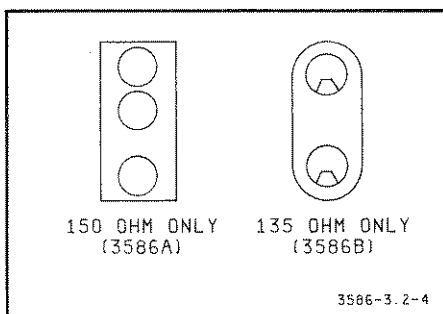

Figure 3-2-4. Connectors For The 135/150 Ohm Input.

NOTE

Make no connections to the 124 Ohm Input while using the 135 Ohm Input. The two inputs share circuitry on the Input Multiplexer Board that causes them to interact. Signals on the 124 Ohm Input will affect the amplitude reading of the 135 Ohm Input. Any impedance connected across the 124 Ohm Input will alter the impedance of the 135 Ohm Input.



3-2-28. The absolute maximum amplitude that can be applied to this input is +27dBm (.5W). This signal level is 8.22V for the 135 Ohm Input, and 8.66V for the 150 Ohm Input. Do not connect anything to the 124 Ohm Input while using this input.

3-2-29. 600 Ohm Input.

3-2-30. This is a balanced input which is calibrated to read absolute input levels across 600 ohms. One milliwatt into 600Ω (which is .775V), causes an amplitude level reading of 0dBm. Either BRIDGED or terminated measurements may be made using this input (see Figure 3-2-1). When the 600 ohm impedance level is furnished by the signal source circuitry, the BRIDGED measurement mode is selected. The terminated or 600 ohm input is used whenever the signal source circuitry must be terminated in 600 ohms. All of the various connectors used on this input are illustrated and identified in Figure 3-2-5.

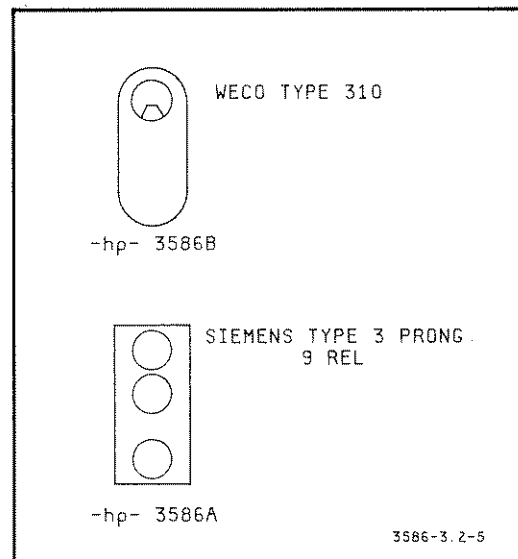

Figure 3-2-5. Connectors For The 600 Ohm Input.

3-2-31. Balanced Inputs. Balanced circuits are those with two outputs which are electrically identical and symmetrical with respect to ground. The balanced inputs on the -hp- 3586A permit the outputs of balanced signal sources to be measured without disturbing their relationship to ground. A balanced measurement is illustrated in Figure 3-2-6. Balanced measurements are not nearly as susceptible to ground loop problems as are terminated measurements. Ground loop voltages tend to be identical on both inputs, so they are cancelled by the common mode rejection characteristics of the instrument.

3-2-32. Not only is the 600 Ohm Input balanced, but it is also floating. A transformer isolates this input from the rest of the circuitry and, most important, from ground. As a result, this input is especially free from ground loop problems.

3-2-33. 600 Ohm Terminated Input. The 600 Ohm Input is used whenever the signal source circuitry needs to be terminated in 600 ohms.

3-2-34. Bridged Measurements. The bridged measurement mode is used whenever the impedance of the signal being measured is already 600 ohms. In this mode, the -hp- 3586A is a high input impedance (10k Ω shunted by 50pf) voltmeter calibrated to read absolute signal levels (power) in dBm, dBv or dBpw referenced to 600 ohms. Its input impedance is high enough to prevent it from seriously loading a 600 Ω signal source or altering a 600 Ω circuit impedance and causing reflections (echoes). For this reason, BRIDGED measurements can be safely made on functioning circuits. This is not meant to imply that all measurements on functioning circuits are made using the Bridged input. In telecommunications systems for instance, pads are often placed between the operating system and the test point. The terminated 600 Ohm Input of the instrument is used to terminate the attenuator pad.

3-2-35. While the input impedance is high enough to prevent the -hp- 3586A from disturbing the circuit, it is also low enough to cause a significant measurement error. If the impedance of the circuit under test is exactly 600 ohms, the error due to loading effect is $-.2567$ dB. If desired, the displayed amplitude level can be corrected by entering an offset of $-.26$ dB. Use the following procedure to enter the offset. If more than one offset is to be used, they must be combined first and entered as a single offset.

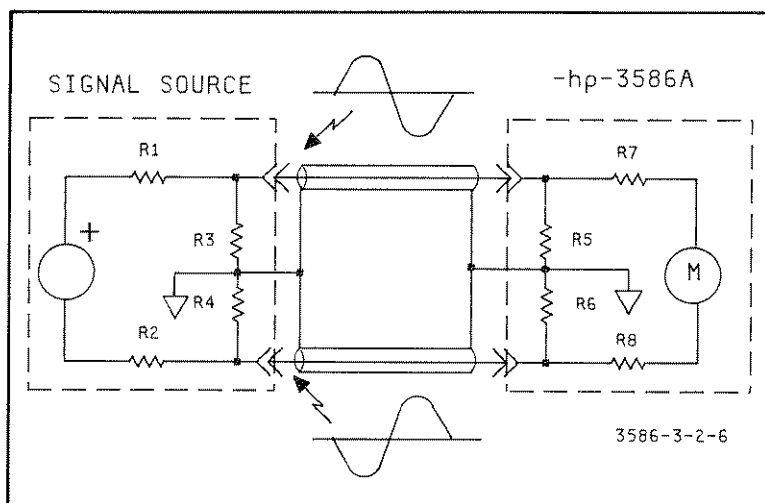

Figure 3-2-6. Balanced Measurement.

STEP 1: Turn OFFSET ON/OFF control ON.

STEP 2: Press **OFFSET** .

STEP 3: Enter the decimal and digits as required.

STEP 4: Press **MHz -dB** or **kHz +dB** as appropriate.

STEP 5: Press **MEAS ● CONT** .



3-2-36. In the BRIDGED measurement mode the maximum input power voltage is +27dB. Normally, there will not be a DC component to the input signal. However, if there is a DC component, it must not exceed 42 volts either differential or common mode.

3-2-37. Bridging Other Impedances. Bridged measurements can be made across impedances other than 75 ohms. When this is done, the displayed amplitude can be used directly for relative measurements, converted to volts or offset (recalibrated) to read absolute amplitude levels across the new circuit impedance. Relative measurements are those in which either a change in level or the difference between two levels is measured. For example, measuring the gain of an amplifier.



3-2-38. Absolute Level Measurements Across Other Impedances. By entering an offset the display can be calibrated to read absolute amplitude at difference levels. The required offset is found using the following equation:

$$\text{Offset} = 10 \log_{10} (R1/75)$$

3-2-39. The procedure for entering offsets is given below. If more than one offset is to be used, all offsets must be combined and entered as a single offset.

STEP 1: Press the OFFSET control located in the Entry group.

STEP 2: Enter the digits and decimal as required.

STEP 3: Press  or  as appropriate.

STEP 4: Press  to resume measurement.

NOTE

Do not change the Units selection after entering an offset. Offsets are not referenced to any particular impedance or level. Because of this, the magnitude of an entered offset does not change when the Units are changed.

3-2-40. Converting to Volts. The displayed absolute amplitude levels are calculated from the measured input voltage. The instrument simply assumes that the impedance is 75 ohms. Because of this, these readings can easily be converted to voltage. The equation for converting from dBm to volts is

$$\text{Input Volts} = (.075) 10^{(A/10)}$$

3-2-41. Meter Output.

3-2-42. A DC voltage proportional to the input signal level is available from the METER output on the rear panel. Zero volts are output when the signal amplitude equals the full scale level. The sensitivity is 100mv/dB on the 10dB range and 10mv/dB on the 100dB Range.

3-2-43. TUNING THE INSTRUMENT IN THE SELECTIVE MEASUREMENT MODES.

3-2-44. When followed sequentially, the information presented in this subsection is a procedure for tuning the -hp- 3586A/B/C to any signal it is capable of measuring in the Selective Measurement Modes.

3-2-45. The -hp- 3586A/B/C can be fine tuned only to input signals that consist of voice traffic or that contain a single frequency, dominant amplitude component. Input signals consisting of voice traffic are fine tuned simple by adjusting for natural sound. All other input signals must contain a single frequency dominant amplitude at the center frequency of the signal to be measured because of the technique used to fine tune the instrument. Fine Tuning begins once the input signal is within the instrument's bandpass (coarsely tuned). The operator activates the Counter and measures the frequency of the input signal. By pressing the Counter to Frequency control, the operator instructs the instrument to tune to the frequency just measured. Since the input signal was just measured, the instrument is precisely tuned to the input signal frequency. Note that a dominant single frequency signal must be present in the input signal for the counter to count. Most commonly measured signals have such a component naturally. If the input signal does not contain the required component, one can be furnished temporarily for the purpose of fine tuning. When a signal is furnished temporarily, its frequency must be at the center of the bandpass to be measured.

3-2-46. Instrument Configuration For Tuning.

3-2-47. The optimum control settings for tuning the -hp- 3586A/B/C to the vast majority of input signals are given below. The possible exceptions are very low amplitude input signals and fluctuating input signals that cause the instrument to autorange constantly (see Paragraph 3-2-71).

3-2-48. Channel. Select the channel in accord with the signal being received. If the instrument is being tuned to a noncommunications signal, it makes no difference which Channel selection is used.



— Configures the instrument to receive a lower sideband signal.



— Configures the instrument to receive an upper sideband signal.

3-2-49. Bandwidth. Use the widest Bandwidth selection permitted by the composition of the input signal. Recall that a single frequency *dominant* amplitude signal must be present in the input signal for fine tuning. The instrument bandpass should discriminate against any signal whose amplitude is larger than the signal to be counted. Avoid the temptation to automatically use a narrow bandwidth. The tuning procedure is usually simpler when wider bandwidths are used.

3-2-50. Range. Use the 100dB Range for tuning the instrument to all but very low amplitude signals (i.e., minus 90dBm and above). Using the 100dB Range will make searching for the input signal easier should it become necessary. Very low amplitude signals cause only a slight indication on the analog tuning meter when the 100dB Range is used. In these cases, the 10dB Range is used to increase meter sensitivity.

3-2-51. Full Scale - Use AUTOMATIC Full Scale While Tuning. If a fluctuating input signal level causes the instrument to autorange constantly, (see Paragraph 3-2-71). Entering a fixed Full Scale level will eliminate the constant autoranging.

3-2-52. Entry Frequency. The Entry Frequency controls are not functional when the instrument is in one of the Selective Measurement modes. An annunciator in the center of one of the controls remains lit to indicate how the displayed frequency will be interpreted if the instrument is switched to one of the SSB Channel measurement modes.

3-2-53. Coarse Tuning.



3-2-54. The instrument is coarsely tuned whenever the dominant single frequency component of the input signal is within the instrument bandpass. In most cases, coarse tuning is obtained by simply entering the Entry Frequency. An additional step may be required whenever a narrow bandwidth is used at high frequencies. Under these circumstances, it may be necessary to search for the input signal even when the frequency of the signal is precisely known. This is because errors in the tuned frequency of the instrument cause the Entry Frequency to fall outside of the instrument bandpass.³ Other times, searching for the input signal is necessary because of operator uncertainty about the frequency of the signal.

³When the ENTRY mode is selected, the AUTOMATIC full scale level is retained until a different value is entered.

3-2-55. Entering The Entry Frequency. In the Selective operating modes, the Entry Frequency is the Frequency at the center of the instrument bandpass. Use the following procedure to enter the Entry Frequency.

STEP 1: Press 

STEP 2: Enter the significant digits.

STEP 3: Press  ,  or 

Notice that these keys permit any frequency to be entered three different ways.

3-2-56. Searching For The Input Signal.

NOTE

This step should not be necessary if the frequency of the input signal is precisely known AND

1. The -hp- 3586A/B and the signal source are locked to the same frequency reference.

OR

2. A high stability frequency reference is used in the instrument.

OR

3. If the widest bandwidth is being used.

Searching for the input signal consists of varying the tuned frequency of the instrument until the signal falls within the instrument bandpass. This is most easily done using the Frequency Tune Control (Paragraph 3-2-58). As expected, it is often necessary to search for an input signal when the input signal frequency is not precisely known. What may not be expected is that it is sometimes necessary to search for the input signal even when its frequency *IS* precisely known. Whenever the error in the instrument's tuned frequency is nominally equal to one-half of the bandwidth, the entered frequency (and therefore the input signal) will not fall within the instrument bandpass. In other words, the instrument bandpass may not include the frequency displayed on the front panel. Exactly when this is likely to happen is a function of the Entry Frequency, Bandwidth selection and frequency reference used in the instrument. The combinations of these factors that require a search for the input signal are summarized in Table 3-2-1. When any of these conditions exist, the operator must search for the input signal or *verify that the signal being received is the desired signal. Note that an increase in the level indication does NOT mean that the instrument is properly tuned. The instrument may be tuned to the wrong signal!* If you are certain there are no other signals in the vicinity of the desired signal, it is safe to assume that an increase in indicated level is due to the desired signal. Otherwise, it is necessary to scan the frequency spectrum (plus or minus 200Hz) to be certain that the instrument is properly tuned.

3-2-58. Frequency Tune Control. This control provides continuous Frequency Entry. When either of the Resolution Controls is on, rotating the Frequency Tune Control will

change the tuned frequency in increments or (decrements) determined by the Resolution Controls. Clockwise rotation increases the frequency and counter clockwise rotation decreases it.

Table 3-2-1. Frequencies At Which Signal Search May Be Required.

Frequency Reference	Bandwidth	
	400Hz	20Hz
None	Entry Frequency > 20MHz	Entry Frequency > 6MHz
Option		Entry Frequency > 20MHz

The tuning procedure is now complete. If a dominant amplitude single frequency signal has been furnished for the purposes of tuning, it should now be removed.

3-2-59. AUTOMATIC. When AUTOMATIC resolution is selected, the frequency increments of the Frequency Tune Control are determined by the Bandwidth selection. According to Bandwidth selection, the frequency changes are: 100Hz for the widest Bandwidth, 20Hz for the 400Hz Bandwidth and 1Hz for the 20Hz Bandwidth.

3-2-60. FREQUENCY STEP. The resolution of the Frequency Tune Control is equal to the quantity stored in the frequency step register when FREQUENCY STEP resolution is selected. At turn on, this value is 1Hz. Use the following procedure to enter a different Frequency Step:

STEP 1: Press



STEP 2: Enter the digits and decimal as required.

STEP 3: Press



,



or



as appropriate.

STEP 4: Press



3-2-61. Fine Tuning.

3-2-62. The instrument can be fine tuned to input signals consisting of voice traffic or input signals that contain dominant amplitude single frequency components.

3-2-63. Fine Tuning To Signals Dominated By A Single Frequency Component. Basically, the procedure for fine tuning the instrument to an input signal of this nature is to measure the frequency of the signal and transfer the result to the Entry Frequency register. This procedure is presented in detail.

STEP 1: Coarsely tune the instrument (this is already done if you are following the procedure in this manual).

STEP 2: Turn the Counter OFF-ON control on.

STEP 3: Press  . The frequency of the input signal will appear in the Frequency/Entry display.

STEP 4: Press  . This transfers the counter reading to the frequency register. The contents of the frequency register determine the tuned frequency of the instrument.

3-2-64. Fine Tuning To Voice Signals. The instrument is fine tuned to voice signals by adjusting for natural sound. This procedure is presented in detail.

STEP 1: Select FREQUENCY STEP for the resolution of the Frequency Tune Control.

STEP 2: Turn up the volume.

STEP 3: Adjust the Frequency Tune Control for natural sound.

3-2-65. INSTRUMENT CONFIGURATION FOR MEASUREMENTS.

3-2-66. Range/Full Scale.

3-2-67. The Range controls determine the range of the Measurement/Entry display (and the Analog Tuning Meter) relative to the full scale level. The Full Scale controls select the method of determining and entering the full scale level. Even though they direct different instrument functions, these controls are very interdependent. In other words, the full scale entry mode selection affects the implementation of the Range selection and vice versa. Because of this, you will probably not understand either control completely until you have read about both. When selecting the Range and Full Scale settings, it is sometimes easiest to think in terms of the combinations of Range and Full Scale selections. To aid the operator in his selection, the relative advantages and disadvantages of all four Range and Full Scale combinations are summarized in Table 3-2-2.

NOTE

When in doubt, choose 10dB/AUTO. This is the optimum combination of Range and Full Scale for the vast majority of level measurements. Even when it is not the optimum choice, the loss is mainly in tuning convenience and speed rather than accuracy.

3-2-68. Range. The Range controls select the operating range of the instrument's internal true rms Detector/Logger. This in turn affects measurement accuracy and determines the display range of both the Measurement/Entry Display and the Analog Tuning Meter. In fact, the Range Controls are labeled in accord with the ranges on the Analog Tuning Meter.

3-2-69. *100dB.* The entire 80dB range of the Detector/Logger is used when the 100dB Range is selected. Any signal level between full scale and 80dB below full scale can be measured. Note that there are no specifications for measurements of signals less than 80dB below full scale; the 100dB label refers to the scale of the Analog Tuning Meter. When this Range is used, the resolution of the Measurement/Entry display is .1dB and the accuracy is

less than the accuracy of the 10dB Range. The reasons for this will become apparent from the description of the 10dB Range.

3-2-70. *10dB*. When the 10dB Range is selected, all signals are detected on the most linear 10dB portion of the Detector/Logger's operating range. This reduces the error introduced by the non-linearity of the Detector/Logger and gives the 10dB Range its superior accuracy. Any signal level between full scale and 10dB below full scale can be measured with .01dB resolution on this range. Precision variable gain IF amplifiers adjust the Full Scale level so that all signals to be measured fall within this very linear 10dB region of the Detector/Logger regardless of their initial amplitude. Amplifying the signal so that it always falls within this most linear 10dB region is the alternative to using the entire 80dB Range of the Detector/Logger. Because of the precision resistor technology used in the IF amplifier gain control circuitry, the IF gain increments are very precise and introduce much less error than is introduced by the non-linearity of the Detector/Logger in the 100dB Range. The 10dB Range and the 100dB Range measurements are contrasted in Figure 3-2-7. Note that signals from +3dB above and -17dB below full scale can be measured using the 100dB Range, but not with the usual accuracy of the 10dB Range.

Table 3-2-2. Relative Advantages/Disadvantages Of Range/Full Scale Selections.

Range Full Scale Combination	Relative Advantages	Relative Disadvantages
10dB/AUTO	<ul style="list-style-type: none"> — Highest accuracy — Highest (.01) resolution — Automatic selection of Full Scale for best Signal to Noise ratio obtainable without overloading. 	<ul style="list-style-type: none"> Under some circumstances, — Tuning is somewhat easier and faster with other combinations — Under some circumstances, the dynamic range of the instrument can be extended with other combinations.
100dB/AUTO	<ul style="list-style-type: none"> — Facilitates tuning — Rapid tuning to individual components of input signal. — Automatic selection of Full Scale for best Signal to Noise ratio obtainable without overloading. 	<ul style="list-style-type: none"> — 100dB Range is less accurate than the 10dB Range — 100dB Range has less resolution (.1dB) than 10dB range — Under some circumstances the dynamic range of the instrument can be extended with other combinations.
100dB/ENTRY	<ul style="list-style-type: none"> — Fast tuning (usually useful only in automated production applications) — Dynamic Range of the instrument can be extended <i>under some circumstances</i>. 	<ul style="list-style-type: none"> — Operator must determine and enter the Full Scale level — 100dB Range is less accurate than 10dB Range — 100dB Range has less resolution (.1dB) than 10dB Range.
10dB/ENTRY	<ul style="list-style-type: none"> — Fast tuning (usually useful only in automated production applications) — Dynamic range of the instrument can be extended <i>under some circumstances</i>. — Highest accuracy — Highest (.01dB) resolution. 	<ul style="list-style-type: none"> — Operator must determine and enter the Full Scale level — RARELY RESULTS IN BEST SIGNAL TO NOISE RATIO FOR MEASUREMENT.

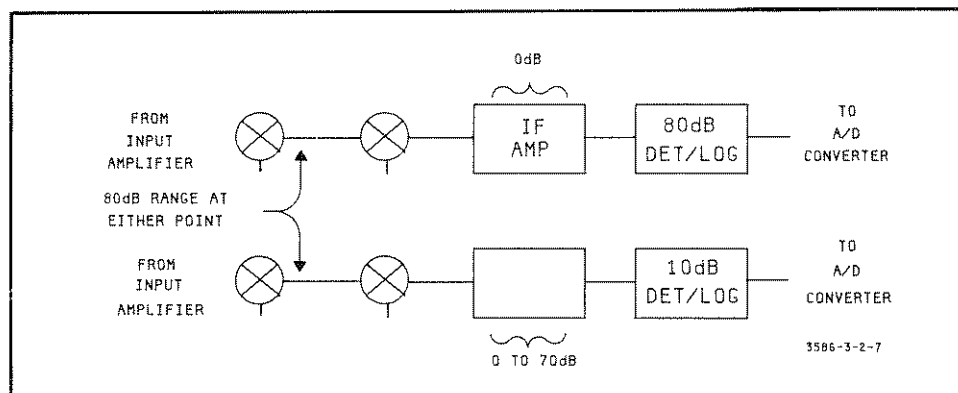

Figure 3-2-7. Comparison of 10dB and 100dB Ranges.

3-2-71. Full Scale. The Full Scale controls select the method of determining and entering the full scale level. If AUTOMATIC Full Scale is selected, the instrument automatically configures itself for the best signal to noise ratio obtainable without overloading. If ENTRY Full Scale is selected, the operator determines and enters a fixed full scale level.

NOTE

Explained as though instrument was in Low Distortion.

3-2-72. AUTOMATIC. This is the principal Full Scale operating mode of the instrument. As previously stated, when it is in this mode, the -hp- 3586A/B/C will configure itself for the best signal to noise obtainable without overloading. The noise referred to in this statement is not just thermal noise, but also includes intermodulation distortion products and spurious signals produced by the local oscillator. The amplitude of the thermal noise and the intermodulation distortion vary oppositely with respect to the full scale level. For example, reducing the full scale level with respect to a fixed input signal level effectively reduces the thermal noise and increases the intermodulation distortion. This relationship is illustrated in Figure 3-2-8. At a certain full scale level, the thermal noise and the intermodulation distortion are equal. In this instrument both are more than 70dB below the maximum input power when this happens. Note that the spurious signals caused by the local oscillator are even lower and do not vary with full scale. This is the full scale level selected by the instrument when it is in Automatic. It is the full scale level that gives the wide *reliable* dynamic range. No matter what the tuned frequency and no matter what the composition of the input signal when the instrument is in Automatic Full Scale, the operator can be certain that all noise is more than 70dB below maximum input power. Because of this and since full scale information is not needed when making measurements, the operator can generally ignore the full scale level once he has selected AUTO. Use AUTOMATIC full scale unless you need the specific advantages of the Entry mode.

3-2-73. Entry. After Entry Full Scale is initially selected, the operator determines and enters the full scale level. Entering a fixed full scale level can result in one of three advantages corresponding to three different and very specific circumstances. *If the circumstances do not exist or if the particular advantage of the Entry mode is not needed, use AUTOMATIC Full Scale.* Once AUTOMATIC is selected the operator can virtually forget the full scale function. Each of the three conditions where entering a fixed Full Scale is an advantage is treated separately as follows.

a. Entering a fixed full scale level eliminates the time required for the instrument to autorange each time it is tuned to a different signal. This results in a significant time saving

when many signals requiring the same full scale level are measured. Usually, these conditions exist only in applications involving automated production. To set the Full Scale level, first allow the instrument to determine the level while in AUTO and then switch to the Entry mode. This assures the best possible signal to noise ratio without overloading.

b. Constant autoranging caused by a fluctuating input signal can be eliminated by entering a fixed full scale level (use the 100dB range only for this purpose). Set the full scale level just above the peak of the fluctuating signal.

c. With certain signals, it is possible to optimize the signal to noise ratio by overdriving the instrument. The input is overdriven by entering a full scale level selected by the instrument in AUTOMATIC full scale. This application is more involved than the others and is explained in detail beginning with Paragraph 3-2-80.

3-2-74. The performance of the 100dB ENTRY Range and Full Scale combination is identical to the performance of the 100dB AUTO combination provided that the full scale levels are equal. There are no performance disadvantages when using 100dB ENTRY as long as the full scale level is carefully selected. The maximum input power is equal to the full scale level. Any full scale level from +20dBm to -45dBm and in 5dB increments can be entered using the procedure outlined in Paragraph 3-2-76.

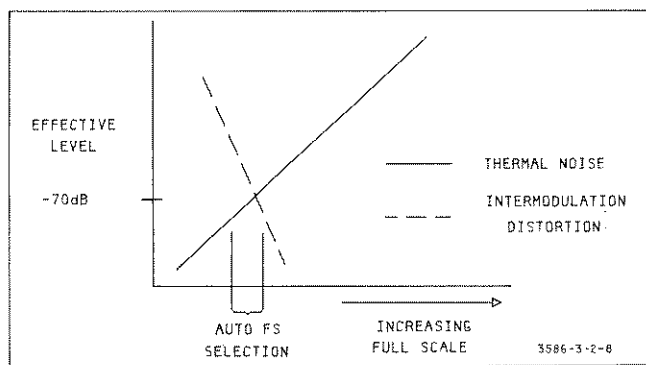

Figure 3-2-8. Relationship Between Thermal Noise, Intermodulation Distortion and Full Scale Selection In The 3586A/B.

3-2-75. The 10dB/ENTRY combination of Range and Full Scale must be used cautiously. Under the special circumstances described in Paragraph 3-2-81 it provides better performance than any other combination of Range and Full Scale. However, in any other applications, it is quite possibly the worst combination. 10dB/ENTRY is quite different from 10dB/AUTO. It is very *unlikely* that the signal to noise ratio will be optimum with this combination. It is useless to analyze the reasons for this reduction in noise performance since they are too complicated and too dependent on the nature of the input signal to be used as criteria for selecting the Range/Full Scale combination. It is much simpler to evaluate the use of this combination by comparing it with the alternatives. Recall that the only reasons for using 10dB/ENTRY are to optimize the signal to noise ratio and to speed tuning when making repetitive measurements requiring the same full scale level. Optimizing the signal to noise is described in Paragraph 3-2-81. When making repetitive measurements, compare 10dB ENTRY to 100dB ENTRY. The tuning speed is identical in both modes and it is likely that the noise reduction in 100dB/ENTRY will offset the additional linearity errors of the 100dB Range. This is especially true when the full scale level is near -50dBm. If neither mode provides satisfactory performance, 10dB AUTOMATIC should be used. The Maximum Input Power corresponding to each full scale level is given in Table 3-2-3 for the

10dB/ENTRY mode. Any full scale level from +20dBm to -120dBm and at 5dB increments can be entered using the procedure given in Paragraph 3-2-76.

Table 3-2-3. Maximum Input Power For Full Scale ENTRY and 10dB Range Combination.



Full Scale	Maximum Input Power	Full Scale	Maximum Input Power
20dBm	20dBm	-55dBm	15dBm
15dBm	20dBm	-60dBm	10dBm
10dBm	20dBm	-65dBm	5dBm
5dBm	20dBm	-70dBm	0dBm
0dBm	20dBm	-75dBm	-5dBm
-5dBm	20dBm	-80dBm	-10dBm
-10dBm	20dBm	-85dBm	-15dBm
-15dBm	20dBm	-90dBm	-20dBm
-20dBm	20dBm	-95dBm	-25dBm
-25dBm	20dBm	-100dBm	-30dBm
-30dBm	20dBm	-105dBm	-35dBm
-35dBm	20dBm	-110dBm	-35dBm
-40dBm	20dBm	-115dBm	-35dBm
-45dBm	20dBm	-120dBm	-35dBm
-50dBm	20dBm		

3-2-76. Entering The Full Scale Level. Use the following procedure to enter the full scale level. Legal entries are at five decibel intervals and between +11dB and -129dB for units of dBV, between +110dB and -30dB for dBpw and between +20dB and -120dB for dBm units. If an illegal entry is made, the full scale level will jump to the next highest permitted value.

STEP 1: Press 

STEP 2: Press 

STEP 3: Enter the digits as required.

STEP 4: Press  or  as appropriate.

STEP 5: Press 

3-2-77. Overload/Underload Indicators. The instrument is equipped with an input overload detector and an Intermediate Frequency (IF) Amplifier overload and underload detector.

3-2-78. Input Overload Indicator. An annunciator, located just to the left of the Measurement/Entry display, will flash "OVLD" whenever the drive to the first mixer in the instrument is excessive. When this happens, either increase the full scale level or reduce the level of the input signal. Measurements made while the input is overloaded *may* (Paragraph 3-2-9) be affected by intermodulation distortion. In AUTOMATIC Full Scale, the full scale level is automatically adjusted to prevent overloading. As a result, when the instrument is in this mode, the OVLD annunciator will flash only briefly during autoranging.

3-2-79. IF Overload/Underload. The IF underload/overload detector functions only when the 10dB Range is used. When the signal level in the IF amplifier is too high, the letters "OL" (Overload) will appear in the Measurement/Entry display. Either reduce the input signal level or increase the full scale level when this happens. In AUTOMATIC full scale, the full scale level is automatically selected to prevent overloading. Therefore, when the instrument is in AUTO, an overload indication will appear only momentarily during autoranging. An underload condition exists when the signal in the IF amplifiers is below the operating range of the Detector/Logger. The letters "UL" (Underload) appear in the Measurement/Entry display when this happens. IF Underloads occur in only the ENTRY Full Scale operating mode. Depending on the circumstances, one of three actions is indicated: 1) reduce the full scale; 2) increase the input signal level or 3) switch to the 100dB range.

3-2-80. Optimizing The Signal To Noise. The signal to thermal noise ratio can be improved by overdriving the input of the instrument. This is done by entering a full scale level that is lower than the one selected by the instrument when it is in AUTOMATIC Full Scale. Overdriving the input also raises the amplitude of the intermodulation distortion. If the power of the input signal is sufficiently dispersed throughout a wide bandwidth, even the increased intermodulation distortion will be negligible. Even when the input signal is not dispersed and the intermodulation distortion is not negligible, overdriving the input can still be useful. Intermodulation distortion products fall at distinct frequencies that depend on the frequencies of the originating signals and the order of the intermodulation distortion. Most of the frequency spectrum remains undisturbed. As long as there are no intermodulation products within the bandpass of the instrument, measurements are perfectly valid. Optimizing the signal to noise by overdriving the input is really a manual procedure for implementing the Low Noise measurement mode. The advantage of this manual procedure is that the input can be overdriven more than the fixed 5dB provided for by the Low Noise Measurement Mode. Overdriving the 100dB Range is very straightforward. Using the procedure given in Paragraph 3-2-82, the full scale level can be reduced to a minimum of -35dBm . Overdriving the 10dB Range is only slightly more involved.

3-2-81. Overdriving On The 10dB Range. When the instrument is operated on the 10dB Range, the thermal noise is affected *only by full scale changes between -50dB and -105dB* . Because of this, the input cannot be overdriven when the full scale level selected by the instrument in AUTO Full Scale is greater than -50dB . Likewise, it does no good to reduce the full scale level below -105dBm . Another restraint when trying to overdrive the input on the 10dB Range is the manner in which the full scale is determined. A particular full scale level may be dictated by the input overload detector or the IF overload detector. *Overdriving the input is possible only when the input overload detector is determining the full scale.* When it is determined by the IF overload detector, overdriving the input only causes the letters "OL" (overload) to appear in the Measurement/Entry display. When this happens, a better measurement could be made in 10dB/AUTO.

3-2-82. Use the following procedure to optimize the instrument's signal to noise ratio by overdriving the input.

STEP 1: Select the LOW DISTORTION Measurement mode.

STEP 2: Select AUTOMATIC Full Scale and the desired Range. The full scale level selected by the instrument will be used as a starting point.

- STEP 3:** Switch to ENTRY Full Scale. Display the full scale level (Press FULL SCALE). Is the full scale level greater than -35dB for the 100dB Range or between -50 and -105dB for the 10dB Range? If the full scale level is outside this range, then overdriving the input is not possible.
- STEP 4:** Reduce the Full Scale level 5dB. *The level reading in the Measurement/Entry display should drop slightly.*
- STEP 5:** Continue reducing the full scale level as long as the level reading continues to drop. The "OVL" annunciator will begin flashing after the first or second full scale reduction. When the level reading begins to increase or if the letters OL appear in the Measurement/Entry display, switch back to the first prior full scale level (i.e., the full scale level that caused the lowest level reading). The lowest level reading occurs when the signal to noise ratio is highest.

3-2-83. Bandwidth.

3-2-84. The primary function of the Bandwidth controls is to select how much of the frequency spectrum will be measured. Since the Bandwidth selections do not have the same selectivity, a secondary effect of these controls is to determine the selectivity of the instrument. The standard and optionally available bandwidths are described below.

3-2-85. 20Hz. The approximate selectivity curve of the 20Hz Bandwidth is illustrated in Figure 3-2-9. This Bandwidth can be used at any frequency within the range of the instrument (50Hz to 32.5MHz).

3-2-86. 400Hz. The approximate selectivity curve of the 400Hz Bandwidth is illustrated in Figure 3-2-10. When selected, local oscillator feedthrough limits the dynamic range of the instrument at Entry Frequencies of 1200Hz or less.

3-2-87. 2000Hz (-hp- 3586B). The approximate selectivity curve of the 2000Hz Bandwidth is illustrated in Figure 3-2-11. When selected, local oscillator feedthrough limits the dynamic range at Entry Frequencies greater than 5kHz. The 2000Hz Bandwidth is found on the Bell version of the instrument (-hp- 3486B). Of special interest to operators making measurements on telecommunications signals is the fact that 2000Hz is the noise bandwidth equivalent of a C-Message weighted 3100Hz bandwidth. This means that, *if the input signal is white noise*, an instrument equipped with this bandwidth will read the same level read by an instrument equipped with a C-Message weighted 3100Hz bandwidth. The correlation between the readings on the two instruments would vary with the similarity of the input signal to white noise.

3-2-88. 1740Hz (3586A, 3586B Option 002). The approximate selectivity curve of the 1740Hz Bandwidth is illustrated in Figure 3-2-12. When selected, local oscillator feedthrough limits the dynamic range at Entry Frequencies greater than 5kHz. The 1740Hz bandwidth is found on the CCITT version of the instrument (-hp- 3586A/B). Of special interest to operators making measurements on telecommunications signals is the fact that 1740Hz is the noise bandwidth equivalent of a psophometric weighted 3100Hz bandwidth. This means that, *if the input signal is white noise*, an instrument equipped with this bandwidth will read the same level read by an instrument equipped with a psophometric weighted 3100Hz bandwidth. The correlation between the readings on the two instruments would vary with the similarity of the input signal to white noise.

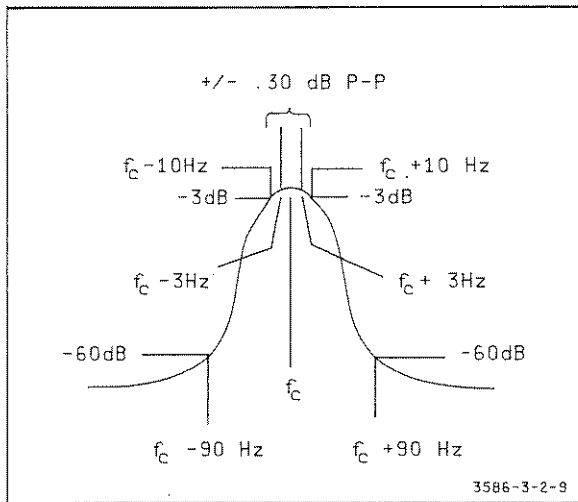

Figure 3-2-9. Approximate Selectivity Curve For The 20Hz Bandwidth.

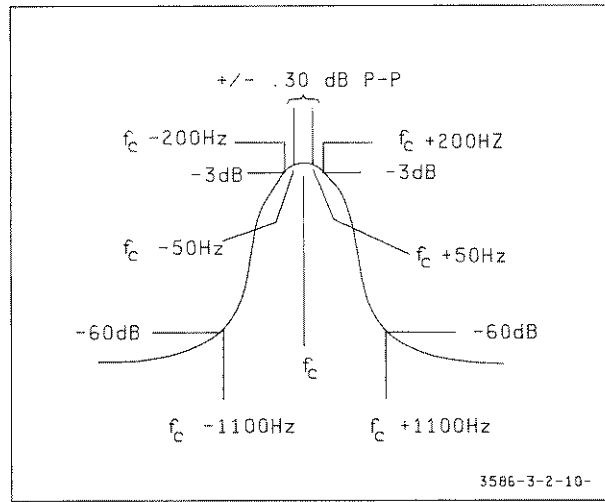

Figure 3-2-10. Approximate Selectivity Curve For The 400Hz Bandwidth.

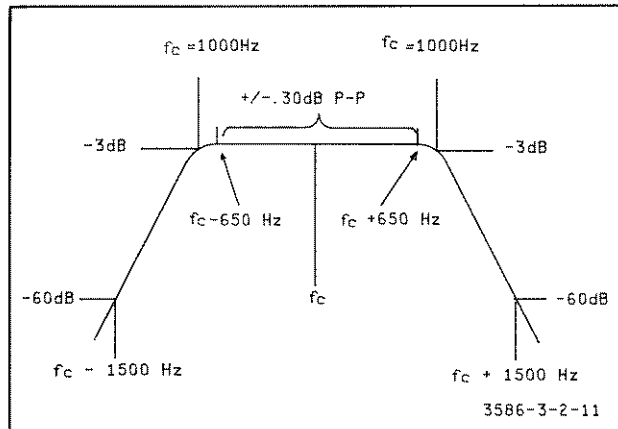

Figure 3-2-11. Approximate Selectivity Curve For The 2000Hz Bandwidth.

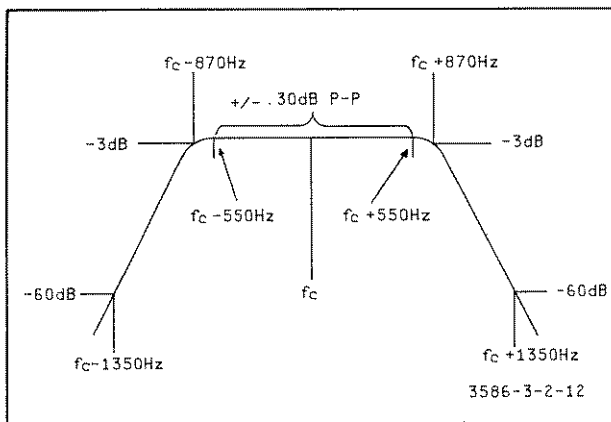

Figure 3-2-12. Approximate Selectivity Curve For The 1740Hz Bandwidth.

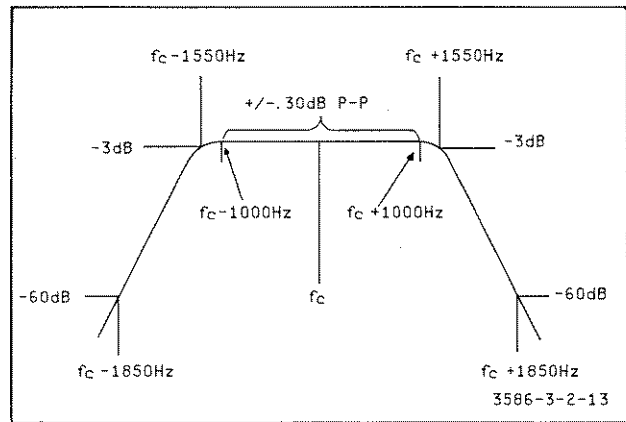

Figure 3-2-13. Approximate Selectivity Curve For The 3100Hz Bandwidth.

3-2-89. 3100Hz (Option 003). The approximate selectivity curve of the 3100Hz Bandwidth is illustrated in Figure 3-2-13. When selected, local oscillator feedthrough limits the dynamic range at Entry Frequencies greater than 5kHz. The 3100Hz Bandwidth is used in both the CCITT (-hp- 3586A) and Bell (-hp- 3586B) versions of the instrument. While this Bandwidth is useful for general purpose applications, it is especially valuable when troubleshooting problems in telecommunications systems. The bandwidth of a message channel is 3100Hz. Measurements of message channel signals at audio frequencies are usually made with wide-band instruments. As a result, the frequency response is extremely flat across the 3100Hz bandwidth of the message channel. Even though the measuring instruments have a wide bandwidth, only the power in the 3100Hz message channel is measured since the line, carrying the message channel, is somewhat selective. When a message channel is translated to some high level in the FDM hierarchy, it is difficult to measure its level precisely because of the nearness of the adjacent channels. Most filters that are flat enough to pass all components of the signal unattenuated cannot adequately discriminate against adjacent channel signals. Likewise, filters with good adjacent channel rejection also discriminated against the signals near the edges of the bandpass. The extremely flat and selective 3100Hz bandpass filter in the -hp- 3586A/B is an exception (see Figure 3-7-13). Using this filter, very accurate level measurements of message channel signals can be made. More important, all measurements (impairment as well as level) of message channels at high frequencies in the FDM hierarchy will correspond to similar measurements made on the same signals at different locations where the message channel is at audio frequencies.

3-2-90. WTD 3100Hz (Weighted). The Weighted Bandwidth is used exclusively for noise measurements on telephone message channels. When the WTD Bandwidth is selected, either a psophometric (-hp- 3586A/CCITT version) or a C-Message (-hp- 3586B/Bell version) filter is placed in series with the 3100Hz Bandwidth filter. Both plots of these weighting curves are illustrated in Figure 3-2-14. Measurements of weighted noise signals correspond closely to subjective evaluations of the unweighted noise level.

3-2-91. Units.

3-2-92. Units of dBm, dBpw, dB.775V or dBV (-hp- 3586C only) can be selected for the amplitude level presented in the Measurement/Entry display by pressing the corresponding UNITS control. The 0dBm reference level is one milliwatt dissipated in the impedance selected from the TERMINATION control group. Similarly, the 0dBpw reference level is one picowatt dissipated in the impedance selected from the TERMINATION control group. Note that units of dBpw are identical to the dBm units used in some segments of the Telecommunications Industry when making level measurements. The reference level of the dB.775V units is .775 volt; the reference level of the dBV units is one volt. Annunciators located next to the Amplitude Level Display label the displayed amplitude with the selected units.

3-2-93. Averaging.

3-2-94. Averaging reduces the range of the random variations in the measured level. To the operator, variations in the measured level appear as racking of the Measurement/Entry display or as ripple on the rear panel METER output. These variations arise from two sources. One source is noise - either the internal noise of the instrument or noise in the input signal. The second source is somewhat obscure. When the input signal consists of two or more constant amplitude signals, with nearly the same frequency, a beat note is created that appears as a level variation to the Detector/Logger in the instrument. As expected, another

performance parameter must be traded off to obtain the reduced racking provided by AVERaging. Measurements occur at approximately one to two second intervals when AVERaging is on, five times slower than the measurement speed during normal operation. Five measurements are averaged, then displayed. The criteria for selecting the AVERaging measurement mode is simple. *Select AVERaging whenever the racking of the Measurement/Entry display does not permit the desired measurement accuracy and/or resolution.*

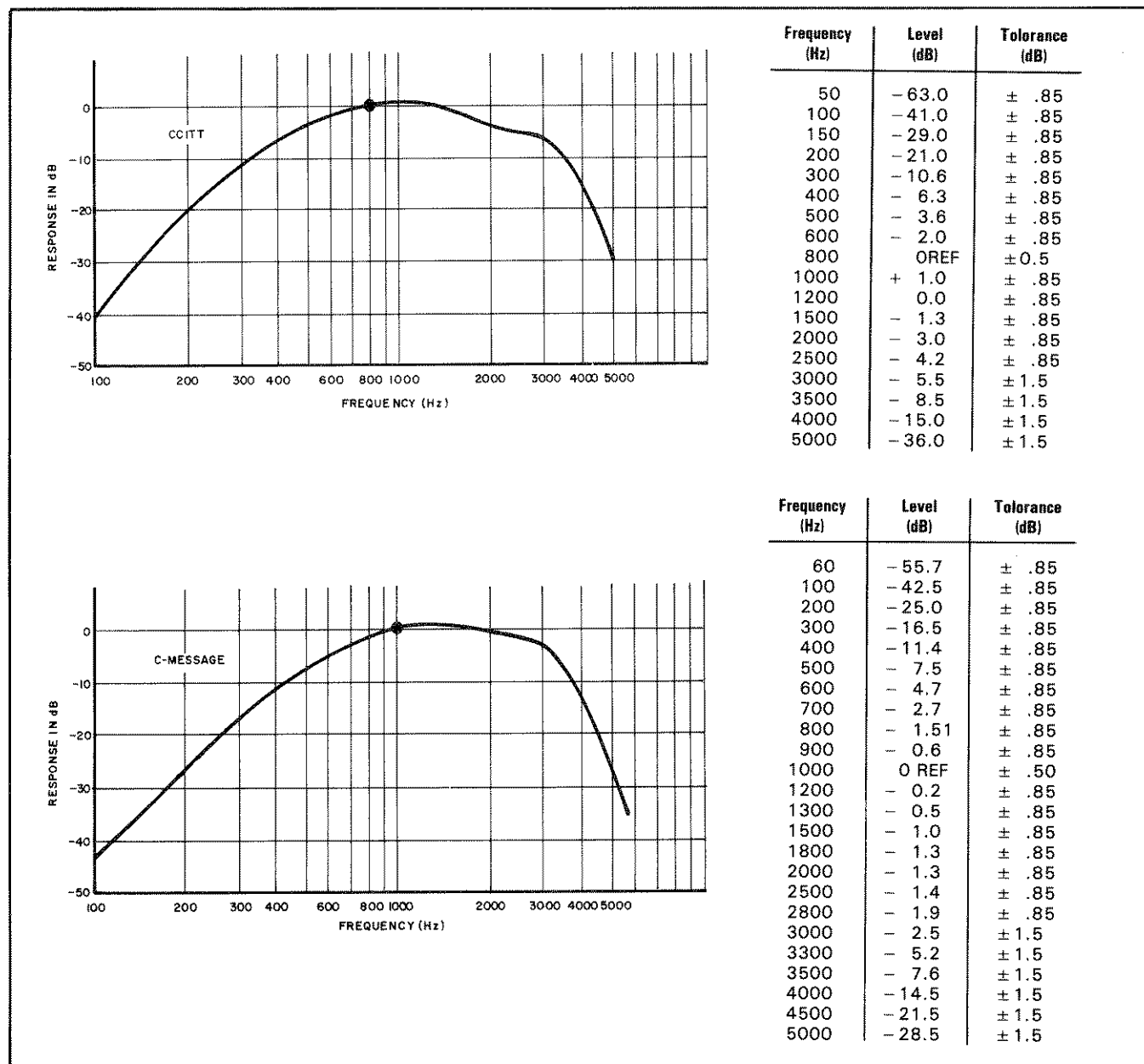

Figure 3-2-14. Weighting Curves Used For WTD 3100Hz Bandwidth Selection.

3-2-95. Averaging And Noise. An instrument can never measure just the signal. It always measures the input signal plus the internal noise of the instrument. As a result, the *average* level reading will be slightly higher than the actual level being measured. Note the word *average*; the reason for it will become apparent later in the paragraph. How much the noise offsets the measurement from its actual level depends on the signal to noise ratio to the instrument or of the incoming signal. As the signal level is increased, the difference between

the measured and actual signal level diminishes. For example, if the input signal level is -80dBm and the RMS level of the noise is -90dBm , the instrument will measure a level of -77.61dBm . However, increasing the input signal level to -10dBm , causes the instrument to measure -9.99913dBm . Obviously, this will be read as -10dBm . If the noise were a sine wave, or any other consistent waveshape for that matter, the offset level reading would at least be consistent. Unfortunately, this is not the case. The amplitude of the noise varies randomly with time. The random variation of the noise causes the level reading to fluctuate. This is the reason for the word *average* noted earlier in the paragraph. It can only be said that the *average* level reading will be slightly higher than the actual level being measured. Individual readings may be quite lower or higher than the input signal level because of the instantaneous value of the noise. To the operator measuring a signal, the level readings tend to change randomly or to "rack". How much the readings rack is a function of the signal to noise ratio in the instrument and the instrument design. Oftentime the signal to noise ratio is so high that the variation in the level is much lower than the resolution of the instrument. In those cases, the level appears constant.

3-2-96. The effect of AVEraging is to reduce the racking of level measurements (i.e., the range of the random level changes). As a result, *most* level measurements are closer to the actual input signal plus RMS noise level. This not only increases the probability that a single measurement will be accurate, but also makes it easier for an operator to interpolate the actual level when the display is racking. The effect of Averaging is illustrated in Figure 3-2-15. The diagram emphasizes the two most important facts about the effect of averaging level measurements: *Averaging reduces the variation of the level measurements, but does not affect the actual noise content.* Note that the width of the curves in the diagram do not necessarily imply a wide variation in level readings. For some input signal levels the entire range of the horizontal axis could be less than $.005\text{dBm}$.

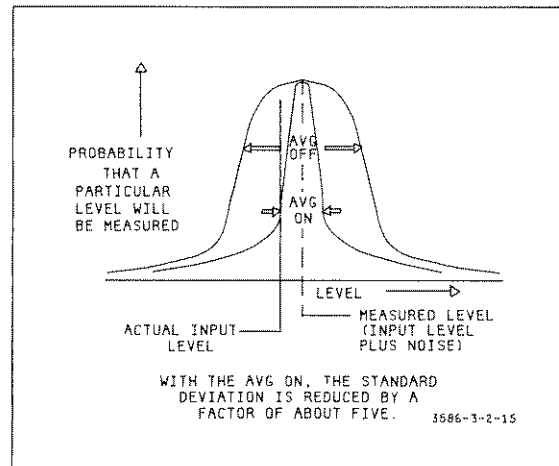



Figure 3-2-15. Effect Of Averaging On Level Measurements.

3-2-97. **Averaging And Closely Spaced Input Signals.** There is an inherent problem when measuring the true RMS level of a composite waveform consisting of two or more constant amplitude signals with closely spaced frequencies. The instantaneous voltage of such a waveform varies at a frequency equal to the difference frequency of the originating signals. When the difference frequency is low enough, the true RMS detector follows the composite waveshape. This causes the Measurement/Entry display to fluctuate in a pseudo random fashion and creates errors in the measured level. When AVEraging is on, the racking of the display and the measurement errors are reduced by extending the frequency response of the detector. A maximum of 0.5dB of error will be displayed when the two frequencies are

greater than 100Hz apart with the AVE off. With the AVE on, a maximum of 0.5dB of error will be displayed when the two frequencies are greater than 10Hz apart. The amount of racking and the measurement error both vary as a function of the difference frequency, relative amplitude of the originating signals and the number of signals contributing to the problem. Fortunately, the magnitude of the measurement error is well below the apparent racking of the display. Because of this, objectionable display racking is sufficient criteria for selecting the AVeraging mode.

3-2-98. Offsets.

3-2-99. When the OFFSET OFF/ON control is on, an offset stored within the instrument is subtracted from the measured signal level. The result is then presented in the Measurement/Entry Display. An "0" is appended to the unit's annunciator to indicate that the displayed level is offset. Zero is subtracted from the measured signal level if no offset has been entered. An offset can be entered by entering its magnitude directly or by transferring an amplitude reading to the offset storage register. Entries can be made with the OFFSET OFF/ON control either on or off. Offsets are retained until another value is entered or the instrument is turned off. To display the Offset, press . Press  to resume measurement.



NOTE

Make the Units selection before entering the offset. Offsets are not referenced to any particular impedance or level. Because of this, the magnitude of an entered offset does not change when the Units are changed.



3-2-100. Direct Offset Entry. Use the following procedure to directly enter the magnitude of an offset. Any value from -199.99dB to $+199.99\text{dB}$ can be entered.

STEP 1: Press  in the Entry control group. The current offset will appear in the Measurement/Entry display.

STEP 2: Enter the digits and decimal point as required.

STEP 3: Press  or  as appropriate.

STEP 4: Press  to resume measurement.

The contents of the offset register can be changed in one dB step using the Increment and Decrement keys. Press , then press  or  as desired.

3-2-101. Offset Entry By Transfer. This method of entering offsets is especially valuable when measuring one signal level relative to another. Use the following procedure to transfer an amplitude reading to the offset storage register.

Press . The entered offset will appear in the Measurement/Entry display.



CHAPTER THREE

WIDEBAND

3-3-1. Wideband is a nonselective measurement mode used to measure the total power of the input signal.

3-3-2. Measurement Mode.

3-3-3. The Wideband measurement mode is selected by pressing the WIDEBAND control. Only the following controls or groups of controls are functional when the instrument is in the Wideband mode: POWER, AUTOMATIC CALIBRATION, the MEASUREMENT/ENTRY controls, the TERMINATION controls, the MEASUREMENT controls and the OFFSET and FULL SCALE functions in the ENTRY control group.

3-3-4. Input Termination.

3-3-5. **10k Ω ||50pf (75 Ohm).** Bridged input calibrated to read absolute power levels when connected across 75 ohms. The maximum input power is +27dBm. Up to 42VDC can be applied to this termination (see Paragraph 3-2-11).

3-3-6. **75 Ohm.** Terminated 75 ohm input. The maximum input power equals +27dBm. If DC voltage is applied to this input, the DC power plus the AC power must not exceed 0.5 watts (see Paragraph 3-2-11).

3-3-7. **10k Ω ||50pf (50 Ohm).** Bridged input calibrated to read absolute power levels when connected across 50 ohms. The maximum input power is +27dBm. Up to 42VDC can be applied to this input. This input is found only on the -hp- 3586C version of the instrument (see Chapter 2).

3-3-8. **50 Ohms.** Terminated 50 ohm input. The maximum input power is +27dBm. If DC is applied to this input, the DC power plus the AC power must not exceed .5 watts. This input is found only on the -hp- 3586C version of the instrument (see Chapter 2).

3-3-9. **135 Ohms.** Balanced input terminated in 135 ohms. The maximum input power is +27dBm. A differential or common mode DC voltage of up to 42 volts can be applied to this input. This input appears only on the -hp- 3586B.

3-3-10. **150 Ohms.** Balanced input terminated in 150 ohms. The maximum input power is +27dBm. This input appears only on the -hp- 3586A.

3-3-11. **124 Ohms.** Balanced input terminated in 124 ohms. The maximum input power is +27dBm. A differential or common mode DC voltage of up to 42 volts can be applied to this termination. Do not connect anything to the 135 ohm input while using this input. This input is found only on the -hp- 3586B.

3-3-12. **Bridged.** Bridged and balanced input calibrated to read absolute power levels across 600 ohms. The maximum input power is +27dBm. A differential or common mode voltage of up to 42 volts DC can be applied to this termination. This input appears only on the -hp- 3586A and B (see Paragraph 3-2-29).

3-3-13. 600 Ohms. Balanced input terminated in 600 ohms. The maximum input power is +27dBm. A differential or common mode voltage of up to 42 VDC can be applied to this termination.

3-3-14. Instrument Configuration For Wideband Measurements.

3-3-15. Full Scale. Use AUTOMATIC Full Scale unless you need the special advantage of the Entry mode. When AUTO full scale is used, the instrument automatically configures the instrument for the best signal to noise ratio obtainable without overloading. The entry mode is useful when making repetitive measurements at the same signal level. In these applications, using the Entry mode eliminates the time required for the instrument to autorange to each new input signal.

3-3-16. Averaging.

NOTE

Additional information on the Averaging function is given in Chapter Two beginning with Paragraph 3-2-95.

3-3-17. Averaging reduces the range of the random variations in the measured level. To the operator, variations in the measured level appear as racking of the Measurement/Entry display or as ripple on the rear panel METER output. These variations arise from two sources. One source is noise - either the internal noise of the instrument or noise in the input signal. The second source is somewhat obscure. When the input signal consists of two or more constant amplitude signals, with nearly the same frequency, a beat note is created that appears as a level variation to the Detector/Logger in the instrument. As expected, another performance parameter must be traded off to obtain the reduced racking provided by AVERAGING. Measurements occur at approximately one second intervals when AVERAGING is on; four times slower than the measurement speed during normal operation. Four measurements are averaged and displayed. The criteria for selecting the AVERAGING measurement mode is simple. *Select AVERAGING whenever the racking of the Measurement/Entry display does not permit the desired measurement accuracy and/or resolution.*



3-3-18. Units.

3-3-19. Units of dBm, dBpw, dB.775V or dBV can be selected for the amplitude level presented in the Measurement/Entry Display by pressing the corresponding UNITS control. The 0dBm reference level is one milliwatt dissipated in the impedance selected from the TERMINATION control group. Note that units of dBpw are identical to the dBm units used in some segments of the Telecommunications Industry when making level measurements. The reference level of the dBV units is one volt. The reference level for dB.775V is .775 volts. Annunciators located next to the Amplitude Level Display label the displayed amplitude with the selected units.

3-3-20. AUTO-CALibration. AUTO CAL should be left on virtually all the time. A complete discussion of AUTO CAL is given beginning with Paragraph 3-1-17.

3-3-21. Offsets.

3-3-22. When the OFFSET OFF/ON control is on, an offset stored within the instrument is

subtracted from the measured signal level. The result is then presented in the Measurement/Entry Display. An "0" is appended to the unit's annunciator to indicate that the displayed level is offset. Zero is subtracted from the measured signal level if no offset has been entered. An offset can be entered by entering its magnitude directly or by transferring an amplitude reading to the offset storage register. Entries can be made with the OFFSET OFF/ON control either on or off. Offsets are retained until another value is entered or the instrument is turned off. To display the Offset, press . Press  to resume measurement.



NOTE

Make the Units selection before entering the offset. Offsets are not referenced to any particular impedance or level. Because of this, the magnitude of an entered offset does not change when the Units are changed.

3-3-23. Direct Offset Entry. Use the following procedure to directly enter the magnitude of an offset. Any value from -199.99dB to $+199.99\text{dB}$ can be entered.

STEP 1: Press  in the Entry control group. The current offset will appear in the Measurement/Entry Display.

STEP 2: Enter the digits and decimal point as required.

STEP 3: Press  or  as appropriate.

STEP 4: Press  to resume measurement.

The contents of the offset register can be changed in one dB step using the Increment and Decrement keys. Press

, then press  or  as desired.

3-3-24. Offset Entry By Transfer. This method of entering offsets is especially valuable when measuring one signal level relative to another. Use the following procedure to transfer an amplitude reading to the offset storage register.

STEP 1: Press . The entered offset will appear in the Measurement/ Entry Display.

CHAPTER FOUR CARRIER

3-4-1. CARRIER is the measurement mode used when measuring the level of carrier leak signals or pilot tones.

3-4-2. MEASUREMENT MODE.

3-4-3. To select CARRIER, press (no shift) the CARRIER control. One other control is automatically set when this mode is selected:

BANDWIDTH 20Hz

The Bandwidth can be changed if desired.

3-4-4. INPUT TERMINATION.

3-4-5. Select the input TERMINATION in accord with the test point to which the instrument is being connected. The dominant consideration is the impedance. In the vast majority of cases, a terminated input with a particular impedance is required. The maximum input power of all inputs is +27dBm (.5 watts). For all inputs except the 50 ohm and 75 ohm inputs, the maximum DC voltage between any two terminal (including ground) is 42 volts. The total power (composite due to AC and DC) input to the 50 ohm and 75 ohm terminated inputs must not exceed .5 watts.

3-4-6. TUNING THE INSTRUMENT IN THE CARRIER MEASUREMENT MODE.

NOTE

If the instrument was tuned to the desired message channel while in another measurement mode, it will be properly tuned when Carrier is selected. The instrument automatically modifies its tuning according to the measurement mode.

3-4-7. The procedure for tuning the instrument to Carrier signals consists of five steps: 1) Select the Entry Frequency Mode; 2) Enter the Entry Frequency; 3) Search for the carrier signal or verify that the proper signal is being received; 4) count the signal and 5) transfer the count to the Entry Frequency register. The contents of the Entry Frequency register determine the tuned frequency of the instrument.

3-4-8. Instrument Configuration For Tuning.

3-4-9. Entry Frequency. Using the Entry Frequency Controls, the operator can choose between entering either the Carrier frequency or the Tone frequency when tuning the instrument to a message channel.¹ When TONE is selected, the RF frequency of a 1kHz (3586B) or 800Hz (3586A) test tone on the message channel is entered and displayed. Note that the tone need not be on the channel. Similarly, the Carrier frequency is entered and displayed when CARRIER is selected. The operator can choose whichever mode is most convenient regardless of the Measurement mode selection.

3-4-10. The Entry Frequency mode selection does not depend on the measurement mode selection. Each measurement mode has a frequency or band of frequencies associated with it that have a fixed relation to either of the Entry Frequencies. As long as the entered frequency is correct for the message channel and the Entry Frequency selection, the instrument will automatically tune to the frequency or band of frequencies required by the measurement mode. Since the purpose of these controls is to facilitate tuning when measuring signals in telecommunications systems, they are functional only when one of the SSB CHANNEL (i.e., telecommunications) measurement modes is selected. An annunciator in one of the controls remains lit while the instrument is in the Selective measurement mode to indicate how the displayed frequency will be interpreted if the instrument is switched to one of the SSB Channel measurement modes.

3-4-11. Miscellaneous Control Settings. The optimum control settings for tuning the instrument to Carrier signals are as follows:

RANGE..... 100dB
FULL SCALE..... AUTO

3-4-12. Coarse Tuning.

3-4-13. The instrument is coarsely tuned whenever the carrier leak signal is within the instrument bandpass. In most cases, coarse tuning is accomplished by simply entering the Entry Frequency (carrier or tone frequency as appropriate). An additional step may be required when carriers at high frequencies are measured. It may be necessary to search for the input signal or verify that the proper signal is being received - even when the frequency of the carrier is precisely known. This is because errors in the tuned frequency of the instrument cause the Entry Frequency to fall outside of the instrument bandpass.

3-4-14. Entering The Entry Frequency. Use the following procedure to enter either the carrier frequency or the RF test tone frequency in accord with the Entry Frequency mode selection.

STEP 1: Press

STEP 2: Enter the significant digits and decimal as required.

STEP 3: Press , or

¹Message channels are usually designated by their position in the FDM hierarchy (for example - Master Group Number, Supergroup Number, Group Number and Channel Number). Charts are available in the operating telephone offices that give either the Carrier or Tone frequency for each of the channels. Therefore, regardless of the exact frequency component of the message channel to be measured, it is easiest to tune the instrument using one of these two frequencies. The entry Frequency controls allow the operator to use either frequency.

3-4-15. Searching For The Input Signal. The instrument may not be precisely tuned to the carrier signal after the Entry Frequency has been entered. Errors in the frequency reference may cause the instrument bandpass to fall completely above or below the carrier signal frequency (see Figure 3-4-1). When this happens, the operator must search for the input signal or *verify that the signal being received is the desired signal. Note that an increase in the level indication does not guarantee that the instrument is properly tuned. The instrument may be tuned to the wrong signal!* Be especially cautious when tuning to carrier leak signals that are next to a pilot tone. It is possible to mistake the pilot tone for an excessive carrier leak signal. Since the tuning error caused by the frequency reference is proportional to frequency, searching for the input signal will be necessary only when high frequency carriers are measured. Also, the magnitude of the tuning error varies with the frequency reference used in the instrument. If the high stability frequency reference is used in the instrument, it may be necessary to search for the input signal only at the very highest frequencies. The approximate Entry Frequencies above which search for and/or verify if the input signal will be necessary are summarized in Table 3-4-1. A more comprehensive discussion of this step is given in Paragraph 3-2-56.

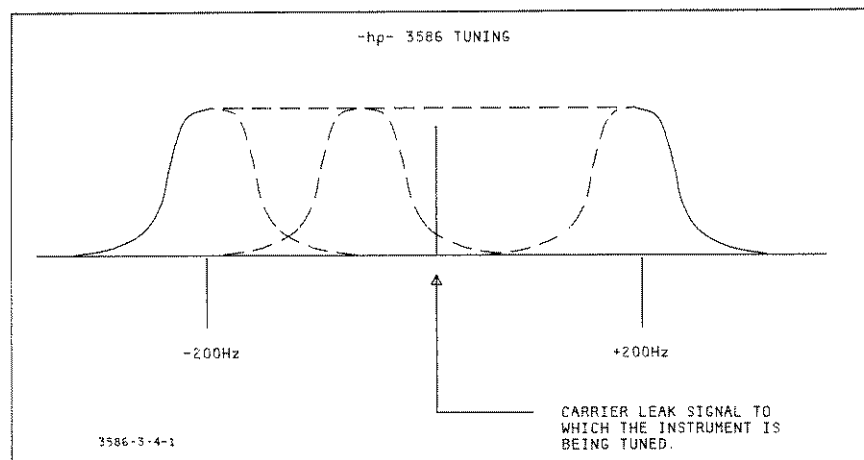

Figure 3-4-1. Tuning Error Of The Twenty Hertz Bandwidth.

Table 3-4-1. Frequencies At Which Signal Search May Be Required.

Frequency Reference	Bandwidth	
	400Hz	20Hz
None	Entry Frequency > 20MHz	Entry Frequency > 6MHz
Option 004		Entry Frequency > 20MHz

3-4-16. Use the following procedure to search for the carrier signal or to verify that the proper signal is being received.

STEP 1: Press in the Frequency Tune control group.

STEP 2: Using the Frequency Tune control, vary the tuned frequency above and below the Entry Frequency about 200Hz each way. Be sure that the signal to which the instrument is finally tuned has the proper relationship to other signals in the instrument bandpass.

STEP 3: Adjust the tuning for a peak response on the analog meter.

3-4-17. Fine Tuning.

3-4-18. The procedure given below is the most convenient method of fine tuning to Carrier signals.

STEP 1: Turn the Counter on. The counted frequency of the carrier will appear in the Frequency/Entry display.

STEP 2: Press  (Counter to Frequency).

This causes the counter reading to modify the contents of the Entry Frequency register. The new Entry Frequency will be displayed for a few seconds and the display reverts back to the counted frequency. The Entry Frequency will be different from the counted frequency if the SSB TONE Entry Frequency mode is used.

3-4-19. INSTRUMENT CONFIGURATION FOR CARRIER MEASUREMENTS.

3-4-20. The control settings given below are those typically chosen for Carrier Level Measurements. Other selections can be made if the operator desires. comprehensive information on each control is given in the paragraph referenced.

RANGE	(3-2-68)	10dB
FULL SCALE.....	(3-2-71)	AUTO
AVERAGE	(3-2-93)	OFF
CALIBRATION.....	(3-1-17)	ON

3-4-21. OFFSETS.

NOTE

The Offset feature is typically used for making amplitude measurements relative to the Test Level Point when measuring signals in telecommunications systems.

3-4-22. Amplitude measurement datas can be offset by a fixed amount if the operator wishes. The offset is entered either directly or by transferring an amplitude reading to the offset storage register. When the OFFSET ON/OFF control is on, the entered offset will be subtracted from the measured signal level and the result presented in the Measurement/Entry display. Zero is subtracted from the measured signal level if no offset has been entered. Entries can be made with the OFFSET OFF/ON control either on or off. Offsets are retained until another value is entered or the instrument is turned off. To display the Offset, press OFFSET. Press MEAS CONT to resume measurement.

NOTE



Make the Units selection before entering the offset. Offsets are not referenced to any particular impedance or level. Because of this, the magnitude of an entered offset does not change when the Units are changed.

3-4-23. Direct OFFSET ENTRY.



3-4-24. Use the following procedure to directly enter the magnitude of an offset. Any value from -199.99dB to $+199.99\text{dB}$ can be entered.

STEP 1: Press  in the Entry control group. The current offset will appear in the Measurement/Entry display.

STEP 2: Enter the digits and decimal point as required.

STEP 3: Press  or  as appropriate.

STEP 4: Press  to resume measurement.

3-4-25. The contents of the offset register can be changed in one dB step using the Increment and Decrement keys. Press , then press  or  as desired.

3-4-26. Offset Entry By Transfer.

3-4-27. This method of entering offsets is especially valuable when measuring one signal level relative to another. Use the following procedure to transfer an amplitude reading to the offset storage register.

STEP 1: Press . The entered offset will appear in the Measurement/Entry display.

CHAPTER FIVE

NOISE/DEMODULATION

(-hp- 3586A/B)

3-5-1. The principal uses of the NOISE/DEMODULATION measurement mode are: 1) measurement of idle message channel noise and 2) to translate message channel signals down to voice frequencies for monitoring or for output through the audio or headphone jacks.

3-5-2. Measurement Mode.

3-5-3. The NOISE/DEMODULATION measurement mode is selected by pressing the (no shift) NOISE/DEMOD control. One other control is automatically set when this mode is selected:

BANDWIDTH..... WIDEST

The bandwidth can be changed if desired. However, the combination of NOISE/DEMODULATION and one of the narrower bandwidths produce a trivial operating configuration.

3-5-4. Bandwidth. The widest bandwidth used on the instrument depends on the instrument model and options. Even though the various wide bandwidths are not operator selectable, they still should be understood. Each wide bandwidth selection has special characteristics that effect the interpretation of noise measurements.

3-5-5. 1740 Hz/2000Hz. The 1740 Bandwidth is the noise bandwidth equivalent of a psophometric weighted 3100Hz bandwidth. Likewise, 2000Hz is the noise bandwidth equivalent of a C-Message weighted 3100Hz bandwidth. This means that, *if the input signal is white noise*, an instrument equipped with one of these bandwidths would read the same level read by an instrument equipped with a 3100Hz bandwidth and the corresponding weighting filter. The correlation between the readings on the two instruments would vary with the similarity of the input signal to the white noise.

3-5-6. 3100Hz. The 3100 Bandwidth is especially valuable for troubleshooting subtle problems in telecommunications systems. All measurements (impairment as well as level) of signals at high levels in the FDM¹ hierarchy will correspond to similar measurements made on the same signals at different locations where the message channel signal is at audio frequencies. This is possible because of the excellent selectivity (Shape Factor $\cong 1.2$) and flatness (Bandpass Ripple $< .25\text{dB}$) of this filter. A more comprehensive description of this Bandwidth selection is given in Paragraph 3-2-89.

3-5-7. Input Termination.

3-5-8. Select the input TERMINATION in accord with the test point to which the instrument is being connected. The dominant consideration is the impedance. In the vast majority of cases, a terminated input with a particular impedance is required. The maximum input power of all input is +27dBm (.5 watts). For all inputs, except the 50 ohm and 75 ohm inputs, the maximum DC voltage between any two terminals (including ground) is 42 volts.

¹Frequency Domain Multiplexing.

The total power (composite due to AC and DC) input to the 50 ohm and 75 ohm terminated inputs must not exceed .5 watts.

3-5-9. TUNING THE INSTRUMENT IN THE NOISE/DEMODULATION MEASUREMENT MODE.

NOTE

If, while in another measurement mode, the instrument was tuned to the desired message channel, it will be properly tuned when NOISE/DEMODulation is selected. The instrument automatically modifies its tuning according to the measurement mode.

3-5-10. The procedure used to tune the instrument in the NOISE/DEMODulation measurement mode depends on the type of signal in the channel. Normally, an input signal must contain a dominant single frequency component if the instrument is to be fine tuned. Of course, neither voice or noise signals contain such a component. When the message channel is carrying voice traffic, this problem is easily overcome. The operator simply adjusts the tuning for natural sound. Tuning is not so easy when the channel contains only noise. Noise does not sound unnatural or significantly different when the instrument is mistuned. Fine Tuning to such a signal is impossible. To overcome this deficiency, a 1kHz test tone is temporarily placed on the message channel for the purpose of fine tuning. Of course, once the instrument is tuned, the 1kHz signal is removed. Note that if the instrument is equipped with an Option 004 high stability oven, fine tuning to noise signals is not necessary. The procedures for tuning to the two types of signals share several steps. These common steps are presented first. They are followed by the special steps required for each type of signal.

3-5-11. Instrument Configuration For Tuning.

3-5-12. **Entry Frequency.** Using the Entry Frequency Controls, the operator can choose between entering either the Carrier frequency or the Tone frequency when tuning the instrument to a message channel. When TONE is selected, the RF frequency of a 1004Hz (3586B) or 800Hz (3586A) test tone on the message channel is entered and displayed. Note that the tone need not be on the channel. Similarly, the Carrier frequency is entered and displayed when CARRIER is selected. The operator can choose whichever mode is most convenient regardless of the Measurement mode selection.

3-5-13. The Entry Frequency mode selection does not depend on the measurement mode selection. Each measurement mode has a frequency or band of frequencies associated with it that have a fixed relation to either of the Entry Frequencies. As long as the entered frequency is correct for the message channel and the Entry Frequency selection, the instrument will automatically tune to the frequency or band of frequencies required by the measurement mode. Since the purpose of these controls is to facilitate tuning when measuring signals in telecommunications systems, they are functional only when one of the SSB CHANNEL (i.e., telecommunications) measurement modes is selected. An annunciator in one of the controls remains lit while the instrument is in the Selective measurement mode to indicate how the displayed frequency will be interpreted if the instrument is switched to one of the SSB Channel measurement modes.

3-5-14. **Channel.** Select the channel in accord with the message channel signal being received.

—Configures the instrument to receive a lower sideband signal.

—Configures the instrument to receive an upper sideband signal.



3-5-15. Coarse Tuning.

3-6-16. The instrument is coarsely tuned whenever the input signal is within the instrument bandpass. In the NOISE/DEMODulation measurement mode, the instrument is coarsely tuned by simply entering the Entry Frequency (Carrier or Tone according to the Entry Frequency selection).

3-5-17. Entering The Entry Frequency. Use the following procedure to enter either the carrier frequency or the RF test tone frequency in accord with the Entry Frequency mode selection.

STEP 1: Press 

STEP 2: Enter the significant digits and decimal as required.

STEP 3: Press ,  or 

3-5-18. Fine Tuning.

3-5-19. Fine Tuning To Noise Signals. The procedure given below is usually the most convenient method of tuning the instrument to noise signals.

STEP 1: Place a 1kHz test tone on the message channel.

STEP 2. Turn on the . The counted RF frequency of the 1kHz test tone on the message channel will appear in the Frequency/Entry Display.

STEP 3. Press  (Counter to Frequency).

This causes the counter reading to modify the contents of the Entry Frequency register. The new Entry Frequency will be displayed for a few seconds and then the display reverts back to the counted frequency. The Entry Frequency may be different from the counted frequency depending on the instrument model and Entry Frequency mode.

STEP 4. Remove the 1kHz signal from the message channel. The instrument is now precisely tuned to the message channel signal.

3-5-20. Fine Tuning The Instrument To Voice Signals. The instrument is easily fine tuned when the message channel is carrying a voice signal. The operator simply adjusts the tuning for natural sound. This procedure is given in greater detail as follows:

STEP 1: Press



in the Entry Control Group. Verify that the Frequency Step is 1Hz or less. If it is greater, enter 1Hz

(press  and  in the Entry Control Group).

STEP 2: Press



in the Frequency Tune control group.

STEP 3: Tune the Volume *down*. Attach headphones if desired.

STEP 4: Tune the Volume up to a comfortable level.

WARNING

With the exception of the tuning instructions given in subsequent steps, turn the Volume control fully counterclockwise when changing the instrument configuration. Changes, such as tuning and range, can cause sudden increases in the audio level that could damage hearing. This is especially true if the operator is using headphones.

STEP 5: Adjust the Frequency Tune control for natural sound.

STEP 6: Turn the volume control fully counterclockwise.

The instrument is now precisely tuned to the message channel signal.

3-5-21. Instrument Configuration For Noise/Demodulation Measurements.

3-5-22. Averaging. An input signal consisting of noise will naturally cause the displayed amplitude to rack. Use Averaging to reduce the range of variations in the measured level. Random level variations are evidenced by an erratic level reading in the Measurement/Entry display and by ripple in the rear panel meter output signal. The variations may be due to noise in the input signal, internal instrument noise or low frequency beat notes caused by two or more closely spaced frequencies in the input signal. (The beat frequency phenomenon would usually not occur with the type of input signals normally measured in the NOISE/DEMODulation mode.) The typical use of AVEraging in this mode is to reduce the *nominal* range of the amplitude variations during noise measurements. Its effect is illustrated in Figure 3-5-1. The outer curve describes the instrument with AVEraging and the inner curve is for the instrument with Averaging. Both curves show the probability that a single reading will fall within a particular range of level. *On the average*, the instrument will read closer to the true RMS level of the noise when AVEraging is on. Note that the maximum range of signal variations is unchanged since a single noise measurement can (theoretically) be infinite in both cases. The price paid for the reduced racking is an increase in measurement time. The measurement rate is slowed from approximately four readings every second to approximately one per-second. Averaging is not normally used when the primary purpose is to monitor a message channel signal or to output the demodulated signal through the headphone or audio jacks. It has no effect on any of these outputs.

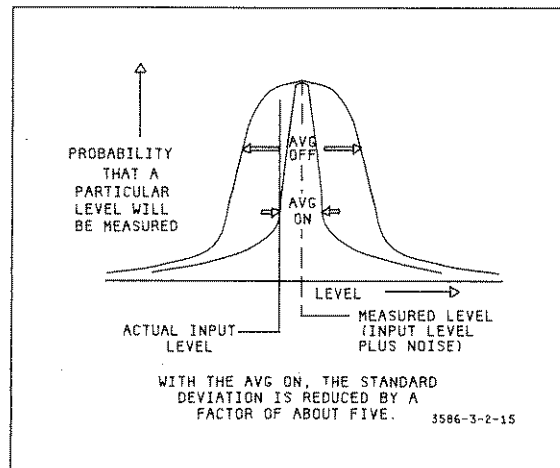

Figure 3-5-1. Effect Of AVeraging On Level Measurements.

3-5-23. WTD (Weighted - Option 002). The Weighted Bandwidth is used exclusively for noise measurements on telephone message channels. When the WTD Bandwidth is selected, either a psophometric (-hp- 3586A/CCITT version) or a C-Message (-hp- 3586B/Bell version) filter is placed in series with the 3100Hz Bandwidth filter. Both plots of these weighting curves are illustrated in Figure 3-5-2. Measurements of weighted noise signals correspond closely to subjective evaluations of the unweighted noise level.

3-5-24. Automatic Calibration. Turn the AUTO CAL off when the instrument is used strictly for monitoring a channel or for outputting a demodulated channel signal through the headphone or audio jacks. This will eliminate the interruption caused by the three minute calibration.

3-5-25. Miscellaneous Control Settings. The control settings listed are those typically chosen for noise level measurements or for monitoring message channel signals. Other selections can be made if the operator desires. Comprehensive information on each control is given in the reference paragraph.

Range	(3-2-68)	10dB
Full Scale	(3-2-71)	AUTO
Unit	(3-2-91)	ANY
Offset	(3-2-98)	EITHER

3-5-26. OFFSETS.

NOTE

The Offset feature is typically used for making amplitude measurements relative to the Test Level Point when measuring signals in telecommunications systems.

3-5-27. When the OFFSET OFF/ON control is on, an offset stored within the instrument is subtracted from the measured signal level. The result is then presented in the Measurement/Entry display. An "0" is appended to the unit's annunciator to indicate that the displayed level is offset. Zero is subtracted from the measured signal level if no offset has

been entered. An offset can be entered by entering its magnitude directly or by transferring an amplitude reading to the offset storage register. Entries can be made with the OFFSET OFF/ON control either on or off. Offsets are retained until another value is entered or the instrument is turned off. To display the Offset,

press **OFFSET** . Press **MEAS
●
CONT**

to resume measurement.

NOTE

Make the Units selection before entering the offset. Offsets are not referenced to any particular impedance or level. Because of this, the magnitude of an entered offset does not change when the Units are changed.

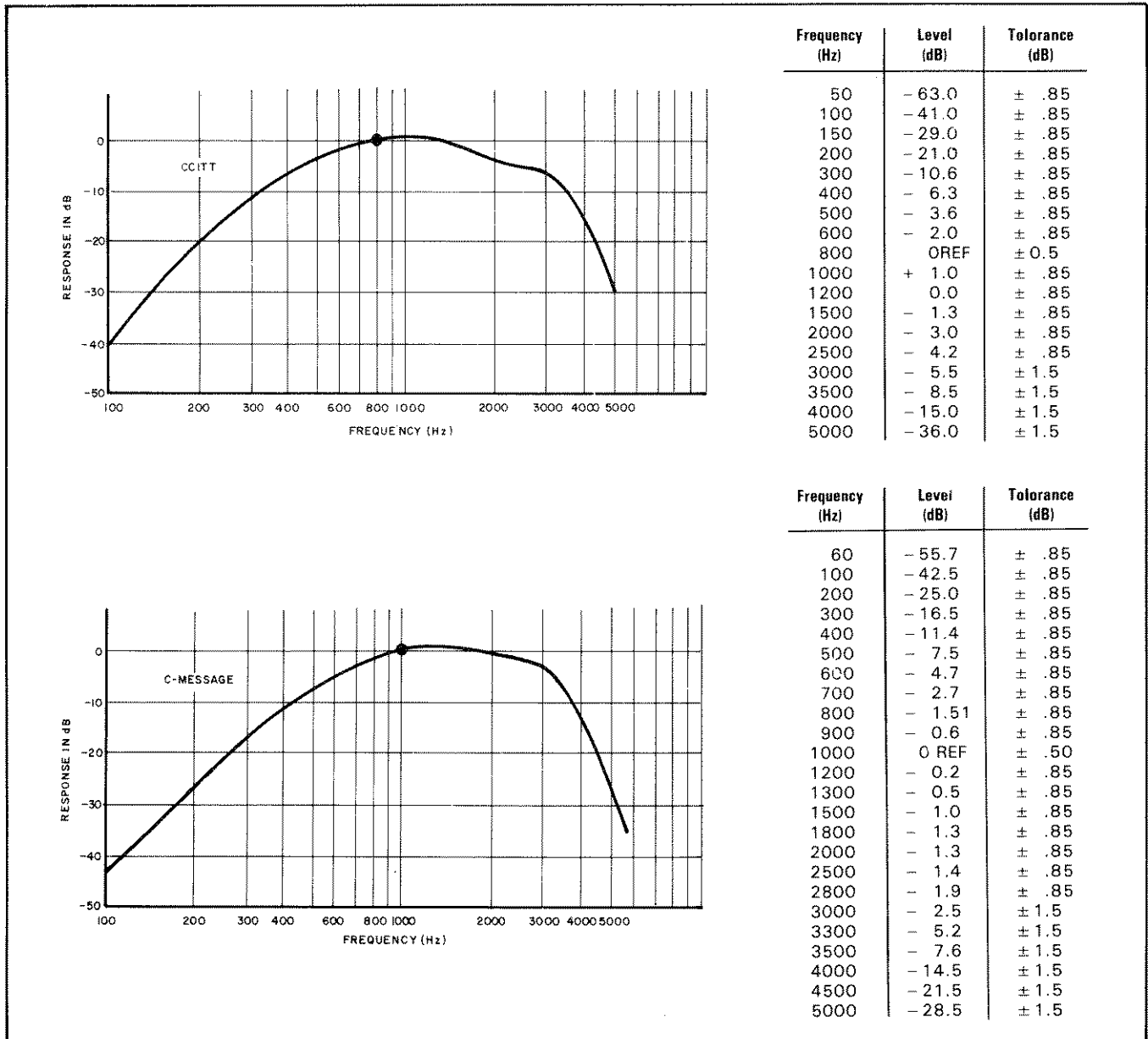





Figure 3-5-2. Weighting Curves Used For WTD Bandwidth Selection.

3-5-28. Direct OFFSET ENTRY.

3-5-29. Use the following procedure to directly enter the magnitude of an offset. Any value from -199.99dB to $+199.99\text{dB}$ can be entered.

STEP 1: Press  in the Entry control group. The current offset will appear in the Measurement/Entry display.

STEP 2: Enter the digits and decimal point as required.

STEP 3: Press  or  as appropriate.

STEP 4: Press  to resume measurement.

The contents of the offset register can be changed in one dB step using the Increment and Decrement keys.

Press , then press  or  as desired.

3-5-30. Offset Entry By Transfer.

3-5-31. This method of entering offsets is especially valuable when measuring one signal level relative to another. Use the following procedure to transfer an amplitude reading to the offset storage register.

STEP 1: Press . The entered offset will appear in Measurement/Entry display.

CHAPTER SIX

1010Hz, TONE 800Hz (3586A); TONE 1004Hz, 2600Hz (3586B)

3-6-1. These measurement modes are grouped together in a single chapter because they are implemented using practically the same procedure.

3-6-2. TONE 1004Hz is used to measure the level of 1004Hz signals on message channels. 1004Hz is the standard tone frequency in the Bell System.

3-6-3. 2600Hz is used to measure the level of 2600Hz inband signaling tones. The presence of a 2600Hz tone on a channel indicates that it is idle.

3-6-4. 1010Hz is used to measure the level of 1010Hz tones on message channels.

3-6-5. TONE 800Hz is used to measure the frequency of 800Hz signals on message channels. 800Hz is the standard tone frequency in the CCITT system.

3-6-6. The SIGNAL TO NOISE RATIO of a message channel can be measured easily by using either 1004/TONE or 1010 in conjunction with the Noise/Tone measurement mode (see Chapter Eight). Measure the level of the tone in either 1004/TONE or 1010 measurement mode. Transfer this reading to the offset register and turn the Offset ON. This establishes the reference level for the signal to noise measurement. Switch the instrument to Noise/Tone. The negative of the displayed reading is the Signal to Noise Ratio.

3-6-7. MEASUREMENT MODE.

3-6-8. The individual measurement modes are selected by pressing the corresponding key with the shift function (blue key) off. In each case, one other control is also selected:

BANDWIDTH 20Hz

The bandwidth may be changed if desired. Using the widest bandwidth (1740, 2000 or 3100) may result in an erroneous measurement.

3-6-9. INPUT TERMINATION.

3-6-10. Select the input TERMINATION in accord with the test point to which the instrument is being connected. The dominant consideration is the impedance. In the vast majority of cases, a terminated input with a particular impedance is required. The maximum input power of all inputs is +27dBm (.5 watts). For all inputs except the 50 ohm and 75 ohm inputs, the maximum DC voltage between any two terminals (including ground) is 42 volts. The total power (composite due to AC and DC) input to the 50 ohm and 75 ohm terminated inputs must not exceed .5 watts.

3-6-11. TUNING THE INSTRUMENT IN THE TONE 1004Hz, 2600Hz, 1010Hz AND TONE 800Hz MEASUREMENT MODES.

NOTE

If the instrument was tuned to the desired message channel while in another measurement mode, it will be properly tuned when any of the above measurement modes are selected. The instrument automatically modifies its tuning according to the measurement mode.

3-6-12. The procedure for tuning the instrument to any of the signals listed in Paragraph 3-6-11 consists of five steps:

1. Select the Entry Frequency mode,
2. Enter the Entry Frequency,
3. Adjust the tuning until a peak is obtained on the analog meter,
4. Count the frequency of the signal and
5. Transfer the count to the Entry Frequency register.

The contents of the Entry Frequency register determine the tuned frequency of the instrument.

3-6-13. Instrument Configuration For Tuning.

3-6-14. Entry Frequency. Using the Entry Frequency Controls, the operator can choose between entering either the Carrier frequency or the Tone frequency when tuning the instrument to a message channel.¹ When TONE is selected, the RF frequency of a 1004Hz (3586B) or 800Hz (3586A) test tone on the message channel is entered and displayed. Note that the tone need not be on the channel. Similarly, the Carrier frequency is entered and displayed when CARRIER is selected. The operator can choose whichever mode is most convenient regardless of the Measurement mode selection.

3-6-15. The Entry Frequency mode selection does not depend on the measurement mode selection. Each measurement mode has a frequency or band of frequencies associated with it that have a fixed relation to either of the Entry Frequencies. As long as the entered frequency is correct for the message channel and the Entry Frequency selection, the instrument will automatically tune to the frequency or band of frequencies required by the measurement mode. Since the purpose of these controls is to facilitate tuning when measuring signals in telecommunications systems, they are functional only when one of the SSB CHANNEL (i.e., telecommunications) measurement modes is selected. An annunciator in one of the controls remains lit while the instrument is in the Selective measurement mode to indicate how the displayed frequency will be interpreted if the instrument is switched to one of the SSB channel measurement modes.

3-6-16. Channel. Select the channel in accord with the message channel signal being received.

¹Message channels are usually designated by their position in the FDM hierarchy (for example - Master Group Number, Supergroup Number Group Number and Channel Number). Charts are available in the operating telephone offices that give either the Carrier or Tone frequency for each of the channels. Therefore, regardless of the exact frequency component of the message channel to be measured, it is easiest to tune the instrument using one of these two frequencies. The Entry Frequency controls allow the operator to use either frequency.



—Configures the instrument to receive an inverted (lower) sideband signal.



—Configures the instrument to receive an erect (upper) sideband signal.

3-6-17. Course Tuning.

3-6-18. The instrument is coarsely tuned whenever the RF signal generated by the tone in the message channel is within the instrument bandpass. In most cases, coarse tuning is obtained by simply entering the Entry Frequency (Carrier or Tone in accord with the Entry Frequency mode). An additional step is sometimes required when the instrument is being tuned to high frequency RF signals. With high frequency signals, it may be necessary to search for the RF signal even when its frequency is precisely known. This is because errors in the tuned frequency of the instrument cause the Entry Frequency to fall outside of the instrument bandpass.

3-6-19. Entering The Entry Frequency. Use the following procedure to enter either the carrier frequency of the RF test tone frequency in accord with the Entry Frequency mode selection.

STEP 1: Press  .

STEP 2: Enter the significant digits and decimal as required.

STEP 3. Press  ,  or 

3-6-20. Searching For The Message Channel Test Tone. Errors in the frequency reference of the instrument might cause its actual tuned frequency to fall completely above or completely below the RF frequency of the tone in the channel. Use the brief procedure given below to quickly locate the signal.

STEP 1: Press 

in the Frequency Tune Control group. This will activate the Frequency Tune Control.

STEP 2: Using the Frequency Tune Control, vary the tuned frequency of the instrument until a peak is obtained on the analog tuning meter.

3-6-21. Fine Tuning.

3-6-22. The procedure given below is usually the most convenient method of fine tuning the instrument to a tone on a message channel.

STEP 1: Turn the  on.

The counted RF frequency of the tone on the message channel will appear in the Measurement/Entry display.

STEP 2: Press  (Counter to Frequency).

This causes the counter reading to modify the contents of the Entry Frequency register. The new Entry Frequency will be displayed for a few seconds and then the display reverts back to the counted frequency. The Entry Frequency may be different from the counted frequency depending on the instrument mode and the Entry Frequency mode.

3-6-23. INSTRUMENT CONFIGURATION FOR TONE 1004Hz, 2600Hz, 1010Hz AND TONE 800Hz MEASUREMENTS.

3-6-24. The control settings listed below are those typically chosen for any of the measurement modes listed in Paragraph 3-6-23. Other selections can be made if the operator desires. Comprehensive information on each control is given in the referenced paragraph.

AUTOMatic CALibration.....(3-1-7)	ON
RANGE.....(3-2-68)	10dB
FULL SCALE.....(3-2-71)	AUTO
AVERage.....(3-2-93)	OFF
UNITS.....(3-7-91)	ANY

3-6-25. OFFSETS.

NOTE

The Offset feature is typically used for making amplitude measurements relative to the Test Level Point when measuring signals in telecommunications systems.

3-6-26. Amplitude measurement data can be offset by a fixed amount if the operator wishes. The offset is entered either directly or by transferring an amplitude reading to the offset storage register. When the OFFSET ON/OFF control is on, the entered offset will be subtracted from the measured signal level and the result presented in the Measurement/Entry display. Zero is subtracted from the measured signal level if no offset has been entered. Entries can be made with the OFFSET OFF/ON control either on or off. Offsets are retained until another value is entered or the instrument is turned off. To display the Offset,

press  . Press  to resume measurement.

NOTE



Make the Units selection before entering the offset. Offsets are not referenced to any particular impedance or level. Because of this, the magnitude of an entered offset does not change when the Units are changed.

3-6-27. Direct OFFSET ENTRY.

3-6-28. Use the following procedure to directly enter the magnitude of an offset. Any value from -199.99dB to +199.99dB can be entered.



STEP 1: Press  in the Entry control group. The current offset will appear in the Measurement/Entry display.

STEP 2: Enter the digits and decimal point as required.

STEP 3:  or  as appropriate.

STEP 4: Press  to resume measurement.

The contents of the offset register can be changed in one dB steps using the Increment and Decrement keys.

Press , then press  or  as desired.

3-6-29. Offset Entry By Transfer.

3-6-30. This method of entering offsets is especially valuable when measuring one signal level relative to another. Use the following procedure to transfer an amplitude reading to the offset storage register.

STEP 1: Press .

The entered offset will appear in the Measurement/Entry display.

CHAPTER SEVEN

ϕ JITTER

3-7-1. The Phase Jitter measurement mode is used to measure the incidental phase modulation of signals in telecommunications systems.¹ Signals typically measured are pilots, carriers and 1kHz tones on message channels. The amplitude of the phase jitter is presented in the Measurement/Entry display in units of peak to peak degrees. In addition, the detected phase jitter signal is available for further analysis from the ϕ Jitter output on the rear panel.

3-7-2. Measurement Mode.

3-7-3. The Phase Jitter measurement mode is selected by pressing the (shift-blue key) ϕ Jitter control. One other control is automatically set when this mode is selected:

BANDWIDTH..... Widest

The Bandwidth can be changed if desired. However, the combination of the ϕ Jitter Measurement Mode and one of the narrower bandwidths produces a trivial operating condition.

3-7-4. ϕ Jitter Output. The demodulated phase jitter signal is output through a BNC connector located on the rear panel. The sensitivity of this output is 166 mv/degree of phase jitter and the output impedance is 10k ohms. By analyzing this signal using an oscilloscope or a spectrum analyzer, the operator can often determine the cause of the ϕ Jitter.

3-7-5. Error Messages. The following error messages may be encountered while making ϕ Jitter measurements.

Er 1.1 — Attempting to use the 10dB Range for Phase Jitter or Impulse measurements.

Er 2.2 — Signal level is too low for valid phase jitter tests.

Er 2.9 — Phase Jitter overrange. If this error continues to be displayed after pressing



several times, the phase jitter is greater than 25 degrees peak to peak.

3-7-6. INPUT TERMINATION.



3-7-7. Select the input TERMINATION in accord with the test point to which the instrument is being connected. The dominant consideration is the impedance. In the vast majority of cases, a terminated input with a particular impedance is required. The maximum input power of all inputs is +27dBm (.5 watts). For all inputs except the 50 ohm and 75 ohm inputs, the maximum DC voltage between any two terminals (including ground) is 42 volts. The total power (composite due to AC and DC) input to the 50 ohm and 75 ohm terminated inputs must not exceed .5 watts.

¹Special frequency weighting characteristics of the ϕ Jitter measurement mode, required for measurements of telecommunication signals, make it impractical for other applications.

3-7-8. TUNING THE INSTRUMENT IN THE ϕ JITTER MEASUREMENT MODE.

NOTE

If the instrument was tuned to the desired message channel while in another measurement mode, it will be properly tuned when ϕ Jitter is selected. The instrument automatically modifies its tuning according to the measurement mode.

3-7-9. The phase jitter measurement circuitry is designed to accept a 1004Hz tone on a message channel once the instrument is tuned to the message channel. The procedure for tuning to a message channel is basically:

1. Select the Entry Frequency mode (Carrier or Tone).
2. Depending on the previous selection, enter either the Carrier or Tone frequency of the message channel carrying the 1004Hz test tone.
3. Count the RF frequency of the 1004Hz test tone.
4. Fine tune the instrument by using the counted frequency to modify the entered frequency.

This procedure is presented in detail in the following paragraphs. With slight modification, also given in the detailed procedure, the instrument can be tuned to signals not associated with message channels.

3-7-10. Instrument Configuration For Tuning.

3-7-11. Entry Frequency. Using the entry Frequency controls, the operator can choose between entering either the Carrier frequency or the Tone frequency when tuning the instrument to a message channel.² When Tone is selected, the RF frequency of a 1kHz (3586B) or 800Hz (3586A) test tone on the message channel is entered and displayed. Note that the tone need not be on the channel. Similarly, the Carrier frequency is entered and displayed when CARRIER is selected. The operator can choose whichever mode is most convenient regardless of the Measurement mode selection.

3-7-12. The Entry Frequency selection does not depend on the measurement mode selection. Each measurement mode has a frequency or band of frequencies associated with it that have a fixed relation to either of the Entry Frequencies. As long as the entered frequency is correct for the message channel and the Entry Frequency selection, the instrument will automatically tune to the frequency or band of frequencies required by the measurement mode. Since the purpose of these controls is to facilitate tuning when measuring signals in telecommunications systems, they are functional only when one of the SSB CHANNEL (i.e., telecommunications) measurement modes is selected. An annunciator in one of the controls remains lit while the instrument is in the Selective measurement mode to indicate how the displayed frequency will be interpreted if the instrument is switched to one of the SSB Channel measurement modes.

²Message channels are usually designated by their position in the FDM hierarchy (for example - Master Group Number, Supergroup Number, Group Number and Channel Number). Charts are available in the operating telephone offices that give either the Carrier or Tone Frequency for each of the channels. Therefore, regardless of the exact frequency component of the message channel to be measured, it is easiest to tune the instrument using one of these two frequencies. The entry Frequency controls allow the operator to use either frequency.

3-7-13. Channel. Select the Channel in accord with the signal being received. If a signal not associated with a message channel is being measured, it makes little difference which channel is selected.



— Configures the instrument to receive an inverted message channel (lower sideband signal).



— Configures the instrument to receive an erect message channel (upper sideband signal).

3-7-14. Coarse Tuning.

3-7-15. The instrument is coarsely tuned whenever the input signal is within the instrument bandpass. In the Phase Jitter measurement mode, the instrument is coarsely tuned by simply entering the Entry Frequency.

3-7-16. Entering The Entry Frequency. Use the following procedure to enter either the carrier frequency or the RF test tone frequency in accord with the Entry Frequency mode selection. If a signal not associated with a message channel is being measured (for example - the output of a carrier generator), enter its frequency.

STEP 1: Press 

STEP 2: Enter the significant digits and decimal as required.

STEP 3: Press  ,  or  as appropriate.

3-7-17. Fine Tuning The Instrument For φ Jitter Measurements. Basically, the procedure for fine tuning is to count the frequency of the signal to be measured and then use the results to modify the contents of the Entry Frequency register. The Entry Frequency register determines the tuned frequency of the instrument. This procedure is given as follows.

STEP 1: Turn the  On .

The counted RF frequency of the 1kHz test tone on the message channel will appear in the Frequency/Entry display.

STEP 2: Press  (Counter to Frequency).

This causes the counter reading to modify the contents of the Entry Frequency register. The new Entry Frequency will be displayed for a few seconds and then the display reverts back to the counted frequency. The Entry Frequency may be different from the counted frequency depending on the instrument model and the Entry Frequency mode.

3-7-18. If a 3586A (CCITT version) is being used to measure the φ Jitter of a signal not associated with a message channel, the Entry Frequency (press FREQ to obtain Entry Frequency) will be offset 200Hz from the counted frequency. However, both the instrument tuning and the counted frequency are correct. Simply ignore the Entry Frequency by leaving the counter on.

3-7-19. Instrument Configuration For ϕ Jitter Measurements.

3-7-20. Full Scale. Use AUTOMATIC Full Scale unless you need the special advantage of the Entry Full Scale mode. AUTOMATIC Full Scale offers two advantages over Entry Full Scale: 1) The dynamic range is wider ($\approx 75\text{dB}$ vs $\approx 45\text{dB}$) and; 2) the instrument will configure itself for the best signal to noise obtainable without overloading. The Entry mode is used only as a last resort to eliminate constant autoranging or when making repetitive measurements of signals with the same amplitude. Using the Entry mode when making repetitive measurements eliminates the time required for the instrument to autorange. This time savings is significant only during automated production testing.

3-7-21. If the system under test is lightly loaded,³ the total input power may fluctuate considerably. This in turn may cause the instrument to autorange almost constantly making it difficult to obtain a reading. If this occurs, turn the Averaging on. Among other things, the Averaging function dampens the autorange detector thereby reducing the tendency for the input circuitry to autorange on transient conditions. If the instrument still autoranges excessively, switch to the Entry full scale mode and enter a full scale level just above the peak of the fluctuating signal.

NOTE

The dynamic range of the instrument while in the Entry Full Scale mode is approximately 45dB. This is considerably less than the approximate 75dB dynamic range while in the AUTO Full Scale mode. Use caution when using Entry Full Scale. The noise performance of the instrument is degraded in this mode. If the ϕ Jitter must be measured with the instruments specified accuracy, measure the signal level in the 1004Hz measurement mode. The level must be within 45dB of the entered full scale for the instrument specifications to apply.

3-7-22. Range. When the instrument is in the AUTOMATIC Full Scale mode, the 10dB and 100dB Range performance are practically identical. Use whichever range is most convenient. Only the 100dB Range is permitted when the instrument is in Entry Full Scale.

3-7-23. Averaging. Use the Averaging function to reduce random variations in the phase jitter amplitude display or to reduce the tendency for the instrument to autorange in response to transient input conditions. Random variations in the displayed ϕ Jitter amplitude are caused by the internal noise of the instrument or by noise in the input signal. In either case, with Averaging on, the indicated reading will vary less around the actual ϕ Jitter level. The effect of Averaging on noise is explained thoroughly in Paragraph 3-2-93. This information applies to ϕ Jitter measurements with very little change. As mentioned in the discussion of Full Scale (Paragraph 3-7-20), averaging reduces the tendency of the instrument in autorange in response to transient changes in the input signal. If excessive autoranging is interfering with the phase jitter measurement, turn Averaging on.

³Lightly loaded: a small percentage of the total number of message channels are carrying traffic.

CHAPTER EIGHT

NOISE/TONE

3-8-1. Noise/Tone is used to measure the noise on a message channel in the presence of a 1kHz test tone. The 1kHz test tone forces all companders in the signal path to operate as if the channel contained voice traffic. This results in a more accurate indication of the noise under actual operating conditions.

3-8-2. The signal to noise ratio of a message channel can be measured easily by using Noise/Tone in conjunction with the Tone 1004 (3586B) or 1010 (3586A) measurement mode (see Chapter Six). Measure the level of the tone in the tone 1004 and 1010 measurement mode. Transfer this reading to the offset register and turn the Offset ON. This establishes the reference level for the signal to noise measurement. Switch the instrument to Noise/Tone. The negative of the displayed reading is the signal to noise ratio.

3-8-3. Measurement Mode.

3-8-4. The NOISE/TONE measurement mode is selected by pressing the (shift-blue key) NOISE/TONE control. One other control is automatically set when this mode is selected:

BANDWIDTH Widest

The bandwidth can be changed if desired. However, the combination of NOISE/TONE and one of the narrower bandwidths produces a trivial operating configuration.

3-8-5. **Bandwidth.** The widest bandwidth used on the instrument depends on the instrument model and options. Even though the various wide bandwidths are not operator selectable, they should still be understood. Each wide bandwidth selection has special characteristics that effect the interpretation of noise measurements.

3-8-6. *1740Hz/2000Hz.* The 1740Hz Bandwidth is the noise bandwidth equivalent of a psophometric weighted 3100Hz bandwidth. Likewise, 2000Hz is the noise bandwidth equivalent of a C-Message weighted 3100Hz bandwidth. This means that, *if the input signal is white noise*, an instrument equipped with one of these bandwidths would read the same level read by an instrument equipped with a 3100Hz bandwidth and the corresponding weighting filter. The correlation between the readings on the two instruments would vary with the similarity of the input signal to white noise.

3-8-7. *3100Hz.* The 3100Hz Bandwidth is especially valuable for troubleshooting subtle problems in telecommunications systems. All measurements (impairment as well as level) of signals at high levels in the FDM¹ hierarchy will correspond to similar measurements made on the same signals at different locations where the message channel signal is at audio frequencies. This is possible because of the excellent selectivity (Shape Factor $\cong 1.2$) and flatness (Bandpass Ripple $< .25\text{dB}$) of this filter. A more comprehensive description of this Bandwidth selection is given in Paragraph 3-2-89.

¹Frequency Domain Multiplexing.

3-8-8. Input Termination.

3-8-9. Select the input TERMINATION in accord with the test point to which the instrument is being connected. The dominant consideration is the impedance. In the vast majority of cases, a terminated input with a particular impedance is required. The maximum input power of all inputs is +27dBm (.5 watts). For all inputs except the 50 ohm and 75 ohm inputs, the maximum DC voltage between any two terminals (including ground) is 42 volts. The total power (composite due to AC and DC) input to the 50 and 75 ohm terminated inputs must not exceed .5 watts.

3-8-10. TUNING THE INSTRUMENT IN THE NOISE/TONE MEASUREMENT MODE.**NOTE**

If the instrument was tuned to the desired message channel while in another measurement mode, it will be properly tuned when NOISE/TONE is selected. The instrument automatically modifies its tuning according to the measurement mode.

3-8-11. The tuning procedure consists of entering the Entry Frequency, counting the input signal frequency and transferring the count to the Entry Frequency register. The Entry Frequency register determines the tuned frequency of the instrument.

3-8-12. Instrument Configuration For Tuning.

3-8-13. Entry Frequency. Using the Entry Frequency Controls, the operator can choose between entering either the Carrier frequency or the Tone frequency when tuning the instrument to a message channel.² When TONE is selected, the RF frequency of a 1kHz (3586B) or 800Hz (3586A) test tone on the message channel is entered and displayed. Note that the tone need not be on the channel. Similarly, the Carrier frequency is entered and displayed when CARRIER is selected. The operator can choose whichever mode is most convenient regardless of the Measurement mode selection.

3-8-14. The Entry Frequency mode selection does not depend on the measurement mode selection. Each measurement mode has a frequency or band of frequencies associated with it that have a fixed relation to either of the Entry Frequencies. As long as the entered frequency is correct for the message channel and the Entry Frequency selection, the instrument will automatically tune to the frequency or band of frequencies required by the measurement mode. Since the purpose of these controls is to facilitate tuning when measuring signals in telecommunications systems, they are functional only when one of the SSB CHANNEL (i.e. telecommunications) measurement modes is selected. An annunciator in one of the controls remains lit while the instrument is in the Selective measurement mode to indicate how the displayed frequency will be interpreted if the instrument is switched to one of the SSB Channel measurement modes.

3-8-15. Channel. Select the channel in accord with the message channel signal being received.

²Message channels are usually designated by their position in the FDM hierarchy (for example - Master Group Number, Supergroup Number, Group Number and Channel Number). Charts are available in the operating telephone offices that give either the Carrier or Tone frequency for each of the channels. Therefore, regardless of the exact frequency component of the message channel to be measured, it is easiest to tune the instrument using one of these two frequencies. The Entry Frequency controls allow the operator to use either frequency.

 — Configures the instrument to receive a lower sideband signal.

 — Configures the instrument to receive an upper sideband signal.



3-8-16. Coarse Tuning.

3-8-17. The instrument is coarsely tuned whenever the input signal is within the instrument bandpass. In the NOISE/TONE measurement mode, the instrument is coarsely tuned by simply entering the Entry Frequency.

3-8-18. Entering The Entry Frequency. Use the following procedure to enter either the carrier frequency or the RF test tone frequency in accord with the Entry Frequency mode selection.

STEP 1: Press 

STEP 2: Enter the significant digits and decimal as required.

STEP 3: Press ,  or 

3-8-19. Fine Tuning.

3-8-20. Use the procedure given below to fine tune the instrument to the tone on the message channel.

STEP 1: Turn the  On .

The counted RF frequency of the 1kHz test tone on the message channel will appear in the Frequency/Entry display.

STEP 2: Press  (Counter to Frequency).

This causes the counter reading to modify the contents of the Entry Frequency register. The new Entry Frequency will be displayed for a few seconds and then the display reverts back to the counted frequency. The Entry Frequency may be different from the counted frequency depending on the instrument model and Entry Frequency mode.

3-8-21. Instrument Configuration For Noise/Tone.

3-8-22. Averaging. Averaging reduces the random variations in the measured level. Random level variations are evidenced by an erratic level reading in the Measurement/Entry display and by ripple in the rear panel meter output signal. The variations may be due to noise in the input signal, internal instrument noise or low frequency beat notes caused by two or more closely spaced frequencies in the input signal. (The beat frequency phenomenon would usually not occur with the type of input signals normally measured in the NOISE/DEMODulation mode.) The typical use of AVeraging in this mode is to reduce the *nominal* range of the amplitude variations during noise measurements. Its effect is il-

illustrated in Figure 3-8-1. The outer curve describes the instrument without AVeraging and the inner curve is for the instrument with Averaging. Both curves show the probability that a single reading will fall within a particular range of level. *On the average*, the instrument will read closer to the true RMS level of the noise when AVeraging is on. Note that the maximum range of signal variations is unchanged since a single noise measurement can (theoretically) be infinite in both cases. The price paid for the reduced racking is an increase in measurement time. The measurement rate is slowed from approximately four readings every second to approximately one per second. Averaging is not normally used when the primary purpose is to monitor a message channel signal or to output the demodulated signal through the headphone or audio jacks. It has no effect on any of these outputs.

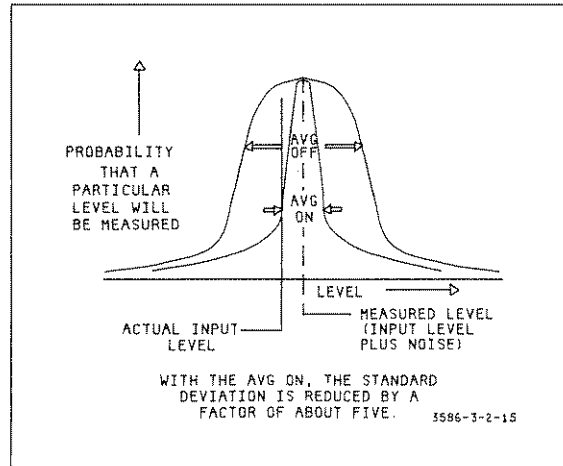

Figure 3-8-1. Effect of AVeraging On Level Measurements.

3-8-23. WTD (Weighted). The Weighted Bandwidth is used exclusively for noise measurements on telephone message channels. When the WTD Bandwidth is selected, either a psophometric (-hp- 3586A/CCITT version) or a C-Message (-hp- 3586B/Bell version) filter is placed in series with the 3100Hz Bandwidth filter. Both plots of these weighting curves are illustrated in Figure 3-8-2. Measurements of weighted noise signals correspond closely to subjective evaluations of the unweighted noise level.

3-8-24. Automatic Calibration. Turn the AUTO CAL off when the instrument is used strictly for monitoring a channel or for outputting a demodulated channel signal through the headphone or audio jacks. This will eliminate the interruption caused by the three minute calibration.³

3-8-25. Miscellaneous Control Settings. The control settings listed below are those typically chosen for noise level measurements or for monitoring message channel signals. Other selections can be made if the operator desires. Comprehensive information on each control is given in the referenced paragraph.

Range (3-2-68) 10dB
 Full Scale.....(3-2-72) AUTO

³The -hp- 3586A/B/C automatically calibrates approximately every three minutes when AUTO CAL is on. See Paragraph 3-1-17 for details.

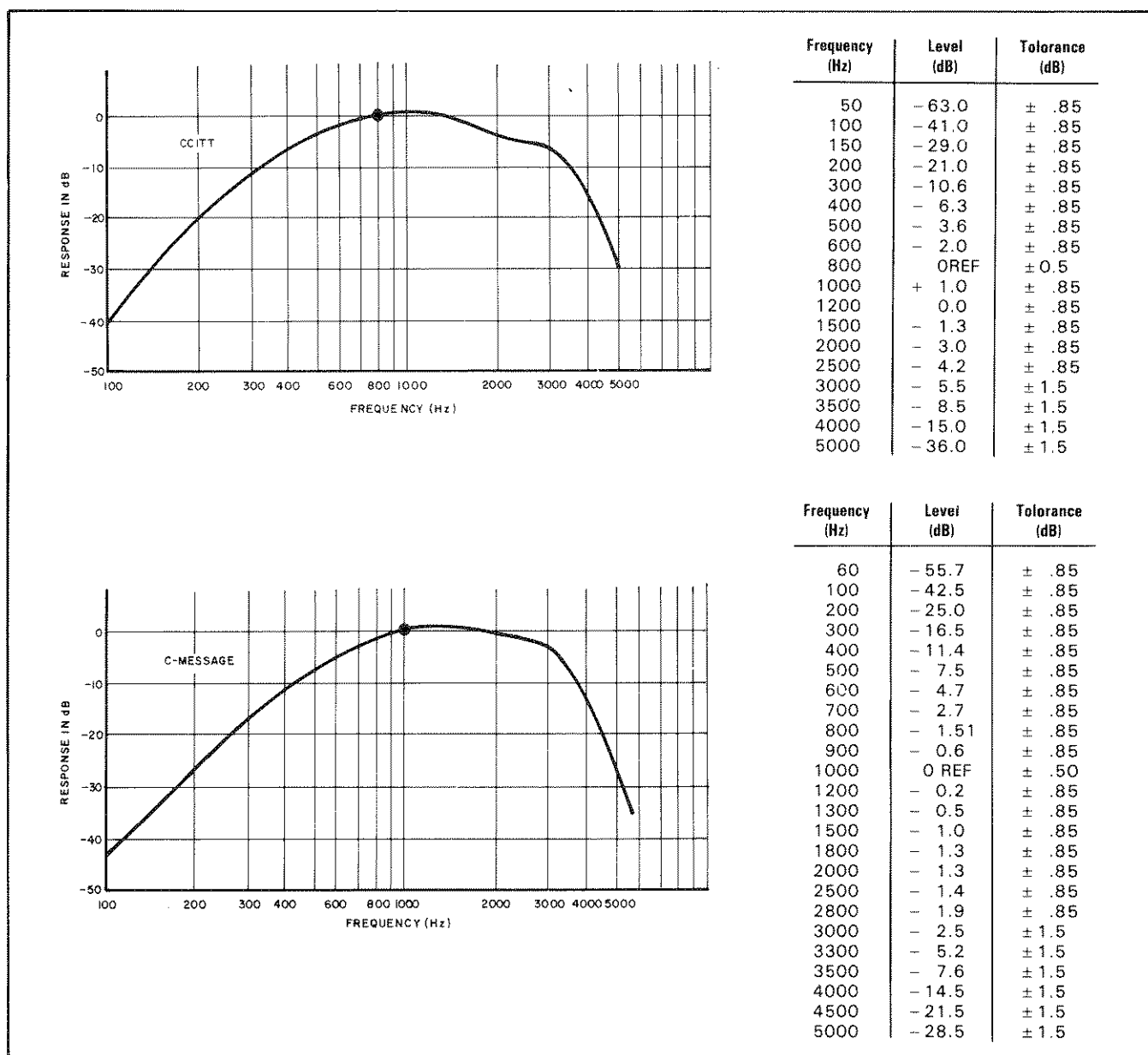

Figure 3-8-2. Weighting Curves Used For WTD Bandwidth Selection.

3-8-26. OFFSETS.

NOTE

The Offset feature is typically used for making amplitude measurements relative to the Test Level Point when measuring signals in telecommunications systems.

3-8-27. Amplitude measurement data can be offset by a fixed amount if the operator wishes. The offset is entered either directly or by transferring an amplitude reading to the offset storage register. When the OFFSET ON/OFF control is on, the entered offset will be subtracted from the measured signal level and the result presented in the Measurement/Entry display. Zero is subtracted from the measured signal level if no offset has been entered. Entries can be made with the OFFSET OFF/ON control either on or off. Offsets are retained until another value is entered or the instrument is turned off. To display the Offset,

Press  . Press  to resume measurement.

NOTE

Make the Units selection before entering the offset. Offsets are not referenced to any particular impedance or level. Because of this, the magnitude of an entered offset does not change when the Units are changed.



3-8-28. Direct OFFSET ENTRY.

3-8-29. Use the following procedure to directly enter the magnitude of an offset. Any value from -199.99dB to $+199.99$ can be entered.

STEP 1: Press  in the Entry control group.



The current offset will appear in the Measurement/Entry display.

STEP 2: Enter the digits and decimal point as required.

STEP 3: Press  or  as appropriate.

STEP 4: Press  to resume measurement.

The contents of the offset register can be changed in one dB steps using the Increment and Decrement keys.

Press  , then press  or  as desired.

3-8-30. Offset Entry By Transfer.

3-8-31. This method of entering offsets is especially valuable when measuring one signal level relative to another. Use the following procedure to transfer an amplitude reading to the offset storage register.

Press  .

The entered offset will appear in Measurement/Entry display.

CHAPTER NINE IMPULSE

3-9-1. The Impulse measurement mode is used to measure the Impulse Noise on message channels in telecommunications systems. Impulse noise consists of irregularly occurring pulses of relatively high amplitude.¹ The pulses originate from natural sources like lightning and from man-made sources both in and out of the telephone office. Examples of man-made noise sources are auto ignition noise, power lines and, within the office, dialing and switching signals. Impulse noise is undesirable principally because it interferes with data transmission.

3-9-2. Measurement Mode.

3-9-3. The Impulse measurement mode is selected by pressing the (shift-blue key) IMPULSE control. The IMPULSE control is also used to terminate an Impulse measurement prematurely. Two other controls are automatically set when this mode is selected:

BANDWIDTH Widest
FULL SCALE..... AUTO

The Full Scale and Bandwidth can be changed if desired. Note that the combination of the Impulse measurement mode and one of the narrower bandwidths produces a trivial operating condition.

3-9-4. **Data Display.** The amplitude of the signal being tested, the time duration of the current test and the number of impulses counted are displayed during Impulse noise measurements. The Format for the data display is:

Measure/Entry	Frequency/Entry
AMPLITUDE	TIME COUNT

3-9-5. **Error Messages.** The error messages presented below are those most likely to be encountered while measuring Impulse Noise.

- Er 4.1 — Impulse counter did not start (instrument failure).
- Er 4-2 — Impulse counter did not stop (instrument failure).
- Er 6-1 — Threshold level more than 60dB below full scale.
- Er 1.2 — Only the 100dB Range is permitted during Impulse measurements.

3-9-6. Input Termination.

3-9-7. Select the input TERMINATION in accord with the test point to which the instrument is being connected. The dominant consideration is the impedance. In the vast majority of cases, a terminated input with a particular impedance is required. The maximum input power of all inputs is +27dBm (.5 watts). For all inputs except the 50 ohm and 75 ohm inputs, the maximum DC voltage between any two terminals (including ground) is 42 volts.

¹According to Bell Publication 41009 (May 1975), Impulse noise consists of all noise spikes 12dB or higher above the rms noise level.

The total power (composite due to AC and DC) input to the 50 ohm and 75 ohm terminated inputs must not exceed .5 watts.

3-9-8. TUNING THE INSTRUMENT FOR IMPULSE MEASUREMENTS.

NOTE

If the instrument was tuned to the desired message channel while in another measurement mode, it will be properly tuned when Impulse is selected. The instrument automatically modifies its tuning according to the measurement mode.

3-9-9. The exact procedure for tuning the instrument to make Impulse measurements depends on whether or not the message channel being tested is carrying a 1kHz signal. If the channel is idle, tuning consists of only the following two steps:

1. Select the most convenient Entry Frequency mode.
2. Enter the Entry Frequency in accord with the above selection.

Fine tuning is not required when measuring the Impulse noise on an idle channel. Note the Counter-to-Frequency control is not functional when the instrument is in the Impulse Measurement mode. When the message channel is carrying a 1kHz signal,² the instrument *must be fine tuned*. Fine tuning aligns a narrow bandwidth 1kHz notch filter with the 1kHz signal on the message channel. The 1kHz signal must be removed from the composite signal before Impulse noise can be measured. Because of the fine tuning requirement, four *ADDITIONAL* steps are added to the tuning procedure:

3. Switch to the Noise Tone measurement mode.
4. Count the RF frequency of the kHz tone on the message channel.
5. Modify the contents of the Entry frequency register with the frequency count.
6. Switch back to the Impulse measurement mode.

A detailed procedure is given in the following paragraphs.

3-9-10. Instrument Configuration For Tuning.

3-9-11. Entry Frequency. Using the Entry Frequency Controls, the operator can choose between entering either the Carrier frequency or the Tone frequency when tuning the instrument to a message channel.³ When TONE is selected, the RF frequency of a 1kHz (3586B) or 800Hz (3586A) test tone on the message channel is entered and displayed. Note that the tone need not be on the channel. Similarly, the Carrier frequency is entered and displayed when CARRIER is selected. The operator can choose whichever mode is most convenient regardless of the Measurement mode selection.

²A 1kHz tone is often placed on a channel to cause companders to operate normally during the Impulse noise tests. This causes the measurement conditions to simulate the operating conditions.

³Message channels are usually designated by their position in the FDM hierarchy (i.e., Master Group Number, Supergroup Number, Group Number and Channel Number). Charts are available in the operating telephone offices that give either the Carrier or Tone frequency for each of the channels. Therefore, regardless of the exact frequency component of the message channel to be measured, it is easiest to tune the instrument using one of these two frequencies. The Entry Frequency controls allow the operator to choose either frequency.

3-9-12. The Entry Frequency mode selection does not depend on the measurement mode selection. Each measurement mode has a frequency or band of frequencies associated with it that have a fixed relation to either of the Entry Frequencies. As long as the entered frequency is correct for the message channel and the Entry Frequency selection, the instrument will automatically tune to the frequency or band of frequencies required by the measurement mode. Since the purpose of these controls is to facilitate tuning when measuring signals in telecommunications systems, they are functional only when one of the SSB CHANNEL (i.e., telecommunications) measurement modes is selected. An annunciator in one of the controls remains lit while the instrument is in the Selective measurement mode to indicate how the displayed frequency will be interpreted if the instrument is switched to one of the SSB Channel measurement modes.

3-9-13. **Channel.** Select the channel in accord with the message channel signal being received.



— Configures the instrument to receive a lower sideband signal.



— Configures the instrument to receive an upper sideband signal.

3-9-14. Coarse Tuning.

3-9-15. The instrument is coarsely tuned whenever the input signal is within the instrument bandpass. In the Impulse measurement mode, the instrument is coarsely tuned by simply entering the Entry Frequency.

3-9-16. **Entering The Entry Frequency.** Use the following procedure to enter either the carrier frequency or the RF test tone frequency in accord with the Entry Frequency mode selection.

STEP 1: Press

STEP 2: Enter the significant digits and decimal as required.

STEP 3: Press , or as appropriate.

STEP 4: If there is a 1kHz test tone on the message channel, switch to the Noise/Tone measurement mode and complete the tuning procedure beginning with Paragraph 3-8-19. Return to the Impulse measurement mode and this procedure when you are finished.

3-9-17. Instrument Configuration For Impulse Measurements.

3-9-18. **Time.** Time refers to the time duration of an Impulse measurement. Any interval up to 99 minutes 59 seconds can be entered with 1 second resolution. Alternatively, the instrument can be set for continuous counting by entering a time greater than the maximum. The format for both entry and display of time is

Minutes (decimal point) Seconds.

Use the following procedure to enter time.

STEP 1: Press  .

The current time entry will appear in the Frequency/Entry display (Con is continuous).

STEP 2: Enter the minutes, press the decimal key; then enter the seconds.

STEP 3: Press  .



3-9-19. Threshold. The threshold level is the minimum amplitude of a *counted* noise spike. Noise spikes below the threshold level will not be counted. Use the following procedure to enter the threshold level. Any level from -119dBm to $+25\text{dBm}$ may be entered for the 3586A. Any level from -116dBm to $+28\text{dBm}$ may be entered for the 3586B.

STEP 1: Determine the threshold level to be entered in accord with the units selection.

STEP 2: Press  (Threshold).

The current threshold level will appear in the Measurement/Entry display.

STEP 3: Enter the digits and decimal as required.

STEP 4: Press  and  as appropriate.

STEP 5: Press  .

NOTE

Do not change the units selection after entering the Threshold level. The Threshold and Offset entry parameters do not change magnitude as a function of units selection.

3-9-20. Full Scale. Use AUTOMATIC Full Scale. When AUTO is used, the instrument automatically configures itself for the best signal to noise ratio obtainable without overloading. It is possible to use the Entry mode during Impulse measurements. Note, however, that the dynamic range with the instrument in Entry is less than it is with the instrument in AUTO. Furthermore, there is no particular advantage to using the Entry mode.

3-9-21. Units, Averaging and Offset. These controls have no effect on the Impulse Noise measurement. However, they do affect the input signal amplitude data that is presented in the Measurement/Entry display during the Impulse measurement. The effects of these controls are described in the paragraphs referenced below.

UNITS	3-2-91
AVERAGING.....	3-2-93
OFFSET.....	3-2-98

CHAPTER TEN NETWORK ANALYSIS

3-10-1. The insertion loss of signal processing networks can be measured on the -hp- 3586A. Insertion loss is the effect of inserting a device between a specific source impedance and a specific termination. A tracking Generator output on the rear panel of the instrument is the source for the measurement. The frequency of the Tracking Generator Output tracks the tuning of the instrument precisely. Its output level and output impedance are 0dBm and 75 ohms respectively. In the simplest application, the Tracking Generator stimulates the device under test and the level at the output of the device is measured with the selective level measurement portion of the instrument. Since the level of the source is 0dBm into 75 ohms, the insertion loss of the device is simply the level displayed on the instrument. In other applications, the measurement may be more complicated because of changes in the impedance of the source or termination. A typical insertion loss measurement is illustrated in Figure 3-10-1.

3-10-2. IMPEDANCE MODIFICATION.

3-10-3. Oftentimes, the source impedance and/or the impedance of the termination must be modified to meet test requirements. The source impedance is increased by placing resistance in series with the output and reduced by placing the resistance in parallel with the output. Altering the impedance of the termination is especially simple. Select the Bridged 75 ohm input ($R_{in} = 10k\Omega \parallel 50pf$) and terminate the device with the desired impedance. If the termination impedance is large, it will be necessary to include the effects of the 10k ohm input impedance when selecting the terminating resistor.

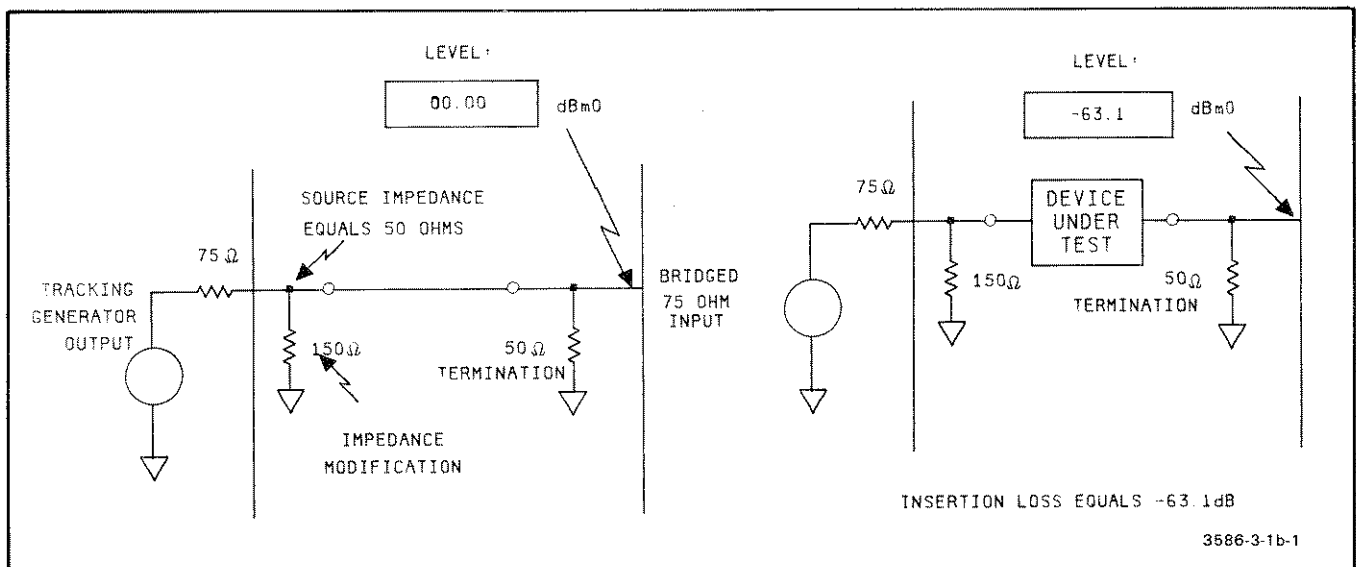

Figure 3-10-1. Typical Insertion Loss Measurement.

3-10-4. MEASUREMENT PROCEDURE.

3-10-5. Use the following procedure to precisely measure the insertion loss of a device. (Accuracy nominally equal to $\pm .25\text{dB}$.)

STEP 1: Modify the impedance of the Tracking Generator.

STEP 2: Select the terminated 75 ohm input or select the Bridged 75 ohm input and terminate the device as desired.

STEP 3: Connect all cables so that the only *apparent* remaining step is to connect the device under test.

STEP 4: Configure the instrument as follows:

—Enter the frequency of the insertion loss measurement.

—Press  Full Scale.

—Press Range 

—Press Bandwidth 

—Any units can be selected; dBm is assumed in this presentation.

STEP 5: Connect the source and termination cables together and read the level. Transfer the reading into offset storage.

(Press ). Turn the Offset OFF-ON control ON.

Press  . The Measurement/Entry Display should now read 0dBm 0.

This offset compensates for errors in the output level of the Tracking Generator and for output level shifts due to unequal source and termination impedances.

STEP 6: Disconnect the source and termination cables and insert the device to be tested.

STEP 7: The level displayed is the insertion loss of the device for the conditions of the test configuration.

CHAPTER ELEVEN

HP-IB OPERATION

NOTE

It is advisable to lock the -hp- 3586A/B/C to the frequency reference of the signal source during HP-IB operation (see Paragraph 2-27). If this cannot be done, see Paragraph 3-11-10 for an explanation of the difficulties that may arise and some alternate solutions.

3-11-1. This chapter contains the instrument dependent information required to operate the -hp- 3586A/B/C over the HP-IB. Directions for mechanically interfacing the instrument with the HP-IB are given in Section II (see Paragraph 2-29). The operator should be familiar with the manual operation of the instrument before attempting to operate it over the HP-IB.

3-11-2. THE HP-IB.

3-11-3. The Hewlett-Packard Interface Bus (HP-IB)¹ is a means of transferring messages in digital form between two or more HP-IB compatible devices. An HP-IB compatible device is an instrument, calculator, computer or peripheral device that is designed to be interfaced using the HP-IB. All data on the HP-IB serve one of four purposes. They either program instrument functions, transfer measurement data, coordinate instrument operation or manage the system. The ability to communicate these messages creates several new and powerful capabilities:

- Instrument operation can be automated.
- Two or more instruments can be integrated to form a system. The system will include all of the individual instrument capabilities plus new capabilities created by the coordinated operation of the instruments.
- Data can be manipulated and stored by a calculator or computer.
- Controller peripherals such as plotters and printers provide a permanent record of data in a variety of formats.

It is not unusual to see all of these advantages realized in a single application of the HP-IB. A typical HP-IB system is illustrated in Figure 3-11-1a. An abridged description of the HP-IB is contained in Figure 3-11-1b.

3-11-4. Introductory Programming Guide.

3-11-5. The quickest and easiest way to get started with the HP-IB is to use an Introductory Programming Guide. The guide contains descriptions and exercises that illustrate all of the -hp- 3586A/B/C HP-IB operations and enough of the controller I/O operations to allow the

¹HP-IB is Hewlett-Packard Company's implementation of IEEE Standard 488-1975, "Standard Digital Interface for Programmable Instrumentation".

operator to write practical programs. It may take as little as 40 minutes for an inexperienced operator to complete all of the exercises in the guide.

3-11-6. The Introductory Programming Guide available for the -hp- 3586A/B/C is the 3586/9825 HP-IB Introductory Programming Guide. Copies of the Introductory Programming Guide will be available. Contact your nearest -hp- Sales and Service office for more information.

3-11-7. Quick Reference Guide.

3-11-8. A comprehensive, but very succinct, description of the 3586A/B/C HP-IB operation will be available for those operators who are already experienced with the HP-IB. Contact your nearest -hp- Sales and Service office for more information.

3-11-9. Operating The -hp- 3586A/B/C Over The HP-IB.

3-11-10. Frequency Stability Considerations. If possible, lock the instrument to the frequency reference of the signal source. This will simplify the tuning routine in the controller program. A selective level meter does not require good frequency accuracy to make highly accurate level measurements. (A good frequency reference only makes the instrument easier to tune.) In an -hp- 3586 not equipped with Option 004, tuning errors of 200Hz are not uncommon at higher frequencies. When the 20Hz Bandwidth in one of these instruments is used, it is possible that the Bandpass of the instrument will not include the Entry Frequency. This is not really a problem when the instrument is operated in a local mode. The operator can quickly search for the signal and/or verify that the instrument is tuned to the proper signal using the Frequency controls. Unfortunately, a routine in a program that does the same thing can be very complicated depending on the frequency spectrum in the vicinity of the desired signal. Of course, if the spectrum is uncomplicated, the tuning routine may be quite simple. The operator must evaluate each application. Locking the -hp- 3586A/B/C to the frequency reference of the signal source eliminates the need for a search and verify routine in the controller program. When this is done, the tuning procedure is reduced to simply programming the Entry Frequency. If it is impossible to lock the signal source and the -hp-3586A/B/C together, use a high accuracy frequency reference. This will reduce the frequency error which, in turn, usually simplifies the required search and verify routine in the controller program.

3-11-11. Calibration. The instrument automatically calibrates itself approximately every three minutes when it is in the local mode and AUTOMATIC CALIBRATION is on. During remote operation, the three minute calibration is disabled. This is done because pseudo random calibrations would make the execution time of the program statements unpredictable. If the instrument specifications are to be maintained, every three minutes, the controller must direct the instrument to calibrate itself. Done this way, the calibration is predictable and cannot interrupt other programming statements. The automatic calibration function is activated using an instrument programming code (explained in subsequent paragraphs). If your system controller has clock functions and statements, the instruction to calibrate can be sent on the basis of time (i.e. - every three minutes). If the controller has no clock functions, the calibration cycle must be based on some other criteria e.g. every 100 measurements.

NOTE

If the instrument is to meet its specifications, it must be forced to calibrate at least once every three minutes.

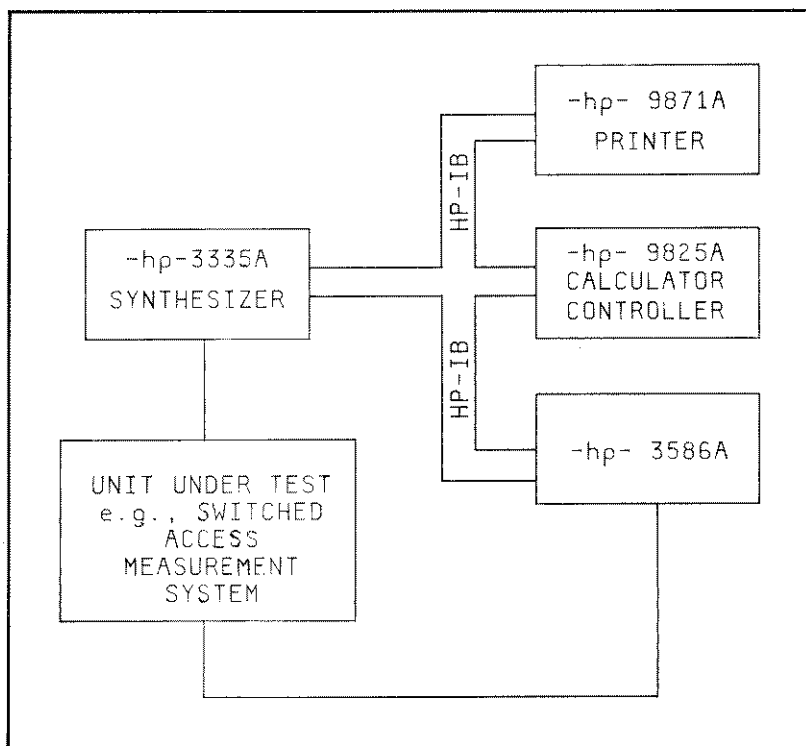

Figure 3-11-1a. Typical HP-IB System.

3-11-12. HP-IB Operating Principle.

3-11-13. Controller. The HP-IB Input/Output ports of all devices on the bus are connected to the same data lines. The devices share the data lines as desired by the active controller. The active controller designates which device will send data and which device or devices will receive data. The system controller, which is usually a calculator or computer, is the active controller most of the time. (The active controller is the device directing data transfers at any given time.) However, it may allow another device to be the active controller.

3-11-14. Talkers. Any device that can send data over the bus is a "talker". The -hp-3586A/B/C is a talker since it can output measurement data and the values of all entered parameters such as frequency and time. All calculators and computers are talkers. Only one talker may be active at a time. The active talker is the talker that is currently directed to send data.

3-11-15. Listeners. Any device that can receive data over the bus is a "listener". The -hp-3586A/B/C is a listener since it can receive codes that activate various instrument functions. Virtually all calculators and computers are listeners. Obviously, it is possible for a device to be a talker part of the time and a listener at other times since the -hp-3586A/B/C, all calculators and all computers are both talkers and listeners. Up to fourteen active listeners can be on the bus at the same time. An active listener is a listener that is currently directed to receive data.

3-11-16. Addressing. The active controller must send commands to specific instruments in order to direct information transfer. For example, only one device should be directed to talk during a data transfer. Also, the message being sent may be intended for only certain devices on the bus. Each HP-IB compatible device has at least one unique "address". This address is used by the controller to specify that particular device. When a device, for example the -hp- 3586A/B/C, is both a talker and a listener, it has separate addresses for each mode.

Therefore, when a controller addresses a device, it also specifies whether the device is to talk or listen. The factory preset talk and listen addresses for the -hp- 3586A/B/C are:

T a l k P
Listen 0 (zero)

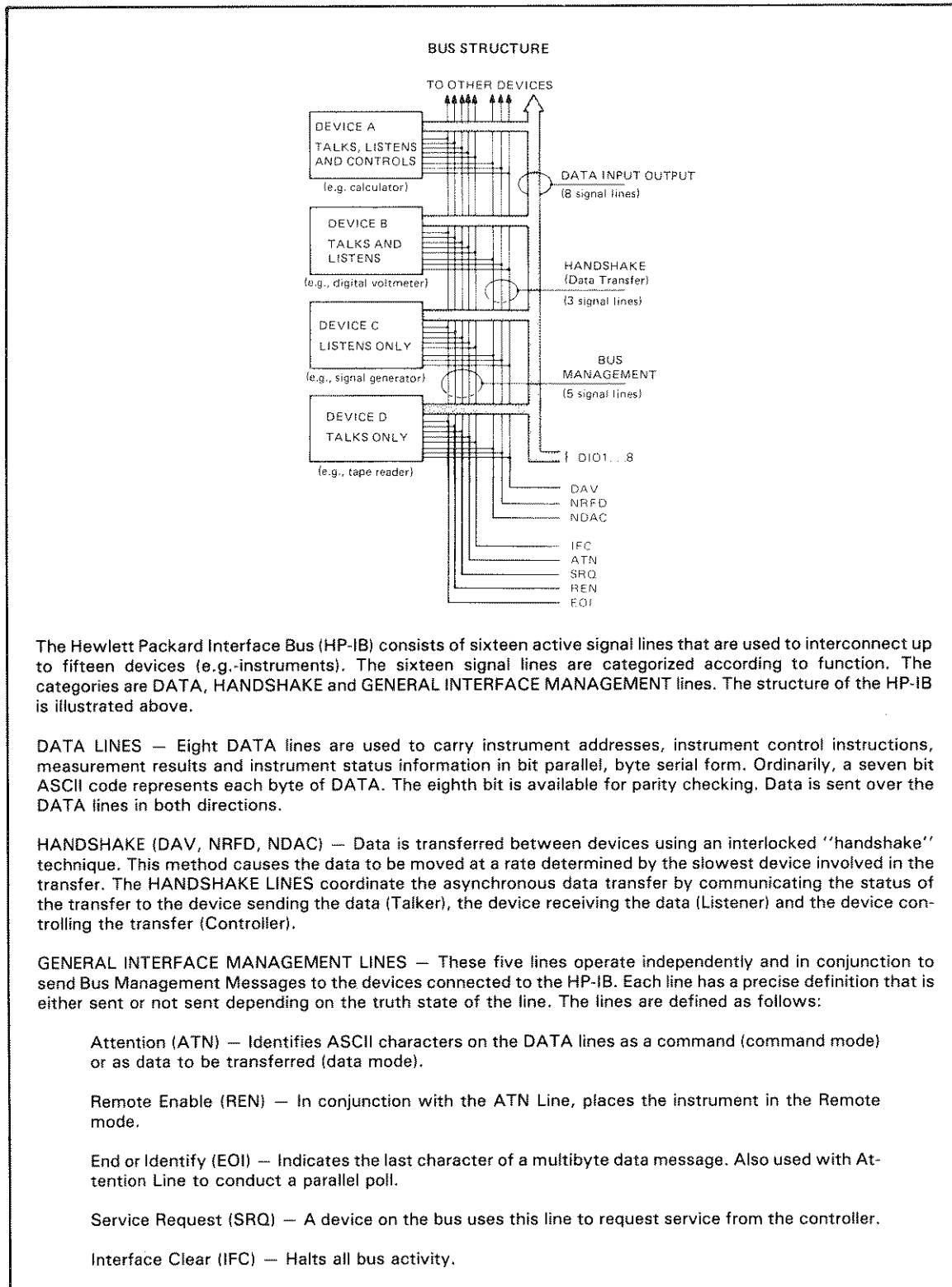

Figure 3-11-1b. Abridged Description Of The HP-IB.

Some Hewlett-Packard controllers (and possibly others) required a coded form of the above addresses called a Device Address. The factory selected Device Address for the -hp-3586A/B/C is (16) sixteen. The talk and listen addresses, and therefore the Device Address, can be changed if desired (see Appendix C, Address Selection). Actually, there is no reason to change these addresses unless another device with the same address, such as an additional -hp-3586A/B/C, is added to the system.

3-11-17. Synthesizing Controller Statements For Instrument Operation.

3-11-18. The interface between the operator and the instrument is changed drastically when an instrument is operated over the HP-IB. During non-HP-IB operation, the operator actuates front panel controls that are labeled according to function. Often, only a single control is used to activate an instrument function. Outputting measurement data consists simply of looking at the front panel display! In contrast, during HP-IB operation, the operator typically faces a keyboard of alpha-numeric characters. Neither the key functions nor their labels correspond to the instrument operation. The natural question is: "What instructions must be entered on the controller to cause a particular action in the instrument?" This subsection explains how to answer that question.

3-11-19. An ideal HP-IB operating section in an instrument manual would give specific instructions such as:

"To initiate a measurement in the -hp-3586A/B/C, enter trg 716 on the controller."

This instruction is very specific and leaves little room for error. Unfortunately, it is not possible to give such specific instructions. Each HP-IB compatible device (e.g., the -hp-3586A/B/C) can be used in systems equipped with various Hewlett-Packard controllers as well as controllers produced by other manufacturers. Likewise, many different instruments are used with each controller. As a result of this diversity, it is impossible to know which instruments and controllers will be used together in a system. *Since it is not known which controller will be used in a system, the operating instructions for an instrument can only describe the interface of that particular instrument with the HP-IB.* An analogous situation exists for the controller operating instructions. Almost all statements sent over the HP-IB to operate an instrument contain a portion that depends on the individual instrument and a portion that depends on the controller used in the system. It is the operator who must synthesize the required statement from information found partially in the instrument documentation and partially in the controller documentation. The concept of *Bus Messages*, presented in the next paragraph, is a significant aid to this process.

3-11-20. Bus Messages. When all of the bus operations are carefully analyzed according to how they are physically implemented on the HP-IB, twelve unique *BUS MESSAGES* are found.

The Data Message implements the primary purpose of the HP-IB. It is used to send the codes that activate instrument functions and for transferring measurement data from one device to another. This message is subdivided into Data Send and Data Receive for operator convenience. Technically, (i.e., according to physical implementation) there is no difference between Data Messages used to send and receive information to and from the instrument. The Trigger Message causes simultaneous action in two or more devices on the bus. The action in a particular device depends on the design of that instrument. In the -hp-3586A/B/C, it causes an immediate measurement. Actually, this message can be used

to cause an action in a single device, but that capability is incidental to its real purpose. The remaining ten Bus Messages are used to manage the system. Their only purpose is to facilitate the implementation of the Data and Trigger Messages.

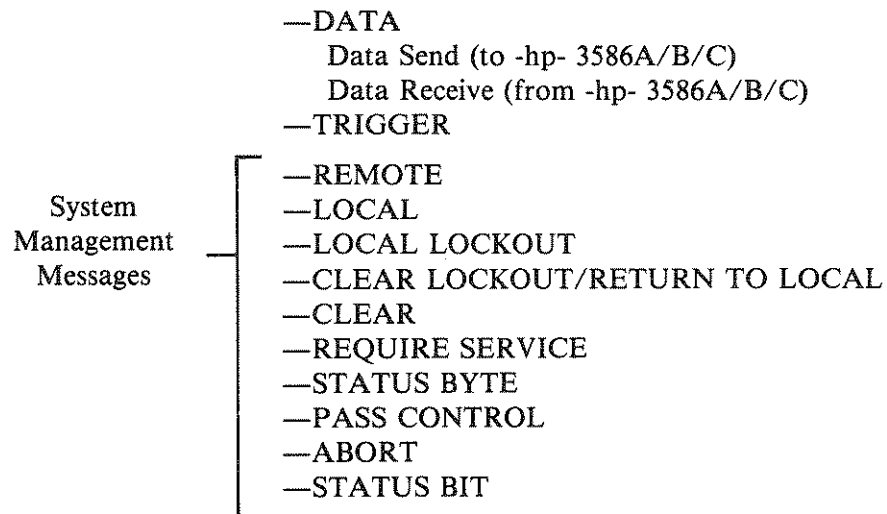

3-11-21. Implementing Bus Messages. Recall that the objective is to answer the question: “What instructions must be entered on the controller to cause a particular action in the instrument?” This question is answered by converting the Bus Messages into controller statements that cause the desired action in the instrument when executed on the controller. Since these twelve messages describe every possible HP-IB Operation, converting them to controller statements will enable the operator to implement every possible HP-IB operation. A procedure for converting the Bus Messages to controller statements is given in the following paragraphs.

NOTE

If the controller used in your system is an -hp- 9825A Calculator, substitute the HPL Bus Message Implementation Table C-1 in Appendix C for the worksheet following Paragraph 3-11-25. The 9825A controller statements that implement each bus message are given in this table. If you do make this substitution, be sure to study the descriptions of the Bus Messages thoroughly (see Index, Table 3-11-1). The information in these descriptions is not restricted to that which is required to convert the Bus Messages.

3-11-22. Step One. Choose one of the Bus Messages for conversion. Begin with the System Management Messages since they are usually more easily converted to controller statements than either the Trigger or Data Messages. Locate the description of the Bus Message in this manual. An index for the Bus Messages is presented in Table 3-11-1. The description of each message contains the following information as applicable:

- The response of the -hp- 3586A/B/C to the message.
- The device dependent information required for the controller statement.
- Any prerequisite operations.
- Suggestions for optimizing the use of the message.

The device dependent information required for the controller statement is always found under the heading *Implementation*.

Table 3-11-1. Bus Message Index

Bus Message	Paragraph
SYSTEM MANAGEMENT MESSAGES	
Remote	3-11-28
Local	3-11-30
Local Lockout	3-11-32
Clear Lockout/Set Local	3-11-34
Clear	3-11-36
Require Service	3-11-38
Status Byte	3-11-40
Status Bit	3-11-44
Pass Control	3-11-45
Abort	3-11-46
TRIGGER	3-11-47
DATA	
Data Send (to -hp- 3586A/B/C)	3-11-51
Data Receive (from -hp- 3586A/B/C)	3-11-64

NOTE

1. *The Require Service Message originates at the instrument rather than at the controller. Consequently, there is no controller message that implements this message. This does not diminish the importance of this message to the operator. Study it carefully in turn.*

2. *The Status Bit, Pass Control and Abort Messages cannot be implemented because the -hp- 3586A/B/C does not have the capacity or the need to respond to them.*

3-11-23. *Step Two.* Find the description of the selected Bus Message in the controller documentation. This description will usually consist of the following information:

- One or more controller statements that implement the message.
- Mnemonics for the controller statements.
- Syntax of the controller statements.
- Any prerequisite operations.

When searching for a message in the controller documentation, it is usually best to start with the Table of Contents. If the message is not referenced there, look in the index. In order for the twelve Bus Messages to be useful, the controller documentation must organize the Input/Output Operation programming statements according to the definitions of the twelve messages. It would be unusual for any manufacturer of controllers to do otherwise since the definitions of the bus messages organize all bus operations according to how they are physically implemented. However, the exact nomenclature used to describe the Bus Messages may vary from one manufacturer to another. It is worthwhile to become familiar with the HP-IB section of the controller documentation before attempting to implement any Bus Messages. This is especially true if the controller was not manufactured by Hewlett-Packard.

NOTE

If your controller documentation does not contain a programming statement for a particular Bus Message, it may be that the controller is not capable of implementing the message.

3-11-24. *Step Three.* Integrate the device dependent information, found in STEP ONE, with the controller dependent information found in STEP TWO. The syntax of the controller statement explains how this should be done.

3-11-25. *Step Four.* The operator only needs to translate the twelve Bus Messages into controller statements once. Record the statements that implement each bus message in the worksheet following this paragraph as they are found. In the future, this table can be used as a quick reference when writing programs. The following example will clarify this procedure and illustrate the kinds of problems you may encounter.

EXAMPLE: The objective of this example is to find a specific controller statement that will implement the Remote Message. The controller will be the -hp- 9825A Calculator.

Step 1 The location of the Remote Message is found in the Bus Message Index given in Table 3-11-1. It is described in Paragraph 3-2-28. According to the description, the instrument will switch to the remote operating mode when a Remote Message is received. Also, the listen address, which is 0 (zero) for the -hp- 3586A/B/C will be required for the controller statement. Note that the names of most Bus Messages suggest their action.

Step 2 The HP-IB operations of the -hp- 9825A Calculator are explained in the General I/O and Extended I/O Programming Manuals. (General I/O Programming Manual Part No. is 09825-90024. Extended I/O Programming Manual Part No. is 09825-90025.) Pages 14 and 22 are referenced in the index of the Extended I/O Manual under the heading *Remote*. a complete description of how to implement the Remote Message and an example is presented on page 22. The required program statement is:

rem Select Code (Device Address)

but what is a Select Code or a Device Address? There is little in the Extended I/O Manual to answer this question. However, checking the index of the General I/O Manual, under the heading *Addressing*, produces results. Descriptions of the Select Code and the Device Address are found on pages 4 and 47 respectively. The Select Code is quickly determined to be seven (7). The Device Address is not quite so easy. On page 38 of the General I/O Programming Manual, it states that the Device Address is the decimal equivalent of the five least significant bits of the binary code for the instrument's talker and/or listen addresses. The listen address of the -hp- 3586A/B/C is given under the heading *Implementation* in the description of the Remote Message.

LISTEN	0	(zero)	<table style="border: none;"> <tr> <td style="text-align: center; padding-right: 10px;"><u>MSA</u></td> <td style="text-align: center; padding-right: 10px;">00110000</td> <td style="text-align: center;"><u>LSB</u></td> </tr> <tr> <td colspan="3" style="text-align: center;">16</td> </tr> </table>	<u>MSA</u>	00110000	<u>LSB</u>	16		
<u>MSA</u>	00110000	<u>LSB</u>							
16									

The binary equivalent of these ASCII characters is found using the ASCII Character Code Table in an Appendix of the General I/O Manual. The decimal equivalent of the five least significant bits is sixteen (16).

Step 3 The complete -hp- 9825A Calculator statement that implements the Remote Message is:

```
rem 716
```

Note that the Device Address of the -hp- 3586A/B/C was given in Paragraph 3-11-16 along with the talk and listen addresses. The procedure for finding the Device Address was included for the sake of an example.

The Select Code is the address of the Input/Output card that plugs into the 9825. It is usually seven (7) for the HP-IB operations.

DATA (send to 3586A/B/C)
Defined in
Paragraph 3-11-51.

DATA (receive)
Defined in
Paragraph 3-11-64.

Program Statements That Implement Bus Messages For Controller _____.

TRIGGER
Defined in
Paragraph 3-11-47.

REMOTE
Defined in
Paragraph 3-11-28.

LOCAL
Defined in
Paragraph 3-11-30.

LOCAL LOCKOUT
Defined in
Paragraph 3-11-32.

CLEAR LOCKOUT AND SET LOCAL
Defined in
Paragraph 3-11-34.

CLEAR
Defined in
Paragraph 3-11-36.

STATUS BYTE
Defined in
Paragraph 3-11-40.

Program Statements That Implement Bus Messages For Controller _____ (Cont'd).

3-11-26. System Management Messages.

3-11-27. The purpose of these ten Bus Messages is to manage the system so that Data and Trigger Messages can be sent as desired.

3-11-28. Remote. When it is first turned on, the -hp- 3586A/B/C is in the LOCAL mode and under front-panel control. In order to be operated over the HP-IB, it must be switched to the Remote mode. The Remote Message switches the instrument to the Remote Mode. In this mode, the only operational front-panel controls are Volume, Line Switch and usually Local unless it has been disabled (see *Local Lockout Message* Paragraph 3-11-32). All other instrument functions are activated over the HP-IB through the system controller. The initial configuration of the instrument, when it is switched to Remote, is determined by the settings of the front panel controls at the time it was switched.

3-11-29. Implementation. The syntax and mnemonics for the program statement(s) that implements the Remote Message are found in the controller documentation. Only the listen address, which is 0 (zero) for the -hp- 3586A/B/C, must come from the instrument documentation. A technical description of the implementation of the Remote Message is presented in Figure A-4 of Appendix A.

3-11-30. Local. The Local Message switches the -hp- 3586A/B/C from Remote to Local operation. The instrument is operated using front panel controls while in the Local mode. Another way of switching the instrument to the Local mode is to actuate the front-panel LOCAL control, providing it has not been disabled (see *Local Lockout Message* Paragraph 3-11-32).

3-11-31. Implementation. The syntax and mnemonics for the program statement that implements the Local Message are found in the controller documentation. Only the listen address, which is 0 (zero) for the -hp- 3586A/B/C, is taken from the instrument documentation. An instrument must be addressed to listen in order for it to enter the Local mode. A technical description of the Local Message implementation is presented in Figure A-5 of Appendix A.

3-11-32. Local Lockout. The Local Lockout Message disables the LOCAL control on the front panel of the instrument. This prevents the casual passer-by from interfering with system operation by pressing buttons. The instrument can still be switched to Local by sending a Local Message over the HP-IB. If the LOCAL control is locked out and the instrument is switched to Local using the Local Message, the LOCAL control will remain disabled. When the instrument is again switched to Remote, the front panel LOCAL control will still be locked out. Since Local Lockout is a universal message, all devices on the HP-IB with Local Lockout capability will respond when this message is sent.

3-11-33. Implementation. The entire program statement that implements the Local Lockout Message is found in the controller documentation. No part of the program statement depends on the individual instrument. A technical description of the Local Lockout Message implementation is presented in Figure A-6 of Appendix A.

3-11-34. Clear Lockout And Return To Local. This is a universal message that switches all instruments on the HP-IB to the Local mode and clears all Local Lockout conditions. Other methods of accomplishing the same thing are to disconnect the HP-IB cable, turn the controller off or turn off the individual devices in the system.

3-11-35. Implementation. The entire program statement that implements the Clear Lockout and Set Local Message is found in the controller documentation. No part of the program statement depends on the individual instrument. A technical description of the Clear Lockout and Set Local Message implementation is presented in Figure A-7 of Appendix A.

3-22-36. Clear. The Clear Message resets instruments to a predefined state. The predefined state of the -hp- 3586A/B/C is identical to the conditions at turn-on except that all stored front panel configurations are retained. The Clear Message can be a universal instruction for all devices on the bus capable of responding or it can be sent to addressed devices only.

3-11-37. Implementation. When the Clear Message is a universal instruction, the entire program statement that implements it is found in the controller documentation. When it is an addressed instruction, the syntax and mnemonics of the program statement that implement it are found in the controller documentation. Only the instrument listen address, which is 0 (zero) for the -hp- 3586A/B/C, is taken from the instrument documentation. A technical description of the Clear Message implementation is presented in Figure A-10 of Appendix A.

3-11-38. Require Service. The Require Service Message is a request for service which is sent from a device on the HP-IB to the active controller. Any of the following conditions in the -hp- 3586A/B/C will generate a Require Service Message:

- Received an unrecognizable string.
- Unable to calibrate.
- Local oscillator not locked.
- Tone not present for S/N or Phase Jitter Measurements.
- Attempt to enter Full Scale level while in AUTOrange.

The Require Service Message is completely independent of all other bus activity. It is sent on a single line (wire) called the SRQ Line, whose state is either true or false. This line is shared by all devices on the HP-IB. When a Require Service Message is received, the controller must determine which device or devices are requesting service. It does this by conducting a *Serial Poll*. Each polled device responds by sending a *Status Byte* which indicates, among other things, whether or not the instrument requested service. Serial Polling and Status Byte Messages are explained fully in the discussion of the Status Byte Message (see Paragraph 3-11-40). The Require Service Message will be cleared when the device sending it is polled or if the condition causing it disappears. In some applications, the controller is programmed to interrupt its main routine and respond to a Require Service Message immediately. Alternatively, it may periodically check the status of the Service Request line and respond when a request is discovered. Considering the problems that generate a Require Service Message in the -hp- 3586A/B/C, interrupting the main routine and servicing the request immediately seems advisable.

3-11-39. Implementation. The Require Service Message originates in the devices on the bus. A technical description of its implementation is presented in Figure A-8 of Appendix A.

3-11-40. Status Byte. A Status Byte Message is sent by a device on the bus to the active controller. The individual bits of the Status Byte indicate the status of various device (instrument) functions and whether or not the instrument requested service (see Paragraph 3-11-41). The definition of each bit in the -hp- 3586A/B/C Status Byte Message is presented in Table 3-11-2. Once the Status Byte of an instrument is in the controller, the status of the instrument functions assigned to the bits can be determined by examining the truth state of each bit. The controller then takes appropriate action. For example, if bit 3 of the -hp- 3586A/B/C Status Byte is true, the controller might print a message advising the operator that a tone is required during S/N and Phase Jitter Measurements.

Table 3-11-2. True State Definitions Of The Bits In The -hp- 3586A/B/C Status Byte.

Bit	True State Definition
0	Received unrecognizable string of ASCII characters.
1	Unable to calibrate.
2	Local oscillator unlocked.
3	Tone not present for S/N or Phase Jitter measurements.
4	Attempt to enter Full Scale level while in AUTOrange.
5	Reference not locked to external standard.
6	This instrument requested service.
7	Not used.

3-11-41. Status Bytes are requested by the controller. The controller requests Status Bytes from instruments by conducting a *Serial Poll* (see Paragraph 3-11-42). Usually, a Serial Poll is conducted in response to a Require Service Message sent by an instrument on the HP-IB. Occasionally, a Serial Poll is conducted even though a Require Service Message was not received by the controller. The programmer may wish to check the status of an instrument function that is encoded in the Status Byte but does not generate a Service Request. There is only one such function in the -hp- 3586A/B/C. The true state of bit 5 is defined as: *The reference is not locked to an external frequency standard*. Since this is a normal operating mode, it will not cause a Service Request. When the system uses an external frequency standard, a programmer might routinely check this instrument function at the beginning of each program.

3-11-42. **Serial Polling.** A Serial Poll is a routine in the program that sequentially requests a Status Byte from some or all devices on the HP-IB. The structure of the routine depends on the way in which the controller implements a Serial Poll and the purpose of the Poll. A flow chart of a Serial Poll that would be conducted in response to a Require Service Message is presented in Figure 3-11-2. In this example, the controller uses separate Serial Poll enable and Serial Poll disable program statements. Some controllers have a single program statement that enables a Serial Poll, polls the addressed device and then disables the Serial Poll. In these cases, a Serial Poll of the system consists of a series of individual Serial Polls on each device. The controller may interrupt the main routine and call up a Serial Poll subroutine immediately whenever a Require Service Message is received or, alternatively, the need for service may be detected by periodic checks in the program. Recall that Serial Polls are sometimes conducted on a single device to learn the status of an instrument function that is encoded in the Status Byte but does not generate a Require Service Message.

3-11-43. **Implementation.** The syntax and mnemonics for the controller statements that implement a Serial Poll are found in the controller documentation. The structure of the Serial Poll routine is developed by the programmer in accord with the total system. Only the listen addresses of the devices to be polled and the definitions of the lists in the Status Byte are taken from the instrument documentation. The listen address of the -hp- 3586A/B/C is 0 (zero). A technical description of the Status Byte Message implementation is presented in Figure A-9 of Appendix A.

3-11-44. **Status Bit.** The Status Bit message is sent from a device on the bus to the active controller. It communicates the status of the device to the active controller. Since it is a single bit message, it can only report the truth state of one predefined statement. The predefined statement may describe a single instrument function or the entire instrument. Status Bit messages are sent in response to a Parallel Poll. The advantage of Parallel Polling is that up to eight instruments can be checked at one time. In other words, eight Status Bit messages can be received by the controller at one time. The -hp- 3586A/B/C does not respond to a parallel poll. See either the controller documentation or the documentation of an instrument that does respond to a parallel poll for more information on the Status Bit message.

3-11-45. Pass Control. The Pass Control message transfers the management of the bus from the system controller to another device in the system. The -hp- 3586A/B/C does not have controller capabilities. See either the system controller documentation or the documentation of a device that does have controller capabilities for more information on this message.

3-11-46. Abort. The Abort message is used by the system controller to regain control of the HP-IB from an active controller. When received, the instrument stops talking or listening. See the system controller documentation for more information on this message.

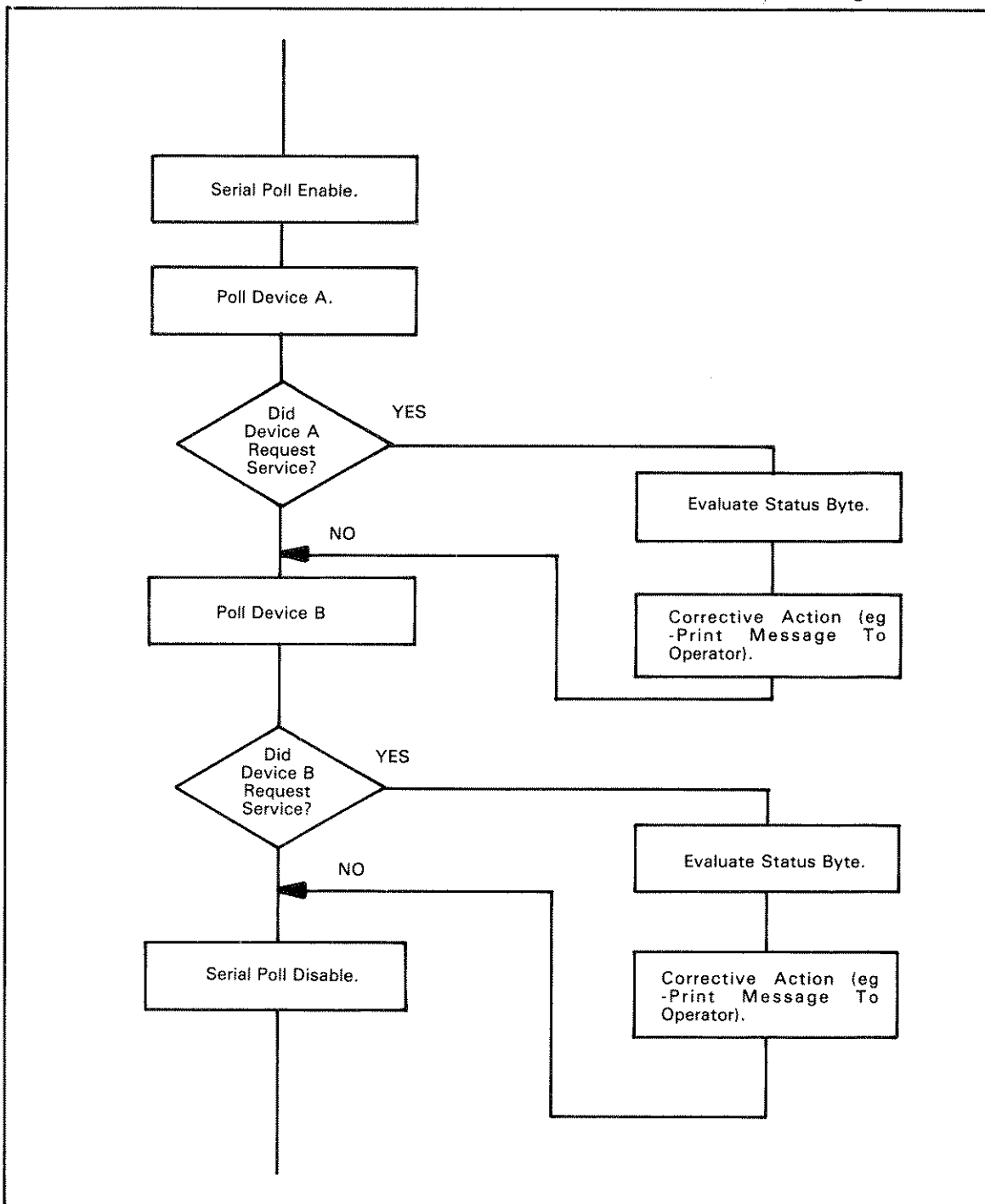

Figure 3-11-2. Flow Chart For Typical Serial Poll.

3-11-47. Simultaneous Device Action On The HP-IB (The Trigger Message).

3-11-48. The Trigger Message causes a predefined response in each device receiving it. In the -hp- 3586A/B/C, the predefined response is an *immediate* measurement. When the Trigger Message is sent to more than one device, the predefined response in all devices occurs simultaneously.

3-11-49. Whenever the -hp- 3586A/B/C is remotely tuned to a new signal or whenever the input signal level is changed, time must be provided for the IF amplifiers in the instrument to adjust to the new signal conditions. If a measurement is taken immediately after any change that affects the signal level in the IF amplifiers, the instrument accuracy is reduced. There are two ASCII instructions that trigger a measurement in the -hp- 3586A/B/C. One of the instructions is the group Trigger Message just described. It is used to trigger a measurement in concert with other device-dependent actions on the bus. *When this trigger message is used, settling time must be provided between the instructions that set the test conditions and the trigger message.* The amount of time required varies with the Bandwidth selection and the accuracy desired. Settling time requirements for each Bandwidth selection and normal instrument accuracy are given in Table 3-11-3. The other trigger command is the programming code TR. It is sent only to the -hp- 3586A/B/C and does not cause a group action. Settling time for the Bandwidth selection is automatically allotted when this trigger message is received. The programming code TR should be used to trigger measurements whenever simultaneous instrument action is not required.

Table 3-11-3. -hp- 3586A Settling Time Requirements.

Bandwidth (in Hz)	Minimum Settling Time (mSec)
3100	150
WTD	150
2000	150
1740	150
400	150
20	250

3-11-50. *Implementation.* The syntax and mnemonics for the program statement that implement the Trigger Message are found in the controller documentation. Only the instrument listen address, which is \emptyset (zero) for the -hp- 3586A/B/C, must come from the instrument documentation. A technical description of the Trigger Message implementation is present in Figure A-3 in Appendix A.

3-11-51. Remote Operation Of The -hp- 3586A/B/C.

3-11-52. **Data Message.** All of the functions of the -hp- 3586A/B/C can be activated remotely by sending Instrument Programming Codes over the HP-IB. Generally, these instrument functions are activated by front panel controls when non-HP-IB operation is used. The Instrument Programming Codes are sent using the Data Message.

3-11-53. *Implementation.* Usually, there are several controller statements that will implement the Data Message. Each statement will have some unique advantage. Thoroughly research this Bus Message in the controller documentation to be certain you are using the optimum statement for your application. The syntax and mnemonics for the controller statements that implement the Data Message are found in the controller documentation. The instrument listen address, which is \emptyset (zero) for the -hp- 3586A/B/C, and the instrument programming codes must come from the instrument documentation. The instrument programming codes and their format are presented in the paragraphs that follow.



3-11-54. Instrument Programming Codes. All of the -hp- 3586A/B/C programming codes and their binary, octal, decimal and hexadecimal values are presented in Table 3-11-4. Each programming code is an instruction to the instrument. In most cases, sending these instructions corresponds to pressing front panel controls during local operation. For instance, receiving the ASCII characters CH1 during Remote operation has the same effect as press-

ing  during local operation. There are exceptions to this one-to-one relationship. All of the "on/off" controls, the dB and Volume controls, all controls in the Frequency Tune group and instrument functions not controllable from the front panel. Each of these exceptions is explained separately in the paragraphs that follow.

3-11-55. On/Off Controls. There are separate ASCII Instructions for the On and Off states of the CALibration, OFFSET, COUNTER and Volume Controls. The Calibration On programming codes does more than just turn the Calibration on. Once the Calibration is already on, it is used to trigger an immediate calibration in the instrument.

3-11-56. dB Instruction. When operating in the Remote mode, the suffix for Full Scale and Offset entries is always the (positive) dB instruction. In effect, sending this code is like pressing $\begin{matrix} \text{kHz} \\ +\text{dB} \end{matrix}$ during local operation. There is no instrument programming code corresponding to the $\begin{matrix} \text{MHz} \\ -\text{dB} \end{matrix}$ control. To enter negative Offset or Full Scale Levels, a negative number is entered before the (positive) dB instruction.

3-11-57. Volume On/Off. The volume ON and Volume OFF instructions switch the audio signal on and off. When the audio signal is switched on, the level is controlled by the front panel volume control even though the instrument is in the Remote mode. This instrument function is not controllable from the front panel.

3-11-58. Frequency Tune Controls. None of the controls in this group can be actuated over the HP-IB. The Frequency Tune Control is inherently a manual control. During Remote operation, continuous tuning is achieved by programming the Frequency Step for the desired resolution and using the  and  instructions to change the frequency.

3-11-59. Display Calibration Constant. This instruction causes the calibration constant, used by the instrument to correct level readings to be displayed in the Amplitude/Entry display. This information is usually of interest to calibration and repair technicians. There is no front panel control corresponding to this instruction.

3-11-60. Fast Calibration. When a Fast Calibration is executed, the instrument is only calibrated on its current range and in the widest bandwidth. This Calibration mode can be used in any of the Selective Measurement Modes. It was designed for use during automated surveillance of telecommunications systems. In this application, the instrument sequentially checks the level of hundreds of individual message channels.

Table 3-11-4. Instrument Programming Codes.

Instruction	ASCII Characters	Binary Code	Octal Code	Decimal Code	Hexadecimal Code
MEASUREMENT					
Wideband	W	01010111	127	87	
	B	01000010	102	66	42
Selective					
LOW DISTortion	M	01001101	115	77	4D
	1	00110001	61	49	31
LOW NOISE (3586C, see M2)	M	01001101	115	77	4D
	6	00110110	66	54	36
SSB Channel					
NOISE/DEMODulation (Low Noise, 3586C only)	M	01001101	115	77	4D
	2	00110010	62	50	32
1010Hz, TONE 1004Hz	M	01001101	115	77	4D
	3	00110011	63	51	33
CARRIER	M	01001101	115	77	4D
	4	00110100	64	52	34
TONE 800Hz, 2600Hz	M	01001101	115	77	4D
	5	00110101	65	53	35
φ JITTER	M	01001101	115	77	4D
	7	00110111	67	55	37
NOISE/TONE	M	01001101	115	77	4D
	8	00111000	70	56	38
IMPULSE	M	01001101	115	77	4D
	9	00111001	71	57	39
Impulse START	S	01010011	123	83	53
	I	01001001	111	73	49
MEASUREMENT/ENTRY					
Range					
10dB	R	01010010	122	82	52
	1	00110001	61	49	31
100dB	R	01010010	122	82	52
	2	00110010	62	50	32
Full Scale					
AUTOmatic	F	01000110	106	70	46
	1	00110001	61	49	31
ENTRY	F	01000110	106	70	46
	2	00110010	62	50	32
AVERage Off	A	01000001	101	65	41
	0	00110000	60	48	30
AVERage On	A	01000001	101	65	41
	1	00110001	61	49	31
UNIT					
dBm	U	01010101	125	85	55
	1	00110001	61	49	31
dBpw (dBv 1V, 3586C)	U	01010101	125	85	55
	2	00110010	62	50	32

Table 3-11-4. Instrument Programming Codes (Cont'd).

Instruction	ASCII Characters	Binary Code	Octal Code	Decimal Code	Hexadecimal Code			
dB .775V	U	01010101	125	85	55			
	3	00110011	63	51	33			
OFFSET Off	O	01001111	117	79	4F			
	S	01010011	123	83				
	Ø	00110000	60	48	30			
OFFSET On	O	01001111	117	79	4F			
	S	01010011	123	83	53			
	1	00110001	61	49	31			
TERMINATION								
	A	B	C					
	10k 50pf(75Ω)	10k 50pf(75Ω)	50Ω	T	01010100	124	84	54
				1	00110001	61	49	31
	75Ω	75Ω	75Ω	T	01010100	124	84	54
				2	00110010	62	50	32
	150Ω	124Ω	10k 50pf(50Ω)	T	01010100	124	84	54
				3	00110011	63	51	33
		135Ω	10k 50pf(75Ω)	T	01010100	124	84	54
				4	00110100	64	52	34
	Bridged-600Ω	Bridged-600Ω	Bridged-600Ω	T	01010100	124	84	54
				5	00110101	65	53	35
	600Ω	600Ω	600Ω	T	01010100	124	84	54
				6	00110110	66	54	36
FREQUENCY/ENTRY								
Entry Frequency								
SSB CARRIER	E	01000101	105	69	45			
	1	00110001	61	49	31			
SSB TONE	E	01000101	105	69	45			
	2	00110010	62	50	32			
Channel								
(LSB)	C	01000011	103	67	43			
	H	01001000	110	72	48			
	1	00110001	61	49	31			
(USB)	C	01000011	103	67	43			
	H	01001000	110	72	48			
	2	00110010	62	50	32			
COUNTER Off	C	01000011	103	67	43			
	N	01001110	116	78	4E			
	Ø	00110000	60	48	30			
COUNTER On	C	01000011	103	67	43			
	N	01001110	116	78	4E			
	1	00110001	61	49	31			
ENTRY								
FREQUENCY	F	01000110	106	70	46			
	R	01010010	122	82	52			
FREQUENCY STEP	S	01010011	123	83	53			
	P	01010000	120	80	50			
FULL SCALE	F	01000110	106	70	46			
	S	01010011	123	83	53			

Table 3-11-4. Instrument Programming Codes (Cont'd).

Instruction	ASCII Characters	Binary Code	Octal Code	Decimal Code	Hexadecimal Code
OFFSET	O	01001111	117	79	4F
	F	01000110	106	70	46
STORE	S	01010011	123	83	53
	T	01010100	124	84	54
RECALL	R	01010010	122	82	52
	C	01000011	103	67	43
THRESH (Threshold)	T	01010100	124	84	54
	H	01001000	110	72	48
TIME	T	01010100	124	84	54
	M	01001101	115	77	4D
0	0	00110000	60	48	30
1	1	00110001	61	49	31
2	2	00110010	62	50	32
3	3	00110011	63	51	33
4	4	00110100	64	52	34
5	5	00110101	65	53	35
6	6	00110110	66	54	36
7	7	00110111	67	55	37
8	8	00111000	70	56	38
9	9	00111001	71	57	39
. (decimal)	.	00111100	74	60	3C
l	U	01010101	125	85	55
	P	01010000	120	80	56
l	D	01000100	104	68	44
	N	01001110	116	78	4E
Hz	H	01001000	110	72	48
	z	01011010	132	90	5A
kHz	k	01001011	113	75	4B
	H	01001000	110	72	48
or	k	01001011	113	65	4B
	z	01011010	132	90	5A
MHz	M	01001101	115	77	4D
	H	01001000	110	72	48
or	M	01001101	115	77	4D
	z	01011010	132	90	5A
dB	D	01000100	104	68	44
	B	01000010	102	66	42
MINUTES	M	01001101	115	77	4D
	N	01001110	116	78	4E
MEASure CONTinue	M	01001101	115	77	4D
	C	01000011	103	67	43
RDNG—OFFSET (Reading—Offset)	R	01010010	122	82	52
	O	01001111	117	79	4F
CNTR—FREQuency (Counter—Frequency)	C	01000011	103	67	43
	F	01000110	106	70	46

Table 3-11-4. Instrument Programming Codes (Cont'd).

Instruction	ASCII Characters	Binary Code	Octal Code	Decimal Code	Hexadecimal Code
BANDWIDTH					
20Hz	B	01000010	102	66	42
	1	00110001	61	49	31
400Hz	B	01000010	102	66	42
	2	00110010	62	50	32
2000Hz 1740Hz 3100Hz	B	01000010	102	66	42
	3	00110011	63	51	33
WTD (Weighted)	B	01000010	102	66	42
	4	00110100	64	52	34
MISCELLANEOUS					
Interrogate	I	01001001	111	73	49
	N	01001110	116	78	4E
CALibrate Off	C	01000011	103	67	43
	A	01000001	101	65	41
	Ø	00110000	60	48	30
CALibrate On	C	01000011	103	67	43
	A	01000001	101	65	41
	1	00110001	61	49	31
Fast Calibrate	C	01000011	103	67	43
	L	01001100	114	76	4C

3-11-61. *Interrogate.* The interrogate instruction is explained fully in Paragraph 3-11-76.

3-11-62. Formats for Instrument Programming Codes. The format for instrument programming codes depends on the sophistication of the instrument function being controlled. A unique two or three ASCII character code is sent to the instrument to activate functions controlled by momentary contact switches in Local mode. For example, the instruction E1 programs the BW CENTER tuning mode. The characters must be received by the instrument in the order shown. While the characters comprising each code must be sent in a certain order, the codes themselves can be sent in any order within a group. Sending E2, CH2 selects SSB TONE tuning, and the upper sideband CHANNEL in that order. Sending CH2, E2 will set the same instrument functions in reverse order. Note that the -hp- 3586A/B/C ignores commas. They are included in the data string examples for clarity.

3-11-63. When the -hp- 3586A/B/C is in the Local mode, certain instrument functions are set using several front panel controls. For instance, to enter the Entry Frequency, the FREQ control is pressed, the appropriate digits are entered and the Hz MIN, kHz + dB or MHz - dB is pressed. This method is used because the Entry Frequency can assume so many different values that individual switches for each value are impractical. Obviously the order in which the controls are actuated is important. When operating in the Remote mode, almost the same method is used to set the Entry Frequency except that ASCII characters are sent over the HP-IB to activate the instrument functions instead of pressing front panel controls. The ASCII character group "FR" actuates the function controlled by FREQ, ASCII digits correspond to the digit controls and the functions controlled by Hz MIN, kHz + dB and MHz - dB are actuated by the ASCII character groups "Hz", "KZ" and "MZ" respec-

tively. For example, to enter an Entry Frequency of 250kHz, the ASCII character group "FR,250,KZ" is sent. As before, the order within the group is important; however, this ASCII character group can be placed anywhere in a larger group of instrument instructions. Observe that the groups E1,FR250KZ,T1 and FR250KZ,E1,T1 and T1,E1,FR250KZ all result in the same instrument settings. Other functions of the -hp- 3586A/B/C set by this method are Frequency Step, Full Scale, Offset, Threshold and Time.

3-11-64. Outputting Data From The -hp- 3586A/B/C.

3-11-65. Data Message. The Data Message is used to transfer the results of measurements or the value of any entered parameter from the -hp- 3586A/B/C to another device on the HP-IB. Usually, the device receiving the data is the controller. Entered parameters are those instrument functions, such as Frequency and Threshold, that are set by entering numerical values. The instructions sent to the instrument before it is instructed to send data determine which type of data will be transferred. If a measure instruction is sent, measurement data will be transferred. Likewise, if an interrogate instruction is sent, the value of the entry parameter designated in the instruction will be sent.

3-11-66. Implementation. The syntax and mnemonics for the program statement used to implement the Data Message are found in the controller documentation. Usually, there is more than one program statement that will implement this Message. Each statement will have some unique advantage that makes it preferable for certain applications. Be sure to research this Bus Message thoroughly in the controller documentation. The talk address, which is P for the -hp- 3586A/B/C, and the formats of the data strings being transferred are found in the instrument documentation. The formats for measurement result are presented in Paragraph 3-11-72 and the formats for entered parameters in Paragraph 3-11-77.

3-11-67. Measure Instructions. The results of each measurement can be transferred from the -hp- 3586A/B/C only once. A measure instruction must be sent to the instrument before each measurement data transfer to make new data available. There are two instructions that will trigger a measurement in the -hp- 3586A/B/C. One is the Trigger Message. It should be used *only* when simultaneous response from the -hp- 3586A/B/C and another device on the bus is required (see Paragraph 3-11-47). The other measure instruction is the programming code TR. This instruction actually directs the instrument to wait and then measure. The duration of the time delay depends on the bandwidth selection. The delay is inserted to allow time for the IF amplifiers in the instrument to adjust to any new signal conditions that might have been programmed. The ASCII instruction is sent to the -hp- 3586A/B/C using the Data Message just like other instructions actuating instrument functions. It can be included in a group of instructions *as long as it is the last instruction in the group*. It must be the last instruction so that all of the instrument functions can stabilize during the time delay.

3-11-68. Overload, Underload and Fast Cal. If the signal being measured is not within the dynamic range of both the Input Amplifier and the IF Amplifiers, the measurement data will not have the normal instrument accuracy. Likewise, the frequency measurement is invalid when the counter is not locked to the input signal. When any of these conditions occur, it is indicated in the measurement data output string.

3-11-69. Input Amplifier Overload/Underload. A code is sent at the beginning of each measurement data string to indicate the status of the Input Amplifier. The code is O for overload, N for normal and U for underload.

3-11-70. IF Amplifier Overload/Underload. The instrument will output a level reading of +9XX.XX when the IF Amplifiers are overloaded. If they are underloaded, the level reading output will be -9XX.XX. The X's can be any digit.

3-11-71. Fast Cal. When using Fast Cal (HP-IB only) the following items should be considered:

1. When the processor receives a Fast Cal code, the instruments Full Scale and tuned frequency do not change. A Calibration is performed using the widest bandwidth on this Full Scale and frequency only; a Calibration is not performed on any other full scale or frequency. When the Calibration is complete, the processor returns the instrument to the state it was in before the Fast Cal code was received.

2. If, while the processor is performing a calibration, the Full Scale changes (this case only applies when the instrument is in Auto Range and the input signal level has changed), then the processor will use the previously stored cal constant. This could create a problem at frequencies above 1MHz. As much as a 2dB difference between Full Scales could exist (although unlikely) if the previously stored cal constant had been calculated for a different frequency.

3. Ideally, Fast Cal should be used when the instrument is in the Entry 10dB or the Entry 100dB mode.

3-11-72. Measurement Data Formats. The format of the data string sent by the -hp-3586A/B/C depends on the measurement mode. Descriptions of the formats of each measurement mode are presented in the following paragraphs. The symbols used in the format descriptions are defined as follows:

- S is the sign of the number (+ or -).
- D stands for digit (0 to 9).
- CR stands for carriage return.
- LF stands for line feed.

All other characters are sent exactly as they appear.

3-11-73. Low Distortion, Low Noise, 1010Hz, Tone 1004Hz, Noise/Demodulation, Carrier, 2600Hz, Tone 800Hz, ϕ Jitter and Noise/Tone. With the counter off, the format of the data string sent by the -hp-3586A/B/C to output this group of measurements is:

```
O
N S DDD.DDD CR LF (spaces added for clarity)
U
```

When the counter is on, the frequency is also sent. In this case, the format is:



```
O
N S DDD.DDD,FDDDDDDDD.D CR LF (spaces added for clarity)
U
```

3-11-74. *Impulse.* The signal level, time expired and number of counts are all sent when Impulse Noise measurement data is transferred from the -hp- 3586A/B/C. The format of the resulting data string is:

```
O
N S DDD.DDD,TDD.DD,CDDD CR LF (spaces added for clarity)
U
```

3-11-75. *Wideband.* The format of the data string sent by the instrument to output a wide-band measurement is:

```
O
N S DDD.DDD CR LF (spaces added for clarity)
U
```

3-11-76. **Interrogate.** The value of any Entry parameter can be output over the HP-IB. This is useful whenever a routine in the program does a search that involves an entry parameter. For example, consider a routine that finds the threshold level that permits ten impulse counts per minute. The threshold is varied using the   functions until the desired level is found. Once the desired level is found, the threshold is read using the interrogate instruction. Normally, the -hp- 3586A/B/C will output measurement data when it is addressed to talk. If Entry parameters are to be output, the instrument must be instructed to send the value of the selected parameter in place of the measurement data. This is done by sending an "interrogate" instruction to the instrument. An interrogate instruction consists of the ASCII characters IN followed by the ASCII instruction for the prefix of the selected parameter. For example, to interrogate the Frequency Step, the ASCII character group IN-SP is sent. The interrogate instruction is sent using the Data message like all other programming instructions. It can be sent in a group of instructions as long as a measure instruction does not follow it in the group. If a measure instruction follows an interrogate instruction, the interrogate instruction is negated. Once the parameter has been interrogated, its value will appear in the appropriate display until it is output. The selected Entry parameter will be output when the instrument is addressed to talk.

3-11-77. **Entry Parameter Formats.** The symbols that are used in these descriptions are defined as follows:

```
D stands for "Digit" (0 to 9)
CR stands for carriage return
LF stands for line feed
```

All other characters are sent exactly as they appear.

3-11-78. *Frequency and Frequency Step.* The Frequency and Frequency Step are output in units of Hz. The format for these Entry parameters is:

```
I DD DDD DDD.D CR LF (space added for clarity)
```

3-11-79. *Full Scale, Offset and Threshold.* The Full Scale, Offset and Threshold are output in units of decibels. The format for these entry parameters is:

```
IS DDD.DDD CR LF (spaces added for clarity)
```

3-11-80. *Time.* The format for the Entry parameter Time is:

I DD.DD CR LF (spaces added for clarity)

The units for the digits on the left of the decimal are minutes. On the right of the decimal, the units are seconds.



Free Manuals Download Website

<http://myh66.com>

<http://usermanuals.us>

<http://www.somanuals.com>

<http://www.4manuals.cc>

<http://www.manual-lib.com>

<http://www.404manual.com>

<http://www.luxmanual.com>

<http://aubethermostatmanual.com>

Golf course search by state

<http://golfingnear.com>

Email search by domain

<http://emailbydomain.com>

Auto manuals search

<http://auto.somanuals.com>

TV manuals search

<http://tv.somanuals.com>