



OPERATING AND SERVICE MANUAL

MODEL 415E SWR METER

SERIALS PREFIXED: 719-

See Appendix I and II at rear of manual for:

- a) 415E Options 01, 02, and
- b) Serials Prefixed 530-, 545-

Copyright HEWLETT-PACKARD COMPANY 1965
1501 PAGE MILL ROAD, PALO ALTO, CALIFORNIA, U.S.A.

LIST OF ILLUSTRATIONS

Number	Title	Page	Number	Title	Page
1-1.	Model 415E SWR Meter	1-0	4-1.	Block Diagram	4-1
2-1.	The Combining Case	2-0	5-1.	Test Set Up.	5-3
2-2.	Steps to Place Instrument in Combining Case	2-0	5-2.	Examples of Diode Marking Methods	5-9
2-3.	Adapter Frame Instrument Combinations	2-1	5-3A.	Switch Component Location	5-10
2-4.	Two Half Modules in Rack Adapter	2-2	5-3B.	Switch Component Location	5-10
3-1.	Front Panel Operating Controls and Connector	3-2	5-4.	Transistor Biasing and Operating Characteristics	5-12
3-2.	Rear Panel Operating Controls and Connectors	3-2	5-5.	Power Supply Waveforms (AC Operation Only	5-14
3-3.	Typical SWR Measurement Setup	3-3	5-6.	Power Supply Waveforms (Initial Battery Operation - Only)	5-15
3-4.	General Turn-On Procedure	3-4	5-7.	Signal Flow Waveforms (Input to Amplifier Output)	5-16
3-5.	Expanded Section of Figure 3-6	3-5	5-8.	Meter and Output Waveforms	5-17
3-6.	Converting Decibels to SWR	3-6	5-9.	Schematic Notes	5-18
3-7.	Attenuation Measurement Setup	3-6	5-10.	Circuit Board Component Location	5-19
3-8.	Impedance Measurement Rules Summary	3-7	5-11.	Power Supply and Input Circuit	5-19
3-9.	Shift of Minimum with Load and Short	3-7	5-12.	Output and Meter Circuit	5-21
3-10.	Example for Use of Smith Chart	3-8	I-1.	Battery - Cover Assembly	I-1
3-11.	415E Noise Figure Curves	3-10	I-2.	Connector Assembly.	I-1
3-12.	Meter Noise Correction Curve	3-10	II-1.	Circuit Board Component Location- Instruments Prefixed 530	II-1

LIST OF TABLES

Number	Title	Page	Number	Title	Page
1-1.	Specifications	1-0	5-4.	Out-of-Circuit Transistor Resistance Measurements	5-12
3-1.	Panel Descriptions	3-3	5-5.	Ohmmeter Ranges for Transistor Resistance Measurements	5-12
5-1.	Recommended Test Equipment	5-1	6-1.	Reference Designation Index	6-2
5-2.	Performance Tests	5-3	6-2.	Replaceable.	6-8
5-3.	Etched Circuit Soldering Equipment	5-8	6-3.	Code List of Manufacturers	6-11

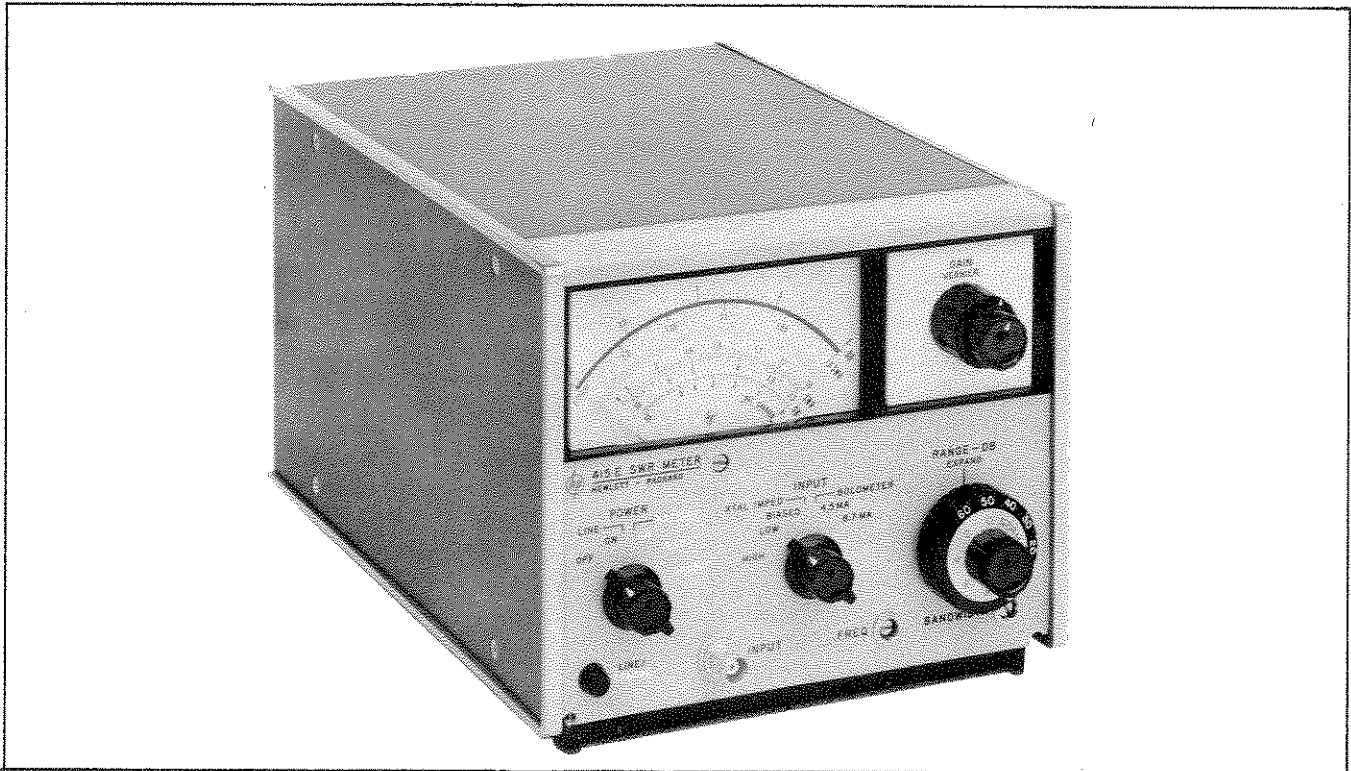

Figure 1-1. Model 415E SWR Meter

Table 1-1. Specifications

Sensitivity: 0.15 μV rms at maximum bandwidth (1 μV rms on high impedance crystal input).

Noise: At least 7.5 db below full scale at rated sensitivity and maximum bandwidth with input terminated in optimum source impedance (see Input). Noise figure less than 4 db.

Range: 70 db in 10 and 2 db steps.

Accuracy: ± 0.05 db/10 db step; maximum cumulative error between any two 10-db steps, ± 0.10 db; maximum cumulative error between any two 2-db steps, ± 0.05 db. Linearity: ± 0.02 db on expand scales, determined by inherent meter resolution on normal scales.

Input: Unbiased low and high impedance crystal (100 and 5000 ohm optimum source impedance respectively); biased crystal (1 v into 1K); low and high current bolometer (4.5 and 8.7 ma $\pm 3\%$ into 200 ohms), positive bolometer protection. Input connector, BNC female.

Input Frequency: 1000 cps, adjustable 7%. Other frequencies between 400 and 2500 cps available on special order.

Bandwidth: Variable, 15 to 130 cps. Typically less than 0.5 db change in gain from minimum to maximum bandwidth.

Recorder Output: 0 to 1V, 1000 ohms source impedance, BNC female.

Amplifier Output: 0 to 0.3V rms (NORM), 0 to 0.8 rms (EXPAND) into at least 10K ohms, dual banana jacks.

Meter Scales: Calibrated for square-law detectors. SWR: 1 to 4, 3.2 to 10 (NORM); 1 to 1.24 (EXPAND). DB: 0 to 10 (NORM); 0 to 2.0 (EXPAND). Battery: charge state.

Meter Movement: 0.25% movement, taut-band suspension, mirror-backed scale with expanded db and swr scales greater than 4-1/4 in. (108 mm) long.

Power: 115 or 230 volts $\pm 10\%$, 50 to 400 cps, 2 watts. Power line frequency or multiples thereof must not be at the tuned amplifier frequency. Optional rechargeable battery provides up to 36 hours continuous operation.

Dimensions: 7-25/32 in. wide, 6-3/32 in. high, 11 in. deep from front side rail (190 x 155 x 279 mm).

Weight: Net 7-7/8 lb (3, 5 kg), 9-7/8 lb (4, 4 kg) with battery.

Options:

01. Rechargeable battery installed.
02. Rear-panel input connector in parallel with the front-panel connector.

SECTION I

GENERAL INFORMATION

1-1. INTRODUCTION.

1-2. The Model 415E SWR Meter is a high-gain amplifier, tuned to an audio frequency, with a square-law calibrated meter readout. The Model 415E is designed for use with square-law detectors in the measurement of SWR and attenuation. In addition, because of the high-sensitivity and tuned amplifier, it can be used as a null detector for audio frequency bridges. The Model 415E is shown in Figure 1-1. Operating Specifications for the Model 415E are given in Table 1-1.

1-3. The Model 415E is a tuned audio amplifier designed to operate at a mean center frequency of 1000 cps (Hz), adjustable 7% with a variable bandwidth of from 15 to 130 cps (Hz). Operating center frequency and bandwidth are both variable at instrument front panel. Tuned amplifier gain is only slightly changed due to any change in bandwidth and is typically less than 0.5 db. In addition to the front panel meter readout provided by the SWR Meter, two rear panel outputs are also available: An AC amplifier output is provided to allow using the 415E as a high-gain (126 db) tuned amplifier; a DC recorder output providing a convenient means of obtaining a permanent record of measurement data. Either or both of these rear panel outputs can be used without affecting instrument meter operation provided power line ground is not connected to the instrument through either rear panel connector.

1-4. INSTRUMENTS COVERED BY MANUAL.

1-5. This manual applies directly to the Model 415E SWR Meters having serial numbers prefixed 719 (first

three numbers of serial number). If the serial prefix on your instrument is other than 719, there are differences between the manual and your instrument which are described in a Manual Changes sheet included with the manual. If the manual changes sheet is missing, the information can be supplied by your nearest Hewlett-Packard Sales and Service Office (see lists at the rear of this manual). The manual change sheet may also include an "ERRATA" section which describes manual correction information which applies to the manual for all instruments including instruments prefixed 719.

1-6. INSTRUMENT OPTIONS.

1-7. This manual provides operating and servicing information for the standard Model 415E. In addition, operating and servicing information for Model 415E instruments with Options 01 and/or 02, described below, is also included.

a. Option 01: Factory installed, 24-volt rechargeable battery capable of supplying up to 36 hours continuous operation of the Model 415E. If not initially installed as an option, the same battery is available on order from Hewlett-Packard (see Paragraph 2-17).

b. Option 02: Additional input connector on rear panel wired in parallel with the front panel INPUT connector. If not initially installed as an option, the connector-cable assembly is available on order from Hewlett-Packard (see Paragraph 2-17).

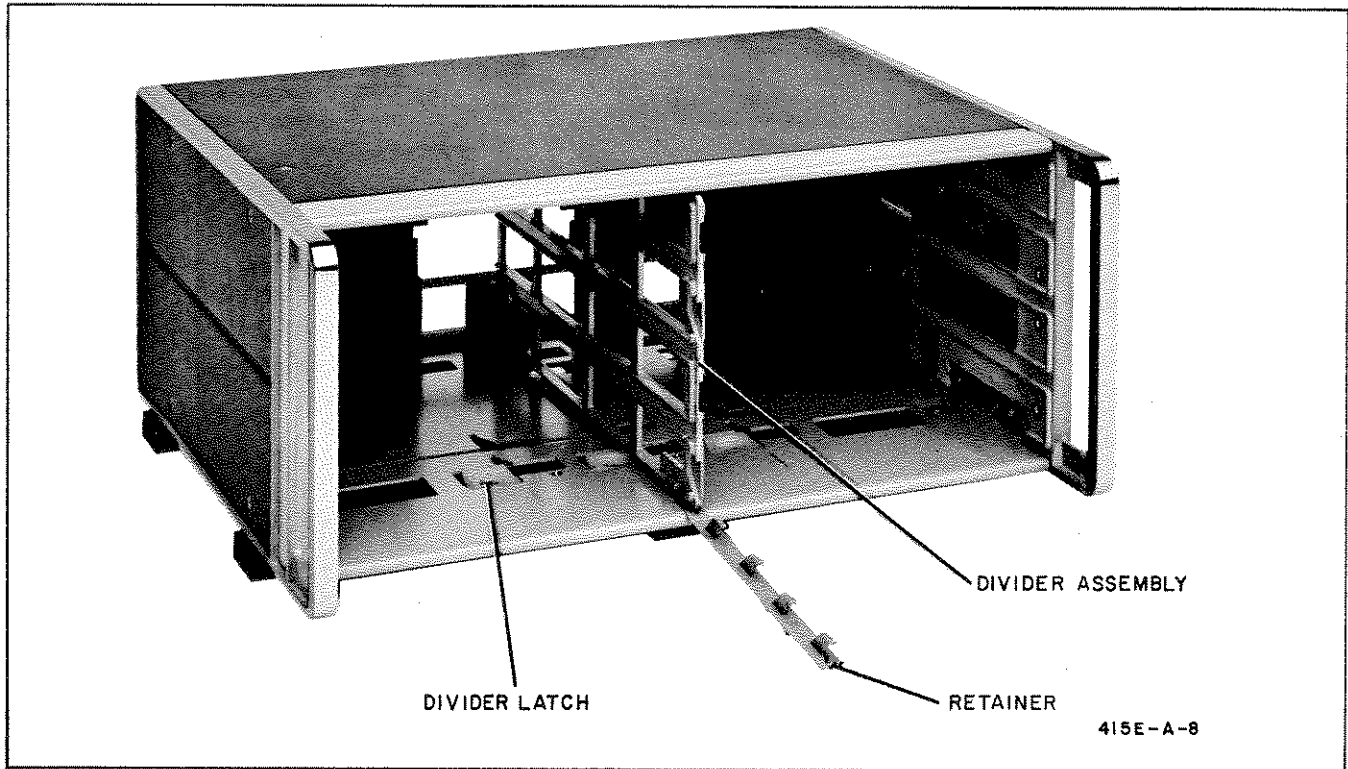

Figure 2-1. The Combining Case

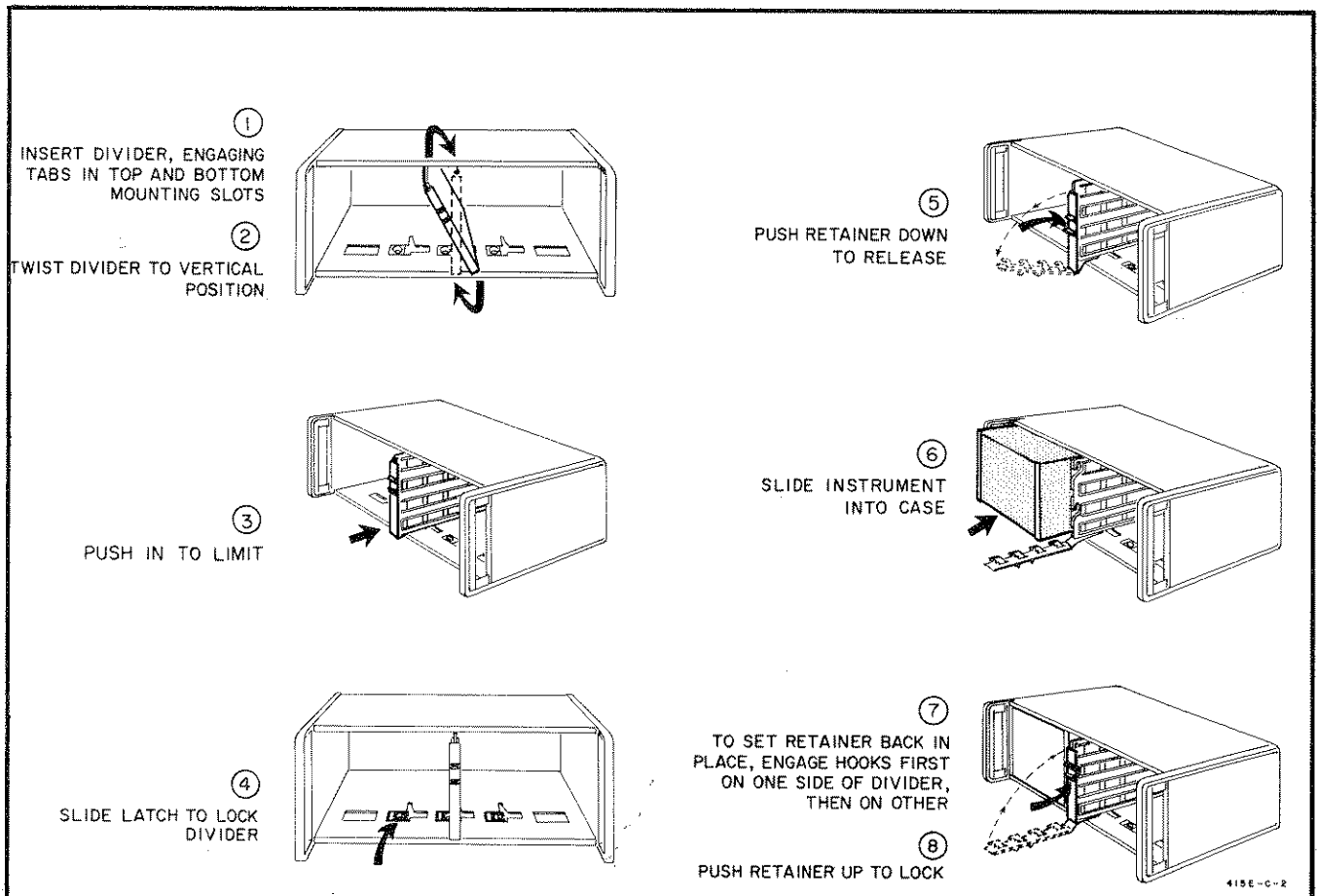

Figure 2-2. Steps to Place Instrument in Combining Case

SECTION II

PREPARATION FOR USE

2-1. INCOMING INSPECTION.

2-2. This instrument was inspected both mechanically and electrically before shipment. To confirm this, the instrument should be inspected for physical damage in transit. Also check for supplied accessories, and test the electrical performance of the instrument, using the procedure outlined in Paragraph 5-3. If there is damage or deficiency, see the warranty on the inside front cover of this manual.

2-3. INSTALLATION.

2-4. The Model 415E is fully transistorized; therefore no special cooling is required. However, the instrument should not be operated where the ambient temperature exceeds 55°C (140°F).

2-5. RACK MOUNTING.

2-6. The Model 415E is a submodular unit that when used alone can be bench mounted only. However, when used in combination with other submodular units it can be bench and/or rack mounted. The hp combining case and adapter frame are designed specifically for this purpose.

2-7. **COMBINING CASE.** The combining case is a full-module unit which accepts varying combinations of submodular units. Being a full-module unit, it can be bench or rack mounted analogous to any full-module instrument. An illustration of the combining case is shown in Figure 2-1. Instructions for installing the Model 415E in a combining case are given graphically in Figure 2-2.

2-8. **ADAPTER FRAME.** The adapter frame is a rack frame that accepts any combination of sub-modular units. It can be rack mounted only. An illustration of the adapter frame is given in Figure 2-3. Instructions are given below:

- a. Place the adapter frame on edge of bench as shown in step 1, Figure 2-4.
- b. Stack the sub-modular units in the frame as shown in step 2, Figure 2-4. Place the spacer clamps between instruments as shown in step 3, Figure 2-4.
- c. Place spacer clamps on the two end instruments (see step 4, Figure 2-4) and push the combination into the frame.
- d. Insert screws on either side of frame, and tighten until sub-modular instruments are tight in the frame.
- e. The complete assembly is ready for rack mounting.

2-9. THREE-CONDUCTOR POWER CABLE.

2-10. To protect operating personnel, the National Electrical Manufacturers' Association (NEMA) recommends that the instrument panel and cabinet be grounded. All Hewlett-Packard instruments are

equipped with a three-conductor power cable which, when plugged into an appropriate receptacle, grounds the instrument. The offset pin on the power cable three-prong connector is the ground wire.

2-11. To preserve the protection feature when operating the instrument from a two-contact outlet, use a three-prong to two-prong adapter and connect the green pigtail on the adapter to ground.

2-12. PRIMARY POWER REQUIREMENTS.

2-13. The Model 415E can be operated from an AC or DC primary power source. The AC source can be either 115 or 230 volts, 50 to 400 cps. The DC source is a 24-volt rechargeable battery. The rechargeable battery is supplied with option 01 instruments only.

2-14. For operation from AC primary power, the instrument can be easily converted from 115- to 230-volt operation. The **LINE VOLTAGE** switch, S1, a two-position slide switch located at the rear of the instrument, selects the mode of AC operation. The line voltage for which the instrument is set to operate appears on the slider of the switch. A 1/16-ampere, 250 volt fuse is used for both 115- and 230-volt operation.

CAUTION

DO NOT CHANGE THE SETTING OF THE
LINE VOLTAGE SWITCH WHEN THE IN-
STRUMENT IS OPERATING.

2-15. INITIAL BATTERY CHECK.

2-16. The following applies to option 01 instruments or instruments that have field-installed batteries. When the battery is used as the power source for the first time, perform the following steps:

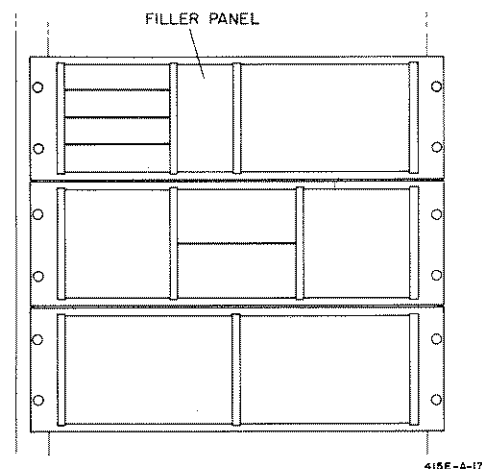

Figure 2-3. Adapter Frame Instrument Combinations

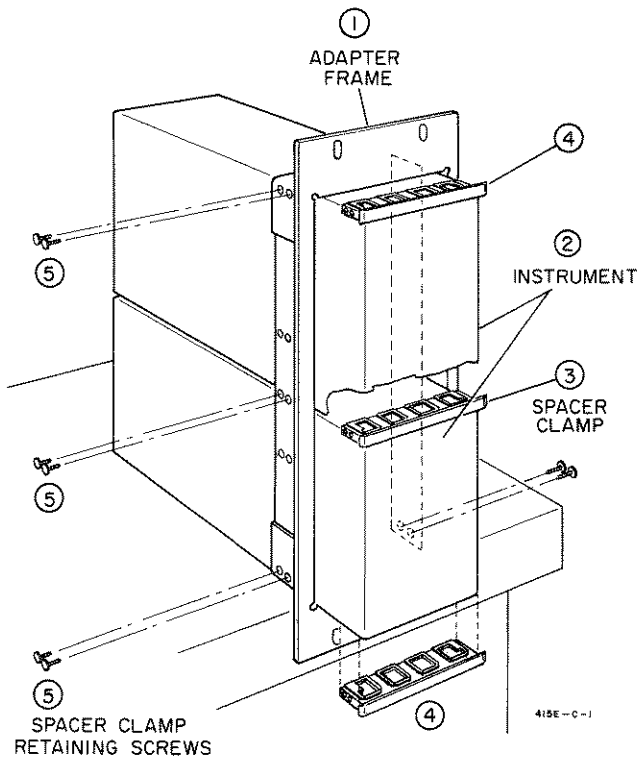

Figure 2-4. Two Half Modules in Rack Adapter

a. Connect Model 415E to AC source. Set POWER switch to CHARGE and charge battery for a minimum of 16 hours or overnight. Note: the battery can be maintained in the charging state indefinitely without damaging the battery. It will assume its full capacity, 1.25 ampere hour, and no more.

b. Set POWER switch to TEST position, the meter needle indication should be within the "BAT. CHARGED" area (see Figure 3-1).

2-17. INSTALLING BATTERY AND INPUT CONNECTOR.

2-18. Available from Hewlett-Packard are parts required for modifying any Model 415E to correspond to those instruments with Option 01 and/or Option 02. A rechargeable Battery Installation Kit, hp Part Number 00415-606, contains the battery and necessary hardware for installation (corresponds to Option 01). Installation instructions are detailed in Appendix at rear of this manual. To obtain the parts required for an input connector on the rear panel (corresponding to Option 02), order by hp Part Number as found in Table 6-1 (listed under Option 02). Instructions for installation of this additional connector are detailed in Appendix at rear of this manual.

2-19. REPACKAGING FOR SHIPMENT.

2-20. When returning an instrument to the Hewlett-Packard Company, use the original packing material (if foam type) if available or contact an authorized hp Sales Office for assistance. If this is not possible, first protect the instrument surfaces by wrapping in heavy Kraft paper or with sheets of cardboard flat against the instrument. Then protect the instrument on all sides (use approximately 4 inches of packing material designed specifically for package cushioning), pack in a durable container, mark container clearly for proper handling, and insure adequately before shipping.

Note

When an instrument is being returned to the Hewlett-Packard Company for service or repair, attach a tag to the instrument specifying the owner and desired action. All correspondence should identify the instrument by model number and the full (eight-digit) serial number.

SECTION III

OPERATING INSTRUCTIONS

3-1. INTRODUCTION.

3-2. This section contains information and procedures for operation of the Model 451E (from either AC or battery power source) in making swr and attenuation measurements. Also included is information on slotted line techniques, instruction in the use of a Smith Chart for plotting load impedance, and discussion of Model 451E noise performance with various source impedances and noise effect on meter indication.

3-3. FRONT AND REAR PANEL FIXTURES.

3-4. Figures 3-1 and 3-2 identify by number the front and rear panel fixtures of the Model 451E. The descriptions in Table 3-1 are keyed by number (1-12 for front, 13-18 for rear) to the figures. Further information regarding the various settings and uses of the controls, indicators, connections, and adjustments is included in the procedures of this section. Information on battery is found in Paragraph 3-6.

3-5. GENERAL OPERATING AND MEASUREMENT CONSIDERATIONS.

3-6. BATTERY OPERATION.

3-7. The Model 451E may be operated from a battery instead of the 115 or 230 volt AC supply (see Paragraph 2-13). Battery operation requires some slightly different procedures to prolong battery life and to ensure proper results. The rechargeable nickel-cadmium battery is factory installed if ordered as Option 01 (see Paragraph 1-7). The same battery may be ordered and installed later. To obtain this, order hp Stock Number 00415-606, Rechargeable Battery Installation Kit.

3-8. INITIAL BATTERY USE. When the Model 451E is to be battery operated for the first time, perform the following steps:

a. Switch the Model 451E POWER switch to BATTERY/TEST position and note meter pointer indication: A meter pointer indication in the "BAT. CHARGED" area indicates the internally battery properly charged and ready for use; A meter pointer indication to the left of the "BAT. CHARGED" area means that the battery must be charged as described below.

b. Connect the Model 451E to AC power source. Set POWER switch to BATTERY/CHARGE and charge the battery for a minimum of 16 hours or overnight.

c. After at least 16 hours of recharge time, switch POWER switch to BATTERY/TEST position and check battery charge. If the battery charge indication is still unsatisfactory, see Paragraph 5-35.

3-9. OPTIMUM BATTERY USAGE. It is recommended that the Model 451E be operated by the battery for up to 8 hours, followed by 16 hours of recharge. If continuous battery operation is required for more than 8 hours, the recharge time should be double the operating time. Continuous battery operation is possible for up to 36 hours but this must be followed by a prolonged recharge period.

3-10. BATTERY STORAGE. Storage of the battery at or below room temperature is best. Extended storage at high temperatures will reduce the cell charge but not damage the battery if the storage temperature is less than 140°F. It is suggested that the battery be charged after removal from storage and before using the Model 451E for battery operation.

3-11. GROUND LOOP CURRENTS.

3-12. The 451E SWR Meter audio amplifier has high sensitivity to low level signals. To reduce ground loop currents, the 451E grounds are isolated by a 46.4 ohm resistor. Ground loops occur when instruments are connected to 451E outputs and grounded through power cords or rack mountings. Ground loops can be minimized in the following ways:

a. Connect the 451E to instruments with floating inputs;

b. Connect the 451E to instruments with high input impedance; Connect only the signal wire between instrument and the 451E;

c. Operation at higher signal levels;

d. An Adapter on the power cord to float the instrument ground where not prohibited by safety regulations.

3-13. BANDWIDTH AND FREQUENCY SELECTION.

3-14. Two front panel adjustments are provided to optimize operation of the Model 451E tuned amplifier. The FREQ (frequency) control allows a total variation of 7% of the center tuned frequency. When more than one Model 451E is included in the same measurement setup, the variable tuned frequency is used to set all the instruments to the exact frequency modulating the source. The high sensitivity and narrow bandwidth of the amplifier make the Model 451E valuable as a meter-indicating null detector for audio frequency bridges. The BANDWIDTH adjustment varies the tuned filter bandwidth from 15 to 130 cps. A narrow bandwidth is best for low level signals as this improves the signal to noise ratio. A wide bandwidth would find more use in fast sweep rate measurements.

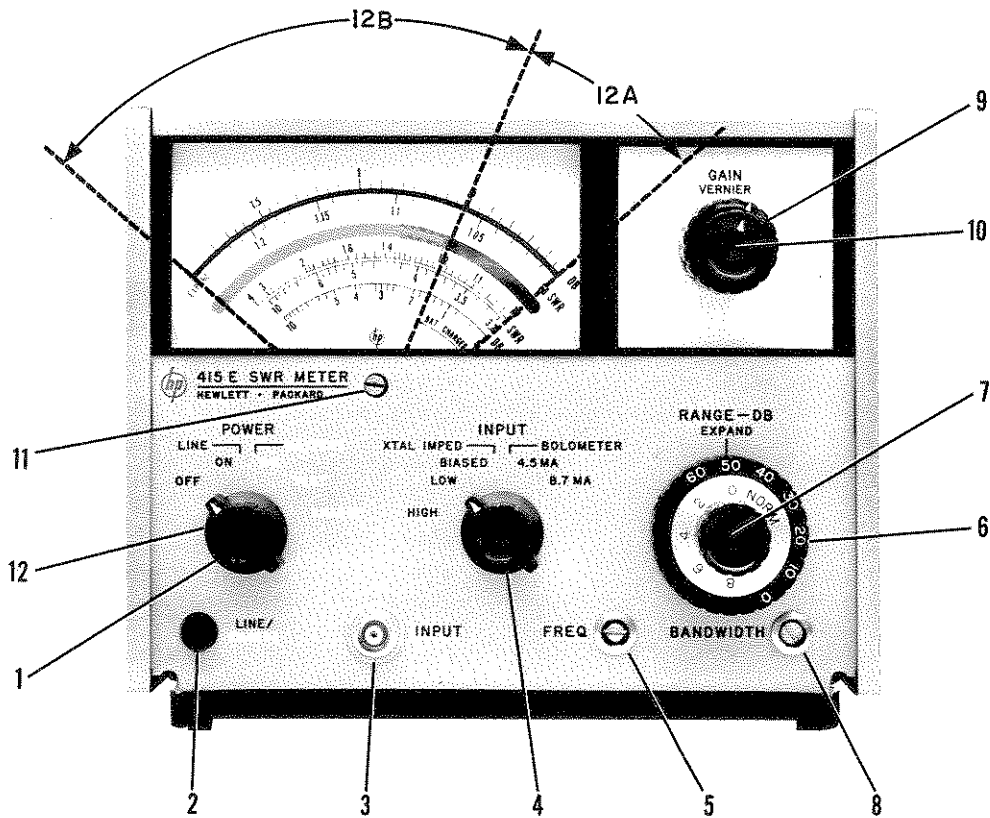

415E-A-9

Figure 3-1. Front Panel Operating Controls and Connector

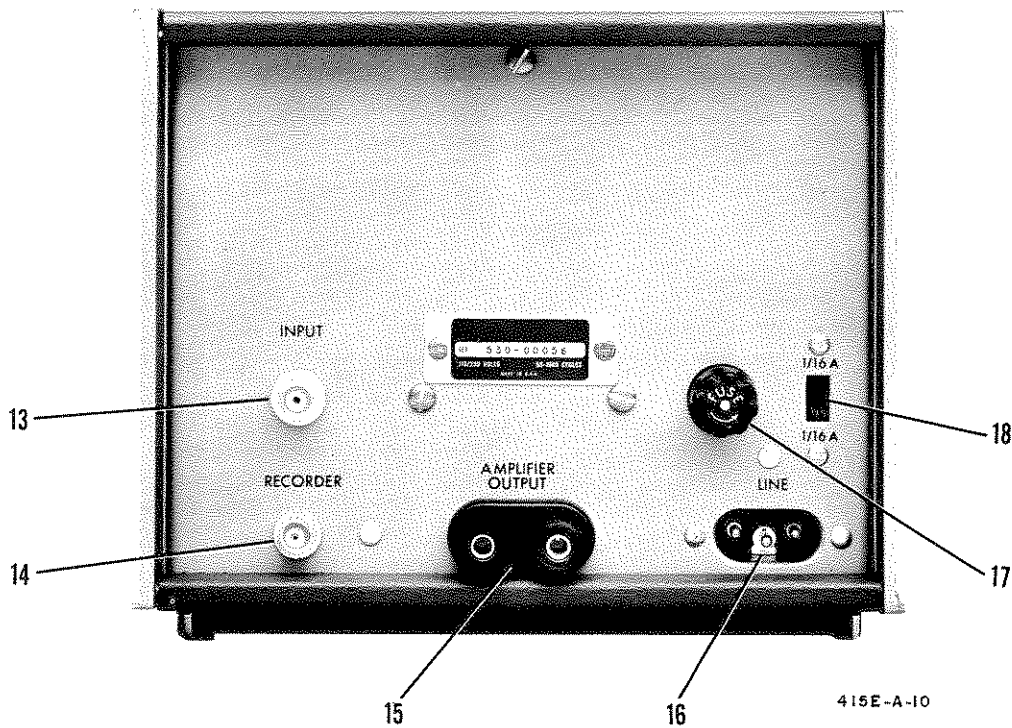

415E-A-10

Figure 3-2. Rear Panel Operating Controls and Connectors

Table 3-1. Panel Descriptions

1. Selects desired 415E power source: BATTERY/CHARGE position allows internal battery recharge when power cord is connected to AC line.	11. Mechanical zero adjustment allows exact setting of meter needle to 2.0 db calibration mark.
2. Indicator lights when power switch is in LINE/ON or BATTERY/CHARGE position.	12. With POWER switch set to BATTERY/TEST, a meter needle indication within the "BATTERY CHARGE" area on the meter face (indicated by 12A) shows that internal battery is charged sufficiently for proper 415E operation; if needle indicator is to left (area 12B) of "BATTERY CHARGED" area, then battery is not charged sufficiently for proper instrument operation (option 01 - ONLY).
3. Female BNC INPUT connector.	13. Additional input connector (wired in parallel with front panel connector); supplied as Option 02 for 415E only upon request.
4. Set input of Model 415E for use with a bolometer or crystal detector mount. See Paragraph 3-53.	14. DC output for recorder use (0 to 1 volt into open circuit or 1000 ohms).
5. Adjustment allows center frequency variation by 70 cps.	15. AC output for use as tuned amplifier output.
6. Attenuator adjusts gain in 10 db steps.	16. Three-conductor AC power cord receptacle (NEMA-type).
7. Allows full scale expansion of any 2.0 db portion of the 10-db scale.	17. Contains power line fuse.
8. Changes bandwidth from 15 to 130 cps.	18. Slide switch to allow 115- or 230-volt AC operation.
9. Allows initial meter reference setting with a control range of at least 10-db.	
10. Provides fine adjustment of GAIN control meter settings.	

3-15. SWR MEASUREMENT EQUIPMENT AND TECHNIQUES.

3-16. EQUIPMENT.

3-17. A typical setup of equipment used in SWR measurements is shown in Figure 3-3. The signal source is usually square-wave modulated at 1000 cps since other modulating waveforms often cause undesirable frequency modulation of the source. Harmonics from the source sometimes cause trouble and can be eliminated with a low-pass filter.

3-18. The detector should be a square-law device (output voltage proportional to RF power input) such as a barretter or a crystal diode operated at low signal levels. The meter of the 415E is calibrated for square-law detectors. Crystal diodes are normally more sensitive than barretters but barretters are square-law over a wider dynamic range. Both types of detector normally maintain accurate square-law response up to at least full scale deflection with the RANGE-DB switch set to 30 position and coarse GAIN at maximum. (1 mv RMS sine wave or 2.2 mv peak-to-peak square wave causes full scale deflection on HIGH XTAL IMPED position. On other positions of INPUT switch, 0.15 mv RMS sine wave or 0.33 mv peak-to-peak square wave causes full scale deflection.) Above this level these detectors should be individually checked for departure from square-law behaviour or manufacturer's data should be consulted.

3-19. A short circuit termination is useful in establishing reference positions along the transmission line and is measuring transmission line wavelengths.

3-20. SLOTTED LINE PROBE PENETRATION.

3-21. A general rule in slotted line measurement is to use minimum probe penetration that still picks up adequate signal to measure. The probe couples to the

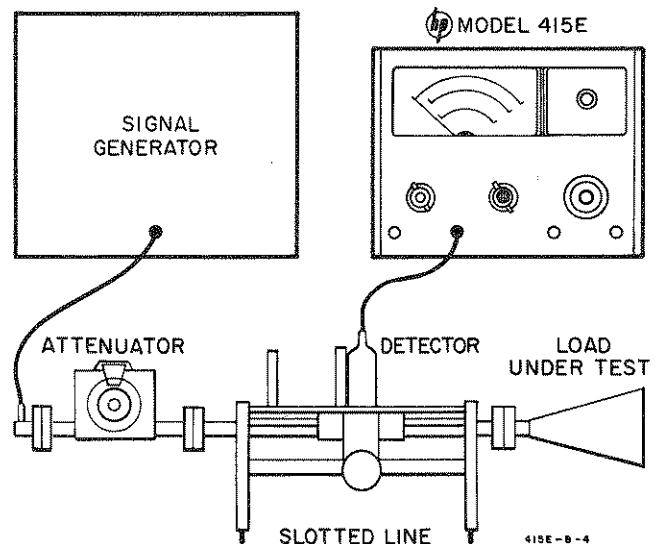
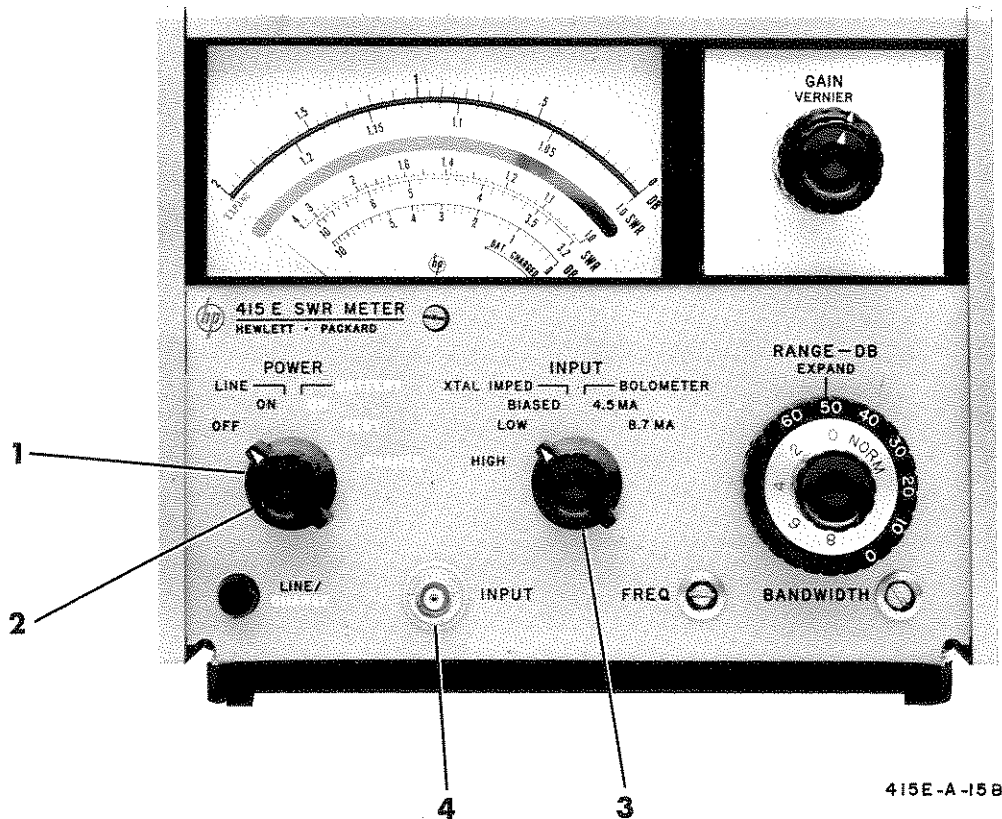

Figure 3-3. Typical SWR Measurement Setup



1. Set POWER switch to OFF. Meter pointer should rest at 2 on the 0-2 DB scale (if not refer to Paragraph 5-10).

2. Set POWER switch to LINE/ON (or BATTERY/ON).

Note

If set to BATTERY/ON refer to Paragraph 3-5 and check battery potential.

3. Set INPUT to desired input impedance. (Note see Paragraph 3-55.)

4. Connect audio source to INPUT (i.e., crystal detector, bolometer, audio oscillator, etc.).

5. Adjust modulation frequency (audio input signal) to approximately 1000 cps.

6. Adjust RANGE-DB, GAIN, and VERNIER controls and the amplitude of the input signal for a convenient meter reference near mid-scale.

7. Adjust FREQ control for maximum meter pointer deflection.

8. Adjust BANDWIDTH control: fully counterclockwise rotation is minimum bandwidth and fully clockwise rotation is maximum bandwidth.

Note

A narrow bandwidth is usually best for low level signals; 30 cps is convenient for most applications; and a wide bandwidth is usually best for fast sweep rate measurements.

Figure 3-4. General Turn-On Procedure

transmission line as a shunt admittance which increases (disturbing the transmission line more) as the probe penetrates farther. To find out whether a given probe penetration is too great or not, measure SWR, then change probe penetration and remeasure SWR. If the second reading is different, the probe is penetrating too far and loading the transmission line significantly.

3-22. PROCEDURE.

3-23. MODERATE SWR. The scales of the 415E are calibrated for reading standing wave ratio directly from the meter. Set the slotted line probe at a voltage maximum and adjust the gain of the 415E with the RANGE-DB, GAIN, and VERNIER controls (EXPAND switch to NORM) for full scale deflection (1.0 on the 1.0 to 4 SWR

scale). Now move the probe toward a minimum. If the meter drops below 3.2, rotate the RANGE-DB switch one position clockwise and read on the 3.2 to 10 SWR scale. If the pointer drops below this scale, rotate RANGE-DB switch one more position clockwise and read on the 1.0 to 4 scale and multiply by 10. This pattern continues for still higher SWR readings.

3-24. The DB scales can be used for a standing wave ratio measurement by setting the 415E to full scale at a voltage maximum, then turning the RANGE-DB switch clockwise for an on scale reading at a voltage minimum and noting the difference in DB readings at the maximum and minimum. A DB reading is obtained by adding RANGE-DB switch setting and meter indication.

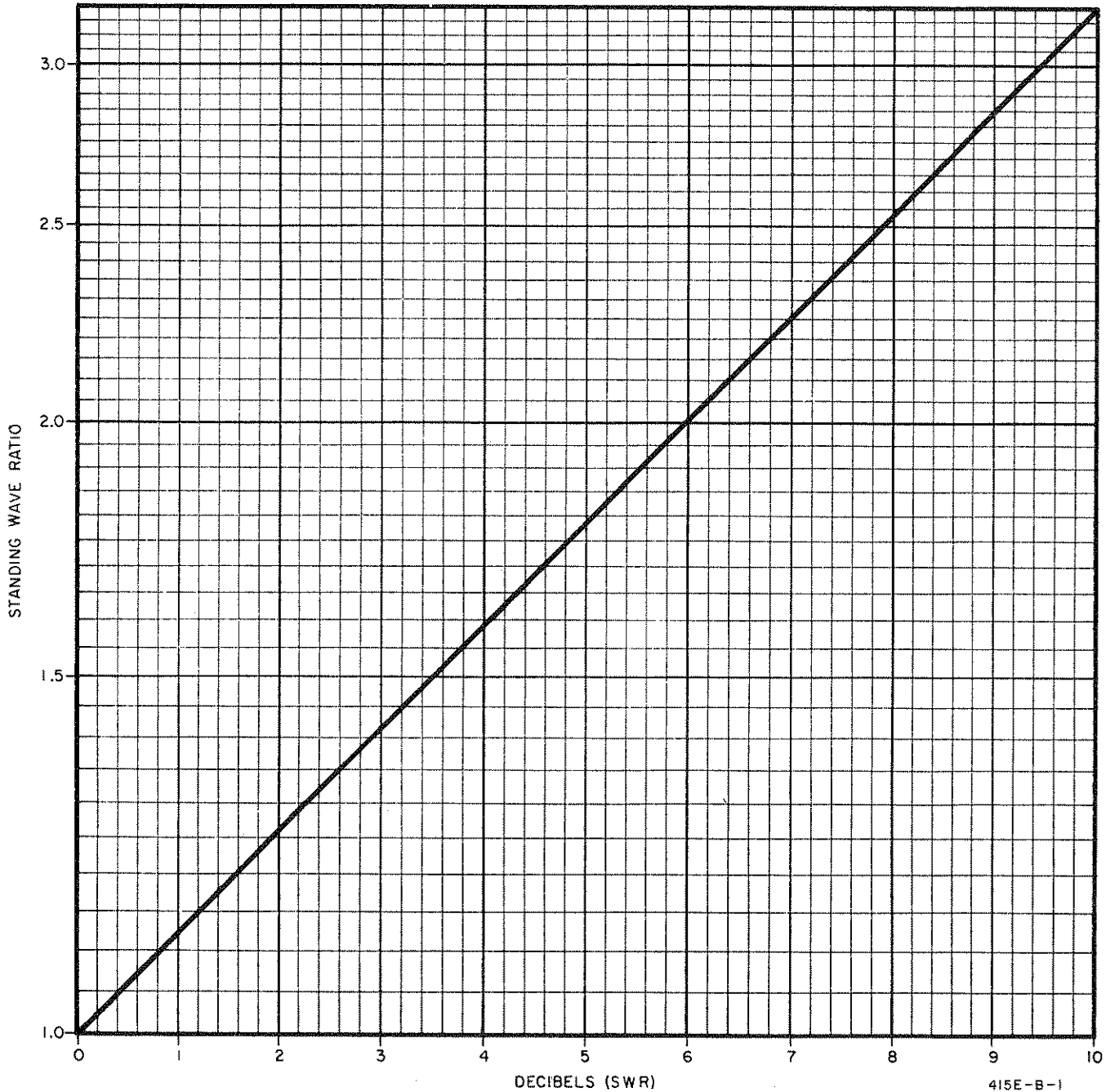

Figure 3-5. Expanded Section of Figure 3-6

Paragraphs 3-25 to 3-32

3-25. **LOW SWR.** Standing wave ratio between 1.0 and 1.24 can be read quite accurately on the EXPAND scales of the meter when the EXPAND switch is set to any position other than NORM.

3-26. **MODERATE SWR, HIGH RESOLUTION.** The EXPAND and -DB scale can be used together with the EXPAND switch to read any SWR with high resolution in DB. Figure 3-5 and 3-6 are used to convert DB to SWR. The reference level (full scale meter deflection at a voltage maximum) can be used with the EXPAND switch at NORM (since 0 db NORM and 0 db EXPAND correspond) but greater accuracy is obtained by setting the reference level with the EXPAND switch to 0.

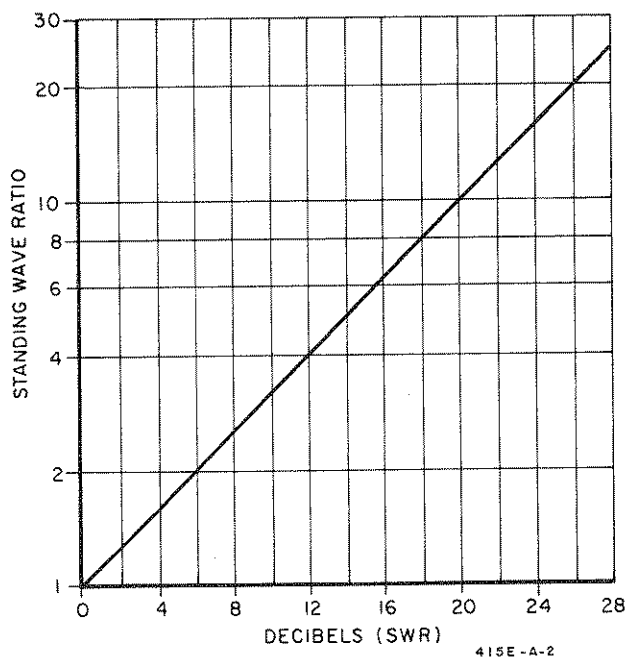

Figure 3-6. Converting Decibels to SWR

3-27. **HIGH SWR.** High standing wave ratios (greater than 30, or sometimes 10) present problems because of excessive probe penetration (to lift the minimum above the noise level) and departure of detector behaviour from square-law. Both problems are lessened or eliminated by measuring only the standing wave pattern near the voltage minimum, where probe loading effects are least disturbing.

3-28. **TWICE-MINIMUM POWER METHOD.** The basis for this method (and the TEN-TIMES-MINIMUM POWER METHOD) is the fact that for a high SWR, the standing wave pattern approximates a parabola in the vicinity of a voltage minimum. The slotted line carriage must have a good scale or dial indicator. Measure the distance (ΔX) between positions on the standing wave pattern where the voltage is 3 db above the voltage at the minimum. Also measure the transmission line wavelength λ_g (standing wave pattern minima are one-half wavelength apart and the sharp minima resulting from

short-circuiting the transmission line are easy to locate accurately). Compute the SWR from the following formula:

$$SWR = 1/\pi (\lambda_g/\Delta X).$$

3-29. **TEN-TIMES-MINIMUM POWER METHOD.** Another convenient "level above minimum method" to use for computing SWR is a level 10 db above minimum. The separation (ΔX) between these positions should be put in the following formula:

$$SWR = 3/\pi (\lambda_g/\Delta X)$$

For standing wave ratios as low as 15 to 1, the accuracy of this method is within 1%.

3-30. **SWR MEASUREMENT-SOURCES OF ERROR.** Several possibilities have already been mentioned: excessive frequency modulation of source (smears out sharp, deep nulls of high SWR pattern), harmonics of signal frequency from source, departure of detector from square-law behaviour, and excessive probe penetration. Also, reflections in the transmission line between the slotted line and device being measured must be minimized.

3-31. ATTENUATION MEASUREMENT.

3-32. The 415E may be used for high resolution insertion loss measurements simply by inserting the device to be measured between signal source and detector and noting the change in DB indication on the 415E. A typical measurement is shown in Figure 3-7. The continuous coverage of the EXPAND scales allows any attenuation measurement to be made on the EXPAND scales. For accurate results, both the signal source and the detector should be well matched. Impedance match of source and detector can be improved, if necessary, with padding attenuators, isolators, or tuners.

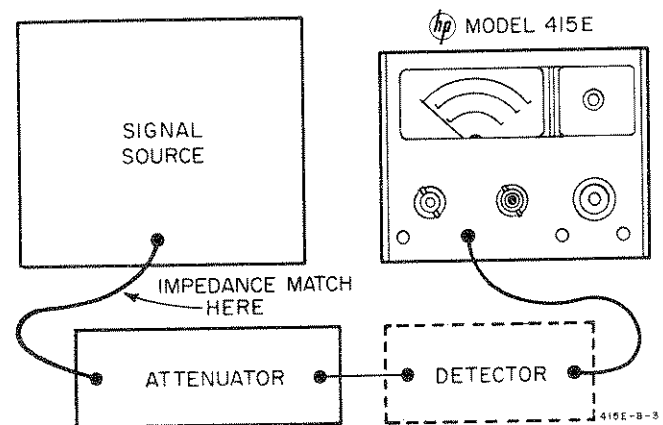

Figure 3-7. Attenuation Measurement Setup

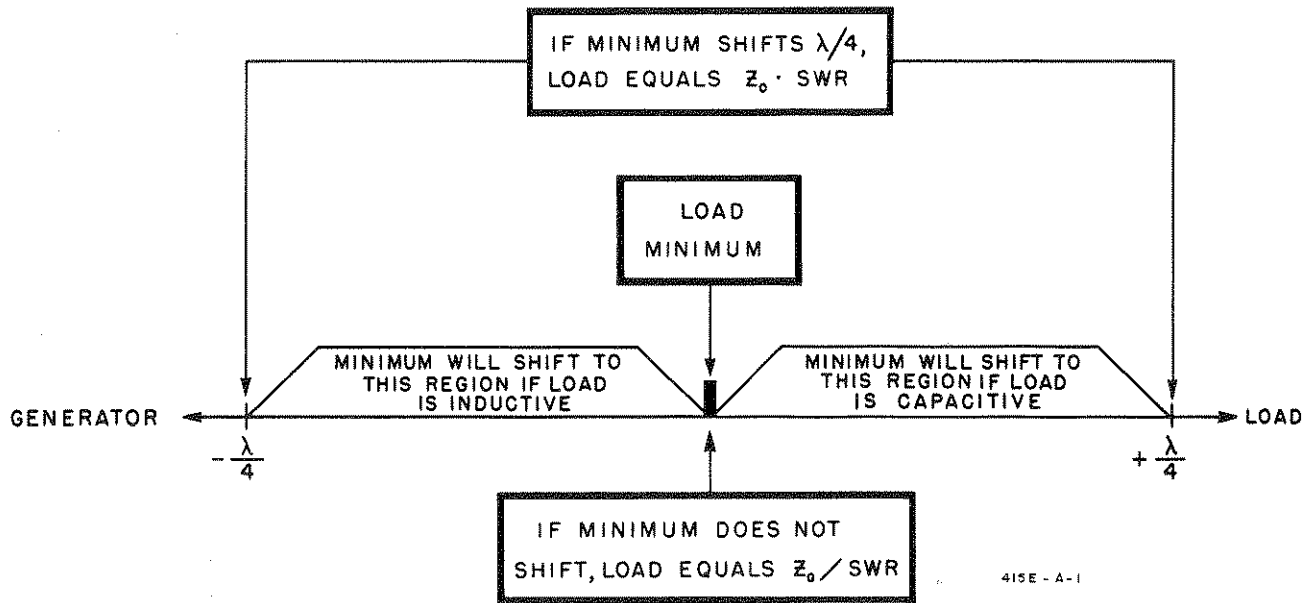

Figure 3-8. Impedance Measurement Rules Summary

3-32. LOAD IMPEDANCE MEASUREMENT.

3-33. GENERAL.

3-34. Slotted line techniques provide information to allow calculation of a load impedance. The following rules apply to the indications given by the voltage minimum when the load is replaced by a short. Figure 3-8 summarizes and graphically presents these impedance measurement rules. When the load is replaced by a short, then:

- a. The shift in the minimum is never more than $\pm 1/4$ wavelength.
- b. If the minimum moves toward the load, the load has a capacitive component.
- c. If the minimum moves toward the generator, the load has an inductive component.
- d. If the minimum does not move, the load is completely resistive and has a normalized value of $1/\text{swr}$.
- e. If the minimum shifts exactly one-quarter wavelength, the load is completely resistive and has a normalized value equal to the swr .

f. The minimum will always be at a multiple of a half wavelength from the load.

3-35. IMPEDANCE MEASUREMENT PROCEDURE.

3-36. The procedure for performing the actual impedance measurement with a slotted line is as follows:

- a. Connect the load under test to the slotted line section and measure the swr (see Paragraph 3-26 or 3-28). Also note the position of the probe carriage at the minimum.
- b. Replace the load under test with a short.
- c. Locate the minimum with the line shorted.

d. Referring to Figure 3-9 and the following formulas, compute the normalized load impedance:

$$\text{Normalized } Z_L = \frac{1 - j(\text{swr}) \tan X}{(\text{swr}) - j \tan X}$$

$$\text{where } X = \frac{180^\circ (\pm \Delta d)}{\lambda_g/2}$$

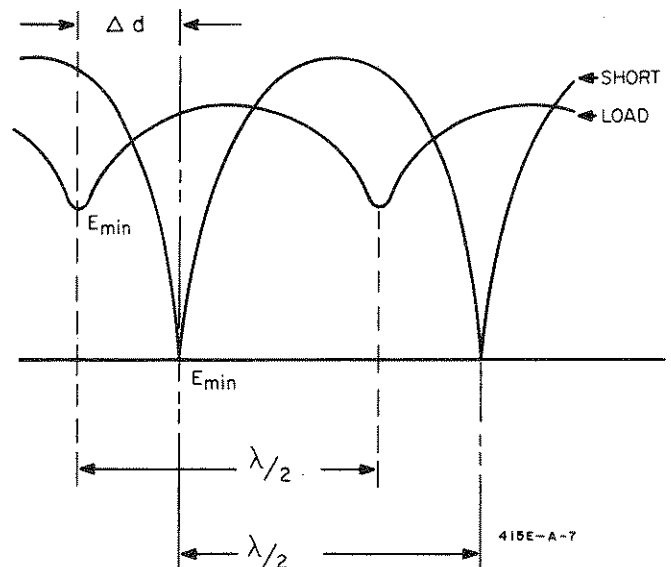

Figure 3-9. Shift of Minimum with Load and Short

and; $\pm \Delta d$ = Shift in centimeters of the minimum point when the short is used. Δd takes a positive sign (+) if the minimum shifts toward the load. Δd takes a negative sign (-) if the minimum shifts toward the generator.

$\lambda/2$ = one-half guide wavelength, i.e., the distance in centimeters between two adjacent voltage minima.

Note

The above calculations are based on the assumption that no losses occur in the transmission line. It is assumed that the characteristic line impedance, Z_0 , is resistive.

3-37. SMITH CHART EXPLANATION.

3-38. When data is obtained from a slotted line system, one of the best aids for determining impedance

is the Smith Chart. * A Smith Chart with an example (see Paragraph 3-39) is shown in Figure 3-10. The values of resistance and reactance are based on a normalized value obtained by dividing the actual value by the characteristic impedance, Z_0 , of the line. Thus if $Z = 5 + j 25$ ohms and if $Z_0 = 50$ ohms, then $Z_N = 0.1 + j 0.5$. On the Smith Chart, the circles which are tangent to the bottom of the chart are for a constant, normalized resistance; lines curving to the right from center are the normalized positive reactance components; lines curving to the left from center are the normalized negative reactance components; the straight line forming the vertical diameter is a line of zero reactance; the lower half of the zero reactance line (marked 1 through 50) also represents the standing wave ratio line.

* Smith, P. H., "Transmission-Line Calculator," Electronics, Jan. 1939, McGraw-Hill.

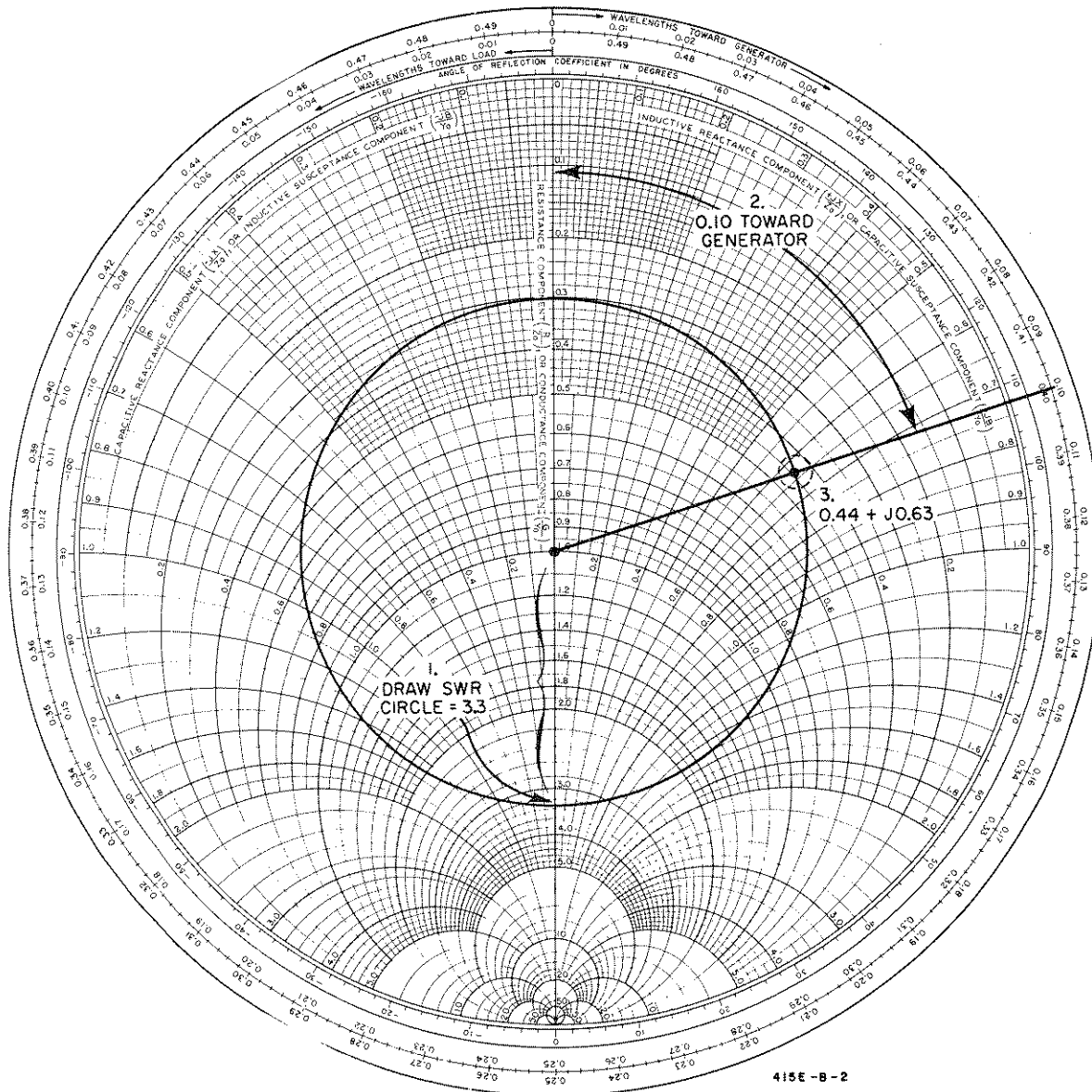

415E-B-2

Figure 3-10. Example for Use of Smith Chart

3-39. SMITH CHART CALCULATIONS.

3-40. Use of the Smith Chart for calculating impedance is outlined below. Following the generalized procedure is a numerical example. Other methods are possible for first entering the Smith Chart, but the one suggested here is practical and easy to use.

a. Determine the guide wavelength, λ_g , as explained in Paragraph 3-28.

b. Measure the swr by the method in either Paragraph 3-26 or 3-28.

c. Locate a convenient minimum with the load still in place. Record the probe carriage reading.

d. Replace load by a short, relocate the minimum and record the probe carriage reading. Determine Δd , the difference between this reading and the one from step c. Note whether the minimum was moved toward the load or toward the generator.

e. Calculate the shift of the minimum, in terms of wavelength:

$$\Delta = \frac{\Delta d}{\lambda_g}$$

f. Start at center of Smith Chart and draw a circle with a radius equal to the swr.

g. Enter the Smith Chart at the top, move in the direction of probe movement noted in step d and a distance $\Delta\lambda$, computed in step e. Use wavelength scale at the periphery of the Smith Chart.

h. Draw a line from the $\Delta\lambda$ point to the center of the chart.

i. Locate the normalized impedance as the intersection of the swr circle and the line drawn in step h.

j. The actual impedance is the product of the normalized impedance from step i and Z_0 , the line characteristic impedance.

Note

The convention of entering the chart as stated in step g applies only if the minimum is located first with the load on the line and relocated when the line is shorted. If it is necessary to first establish the shorted minimum point, the direction of $\Delta\lambda$ would be opposite to the direction of probe movement required to relocate the minimum with the load concerned.

3-41. The following example will clarify the above procedure. Figure 3-10 shows the important steps involving the Smith Chart. The assumed characteristic impedance is 50 ohms. The distance between adjacent minima is 15 cm, therefore $\lambda_g = 30$ cm. The swr is measured as 3.3. A minimum is located at 22 cm. The load is shorted and the minimum shifts to 19 cm, toward the generator.

$$\Delta d = 22 \text{ cm} - 19 \text{ cm} = 3 \text{ cm}$$

$$\Delta\lambda = \Delta d / \lambda_g = 3 \text{ cm} / 30 \text{ cm} = 0.1 \text{ wavelength}$$

3-42. The following numbered steps refer directly to Figure 3-10.

(1) A circle for swr = 3.3 is drawn.

(2) A line is drawn from the 0.1λ point (toward the generator) to the center of the chart.

(3) The normalized impedance at the intersection of the circle and the line is $0.44 + j 0.63$.

The impedance of the load (for $Z_0 = 50\Omega$) is then:

$$50 (0.44 + j 0.63) = 22 + j 31.5 \text{ ohms}$$

3-43. SPECIAL APPLICATIONS.

3-44. The Model 415E is equipped with outputs which allow applications other than as a meter indicating device for swr or attenuation.

3-45. RECORDER.

3-46. The rear panel recorder output furnishes an output from 0 to 1 volt DC with internal resistance of 1000 ohms and provides a convenient means of obtaining a permanent record of measured data. For proper operation, the recorder output ground (BNC shell) must be connected to a floating ground. Adapters are commonly available to float the ground of grounded input instruments at the power cord (see Paragraph 3-11).

3-47. AMPLIFIER OUTPUT.

3-48. The rear panel amplifier output furnishes an output from 0 to 0.8 volt RMS into 10K ohms or more. The Model 415E will supply up to 126 db of voltage gain. For proper operation, the ground terminal (black) must be connected to a floating ground (see Paragraph 3-11). With the 415E EXPAND switch set to NORM, a full scale meter reading will result in a 0.3 volt RMS output signal, and a minimum scale reading (10 db) will result in approximately 0.03 volt RMS. With the 415E EXPAND switch set to any position except NORM, a full scale meter reading results in a 0.8 volt RMS output and a minimum scale reading (2 db) results in a 0.5 volt RMS output signal. A zero input signal results in a zero volt output signal.

3-49. The Model 415E is especially useful as a tuned amplifier in a measurement setup using an Oscilloscope and a Sweep Oscillator. Sweep speeds may be increased (over the speeds using a ratio meter in a reflectometer system) and the Model 415E, used as a high gain amplifier, provides the required sensitivity.* The AMPLIFIER OUTPUT (AC) is often more useful for this purpose than the RECORDER OUTPUT (DC) since the DC output is filtered to reduce ripple and its response is too slow to make full use of maximum bandwidth.

* See hp Application Notes 54, 61, 65, and 66.

3-50. MODEL 415E NOISE FIGURE .

3-51. Figure 3-11 illustrates a typical value of Noise Figure that would be encountered in a Model 415E. The following example of Model 415E noise figure measurement is presented to illustrate the particular considerations that must be made to calculate instrument noise figure.

a. Calculate the meter indication when a 5000 ohm resistor is connected as a source, assuming the Model 415E is noiseless (0 db noise figure).

b. Any excess indication of 415E meter is then one-half of its noise figure.

c. Calculation example:

- (1) Assume 415E with controls set for the following conditions: EXTAL IMPED HIGH (input impedance 200K), 1 μ V RMS sine wave at input causes full scale deflection (0 on 0 to 10 DB scale), 130 cps bandwidth at 3 db points (1.5 db points on Model 415E meter which is calibrated for square-law. Noise equivalent bandwidth is $\pi/2$ times 3 db bandwidth).
- (2) The open-circuit noise voltage across a 5000 ohm resistor at 295° K (22° C) in a bandwidth of (130 times $\pi/2$) cps is as follows:

$$V_n = 2\sqrt{KTBR}$$

$$V_n = 2\sqrt{(1.38 \times 10^{-23})(295)(130 \times \pi/2)(5000)}$$

$$V_n = 0.129 \times 10^{-6} \text{ volts} = 0.129 \mu\text{v}$$

- (3) The 0.129 μ V open circuit voltage is reduced to 0.126 μ V by the 200K ohm input resistance of the 415E which is assumed to be noiseless.
- (4) 0.126 μ V is 18.0 db below 1 μ V but square-law calibrated meter of the 415E, set as above, would indicate 1/2 of 18 db or 9.0 db below full scale. Also, since the 415E meter is average-reading and calibrated to read RMS value of a sine wave, it reads 1.05 db below the RMS value of Gaussian noise. Therefore, the 415E reads 1/2 of 1.05 db or 0.525 db less than 9.0 and the 415E would read 9.525 db with a 5000 ohm resistor connected to the input as described. Hence, a 7.525 db (9.525 + 2) meter reading indicates a 4 db noise figure.

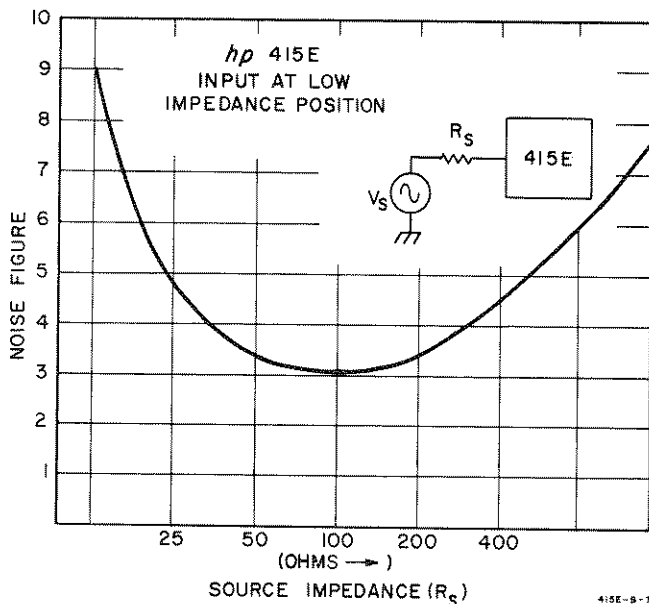
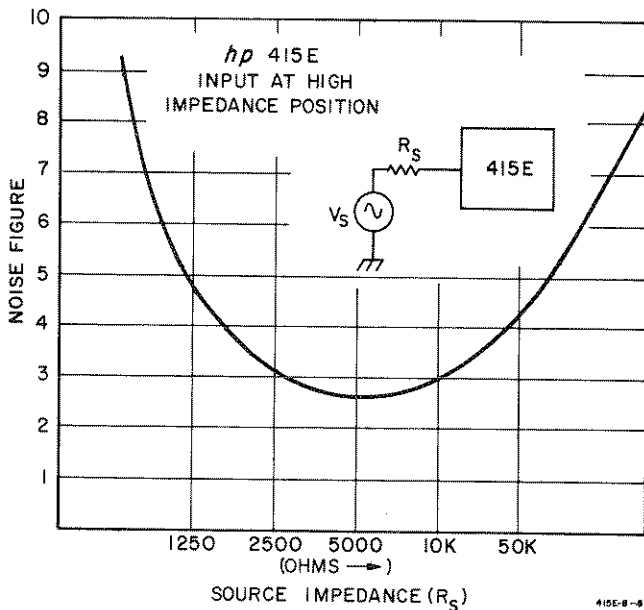

Figure 3-11. 415E Noise Figure Curves

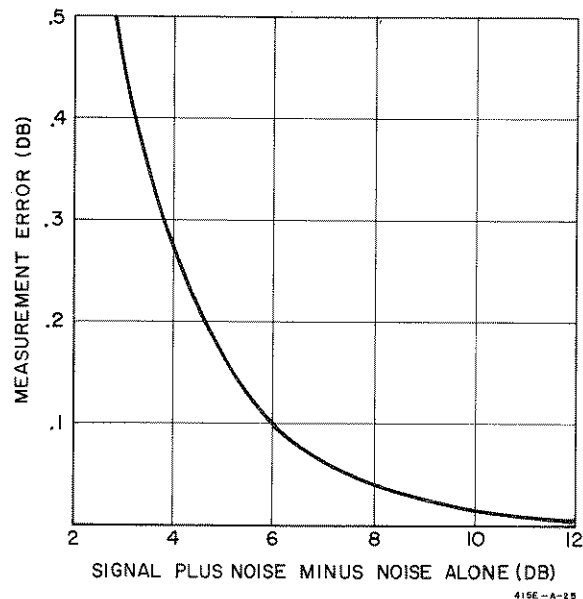

Figure 3-12. Meter Noise Correction Curve

3-52. A system error occurs when making measurements on lower 415E ranges due to noise. For convenient reference, a graph (Figure 3-12) is shown to allow correction to meter reading for any given measurement. To use this graph, make a signal measurement, then turn RF power source off or disconnect detector from RF source and note average meter reading due to noise. The difference between these two readings is used to obtain the proper correction factor from Figure 3-12. For example: if the average noise level is 9.5 db and the measured signal level is 3.5 db then the difference is 6 db. Refer to Figure 3-12, 6 db corresponds to an error of 0.1 db. This 0.1 db correction factor is always added to measured signal. Hence, $3.5 + 0.1 = 3.6$ db (corrected meter reading).

3-53. USE OF CRYSTAL DETECTORS.

3-54. The input impedance of Model 415E must always be higher than the output or source impedance of a

bolometer or crystal detector connected to the INPUT connector (see Paragraph 4-21 for discussion). For low output impedance devices, such as 100 to 200 ohm detectors, use 415E XTAL IMPED/LOW switch position. For high output impedance devices, such as hp Models 420B, 423B, 424B, or 786D, use 415E XTAL IMPED/HIGH position. If improper input impedance is selected, the crystal detector may depart from square-law for which 415E is calibrated. Paragraph 3-55 gives method of checking and calibrating a detector for square-law response.

3-55. CHECKING SQUARE-LAW RESPONSE.

3-56. Increase the power level to the crystal detector by known increments and note detector response on 415E. Note: a deviation in square-law response may be due to excessive RF power to the crystal detector (see Operating literature for specified response characteristics of crystal detector in use).

SECTION IV PRINCIPLES OF OPERATION

4-1. GENERAL.

4-2 The 415E is a high-gain tuned amplifier which takes an input from a bolometer, crystal, or any audio source, amplifies it and applies it to a meter calibrated for use with square-law detectors. With bolometer or biased crystal operation, the Model 415E supplies the appropriate bias current. Figure 4-1 is a block diagram which illustrates instrument operation. Refer also to the schematic diagrams, Figures 5-11 and 5-12 which fold out of the manual for easy reference.

4-3. INPUT CIRCUITS.

4-4. The input voltage is first routed through INPUT switch, A1S1. In the HIGH position it is applied directly to the first section of the range attenuator, A2S1. When the INPUT switch is set to any other position but HIGH, the input signal passes through transformer T1 whose turns ratio provides a 50 to 1 impedance transformation, converting a 50 to 200 ohm source to 2500 to 10,000 ohms (which is the range of best noise figure for the INPUT AMPLIFIER).

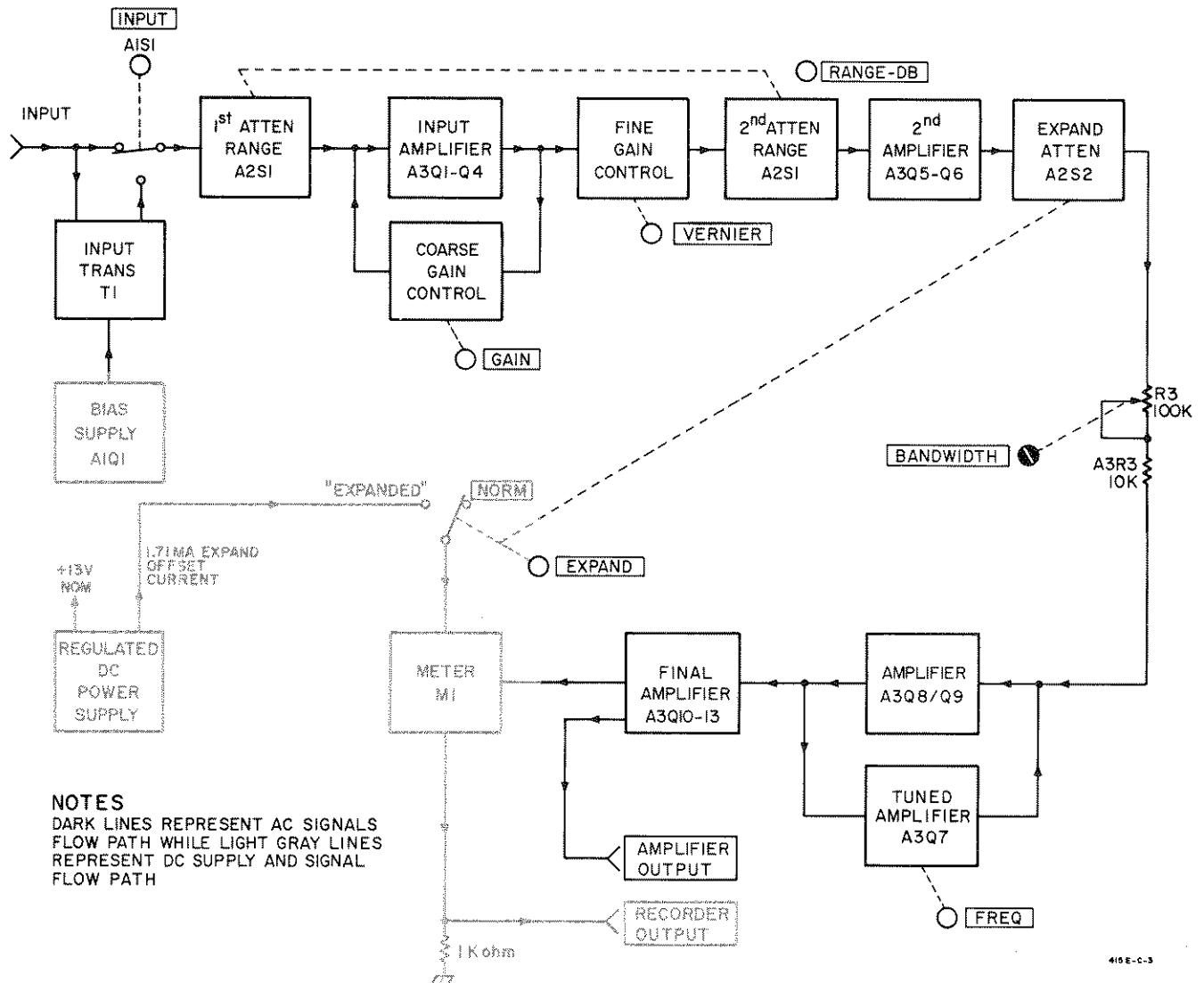

Figure 4-1. Block Diagram

4-5. RANGE ATTENUATOR.

4-6. The signal from A1S1 is fed to the first section of the RANGE-DB switch, A2S1, and then to the input amplifier. The second section of A2S1 is located between the input amplifier and the second amplifier. The RANGE-DB Switch positions are marked in 10 db steps.

4-7. INPUT AMPLIFIER.

4-8. After passing through the first section of the range attenuator, A2S1, the signal goes to the input amplifier (A3Q1/Q2/Q3/Q4) which consists of four transistors in cascade. The input signal is applied to the base of A3Q1 and the final amplifier signal is taken from the collector of A3Q4. The GAIN and VERNIER controls are associated with this amplifier and vary its gain over a range of more than 10 to 1. GAIN control R1, the coarse control, is a 250K ohm variable resistor which adjusts the amount of negative feedback from the collector of A3Q4 to the emitter of A3Q1. VERNIER control, R2, is a fine gain control and changes gain by inserting 0 to 5000 ohms in series with the output signal.

4-9. SECOND AMPLIFIER.

4-10. Transistors A3Q5 and A3Q6 amplify the signal from the second section of the range attenuator. AC feedback provides gain stability and high input impedance. The output of the amplifier is applied through the EXPAND attenuator, A2S2, to the third amplifier A3Q8 and A3Q9.

4-11. EXPAND CIRCUIT.

4-12. The function of the EXPAND switch A2S2, is to allow any signal level to be measured on an expanded scale with continuous coverage while maintaining the original reference level. Expansion is accomplished by applying a precise amount of DC-offset current from A3Q17 to the meter and simultaneously increasing the signal to the 3rd amplifier. This increased gain allows a 2 db change in signal level to deflect the meter across its full scale. The offset current places the zero signal indication off scale to the left.

4-13. FREQUENCY SELECTIVE CIRCUITS.

4-14. The frequency response of the third amplifier, A3Q8 and A3Q9, is shaped by negative feedback. The feedback path includes a Wien-bridge and amplifier A2Q7. At the null frequency of the Wien-bridge, the negative feedback path is open and the gain of the amplifier is maximum. Off center frequency the negative feedback through the Wien-bridge reduces gain. The amount of the "off resonance" gain reduction depends on the setting of the BANDWIDTH control, R3.

4-15. The Wien-bridge is adjusted for a sharp null at center frequency with BRIDGE STABILITY ADJUST A3R29. Actually, this control is set for a very slight bridge unbalance to produce just enough positive feedback so that signal current to the base of A3Q8 is supplied mainly by A3Q7. Thus, at resonance, negligible signal current flows through BANDWIDTH control, R3,

and gain is independent of its setting. Center frequency is set by varying resistors R4 and R5 (these resistors are ganged and comprise the front panel FREQ control).

4-16. FINAL AMPLIFIER.

4-17. The output amplifier consists of four transistors. The two output transistors, A3Q12 and A3Q13, operate as a push-pull class B amplifier with both collectors AC grounded. The emitters of these transistors are tied together and the AC amplifier output is taken from this point through a coupling capacitor, A3C28. Large negative feedback makes the gain of the output amplifier very nearly unity. The AC output voltage is developed across resistor A3R51: The current through A3R51 is supplied by A3Q12 and A3Q13 conducting one at a time on alternate half cycles (Class B operation) and the output signal sine wave is a composite of this half-cycle operation. In addition, the collector current of A3Q13 can drive the meter directly. No rectifier diodes are needed. This meter driving current is filtered by capacitor A3C26 and passes through the meter and a 1000 ohm resistor, R6, to develop a DC voltage for the recorder output.

4-18. GROUND LOOPS.

4-19. The grounding technique used in the 415E consists of an input connector ground, a circuit board ground, and output connector grounds. These are "floating" grounds that are tied together and isolated from chassis ground except for a 46.4 ohm resistor, R7, and a 0.05 uf capacitor, C1, connecting ground and chassis. A solid connection to chassis-or-earth ground permits troublesome ground loop currents to flow causing erroneous instrument operation. For this reason, connecting grounded instruments to the 415E output connectors can cause erroneous readings. Most recorders and oscilloscopes that might be used with the 415E outputs have differential inputs available with neither side grounded (see Paragraph 3-11).

4-20. INPUT IMPEDANCE.

4-21. The Model 415E is designed to have an input impedance much higher than that of any crystal detector or bolometer normally used with it. This results in lower noise figure and the highest possible input signal to the 415E. For example with the 415E INPUT switched to LOW, the input impedance is approximately 2000 ohms while the output or source impedance of a bolometer is approximately 200 ohms.

4-22. This high input impedance effectively nearly doubles the output voltage of a source compared with an amplifier which matches the source resistance. It should be emphasized that the transformer turns ratio in the 415E is chosen for lowest noise figure rather than to match impedances.

4-23. INPUT BIASING.

4-24. When the 415E input switch is set to one of the biased positions XTAL IMPED/BIASED, or 4.5 MA or 8.7 MA), a bias source is connected in series with INPUT connector. An emitter follower, A1Q1, in this bias circuit provides bolometer protection by limiting transients when a bolometer or crystal detector is connected or disconnected. Three calibrated levels of bias are available: 1 volt into 1000 ohms (XTAL IMPED/BIASED), or 4.5 ma and 8.7 ma into 200 ohms, selected with the INPUT switch, A1S1. These bias levels are set within a specification, $\pm 3\%$, by adjusting the DC voltage potential of the positive power supply with resistor A3R54. A single adjustment suffices since 1% resistors accurately determine the ratios between the 3 bias levels. The positive DC voltage is typically 13.2 volts DC but may be as low as +12 volts DC or as high as +14 volts DC for proper adjustment.

4-25. POWER SUPPLY.

4-26. The regulated power supplies are fed by either an internal battery, BT1 (Option 01 instruments only), or a conventional AC supply consisting of transformer T2 and rectifier diodes A3CR4 and A3CR5. The power supply must provide two regulated outputs: +13 volts and -1.71 milliamperes offset current. The voltage reference diode A3CR10 (temperature compensated by diodes A3CR7 and A3CR8) and transistor A3Q17 form a constant current source to provide the offset current. The voltage reference diode A3CR10 and transistor A3Q16 form a shunt-type regulator maintaining a nominal -7.5 volts.

4-27. In the LINE/ON position, about 3 ma "trickle charge" is supplied through A3R52 to the battery BT1 (Option 01 only). If the POWER switch is set to BATTERY/ON position, battery current passes through diode A3CR6 to the regulators. The BATTERY/CHARGE position allows recharging of the battery by placing A3R52 and A4R2 in parallel. About 20 ma to 30 ma then flows to the battery depending upon the charge condition of the battery.

SECTION V MAINTENANCE

5-1. INTRODUCTION.

5-2. This section provides instructions for performance testing, calibrating, troubleshooting, and repairing the SWR Meter.

5-3. PERFORMANCE TESTING.

5-4. **PURPOSE.** The procedures listed in Table 5-2 check 415E performance for incoming inspection, periodic evaluation, calibration, and troubleshooting. The tests can be performed without access to the instrument interior. The specifications of Table 1-1 are the performance standards.

5-5. **TEST EQUIPMENT REQUIRED.** The test instruments and accessories required to make the performance checks are listed in Table 5-1. Test instruments other than the ones listed can be used provided their performance equals or exceeds the Minimum Required Specifications.

5-6. **ISOLATING ATTENUATOR.** In order to obtain accurate results when checking the Model 415E, it is necessary to maintain some attenuation between the source and the INPUT to compensate for a source impedance different from the calibrated attenuator used. The attenuator recommended for test and adjustment and performance testing has an impedance of 50 ohms. Therefore, a 5 to 10 db, 50 ohm attenuator is suggested to be placed between the Oscillator and the attenuators used in the test setup (Table 5-2). If a separate attenuator is not used, then one of the Model 355 Attenuators may be left in the setup set to 5 or 10 db, or use an impedance matching transformer.

5-7. CALIBRATION.

5-8. GENERAL.

5-9. The following procedures outline the adjustments necessary to calibrate the Model 415E. The actual adjustments should be made only when it is determined

that the instrument is not operating properly. To determine proper performance, see Table 5-2. If the instrument fails to meet any of the given limits or indications, refer to the troubleshooting paragraph 5-35 for possible causes and corrective action. This procedure is sequential to some extent. The bias supplies should be set before any attempt to adjust the amplifier. Also check the mechanical meter adjustment before checking any indication on the Model 415E meter.

Note

To avoid errors due to possible groundloop currents isolate the Model 415E from ground used for other measuring instruments. It may be necessary to use adapters to unground all instruments except the Model 415E.

5-10. MECHANICAL METER ADJUSTMENT.

5-11. When the meter is properly set, the pointer rests over the calibration (i.e., 2 on the 0 to 2 DB scale) on the meter scale when the instrument is (1) at normal operating temperature, (2) in its normal operating position, and (3) turned off. Set the pointer as follows to obtain best accuracy and mechanical stability:

Note

If meter pointer adjustment is changed, EXPAND tracking (Paragraph 5-16) must be checked and adjusted if necessary.

- a. Turn instrument off.
- b. Rotate mechanical zero-adjustment screw clockwise until meter pointer is to left of 2 (on the 0 to 2 DB scale) and moving to the right toward 2.
- c. Continue to rotate adjustment screw clockwise; stop when the pointer is exactly on 2. If the pointer overshoots 2, repeat steps b and c.

Table 5-1. Recommended Test Equipment

Instrument Type	Minimum Required Specifications	USE/Check	Recommended Model
Audio Oscillator	Freq. Range: 400 to 2500 cps Accuracy: $\pm 3\%$ Output: 10 volts into 600 ohms Distortion: less than 1%	All Performance Tests	hp 200CD
Electronic Counter	Freq. Range: 400 to 2500 cps Accuracy: ± 1 count $\pm 0.01\%$	Frequency, and Bandwidth	hp 5512A (or 5212A)
AC Voltmeter	Voltage Range: 0.1 to 1 volt Accuracy: $\pm 1\%$ of full scale Freq. Range: 400 to 2500 cps Input Impedance: 10 megohms	Sensitivity, and Noise	hp 400H

Table 5-1 Recommended Test Equipment (Cont'd)

Instrument Type	Minimum Required Specifications	USE/Check	Recommended Model
DC Voltmeter	Voltage Range: ± 0.1 to ± 30 volts Input Impedance: 10 megohms Accuracy: $\pm 1\%$ of full scale	Sensitivity and Noise and General Purpose Circuit Voltage Checks	hp 412A (or 3440A with 3443A plug-in)
Attenuator Variable	Range: at least 130 db in 10 and 1 db steps Accuracy: Calibration must be known to ± 0.02 db for 1 db steps to ± 0.017 db for first 20 db step, ± 0.03 db for second 20 db step, and ± 0.05 db for subsequent 20 db steps.	EXPAND and RANGE attenuator accuracy	hp 355C and hp 355D, with calibration error chart
Feed-Thru Terminations	Value: 5000 ohms Accuracy: 10% (Met Film Resistor)	Noise	Shielded body: 11523-600 Resistor: hp 0683-5125
	Value: 100 ohm Accuracy: 10% (10100B)	Noise	hp 10100B
	Value: 50 ohm Accuracy: 10%	EXPAND and RANGE attenuator accuracy	hp 10100A
Oscilloscope	Vertical Sensitivity: 0.2 mv/cm up to 20 v/cm Bandwidth: Adjustable from 40 Kc to 400 Kc Sweep Time: 0.2 msec/cm to 5 msec/cm Input: AC coupled, floating-non-grounded	General Purpose check and troubleshooting	hp 140A (oscilloscope with hp 1420A (Time base plug-in) and hp 1400 A (Differential Ampl. Plug-in)
Adapters and Cables	BNC Female-to-Female Adapter (1-Required)	All Performance	hp 1250-0080-9 (UG-914/UN)
	BNC to Dual Banana Adapter Post (2-Required)	All Performance	hp 10110A
	Male-to-Male BNC 50 ohm cable (1-Required)	Bandwidth	hp 10502A
	Dual Banana-to-Dual Banana Plugs on a 50 ohm cable (1-Required)	All Performance Checks	hp 11000A
	Dual Banana-to-BNC Male (2-Required)	Performance	hp 11001A
	Straight-through Voltage Probe (Thin, flexible probe with small push button pincer jaws) Shunt capacity of 150 pf - terminated in shielded dual banana plug	General Purpose use with Oscilloscope	hp 10025A

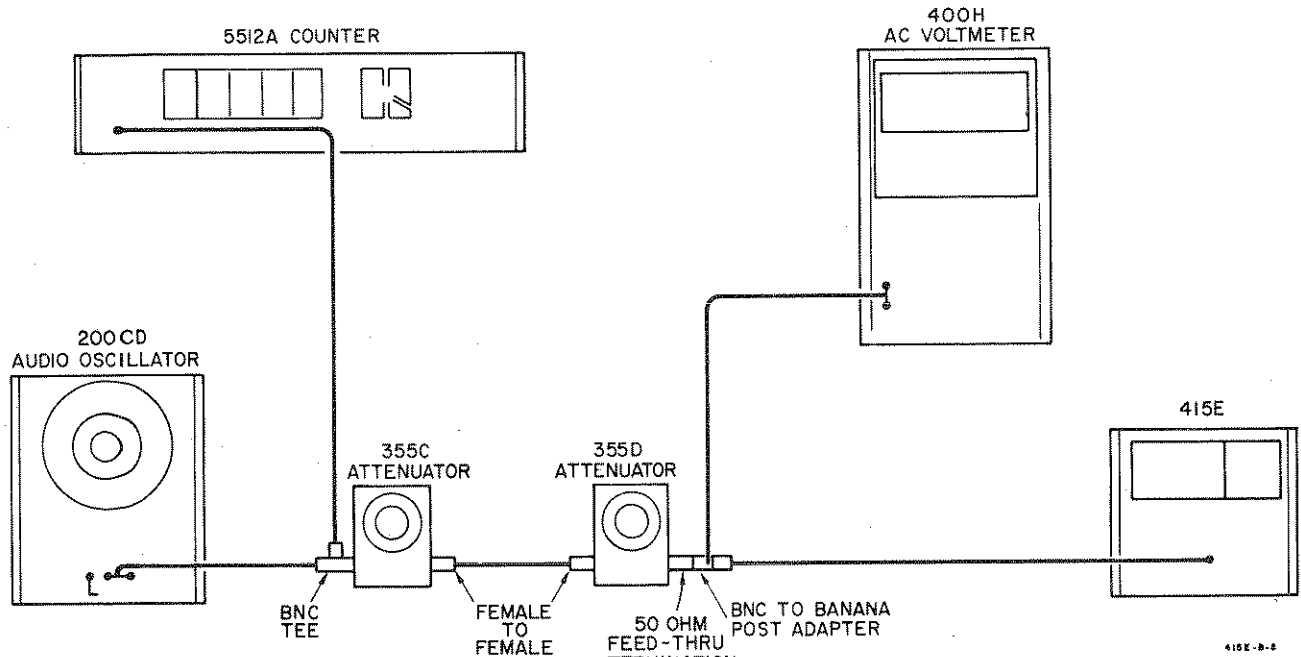

Figure 5-1. Test Set Up

Table 5-2. Performance Tests

1. SENSITIVITY: 0.15 μ v RMS at max bandwidth (1 μ v RMS on HIGH impedance crystal input).			
Procedure.	Readings		
	Min	Act	Max
a. Connect equipment as shown in Figure 5-1 (Omit 355D Attenuator)	--	0.125	0.15 v RMS
b. Set 415E to NORM, 0 db, LOW, ON, with GAIN, VERNIER, and BANDWIDTH controls full clockwise.	--	0.125	0.15 v RMS
c. Set Oscillator to 1000 cps.	--	0.94	1.0 v RMS
d. Adjust 415E FREQ to peak meter (needle to right).			
e. Adjust Oscillator output for 0 db 415E meter reading.			
f. The AC Voltmeter should read 0.15 volt RMS or less (This corresponds to a sensitivity of 0.15 μ volt RMS or greater on 60 DB range).			
g. Switch 415E INPUT to HIGH and adjust Oscillator output for 0 db 415E meter reading.			
h. The AC Voltmeter should read 1.0 volt RMS or less (This corresponds to a sensitivity of 1.0 μ volt RMS or greater on 60 DB range).			

Table 5-2. Performance Tests (Cont'd)

2. NOISE: At least 7.5 db below full scale at rated sensitivity and maximum bandwidth with input terminated in optimum source impedance

<u>Procedure.</u>	<u>Readings</u>		
	Min	Act	Max
a. Connect equipment as shown in Figure 5-1 (omit 355D from setup).	-10	(High)	-7.5 db
b. Set 415E to NORM, 0 db, HIGH, and ON with GAIN, VERNIER, FREQ, and BANDWIDTH controls full clockwise.	-9	(Low)	-7.5 db
c. Set 355C to 0 db and tune Oscillator to peak 415E.			
d. Adjust Oscillator output for 1.0 volts RMS AC Voltmeter reading.			
e. Adjust 415E GAIN for 0 db meter reading and remove connections from 415E.			
f. Connect special 5000 ohm feed-thru termination to INPUT (See Procedure 6 of this table).			
g. Set 415E RANGE-DB to 60. The average noise level indicated by meter pointer should be at least 7.5 db down from 0 on the 0 to 10 db scale.			
h. Switch INPUT to LOW and repeat steps b and c above.			
i. Adjust Oscillator output for 0.15 volt RMS AC Voltmeter reading.			
j. Adjust 415E GAIN for 0 db meter reading and remove connections to 415E.			
k. Connect Model 10100B Feed-Thru Termination to INPUT.			
m. Repeat step g above. The average noise level should be 7.5 db down from 0 on 0 to 10 db scale.			

3A. RANGE ACCURACY: ± 0.05 db/10 db step; maximum cumulative error ± 0.10 db

<u>Procedure.</u>	<u>Readings</u>		
	Min	Act	Max
a. Connect 415E as shown in Figure 5-1 (omit Counter and AC Voltmeter).	9.95 db	10.00	10.05 db
b. Set 415E to ON, LOW, 0 (RANGE-DB), 0 (EXPAND), with GAIN full counterclockwise.	19.9 db	20.01	20.1 db
c. Set 355C to 5-db and 355D to 0 and adjust Oscillator frequency for peak 415E meter reading.	29.9 db	30.01	30.1 db
d. Adjust Oscillator output and 415E VERNIER for 1 db meter reading on 0 to 2 db scale.	39.95 db	40.01	40.05 db
e. Switch 355D to 20 db and 415E RANGE-DB to 10. The 415E meter reading should be 1.0 db ± 0.05 db (See Note 1).	49.9 db	50.03	50.1 db
f. Switch 355D to 40 db and 415E to 20. 415E to 20. 415E should read 1.0 db ± 0.1 db.	59.9 db	59.94	60.1 db

Table 5-2. Performance Tests (Cont'd)

<p>g. Switch 355D to 60 db and 415E to 30. 415E should read 1.0 db ± 0.1 db.</p> <p>h. Switch 355D to 40 and set 415E GAIN control to minimum. Adjust Oscillator for 1.0 reading on 415E meter. Switch 415E to 40 db and 355D to 60. 415E should read 1.0 ± 0.05 db.</p> <p>i. Switch 355D to 80 db and 415E to 50. 415E should read 1.0 db ± 0.1 db.</p> <p>j. Switch 355D to 100 db and 415E to 60. 415E should read 1.0 db ± 0.1 db.</p>																																						
<p>3B. EXPANDED RANGE ACCURACY:</p> <p>Maximum cumulative error between any two 2 db steps: ± 0.05 db Accuracy on any 0 to 2 db scale: ± 0.02 db</p>																																						
<p><u>Procedure.</u></p> <p>a. Set 415E as in steps a and b of procedure 3A above.</p> <p>b. Set 355D to 10 db and 355C to 0 db. (See Note 1)</p> <p>c. Adjust Oscillator output and 415E VERNIER for 0 db meter reading on 0 to 2 db scale.</p> <p>d. Switch 355C from 0 to 4 db in 1-db steps. The Model 415E meter reading should be as given below:</p> <table border="1" style="width: 100%; border-collapse: collapse;"> <thead> <tr> <th style="text-align: left;">Model 355C</th> <th style="text-align: left;">Model 415E</th> </tr> </thead> <tbody> <tr> <td>1 db</td> <td>0.5 ± 0.02 db</td> </tr> <tr> <td>2 db</td> <td>1.0 ± 0.02 db</td> </tr> <tr> <td>3 db</td> <td>1.5 ± 0.02 db</td> </tr> <tr> <td>4 db</td> <td>2.0 ± 0.02 db</td> </tr> </tbody> </table> <p>e. Change 355C to 0, adjust 200CD for 415E reading of 1.0 on 0 to 2 db scale. Change expand to 2 and 355C to 4. The Model 415E should indicate 1 db ± 0.05 db on 0 to 2 db scale.</p> <p>f. Change 355C to 8 db and EXPAND to 4. The 415E should read 1 db ± 0.05 db.</p> <p>g. Switch 355D to 20 db and 355C to 2 db and EXPAND to 6. The 415E should read 1 db ± 0.05 db.</p> <p>h. Switch 355C to 6 db and EXPAND to 8. The 415E should read 1 db ± 0.05 db.</p>	Model 355C	Model 415E	1 db	0.5 ± 0.02 db	2 db	1.0 ± 0.02 db	3 db	1.5 ± 0.02 db	4 db	2.0 ± 0.02 db	<p><u>Readings</u></p> <table border="1" style="width: 100%; border-collapse: collapse;"> <thead> <tr> <th style="text-align: left;">Min</th> <th style="text-align: center;">Act</th> <th style="text-align: right;">Max</th> </tr> </thead> <tbody> <tr> <td>0.48 db</td> <td style="text-align: center;">0.51</td> <td style="text-align: right;">0.52 db</td> </tr> <tr> <td>0.98 db</td> <td style="text-align: center;">1.01</td> <td style="text-align: right;">1.02 db</td> </tr> <tr> <td>1.48 db</td> <td style="text-align: center;">1.51</td> <td style="text-align: right;">1.52 db</td> </tr> <tr> <td>1.98 db</td> <td style="text-align: center;">2.00</td> <td style="text-align: right;">2.02 db</td> </tr> <tr> <td>1.95 db</td> <td style="text-align: center;">1.99</td> <td style="text-align: right;">2.05 db</td> </tr> <tr> <td>3.95 db</td> <td style="text-align: center;">3.99</td> <td style="text-align: right;">4.05 db</td> </tr> <tr> <td>5.95 db</td> <td style="text-align: center;">5.98</td> <td style="text-align: right;">6.05 db</td> </tr> <tr> <td>7.95 db</td> <td style="text-align: center;">7.98</td> <td style="text-align: right;">8.05 db</td> </tr> </tbody> </table>	Min	Act	Max	0.48 db	0.51	0.52 db	0.98 db	1.01	1.02 db	1.48 db	1.51	1.52 db	1.98 db	2.00	2.02 db	1.95 db	1.99	2.05 db	3.95 db	3.99	4.05 db	5.95 db	5.98	6.05 db	7.95 db	7.98	8.05 db
Model 355C	Model 415E																																					
1 db	0.5 ± 0.02 db																																					
2 db	1.0 ± 0.02 db																																					
3 db	1.5 ± 0.02 db																																					
4 db	2.0 ± 0.02 db																																					
Min	Act	Max																																				
0.48 db	0.51	0.52 db																																				
0.98 db	1.01	1.02 db																																				
1.48 db	1.51	1.52 db																																				
1.98 db	2.00	2.02 db																																				
1.95 db	1.99	2.05 db																																				
3.95 db	3.99	4.05 db																																				
5.95 db	5.98	6.05 db																																				
7.95 db	7.98	8.05 db																																				
<p>4. INPUT FREQUENCY: 1000 cps, adjustable 7% (± 35 cps).</p>																																						
<p><u>Procedure.</u></p> <p>a. Connect equipment as shown in Figure 5-1 (omit 355D and AC Voltmeter from setup).</p> <p>b. Set 355C to 10 db.</p> <p>c. Set 415E to LOW, ON, 0 (EXPAND), with GAIN, FREQ, and VERNIER full clockwise.</p> <p>d. Tune Oscillator to peak 415E (meter needle to right). Record Counter reading.</p> <p>e. Turn FREQ full counterclockwise.</p> <p>f. Tune Oscillator to peak 415E. Record Counter reading. The difference between the recorder frequency readings of steps d and f must be at least 70 cps with 1000 cps between the two frequencies.</p>	<p><u>Readings</u></p> <table border="1" style="width: 100%; border-collapse: collapse;"> <thead> <tr> <th style="text-align: left;">Min</th> <th style="text-align: center;">Act</th> <th style="text-align: right;">Max</th> </tr> </thead> <tbody> <tr> <td>1020 cps</td> <td style="text-align: center;">1036</td> <td style="text-align: right;">--</td> </tr> <tr> <td>--</td> <td style="text-align: center;">960</td> <td style="text-align: right;">980 cps</td> </tr> <tr> <td style="text-align: center;">Act</td> <td style="text-align: center;">Act</td> <td style="text-align: right;">Diff</td> </tr> <tr> <td style="text-align: center;">-</td> <td style="text-align: center;">=</td> <td style="text-align: right;">76</td> </tr> </tbody> </table> <div style="border: 1px solid black; padding: 5px; width: fit-content; margin: 10px auto;"> <p>Difference = > 70 cps</p> </div>	Min	Act	Max	1020 cps	1036	--	--	960	980 cps	Act	Act	Diff	-	=	76																						
Min	Act	Max																																				
1020 cps	1036	--																																				
--	960	980 cps																																				
Act	Act	Diff																																				
-	=	76																																				

Table 5-2. Performance Tests (Cont'd)

<p>5. BANDWIDTH: Variable 15 to 130 cps.</p>	
<p><u>Procedure.</u></p> <p>a. Connect equipment as shown in Figure 5-1 (omit 355D and AC Voltmeter).</p> <p>b. Set 415E to LOW, ON, NORM, 0 (RANGE-DB), with GAIN and VERNIER full clockwise.</p> <p>c. Turn BANDWIDTH full counterclockwise.</p> <p>d. Tune Oscillator to peak 415E.</p> <p>e. Switch 415E EXPAND to 0 and retune Oscillator to be sure that 415E is peaked at center frequency.</p> <p>f. Adjust GAIN control for a 0 db meter reading.</p> <p>g. Tune Oscillator slightly off tuned frequency causing meter reading to drop to exactly 1.5 db and record Counter reading.</p> <p>h. Tune Oscillator back to tuned frequency and then off to other side of tuned frequency causing meter reading to drop to exactly 1.5 db. Record Counter reading.</p> <p>i. The difference between the readings of steps g and h should be 15 cps or less.</p> <p>j. Turn BANDWIDTH full clockwise and retune OSCILLATOR for peak 415E meter reading.</p> <p>k. Repeat steps f, g, h above.</p> <p>m. The difference between the recorded frequency readings, this time, should be 130 cps or greater.</p>	<p><u>Readings</u></p> <p>Act - Act = Difference (< 15 cps)</p> <p>966 953 = 13</p> <p>Act - Act = Difference (> 130 cps)</p> <p>1028 896 = 132</p>
<p>6. SPECIAL 5000 OHM FEED-THRU TERMINATION</p> <p>In order to measure the 415E operating noise level, a special load must be used to terminate the INPUT in its optimum source impedance. For the LOW impedance INPUT, the hp Model 10100B (100 ohms) should be used. For the HIGH impedance INPUT, a special 5000 ohm termination must be built as detailed below (See Table 5-1 for part stock numbers).</p>	
<p><u>Procedure</u></p> <p>a. Refer to cut away view to left. Unscrew male BNC and lockwasher from housing by using a 3/8-inch open-end wrench and holding housing either in a vise or with gas pliers.</p> <p style="text-align: center;">Note</p> <p>If gas pliers are used housing should be protected with tape or heavy paper.</p> <p>b. Solder 5000 ohm $\pm 10\%$ 1/4 W resistor to BNC.</p>	<p style="text-align: center;">* RESISTOR VALUE: 50, 100, OR 5K OHM AS REQUIRED</p> <p style="text-align: center;">NOTE: ENTIRE ASSEMBLY MINUS RESISTOR IS AVAILABLE AS 11523-600.</p> <p style="text-align: right; font-size: small;">415E-A-23</p>

b. If the meter tracking error is greater than ± 0.02 db, adjust A3R57 (See Figure 5-10) and repeat measurement until meter tracking error is less than ± 0.02 db.

5-18. REPAIR AND REPLACEMENT.

5-19. Certain procedures and precautions must be followed when repairing or replacing any component of the Model 415E. Most of the amplifier and power supply circuit components are located on the etched circuit board. Instructions for working on the etched circuit board are summarized in Paragraph 5-20. Always disconnect the AC or battery power before replacing or soldering any parts. Instruction for removal and replacement of switches is detailed in Paragraph 5-27.

5-20. ETCHED CIRCUITS.

5-21. The etched circuit board in the SWR Meter is of the plated-through type consisting of metallic conductors bonded to both sides of insulating material. Soldering can be done from either side of the board with equally good results. Table 5-3 lists required tools and materials. Following are recommendations and precautions pertinent to etched circuit repair work.

a. Avoid unnecessary component substitution; it can result in damage to the circuit board and/or adjacent components.

b. Do not use a high-power soldering iron on etched circuit boards. Excessive heat may lift a conductor or damage the board.

c. Use a suction device (Table 5-3) or wooden toothpick to remove solder from component mounting holes. DO NOT USE A SHARP METAL OBJECT SUCH AS AN AWL OR TWIST DRILL FOR THIS PURPOSE. SHARP OBJECTS MAY DAMAGE THE PLATED-THROUGH CONDUCTOR.

d. After soldering, remove excess flux from the soldered area and apply a protective coating to prevent contamination and corrosion. See Table 5-3 for recommendations.

5-22. COMPONENT REPLACEMENT.

a. Remove defective component from circuit board.

b. Remove solder from mounting holes using a suction desoldering aid (Table 5-3) or wooden toothpick.

c. Shape leads of replacement component to match mounting hole spacing.

d. Insert component leads into mounting holes and position component as original was positioned. DO NOT FORCE LEADS OF REPLACEMENT COMPONENT INTO MOUNTING HOLES. Sharp lead ends may damage plated-through conductor.

Note: Axial lead components, such as resistors and tubular capacitors, can be replaced without unsoldering. Clip leads near body of defective component, remove component and straighten leads left in board. Wrap leads of replacement component one turn around original leads. Solder wrapped connection, and clip off excess lead.

Table 5-3. Etched Circuit Soldering Equipment

Item	Use	Specification	Item Recommended
Soldering Tool	Soldering Unsoldering	Wattage rating: 37.5 Tip Temp: 750 - 800°F Tip Size: 1/8" OD	Ungar #776 Handle with Ungar #1237 Heating Unit
Soldering Tip, general purpose	Soldering Unsoldering	Shape: chisel Size: 1/8"	Ungar #PL113
De-soldering aid	Unsoldering multi- connection components (e.g., tube sockets)	Suction device to remove molten solder from connection	Soldapullt by the Edsyn Company, Arleta, California
Resin (flux) solvent	Remove excess flux from soldered area before application of protective coating	Must not dissolve etched circuit base board ma- terial or conductor bonding agent	Freon Acetone Lacquer Thinner Isopropyl Alcohol (100% dry)
Solder	Component replacement Circuit board repair Wiring	Resin (flux) core, high tin content (60/40 tin/ lead), 18 gauge (SWG) preferred	
Protective Coating	Contamination, corrosion protection after soldering	Good electrical insula- tion, corrosion- prevention properties	Krylon* #1302 Humiseal Protective Coating, Type 1B12 by Columbia Technical Corp. Woodside 77, New York
*Krylon Inc., Norristown, Pennsylvania			

Table 5-2. Performance Tests (Cont'd)

<p>c. Let resistor cool, then check resistance from male BNC pin through resistor; resistance measured should be $\pm 10\%$ that indicated by the coding.</p> <p>d. Replace lockwasher and male BNC.</p> <p>e. Check resistance from male-to-female BNC center conductor; resistance should be 0 or a few tenths of an ohm.</p>	
<p>Note</p> <p>1. The Attenuators used for checking 415E RANGE and EXPAND attenuators must be calibrated and an error chart used. Calibration requirements are given in Table 5-1.</p>	

d. When the pointer is exactly on 2, rotate the adjustment screw approximately 15 degrees counterclockwise. This is enough to free the adjustment screw from the meter suspension. If the pointer moves during this step, repeat steps b through d.

Note

For all DC voltage measurements, Voltmeter common lead should be connected to black terminal of rear panel AMPLIFIER OUTPUT connector. This is instrument ground.

5-12. BIAS/POWER SUPPLY ADJUST.

5-13. This adjustment sets the bias supply current and voltage levels which are supplied to the INPUT connector for use with bolometers or biased crystal detectors. This adjustment is accomplished by adjusting the potential of the positive DC power supply to an optimum value. The positive DC power supply is typically set to +12 volts or as high as +14 volts DC.

- a. Remove top and left side covers.
- b. Connect a dual banana plug-to-male BNC connector. Connect a 200 ohm resistor between terminals of dual banana plug.
- c. Connect a DC Voltmeter across the 200 ohm resistor.
- d. Turn 415E on and set INPUT switch to BOLOMETER/8.7 MA. The DC Voltmeter reading should be between 1.80 and 1.68 volts DC. If necessary, adjustment is made with variable resistor A3R54 (see Figure 5-10).
- e. Switch 415E INPUT switch to BOLOMETER/4.5 MA. The DC Voltmeter should read between 0.93 and 0.87 volts DC. If necessary, adjustment is made with A3R54.
- f. Remove 200 ohm resistor from adapter and replace with a 1000 ohm 1% resistor. Switch INPUT switch to XTAL IMPED/BIASED. The DC Voltmeter should read between 1.03 and 0.97 volts DC. If necessary, adjustment is made with A3R54.
- g. Since one adjustment sets the bias level for all three of the bias supplies, measurement steps d, e, and f must be repeated after any adjustment is made.
- h. Remove DC Voltmeter leads from 415E INPUT connector and measure DC potential at BATT+ terminal of 415E circuit board assembly (circuit board socket and terminals are located beneath instrument top cover). DC potential should be between +12 and +14 volts (typically +13.2 volts DC).

5-14. STABILITY ADJUST.

5-15. This adjustment sets the 415E so that a change in operating bandwidth will not affect any meter reading by more than 0.5 db.

- a. Turn 415E on and set as follows:

INPUT HIGH
 RANGE-DB 0 DB
 EXPAND NORM
 GAIN full CW
 BANDWIDTH full CW
 FREQ approximately centered

b. Connect an Audio Oscillator to the INPUT of 415E and adjust the output frequency and amplitude for a near full scale reading.

c. Adjust 415E FREQ control to be sure that instrument is tuned to center frequency of input signal (maximum meter pointer deflection toward right side of instrument).

d. Switch EXPAND switch to 0 and using the GAIN control, set a reference of 1 on the 0 to 2 DB scale.

e. Turn the BANDWIDTH from fully clockwise to fully counterclockwise and retune. The meter reading change should not be more than 0.5 db.

f. If the change in meter reading is greater than 0.5 db, adjust A3R29 (See Figure 5-10) and repeat step e until the meter reading change is less than 0.5 db.

5-16. EXPAND-NORMAL ADJUST.

5-17. The meter, M1, requires a special "offset-current" supply when using an EXPAND switch setting other than NORM. This current supply provides the zero reference signal to the meter and is adjusted as follows:

- a. Perform steps a through d of Procedure 3B in Table 5-2.

5-33. MAINTENANCE OF OPTIONS 01 AND 02.

5-34. Operating instructions for Model 415E instruments with Option 01 (internally installed battery) and/or Option 02 (rear panel input connector) is found in section III. Paragraphs 1-6 explain what is covered by these two options. Installation and removal instructions are given in the appendix at the rear of this manual.

5-35. TROUBLESHOOTING.

5-36. LOCATING TROUBLE.

5-37. Always start locating trouble with a thorough visual inspection for burned-out or loose components, loose connections, or any conditions which suggest a source of trouble. Check the fuse to see that it is not open.

5-38. If trouble cannot be isolated to a bad component by visual inspection, the trouble should be isolated to a circuit section. Isolation to a circuit section can be accomplished by using the waveforms (Figures 5-5 through 5-8) and using the front panel performance tests (Table 5-2).

5-39. POWER SUPPLY TROUBLE.

5-40. Correct operation of the power supply is vital to proper operation of the SWR Meter. Noise or variation in the regulated voltages causes erratic instru-

ment operation. Noise or variation in the offset current supply causes erratic operation when the 415E is used for expanded operation (i.e., EXPAND control set to any position other than NORM). Refer to Paragraph 4-25 for a discussion of power supply operation.

5-41. COMPONENT TROUBLE ISOLATION.

5-42. The following procedures and data are given to aid in determining whether a transistor is operational. Tests are given for both in-circuit and out-of-circuit transistors and should be useful in determining whether a particular section trouble is due to a faulty transistor or an associated component.

5-43. IN-CIRCUIT TESTING.

5-44. The common causes of transistor failures are internal short- and open-circuits. In transistor circuit testing the most important consideration is the transistor base - emitter junction. Like the control grid of a vacuum tube, this is the operational control point in the transistor. This junction is essentially a solid-state diode. For the transistor to conduct, the diode must conduct; that is, the diode must be forward biased. As with simple diodes, the forward-bias polarity is determined by the materials forming the junc-

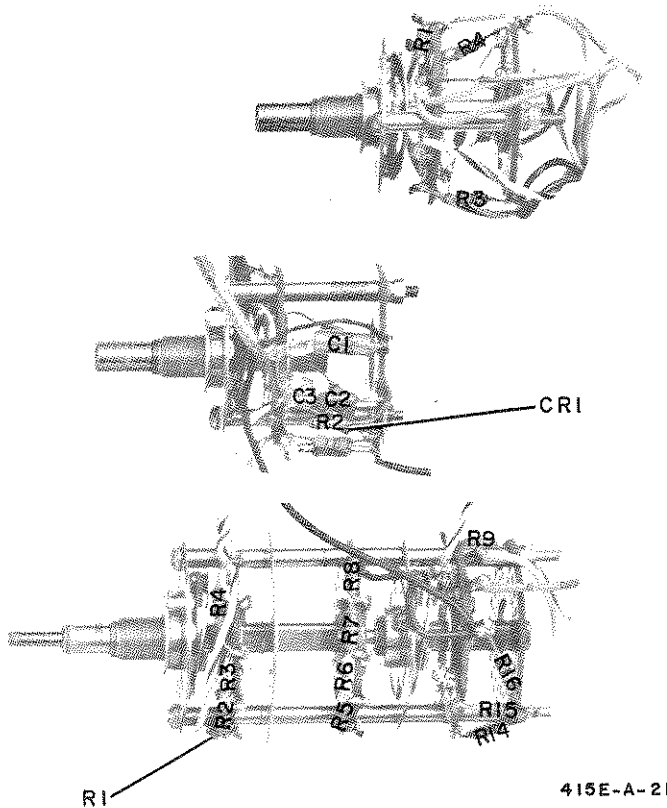

Figure 5-3A. Switch Component Location

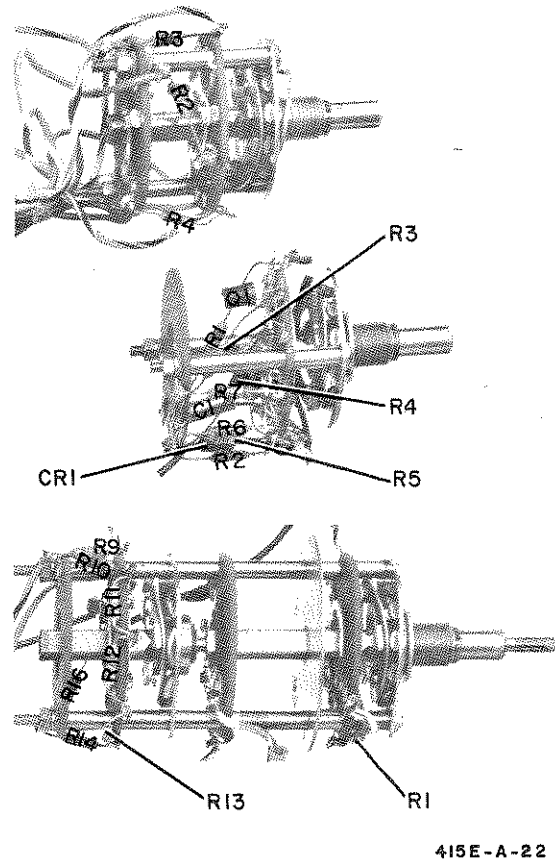

Figure 5-3B. Switch Component Location

5-23. **ETCHED CONDUCTOR REPAIR.** A broken or burned section of conductor can be repaired by bridging the damaged section with a length of tinned copper wire. Allow adequate overlap and remove any varnish from etched conductor before soldering wire into place.

5-24. TRANSISTOR REPLACEMENT.

a. Do not apply excessive heat. See Table 5-3 for soldering tool specifications.

b. Use a heat sink such as pliers or hemostat between transistor body and hot soldering iron.

c. When installing a replacement transistor, ensure sufficient lead length to dissipate heat of soldering by maintaining about the same length of exposed lead as used for original transistor.

5-25. DIODE REPLACEMENT.

5-26. Solid state diodes are in many physical forms. This sometimes results in confusion as to which lead or connection is for the cathode (negative) or anode (positive), since not all diodes are marked with the standard symbols. Figure 5-2 shows examples of some diode marking methods. If doubt exists as to polarity, an ohmmeter may be used to determine the proper connection. It is necessary to know the polarity of the ohms lead with respect to the common lead for the ohmmeter used. (For the hp Model 410B Vacuum Tube Voltmeter, the ohms lead is negative with respect to the common; for the hp Model 412A DC Vacuum Tube Voltmeter, the ohms lead is positive with respect to the common.) When the ohmmeter indicates the least diode resistance, the cathode of the diode is connected to the ohmmeter lead which is negative with respect to the other lead.

Note: Replacement instructions are the same as those listed for transistor replacement.

5-27. SWITCH REPAIR OR REPLACEMENT.

5-28. The EXPAND and RANGE switches are on the same assembly, as are the GAIN and VERNIER controls. These assemblies, along with the POWER switch and the INPUT switch, may be removed by first taking off all instrument covers and using the applicable instructions which follow.

Note: For general soldering instructions, refer to Paragraph 5-24 and 5-25.

5-29. **GAIN/VERNIER.** Refer to Figure 5-3 and the schematic diagrams for component identification and location.

a. Loosen setscrews in knobs and remove from shaft.

b. Loosen and remove shaft nut from front panel.

c. Pull assembly back and out of instrument removing lock washer and grounding lug from shaft. Also remove white GAIN/VERNIER instruction plate from front panel.

d. Unsolder connecting wires. Mark each to indicate which lugs to resolder wires to.

e. Replacement is reverse of removal.

5-30. **RANGE-DB/EXPAND.** Refer to Figure 5-3 and the schematic diagram for component identification and location.

a. Loosen setscrews in knobs and remove from shaft.

b. Loosen and remove shaft nut from front panel.

c. Loosen the BANDWIDTH potentiometer to allow the switch assembly to be pulled free of the front panel.

d. Unsolder connecting wires. Mark each to indicate which lugs to resolder wires to.

e. Replacement is reverse of removal.

5-31. **INPUT.** Refer to Figure 5-3 and the schematic diagrams for component identification and location.

a. Loosen setscrews in knob and remove from shaft.

b. Loosen and remove shaft nut from front panel.

c. Pull switch assembly free from front panel and unsolder connecting wires. Mark each to indicate which lugs to resolder wires to.

d. Replacement is reverse of removal.

5-32. **POWER.** Refer to Figure 5-3 and the schematic diagrams for component identification and location.

a. Loosen the two nuts holding circuit board in place and remove circuit board from instrument.

b. Loosen setscrews in knob and remove from shaft.

c. Loosen and remove shaft nut from front panel.

d. Pull switch assembly free from front panel and unsolder connecting wires. Mark each to indicate which lugs to resolder wires to.

e. Replacement is reverse of removal.

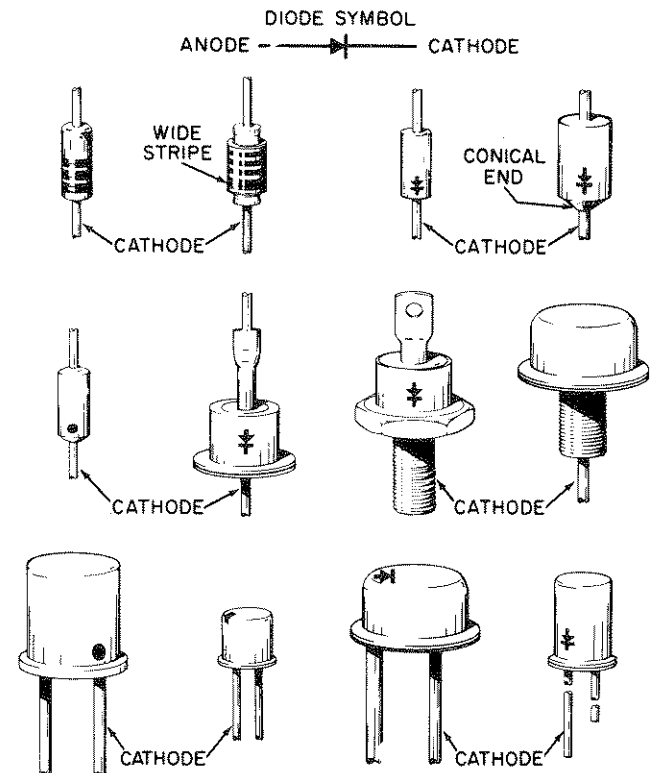

Figure 5-2. Examples of Diode Marking Methods

415E-A-16

tion. Use the transistor symbol on the schematic diagram to determine the bias polarity required to forward-bias the base-emitter junction. The A part of Figure 5-4 shows transistor symbols with terminals labeled. Notice that the emitter arrow points toward the type N material. The other two columns of the illustration compare the biasing required to cause conduction and cut-off in transistors and vacuum tubes. If the transistor base-emitter diode (junction) is forward-biased the transistor conducts. If the diode is heavily forward-biased, the transistor saturates. However, if the base-emitter diode is reverse-biased the transistor is cut off (open). The voltage drop across a forward-biased emitter-base diode varies with transistor collector current. For example, a germanium transistor has a typical forward-bias, base-emitter voltage of 0.2-0.3 volts when collector current is 1-10 ma, and 0.4-0.5 volts when collector current is 10-100 ma. In contrast, forward-bias voltage for silicon transistors is about twice that for germanium types: about 0.5-0.6 volts when collector current is low, and about 0.8-0.9 volts when collector current is high.

5-45. Figure 5-4, part B, shows simplified versions of the three basic transistor circuits and gives the operating characteristics of each. When examining a transistor stage, first determine if the emitter-base diode is biased for conduction (forward-biased) by measuring the voltage difference between emitter and base. When using an electronic voltmeter, do not measure directly between emitter and base: there may be sufficient loop current between the voltmeter leads

to damage the transistor. Instead, measure each voltage separately with respect to a voltage commonpoint (e.g., chassis). If the emitter-base diode is forward-biased, check for amplifier action by short-circuiting base to emitter while observing collector voltage. The short circuit eliminates base-emitter bias and should cause the transistor to stop conducting (cut off). Collector voltage should then shift to near the supply voltage. Any difference is due to leakage current through the transistor and, in general, the smaller this current, the better the transistor. If collector voltage does not change the transistor has either an emitter-collector short circuit or emitter-base open circuit.

5-46. OUT-OF-CIRCUIT TESTING.

5-47. The two common causes of transistor failure are internal short- and open-circuits. Remove the transistor from the circuit and use an ohmmeter to measure internal resistance. See Table 5-4 for measurement data.

CAUTION

Most ohmmeters can supply enough current or voltage to damage a transistor. Before using an ohmmeter to measure transistor forward or reverse resistance, check its open-circuit voltage and short-circuit current output **ON THE RANGE TO BE USED**. Open-circuit voltage must not exceed 1.5 volts and short-circuit current must be less than 3 ma. See Table 5-5 for safe resistance ranges for some common ohmmeters.

Table 5-4. Out-of-Circuit Transistor Resistance Measurements

Transistor Type		Connect Ohmmeter		Measure Resistance (ohms)
		Pos. lead to	Neg. lead to	
PNP Germanium	Small Signal	emitter	base*	200-250
		emitter	collector	10K-100K
	Power	emitter	base*	30-50
		emitter	collector	several hundred
NPN Silicon	Small Signal	base	emitter	1K-3K
		collector	emitter	very high (might read open)
	Power	base	emitter	200-1000
		collector	emitter	high, often greater than 1M
*To test for transistor action, add collector-base short. Measured resistance should decrease.				

Table 5-5. Ohmmeter Ranges for Transistor Resistance Measurements

Ohmmeter	Safe Range(s)	Open Ckt Voltage	Short Ckt Current	Lead	
				Color	Polarity
hp 412A	R x 1K	1.0V	1 ma	Red Black	+ -
hp 427A	R x 10K	1.0V	100µa		
	R x 100K	1.0V	10µa		
	R x 1M	1.0V	1µa		
hp 410C	R x 10M	1.0V	0.1µa	Red Black	+ -
	R x 1K	1.3V	0.57 ma		
	R x 10K	1.3V	57µa		
	R x 100K	1.3V	5.7µa		
	R x 1M	1.3V	0.5µa		
hp 410B	R x 10M	1.3V	0.05µa	Black Red	+ -
	R x 100	1.1V	1.1 ma		
	R x 1K	1.1V	110µa		
	R x 10K	1.1V	11µa		
	R x 100K	1.1V	1.1µa		
Simpson 260	R x 1M	1.1V	0.11µa	Red Black	+ -
	R x 100	1.5V	1 ma		
Simpson 269	R x 1K	1.5V	0.82 ma	Black Red	+ -
Triplet 630	R x 100	1.5V	3.25 ma	Varies with Serial Number	
	R x 1K	1.5V	325µa		
Triplet 310	R x 10	1.5V	750µa		
	R x 100	1.5V	75µa		

A. TRANSISTOR BIASING			
DEVICE	SYMBOL	CUTOFF	CONDUCTING
VACUUM TUBE			
N P N TRANSISTOR			
P N P TRANSISTOR			

B. AMPLIFIER CHARACTERISTICS			
CHARACTERISTIC	COMMON BASE	COMMON EMITTER	COMMON COLLECTOR
INPUT Z	30-50 Ω	500-1500 Ω	20-500K Ω
OUTPUT Z	300-500K Ω	30-50K Ω	50-1000 Ω
VOLTAGE GAIN	500-1500	300-1000	<1
CURRENT GAIN	<1	25-50	25-50
POWER GAIN	20-30 db	25-40 db	10-20 db

Figure 5-4. Transistor Biasing and Operating Characteristics

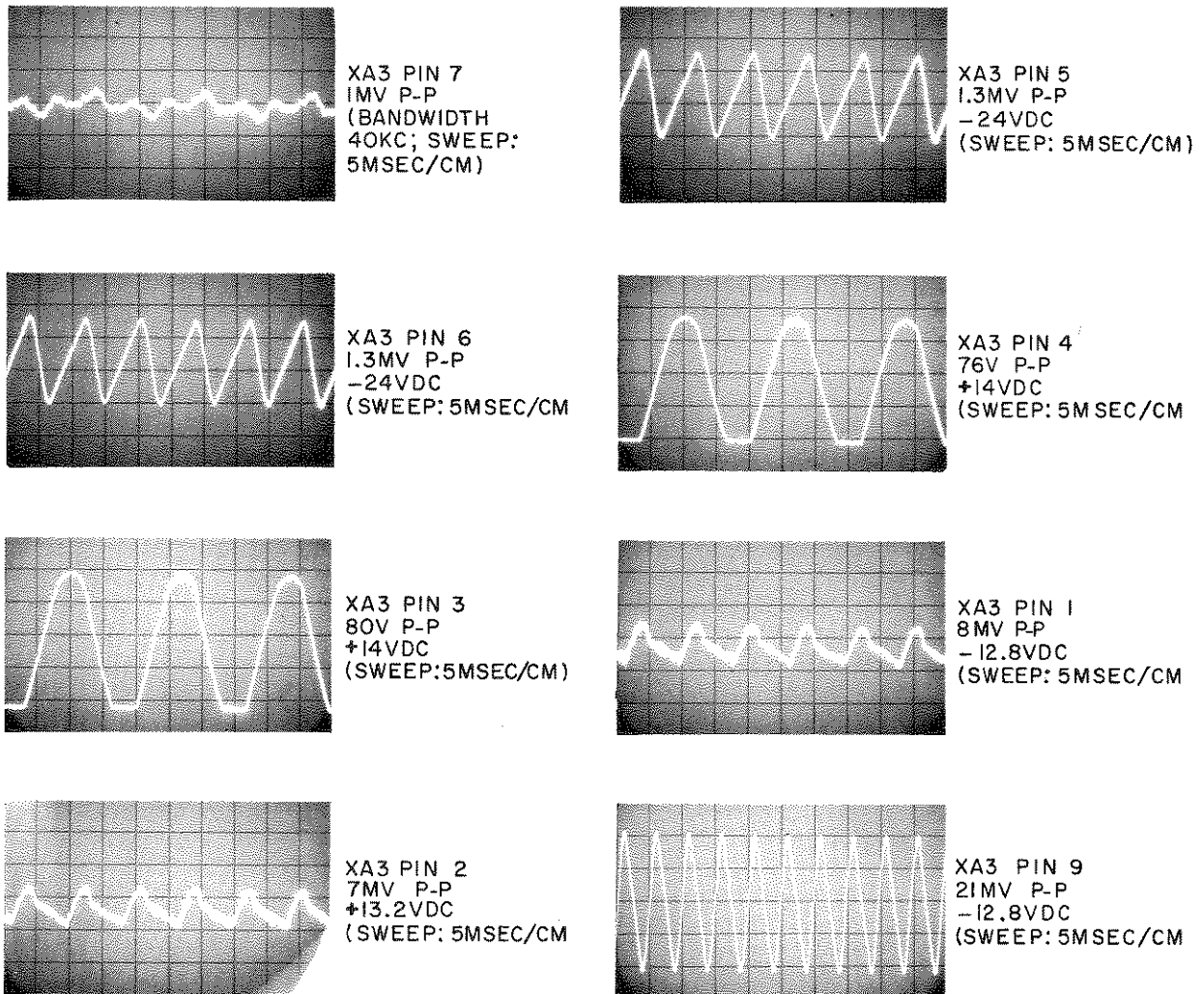

415E-A-13

MEASUREMENT CONDITIONS (unless otherwise noted).*

- a. Model 415E set to HIGH, NORM, RANGE 0, BANDWIDTH cw, FREQ centered, GAIN & VERNIER ccw, LINE/ON.
- b. MODEL 140A with 1420A & 1400A set to 0.2 msec/cm, AC, 400 kc, and appropriate vertical sensitivity.
- c. Model 200CE Oscillator set to about 1000 cps, and for 0 db Model 415E meter reference.
- d. Model 412A DC Voltmeter set to appropriate range.

*All measurements made with respect to 415E common (black terminal rear panel AMPLIFIER OUTPUT connector).

Figure 5-5. Power Supply Waveforms (AC OPERATION - ONLY)

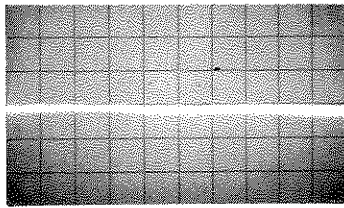

XA3 PIN 7
0.4MV P-P
(BANDWIDTH:40KC)

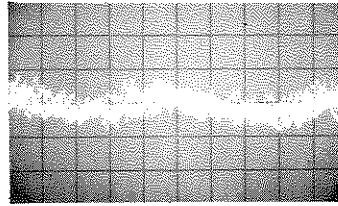

XA3 PIN 5
0.8MV P-P
(-13VDC)
(BANDWIDTH: 40KC)

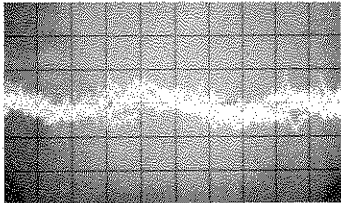

XA3 PIN 6
1MV P-P
-12.6VDC
(BANDWIDTH:40KC)

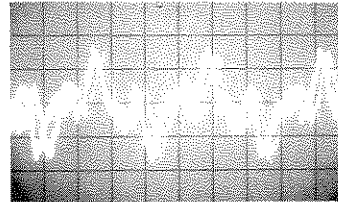

XA3 PIN 4
3MV P-P
+13.2VDC
(BANDWIDTH: 40KC;
SWEEP: 5MSEC/CM)

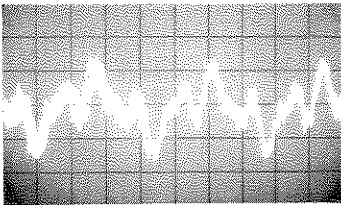

XA3 PIN 3
3MV P-P
+13.2VDC
(BANDWIDTH:40KC;
SWEEP: 5MSEC/CM)

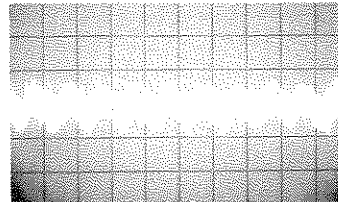

XA3 PIN 1
0.8MV P-P
-12.6VDC
(BANDWIDTH: 40KC;
SWEEP: 1MSEC/CM)

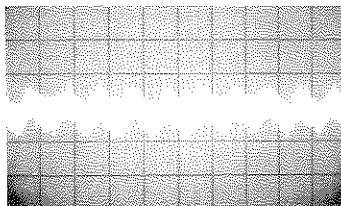

XA3 PIN 2
0.8MV P-P
+13.2VDC
(BANDWIDTH:40 KC;
SWEEP: 1MSEC/CM)

415E-A-11

MEASUREMENT CONDITIONS (unless otherwise noted).*

- Model 415E set to HIGH, NORM, RANGE 0, BANDWIDTH cw, FREQ centered, GAIN & VERNIER ccw, BATTERY/ON.
- MODEL 140A with 1420A & 1400A set to 0.2 msec/cm, AC, 400 kc, and appropriate vertical sensitivity.
- Model 200CE Oscillator set to about 1000 cps, and for 0 db Model 415E meter reference.
- Model 412A DC Voltmeter set to appropriate range.

*All measurements made with respect to 415E common (black terminal rear panel AMPLIFIER OUTPUT connector).

Figure 5-6. Power Supply Waveforms (INTERNAL BATTERY OPERATION - ONLY)

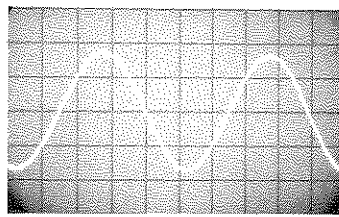

1000 CPS
INPUT SIGNAL
38V P-P

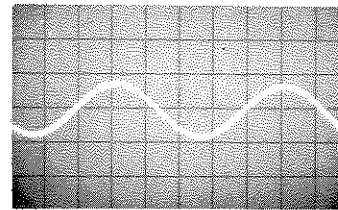

XA3 PIN 17
3.8MV P-P
40KC BANDWIDTH
+2.6VDC

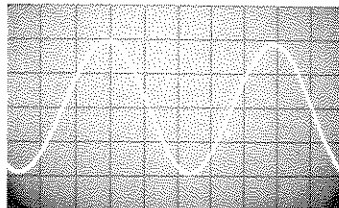

XA3 PIN 21
37MV P-P

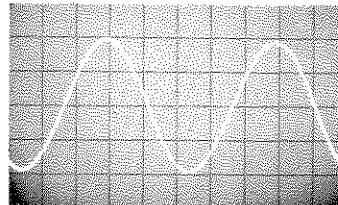

XA3 PIN 16
170MV P-P



XA3 PIN 19
4V P-P

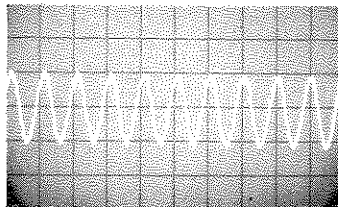

XA3 PIN 11
10MV P-P

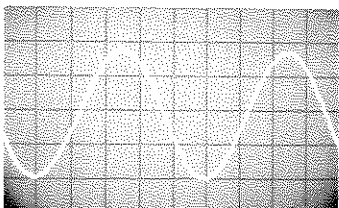

XA3 PIN 18
4V P-P
+2.6VDC

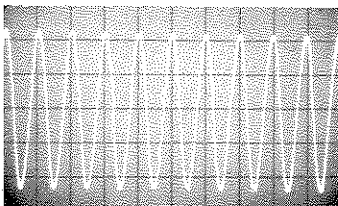

XA3 PIN 8
0.9V P-P

415E-A-14

MEASUREMENT CONDITIONS (unless otherwise noted).*

- Model 415E set to ON, HIGH, NORM, RANGE 0, BANDWIDTH cw, FREQ centered, GAIN & VERNIER ccw.
- MODEL 140A with 1420A & 1400A set to 0.2 msec/cm, AC, 400 kc, and appropriate vertical sensitivity.
- Model 200CE Oscillator set to about 1000 cps, and for 0 db Model 415E meter reference.
- Model 412A DC Voltmeter set to appropriate range.

*All measurements made with respect to 415E common (black terminal rear panel AMPLIFIER OUTPUT connector).

Figure 5-7. Signal Flow Waveforms (INPUT TO AMPLIFIER OUTPUT)

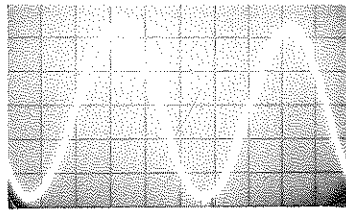

AMPLIFIER
OUTPUT
2.5V P-P
(EXPAND: 0)

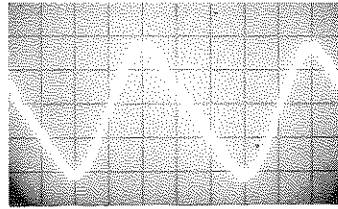

RECORDER
OUTPUT
0.2V P-P
+1.0VDC
(EXPAND: 0)

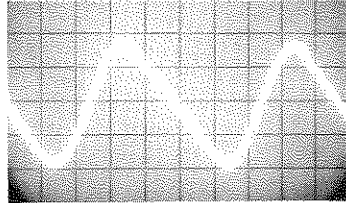

RECORDER
OUTPUT
72MV P-P
+1.0VDC

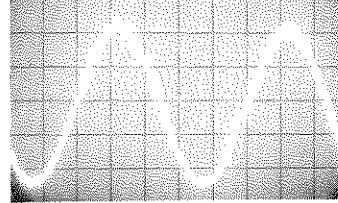

AMPLIFIER
OUTPUT
0.9V P-P

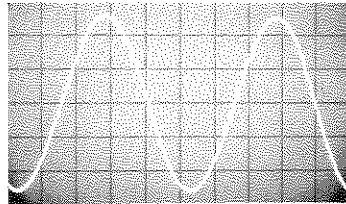

XA3 PIN 15
0.25V P-P
+1.4VDC

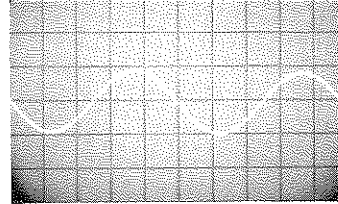

XA3 PIN 13
3.8MV P-P
(40KC BANDWIDTH)
+1.1VDC

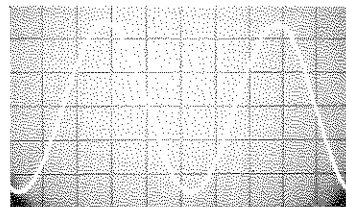

XA3 PIN 14
0.25V P-P
+1.4VDC

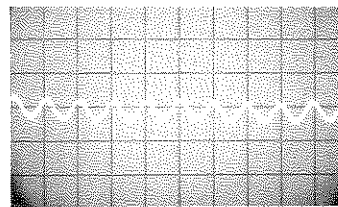

XA3 PIN 12
0.6MV P-P
(BANDWIDTH 40KC)
+1.1VDC

415E-A-12

MEASUREMENT CONDITIONS (unless otherwise noted).*

- Model 415E set to ON, HIGH, NORM, RANGE 0, BANDWIDTH cw, FREQ centered, GAIN & VERNIER ccw.
- MODEL 140A with 1420A & 1400A set to 0.2 msec/cm, AC, 400 kc, and appropriate vertical sensitivity.
- Model 200CE Oscillator set to about 1000 cps, and for 0 db Model 415E meter reference.
- Model 412A DC Voltmeter set to appropriate range.

*All measurements made with respect to 415E common (black terminal rear panel AMPLIFIER OUTPUT connector).

Figure 5-8. Meter and Output Waveforms

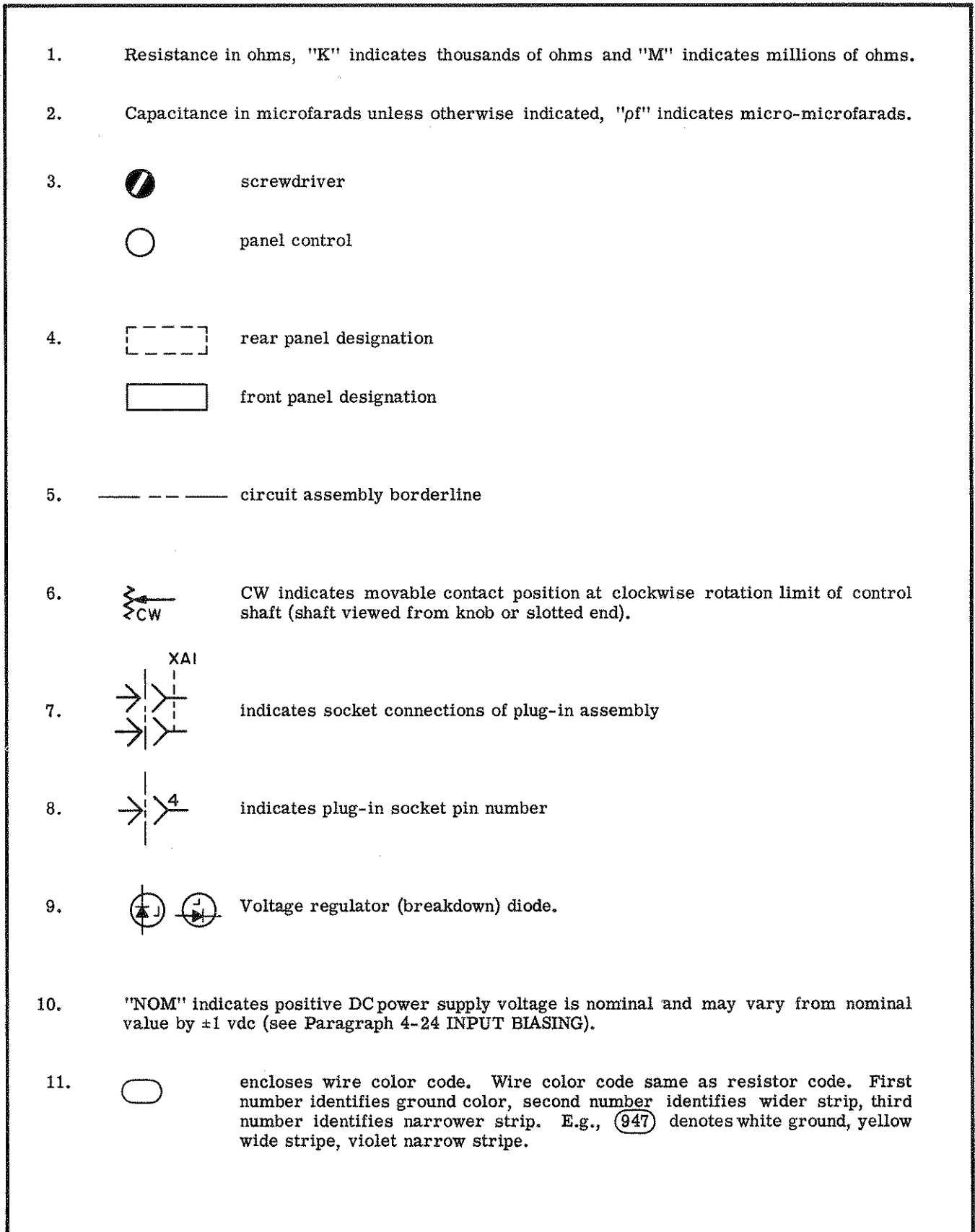

Figure 5-9. Schematic Notes

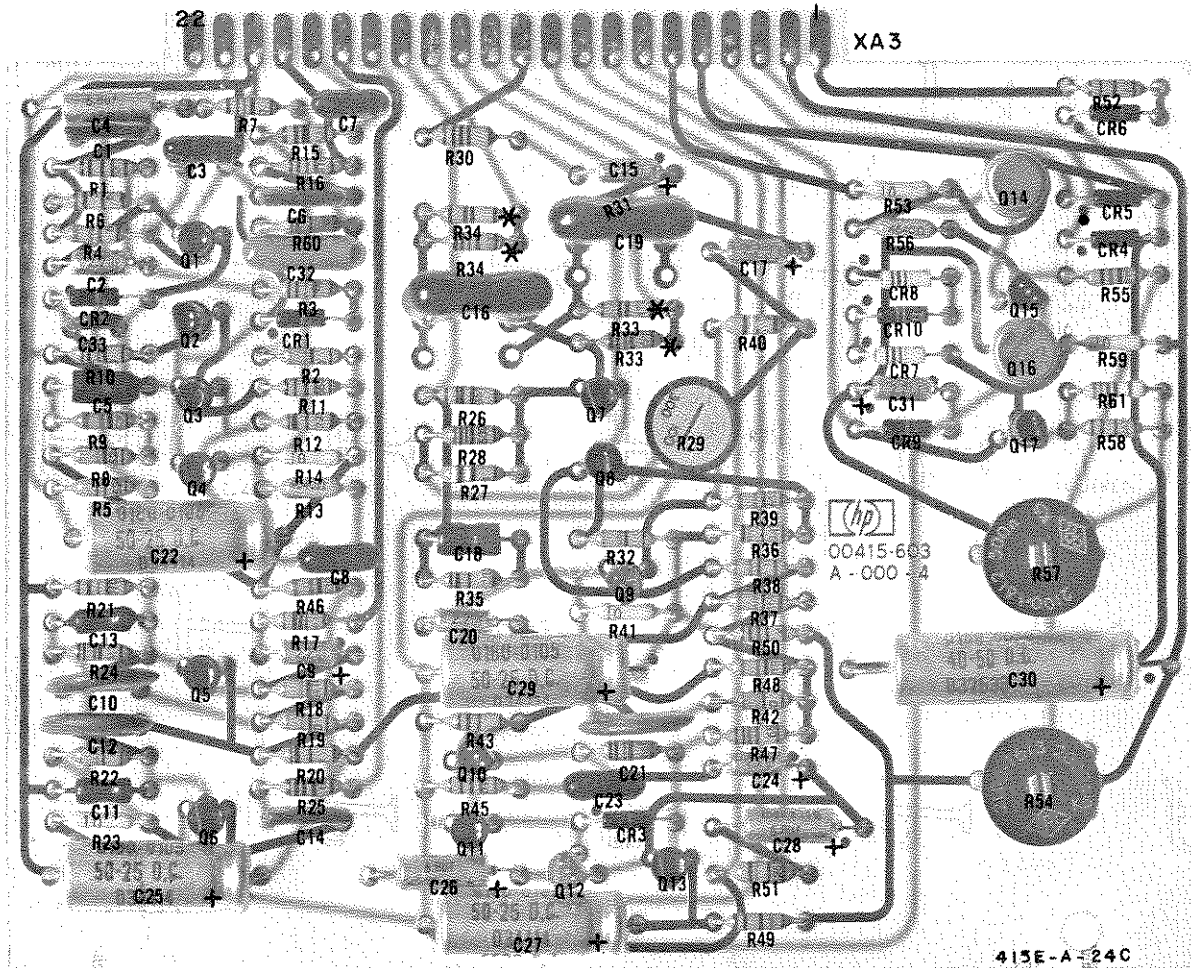
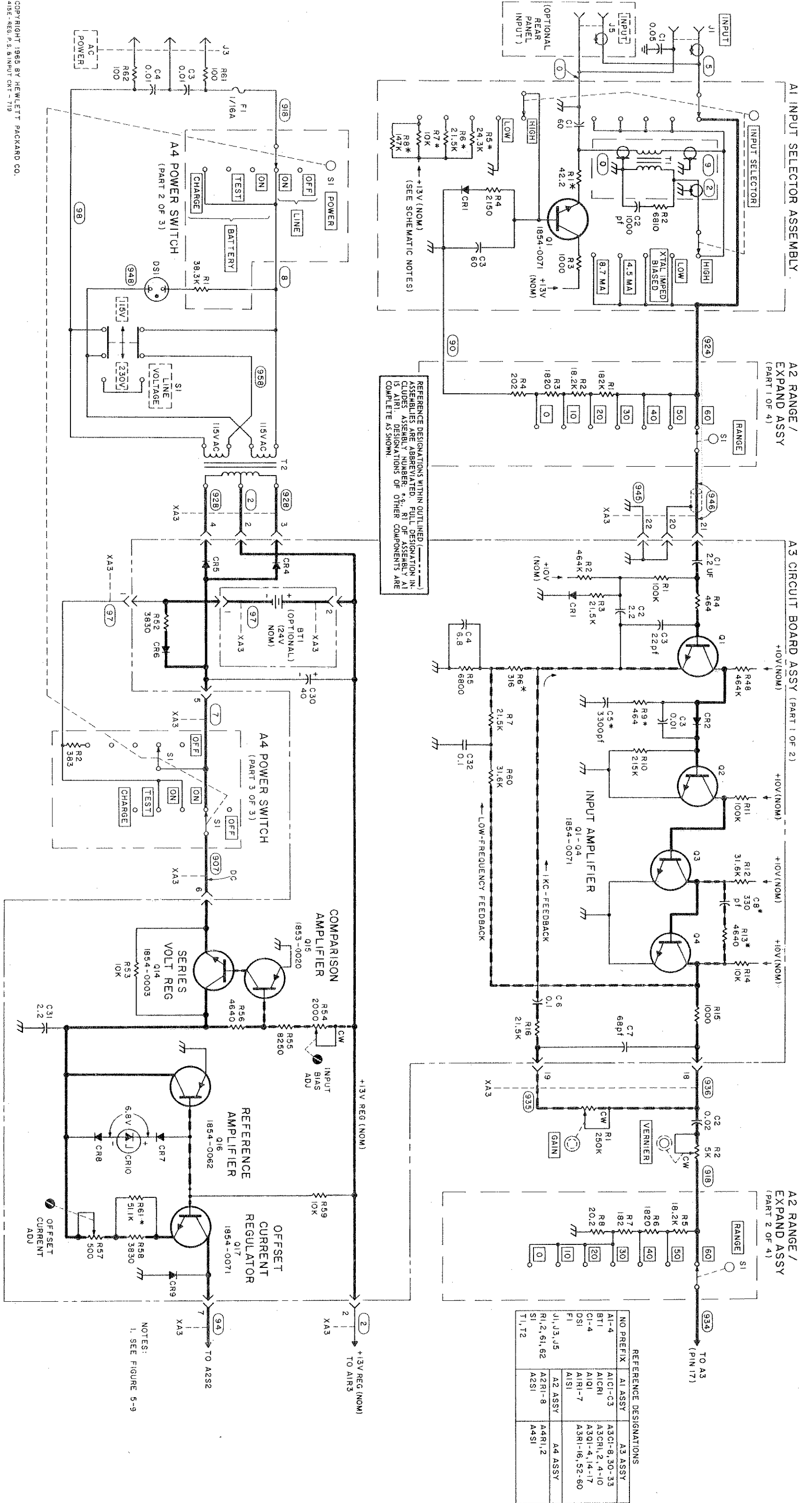

Figure 5-10. A3 Circuit Board Component Location for Instruments Prefixed 545-, and up.
See Appendix II for Component Location of Instruments Prefixed 530-.



NO PREFIX	AI ASSY	A3 ASSY
AI-4	A1C1-C3	A3C1-6,30-33
BT1	A1CRI	A3CRI,2,4-10
CI-4	A1DI	A3CI-4,14-17
DS1	A1R1-7	A3R1-16,52-60
F1	A1S1	
J1, J3, J5		
R1, 2, 61, 62	A2R1-8	A4R1, 2
S1	A2S1	A4S1
T1, T2		

REFERENCE DESIGNATIONS WITHIN OUTLINED ASSEMBLIES ARE ABBREVIATED. FULL DESIGNATION INCLUDES ASSEMBLY NUMBER, *%*, R1 OF ASSEMBLY A1 IS A1R1. DESIGNATIONS OF OTHER COMPONENTS ARE COMPLETE AS SHOWN.

NOTES:
1. SEE FIGURE 5-9

Figure 5-11. Power Supply and Input Circuit

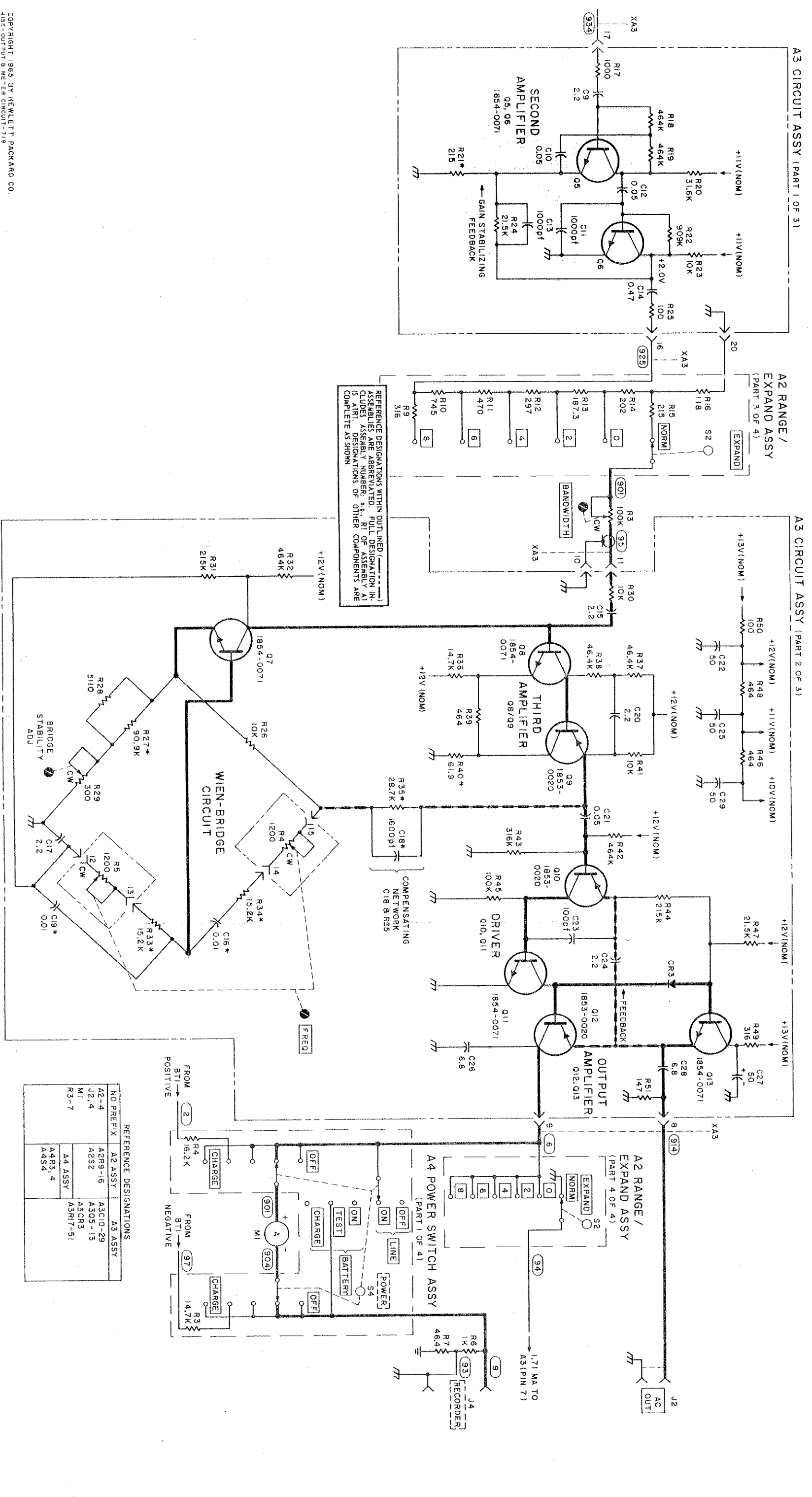

Figure 5-12. Output & Meter Circuit

COPYRIGHT 1968 BY HEWLETT PACKARD CO.
415E-OUTPUT & METER CIRCUIT-719

SECTION VI REPLACEABLE PARTS

6-1. INTRODUCTION

6-2. This section contains information for ordering replacement parts. Table 6-1 lists parts in alpha-numerical order of their reference designators and indicates the description and hp stock number of each part, together with any applicable notes. Table 6-2 lists parts in alpha-numerical order of their hp stock number and provides the following information on each part;

- a. Description of the part (see list of abbreviations below).
- b. Typical manufacturer of the part in a five-digit code; see list of manufacturers in Table 6-3.
- c. Manufacturer's part number.
- d. Total quantity used in the instrument (TQ column).

6-3. Miscellaneous parts are listed at the end of Table 6-1.

6-4. ORDERING INFORMATION

6-5. To obtain replacement parts, address order or inquiry to your local Hewlett-Packard Field Office (see lists at rear of this manual for addresses). Identify parts by their Hewlett-Packard stock numbers.

- 6-6. To obtain a part that is not listed, include;
 - a. Instrument model number.
 - b. Instrument serial number.
 - c. Description of the part.
 - d. Function and location of the part.

REFERENCE DESIGNATORS

A = assembly	E = misc electronic part	MP = mechanical part	TB = terminal board
B = motor	F = fuse	P = plug	TP = test point
BT = battery	FL = filter	Q = transistor	V = vacuum, tube, neon bulb, photocell, etc.
C = capacitor	J = jack	R = resistor	W = cable
CP = coupler	K = relay	RT = thermistor	X = socket
CR = diode	L = inductor	S = switch	Y = crystal
DL = delay line	M = meter	T = transformer	
DS = device signaling (lamp)			

ABBREVIATIONS

A = amperes	GE = germanium	N/C = normally closed	RMO = rack mount only
A. F. C. = automatic frequency control	GL = glass	NE = neon	RMS = root-mean square
AMPL = amplifier	GRD = ground(ed)	NI PL = nickel plate	RWV = reverse working voltage
	H = henries	N/O = normally open	S-B = slow-blow
B. F. O. = beat frequency oscillator	HEX = hexagonal	NPO = negative positive zero (zero temperature coefficient)	SCR = screw
BE CU = beryllium copper	HG = mercury	NRFR = not recommended for field replacement	SE = selenium
BH = binder head	HR = hour(s)	NSR = not separately replaceable	SECT = section(s)
BP = bandpass			SEMICON = semiconductor
BRS = brass	IF = intermediate freq		SI = silicon
BWO = backward wave oscillator	IMPG = impregnated		SIL = silver
	INCD = incandescent	OBD = order by description	SL = slide
CCW = counter-clockwise	INCL = include(s)	OH = oval head	SPL = special
CER = ceramic	INS = insulation(ed)	OX = oxide	SST = stainless steel
CMO = cabinet mount only	INT = internal		SR = split ring
COEF = coefficient			STL = steel
COM = common	K = kilo = 1000		
COMP = composition	LIN = linear taper	P = peak	TA = tantalum
CONN = connector	LK WASH = lock washer	PC = printed circuit	TD = time delay
CP = cadmium plate	LOG = logarithmic taper	PF = picofarads = 10 ⁻¹² farads	TGL = toggle
CRT = cathode-ray tube	LPF = low pass filter	PH BRZ = phosphor bronze	TI = titanium
CW = clockwise		PHL = Phillips	TOL = tolerance
		PIV = peak inverse voltage	TRIM = trimmer
DEPC = deposited carbon		P/O = part of	TWT = traveling wave tube
DR = drive	M = milli = 10 ⁻³	POLY = polystyrene	U = micro = 10 ⁻⁶
	MEG = meg = 10 ⁶	PORC = porcelain	
ELECT = electrolytic	MET FLM = metal film	POS = position(s)	VAR = variable
ENCAP = encapsulated	MET OX = metallic oxide	POT = potentiometer	VDCW = dc working volts
EXT = external	MFR = manufacturer	PP = peak-to-peak	
	MINAT = miniature	PT = point	W/ = with
	MOM = momentary	PWV = peak working voltage	W = watts
F = farads	MTG = mounting	RECT = rectifier	WIV = working inverse voltage
PH = flat head	MY = "mylar"	RF = radio frequency	WW = wirewound
FIL H = fillister head		RH = round head	W/O = without
FXD = fixed	N = nano (10 ⁻⁹)	RIV = reverse inverse voltage	

Table 6-1. Reference Designation Index

Reference Designation	Stock No.	Description #	Note
A1	00415-601	SWITCH ASSEMBLY: INPUT	
A1C1	0180-0106	C:FXD ELECT 60 UF 20% 6VDCW	
A1C2	0160-0153	C:FXD MYLAR 0.001UF 10%	
A1C3	0180-0106	C:FXD ELECT 60 UF 20% 6VDCW	
A1CR1	1901-0025	DIODE: JUNCTION: 100MA AT 1V 100 PIV	
A1Q1	1854-0071	TRANSISTOR: SILICON NPN 2N3391	
A1R1	0757-0316	R:FXD MET FLM 42.2 OHM 1% 1/8W	
A1R2	0757-0439	R:FXD MET FLM 6.81K OHM 1% 1/8W	
A1R3	0757-0280	R:FXD MET FLM 1.00K OHM 1% 1/8W	
A1R4	0698-0084	R:FXD MET FLM 2150 OHM 1% 1/8W	
A1R5	0757-0451	R:FXD MET FLM 24.3K OHM 1% 1/8W	
A1R6	0757-0199	R:FXD MET FLM 21.5K OHM 1% 1/8W	
A1R7	0757-0443	R:FXD MET FLM 11K OHM 1% 1/8W	
A1R8	0698-3452	R:FXD MET FLM 147K OHM 1% 1/8W	
A1S1	3100-1805	SWITCH: ROTARY	
A2	00415-602	SWITCH ASSEMBLY: RANGE	
A2R1	0698-6114	R:FXD MET FLM 182K OHM .25% 1/8W	
A2R2	0698-6109	R:FXD MET FLM 18.2 OHM .25% 1/8W	
A2R3	0698-6113	R:FXD MET FLM 1820 OHM .25% 1/8W	
A2R4	0698-6112	R:FXD MET FLM 202 OHM .25% 1/8W	
A2R5	0698-6109	R:FXD MET FLM 18.2 OHM .25% 1/8W	
A2R6	0698-6113	R:FXD MET FLM 1820 OHM .25% 1/8W	
A2R7	0698-6111	R:FXD MET FLM 182 OHM .25% 1/8W	
A2R8	0698-6110	R:FXD MET FLM 20.2 OHM .25% 1/8W	
A2R9	0698-3444	R:FXD MET FLM 316 OHM 1% 1/8W	
A2R10	0698-3531	R:FXD MET FLM 745 OHM 0.5% 1/8W	
A2R11	0698-3530	R:FXD MET FLM 470 OHM 0.5% 1/8W	
A2R12	0698-3529	R:FXD MET FLM 297 OHM 0.5% 1/8W	
A2R13	0698-3527	R:FXD MET FLM 187.3 OHM 0.5% 1/8W	
A2R14	0698-6112	R:FXD MET FLM 202 OHM .25% 1/8W	
A2R15	0698-3441	R:FXD MET FLM 215 OHM 1% 1/8W	
A2R16	0698-3525	R:FXD MET FLM 118 OHM 0.5% 1/8W	
A2S1	3100-1806	SWITCH: ROTARY	
A3	00415-603	BOARD ASSEMBLY: AMPLIFIER	
A3C1	0180-0155	C:FXD ELECT 2.2 UF 20% 20VDCW	
A3C2	0180-0155	C:FXD TA 2.2UF 20% 20VDCW	
A3C3	0140-0145	C:FXD MICA 22 PF 5% 500 VDCW	
A3C4	0180-0116	C:FXD ELECT TA 6.8 UF 10% 35VDCW	
A3C5	0160-0155	C:FXD MY 3300 PF 10%	
A3C6	0150-0121	C:FXD CER 0.1UF +80%-20% 50VDCW	
A3C7	0140-0192	C:FXD MICA 68PF 5% 300VDCW	
A3C8	0140-0207	C:FXD MICA 330PF 5% 500VDCW	
A3C9	0180-0155	C:FXD TA 2.2UF 20% 20VDCW	
A3C10	0150-0096	C:FXD CER 0.05UF 100VDCW	
A3C11	0160-0153	C:FXD MYLAR 0.001UF 10%	

See list of abbreviations in introduction to this section

Table 6-1. Reference Designation Index (Cont' d)

Reference Designation	Ⓢ Stock No.	Description #	Note
A3C12	0150-0096	C:FXD CER 0.05UF 100VDCW	
A3C13	0160-0153	C:FXD MYLAR 0.001UF 10%	
A3C14	0160-0174	C:FXD CER 0.47UF +80-20% 25VDCW	
A3C15	0180-0155	C:FXD ELECT 2.2 UF 20% 20VDCW	
A3C16	0160-2120	C:FXD MICA 0.01UF 1%	
A3C17	0180-0155	C:FXD ELECT 2.2 UF 20% 20VDCW	
A3C18	0160-0299	C:FXD MYLAR .0018 UF 10% 200VDCW	
A3C19	0160-2120	C:FXD MICA 0.01UF 1%	
A3C20	0180-0155	C:FXD ELECT 2.2 UF 20% 20VDCW	
A3C21	0150-0096	C:FXD CER 0.05UF 100VDCW	
A3C22	0180-0105	C:FXD ELECT SEMI-POLARIZED 50UF 25VDCW	
A3C23	0140-0176	C:FXD MICA 100 PF 2% 300 VDCW	
A3C24	0180-0155	C:FXD ELECT 2.2 UF 20% 20VDCW	
A3C25	0180-0105	C:FXD ELECT SEMI-POLARIZED 50UF 25VDCW	
A3C26	0180-0116	C:FXD ELECT TA 6.8 UF 10% 35VDCW	
A3C27	0180-0105	C:FXD ELECT SEMI-POLARIZED 50UF 25VDCW	
A3C28	0180-0116	C:FXD ELECT TA 6.8 UF 10% 35VDCW	
A3C29	0180-0105	C:FXD ELECT SEMI-POLARIZED 50UF 25VDCW	
A3C30	0180-0050	C:FXD ELECT 40UF -15%+100% 50VDCW	
A3C31	0180-0155	C:FXD ELECT 2.2 UF 20% 20VDCW	
A3C32	0170-0085	C:FXD MY 0.1UF 20% 50VDCW	
A3C33	0150-0093	C:FXD CER 0.01UF +80-20% 100VDCW	
A3CR1	1901-0025	DIODE:JUNCTION:100 MA AT 1V 100 PIV	
A3CR2	1901-0025	DIODE:JUNCTION:100 MA AT 1V 100 PIV	
A3CR3	1901-0025	DIODE:JUNCTION:100 MA AT 1V 100 PIV	
A3CR4	1901-0033	DIODE:SILICON 100 MA AT +1V 180 WIV	
A3CR5	1901-0033	DIODE:SILICON 100 MA AT +1V 180 WIV	
A3CR6	1901-0025	DIODE:JUNCTION:100 MA AT 1V 100 PIV	
A3CR7	1910-0016	DIODE:GERMANIUM 100MA AT 0.85V 60PIV	
A3CR8	1910-0016	DIODE:GERMANIUM 100MA AT 0.85V 60PIV	
A3CR9	1901-0025	DIODE:JUNCTION:100 MA AT 1V 100 PIV	
A3CR10	1902-0048	SEMICON DEVICE:DIODE BREAKDOWN 6.8V 10%	
A3Q1	1854-0071	TRANSISTOR:SILICON NPN 2N3391	
A3Q2	1854-0071	TRANSISTOR:SILICON NPN 2N3391	
A3Q3	1854-0071	TRANSISTOR:SILICON NPN 2N3391	
A3Q4	1854-0071	TRANSISTOR:SILICON NPN 2N3391	
A3Q5	1854-0071	TRANSISTOR:SILICON NPN 2N3391	
A3Q6	1854-0071	TRANSISTOR:SILICON NPN 2N3391	
A3Q7	1854-0071	TRANSISTOR:SILICON NPN 2N3391	
A3Q8	1854-0071	TRANSISTOR:SILICON NPN 2N3391	
A3Q9	1853-0020	TRANSISTOR:SILICON PNP	
A3Q10	1853-0020	TRANSISTOR:SILICON PNP	
A3Q11	1854-0071	TRANSISTOR:SILICON NPN 2N3391	
A3Q12	1853-0020	TRANSISTOR:SILICON PNP	
A3Q13	1854-0071	TRANSISTOR:SILICON NPN 2N3391	
A3Q14	1854-0003	TRANSISTOR:PNP SILICON	
A3Q15	1853-0020	TRANSISTOR:SILICON PNP	
A3Q16	1850-0062	TRANSISTOR:GERMANIUM PNP 2N404	
A3Q17	1854-0071	TRANSISTOR:SILICON NPN 2N3391	
A3R1	0757-0465	R:FXD MET FLM 100K OHM 1% 1/8W	

See list of abbreviations in introduction to this section

Table 6-1. Reference Designation Index (Cont'd)

Reference Designation	Stock No.	Description #	Note
A3R2	0698-3260	RIFXD MET FLM 464K OHM 1% 1/8W	
A3R3	0757-0199	RIFXD MET FLM 21.5K OHM 1% 1/8W	
A3R4	0698-0082	RIFXD MET FLM 464 OHM 1% 1/8W	
A3R5	0757-0439	RIFXD MET FLM 6.81K OHM 1% 1/8W	
A3R6	0698-3444	RIFXD MET FLM 316 OHM 1% 1/8W	
A3R7	0757-0199	RIFXD MET FLM 21.5K OHM 1% 1/8W	
A3R8	0698-3260	RIFXD MET FLM 464K OHM 1% 1/8W	
A3R9	0698-0082	RIFXD MET FLM 464 OHM 1% 1/8W	
A3R10	0698-3454	RIFXD MET FLM 215K OHM 1% 1/8W	
A3R11	0757-0465	RIFXD MET FLM 100K OHM 1% 1/8W	
A3R12	0698-3160	RIFXD MET FLM 31.6K OHM 1% 1/8W	
A3R13	0698-3155	RIFXD MET FLM 4640 OHM 1% 1/8	
A3R14	0757-0442	RIFXD MET FLM 10.0K OHM 1% 1/8W	
A3R15	0757-0280	RIFXD MET FLM 1.00K OHM 1% 1/8W	
A3R16	0757-0199	RIFXD MET FLM 21.5K OHM 1% 1/8W	
A3R17	0757-0280	RIFXD MET FLM 1.00K OHM 1% 1/8W	
A3R18	0698-3260	RIFXD MET FLM 464K OHM 1% 1/8W	
A3R19	0698-3260	RIFXD MET FLM 464K OHM 1% 1/8W	
A3R20	0698-3160	RIFXD MET FLM 31.6K OHM 1% 1/8W	
A3R21	0698-3441	RIFXD MET FLM 215 OHM 1% 1/8W	
A3R22	0757-0488	RIFXD MET FLM 909K OHM 1% 1/8W	
A3R23	0757-0442	RIFXD MET FLM 10.0K OHM 1% 1/8W	
A3R24	0757-0199	RIFXD MET FLM 21.5K OHM 1% 1/8W	
A3R25	0757-0401	RIFXD MET FLM 100 OHM 1% 1/8W	
A3R26	0757-0442	RIFXD MET FLM 10.0K OHM 1% 1/8W	
A3R27	0757-0464	RIFXD MET FLM 90.9K OHM 1% 1/8W	
A3R28	0757-0438	RIFXD MET FLM 5.11K OHM 1% 1/8W	
A3R29	2100-1611	RIVAR WW 300 OHM 5% 1W LIN 1/5W	
A3R30	0757-0442	RIFXD MET FLM 10.0K OHM 1% 1/8W	
A3R31	0698-3454	RIFXD MET FLM 215K OHM 1% 1/8W	
A3R32	0698-3260	RIFXD MET FLM 464K OHM 1% 1/8W	
A3R33	0698-5001	RIFXD MET FLM 15.2K OHM 1% 1/8W	
A3R34	0698-5001	RIFXD MET FLM 15.2K OHM 1% 1/8W	
A3R35	0698-3160	RIFXD MET FLM 31.6K OHM 1% 1/8W	
A3R36	0698-3156	RIFXD MET FLM 14.7K OHM 1% 1/8W	
A3R37	0698-3162	RIFXD MET FLM 4640 OHM 1% 1/8W	
A3R38	0698-3162	RIFXD MET FLM 4640 OHM 1% 1/8W	
A3R39	0698-0082	RIFXD MET FLM 464 OHM 1% 1/8W	
A3R40	0698-4037	RIFXD MET FLM 46.4 OHM 1% 1/8W	
A3R41	0757-0442	RIFXD MET FLM 10.0K OHM 1% 1/8W	
A3R42	0698-3260	RIFXD MET FLM 464K OHM 1% 1/8W	
A3R43	0698-3457	RIFXD MET FLM 316K OHM 1% 1/8W	
A3R44	0698-3454	RIFXD MET FLM 215K OHM 1% 1/8W	
A3R45	0757-0465	RIFXD MET FLM 100K OHM 1% 1/8W	
A3R46	0698-0082	RIFXD MET FLM 464 OHM 1% 1/8W	
A3R47	0757-0199	RIFXD MET FLM 21.5K OHM 1% 1/8W	
A3R48	0698-0082	RIFXD MET FLM 464 OHM 1% 1/8W	
A3R49	0698-3444	RIFXD MET FLM 316 OHM 1% 1/8W	
A3R50	0757-0401	RIFXD MET FLM 100 OHM 1% 1/8W	
A3R51	0698-3438	RIFXD MET FLM 147 OHM 1% 1/8W	
A3R52	0698-3153	RIFXD MET FLM 3830 OHM 1% 1/8W	

See list of abbreviations in introduction to this section

Table 6-1. Reference Designation Index (Cont'd)

Reference Designation	Stock No.	Description #	Note
A3R53	0757-0442	R:FXD MET FLM 10.0K OHM 1% 1/8W	
A3R54	2100-1613	R:VAR COMP 2K OHM 20% LIN 1/5W	
A3R55	0757-0441	R:FXD MET FLM 8.25K OHM 1% 1/8W	
A3R56	0698-3155	R:FXD MET FLM 4640 OHM 1% 1/8	
A3R57	2100-1612	R:VAR COMP 500 OHM 20% LIN 1/5W	
A3R58	0698-3153	R:FXD MET FLM 3830 OHM 1% 1/8W	
A3R59	0757-0442	R:FXD MET FLM 10.0K OHM 1% 1/8W	
A3R60	0698-3160	R:FXD MET FLM 31.6K OHM 1% 1/8W	
A3R61	0757-0462	R:FXD MET FLM 51.1K OHM 1% 1/8W	
A4	00415-608	SWITCH ASSEMBLY, POWER	
A4R1	0698-3161	R:FXD MET FLM 38.3K OHM 1% 1/8W	
A4R2	0698-3446	R:FXD MET FLM 383 OHM 1% 1/8W	
A4R3	0698-3156	R:FXD MET FLM 14.7K OHM 1% 1/8W	
A4R4	0757-0447	R:FXD MET FLM 16.2K OHM 1% 1/8W	
A4S1	3100-1807	SWITCH:ROTARY	
BT1	1420-0009	BATTERY:RECHARGEABLE 24V 1.25AH (OPTION 01 ONLY)	
C1	0150-0096	C:FXD CER 0.05UF 100VDCW	
C2	0150-0096	C:FXD CER 0.05UF 100VDCW	
C3	0150-0119	C:FXD CER 2X(0.01 UF) 20% 250VDCW	
C4	0150-0119	C:FXD CER 2X(0.01 UF) 20% 250VDCW	
DS1	1450-0048	LAMP:NEON	
F1	2110-0011	FUSE:CARTRIDGE 3 AG 1/16 AMP 250V MAX	
J1	1250-0118	CONNECTOR:BNC	
J2	1510-0006	BINDING POST ASSEMBLY:BLACK	
J2	1510-0007	BINDING POST ASSEMBLY:RED	
J2	0340-0086	INSULATOR:BINDING POST	
J2	0340-0090	INSULATOR:BINDING-POST DOUBLE	
J3	1251-0148	CONNECTOR:POWER 3 PIN MALE	
J4	1250-0118	CONNECTOR:BNC RECORDER	
J5	1250-0001	CONNECTOR:BNC (OPTION 02 ONLY)	
M1	1120-0392	METER	
R1	2100-1574	R:VAR COMP 250K 10% 20CWLOG 15K OHM20% LIN	
R2		PART OF R1	
R3	2100-1578	R:VAR COMP 100K OHM 10% 20 CCWLOG 13W	
R4	2100-1577	R:VAR WW DUAL 1200 OHM 10% LIN TANDEM	
R5		PART OF R4	
R6	0757-0280	R:FXD MET FLM 1000 OHM 1% 1/8W	
R7	0698-4037	R:FXD MET FLM 46.4 OHM 1% 1/8W	
R8	THRU		
R60		NOT ASSIGNED	
R61	0757-0401	R:FXD MET FLM 100 OHM 1% 1/8W	
R62	0757-0401	R:FXD MET FLM 100 OHM 1% 1/8W	
S1	3101-0033	SWITCH:SLIDE DPDT	
T1	9100-0392	TRANSFORMER:AUDIO	
T2	9100-0393	TRANSFORMER:POWER	
XA3	1251-0172	CONNECTOR:PRINTED CIRCUIT 22-CONN	

See list of abbreviations in introduction to this section

Table 6-1. Reference Designation Index (Cont'd)

Reference Designation	Ⓢ Stock No.	Description #	Note
XF1	1400-0084	FUSEHOLDER:EXTRACTOR POST TYPE	
		<u>MISCELLANEOUS</u>	
	00415-606	BATTERY INSTALLATION KIT, INCLUDES SAMPLE PARTS AS INSTALLED WITH OPTION 01 AND FOUR 6-32 HEX NUTS FOR MOUNTING	
	00415-003 0370-0062	DIAL-KNOB ASSY:EXPAND KNOB:BLACK, VERNIER	
	0370-0089 0370-0104 0370-0106 8120-0078	KNOB:BLACK CONCENTRIC 1 IN. OD GAIN KNOB:BLACK BAR W/ARROW 13/16 DIA 1/4" SHAFT KNOB:RANGE CABLE:POWER 7.5 FT	
		<u>OPTIONS</u>	
		OPTION 01:	
	1420-0009 00415-006 2420-0001	BATTERY, RECHARGEABLE (BT1) COVER, BATTERY HEX NUTS (QTY-4)	
		NOTE: SEE MISCELLANEOUS SECTION FOR BATTERY INSTALLATION KIT STOCK NUMBERS	
		OPTION 02:(J5)	
00415-607 0360-0024 1250-0001 2420-0001 3050-0100 3050-0018	CABLE:SPECIAL PURPOSE ELECTRICAL TERMINAL LUG CONNECTOR:BNC HEX NUT: 6-32 X 5/16 WASHER, LOCK NO. 6 WASHER, EXTRUDED FIBER (QTY-2)		

See list of abbreviations in introduction to this section

Table 6-1. Reference Designation Index (Cont'd)

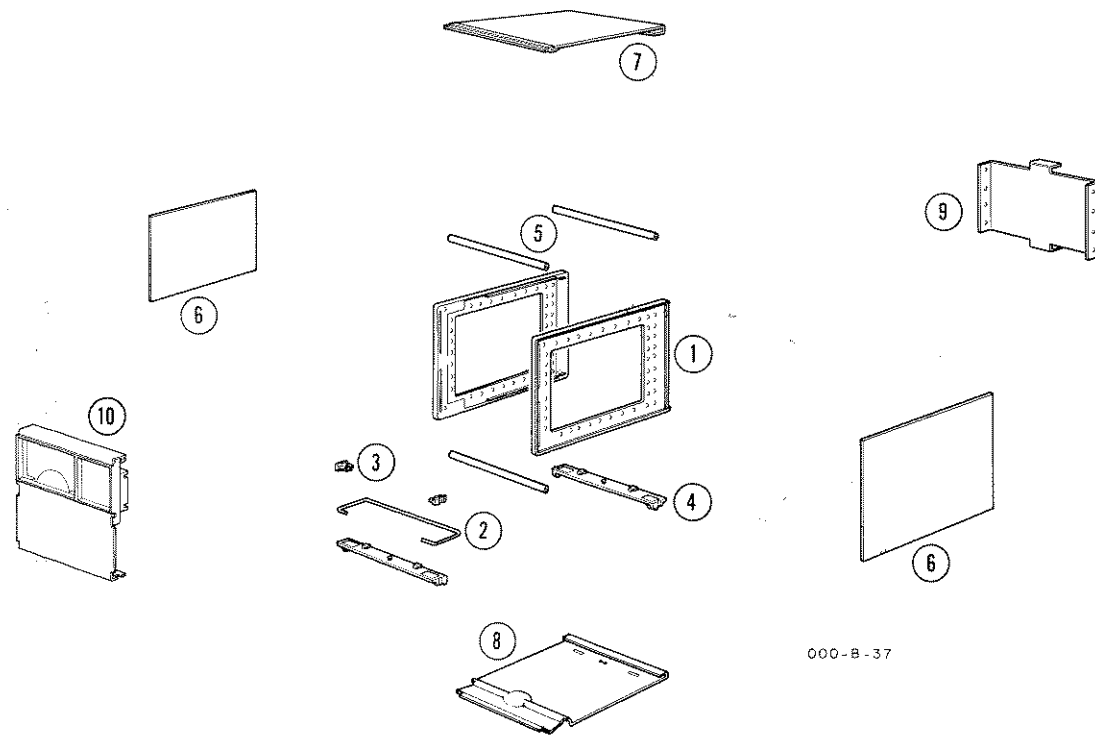
Reference Designation	Stock No.	Description #	Note
			
000-B-37			
CABINET PARTS			
1.	5060-0703	FRAME ASSEMBLY	
2.	1490-0032	STAND: TILT HALF-MODULE	
3.	5040-0700	HINGE	
4.	5060-0728	FOOT ASSEMBLY HALF MODULE	
5.	5020-0701	CABINET SPACER	
6.	2370-0015	LOCKWASHER: 6-32 X 0.375" FH SLOT DRIVE	
	5000-0703	COVER:SIDE	
	2370-0020	# 6-32 X 0.187" 100° FH, PHILLIPS DRIVE	
7.	5060-0720	COVER:TOP	
	2370-0016	# 6-32 X 0.373" 100° FH, PHILLIPS DRIVE	
8.	5000-0717	COVER:BOTTOM	
	2370-0016	# 6-32 X 0.373" 100° FH, PHILLIPS DRIVE	
9.	00415-004	PANEL:REAR	
	2370-0015	# 6-32 X 0.375" FH,SLOT DR W/ EXT LOCKWASHER	
10	00415-002	PANEL:FRONT	
	2370-0002	# 6-32 X 0.375" FH,SLOT DRIVE	

See list of abbreviations in introduction to this section

Table 6-2. Replaceable Parts

Stock No.	Description #	Mfr.	Mfr. Part No.	TQ
0140-0145	C:FXD MICA 22 PF 5% 500 VDCW	04062	RDM15C220J5C	1
0140-0176	C:FXD MICA 100 PF 2% 300 VDCW	04062	RDM15F101G3C	1
0140-0192	C:FXD MICA 68PF 5% 300VDCW	04062	RDM15E680J3C	1
0140-0207	C:FXD MICA 330PF 5% 500VDCW	04062	RDM15F331J5C	1
0150-0093	C:FXD CER 0.01UF +80-20% 100VDCW	91418	TA	1
0150-0096	C:FXD CER 0.05UF 100VDCW	91418	-TA	5
0150-0119	C:FXD CER 2X(0.01 UF) 20% 250VDCW	56289	41C159A	2
0150-0121	C:FXD CER 0.1UF +80%-20% 50VDCW	56289	5C50A	1
0160-0153	C:FXD MYLAR 0.001UF 10%	28480	0160-0153	3
0160-0155	C:FXD MY 3300 PF 10%	28480	0160-0155	1
0160-0174	C:FXD CER 0.47UF +80-20% 25VDCW	56289	5C11A	
0160-0299	C:FXD MYLAR .0018 UF 10% 200VDCW	28480	0160-0299	1
0160-2120	C:FXD MICA 0.01UF 1%	04062	RDM30F103F3C	2
0170-0085	C:FXD MY 0.1UF 20% 50VDCW	84411	601PE STYLE 3	1
0180-0050	C:FXD ELECT 40UF -15%+100% 50VDCW	56289	D32538	1
0180-0105	C:FXD ELECT SEMI-POLARIZED 50UF 25VDCW	56289	D34114	4
0180-0106	C:FXD ELECT TA 60UF 20% 6VDCW	56289	150D606X000682	2
0180-0116	C:FXD ELECT TA 6.8 UF 10% 35VDCW	56289	150D685X903582	3
0180-0155	C:FXD TA 2.2UF 20% 20VDCW	56289	150D225X0020A2	
0340-0086	INSULATOR: BINDING POST	28480	0340-0086	1
0340-0090	INSULATOR: BINDING-POST DOUBLE	28480	0340-0090	1
0360-0024	TERMINAL: LUG GROUNDING FOR POTENTIOMETERS	37942	A-131023-1	1
0370-0062	KNOB	28480	0370-0062	1
0370-0089	KNOB: BLK CONCENTRIC 1 IN. OD 17/64 IN. HOLE	28480	0370-0089	1
0370-0104	KNOB: BLACK BAR W/ARROW 13/16 DIA 1/4 SHAFT	28480	0370-0104	2
0370-0106	KNOB	28480	0370-0106	1
0380-0308	SPACER: CAPTIVE	28480	0380-0308	2
0698-0082	R:FXD MET FLM 464 OHM 1% 1/8W	28480	0698-0082	5
0698-0084	R:FXD MET FLM 2150 OHM 1% 1/8W	28480	0698-0084	1
0698-3153	R:FXD MET FLM 3830 OHM 1% 1/8W	28480	0698-3153	2
0698-3155	R:FXD MET FLM 4640 OHM 1% 1/8	28480	0698-3155	2
0698-3156	R:FXD MET FLM 14.7K OHM 1% 1/8W	28480	0698-3156	2
0698-3160	R:FXD MET FLM 31.6K OHM 1% 1/8W	28480	0698-3160	4
0698-3161	R:FXD MET FLM 3830 OHM 1% 1/8W	28480	0698-3161	1
0698-3162	R:FXD MET FLM 4640 OHM 1% 1/8W	28480	0698-3162	2
0698-3260	R:FXD MET FLM 464K OHM 1% 1/8W	28480	0698-3260	
0698-3438	R:FXD MET FLM 147 OHM 1% 1/8W	28480	0698-3438	1
0698-3441	R:FXD MET FLM 215 OHM 1% 1/8W	28480	0698-3441	2
0698-3444	R:FXD MET FLM 316 OHM 1% 1/8W	28480	0698-3444	3
0698-3446	R:FXD MET FLM 383 OHM 1% 1/8W	28480	0698-3446	1
0698-3452	R:FXD MET FLM 147K OHM 1% 1/8W	28480	0698-3452	1
0698-3454	R:FXD MET FLM 215K OHM 1% 1/8W	28480	0698-3454	3
0698-3457	R:FXD MET FLM 316K OHM 1% 1/8W	28480	0698-3457	1
0698-3525	R:FXD MET FLM 118 OHM 0.5% 1/8W	28480	0698-3525	1
0698-3527	R:FXD MET FLM 187.3 OHM 0.5% 1/8W	28480	0698-3527	1
0698-3529	R:FXD MET FLM 297 OHM 0.5% 1/8W	28480	0698-3529	1
0698-3530	R:FXD MET FLM 470 OHM 0.5% 1/8W	28480	0698-3530	1
0698-3531	R:FXD MET FLM 745 OHM 0.5% 1/8W	28480	0698-3531	1
0698-4037	R:FXD MET FLM 46.4 OHM 1% 1/8W	28480	0698-4037	2
0698-5001	R:FXD MET FLM 15.2K OHM 1% 1/8W	28480	0698-5001	2

See list of abbreviations in introduction to this section

Table 6-2. Replaceable Parts (Cont'd)

Stock No.	Description #	Mfr.	Mfr. Part No.	TQ
0698-6109	R:FXD MET FLM 18.2 OHM .25% 1/8W	28480	0698-6109	2
0698-6110	R:FXD MET FLM 20.2 OHM .25% 1/8W	28480	0698-6110	1
0698-6111	R:FXD MET FLM 182 OHM .25% 1/8W	28480	0698-6111	1
0698-6112	R:FXD MET FLM 202 OHM .25% 1/8W	28480	0698-6112	2
0698-6113	R:FXD MET FLM 1820 OHM .25% 1/8W	28480	0698-6113	2
0698-6114	R:FXD MET FLM 182K OHM .25% 1/8W	28480	0698-6114	1
0757-0199	R:FXD MET FLM 21.5K OHM 1% 1/8W	28480	0757-0199	6
0757-0280	R:FXD MET FLM 1.00K OHM 1% 1/8W	28480	0757-0280	4
0757-0316	R:FXD MET FLM 42.2 OHM 1% 1/8W	28480	0757-0316	1
0757-0401	R:FXD MET FLM 100 OHM 1% 1/8W	28480	0757-0401	4
0757-0438	R:FXD MET FLM 5.11K OHM 1% 1/8W	28480	0757-0438	1
0757-0439	R:FXD MET FLM 6.81K OHM 1% 1/8W	28480	0757-0439	2
0757-0441	R:FXD MET FLM 8.25K OHM 1% 1/8W	28480	0757-0441	1
0757-0442	R:FXD MET FLM 10.0K OHM 1% 1/8W	28480	0757-0442	7
0757-0443	R:FXD MET FLM 11 K OHM 1% 1/8W	28480	0757-0443	1
0757-0447	R:FXD MET FLM 16.2K OHM 1% 1/8W	28480	0757-0447	1
0757-0451	R:FXD MET FLM 24.3K OHM 1% 1/8W	28480	0757-0451	1
0757-0462	R:FXD MET FLM 51.1K OHM 1% 1/8W	28480	0757-0462	1
0757-0464	R:FXD MET FLM 90.9K OHM 1% 1/8W	28480	0757-0464	1
0757-0465	R:FXD MET FLM 100K OHM 1% 1/8W	28480	0757-0465	3
0757-1094	R:FXD MET FLM 1.47K OHM 1% 1/8W	28480	0757-1094	1
1120-0392	METER	28480	1120-0392	1
1250-0001	CONNECTOR:BNC	91737	5126	1
1250-0118	CONNECTOR:BNC	91737	8427	2
1251-0148	CONNECTOR:POWER 3 PIN MALE	60427	H-1061-2	1
1251-0172	CONNECTOR:PRINTED CIRCUIT 22-CONN	28480	1251-0172	1
1400-0084	HOLDER:FUSE POST TYPE 3AG	75915	342014	1
1420-0009	BATTERY:RECHARGEABLE 24V 1.25AH(OPT 01)	28480	1420-0009	1
1450-0048	LAMP:NEON	28480	1350-0048	1
1490-0032	STAND:TILT HALF-MODULE	28480	1490-0032	1
1510-0006	BINDING POST ASSEMBLY:BLACK	28480	1510-0006	1
1510-0007	BINDING POST ASSEMBLY:RED	28480	1510-0007	1
1850-0062	TRANSISTOR:GERMANIUM PNP 2N404	28480	1850-0062	1
1853-0020	TRANSISTOR:SILICON PNP	28480	1853-0020	4
1854-0003	TRANSISTOR:NPN SILICON	28480	1854-0003	1
1854-0071	TRANSISTOR:SILICON NPN 2N3391	89473	16A792	12
1901-0025	DIODE:JUNCTION:100MA AT 1V 100 PIV	28480	1901-0025	6
1901-0033	DIODE:SILICON 100 MA AT 41V 180 WIV	28480	1901-0033	2
1902-0048	SEMICON DEVICE:DIODE BREAKDOWN 6.8V 10%	28480	1902-0048	1
1910-0016	DIODE:GERMANIUM 100MA AT 0.85V 60PIV	28480	1910-0016	2
2100-1574	R:VAR COMP 250K 10% 20CWLOG 15K OHM20% LIN	28480	2100-1574	1
2100-1577	R:VAR WW DUAL 1200 OHM 10% LIN TANDEM	28480	2100-1577	1
2100-1578	R:VAR COMP 100K OHM 10% 20 CCWLOG 13W	28480	2100-1578	1
2100-1611	R:VAR WW 300 OHM 5% 1W LIN 1/5W	28480	2100-1611	1
2100-1612	R:VAR COMP 500 OHM 20% LIN 1/5W	28480	2100-1612	1
2100-1613	R:VAR COMP 2K OHM 20% LIN 1/5W	28480	2100-1613	1
2110-0011	FUSE:CARTRIDGE 3 AG 1/16 AMP 250V MAX	75915	312062	1
3100-1805	SWITCH:ROTARY	28480	3100-1805	1
3100-1806	SWITCH:ROTARY	28480	3100-1806	1
3100-1807	SWITCH:ROTARY	28480	3100-1807	1
3101-0033	SWITCH:SLIDE DPDT	42190	4633	1
5000-0703	COVER:SIDE 6 X 11 SM	28480	5000-0703	2
5000-0717	COVER:HALF-MODULE BOTTOM	28480	5000-0717	1

See list of abbreviations in introduction to this section

Table 6-2. Replaceable Parts (Cont' d)

Stock No.	Description #	Mfr.	Mfr. Part No.	TQ
5020-0701	CABINET SPACER	28480	5020-0701	3
5040-0700	HINGE	28480	5040-0700	2
5060-0703	FRAME ASSEMBLY	28480	5060-0703	2
5060-0720	COVER:HALF-RECESS TOP	28480	5060-0720	1
5060-0728	FOOT ASSY:HALF MODULE	28480	5060-0728	2
8120-0078	CABLE:POWER 7.5FT.	70903	KH4147	1
9100-0392	TRANSFORMER:AUDIO	28480	9100-0392	1
9100-0393	TRANSFORMER:POWER	28480	9100-0393	1
00415-002	PANEL: FRONT	28480	00415-002	1
00415-003	DIAL ASSY.: EXPAND	28480	00415-003	1
00415-004	PANEL: REAR	28480	00415-004	1
00415-006	COVER: BATTERY(OPTION 01)	28480	00415-006	1
00415-608	SWITCH ASSEMBLY: POWER	28480	00415-608	1
00415-601	SWITCH ASSEMBLY: INPUT	28480	00415-601	1
00415-602	SWITCH ASSEMBLY: RANGE	28480	00415-602	1
00415-603	BOARD ASSEMBLY: AMPLIFIER	28480	00415-603	1
00415-607	CABLE: SPECIAL PURPOSE ELECTRICAL(OPT 02)	28480	00415-607	2

See list of abbreviations in introduction to this section

TABLE 6-3.
CODE LIST OF MANUFACTURERS

The following code numbers are from the Federal Supply Code for Manufacturers Cataloging Handbooks H4-1 (Name to Code) and H4-2 (Code to Name) and their latest supplements. The date of revision and the date of the supplements used appear at the bottom of each page. Alphabetical codes have been arbitrarily assigned to suppliers not appearing in the H4 Handbooks.

Code No.	Manufacturer	Address	Code No.	Manufacturer	Address	Code No.	Manufacturer	Address
00000	U. S. A. Common	Any supplier of U. S.	05729	Metro-Tel Corp.	Westbury, N. Y.	12881	Metex Electronics Corp.	Clark, N. J.
00136	McCoy Electronics	Mount Holly Springs, Pa.	05783	Stewart Engineering Co.	Santa Cruz, Calif.	12930	Delta Semiconductor Inc.	Newport Beach, Calif.
00213	Sage Electronics Corp.	Rochester, N. Y.	05820	Wakefield Engineering Inc.	Wakefield, Mass.	12954	Dickson Electronics Corp.	Scottsdale, Arizona
00287	Cemco Inc.	Danielson, Conn.	06004	Bassick Co., The	Bridgeport, Conn.	13103	Thermolloy	Dallas, Texas
00334	Humidial	Colton, Calif.	06090	Raychem Corp.	Redwood City, Calif.	13396	Telefunken (GmbH)	Hanover, Germany
00348	Microtron Co., Inc.	Valley Stream, N. Y.	06175	Bausch and Lomb Optical Co.	Rochester, N. Y.	13835	Midland-Wright Div. of Pacific Industries, Inc.	Kansas City, Kansas
00373	Garlock Inc., Electronics Products Div.	Camden, N. J.	06402	E. T. A. Products Co. of America	Chicago, Ill.	14099	Sem-Tech	Newbury Park, Calif.
00656	Aerovox Corp.	New Bedford, Mass.	06540	Anatom Electronic Hardware Co., Inc.	New Rochelle, N. Y.	14193	Calif. Resistor Corp.	Santa Monica, Calif.
00779	Amp. Inc.	Harrisburg, Pa.	06555	Beede Electrical Instrument Co., Inc.	Penacook, N. H.	14298	American Components, Inc.	Conshohocken, Pa.
00781	Aircraft Radio Corp.	Boonton, N. J.	06666	General Devices Co., Inc.	Indianapolis, Ind.	14433	ITT Semiconductor, A Div. of Int. Telephone & Telegraph Corp.	West Palm Beach, Fla.
00815	Northern Engineering Laboratories, Inc.	Burlington, Wis.	06751	Semcor Div. Components Inc.	Phoenix, Ariz.	14493	Hewlett-Packard Company	Loveland, Colo.
00853	Sangamo Electric Co., Pickens Div.	Pickens, S. C.	06812	Torrington Mfg. Co., West Div.	Van Nuys, Calif.	14655	Cornell Dublier Electric Corp.	Newark, N. J.
00866	Goe Engineering Co.	Los Angeles, Calif.	06980	Varian Assoc. Eimac Div.	San Carlos, Calif.	14674	Corning Glass Works	Corning, N. Y.
00891	Carl E. Holmes Corp.	Los Angeles, Calif.	07088	Kelvin Electric Co.	Van Nuys, Calif.	14752	Electro Cube Inc.	So. Pasadena, Calif.
00929	Microtab Inc.	Livingston, N. J.	07126	Digitran Co.	Pasadena, Calif.	14960	Williams Mfg. Co.	San Jose, Calif.
01009	Aiden Products Co.	Brockton, Mass.	07137	Transistor Electronics Corp.	Minneapolis, Minn.	15203	Webster Electronics Co.	New York, N. Y.
01121	Allen Bradley Co.	Milwaukee, Wis.	07138	Westinghouse Electric Corp. Electronic Tube Div.	Elmira, N. Y.	15291	Adjustable Bushing Co.	N. Hollywood, Calif.
01255	Litton Industries, Inc.	Beverly Hills, Calif.	07149	Filmohm Corp.	New York, N. Y.	15558	Micron Electronics	Garden City, Long Island, N. Y.
01281	TRW Semiconductors, Inc.	Lawndale, Calif.	07233	Cinch-Graphik Co.	City of Industry, Calif.	15566	Amprobe Inst. Corp.	Lynbrook, N. Y.
01295	Texas Instruments, Inc., Transistor Products Div.	Dallas, Texas	07261	Avnet Corp.	Culver City, Calif.	15772	Twentieth Century Coil Spring Co.	Santa Clara, Calif.
01349	The Alliance Mfg. Co.	Alliance, Ohio	07263	Fairchild Camera & Inst. Corp. Semiconductor Div.	Mountain View, Calif.	15818	Amelco Inc.	Mt. View, Calif.
01589	Pacific Relays, Inc.	Van Nuys, Calif.	07322	Minnesota Rubber Co.	Minneapolis, Minn.	15909	Daven Div. Thomas A. Edison Ind. McGraw-Edison Co.	Long Island City, N. Y.
01930	Amerock Corp.	Rockford, Ill.	07387	Bitcher Corp., The	Monterey Park, Calif.	16037	Spruce Pine Mica Co.	Spruce Pine, N. C.
01961	Pulse Engineering Co.	Santa Clara, Calif.	07700	Technical Wire Products Inc.	Cranford, N. J.	16179	Omni-Spectra Inc.	Detroit, Ill.
02114	Ferroxcube Corp. of America	Saugerties, N. Y.	07910	Continental Device Corp.	Hawthorne, Calif.	16352	Computer Diode Corp.	Lodi, N. J.
02286	Cote Rubber and Plastics Inc.	Sunnyvale, Calif.	07933	Raytheon Mfg. Co., Semiconductor Div.	Mountain View, Calif.	16688	Ideal Prec. Meter Co., Inc. De Jur Meter Div.	Brooklyn, N. Y.
02660	Amphenol-Borg Electronics Corp.	Chicago, Ill.	07966	Shockley Semi-Conductor Laboratories	Palo Alto, Calif.	16758	Delco Radio Div. of G. M. Corp.	Kokomo, Ind.
02735	Radio Corp. of America, Semiconductor and Materials Div.	Somerville, N. J.	07980	Hewlett-Packard Co., Boonton Radio Div.	Boonton, N. J.	17109	Thermonetics Inc.	Canoga Park, Calif.
02771	Vocaline Co. of America, Inc.	Old Saybrook, Conn.	08145	U. S. Engineering Co.	Los Angeles, Calif.	17474	Tranex Company	Mountain View, Calif.
02777	Hopkins Engineering Co.	San Fernando, Calif.	08289	Blinn, Delbert Co.	Pomona, Calif.	17675	Hamlin Metal Products Corp.	Akron, Ohio
03508	G. E. Semiconductor Prod. Dept.	Syracuse, N. Y.	08358	Burgess Battery Co.	Niagara Falls, Ontario, Canada	17745	Angstrom Prec. Inc.	No. Hollywood, Calif.
03705	Apex Machine & Tool Co.	Dayton, Ohio	08654	Bristol Co., The	Waterbury, Conn.	18042	Power Design Pacific Inc.	Palo Alto, Calif.
03797	Eldema Corp.	Compton, Calif.	08717	Sloan Company	Sun Valley, Calif.	18476	Toy-Car Mfg. Co., Inc.	Holliston, Mass.
03877	Transitron Electric Corp.	Wakefield, Mass.	08718	ITT Cannon Electric Inc., Phoenix Div.	Phoenix, Arizona	18486	TRW Elect. Comp. Div.	Des Plaines, Ill.
03888	Pyrofilm Resistor Co., Inc.	Cedar Knolls, N. J.	08792	CBS Electronics Semiconductor Operations, Div. of C. B. S. Inc.	Lowell, Mass.	18583	Curtis Instrument, Inc.	Mt. Kisco, N. Y.
03954	Singer Co., Diehl Div. Finnerle Plant	Somerville, N. J.	08984	Mel-Rain	Indianapolis, Ind.	18873	E. I. DuPont and Co., Inc.	Wilmington, Del.
04009	Arrow, Hart and Hegeman Elect. Co.	Hartford, Conn.	09026	Babcock Relays Div.	Costa Mesa, Calif.	18911	Durant Mfg. Co.	Milwaukee, Wis.
04013	Taurus Corp.	Lambertville, N. J.	09134	Texas Capacitor Co.	Houston, Texas	19315	Bendix Corp., The Eclipse-Pioneer Div.	Teterboro, N. J.
04222	Hi-Q Division of Aerovox	Myrtle Beach, S. C.	09145	Altoh Electronics	Sun Valley, Calif.	19500	Thomas A. Edison Industries, Div. of McGraw-Edison Co.	West Orange, N. J.
04354	Precision Paper Tube Co.	Chicago, Ill.	09250	Electro Assemblies, Inc.	Chicago, Ill.	19644	LRG Electronics	Horseheads, N. Y.
04404	Dymec Division of Hewlett-Packard Co.	Palo Alto, Calif.	09569	Mallory Battery Co. of Canada, Ltd.	Toronto, Ontario, Canada	19701	Electra Mfg. Co.	Independence, Kansas
04651	Sylvania Electric Products, Microwave Device Div.	Mountain View, Calif.	10214	General Transistor Western Corp.	Los Angeles, Calif.	20183	General Atronics Corp.	Philadelphia, Pa.
04713	Motorola, Inc., Semiconductor Prod. Div.	Phoenix, Arizona	10411	Ti-Tal, Inc.	Berkeley, Calif.	21226	Executone, Inc.	Long Island City, N. Y.
04732	Filttron Co., Inc. Western Div.	Culver City, Calif.	10646	Carborundum Co.	Niagara Falls, N. Y.	21335	Fafnir Bearing Co., The	New Britain, Conn.
04773	Automatic Electric Co.	Northlake, Ill.	11236	CTS of Berne, Inc.	Berne, Ind.	21520	Fansteel Metallurgical Corp.	N. Chicago, Ill.
04796	Sequoia Wire Co.	Redwood City, Calif.	11237	Chicago Telephone of California, Inc.	So. Pasadena, Calif.	23783	British Radio Electronics Ltd.	Washington, D. C.
04811	Precision Coil Spring Co.	El Monte, Calif.	11242	Bay State Electronics Corp.	Waltham, Mass.	24455	G. E. Lamp Division	
04870	P. M. Motor Company	Westchester, Ill.	11312	Teledyne Inc., Microwave Div.	Palo Alto, Calif.	24655	General Radio Co.	Nela Park, Cleveland, Ohio
05006	Twentieth Century Plastics, Inc.	Los Angeles, Calif.	11534	Duncan Electronics Inc.	Costa Mesa, Calif.	26365	Genies Reproducer Corp.	West Concord, Mass.
05277	Westinghouse Electric Corp. Semi-Conductor Dept.	Youngwood, Pa.	11711	General Instrument Corp., Semiconductor Div., Products Group	Newark, N. J.	26462	Grobet File Co. of America, Inc.	New Rochelle, N. Y.
05347	Ultronix, Inc.	San Mateo, Calif.	11717	Imperial Electronic, Inc.	Buena Park, Calif.			Carlstadt, N. J.
05593	Humitronic Engineering Co.	Sunnyvale, Calif.	11870	Melabs, Inc.	Palo Alto, Calif.	26992	Hamilton Watch Co.	Lancaster, Pa.
05616	Cosmo Plastic (c/o Electrical Spec. Co.)	Cleveland, Ohio	12136	Philadelphia Handle Co.	Camden, N. J.	28480	Hewlett-Packard Co.	Palo Alto, Calif.
05624	Barber Colman Co.	Rockford, Ill.	12697	Clarostat Mfg. Co.	Dover, N. H.	33173	G. E. Receiving Tube Dept.	Owensboro, Ky.
05728	Tiffen Optical Co.	Roslyn Heights, Long Island, N. Y.	12859	Nippon Electric Co., Ltd.	Tokyo, Japan	35434	Lectrohm Inc.	Chicago, Ill.
						36196	Stanwyck Coil Products Ltd.	Hawkesbury, Ontario, Canada
						37942	P. R. Mallory & Co. Inc.	Indianapolis, Ind.
						39543	Mechanical Industries Prod. Co.	Akron, Ohio
						40920	Miniature Precision Bearings, Inc.	Keene, N. H.
						42190	Muter Co.	Chicago, Ill.
						43990	C. A. Norgren Co.	Englewood, Colo.

From: FSC. Handbook Supplements
H4-1 Dated JULY 1965
H4-2 Dated NOV 1962

TABLE 6-3.
CODE LIST OF MANUFACTURERS (Continued)

Code No.	Manufacturer	Address	Code No.	Manufacturer	Address	Code No.	Manufacturer	Address
44655	Ohmite Mfg. Co.	Skokie, Ill.	72964	Robert M. Hadley Co.	Los Angeles, Calif.	80031	Mepco Division of Sessions Clock Co.	
46384	Penn Eng. & Mfg. Corp.	Doylestown, Pa.	72962	Erie Technological Products, Inc.	Erie, Pa.			Morristown, N.J.
47904	Polaroid Corp.	Cambridge, Mass.	73061	Hansen Mfg. Co., Inc.	Princeton, Ind.	80120	Schnitzer Alloy Products Co.	Elizabeth, N.J.
48620	Precision Thermometer & Inst. Co.		73076	H.M. Harper Co.	Chicago, Ill.	80130	Times Telephoto Equipment	New York, N.Y.
		Southampton, Pa.	73138	Helipot Div. of Beckman Inst., Inc.		80131	Electronic Industries Association. Any brand Tube meeting EIA Standards-Washington, DC.	
49956	Microwave & Power Tube Div.	Waltham, Mass.			Fullerton, Calif.	80207	Unimax Switch, Div. Maxon Electronics Corp.	
52090	Rowan Controller Co.	Westminster, Md.	73293	Hughes Products Division of Hughes Aircraft Co.	Newport Beach, Calif.			Wallingford, Conn.
52983	Sanborn Company	Waltham, Mass.	73445	Ampetex Electronic Co., Div. of North American Phillips Co., Inc.	Hicksville, N.Y.	80223	United Transformer Corp.	New York, N.Y.
54294	Shallcross Mfg. Co.	Selma, N.C.	73506	Bradley Semiconductor Corp.	New Haven, Conn.	80248	Oxford Electric Corp.	Chicago, Ill.
55026	Simpson Electric Co.	Chicago, Ill.	73559	Carling Electric, Inc.	Hartford, Conn.	80294	Bourns Inc.	Riverside, Calif.
55933	Sonetone Corp.	Elmsford, N.Y.	73682	George K. Garrett Co., Div. MSL Industries Inc.	Philadelphia, Pa.	80411	Acro Div. of Robertshaw Controls Co.	
55938	Raytheon Co. Commercial Apparatus & Systems Div.	So. Norwalk, Conn.	73734	Federal Screw Products Inc.	Chicago, Ill.	80486	All Star Products Inc.	Columbus, Ohio
56137	Spaulding Fibre Co., Inc.	Tonawanda, N.Y.	73743	Fischer Special Mfg. Co.	Cincinnati, Ohio	80509	Avery Adhesive Label Corp.	Monrovia, Calif.
56289	Sprague Electric Co.	North Adams, Mass.	73793	General Industries Co., The	Elyria, Ohio	80583	Hammarlund Co., Inc.	New York, N.Y.
59446	Telex, Inc.	St. Paul, Minn.	73846	Goshen Stamping & Tool Co.	Goshen, Ind.	80640	Stevens, Arnold, Co., Inc.	Boston, Mass.
59730	Thomas & Betts Co.	Elizabeth, N.J.	73899	JFD Electronics Corp.	Brooklyn, N.Y.	81030	International Instruments Inc.	Orange, Conn.
60741	Triplett Electrical Inst. Co.	Bluffton, Ohio	73905	Jennings Radio Mfg. Corp.	San Jose, Calif.	81073	Grayhill Co.	LaGrange, Ill.
61775	Union Switch and Signal, Div. of Westinghouse Air Brake Co.	Pittsburgh, Pa.	74276	Signalite Inc.	Neptune, N.J.	81095	Triad Transformer Corp.	Venice, Calif.
62119	Universal Electric Co.	Owosso, Mich.	74455	J. H. Winns, and Sons	Winchester, Mass.	81312	Winchester Elec. Div. Litton Ind., Inc.	Oakville, Conn.
63743	Ward-Leonard Electric Co.	Mt. Vernon, N.Y.	74861	Industrial Condenser Corp.	Chicago, Ill.	81349	Military Specification	
64959	Western Electric Co., Inc.	New York, N.Y.	74868	R. F. Products Division of Amphenol-Borg Electronics Corp.	Danbury, Conn.	81483	International Rectifier Corp.	El Segundo, Calif.
65092	Weston Inst. Inc. Weston-Newark	Newark, N.J.	74970	E. F. Johnson Co.	Waseca, Minn.	81541	Airpax Electronics, Inc.	Cambridge, Mass.
65295	Wittek Mfg. Co.	Chicago, Ill.	75042	International Resistance Co.	Philadelphia, Pa.	81860	Barry Controls, Div. Barry Wright Corp.	Watertown, Mass.
66346	Revere Wollansak Div. Minn. Mining & Mfg. Co.	St. Paul, Minn.	75378	CTS Knights Inc.	Sandwich, Ill.	82042	Carler Precision Electric Co.	Skokie, Ill.
70276	Allen Mfg. Co.	Hartford, Conn.	75382	Kulka Electric Corporation	Mt. Vernon, N.Y.	82047	Sperfi Faraday Inc., Copper Hewitt Electric Div.	Hoboken, N.J.
70318	Allmetal Screw Product Co., Inc.	Garden City, N.Y.	75818	Lenz Electric Mfg. Co.	Chicago, Ill.	82142	Jeffer's Electronics Division of Speer Carbon Co.	Du Bois, Pa.
70485	Atlantic India Rubber Works, Inc.	Chicago, Ill.	75915	Littelfuse, Inc.	Des Plaines, Ill.	82170	Fairchild Camera & Inst. Corp., Defense Prod. Division	Clifton, N.J.
70563	Amperite Co., Inc.	Union City, N.J.	76005	Lord Mfg. Co.	Erie, Pa.	82209	Maguire Industries, Inc.	Greenwich, Conn.
70903	Balden Mfg. Co.	Chicago, Ill.	76210	C. W. Marwedel	San Francisco, Calif.	82219	Sylvania Electric Prod. Inc. Electronic Tube Division	Emporium, Pa.
70998	Bird Electronic Corp.	Cleveland, Ohio	76487	James Millen Mfg. Co., Inc.	Malden, Mass.	82376	Astron Corp.	East Newark, Harrison, N.J.
71002	Birnback Radio Co.	New York, N.Y.	76493	J. W. Miller Co.	Los Angeles, Calif.	82389	Switchcraft, Inc.	Chicago, Ill.
71041	Boston Gear Works Div. of Murray Co. of Texas	Quincy, Mass.	76530	Cinch-Monadnock, Div. of United Carr Fastener Corp.	San Leandro, Calif.	82647	Metals & Controls Inc. Spencer Products	Attleboro, Mass.
71218	Bud Radio, Inc.	Willoughby, Ohio	76545	Mueller Electric Co.	Cleveland, Ohio	82768	Phillips-Advance Control Co.	Joliet, Ill.
71286	Camloc Fastener Corp.	Paramus, N.J.	76703	National Union	Newark, N.J.	82866	Research Products Corp.	Madison, Wis.
71313	Cardwell Condenser Corp.	Lindenhurst L.I., N.Y.	76854	Oak Manufacturing Co.	Crystal Lake, Ill.	82877	Rotron Mfg. Co., Inc.	Woodstock, N.Y.
71400	Bussmann Mfg. Div. of McGraw-Edison Co.	St. Louis, Mo.	77068	Bendix Corp., The Bendix Pacific Div.	N. Hollywood, Calif.	82893	Vector Electronic Co.	Glendale, Calif.
71436	Chicago Condenser Corp.	Chicago, Ill.	77075	Pacific Metals Co.	San Francisco, Calif.	83053	Western Washer Mfg. Co.	Los Angeles, Calif.
71447	Calif. Spring Co., Inc.	Pico-Rivera, Calif.	77221	Phanostran Instrument and Electronic Co.	South Pasadena, Calif.	83058	Carr Fastener Co.	Cambridge, Mass.
71450	CTS Corp.	Elkhart, Ind.	77252	Philadelphia Steel and Wire Corp.	Philadelphia, Pa.	83086	New Hampshire Ball Bearing, Inc.	Peterborough, N.H.
71468	ITT Cannon Electric Inc.	Los Angeles, Calif.	77342	American Machine & Foundry Co. Potter & Brumfield Div.	Princeton, Ind.	83125	General Instrument Corp., Capacitor Div.	Darlington, S.C.
71471	Cinema Plant, Hi-Q Div. Aerovox Corp.	Burbank, Calif.	77630	TRW Electronic Components Div.	Camden, N.J.	83148	ITT Wire and Cable Div.	Los Angeles, Calif.
71482	C.P. Clare & Co.	Chicago, Ill.	77638	General Instrument Corp., Rectifier Div.	Brooklyn, N.Y.	83186	Victory Engineering Corp.	Springfield, N.J.
71590	Centralab Div. of Globe Union Inc.	Milwaukee, Wis.	77764	Resistance Products Co.	Harrisburg, Pa.	83298	Bendix Corp., Red Bank Div.	Red Bank, N.J.
71616	Commercial Plastics Co.	Chicago, Ill.	77969	Rubbercraft Corp. of Calif.	Torrance, Calif.	83315	Hubbell Corp.	Mundelein, Ill.
71700	Cornish Wire Co., The	New York, N.Y.	78189	Shakeproof Division of Illinois Tool Works	Elgin, Ill.	83330	Smith, Heiman H., Inc.	Brooklyn, N.Y.
71707	Coto Coil Co., Inc.	Providence, R.I.	78283	Signal Indicator Corp.	New York, N.Y.	83385	Central Screw Co.	Chicago, Ill.
71744	Chicago Miniature Lamp Works	Chicago, Ill.	78290	Struthers-Dunn Inc.	Pitman, N.J.	83501	Gavitt Wire and Cable Co. Div. of Amerace Corp.	Brookfield, Mass.
71753	A.O. Smith Corp., Crowley Div.	West Orange, N.J.	78452	Thompson-Bremer & Co.	Chicago, Ill.	83594	Burroughs Corp. Electronic Tube Div.	
71785	Cinch Mfg. Co., Howard B. Jones Div.	Chicago, Ill.	78471	Tilley Mfg. Co.	San Francisco, Calif.			Plainfield, N.J.
71984	Dow Corning Corp.	Midland, Mich.	78488	Stackpole Carbon Co.	St. Marys, Pa.	83740	Union Carbide Corp. Consumer Prod. Div.	New York, N.Y.
72136	Electro Motive Mfg. Co., Inc. Williamant, Conn.	Williamant, Conn.	78493	Standard Thomson Corp.	Waltham, Mass.			Huntington, Ind.
72354	John E. Fast Co., Div. Victoreen Instr. Co.	Chicago, Ill.	78553	Tinnerman Products, Inc.	Cleveland, Ohio	83777	Model Eng. and Mfg., Inc.	Festus, Mo.
		Chicago, Ill.	78790	Transformer Engineers	San Gabriel, Calif.	83942	Aeronautical Inst. & Radio Co.	Lodi, N.J.
72619	Dialight Corp.	Brooklyn, N.Y.	78947	Ucinite Co.	Newtonville, Mass.	84171	Arco Electronics Inc.	Great Neck, N.Y.
72656	Indiana General Corp., Electronics Div.	Keasby, N.J.	79136	Waldes Kohinoor Inc.	Long Island City, N.Y.	84396	A. J. Glesener Co., Inc.	San Francisco, Calif.
		Keasby, N.J.	79142	Veeder Root, Inc.	Hartford, Conn.	84411	TRW Capacitor Div.	Ogallala, Neb.
72699	General Instrument Corp., Cap. Div.	Newark, N.J.	79251	Wenco Mfg. Co.	Chicago, Ill.	84970	Sarkes Tarzian, Inc.	Bloomington, Ind.
72765	Drake Mfg. Co.	Chicago, Ill.	79272	Continental-Wirt Electronics Corp.	Philadelphia, Pa.	85454	Boonton Molding Company	Boonton, N.J.
72825	Hugh H. Eby Inc.	Philadelphia, Pa.	79963	Zierick Mfg. Corp.	New Rochelle, N.Y.			
72928	Gudeman Co.	Chicago, Ill.						

APPENDIX OPTION 01-02

The 415E-Option 01 instrument consists of a standard Model 415E SWR Meter with a battery installed allowing either AC Line-or portable-operation of the instrument. The 415E-Option 02 Instrument consists of a standard Model 415E SWR Meter with a rear panel INPUT connector installed and wired in parallel with the front panel connector; Either INPUT connector may be used at any one time. A Model 415E which is designated as 415E-Option 01-02 is merely an instrument with both the rear panel connector and the internal battery installed. Paragraph 3-8 explains operation of the instrument with a battery installed.

A list of component parts required for/or included with installation in your instrument is included on the next to last page of Table 6-1 in this manual. Instructions for installation or removal of either or both of these instrument options are given below.

INSTALLATION PROCEDURE.

1. OPTION 01

- a. Set POWER switch to OFF and remove power plug from 415E.
- b. Remove top and bottom instrument covers.

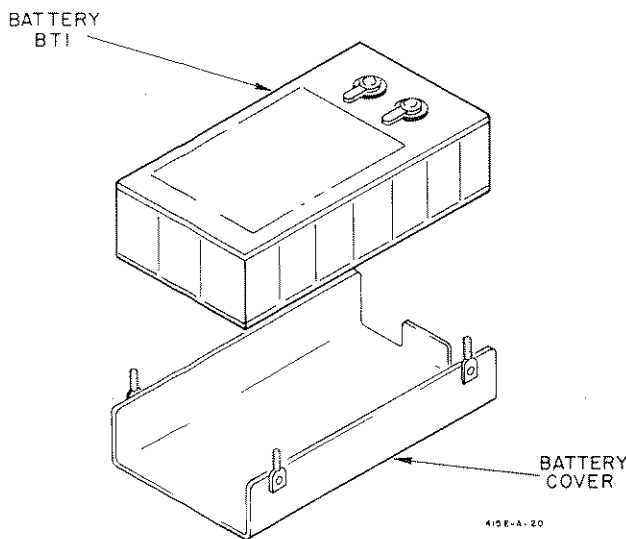

Figure I-1. Battery-Cover Assembly

- c. Refer to Figure I-1 which shows the cover and battery disassembled and install from bottom of instrument into the top deck. Note: The battery should be installed so that the two battery terminals are toward the top and front of the instrument.

- d. Using the four retaining nuts, fasten the battery cover tightly in place.

CAUTION

DO NOT SHORT BATTERY TERMINALS AT ANY TIME AS THIS MAY CAUSE BATTERY CELL DAMAGE.

- e. Using a low heat soldering iron (See Table 5-3), solder a red lead wire (#22 gauge, stranded) between the + battery terminal and the circuit board socket terminal marked BATT +.

- f. Solder a black lead wire (#22 gauge, stranded) between the negative battery terminal and the circuit board socket terminal marked BATT -.

- g. Removal is the reverse of installation.

2. OPTION 02

- a. Refer to Figure I-2 which shows the proper assembly of the rear panel lug connector and cable assembly.

- b. The shielded cable ground for the rear panel connector must be connected to the front panel INPUT ground to minimize noise pickup and signal reference problems.

- c. The center conductor must be connected to RANGE-DB switch, A1S1, at the same point as the green wire leading to the front panel BNC input connector.

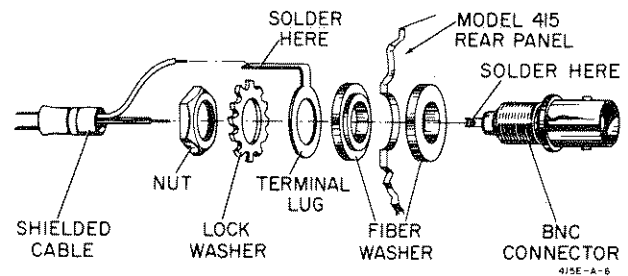

Figure I-2. Connector Assembly

MAINTENANCE OF THE RECHARGEABLE NICKEL CADMIUM BATTERY

The maintenance of the rechargeable Nickel Cadmium battery poses two problems, both of which pertain to recharging the battery.

The first problem concerns damage to the battery because of improper maintenance. Damage during operation and storage will reduce the number of charging cycles and therefore the life of the battery.

The second problem concerns that of thermal runaway. As the Nickel Cadmium battery heats due to the charging current, the battery terminal voltage drops. The charging current will then increase if the recharging circuit consists of a constant voltage source. This thermal runaway will result in destruction of the battery. This problem, however, is alleviated in Hewlett-Packard instruments because a constant current source provides battery recharge.

Maintenance of the Nickel Cadmium battery can be summarized with several DO NOT's.

1. Do not allow the battery to discharge below 6 volts per 5 cell battery (1.2 volts per cell). This will prevent reverse charging of one or more cells.
2. Do not fast charge for periods exceeding 75 hours because excessive heat generated may shorten battery life. Typical charging rates are a trickle charge of 4 mA to 7 mA and a fast charge rate of 16 mA to 18 mA, where applicable. The battery may be charged at a trickle rate indefinitely.
3. Do not charge the batteries in an environment with temperatures above 95°F (35°C) or below 32°F (0°C). Whenever possible, charge the battery at moderate temperatures (70°F ±10°F, 21°C ±5.6°C). Operation of the battery in the same moderate temperatures as for battery charging will provide maximum performance.
4. Do not store the battery at temperatures above 122°F (50°C) or below -4°F (-20°C). Prolonged storage (90 days under ideal conditions) may require three to five charge-discharge cycles to reach full capacity.
5. Do not short-circuit the battery because the exceedingly low internal resistance will allow discharge at extremely high current levels. This will result in battery damage.

APPENDIX II

Backdating information for Model 415E with Serials Prefixed 530-.

- 1) Substitute the component locations in Figure 1-1.
- 2) Page 5-19, Figure 5-11; A3R6: change to 215 ohms*
 Page 5-21, Figure 5-12; A3R33 and A3R34: change to 15.4 K ohms*
 A3R21: change to 316 ohms*

Table 6-1; A3R6: change to 0698-3441; R: fxd met flm 215 ohm 1% 1/8W
 A3R21: change to 0698-3444; R: fxd met flm 316 ohm 1% 1/8W
 A3R33, and A3R34: change to 0698-3540; R: fxd met flm 15.4 Kohms 1% 1/8W

Table 6-2; Add: 0698-3540 R: fxd met flm 15.4 K ohm 1% 1/8W; Mfr 28480; TQ 2
 Delete: 0698-5001 R: fxd met flm 15.2 K ohm 1% 1/8W; Mfr 28480; TQ 2

* Factory selected part. Average value shown.

Backdating information for Model 415E with serials prefixed 530- and 545-.

Instruments serial prefixed 530 and 545 contain the following component differences:

A3C1	0160-0174	C:FXD ELECT 2.2 μ F +80-20% 25 VDCW
A3R22	0698-3260	R:FXD MET FLM 464K 1% 1/8W

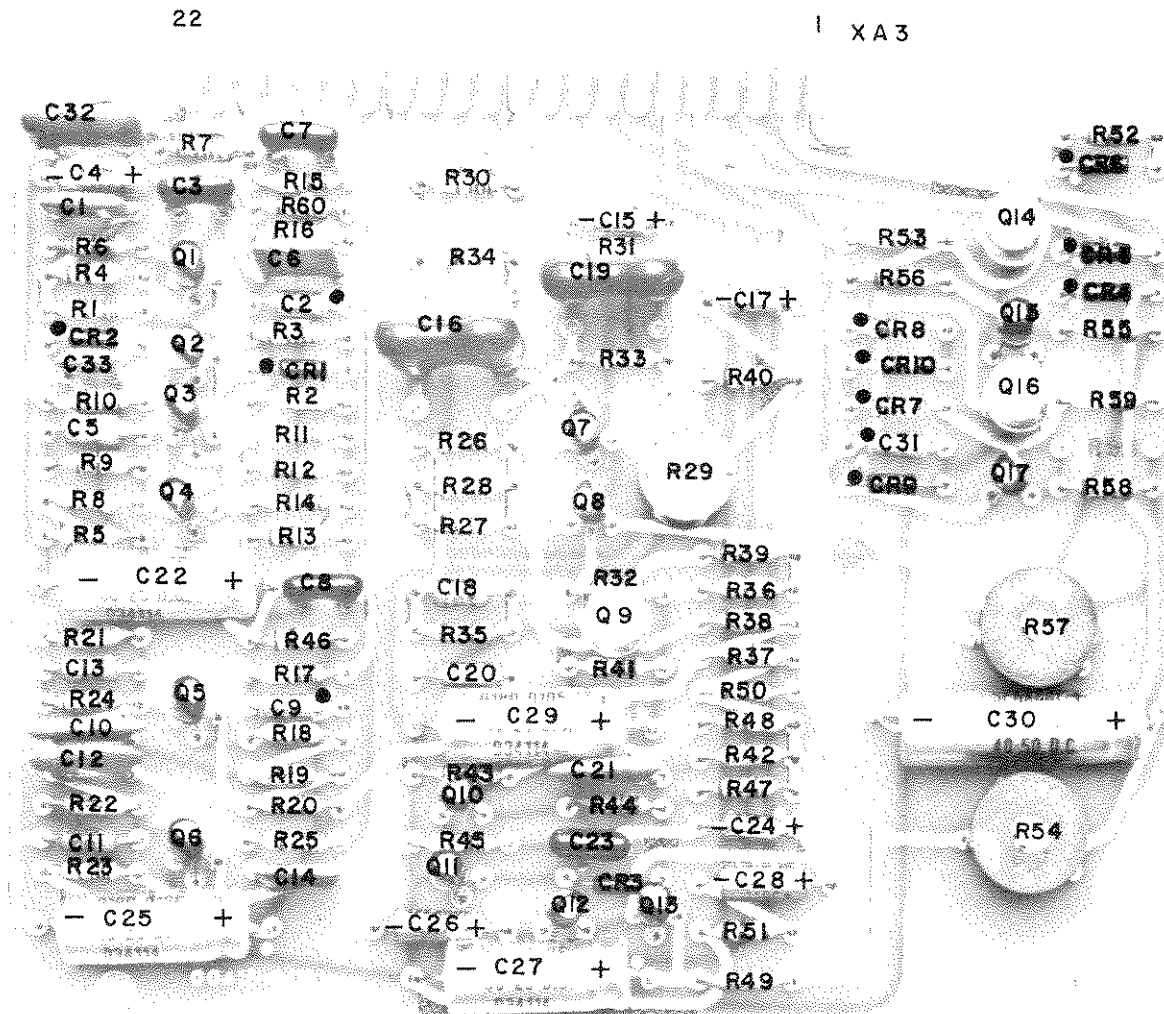

415E-A-24

Figure I-1. Circuit Board Component Location for Instruments with serials prefixed 530-



ELECTRONIC INSTRUMENTATION SALES AND SERVICE

UNITED STATES

ALABAMA
P.O. Box 4207
2003 Byrd Spring Road S.W.
Huntsville 35802
Tel: (205) 881-4591
TWX: 810-726-2204

ARIZONA
3099 North Scottsdale Road
Scottsdale 85251
Tel: (602) 945-7801
TWX: 910-950-1282

232 South Tucson Boulevard
Tucson 85716
Tel: (602) 623-2564
TWX: 910-952-1162

CALIFORNIA
3939 Lankershim Boulevard
North Hollywood 91604
Tel: (213) 877-1282
TWX: 910-499-2170

1101 Embarcadero Road
Palo Alto 94303
Tel: (415) 327-6500
TWX: 910-373-1280

2591 Carlsbad Avenue
Sacramento 95821
Tel: (916) 482-1463
TWX: 910-367-2092

1055 Shafter Street
San Diego 92106
Tel: (714) 223-8103
TWX: 910-335-2000

COLORADO
7955 East Prentice
Englewood 80110
Tel: (303) 771-3455
TWX: 910-935-0705

CONNECTICUT
508 Tolland Street
East Hartford 06108
Tel: (203) 289-9394
TWX: 710-425-3416

111 East Avenue
Norwalk 06851
Tel: (203) 853-1251
TWX: 710-468-3750

DELAWARE
3941 Kennett Pike
Wilmington 19807
Tel: (302) 655-6161
TWX: 510-666-2214

FLORIDA
Suite 106
9999 N.E. 2nd Avenue
Miami Shores 33138
Tel: (305) 758-3626
TWX: 810-848-7262

P.O. Box 20007
Herndon Station 32814
621 Commonwealth Avenue
Orlando
Tel: (305) 841-3970
TWX: 810-850-0113

P.O. Box 8128
Madeira Beach 33708
410 150th Avenue
St. Petersburg
Tel: (813) 391-0211
TWX: 810-863-0366

GEORGIA
P.O. Box 28234
2340 Interstate Parkway
Atlanta 30328
Tel: (404) 436-6181
TWX: 810-766-4890

ILLINOIS
5500 Howard Street
Skokie 60076
Tel: (312) 677-0400
TWX: 910-223-3613

INDIANA
4002 Meadows Drive
Indianapolis 46205
Tel: (317) 546-4891
TWX: 810-341-3263

LOUISIANA
P.O. Box 856
1942 Williams Boulevard
Kenner 70062
Tel: (504) 721-6201
TWX: 810-955-5524

MARYLAND
6707 Whitestone Road
Baltimore 21207
Tel: (301) 944-5400
TWX: 710-862-0850

P.O. Box 727
Twinbrook Station 20851
12303 Twinbrook Parkway
Rockville
Tel: (301) 427-7560
TWX: 710-828-9684

MASSACHUSETTS
Middlesex Turnpike
Burlington 01803
Tel: (617) 272-9000
TWX: 710-332-0382

MICHIGAN
24315 Northwestern Highway
Southfield 48075
Tel: (313) 353-9100
TWX: 810-232-1532

MINNESOTA
2459 University Avenue
St. Paul 55114
Tel: (612) 645-9461
TWX: 910-563-3734

MISSOURI
9208 Wyoming Place
Kansas City 64114
Tel: (816) 333-2445
TWX: 910-771-2087

2812 South Brentwood Blvd.
St. Louis 63144
Tel: (314) 644-0220
TWX: 910-760-1670

NEW JERSEY
391 Grand Avenue
Englewood 07631
Tel: (201) 567-3933
TWX: 710-991-9707

NEW MEXICO
P.O. Box 8366
Station C 87108
6501 Lomas Boulevard N.E.
Albuquerque
Tel: (505) 255-5586
TWX: 910-989-1665

156 Wyatt Drive
Las Cruces 88001
Tel: (505) 526-2485
TWX: 910-983-0550

NEW YORK
1702 Central Avenue
Albany 12205
Tel: (518) 869-8462

1219 Campville Road
Endicott 13760
Tel: (607) 754-0050
TWX: 510-252-0890

236 East 75th Street
New York 10021
Tel: (212) 879-2023
TWX: 710-581-4376

82 Washington Street
Poughkeepsie 12601
Tel: (914) 454-7330
TWX: 510-248-0012

39 Saginaw Drive
Rochester 14623
Tel: (716) 473-9500
TWX: 510-253-5981

1025 Northern Boulevard
Roslyn, Long Island 11576
Tel: (516) 869-8400
TWX: 510-223-0811

5858 East Molloy Road
Syracuse 13211
Tel: (315) 454-2486
TWX: 710-541-0482

NORTH CAROLINA
P.O. Box 5187
1923 North Main Street
High Point 27262
Tel: (919) 882-6873
TWX: 510-926-1516

OHIO
5579 Pearl Road
Cleveland 44129
Tel: (216) 884-9209
TWX: 810-421-8500

2460 South Dixie Drive
Dayton 45439
Tel: (513) 298-0351
TWX: 810-459-1925

OREGON
Westhills Mall, Suite 158
4475 S.W. Scholls Ferry Road
Portland 97225
Tel: (503) 292-9171
TWX: 910-464-6103

PENNSYLVANIA
2500 Moss Side Boulevard
Monroeville 15146
Tel: (412) 271-0724
TWX: 710-797-3650

144 Elizabeth Street
West Conshohocken 19428
Tel: (215) 248-1600, 828-6200
TWX: 510-660-8715

TEXAS
P.O. Box 7166
3605 Inwood Road
Dallas 75209
Tel: (214) 357-1881
TWX: 910-861-4081

P.O. Box 22813
4242 Richmond Avenue
Houston 77027
Tel: (713) 667-2407
TWX: 910-881-2645

GOVERNMENT CONTRACT OFFICE
225 Billy Mitchell Road
San Antonio 78226
Tel: (512) 434-4171
TWX: 910-871-1170

UTAH
2890 South Main Street
Salt Lake City 84115
Tel: (801) 486-8166
TWX: 910-925-5681

VIRGINIA
P.O. Box 6514
2111 Spencer Road
Richmond 23230
Tel: (703) 282-5451
TWX: 710-956-0157

WASHINGTON
11656 N.E. Eighth Street
Bellevue 98004
Tel: (206) 454-3971
TWX: 910-443-2303

FOR AREAS NOT LISTED, CONTACT: Hewlett-Packard; 1501 Page Mill Road; Palo Alto, California 94304; Tel: (415) 326-7000; TWX: 910-373-1267; Telex: 34-8461

CANADA

ALBERTA
10010 - 105th Street
Edmonton
Tel: (403) 424-0718
TWX: 610-831-2431

BRITISH COLUMBIA
Hewlett-Packard (Canada) Ltd.
2184 West Broadway
Vancouver
Tel: (604) 738-7520
TWX: 610-922-5050

NOVA SCOTIA
7001 Mumford Road
Suite 356
Halifax
Tel: (902) 455-0511
TWX: 610-271-4482

ONTARIO
Hewlett-Packard (Canada) Ltd.
880 Lady Ellen Place
Ottawa 3
Tel: (613) 722-4223
TWX: 610-562-1952

Hewlett-Packard (Canada) Ltd.
1415 Lawrence Avenue West
Toronto
Tel: (416) 249-9196
TWX: 610-492-2382

QUEBEC
Hewlett-Packard (Canada) Ltd.
275 Hymus Boulevard
Pointe Claire
Tel: (514) 697-4232
TWX: 610-422-3022
Telex: 01-2819

FOR AREAS NOT LISTED, CONTACT: Hewlett-Packard Inter-Americas; 1501 Page Mill Road; Palo Alto, Calif. 94304; Tel: (415) 326-7000; TWX: 910-373-1267; Telex: 034-8461; Cable: HEWPACK Palo Alto

CENTRAL AND SOUTH AMERICA

ARGENTINA
Mauricio A. Suárez
Telecomunicaciones
Carlos Calvo 224
Buenos Aires
Tel: 30-6312, 34-9087
Cable: TELEPILOT Buenos Aires

BRAZIL
Ciental, Importacao e
Comercio Ltda.
Avenida 13 de Maio, 13-22° andar
Rio de Janeiro G.B.
Tel: 42-9483

Ciental, Importacao e
Comercio Ltda.
Rua Des. Eliseu Guilherme, 62
Sao Paulo 8
Tel: 70-2318
Cable: CIENTALCO, Sao Paulo

CHILE
Héctor Calcaeni
Casilla 13942
Santiago
Tel: 490.505, 393.119

COLOMBIA
Instrumentacion
Henrik A. Langebaek & Cia. Ltda.
Cra. 7A N° 48-51/59
Apartado Aereo 6287
Bogota, 1 D.E.
Tel: 45-78-06, 45-55-46
Cable: AARIS Bogota

COSTA RICA
Lic. Alfredo Gallegos Gudián
Apartado 3243
San José
Tel: 21-86-13
Cable: GALGUR San José

ECUADOR
Laboratorios de Radio-Ingeniería
Calle Guayaquil 1246
Post Office Box 3199
Quito
Tel: 12496
Cable: HORVATH Quito

EL SALVADOR
Electrónica
27 Avenida Norte 1133
Apartado Postal 1589
San Salvador
Tel: 25-74-50
Cable: ELECTRONICA
San Salvador

GUATEMALA
Olander Associates Latin America
Apartado 1226
7a. Calle, 0-22, Zona 1
Guatemala City
Tel: 22812
Cable: OLALA Guatemala City

MEXICO
Hewlett-Packard Mexicana,
S.A. de C.V.
Eugenia 408, Dept. 1
México 12, D.F.
Tel: 43-03-79

NICARAGUA
Roberto Terán G.
Edificio Terán
Apartado Postal 689
Managua
Tel: 3451, 3452
Cable: ROTERAN Managua

PANAMA
Electrónica Balboa, S.A.
P.O. Box 4929
Ave. Manuel Espinosa No. 13-50
Bldg. Alina
Panama City
Tel: 30833
Cable: ELECTRON Panama City

PERU
Fernando Ezeta B.
Av. Petit Thouars 4719
Miraflores
Casilla 3061
Lima
Tel: 50345
Cable: FEPERU Lima

PUERTO RICO
San Juan Electronics, Inc.
P.O. Box 5167
Ponce de Leon 150, Stop 3
Puerta de Tierra Santa
San Juan 00906
Tel: (809) 725-3342
Cable: SATRONICS San Juan

URUGUAY
Pablo Ferrando
S.A. Comercial e Industrial
Avenida Italia 2877
Casilla de Correo 370
Montevideo
Tel: 40-3102
Cable: RADIUM Montevideo

VENEZUELA
Citec, C.A.
Edif. Arisan-Of. #4
Avda. Francisco de Miranda
Apartado del Este 10934 Chacaito
Caracas
Tel: 71.88.05
Cable: CITECAL Caracas

FOR AREAS NOT LISTED, CONTACT: Hewlett-Packard Inter-Americas; 1501 Page Mill Road; Palo Alto, Calif. 94304; Tel: (415) 326-7000; TWX: 910-373-1267; Telex: 034-8461; Cable: HEWPACK Palo Alto



ELECTRONIC INSTRUMENTATION SALES AND SERVICE

EUROPE

AUSTRIA

Unilabor H.m.b.H.
Wissenschaftliche Instrumente
Rummelhardtgasse 6/3
P.O. Box 33
Vienna IX/71
Tel: 426 181
Cable: LABORINSTRUMENT
Vienna

BELGIUM

Hewlett-Packard Benelux S.A.
20-24 rue de l'Hôpital
Brussels
Tel: 11 22 20
Cable: PALOBEN Brussels

DENMARK

Tage Olsen A/S
Rønnegade 1
Copenhagen o
Tel: 29 48 00
Cable: TOCOPEN Copenhagen

FINLAND

INTO O/Y
Meritulinkatu 11
P.O. Box 10153
Helsinki 10
Tel: 61 133
Cable: INTO Helsinki

FRANCE

Hewlett-Packard France
2 rue Tête d'Or
Lyon, 6 - Rhône
Tel: 52 35 66
Hewlett-Packard France
150 Boulevard Massena
Paris 13e
Tel: 707 97 19
Cable: HEWPACK Paris

GERMANY

Hewlett-Packard Vertriebs-GmbH
Lietzenburger Strasse 30
1 Berlin W 30
Tel: 07031-6971
Cable: HEPAG Boblingen

Hewlett-Packard Vertriebs-GmbH
Herrnberger Strasse 110
703 Böblingen, Württemberg
Tel: 07031-6971
Cable: HEPAG Boblingen

Hewlett-Packard Vertriebs-GmbH
Achenbachstrasse 15
4 Düsseldorf 1
Tel: 68 52 58/59

Hewlett-Packard Vertriebs-GmbH

Kurhessenstrasse 95
6 Frankfurt 50
Tel: 52 00 36
Cable: HEWPACKSA Frankfurt

Hewlett-Packard Vertriebs-GmbH
Beim Strohhaue 26
2 Hamburg 1
Tel: 24 05 51/52
Cable: HEWPACKSA Hamburg

Hewlett-Packard Vertriebs-GmbH
Reginfriedstrasse 13
8 Munich 9
Tel: 69 51 21/22
Cable: HEWPACKSA Munich

GREECE

Kostos Karayannis
18, Ermou Street
Athens 126
Tel: 230 301
Cable: RAKAR Athens

IRELAND

Hewlett-Packard Ltd.
224 Bath Road
Slough, Bucks, England
Tel: Slough 28406-9, 29486-9
Cable: HEWPIE Slough

ITALY

Hewlett-Packard Italiana S.p.A.
Viale Lunigiana 46
Milan
Tel: 69 15 84
Cable: HEWPACIT Milan

Hewlett-Packard Italiana S.p.A.
Palazzo Italia
Piazza Marconi 25
Rome - Eur
Tel: 591 2544
Cable: HEWPACIT Rome

NETHERLANDS

Hewlett-Packard Benelux, N.V.
de Boelelaan 1043
Amsterdam, Z.2
Tel: 42 77 77
Cable: PALOBEN Amsterdam

NORWAY

Morgenstjerne & Co. A/S
Ingeniofirma
6 Wessels Gate
Oslo
Tel: 20 16 35
Cable: MOROF Oslo

PORTUGAL

Telectra
Rua Rodrigo da Fonseca 103
P.O. Box 2531
Lisbon 1
Tel: 68 60 72
Cable: TELECTRA Lisbon

SPAIN

Ataio Ingerieros
Urgel, 259
Barcelona, 11
Tel: 230-69-88
Ataio Ingenieros
Enrique Larreta 12
Madrid, 16
Tel: 235 43 44
Cable: TELEATAIO Madrid

SWEDEN

HP Instrument AB
Hagakergatan 7
Mölnadal
Tel: 031 - 27 68 00
HP Instrument AB
Centralvägen 28
Solna
Tel: 08 - 83 08 30
Cable: MEASUREMENTS
Stockholm

SWITZERLAND

HEWPAK AG
Zürcherstrasse
8952 Schlieren
Zurich
Tel: (051) 98 18 21
Cable: HEWPACKAG Zurich

TURKEY

Telekom Engineering Bureau
P.O. Box 376 - Galata
Istanbul
Tel: 49 40 40
Cable: TELEMATION Istanbul

UNITED KINGDOM

Hewlett-Packard Ltd.
224 Bath Road
Slough, Bucks
Tel: Slough 28406-9, 29486-9
Cable: HEWPIE Slough

YUGOSLAVIA

Belram S.A.
83 avenue des Mimosas
Brussels 15, Belgium
Tel: 35 29 58
Cable: BELRAMEL Brussels

FOR AREAS NOT LISTED, CONTACT: Hewlett-Packard S.A.; 54 Route des Acacias; Geneva, Switzerland; Tel: (022) 42 81 50; Telex: 2.24.86; Cable: HEWPACKSA Geneva

AFRICA, ASIA, AUSTRALIA

AUSTRALIA

Hewlett-Packard Australia
Pty. Ltd.
22-26 Weir Street
Glen Iris, S. E. 6
Victoria
Tel: 20-1371 (4 lines)
Cable: HEWPAK Melbourne

Hewlett-Packard Australia
Pty. Ltd.
4 Grose Street
Glebe, New South Wales
Tel: 211-2235, 211-2888
Cable: HEWPAK Sydney

CEYLON

United Electricals Ltd.
P.O. Box 681
Yahala Building
Staples Street
Colombo 2
Tel: 5496
Cable: HOTPOINT Colombo

ETHIOPIA

African Salespower & Agency
Private Ltd., Co.
P. O. Box 718
Addis Ababa
Tel: 44090
Cable: ASACO Addisababa

HONG KONG

Schmidt & Co. (Hong Kong) Ltd.
P.O. Box 297
1511, Prince's Building
10, Chater Road
Hong Kong
Tel: 240168, 232735
Cable: SCHMIDTCO Hong Kong

INDIA

The Scientific Instrument
Co., Ltd.
6, Tej Bahadur Sapru Road
Allahabad 1
Tel: 2451
Cable: SICO Allahbad

The Scientific Instrument

Co., Ltd.
240, Dr. Dadabhai Naoroji Road
Bombay 1
Tel: 26-2642
Cable: SICO Bombay

The Scientific Instrument

Co., Ltd.
11, Esplanade East
Calcutta 1
Tel: 23-4129
Cable: SICO Calcutta

The Scientific Instrument Co., Ltd.
30, Mount Road
Madras 2
Tel: 86339
Cable: SICO Madras

The Scientific Instrument Co., Ltd.
B-7, Ajmeri Gate Extn.
New Delhi 1
Tel: 27-1053
Cable: SICO New Delhi

IRAN

Telecom, Ltd.
P. O. Box 1812
Teheran
Tel: 43850, 48111
Cable: BASCOM Teheran

ISRAEL

Electronics & Engineering
Div. of Motorola Israel Ltd.
16, Kremenski Street
Tel-Aviv
Tel: 35021/2/3
Cable: BASTEL Tel-Aviv

JAPAN

Yokogawa-Hewlett-Packard Ltd.
Shinbanyu Building
No. 8, Umeda
Kita-ku, Osaka City
Tel: 0726-23-1641

Yokogawa-Hewlett-Packard Ltd.
Ito Building
No. 59, Kotori-cho
Nakamura-ku, Nagoya City
Tel: 551-0215

Yokogawa-Hewlett-Packard Ltd.
Ohashi Building
No. 59, I-chome, Yoyogi
Shibuya-ku, Tokyo
Tel: 370-2281
Cable: YOKOHEWPAK Tokyo
Telex: 232-2034

KENYA

R. J. Tilbury Ltd.
P. O. Box 2754
Suite 517/518
Hotel Ambassadeur
Nairobi
Tel: 25670, 26803, 68206
Cable: ARIAYTEE Nairobi

KOREA

American Trading Co., Korea, Ltd.
Seoul P. O. Box 1103
112-35 Sokong-Dong
Jung-ku, Seoul
Tel: 3,7049, 3,7613
Cable: AMTRACO Seoul

LEBANON

Constantin E. Macridis
Clemenceau Street
Clemenceau Center
Beirut
Tel: 220846
Cable: ELECTRONUCLEAR Beirut

MALAYSIA

MECOMB Malaysia Ltd.
2 Lorong 13/6A
Section 13
Petaling Jaya, Selangor
Cable: MECOMB Kuala Lumpur

NEW ZEALAND

Sample Electronics (N.Z.) Ltd.
8 Matipo Street
Onehunga S.E. 5
Auckland
Tel: 667-356
Cable: ELPMAS Auckland

PAKISTAN (EAST)

Mushko & Company, Ltd.
31, Jinnah Avenue
Dacca
Tel: 80058
Cable: COOPERATOR Dacca

PAKISTAN (WEST)

Mushko & Company, Ltd.
Oosman Chambers
Victoria Road
Karachi 3
Tel: 51027, 52927
Cable: COOPERATOR Karachi

SINGAPORE

Mechanical and Combustion
Engineering Company Ltd.
9, Jalan Kilang
Singapore, 3
Tel: 642361-3
Cable: MECOMB Singapore

SOUTH AFRICA

F. H. Flanter & Co. (Pty.), Ltd.
Rosella House
Buitencingle Street
Cape Town
Tel: 3-3817
Cable: AUTOPHONE Cape Town

F. H. Flanter & Co. (Pty.), Ltd.
104 Pharmacy House
80 Jorissen Street
Braamfontein, Johannesburg
Tel: 724-4172

TAIWAN

Hwa Sheng Electronic Co., Ltd.
P. O. Box 1558
21 Nanking West Road
Taipei
Tel: 46076, 45936
Cable: VICTRONIX Taipei

THAILAND

The International
Engineering Co., Ltd.
P. O. Box 39
614 Sukhumvit Road
Bangkok
Tel: 913460-1-2
Cable: GYSOM Bangkok

VIETNAM

Landis Brothers and Company,
Inc.
P. O. Box H-3
216 Hien-Yuong
Saigon
Tel: 20.805
Cable: LANBROCOMP Saigon

FOR AREAS NOT LISTED, CONTACT: Hewlett-Packard Export Marketing; 1501 Page Mill Road; Palo Alto, California 94304; Tel: (415) 326-7000; Telex: 034-8461; Cable: HEWPACK Palo Alto

Free Manuals Download Website

<http://myh66.com>

<http://usermanuals.us>

<http://www.somanuals.com>

<http://www.4manuals.cc>

<http://www.manual-lib.com>

<http://www.404manual.com>

<http://www.luxmanual.com>

<http://aubethermostatmanual.com>

Golf course search by state

<http://golfingnear.com>

Email search by domain

<http://emailbydomain.com>

Auto manuals search

<http://auto.somanuals.com>

TV manuals search

<http://tv.somanuals.com>