



OPERATING AND PROGRAMMING MANUAL

**MODEL 54110D
COLOR
DIGITIZING OSCILLOSCOPE**

©COPYRIGHT HEWLETT-PACKARD/COLORADO SPRINGS DIVISION
1900 GARDEN OF THE GODS ROAD, COLORADO SPRINGS, COLORADO U.S.A.

ALL RIGHTS RESERVED

Manual Part No. 54110-90901
Microfiche Part No. 54110-90801

PRINTED: NOVEMBER 1985

SAFETY

This product has been designed and tested according to International Safety Requirements. To ensure safe operation and to keep the product safe, the information, cautions, and warnings in this manual, must be heeded. Refer to Section 1 and the Safety Summary for general safety considerations applicable to this product.

This apparatus has been designed and tested in accordance with IEC publication 348, safety requirements for electronic measuring apparatus, and has been supplied in a safe condition. This manual contains some information and warnings which have to be followed by the user to ensure safe operation and to retain the apparatus in safe condition.

CERTIFICATION

Hewlett-Packard Company certifies that this product met its published specifications at the time of shipment from the factory. Hewlett-Packard further certifies that its calibration measurements are traceable to the United States National Bureau of Standards, to the extent allowed by the Bureau's calibration facility, and to the calibration facilities of other International Standards Organization members.

WARRANTY

This Hewlett-Packard product is warranted against defects in material and workmanship for a period of one year from date of shipment. During the warranty period, Hewlett-Packard Company will, at its option, either repair or replace products which prove to be defective.

For warranty service or repair, this product must be returned to a service facility designated by HP. However, warranty service for products installed by HP and certain other products designated by HP will be performed at Buyer's facility at no charge within the HP service travel area. Outside HP service travel areas, warranty service will be performed at Buyer's facility only upon HP's prior agreement and Buyer shall pay HP's round trip travel expenses.

For products returned to HP for warranty service, Buyer shall prepay shipping charges to HP and HP shall pay shipping charges to return the product to Buyer. However, Buyer shall pay all shipping charges, duties, and taxes for products returned to HP from another country.

LIMITATION OF WARRANTY

The foregoing warranty shall not apply to defects resulting from improper or inadequate maintenance by Buyer, Buyer-supplied software or interfacing, unauthorized modification or misuse, operation outside of the environmental specifications for the product, or improper site preparation or maintenance.

NO OTHER WARRANTY IS EXPRESSED OR IMPLIED. HP SPECIFICALLY DISCLAIMS THE IMPLIED WARRANTIES OR MERCHANTABILITY AND FITNESS FOR A PARTICULAR PURPOSE.

EXCLUSIVE REMEDIES

THE REMEDIES PROVIDED HEREIN ARE BUYER'S SOLE AND EXCLUSIVE REMEDIES. HP SHALL NOT BE LIABLE FOR ANY DIRECT, INDIRECT, SPECIAL INCIDENTAL, OR CONSEQUENTIAL DAMAGES, WHETHER BASED ON CONTRACT, TORT, OR ANY OTHER LEGAL THEORY.

ASSISTANCE

Product maintenance agreements and other customer assistance agreements are available for Hewlett-Packard products.

For any assistance, contact your nearest Hewlett-Packard Sales and Service Office. Addresses are provided at the back of this manual.

SCWA984

X-RAY RADIATION NOTICE

ACHTUNG

Model 54110D

WARNING

Während des Betriebs erzeugt dieses Gerät Röntgenstrahlung. Das Gerät ist so abgeschirmt, daß die Dosisleistung weniger als 36 $\mu\text{A}/\text{kg}$ (0.5 mR/h) in 5cm Abstand von der Oberfläche der Katodenstrahlröhre beträgt. Somit sind die Sicherheitsbestimmungen verschiedener Länder, u.A. der deutschen Röntgenverordnung eingehalten.

Die Stärke der Röntgenstrahlung hängt im Wesentlichen von der Bauart der Katodenstrahlröhre ab, sowie von den Spannungen, welche an dieser anliegen. Um einen sicheren Betrieb zu gewährleisten, dürfen die Einstellungen der Niederspannungs- und des Hochspannungsnetzteils nur nach der Anleitung in Kapitel V des Handbuches vorgenommen werden.

Die Katodenstrahlröhre darf nur durch die gleiche Type ersetzt werden. (Siehe Kapitel Vi für HP — Ersatzteile).

Das Gerät ist in Deutschland zugelassen unter

der Nummer: BW/218/86/Roe

When operating, this instrument emits x-rays; however, it is well shielded and meets safety and health requirements of various countries, such as the X-ray Radiation Act of Germany.

Radiation emitted by this instrument is less than 0.5 mR/hr at a distance of five (5) centimeters from the surface of the cathode-ray tube. The x-ray radiation primarily depends on the characteristics of the cathode-ray tube and its associated low-voltage and high-voltage circuitry. To ensure safe operation of the instrument, adjust both the low-voltage and high-voltage power supplies as outlined in Section V of this manual (if applicable).

Replace the cathode-ray tube with an identical CRT only. Refer to Section VI for proper HP part number.

Number of German License: BW/218/86/Roe



GEWERBEAUF SICHTSAMT STUTTGART

- Zentrale Stelle für Sicherheitstechnik und Vorschriftenwesen in Baden-Württemberg -

Gewerbeaufsichtsamt · Jägerstr. 22 · Postfach 703 · 7000 Stuttgart 1

Stuttgart, den 16.01.1986

Fernsprecher

(0711) 205 01 (Behördenzentrum)

Durchwahl 2050 - 4798

Aktenzeichen: Z 5108/HP/Ws/Hh
(Bitte bei Antwort angeben)

Firma
Hewlett Packard GmbH
Herrenberger Str. 110/130

7030 Böblingen

Zulassungsschein Nr. BW/218/86/Rö

Gemäß § 9 der Röntgenverordnung vom 01.03.1973 (BGBl. I S. 173) wird die Zulassung der Bauart durch den Bauartzulassungsbescheid vom 16.01.1986 mit Aktenzeichen Z 5108/HP/Ws/Hh für den nachfolgend aufgeführten Störstrahler bescheinigt:

Gegenstand	:	Digital-Oszilloskop
Firmenbezeichnung	:	HP Typ 54110D
Bildröhre	:	Sony Typ M23 JHU 15X
Hersteller	:	Hewlett-Packard 1900 Garden of the Gods Road Colorado Springs Colorado 80907, USA
Betriebsbedingungen	:	Hochspannung: max. 22,3 kV Strahlstrom: max. 0,4 mA
Zulassungskennzeichen	:	BW/218/86/Rö

Die Bauartzulassung ist befristet bis 16.01.1996.

Für den Strahlenschutz wesentliche Merkmale

1. Die Art und Qualität der Bildröhre,
2. die der Hochspannungserzeugung und -stabilisierung dienenden Bauelemente.

Auflagen:

1. Die Geräte sind bezüglich der für den Strahlenschutz wesentlichen Merkmale entsprechend den vorgestellten und geprüften Mustern und Antragsunterlagen herzustellen.
2. Die Geräte sind einer Stückprüfung daraufhin zu unterziehen, ob sie bezüglich der für den Strahlenschutz wesentlichen Merkmale der Bauartzulassung entsprechen.

Die Prüfung muß umfassen:

- a) Kontrolle der Hochspannung an jedem einzelnen Gerät,
 - b) Messung und Dosisleistung nach Festlegung im Bauartzulassungsbescheid.
3. Die Herstellung und die Stückprüfung sind durch den von der Zulassungsbehörde bestimmten Sachverständigen überwachen zu lassen.
 4. Die Geräte sind deutlich sichtbar und dauerhaft mit dem Kennzeichen

BW/218/86/Rö

zu versehen sowie mit einem Hinweis folgenden Mindestinhalts:

"Die in diesem Gerät entstehende Röntgenstrahlung ist ausreichend abgeschirmt.
Beschleunigungsspannung maximal 22,3 kV."

Hinweis für den Benutzer des Geräts:

Unsachgemäße Eingriffe, insbesondere Verändern der Hochspannung oder Auswechseln der Bildröhre können dazu führen, daß Röntgenstrahlung in erheblicher Stärke auftritt. Ein so verändertes Gerät entspricht nicht mehr dieser Zulassung und darf infolgedessen nicht mehr betrieben werden.

Reutter

Reutter



Dieses Gerät wurde nach den Auflagen der Zulassungsbehörde einer Stückprüfung unterzogen und entspricht in den für den Strahlenschutz wesentlichen Merkmalen der Bauartzulassung. Die Beschleunigungsspannung beträgt maximal 22,3 kV.

Hewlett-Packard
1900 Garden of the Gods Road
Colorado Springs
Colorado 80907, USA

SAFETY CONSIDERATIONS

GENERAL - This is a Safety Class I instrument (provided with terminal for protective earthing).

OPERATION - BEFORE APPLYING POWER verify that the power transformer primary is matched to the available line voltage, the correct fuse is installed, and Safety Precautions are taken (see the following warnings). In addition, note the instrument's external markings which are described under "Safety Symbols."

WARNING

o Servicing instructions are for use by service-trained personnel. To avoid dangerous electric shock, do not perform any servicing unless qualified to do so.

o **BEFORE SWITCHING ON THE INSTRUMENT**, the protective earth terminal of the instrument must be connected to the protective conductor of the (mains) powercord. The mains plug shall only be inserted in a socket outlet provided with a protective earth contact. The protective action must not be negated by the use of an extension cord (power cable) without a protective conductor (grounding). Grounding one conductor of a two-conductor outlet is not sufficient protection.

o If this instrument is to be energized via an auto-transformer (for voltage reduction) make sure the common terminal is connected to the earth terminal of the power source.

o Any interruption of the protective (grounding) conductor (inside or outside the instrument) or disconnecting the protective earth terminal will cause a potential shock hazard that could result in personal injury.

o Whenever it is likely that the protection has been impaired, the instrument must be made inoperative and be secured against any unintended operation.

o Only fuses with the required rated current, voltage, and specified type (normal blow, time delay, etc.) should be used. Do not use repaired fuses or short circuited fuseholders. To do so could cause a shock or fire hazard.

o Do not operate the instrument in the presence of flammable gasses or fumes. Operation of any electrical instrument in such an environment constitutes a definite safety hazard.

o Do not install substitute parts or perform any unauthorized modification to the instrument.

o Adjustments described in the manual are performed with power supplied to the instrument while protective covers are removed. Energy available at many points may, if contacted, result in personal injury.

o Any adjustment, maintenance, and repair of the opened instrument under voltage should be avoided as much as possible, and when inevitable, should be carried out only by a skilled person who is aware of the hazard involved.

o Capacitors inside the instrument may still be charged even if the instrument has been disconnected from its source of supply.

SAFETY SYMBOLS



Instruction manual symbol. The product will be marked with this symbol when it is necessary for the user to refer to the instruction manual in order to protect against damage to the product.



Indicates hazardous voltages.



Earth terminal (sometimes used in manual to indicate circuit common connected to grounded chassis).

WARNING

The WARNING sign denotes a hazard. It calls attention to a procedure, practice, or the like, which, if not correctly performed or adhered to, could result in personal injury. Do not proceed beyond a WARNING sign until the indicated conditions are fully understood and met.

CAUTION

The CAUTION sign denotes a hazard. It calls attention to an operating procedure, practice, or the like, which, if not correctly performed or adhered to, could result in damage to or destruction of part or all of the product. Do not proceed beyond a CAUTION sign until the indicated conditions are fully understood or met.

SC1D984

TABLE OF CONTENTS

SECTION 1 WHEN YOU RECEIVE YOUR INSTRUMENT

Introduction	1-1
Safety Considerations	1-1
Accessories Supplied With The 54110D	1-1
Options	1-3
Power Cable	1-3
Initial Inspection	1-3
Claims for Damage	1-3
Packaging	1-3

SECTION 2 HOW TO USE THIS MANUAL

Introduction	2-1
When You Receive Your Instrument, Section 1	2-1
Meet The 54110D Color Digitizing Oscilloscope, Section 3	2-1
Getting Ready to Use the 54110D, Section 4	2-1
Getting Started With the Front Panel, Section 5	2-1
Familiarize Yourself With the Menus, Section 6	2-1
Front Panel Exercises, Section 7	2-1
Making a Hardcopy, Section 8	2-2
Remote Control, Section 9	2-2
Command Set Overview, Section 10	2-2
Appendix A	2-2
Appendix B	2-2
Appendix C	2-2

SECTION 3 SPECIFICATIONS AND SUPPLEMENTAL CHARACTERISTICS

Introduction	3-1
Vertical	3-2
Horizontal	3-3
Trigger	3-3
Inputs	3-4
Cathode-Ray Tube	3-5
HP 54110D Operating Characteristics	3-6
Digitizer	3-6
Vertical	3-6
Horizontal	3-6

Trigger.....	3-6
Display.....	3-7
Measurement Aids	3-8
Setup Aids.....	3-9
Power Requirements.....	3-9
Environmental.....	3-10

**SECTION 4
GETTING READY TO USE THE 54110D**

HP 54110D Specifications	4-1
Operating Environment	4-1
Power Requirements.....	4-1
Power Cable.....	4-3
HP-IB Address Selection.....	4-3
HP-IB Interconnections	4-3
Initial Color Display Setup	4-3

**SECTION 5
FRONT PANEL**

Getting Started With the Front Panel	5-1
System Control.....	5-1
Save/Recall.....	5-2
Local.....	5-2
Auto-Scale.....	5-3
Entry Devices.....	5-3
Menu Selection.....	5-3

**SECTION 6
FAMILIARIZE YOURSELF WITH THE MENUS**

Familiarize Yourself With The Menus	6-1
Vertical.....	6-1
Auto-Scale.....	6-1
Channel 1 and Channel 2 Menus.....	6-1
Normal Mode.....	6-2
Magnify Mode.....	6-2
Timebase Menu	6-4
Trigger Menu.....	6-6
Pattern Mode.....	6-7
Display Menu.....	6-11
Delta V (Volts) Menu	6-13
Delta T (Time) Menu.....	6-15
More.....	6-17

Wfm Save (Waveform Save)	6-17
Wfm Math (Waveform Math)	6-20
Measure	6-21
Plot	6-22
Print	6-24
Probes	6-24
Utility	6-26
Cal Menu	6-26
Color Cal Menu	6-30
HP-IB Menu	6-30

**SECTION 7
FRONT PANEL EXERCISES**

Introduction	7-1
Inputting a Signal	7-1
Front Panel Review	7-1
Make a Voltage Measurement	7-2
Time Domain Measurements	7-5
Delay	7-9
Trigger	7-15
Pattern Mode	7-16
State Mode	7-19
Display	7-19
Normal Mode	7-19
Averaged Mode	7-19
Probes	7-25
Waveform Math	7-26

**SECTION 8
MAKING A HARDCOPY**

Introduction	8-1
Setting Up the 54110D	8-1
Graphics Printer	8-1
Compatible Printers	8-2
Plotters	8-2
Compatible Plotters	8-3

**SECTION 9
REMOTE CONTROL**

Introduction	9-1
HP-IB Compatibility	9-1
HP-IB Status Display	9-1

Remote Mode	9-1
Local Mode.....	9-4
Local Lockout.....	9-5
Addressing	9-5
HP-IB Turn-On Default Conditions	9-6
Data Messages	9-6
Receiving Data Messages.....	9-6
Program Order Considerations	9-7
Program Command Format.....	9-7
Sending Data Messages	9-8
Learn and Cal Strings.....	9-8
Receiving the Clear Message	9-9
Receiving the Trigger Message.....	9-9
Receiving the Remote Message	9-9
Receiving the Local Message.....	9-9
Receiving the Local Lockout Message	9-9
Receiving the Clear/Set Local Message	9-9
Sending the Require Service Message	9-10
The Status Word	9-10
Sending the Status Byte Message.....	9-10
Receiving the Abort Message.....	9-11

**SECTION 10
COMMAND SET OVERVIEW**

Introduction	10-1
Command Set Organization	10-1
Notation Conventions and Definitions	10-4
Command Abbreviations.....	10-4
Alpha and Numeric Numeric Arguments.....	10-5
Data Output (Query) Format	10-5
Command Order Considerations	10-5
Default Settings	10-5
Status Word	10-6
System Commands	10-11
Acquire Subsystem.....	10-33
Channel Subsystem.....	10-38
Display Subsystem	10-45
Function Subsystem	10-61
Graph Subsystem	10-66
Hardcopy Subsystem	10-69
Measure Subsystem.....	10-76
Timebase Subsystem	10-95
Trigger Subsystem	10-104
Waveform Subsystem.....	10-117
Data Movement in the 54110D	10-129

**APPENDIX A
EXAMPLE/DEMO PROGRAMS**

Introduction	A-1
Vertical Demo Program	A-1
Timebase Demo Program.....	A-2
Learn String Demo Program.....	A-4
Hardcopy Demo Program.....	A-4
Hardcopy/Plot Demo Program.....	A-5
Measure Demo Program.....	A-5
Data Transfer Demo Program.....	A-7
Service Request (SRQ) Demo Program	A-9
Service Request (Extended) Demo Program	A-12
Color Demo Program	A-13

APPENDIX B

Software Delay Calibration and Trigger Delay Optimization.....	B-1,2
---	-------

APPENDIX C

Display Mode Considerations.....	C-1
Auto Top-Base	C-1
Coarse Measurements	C-2
Precise Measurements.....	C-2

LIST OF TABLES

1-1. AC Power Cables	1-4
2-1. User Table.....	2-3
3-1. Specifications	3-2
3-2. Supplemental Characteristics.....	3-6
9-1. Commonly Used Code Conversions	9-2
9-2. HP-IB Message Reference Table.....	9-3
10-1. The Lower Byte of the SStatus Word.....	10-7
10-2. The Upper Byte of the Status Word	10-8
10-3. Error Numbers.....	10-16
10-4. 54110D Front Panel Key Codes	10-18
10-5. Reset Conditions	10-25

LIST OF FIGURES

FIGURE	PAGE
1-1	54001A 1 GHz Miniature Active Probe 1-2
1-2	54002A 1 M Ohm, 300 MHz with 10:1 Probe..... 1-2
4-1	HP 54110D Rear Panel 4-2
4-2	Power Module 4-2
4-3	HP-IB Interface Connector 4-4
4-4	HP-IB Interface 4-5
5-1	54110D Front Panel..... 5-1
6-1	Chan 1/2 Menu 6-2
6-2	Timebase Menu..... 6-5
6-3	Trigger Menu..... 6-6
6-4	Trigger Menu..... 6-10
6-5	Display Menu 6-11
6-6	Delta V Menu 6-13
6-7	Vmarkers 6-13
6-8	Delta t Menu 6-16
6-9	Wfm Save Menu 6-19
6-10	Wfm Math Menu 6-19
6-11	Measure Menu 6-23
6-12	Plot Menu 6-23
6-13	Print Menu..... 6-25
6-14	Probes Menu 6-25
6-15	Utility Menu..... 6-25
6-16	Cal Menu 6-28
6-17	Trigger Delay 6-29
6-18	Chan to Chan Skew..... 6-29
6-19	Color Cal Menu 6-31
6-20	HP-IB Menu 6-31
6-21	Color Chart..... 6-32
6-22	HSL Color Model..... 6-33
7-1	HP 54110D Front Panel 7-1
7-2	Manual Vmarker Measurement..... 7-2
7-3	The Histogram of a Waveform 7-3
7-4	Auto Top-Base Voltage Measurement..... 7-3
7-5	Peak-to-Peak Voltage..... 7-4
7-6	Delta Vmarkers on Split Screen 7-5
7-7	Manual Time Interval Measurement..... 7-6
7-8	Edge Find 7-7
7-9	+ Pulse Width 7-9
7-10	Time Jitter in the Averaged Mode 7-11
7-11	Time Jitter in the Normal Mode..... 7-12
7-12	Time Jitter With Normal/Averaged Mode 7-12
7-13	Auto Sweep Mode With Delay 50 ms..... 7-13
7-14	Split Screen With Trigger On Chan 1 7-15
7-15	Split Screen With Trigger On Chan 2..... 7-16
7-16	Pattern When Entered "HHXX" 7-17
7-17	Pattern When Exited 7-18
7-18	Averaged Mode (8 Averages) 7-20

LIST OF FIGURES (Cont'd)

7-19	Normal Mode	7-21
7-20	Magnify Window in the Normal Mode	7-22
7-21	Magnify Using Normal Mode	7-23
7-22	Magnify in the Averaged Mode With 2 Averages	7-24
7-23	Magnify in the Averaged Mode With 512 Averages	7-24
7-24	Time Delay Chan 1 to Chan 2	7-26
7-25	Selecting Func 1	7-27
7-26	Func 1	7-27
7-27	Waveform Math Func 1&2	7-28
7-28	Measuring Func 1 Parameter	7-29
7-29	Automated Measurements on Func 1	7-30
7-30	Automated Measurements on Func 2	7-30
10-1	Command Set Syntax Diagram	10-2
10-2	System Commands	10-9
10-3	Acquire Subsystem Commands	10-32
10-4	Channel Subsystem Commands	10-37
10-5	Display Subsystem Commands	10-42
10-6	Attribute Byte	10-46
10-7	Function Subsystem Commands	10-60
10-8	Graph Subsystem Commands	10-65
10-9	Hardcopy Subsystem Commands	10-68
10-10	Measurement Subsystem Commands	10-72
10-11	Timebase Subsystem Commands	10-94
10-12	Trigger Subsystem Commands	10-99
10-13	Waveform Subsystem Commands	10-114
10-14	Data Flow	10-130

SECTION 1

WHEN YOU RECEIVE YOUR INSTRUMENT

1-1. INTRODUCTION

This Operating and Programming Manual contains information required to install, operate and program the Hewlett-Packard Model 54110D Color Digitizing Oscilloscope. Paragraph 1-3 lists the accessories supplied with the instrument. Section 1 covers instrument safety, identification, options, accessories, receiving information and other basic data. Section 2 provides guidelines for using this manual.

1-2. SAFETY CONSIDERATION

The Hewlett-Packard Model 54110D is a Safety Class 1 instrument (instrument with an exposed metal chassis that is directly connected to earth via the power supply cable.)

WARNING

Before you apply power to the unit make sure you review this manual and become familiar with the definitions of the safety markings and pertinent instructions. These must be followed to insure safe operation and that the instrument is maintained in a safe condition.

1-3. ACCESSORIES SUPPLIED WITH THE 54110D

The 54110D Color Digitizing Oscilloscope is supplied complete with the following accessories:

Four 54002A input pods

One power cable

One Operating and Programming Manual and one Service Manual.

1-4. ACCESSORIES AVAILABLE

The following accessories are available for the 54110D:

54001A 10 M Ω , 1 GHz Miniature Active Probe with an attached 1.5M cable. (see figure 1-1)

54003A 1 M Ω 300 MHz, 10:1 probe.

11536A 50 Ohm Probing Tee. Used to minimize disturbance of transmission characteristics. Compatible with the 54001A high bandwidth probe (see above). Requires one 54051A probe adapter (see below).

10211A (24 pin) and 10024A (16 pin) Test Clips.

54001-23203 probe adapter. Adapts the 54001A (see above) mini-probe tip (or other HP mini-probes) to the probing accessories included in the 10020A resistive divider probe kit, and to the 11536A probing tee.

10240B BNC Blocking Capacitor. Used to ac couple signals to 54110D's inputs.

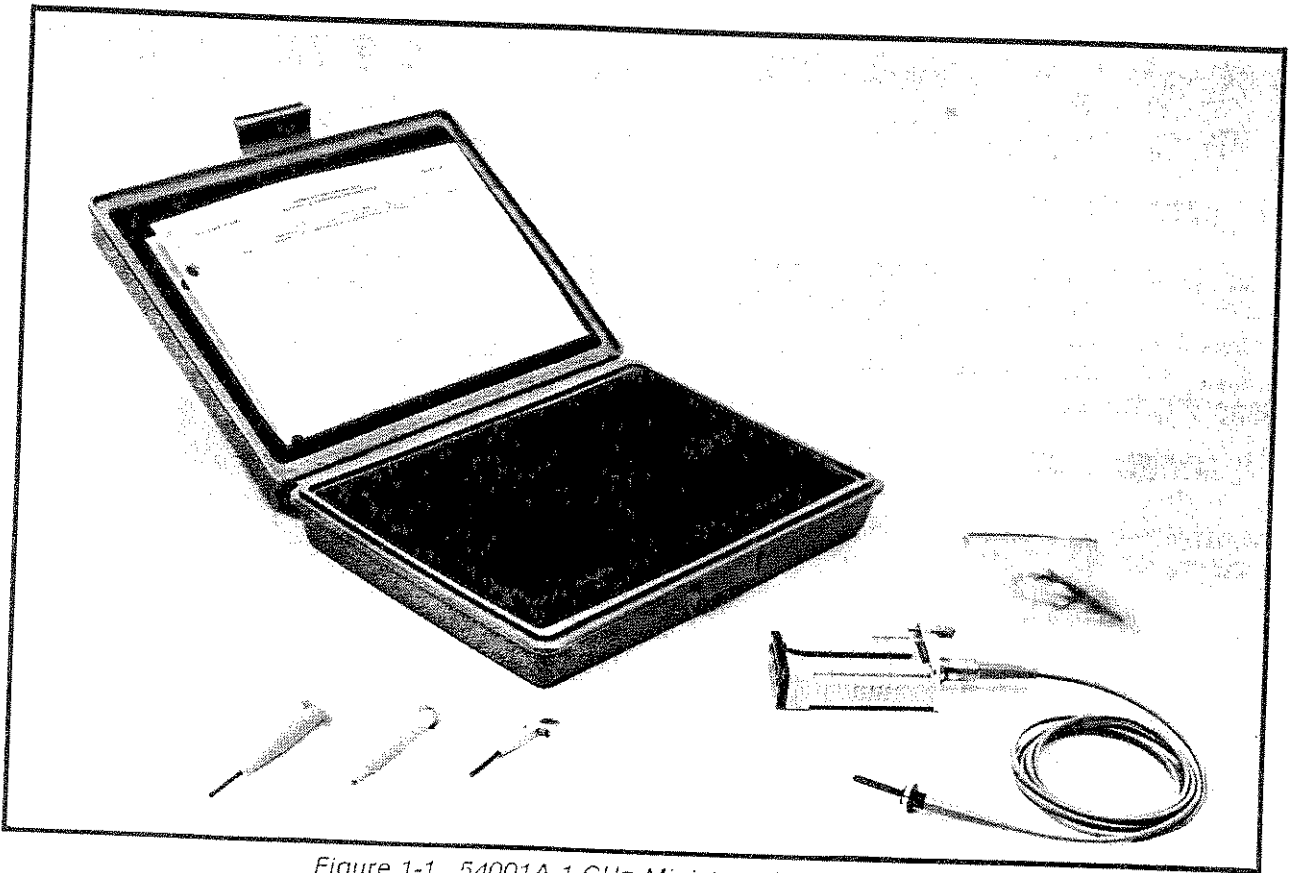

Figure 1-1. 54001A 1 GHz Miniature Active Probe

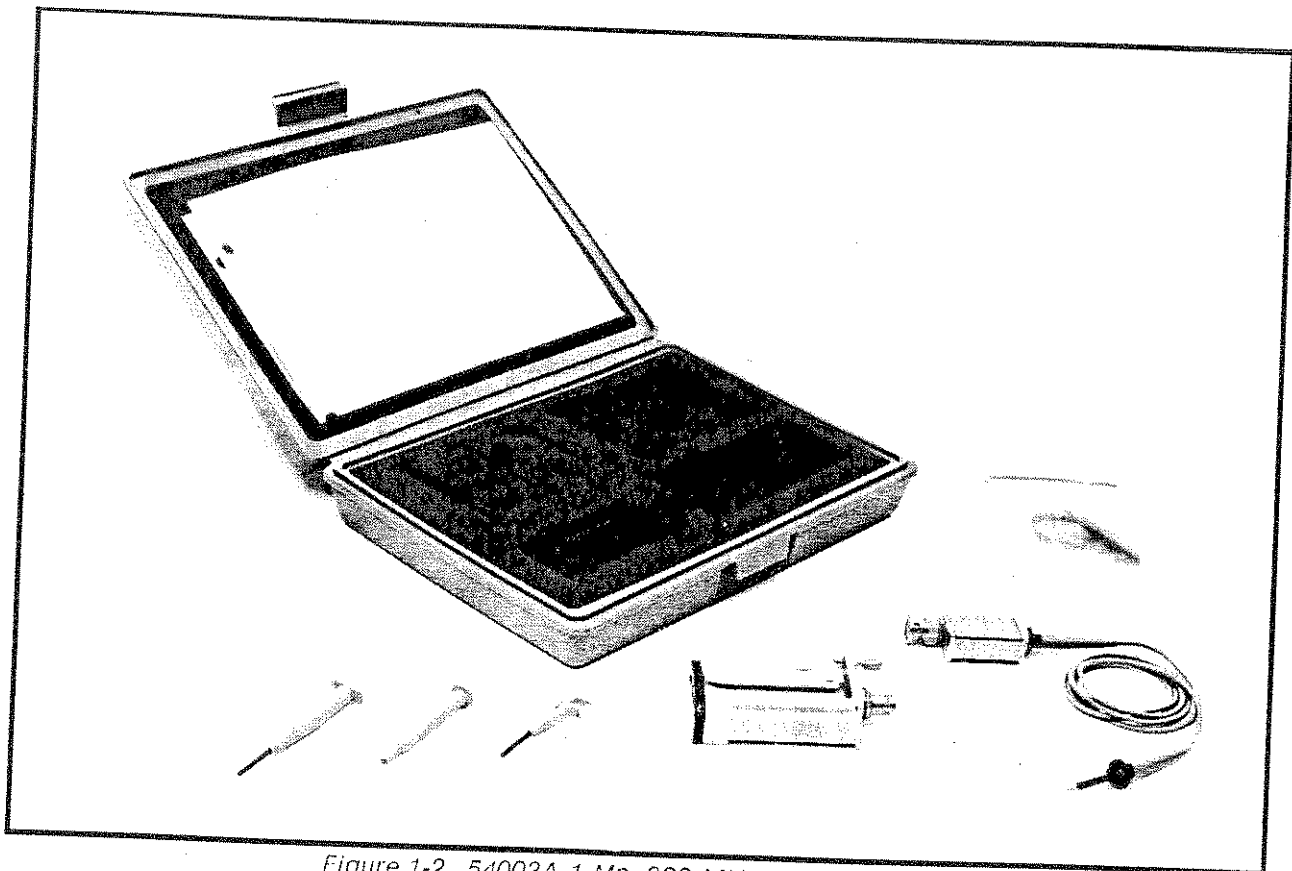

Figure 1-2. 54003A 1 M Ω 300 MHz with 10:1 Probe

1-5. OPTIONS

The 54110D Color Digitizing Oscilloscope has two options available:

Option 908 provides rack ears and associated mounting hardware for rack mounting the 54110D. The HP part number is 5061-9679.

Option 910 provides an additional Operating and Programming Manual for the 54110D. The HP part number is 54110-90901.

1-6. POWER CABLE

WARNING

Before energizing this unit you must insure that the chassis of the instrument is properly grounded. This precaution is to avoid the possibility of injury or death which may result if the protective ground is defeated.

The 54110D is provided with a 3 wire power cable. When this cable is connected to an appropriate AC power receptacle it provides a ground for the instrument cabinet. The type of power cable shipped with each instrument depends on the country of destination. See table 1-1 for power cable description and applications.

1-7. INITIAL INSPECTION

WARNING

To avoid hazardous electrical shock, do not perform electrical tests when there are signs of shipping damage to any portion of the instrument.

Inspect the shipping container for damage. If the shipping container or packaging materials are damaged, it should be kept until the contents of the shipment have been checked for completeness and the instrument has been checked mechanically and electrically. The contents of the shipment should be as listed in Paragraph 1-3. If the contents are incomplete, or if there is mechanical damage or defect, notify the nearest Hewlett-Packard office. If either the shipping container is damaged or the packaging material shows signs of stress, notify the carrier as well as the Hewlett-Packard office. Keep the shipping materials for the carrier's inspection. The HP office will arrange for repair or replacement without waiting for claim settlement.

1-8. CLAIMS FOR DAMAGE

If physical damage is evident or if the instrument does not meet specifications when received, notify the carrier and the nearest Hewlett-Packard Sales/Service Office. The sales/service office will arrange for repair or replacement of the unit without waiting for settlement of the claim against the carrier.





1-9. STORAGE AND SHIPMENT

The 54110D Color Digitizing Oscilloscope may be stored and shipped in environments that do not exceed the following limits:

Temperature.....	-40° C to +75° C
Humidity.....	<95% relative
Altitude	<15,300 metres (50,000 feet)

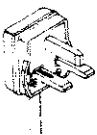
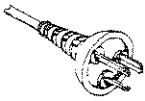
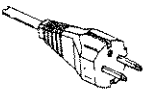
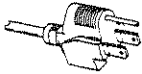
This instrument should also be protected from temperature extremes that would cause condensation in the instrument.

Table 1-1. AC Power Cables

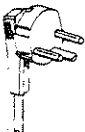
PLUG TYPE	CABLE PART NO.	PLUG DESCRIPTION	LENGTH IN/CM	COLOR	COUNTRY
OPT 900 	8120-1351 8120-1703	Straight *BS1363A 90°	90/228 90/228	Gray Mint Gray	United Kingdom, Cyprus, Nigeria, Zimbabwe Singapore
OPT 901 	8120-1369 8120-0696	Straight *NZSS198/ASC 90°	79/200 87/221	Gray Mint Gray	Australia, New Zealand
OPT 902 	8120-1689 8120-1692 8120-2857	Straight *CEE7-Y11 90° Straight (Shielded)	79/200 79/200 79/200	Mint Gray Mint Gray Coco Brown	East and West Europe, Saudi Arabia, So Africa, India (Unpolarized in many nations)
OPT 903 	8120-1378 8120-1521 8120-1992	Straight *NEMA5-15P 90° Straight (Medical UL544)	90/228 90/228 96/244	Jade Gray Jade Gray Black	United States, Canada, Japan (100V or 200V), Mexico, Philippines, Taiwan
OPT 904 	8120-0698	Straight *NEMA6-15P	90/229	Black	United States, Canada
OPT 905 	8120-1396 8120-1625	CEE22-V1 (Systems Cabinet use) 250V	30/76 96/244	Black Black	
OPT 906 	8120-2104 8120-2296	Straight *SEV1011 1959-24507 Type 12 90°	79/200 79/200	Mint Gray Mint Gray	Switzerland
OPT 912 	8120-2956 8120-2957	Straight *DHCK107 90°	79/200 79/200	Mint Gray Mint Gray	Denmark

*Part number shown for plug is industry identifier for plug only. Number shown for cable is HP Part no. for complete cable including plug. E=Earth Ground, L=line, N=Neutral

1-10. PACKAGING

Original packaging i.e., the containers and materials identical to those used in factory packaging are available from Hewlett-Packard. If the unit is being returned to Hewlett-Packard for servicing, attach a tag indicating the type of servicing required, return address, model number, and full serial number. Mark the container FRAGILE. In any correspondence refer to the instrument by model number and full serial number.

If other packaging is to be used the following general instructions for repackaging with commercially available materials should be followed;

- a. Wrap the instrument in heavy paper or plastic. If you are shipping the unit to a Hewlett-Packard office or service center be sure to attach a tag to the instrument indicating the type of service required, return address, model number and full serial number.
- b. Use a strong shipping container. A double wall carton made of 2.4MPa (350psi) test material is adequate.
- c. Use a layer of shock absorbing material 75 to 100mm (3 to 4 inches) thick around all sides of the instrument to provide firm cushioning and prevent movement inside the container. Protect the control panel with cardboard.
- d. Seal the shipping container securely.
- e. Mark the shipping container FRAGILE to insure careful handling.
- f. In any correspondence, refer to instrument by model number and full serial number.

NOTES:

SECTION 2

HOW TO USE THIS MANUAL

2-1. INTRODUCTION

This Operating and Programming Manual has been designed as both a tutorial operating manual and a reference manual for writing programs to operate the oscilloscope remotely.

The first four sections of the manual are concerned with instrument specifications, receiving information and operating environment information for the 54110D.

The next four sections (5 through 8) of the manual are concerned with front panel exercises. Sections 9-11 are dedicated to the remote programming of the HP-IB interface.

Here is an overview of what this manual contains:

WHEN YOU RECEIVE YOUR INSTRUMENT, SECTION 1

This section includes installation information, receiving information, warranty data and much more. You should read Section 1 before initial installation and operation.

MEET THE 54110D COLOR DIGITIZING OSCILLOSCOPE, SECTION 3

This section provides a description of this oscilloscope and complete specifications and operating characteristics. This section also includes a probe selection table.

GETTING READY TO USE THE 54110D, SECTION 4

This section contains important data about the required operating environment and power requirements for the 54110D. You should review this section prior to initial operation.

GETTING STARTED WITH THE FRONT PANEL, SECTION 5

This section introduces you to the front panel layout and its four functional areas. Section 5 provides vital information for the first time user.

FAMILIARIZE YOURSELF WITH THE MENUS, SECTION 6

Many of the front panel controls on the 54110D are multi-functioned. To better understand these controls this section defines all front panel functions and maps the different function groups. This section also introduces you to the color features of this instrument. This section is formatted so that it can be used as a reference by operators, regardless of skill level.

FRONT PANEL EXERCISES, SECTION 7

This section provides step-by-step exercises that will help you become more familiar with making measurements from the front panel of the 54110D. Section 7 builds on the information presented in Section 6.

MAKING A HARDCOPY, SECTION 8

This section provides information concerning the use of graphics printers and plotters with the 54110D via HP-IB. This section also provides a list of Hewlett-Packard printers and plotters that are compatible with this instrument.

REMOTE OPERATION, SECTION 9

This section discusses the remote operation of the instrument over the HP-IB. Such topics as HP-IB compatibility, remote/local modes, local lockout, learn and cal strings are dealt with. Review this section before writing programs for the instrument.

COMMAND SET OVERVIEW, SECTION 10

This section contains the instruction set, notation conventions and definitions, syntax diagrams and other detailed programming reference information for the 54110D.

APPENDIX A

Appendix A contains example programs for the 54110D using the HP 200 series scientific computer using the HP Basic 4.0 operating system.

APPENDIX B

Appendix B provides the advanced user with a discussion of the channel-to-channel timing skew and trigger delay calibration concerns when using the 54110D.

APPENDIX C

Appendix C provides the advanced user detailed information concerning the automated measurements that the 54110D can perform. This appendix discusses such topics as measurement throughput, accuracy, and resolution.

The following table indicates those chapters which are recommended reading for various types of 54110D users. You may fall into more than one category. For example, you may be an inexperienced programmer who installs the 54110D.

Table 2-1. User Table

Reader/User	Chapters										Appendix		
	1	2	3	4	5	6	7	8	9	10	A	B	C
Installation Personnel	•	•		•									
First Time User (Front Panel)			•	•	•	•		•					
Advanced User (Front Panel)						•	•	•				•	•
Beginning Programmer			•	•	•	•	•		•				
Advanced Programmer										•	•		

NOTES:

NOTES:

SECTION 3 SPECIFICATIONS AND SUPPLEMENTAL CHARACTERISTICS

3-1. INTRODUCTION

This section of the manual contains a list of specifications for reference and performance verification. These specifications are listed in Table 3-1. Also included in section three are the supplemental characteristics. Supplemental characteristics are not specifications but are typical parameters and are included in this manual as additional information for the user. Supplemental characteristics are listed in Table 3-2.

NOTES:

Table 3-1. Specifications

VERTICAL (Voltage)

Bandwidth (-3dB):¹

- with HP 54002A: dc to 1 GHz
- with HP 54001A: dc to 700 Mhz₃
- with HP 54003A: dc to 300 Mhz₃

Transition Time (10% to 90%):¹

- with HP 54002A: ≤ 350 ps
- with HP 54001A: ≤ 450 ps₃
- with HP 54003A: ≤ 1.2 ns₃

Deflection Factor (full-scale = 8 divisions):

- with HP 54002A: 10 mV/div to 1 V/div in 1-2-5 steps
- with HP 54001A: 100 mV/div to 10 V/div in 1-2-5 steps₃
- with HP 54003A: 100 mV/div to 10 V/div in 1-2-5 steps₃

DC Accuracy, Single Voltage Marker:

- with HP 54002A: $\pm 3\%$ of full-scale $\pm 2\%$ of offset²
- with HP 54001A: $\pm 6\%$ of full-scale $\pm 2\%$ of offset ± 50 mV₃
- with HP 54003A: $\pm 6\%$ of full-scale $\pm 2\%$ of offset ± 50 mV₃

DC Delta Voltage Accuracy (Two Markers On Same Channel):

- with HP 54002A: $\pm 1\%$ of full-scale $\pm 3\%$ of reading²
- with HP 54001A: $\pm 1\%$ of full-scale $\pm 6\%$ of reading
- with HP 54003A: $\pm 1\%$ of full-scale $\pm 6\%$ of reading

DC Offset:

RANGE: ± 1.5 x full-scale (referenced to center screen)

ADJUSTMENT RESOLUTION: adjustable in steps of 0.0025 x full-scale

Dynamic Range: deflection factor and offset should be scaled so that the unmagnified signal remains within the full-scale display range.

Magnifier: expands displayed signal vertically from 1 to 16 times; adjustable in 0.5% steps.

Inputs: two inputs, configurable with HP 54000-series pods.

Table 3-1. Specifications (Continued)

HORIZONTAL (Time)

Deflection Factor (full-scale = 10 divisions): 100 ps/div to 1 s/div

ADJUSTMENT RESOLUTION: adjustable in 1-2-5 steps via knob and step keys. Adjustable to three significant figures via keypad or HP-IB command.

Delay (Time Offset):

PRE-TRIGGER RANGE: up to -200 ms or -10 divisions, whichever is greater.

POST-TRIGGER RANGE: up to +1 second or +600,000 divisions, whichever is greater.

ADJUSTMENT RESOLUTION: adjustable in steps of 10 ps or 10^{-6} x delay setting, whichever is greater.

Time Base Accuracy: error is:

SINGLE-CHANNEL: $\leq (100 \text{ ps} \pm 2 \times 10^{-5} \times \text{delta T reading})$

DUAL-CHANNEL: $\leq (200 \text{ ps} \pm 2 \times 10^{-5} \times \text{delta T reading})$

TRIGGER

Trigger Source	Vertical Channel 1 or 2		
Input Pod	HP 54002A	HP 54001A	HP 54003A ³
Trigger Level Range	$\pm 2 \times \text{full-scale}$		
Trigger Level Adjustment Resolution	$0.0025 \times \text{full-scale}$		
Trigger Sensitivity DC to 100 MHz	$0.12 \times \text{full-scale}$		
Above 100 Mhz (frequency range)	$0.24 \times \text{full-scale}$ (100 MHz to 500 MHz)	$0.24 \times \text{full-scale}$ (100 Mhz to 300 Mhz)	
Pulse width > 1 ns	$0.24 \times \text{full-scale}$		

Table 3-1. Specifications (Continued)

TRIGGER (Continued)				
Trigger Source	Trigger Input 3 or 4			
Input Pod	HP 54002A	HP 54001A	HP 54003A ³	
Trigger Level Range	±2 V	±20 V		
Trigger Level Adjustment Resolution	2 mV	20 mV		
Trigger Sensitivity DC to 100 MHz	40 mV	400 mV		
Above 100 Mhz (frequency range)	80 mV (100 MHz to 500 MHz)	800 mV (100 MHz to 500 MHz)	800 Mv (100 MHz to 300 Mhz)	
Pulse width > 1 ns	80 mV	800 mV		
<p>RMS Jitter: $\leq (50 \text{ ps} + 5 \times 10^{-7} \times \text{delay setting})$</p> <p>Trigger Source: channel 1, channel 2, trigger 3, trigger 4. Independent trigger level and polarity settings on all sources. Edge trigger on any source. Logical pattern trigger on all sources.</p> <p>Trigger 3 and 4 Input: configurable with HP 54000-series pods.</p>				
INPUTS				
	HP 54002A 50Ω Input	HP 54001A 1 GHz Miniature Active Probe	HP 54003A 1 MΩ Input, With 10:1 Probe Attached	HP 54003A 1 MΩ Input, With 10:1 Probe Removed
Maximum Input Voltage	5 V rms	20 V peak	20 V peak	2 V peak

Table 3-1. Specifications (Continued)

INPUTS (Continued)				
	HP 54002A 50 Ω Input	HP 54001A 1 GHz Miniature Active Probe	HP 54003A 1 M Ω Input, With 10:1 Probe Attached	HP 54003A 1 M Ω Input, With 10:1 Probe Removed
Coupling	dc	dc	dc	dc
Input Capacitance (Nominal)	N/A	2 pF	8 pF	10 pF
Input Resistance (Nominal)	50 Ω	10 k Ω	1 M Ω	1 M Ω
Bandwidth * (-3dB)	dc to 1 GHz	dc to 1 GHz	dc to 300 MHz	dc to 300 MHz
Transition Time * (10% to 90%)	≤ 350 ps	≤ 350 ps	≤ 1.2 ns	≤ 1.2 ns
Division Ratio *	1:1	10:1 $\pm 3\%$	10:1 $\pm 3\%$	1:1 $\pm 1\%$

CATHODE-RAY TUBE

X-RAY EMISSION: CRT emission < 0.1 mR/hr; not measurable in background noise using Victoreen Model 440RF/C.

NOTES:

1. These specifications apply over ambient temperature range of +15°C to +35°C.
 2. When driven from a 50 Ω source.
 3. With the 10:1 divider probe supplied with the 54003A.
- * Refer to VERTICAL and TRIGGER specifications for system performance specifications.

Table 3-2. Supplemental Characteristics

DIGITIZER

Resolution: 7 bits (1 part in 128). Effective resolution can be extended up to approximately 10 bits by using magnification and averaging.

Digitizing Rate: up to 40 megasamples/second.

VERTICAL

Input Protection: a relay opens when applied voltage exceeds rated input voltage for input pod in use (see Specifications).

HORIZONTAL

Delay Between Channels: difference in delay between channels can be nulled out in 10 ps steps up to 10 ns to compensate for differences in input cables or probe length.

Reference Location: the reference point can be located at the left edge, center, or right edge of the display. The reference point is that point where the time is offset from the trigger by the delay time.

TRIGGER

Input Protection: a message appears on the display when the applied voltage exceeds rated input voltage for input pod in use (see Specifications).

Holdoff

HOLD-OFF-BY-EVENTS: range of events counter is from 2 to 67 million events. Maximum counting rate is 80 MHz. An event is defined as anything that satisfies the triggering conditions selected.

HOLD-OFF-BY-TIME: adjustable in 10 ns steps from 70 ns to 670 ms.

Trigger Modes

EDGE TRIGGER: on any source (see Specifications, Trigger Source).

PATTERN TRIGGER: a pattern can be specified for all sources. Each source can be specified as high, low, or don't care. Trigger can occur on the last edge to enter the specified pattern or the first edge to exit the specified pattern.

Table 3-2. Supplemental Characteristics (Continued)

Trigger Modes (Continued)

TIME QUALIFIED PATTERN TRIGGER: trigger occurs on the first edge to exit the specified pattern, only if the pattern was present for less than [greater than] the specified time. Filter time is adjustable from 10 ns to 5 seconds. Filter recovery time is ≤ 8 ns. In the "Pattern present <[time]" mode, the pattern must be present ≥ 1 ns for the trigger to respond.

STATE TRIGGER: a pattern can be specified for any three sources. Trigger can be set to occur on an edge of either polarity on the source specified as the clock (not one of the pattern sources) when the pattern is present or not present. Setup time for the pattern to be present prior to the clock edge is < 4 ns; hold time is zero.

Delayed Trigger

EVENTS-DELAYED MODE: the trigger can be armed by an edge on any source, then triggered by the n th edge on any other source.

The number of events, n , can be set from 1 to $10^8 - 1$.
Maximum event counting rate is 150 MHz.

TIME-DELAYED MODE: the trigger can be armed by an edge on any source, then triggered by the first edge on any other source after a specified time has elapsed. The delay time can be set from 20 ns to 5 seconds.

DISPLAY

Data Display Resolution: 501 points horizontally (full-scale) by 256 points vertically.

Data Display Formats

SPLIT SCREEN: each channel display is four divisions high.

FULL SCREEN: the two channels are overlaid. Each channel display is eight divisions high.

Display Modes

VARIABLE PERSISTENCE: the time that each data point is retained on the display can be varied from 200 ms to 10 seconds, or it can be displayed indefinitely.

Table 3-2. Supplemental Characteristics (Continued)

Display Modes (Continued)

AVERAGING: the number of averages can be varied from 1 to 2048 in powers of 2. On each acquisition, $1/n$ times the new data is added to $(n-1)/n$ of the previous value at each time coordinate. Averaging operates continuously; the average does not stop after n acquisitions.

GRATICULES: Full grid, axes with tic marks, or frame with tic marks.

DISPLAY COLORS: a default color selection is setup in the instrument. Different colors are used for Display background, Channel 1/Function 1, Channel 2/Function 2, background text, highlighted text, Advisories, Markers, overlapping waveforms and Memories. If desired, the colors used may be changed from the front panel or from HP-IB.

MEASUREMENT AIDS

Markers: dual voltage markers and dual time markers are available. Voltage markers can be assigned to either channel or to both channels, memories and functions.

Automatic Edge Finders: the time markers can be assigned automatically to any displayed edge of either polarity on a channel memory, or function or to any combination of the preceding. The voltage markers establish the threshold reference for the time markers in this mode.

Automatic Pulse Parameter Measurements: the following pulse parameter measurements can be performed automatically (as defined by IEEE standard 194-1977, "IEEE Standard Pulse Terms and Definitions").

Frequency	Top magnitude
Period	Base magnitude
Pulse duration	Preshoot
Rise time	Overshoot
Fall time	RMS volts
Pulse amplitude	Duty cycle

Waveform Math: two independent functions are provided for waveform math. The operators are +, -, invert, versus and only. Either of the two vertical channels or any of the four waveform memories can be used as operands for the waveform math. If turned on, Function 1 is displayed in lieu of Channel 1 and Function 2 is displayed in lieu of Channel 2.

Table 3-2. Supplemental Characteristics (Continued)

SETUP AIDS

Presets: vertical deflection factor, offset, and trigger level can be preset independently on each channel for ECL or TTL levels.

Auto-Scale: pressing Auto-Scale causes vertical and horizontal deflection factors and the trigger source to be set for a display appropriate to the signals applied to the inputs. Requires a duty cycle >0.1%, frequency >50Hz, and amplitude >20 mV peak. Operative only for relatively stable input signals.

Save-Recall: ten front panel setups may be saved in non-volatile memory. If Auto-Scale is inadvertently pressed, pressing Recall followed by Auto-Scale, restores the instrument to the state prior to the last Auto-Scale executed.

Waveform Memories: four memories are provided for storage of waveforms. Only one waveform may be stored in each of these memories. These memories can be used as sources for either measurements or functions. Two additional memories are provided to store pictures. Each of these two waveform picture memories is a pixel map of the display. Any number of waveform pictures may be written into to each picture memory. Once stored, individual waveforms cannot be accessed from the picture memories. The display of any of the six memories can be turned on or off without affecting their contents. Waveforms in memory are displayed in a different color from live waveforms.

POWER REQUIREMENTS

Voltage: 115/230 V ac, -25% to +15%, 48-66 Hz.

Power: 350 watts maximum, 650 VA maximum.

DIMENSIONS

Refer to outline drawing.

WEIGHT

Net: approximately 25.5 kg (56 lb).

Shipping: approximately 30.5 kg (67 lb).

Table 3-2. Supplemental Characteristics (Continued)

ENVIRONMENTAL CONDITIONS

Temperature

OPERATING: 0°C to +55°C (+32°F to +131°F).

Note: see Specification Note 1.

NON-OPERATING: -20°C to +75°C (-4°F to +167°F).

Humidity

OPERATING: up to 90% relative humidity at +40°C (+104°F).

NON-OPERATING: up to 95% relative humidity at +65°C (+149°F).

Altitude

OPERATING: up to 4600 metres (15,000 ft).

NON-OPERATING: up to 15,300 metres (50,000 ft).

Vibration: Vibrated in three orthogonal axes for 15 minutes each axes; 0.38 mm (0.015 in.) peak-to-peak excursion; 5 to 55 Hz; 1 minute/octave sweep.

NOTES:

1. DIMENSIONS ARE FOR GENERAL INFORMATION ONLY. IF DIMENSIONS ARE REQUIRED FOR BUILDING SPECIAL ENCLOSURES, CONTACT YOUR HP FIELD ENGINEER.
2. DIMENSIONS ARE IN MILLIMETRES AND (INCHES).

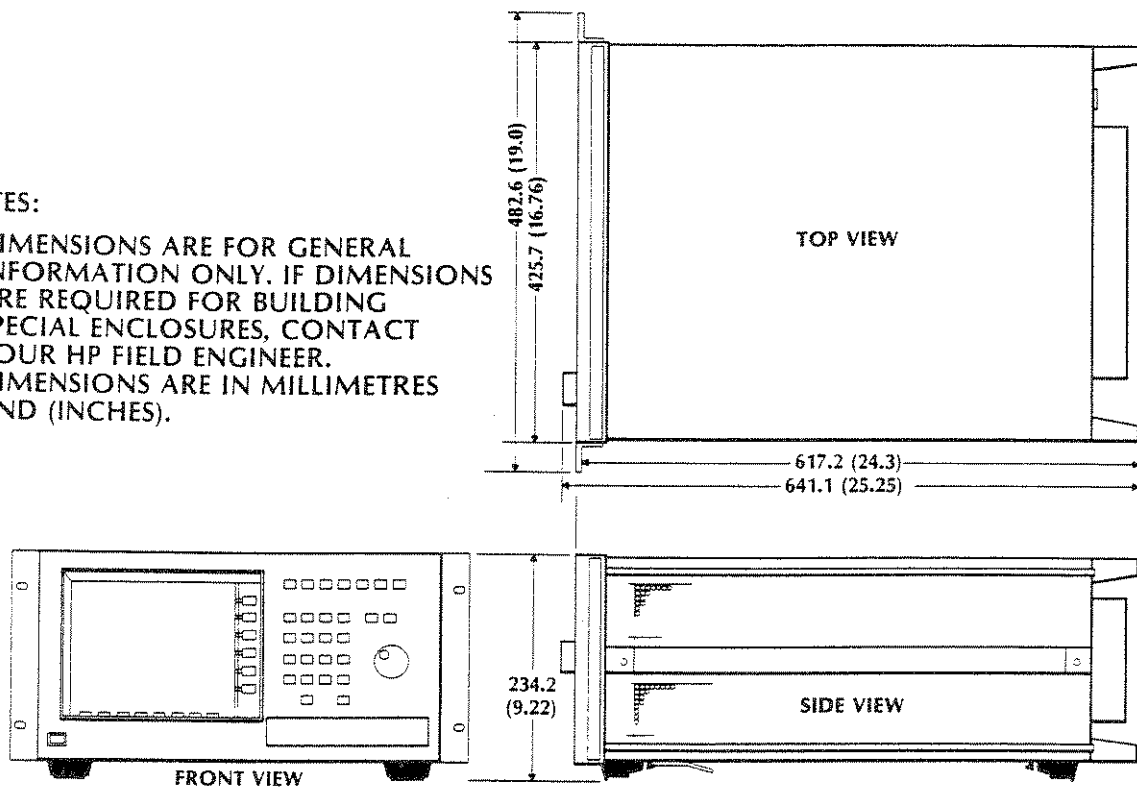

SECTION 4 GETTING READY TO USE THE HP 54110D

4-1. HP 54110D SPECIFICATIONS

This section provides information concerning the operating environment and the power requirements for the HP 54110D Color Digitizing Oscilloscope. It is important that the user provide the correct power source and operating environment for this instrument. Failure to do so can cause serious damage to the instrument and/or provide a health hazard to the user.

4-2. OPERATING ENVIRONMENT

CAUTION

Insure the instrument has adequate clearance on all surfaces to provide for sufficient air flow for cooling. Do not block any of the vent holes or the fan's air inlet.

The operating environment must be maintained within the following parameters:

Temperature 0° C to 55° C
Humidity <90% up to 40° C
Altitude <4572 metres (15,000 feet)

This instrument should also be protected from temperature extremes that would cause condensation in the instrument.

4-3. POWER REQUIREMENTS

The 54110D requires a power source of 115 or 230 Vac +15/-25%; 48-66 Hertz single phase. Power consumption is 350 watts maximum or 650 VA maximum.

CAUTION

Before connecting this instrument to the AC power source, insure that the line select switch on the rear panel of the instrument is set to the appropriate position (see figure 4-1).

A blade-type screwdriver may be used to change the position of this switch. Figure 4-2 shows the line select switch set for 115 Vac operation. If this switch is not set correctly, serious damage to the instrument is likely.

Once the correct setting on the line select switch has been made and the appropriate power cord has been installed and connected to the mains, the unit can be turned on (see paragraph 4-4). By selecting the appropriate line voltage with the line select switch, you are also determining the correct circuit breaker trip current. If 115 Vac line voltage is selected, the circuit breaker trip current will be 5 amps. If 230 Vac line voltage is selected, the circuit breaker trip current will be 3 amps.

Model 54110D - Getting Ready to Use the HP 54110D

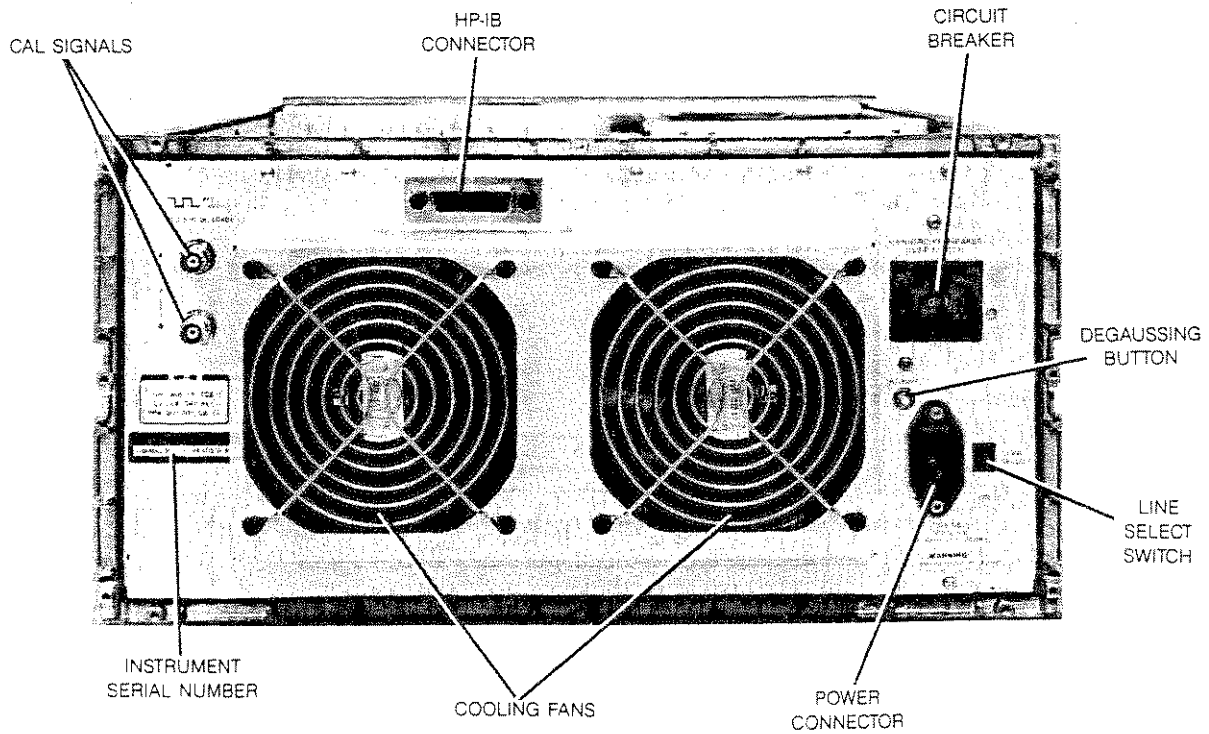
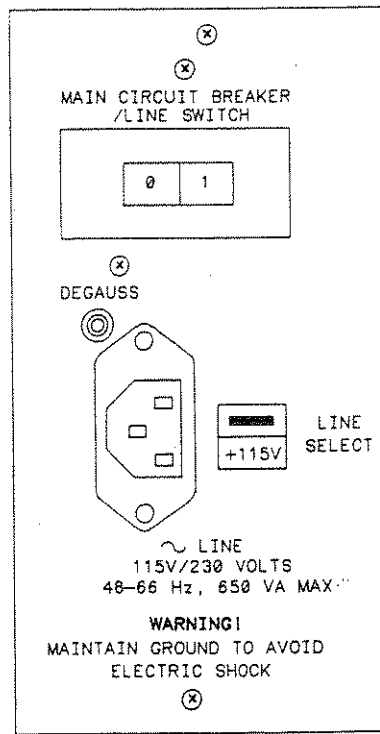

Figure 4-1. HP 54110D Rear Panel



M5411017

Figure 4-2. Power Module

The 54110D has two switches that can interrupt the power for the instrument. The first is the line switch and the second is the mains breaker:

1. The line switch is located at the lower left of the front panel.
2. The mains breaker is located on the upper right hand corner of the rear panel (see figure 4-1).

If the front panel line switch is in the "STBY" position or if the mains breaker is in the OFF or "0" position, the unit will not function.

4-4. POWER CABLE

WARNING

Before energizing this unit you must insure that the chassis of the instrument is properly grounded. This precaution is to avoid the possibility of injury or death which may result if the protective ground is defeated.

The 54110D is provided with a 3-wired power cable. When this cable is connected to an appropriate AC power receptacle, it provides a ground for the instrument cabinet. The type of power cable shipped with each instrument depends on the country of destination. See table 1-1 for power cable description and applications.

4-5. HP-IB ADDRESS SELECTION

HP-IB address can be read and selected from the front panel of the 54110D with the use of soft keys that are located at the right of the CRT (after pressing the Utility menu select key). In order to set or change the HP-IB address, put the 54110D into the TALK/LISTEN mode (soft key selectable), then input the desired address from the front panel. The 54110D supports the following HP-IB interface functions: SH1, AH1, T5, TE0, L3, LE0, SR1, RL1, PP0, DC1, DT1, C0, E1. For further information concerning the 54110D HP-IB, operation, see Section 9.

4-6. HP-IB INTERCONNECTIONS

Interconnection data concerning the rear panel HP-IB connector is provided in figure 4-3. The HP-IB system allows the interconnection of up to 15 (including controller) HP-IB compatible instruments. The HP-IB cables have identical connectors on both ends so that several cables can be connected to a single source without special connectors or switch boxes. System components and devices may be connected in virtually any configuration (see figure 4-4).

4-7. INITIAL COLOR DISPLAY SETUP

The 54110D Color Digitizing Oscilloscope uses an electromagnetic color display and may require degaussing at installation or later if it becomes necessary. To facilitate this, the display section has a built in degaussing coil. The energizing switch for this coil is located on the rear panel on the power panel. (See figure 4-2) To degauss the CRT press this switch several times.

If, in certain severe situations, internal degaussing is not adequate it may be necessary to use an external television type degaussing coil. On the front panel left of the CRT are two screw driver adjust controls; Brightness and Background. The background control sets the luminosity of the background of the CRT. The brightness control sets the gain of the Z axis, that is, controls the intensity of the displayed information on the CRT. These two controls are usually adjusted to accommodate users taste and ambient light.

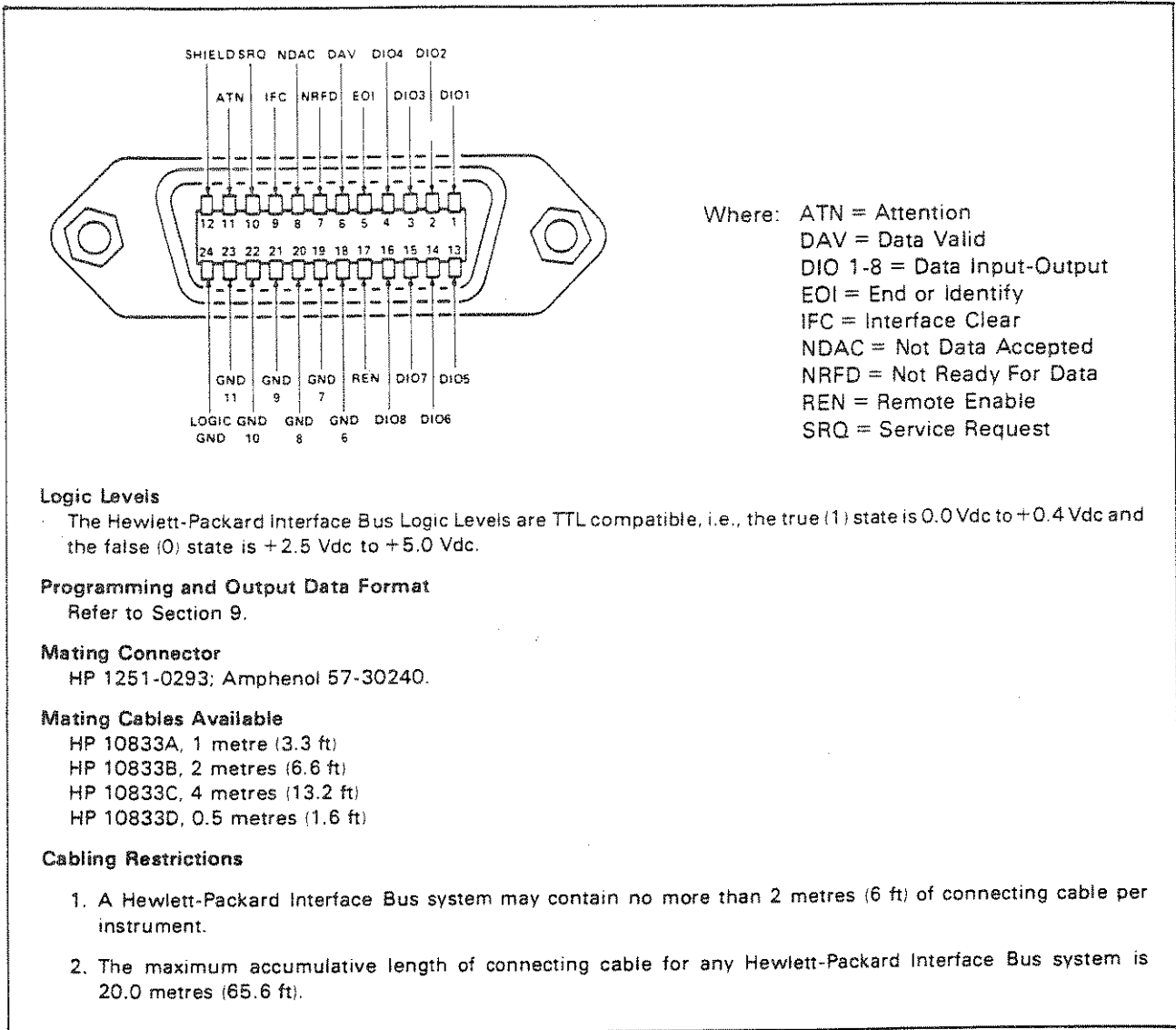

Figure 4-3. HP-IB Interface Connector

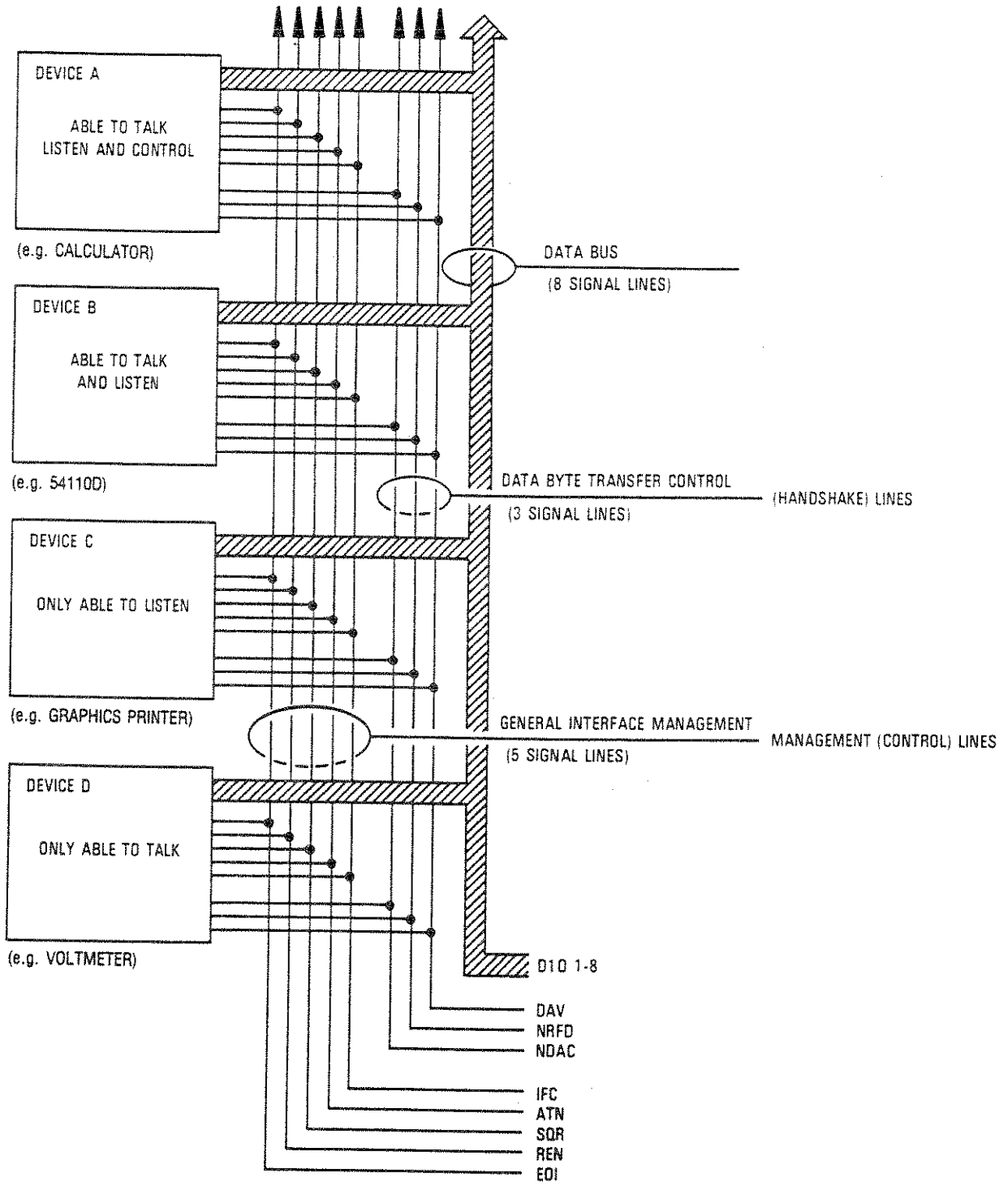

Figure 4-4. HP-IB Interface

NOTES:

SECTION 5 FRONT PANEL

5-1. GETTING STARTED WITH THE FRONT PANEL

This section describes the front panel of the 54110D and discusses its four functional areas. The four functional areas of the front panel of the 54110D Color Digitizing Oscilloscope include:

- A. System Control
- B. Entry
- C. Menu Selection
- D. Function

These four groups of keys give the operator complete local control of the instrument. (See Figure 5-1.)

5-2. SYSTEM CONTROL

The SYSTEM CONTROL keys are located on the top right-hand side of the front panel directly under the label, "SYSTEM CONTROL"

The SYSTEM CONTROL keys provide control of acquisition, the dynamic display, SAVE/RECALL registers and automatic display scaling.

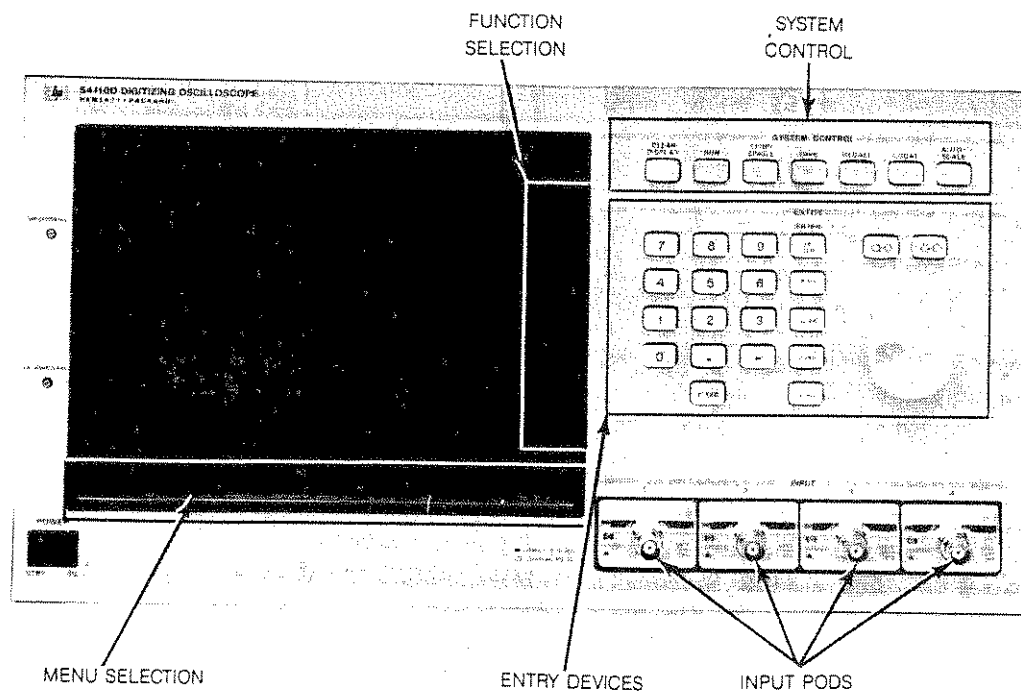

Figure 5-1. 54110D Front Panel

The CLEAR DISPLAY key erases the dynamic (active) display. This key will not erase a waveform in memory that is being displayed. When the CLEAR DISPLAY key is pressed the instrument will momentarily stop acquiring data, erase the screen and then resume acquiring data. If the STOP/SINGLE key has previously been pressed, the CLEAR DISPLAY key will erase the displayed waveform and acquisition will not resume unless the RUN key is pressed, or if a single acquisition is desired the STOP/SINGLE key can be pressed for the second time. If you are acquiring a large number of averages and you change the input signal you can quickly reset the average registers by pressing the CLEAR DISPLAY key. This will save the time that the display would normally take to integrate to the new signal levels.

The RUN key causes the 54110D to resume acquiring data after acquisition has been stopped by the STOP/SINGLE key. When the STOP/SINGLE key is pressed the instrument will stop acquiring data and display, indefinitely, the last data that was acquired. Each subsequent STOP/SINGLE key press arms the instrument to make a single acquisition that would be started by the next trigger event. To return to the previous operating mode press the RUN key. When the STOP/SINGLE key has been pressed the SEC/DIV, VOLTS/DIV and other front panel controls that would normally cause the displayed waveform to change will erase the active display as if the CLEAR DISPLAY key had been pressed.

5-3. SAVE/RECALL

This instrument allows the user to SAVE and RECALL up to ten different front panel setups in nonvolatile memory.

To SAVE the current front panel setup in one of the ten SAVE/RECALL registers, press SAVE, then press the number (0-9) of the register desired. All front panel functions, modes and Cal factors, menu selection and input device assignments are not saved. SAVE/RECALL will not cause execution of measurements, edge finders, "Start Print", or other action keys.

To RECALL a previously saved front panel setup press RECALL, then press the number (0-9) of the desired register.

To return to the condition that existed prior to the last AUTO-SCALE, press RECALL then press AUTO-SCALE. This feature allows you to recover if the AUTO-SCALE is accidentally pressed.

5-4. LOCAL

When the LOCAL key is pressed an RTL (return to local) message is sent to the HP-IB interface and the unit will return to local (front panel) control if it had previously been in remote operation and if the HP-IB controller had not invoked a local lockout.

The LOCAL key is the only active front panel key when the unit is in REMS (remote state).

5-5. AUTOSCALE

When the AUTO-SCALE key is pressed the instrument will select the vertical sensitivity, vertical offset, trigger level and sweep speed for a display of the input signal. If input signals are present at both vertical inputs the sweep will be triggered on Chan 1 and the display will go to the split screen mode and the vertical sensitivity for each channel will be scaled appropriately. If only one of the vertical has a signal on it, the split screen function will be turned off. See Operating Characteristics for input signal requirements for proper AUTO-SCALE operation.

When the AUTO-SCALE cycle is complete, the Timebase menu will be selected and the input devices will be assigned to the SEC/DIV function.

5-6. ENTRY DEVICES

Under the SYSTEM CONTROL keys is an area labeled ENTRY. Located in this portion of the front panel is a number pad, a vertical column of 5 ENTER keys, the "knob" and two step keys, (refer to figure 5-1). These four items are referred to, throughout this manual, as the "entry devices".

The entry devices are used to change the value of any of the items in the function menus that are displayed in UPPER CASE letters e.g., VOLTS/DIV and SEC/DIV. The function menus are on the right side of the CRT.

The value of the selected variable function is listed at the top of the waveform display area on the CRT.

5-7. MENU SELECTION

Softkeys provide front panel control of the 54110D color digitizing oscilloscope.

This instrument has two sets of softkeys, the first set is located at the bottom of the CRT, and the second set is right of the CRT. The keys at the bottom of the CRT are referred to as the "menu selection keys" as they are used to choose a desired function menu. As you press the different function menu selection keys the function menus along the right side of the CRT will change. Pressing the More key at the bottom right-hand corner of the CRT provides an additional seven function menus. If the More key is pressed again the original menu will return.

After you have selected a function menu, notice some of the function menu softkey labels have text shown in inverse video. If the adjacent softkey is pressed the text that is in inverse video will change, e.g., to turn a function On or Off, or to activate an associated function, e.g., pattern trigger, edge trigger, state trigger. If the function select key allows you to select a waveform source the text of the selected source will be the same color as the displayed waveform from that source, for example, if the default colors are used all text relating to channel 1 will be yellow and all text relating to channel 2 will be green.

When a softkey with an upper case label is pressed the label will typically change to a color associated with the function that has been selected to be slaved to the input devices.

The third type label for function softkey will have the first letter of each word in upper case and there will be no inverse video text associated with the label. When a function key with this type of label is pressed the function will execute. This type of label is used primarily in the Measure and Utility menus.

NOTES:

SECTION 6 FAMILIARIZE YOURSELF WITH THE MENUS

6-1. FAMILIARIZE YOURSELF WITH THE MENUS

This section contains a description of the front panel operation of the 54110D. Operating details and front panel layout are discussed in detail. You should read this section completely before continuing to Sections 7 and 8.

6-2. VERTICAL

After you have energized the unit, connect one of the cal signals from the rear panel to the channel 1 input. The most convenient method of scaling the vertical and horizontal is to press the AUTO-SCALE key. This key causes the 54110D to evaluate the vertical inputs and scale the vertical and timebase for a triggered and appropriately scaled display. See Operating Characteristics in Section 1 for limitations of AUTO-SCALE.

6-3. AUTO-SCALE

When the AUTO-SCALE key is pressed, the DELAY will be set to 0 seconds and referenced to center screen. The instrument will be left in the Timebase menu with SEC/DIV the assigned function for the Entry Devices.

Rotate the "knob" and notice the sweep speed change, enter "1" from the key pad and press the μ sec entry key, the sweep speed will go to 1 μ sec/div. Next alternately press the step keys, the sweep speed will either sweep faster or slower depending on which step key is pressed. These three devices are referred to as the Entry Devices and are used to change variable functions on this instrument.

If no signal is detected on the inputs, a red error message will state "No signal found".

If there is a signal present at the inputs of both channels, the 54110D will go to the split screen function, that is, channel 1 will be displayed in the top half of the display and channel 2 will be displayed in the bottom half of the display. The unit will be set to trigger on channel 1.

6-4. CHANNEL 1 and CHANNEL 2 MENUS

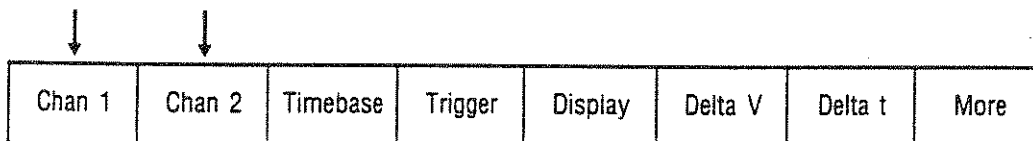

When Chan 1 or 2 is selected, one of three channel modes will appear on the right side of the display, (see Figure 6-1). The first is the Normal mode, the second is the Magnify mode, and the third is the Func 1/2 on. The normal and magnify modes have associated menus, and the func1/2 modes do not. Func1/2 can be turned off or on in the Wfm Math menu. When they are on, they replace chan 1 and 2 respectively. Chan 1/2 and Func 1/2 are displayed in the same color respectively.

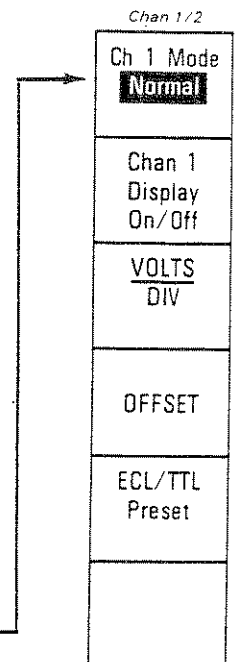

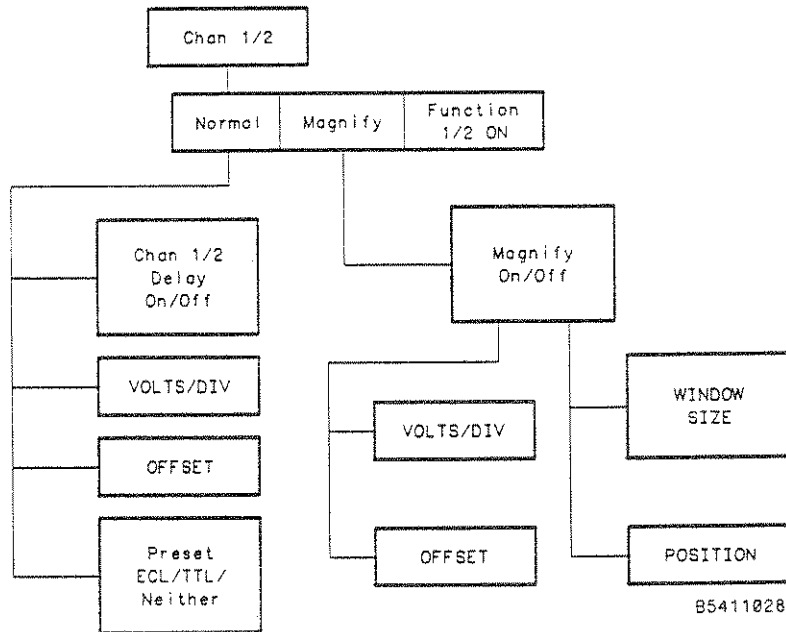

Figure 6-1. Chan 1/2 Menu

6-5. NORMAL MODE

The Normal mode should be selected when the entire vertical magnitude of the input signal needs to be observed. When operating in this mode, you should not adjust VOLTS/DIV or OFFSET in such a fashion that the signal will be off scale vertically as erroneous results may be acquired.

The display On/Off key is the second from the top. Push it and notice that the Chan 1 signal disappears and reappears depending on whether On or Off is selected. This function key turns off the display for a particular channel. It does not stop that channel from acquiring data. Next is the VOLTS/DIV key which when selected will allow the vertical sensitivity to be changed in a 1-2-5 sequence in three ways: (Note; a 1-2-4 sequence is used when are in the split screen mode).

1. Vertical sensitivity can be changed by using the number pad on the Entry portion of the front panel. After a number on the key pad has been pressed, the appropriate "units" key must be pressed to complete the operation. The units keys are located just to the right of the key pad. Note: In the Normal mode all entries other than 1-2-5 will default to the nearest 1-2-5 range. In the Magnify mode, sensitivity can be entered to 3 digit resolution.
2. The knob may be used to change the vertical sensitivity.
3. The step keys, located just above the knob, may be used to increment or decrement the vertical sensitivity.

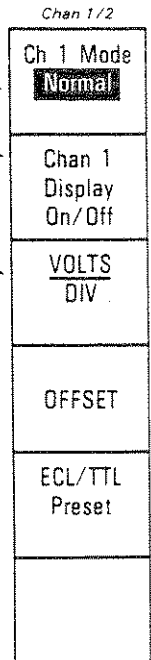

These three entry devices may be used on any function menu item that is written in UPPER CASE letters. Notice that as these upper case functions are selected they assume the color of the source that they are associated.

The next function key is OFFSET which when selected allows the trace to be moved up or down by using the number pad, the knob, or the step keys. This function works much the same way as a conventional oscilloscope position control. The OFFSET voltage as referenced to center screen is shown at the top of the waveform display area.

The next function key is the Preset key. This key provides three choices:

1. ECL
2. TTL
3. Neither

When ECL or TTL is selected for a channel the instrument automatically selects the correct OFFSET, VOLTS/DIV, and TRIG LEVEL for the logic family that was selected. If the ECL or TTL function is selected the selection will be highlighted. When neither preset is desired, press the preset key until neither ECL or TTL is highlighted. The OFFSET, VOLTS/DIV, and TRIG LEVEL will then return to their previous settings.

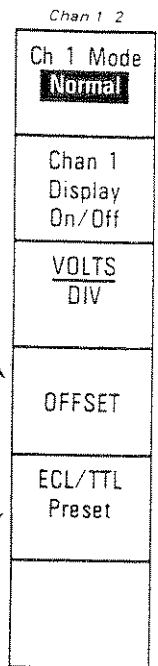

6-6. MAGNIFY MODE

When the magnify mode is selected, Magnify can be turned On/Off by pressing the Magnify On/Off key. When Off is selected there will be two variable functions on the vertical function menu; WINDOW SIZE and POSITION. They can be changed by using any of the entry devices i.e., step keys, the knob, or number pad. The horizontal lines that define the window can be moved closer together or farther apart by manipulating the entry devices. The window defines the range that will be displayed full scale when Magnify is keyed on. When the POSITION function is selected, the user can move the window on the vertical axis by using the input devices. Note: This is different from vertical position; the window moves not the signal. The Magnify function is easy to demonstrate:

Connect the cal signal to Chan 1 and push AUTO-SCALE.

Select:

- Mode = Magnify
- Magnify = Off
- Display = Averaged
- # of Averages = 64

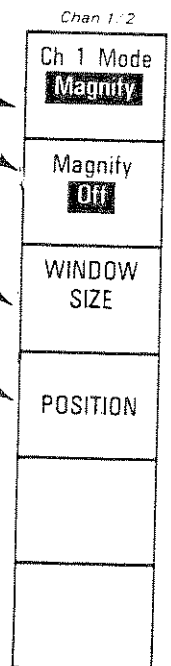

Alternately select and adjust the WINDOW SIZE and POSITION so the window is about the pulse top. When Magnify is turned On the portion of the signal that was defined by the window will fill the display. The vertical sensitivity or offset for the magnified display is shown at the top of the waveform display area.

The vertical sensitivity and offset can be adjusted in the Magnify mode by selecting the appropriate function key and using one of the entry devices.

You would use the magnify function if you wanted to evaluate a small signal such as a reflection or overshoot that was present on large signal. Magnify can also be used to provide increased vertical sensitivity.

The Magnify mode allows higher vertical resolution, up to 16X magnification in the average mode. Note, the magnify mode is most useful when the instrument is in the average mode.

6-7. TIMEBASE MENU

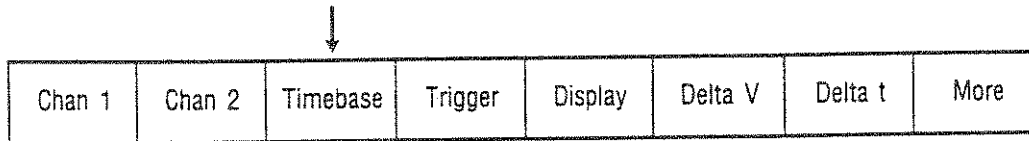

After the AUTO-SCALE system control key is pressed you will notice that the instrument has established itself in the timebase menu and the SEC/DIV function.

The Timebase menu contains two variable functions. Note: Variable functions are identified by UPPER CASE LABELS. (See Figure 6-2.)

The SEC/DIV function allows the time scale on the X-axis to be varied from 1 sec/div to 100 ps/div in a 1-2-5 sequence by using the entry devices. Sweep speeds can be entered from the number pad with up to 3 digits of resolution.

The effect is very similar to turning the time/division switch on a conventional oscilloscope.

For sweep speeds slower than 2.5 μ s/div the sampling rate is changed to provide an appropriate display on the CRT.

The DELAY function controls the pre and post trigger delay and can be varied by the entry devices. The adjustment resolution for DELAY time is equivalent to 0.2% of the time interval represented by 10 horizontal divisions (but not less than 2 ps or 1 ppm whichever is greater). The DELAY function has an effect similar to that of a horizontal position control on a conventional oscilloscope, but with the added advantage of having a range of millions of screen widths.

The Delay Ref. key allows you to reference the delay to the right or left graticule edge or center screen. The time at the Delay ref. is equivalent to the delay time. DELAY = 0 is the trigger point.

When the DELAY function is selected, delay time is displayed at the top of the waveform display area. Maximum pre and post trigger time intervals vary with sweep speed and Delay Ref. location.

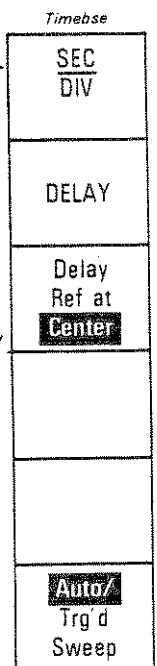

Negative DELAY values infer time before the trigger and positive DELAY values infer time after trigger. The trigger point is at DELAY = 0.

The last key on the Timebase menu is the Auto/Triggered (Trg'd) key. When the Auto sweep function is chosen the unit will provide a baseline on the display in the absence of a trigger signal. If a signal is present, but is not triggered, the display will be unsynchronized but will not be a baseline.

If the unit is in Trg'd sweep and no trigger is present the unit will not sweep, and the data acquired on the previous trigger will remain on-screen.

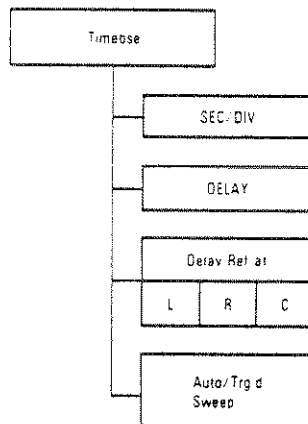

Figure 6-2. Timebase Menu

Always use the Trg'd Sweep function when the trigger rep. rate goes below 20 Hz. to prevent Auto Sweep from generating a sweep prior to the trigger event. The signal on the display that was initiated by Auto Sweep would be asynchronous with the signal on the sweep that was initiated by the trigger event. The oscilloscope will trigger normally if the trigger repetition rate is greater than 20 Hz.

NOTE

The STATUS line in the upper left corner of the screen indicates the current trigger status. It is updated every half second. In the Trg'd sweep mode the STATUS line indicates whether the instrument is "Running" or "Awaiting Trigger". In the Auto Sweep mode the STATUS line indicates whether the instrument is "Running" or "Auto Triggering". Other status indications are "Stopped", "Measuring", "Printing", "Plotting", and "Testing". The 20 Hz auto trigger repetition rate applies even for long DELAY or large SEC/DIV settings.

6-8. TRIGGER MENU

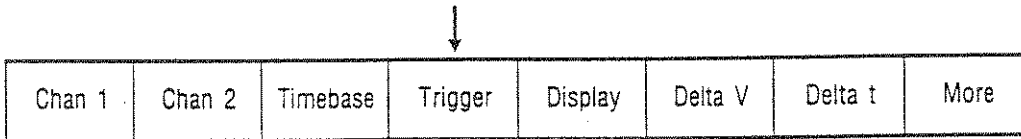

The Trigger menu allows you to select trigger mode, source, slope and holdoff. This menu also is used to invoke the unit's combinatorial triggering capability (logic pattern triggering). (See Figure 6-3).

When previewing the trigger menu notice the five trigger modes: Edge, Pattern, State, Time-Delay, and Event-Delay modes. Let's first discuss the Edge Mode. Edge Mode allows you to select one of four trigger sources (Trig Src), adjust the trigger level (TRIG LEVEL), select the slope of the input signal that is to be used to define the trigger (Pos/Neg), and define the HOLDOFF in Time or Events.

The Trig SRC key permits the selection of one of four possible trigger sources; Chan 1, Chan 2, Trig 3, or Trig 4.

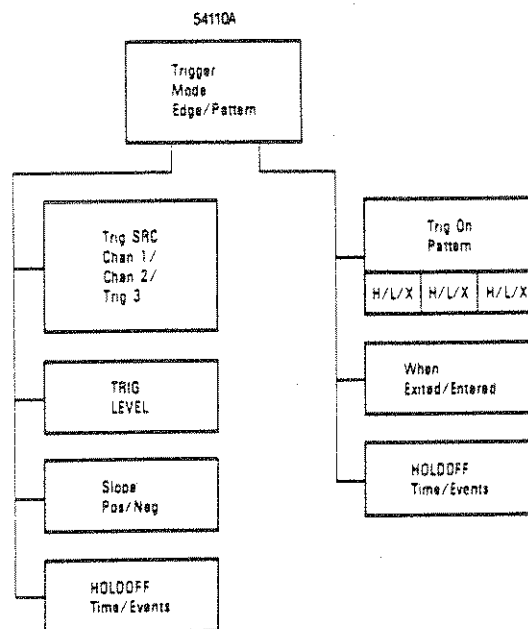

Figure 6-3. Trigger Menu

If Chan 1 or 2 is selected as the Trig Src a horizontal line (orange) will appear on the display showing the TRIG LEVEL with respect to the displayed signal when TRIG LEVEL is assigned to the entry devices.

Slope selects the Neg or Pos slope of the input signal to be used as the trigger. The trigger slope and level can be set independently for each channel and the settings for the channel will be retained even though another channel is selected as the trigger source, or another trigger mode is selected.

The HOLDOFF circuitry allows you to define the period following a trigger event during which the trigger circuit is disabled. By pressing the HOLDOFF function key you can determine whether the HOLDOFF is to be defined by time or events. An event is defined as a change in the input that satisfies the trigger conditions. If Time is used to define holdoff the range is from 70 ns to 670 ms. HOLDOFF by Events range is from 2 events to 6.7×10^7 events. Maximum counting rate for events is 80 MHz.

Holdoff by events can be used to trigger stably on a complex waveform by counting the number of trigger events that are to be skipped before accepting another for a trigger. By setting the holdoff by events to one less than the number of events occurring over the fundamental period, a stable display will result. Holdoff by events is equivalent to placing a divide-by-N counter in the trigger path where N is one plus the holdoff value.

Unlike conventional oscilloscopes the trigger system in the 54110D is completely independent of the timebase. This means that adjusting the DELAY or SEC/DIV functions will not disturb the display synchronization established with holdoff. Also, it should be noted that auto sweep acts on the repetition rate of accepted triggers so holdoff by time values greater than 50 ms or large holdoff by events values can result in a low effective trigger repetition rate. In this case the Trg'd sweep function should be used. Holdoff can be varied by using any of the entry devices and is displayed at the top of the waveform display area.

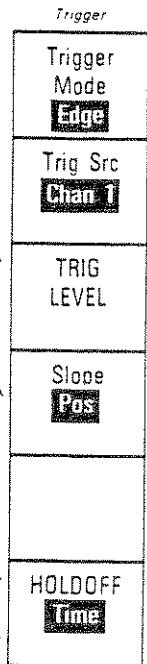

6-9. PATTERN MODE

Press trigger mode function key to access the Pattern Mode. In this mode you have 4 bit pattern recognition capability and the instrument can be triggered either when entering or exiting this pattern. Holdoff can be defined either by events or time.

The label for the Trig On PATTERN function key includes four characters in an inverse video text field. When the Trig On PATTERN key is pressed one of these characters will be highlighted. By using the entry devices you can change this character to one of three letters; X, L, or H. Pressing trig on pattern again will sequence through the character field so each can be edited. X indicates a "don't care condition", L indicates a requirement for an input < the trigger level for that input. H indicates a requirement for an input > the trigger level for that input.

The three characters in this text field determine whether the voltage levels at each of the four inputs (Chan 1, Chan 2, Trig 3, and Trig 4) are required to be above or below TRIG LEVEL or are not used as a trigger qualifier. If these characters read "LHXX", Chan 1 would have to be below the trigger level, Chan 2 would have to be above the trigger level to satisfy the pattern condition.

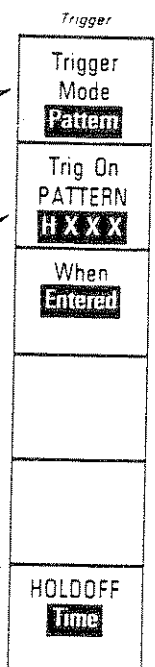

NOTE

Set the TRIG LEVEL for each trigger source while you are in the Edge mode. These trigger levels must be set before going to the Pattern mode or proper Pattern triggering may not occur.

The next key on the function menu is the When Entered/Exited key. When this key is pressed the inverse video text field next to the key will change from Entered to Exited or vice versa. If When Entered is selected, the unit will generate a trigger on the last transition that makes the PATTERN true. If When Exited is selected the unit will generate a trigger on the first transition on any of the inputs that cause the pattern to be false, after it was initially true.

When you are in the pattern mode and you have pressed the Trig On PATTERN key the condition that a particular input must be in to satisfy the requirements the pattern requirements will be shown at the top of the waveform display area.

If When Present > is selected, a trigger event will occur if the trigger pattern is true for a minimum time period. This period is listed in the label for the time key and can be varied from 10 ns to 5 sec. by the entry devices.

When the trigger pattern remains true for the required period of time, a trigger will occur when any of the inputs transition to a false state.

If the pattern becomes true and then goes false before the specified time, no trigger will occur.

If When Present < is selected, a trigger will occur only if the trigger pattern is satisfied and one of the inputs transitions to a false state before a given time period. In this mode, the pattern must be true for at least 1 ns to be recognized.

This period is listed in the time key label and can be varied from 10 ns to 5 sec. by the entry devices. Only holdoff by time is available within the when present modes.

Press the Trigger Mode key, the label will change to State. In the State mode one of the inputs is selected as a simple edge source, the other three are used to define a pattern.

A trigger will occur on the edge (pos/neg) when the pattern is true and Is Present is selected. A trigger will also occur on the edge (pos/neg) when the pattern is false and Is Not Present is selected. The threshold is set by TRIG LEVEL when you were in the edge mode. Only holdoff by time is available with the state mode.

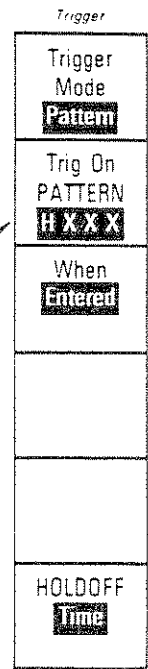

Press the Trigger Mode key and the label will read "Time Dly", (Time Delay). This menu allows you to arm on a signal edge on any source, wait for a period of time and then trigger on an edge from a different source. The edge polarities, the sources that are used to define the edges, and the delay time are all user definable.

The second and third function keys allow you to select the polarity and source of the arming edge. The delay time range is from 20 ns to 5 sec.

The fourth key allows you to define a waiting period between the arming edge that is used as a trigger qualifier and the edge on which the instrument triggers.

The fifth and sixth function keys allow you to select the polarity and source of the edge that is used as the trigger event.

The last trigger mode is Evnt-Dly, (event delayed), This menu allows you to define an edge as a trigger qualifier. Once this edge is detected the unit will trigger after a definable number of edges on any other source.

The second and third keys on the menu allow you to select the polarity and source of the arming edge.

The fourth key allows you to determine the number of edges on the trigger source that are to take place before the trigger event.

The fifth and sixth keys allow you to determine the polarity and source of the triggering and counting edge.

In the edge mode TRIG LEVEL is used to specify a threshold for each source independently. It is these thresholds that are in effect in all other modes wherever a source is active in a triggering function. Other than thresholds there is no interaction between the trigger menus. Changing slopes or patterns in one menu will not affect corresponding entries in other mode menus.

In most of the triggering modes it is possible to specify parameters which will reduce the effective trigger repetition rate (display triggers) to below 20 Hz. Since the auto sweep function measures the rate of display triggers the timebase should be put in Trg'd mode to avoid premature automatic triggers with large event delay counts, filter times etc.

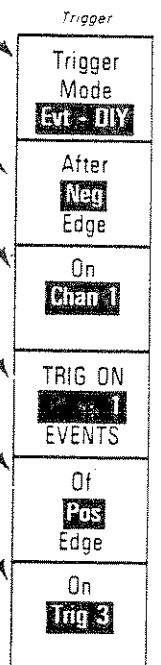
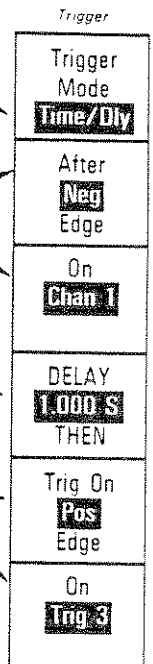

54110D
Trigger Menu
Trigger Mode

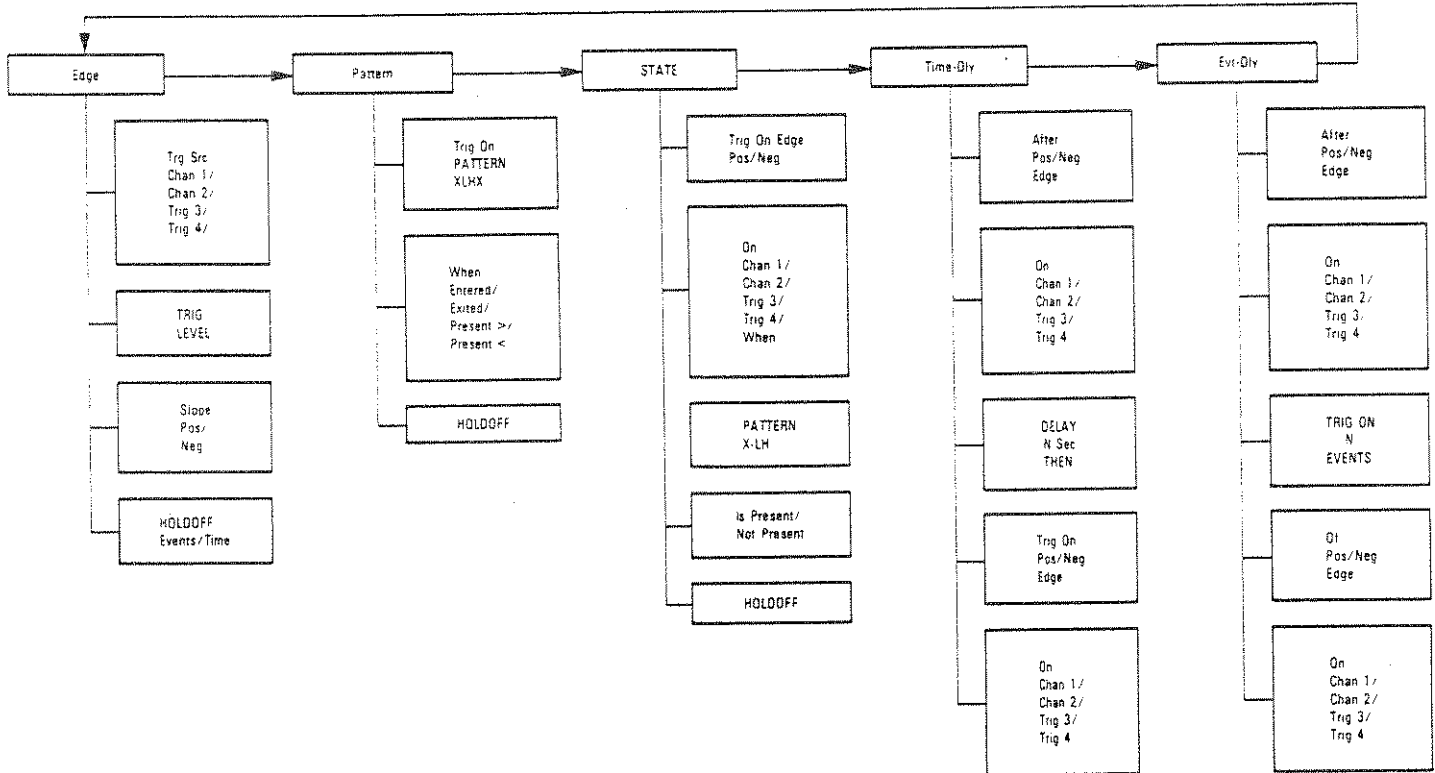
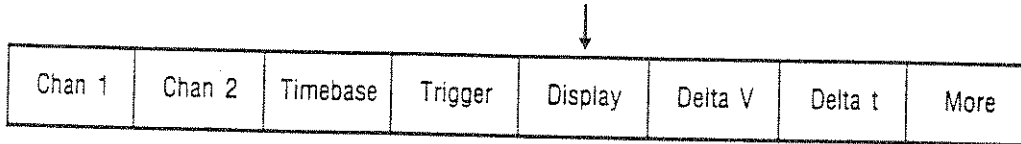

Figure 6-4. Trigger Menu

6-10. DISPLAY MENU



When the Display function menu is chosen two modes are available, Normal and Averaged. (See figure 6-5.)

In the Normal mode each displayed data point is displayed for a period of time defined by the user. You can vary the DISPLAY TIME (persistence) from 200 ms to infinity.

In infinite persistence the data points will remain on the display until the CLEAR DISPLAY key is pressed or until the sweep speed, vertical sensitivity or trigger level are changed. The persistence is shown at the top of the waveform display area.

If variable persistence (persistence other than infinite) is selected, you have a flexible display that changes with variations in the input signal but stores the signal indefinitely on the display if the trigger is lost and the unit is in Trg'd Sweep.

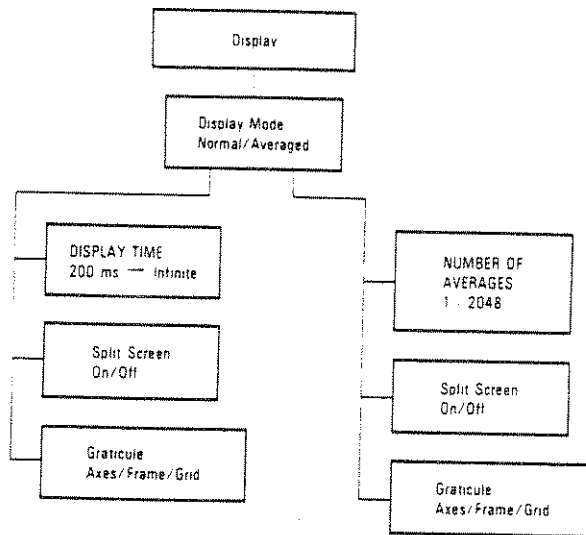
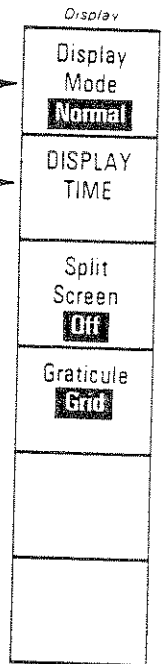

Figure 6-5. Display Menu

Model 54110D - Menus

A minimum persistence setting is useful when the input signal is changing and the user needs immediate feedback, such as in rapid probing from point-to-point, or setting the amplitude or frequency of a signal source. More persistence is useful when observing long-term changes in the signal or low signal repetition rates. At fast sweep speeds and low trigger rep. rate conditions more persistence is needed to gain an adequate number of data points on the display. Infinite persistence is useful for worst-case characterization of signal noise, jitter, drift, timing, etc.

There is a limit to the number of data points that can be displayed on the screen at any one time in the variable persistence mode. The display time is temporarily reduced whenever the number of points exceeds 5,600. This has the effect of reducing the number of data points on the display. When this happens you might see the display appearing to pulsate, that is, a number of points will accumulate and then the display will fade and build up again, etc.

If Averaged Mode is selected the last acquired data points are averaged with previously acquired data before they are displayed. The number of data points that is averaged is variable from 1 to 2048. The step keys and the knob change the number of averages in powers of 2; however, any number of averages between 1 and 2048 can be entered from the key pad.

Vertical resolution can be extended and displayed noise can be significantly reduced by using the averaged mode. As the number of averages is increased, the display becomes less responsive to changes to the input signal(s); however, noise is reduced, and resolution is improved as more averages are used. By selecting the appropriate number averages the throughput for the automatic pulse parameters or the precise edge locators can be controlled. Since these automatic measurements use averaging the user can trade off the speed of the measurements against the repeatability of the measured results.

The input signal is digitized and each data point is assigned a time slot relative to the trigger. In the averaging mode the unit calculates the average of the most recent data point with the previous values in the same time slot. You can define the number of data points that are to be averaged from 1 to 2048. Each average is calculated from data acquired for each time slot, data for adjacent time slots is not averaged together.

The current number of averages which have been accumulated is listed on the second line of text in the upper left of the screen. When a precise measurement is made in the average mode, this readout displays the running number of averages for the measurement. Because only data points in the same time slot with respect to the trigger are averaged together, averaging does not reduce the bandwidth or risetime of the acquired waveform.

The next function key on the display menu is the Split Screen key. When split screen is keyed On, Chan 1 or Func 1 will be presented in the upper half of the display and Chan 2 or Func 2 in the lower half. Scaling accuracy is maintained as this function is turned off/on. When the split screen function is keyed off Chan 1 or Func 1 and Chan 2 or Func 2 will be overlaid on the display area.

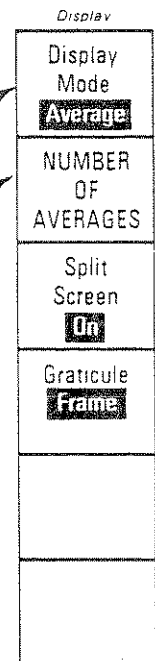

NOTE

In the split screen mode each channel occupies 4 vertical divisions rather than 8 as is the case when split screen is off. This requires the vertical sensitivity in volts/div be doubled.

Three different graticules are available in the display function menu. Press the graticule key and cycle through them to see how they appear. You will find that using the frame graticule makes it easier to see the Delta V and Delta t markers.

6-11. DELTA V (VOLTS) MENU

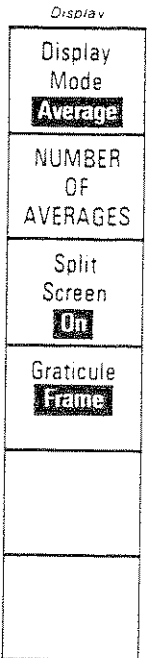
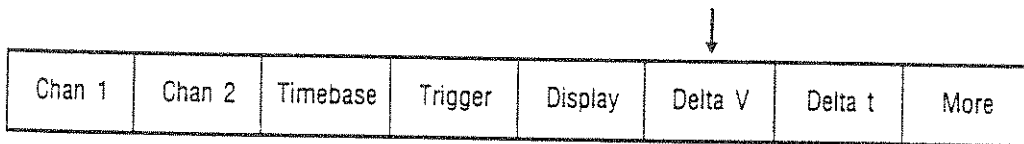

When the Delta V (delta volts) menu is enabled, two markers are displayed. These markers can be used to make absolute voltage measurements on the signal under evaluation or as reference markers when adjusting a signal to a given amplitude. (See figure 6-6)

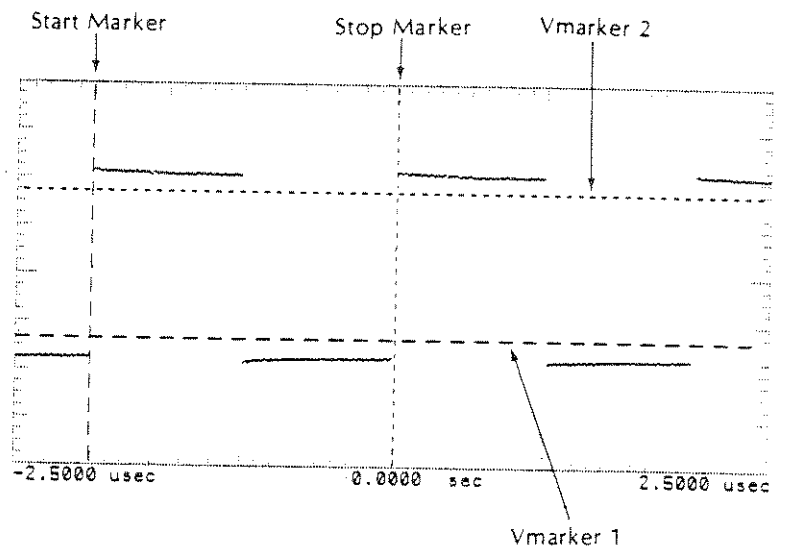
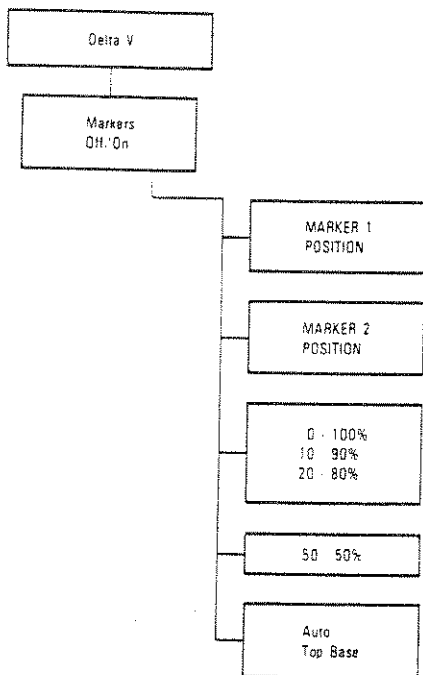

Figure 6-6. Delta V Menu

Figure 6-7. Vmarkers

Model 54110D - Menus

Once the delta V menu is selected, the markers cannot be activated unless the display for chan 1 or 2 or func 1 or 2 or memory 1-4 is turned on. Choose the source you would like to evaluate and enable the V markers. Observe the next two functions on the delta V menu, MARKER 1 POSITION and MARKER 2 POSITION. (See figure 6-7.)

After assigning the markers to the desired channel(s), func(s), memory or memories selecting marker 1 position and marker 2 position function keys will allow you to position the markers vertically with the entry devices. The voltage shown at the top of the waveform display area indicates the voltage level of the selected V marker. Note: if you are using the default color, set the V marker you have selected and it's label will be orange. Delta V (also orange), the difference between the two markers, is shown in the factors area at the bottom of the display.

In the lower portion of the display are the "display factors", these factors include the delta V value and the absolute value for each marker. The delta V function simplifies waveform measurements.

The next three keys on the delta V menu automatically position the V markers on the display. The 0-100/10-90/20-80% key causes the instrument to perform some calculations and position the V markers for the user. When the V markers are positioned manually the inverse video field will change to 0-100%. If the key that is showing 0-100% is pressed the label will change to 10-90% and the markers will move to the 10% and 90% points of their previous levels. If the key is pressed again the label will change to 20-80% and the markers will move to the 20% and 80% points of their original levels. The 50-50% key moves both markers to the 50% point of the 0-100% levels.

The Auto Top-Base automatically locates the top and base of the displayed waveform. This is done by evaluating a histogram of the displayed signal.

If either of the V markers are manually repositioned while the function switch is in 10-90%, 20-80%, or 50-50% the original reference will be lost and the label for the key will change to 0-100%.

If two channels/functions/memories are on the Vmarkers can be assigned to either display trace or assigned to Dual where Vmarker 1 can be assigned to one trace and Vmarker 2 is assigned to the other. If Auto 50-50% key is pressed with Vmarkers set to dual, one Vmarker will go to the 50% point of one trace and the second Vmarker will go to the 50% point of the other trace.

Input the cal signal from the rear panel to Chan 1 and press auto-scale. Next select the Delta V function menu and key on the V markers. Now, establish the top-base by pressing auto top-base. To demonstrate the action of the 0-100/10-90/20-80% key, press it several times, notice how it cycles through the three selections and how the V markers move. Press the 50-50% key, this establishes the V markers at the 50% point of the signal.

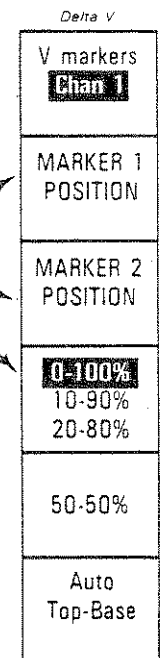
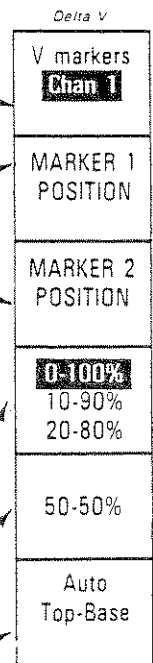

6-12. DELTA T (TIME) MENU

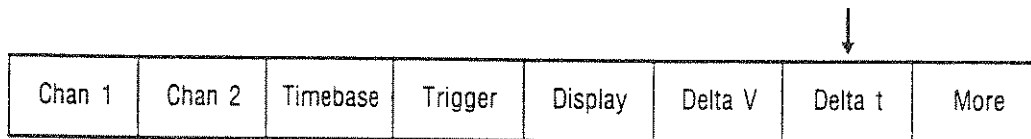

The Delta T function menu provides control for two T (time) markers that can be used to make measurements in the time domain. The display factors include Δt which is the time interval between the two t markers. In figure 6-8 the Start marker = 2 us and the Stop marker = 0 sec. These times tell you the time between the T markers and the delay ref. (See figure 6-8.)

After the t markers have been enabled, each t marker can be moved manually by selecting START MARKER or STOP MARKER and using the entry devices. The time between the selected t marker and the trigger event is listed just above the waveform display area on the CRT.

The Delta t menu is extended when the Delta V markers are turned on. START ON EDGE, STOP ON EDGE, and Precise Edge find Functions are available on the Delta t menu when the Delta V markers are on. Try this exercise to demonstrate these capabilities.



Connect the cal signal to Chan 1 and press the AUTO-SCALE control key. Select the delta t menu and turn the t markers on. Manually move the start marker so that it coincides with the first positive leading edge of the cal signal (figure 6-7). This is one way of making a time interval measurement.

In the display factors, the start marker is approximately 2 us ahead (-2 us) of the trigger event (delay = 0) which was established at center screen when you used AUTO-SCALE. The stop marker is located approximately center screen and the time interval between the t markers (delta t) is approximately 2 us.

Select the delta V menu and turn the V markers on. Press auto top-base then press 50-50%. For this measurement the significant thing is to make sure that the V markers intersect the rising and falling edges of the signal.

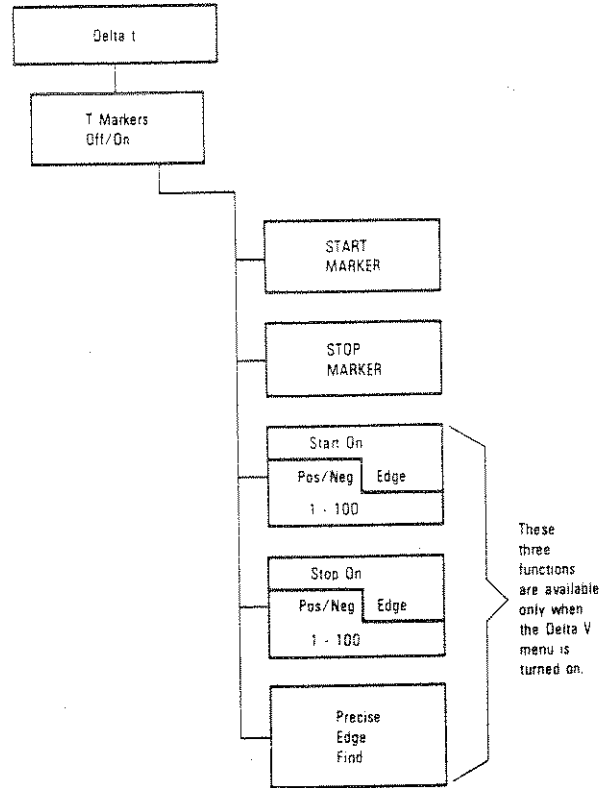

Figure 6-8. Delta t Menu

Return to the delta t menu. Press START ON EDGE function key several times, notice that the pos/neg indicator alternates and the start marker moves from the positive edge of the first pulse to the negative edge of the same pulse. Try using each of the entry devices to move the START EDGE to another pulse. STOP EDGE can be changed in this fashion also. Start on edge and stop on edge are "coarse" edge locators in as much as data already collected on screen is used to locate the edges.

To demonstrate the last delta t menu function, precise edge find, return to the delta V menu and press auto top-base to locate the top and base of the cal signal, then select 10-90%. Now again return to the delta t menu. Set start edge to pos 1 and stop edge to pos 1 and press precise edge find. Δt (in the factors field) will represent the rise time of the pulse, in this case approximately 2 ns. Note that the instrument automatically selects a faster sweep range, to increase the resolution of the edge finder.

The precise edge find function initiates an automatic time interval measurement. The instrument will acquire the data, make the measurement and have the delta t and delta V markers visible on the display so that you can see where the automated measurements were made.

When you use the precise edge find function the unit will expand the selected edges defined by the start on edge and stop on edge functions. This expansion is accomplished with newly acquired data. By expanding the edge in this fashion the horizontal resolution is increased. The speed and repeatability of this measurement is influenced by the number of averages. The more averages the more repeatable and slower the measurement will be. Other items that will influence measurement speed and repeatability are: input signal edge speed, repetition rate, signal jitter, starting sweep speed and delay. If the Vmarkers are set to dual and you press auto 50/50, you may do a semi-automated 2 channel time interval measurement by going to the Delta t menu and pressing precise edge fine key.

6-13. MORE

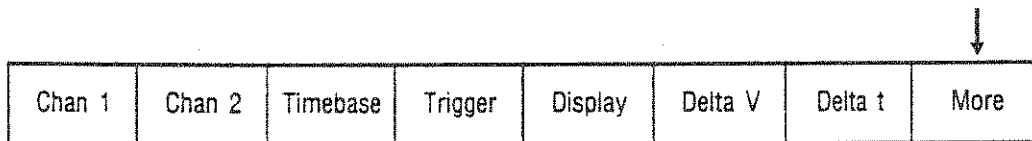

To view the remaining menus press the "More" key. It is located in the lower right hand corner of the display. This key allows you access to seven additional function menus. Pressing the More key again allows you to return to the original set of menu keys.

6-14. WFMSAVE (WAVEFORM SAVE)

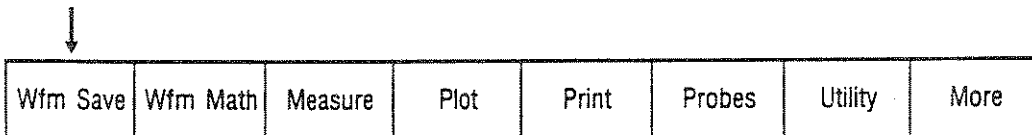

The 54110D has 6 waveform memories available from the front panel; Waveform memories 1 through 4 and pixel memories 5 and 6. (See Figure 6-9.)

When waveforms are stored to one of the four waveform memories the waveform factors are stored as part of the record. These factors include: vertical sensitivity, vertical offset, sweep speed, and time delay. The fact that these factors are maintained allows you to make measurements on waveforms stored in these memories. These waveform records can store only one waveform at a time. If you store a waveform to a memory that contains a waveform record the first record will be written over and lost.

Pixel memories 5 and 6 are 256 by 501 bit memories and are constructed so that multiple waveforms can be stored in each. If more than one waveform is stored to a pixel memory the waveforms will be superimposed. Waveform factors are not maintained when a waveform is stored to a pixel memory, therefore measurements cannot be made on these waveforms. The first function key on the waveform save menu is the WAVEFORM/PIXEL MEMORY select key. When this key is pressed repeatedly the selected memory will cycle through waveform memories 1, 2, 3, 4, and pixel memories 5 and 6. This function is also slaved to the entry devices, that is, the key pad, step keys and the knob can be used to change the selected memory.

The second key allows you to display or not display the waveform(s) in the selected memory. This key also allows you to select either the upper or lower screen to display the memory when the instrument is in the split screen mode.

When memory 1, 2, 3, or 4 is selected the Source for Store key allows you to select the source of the waveform that is to be stored when the store key is pressed. The potential sources are chan 1, chan 2, func (function) 1 and func 2.

In order for a source to be available for the "source for store", it must be turned on. For example, in order to have func 1/2 as a source for store, the selected function first must be turned on using the Wfm Math menu.

When func 1 or 2 are turned on they replace chan 1 and chan 2 respectively, both in the chan 1/2 menus and the wfm save menu, therefore only two of the four sources can be active at any one time.

If you have selected one of the waveform memories i.e., 1-4, the last key on this menu will be the Store key. When you press this key the source will be stored in the selected waveform memory.

The four waveform memories are nonvolatile memories, that is, the data in these memories is retained when the instrument is turned off and then turned back on. The data in the two pixel memories is lost when the instrument is turned off.

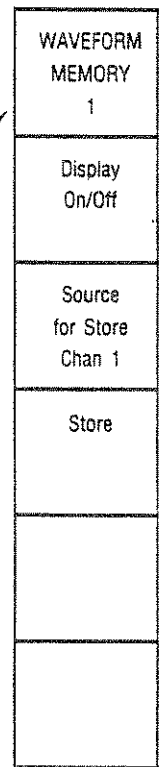

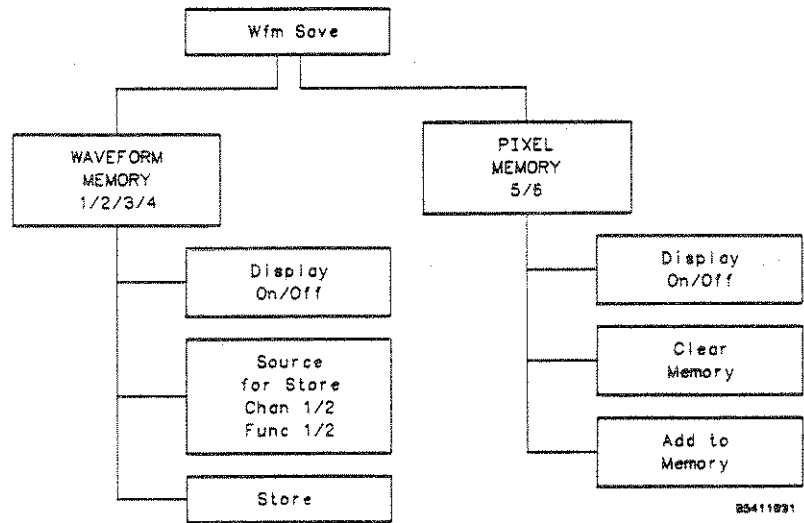

Figure 6-9. Wfm Save Menu

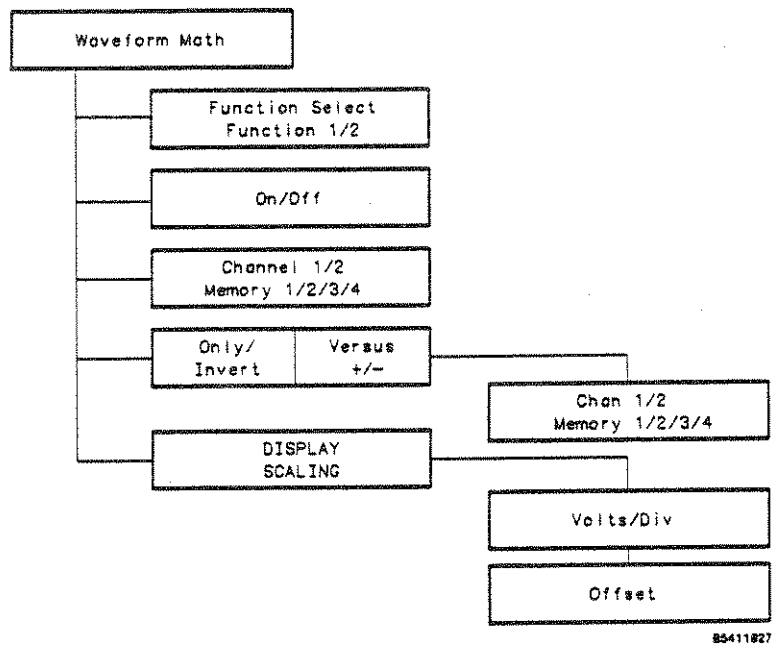

Figure 6-10. Waveform Math Menu

If you select pixel memory 5 or 6 the function menu will change. The third key will change to the Clear Memory key and the fourth key will be the Add to Memory key.

The clear memory key allows you to erase whatever is stored in the selected pixel memory.

When the add to memory key is pressed, whatever data is being displayed in the waveform display area (with the exception of the graticule and markers) will be written to the selected pixel memory, along with whatever data is already there.

6-15. WFM (WAVEFORM) MATH

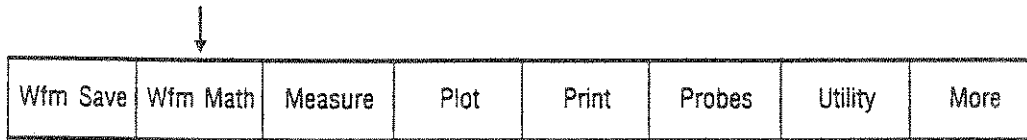

The Wfm Math menu allow you to define two functions (Func 1 and 2) using the channels and waveform memories as operands. The operators are: +, -, Invert, Versus, and Only. This menu also allows you to determine the vertical offset and scaling for the function display. (See figure 6-10.)

The Function Select key allows you to select Func 1 or Func 2 as the active function. The color of the label and the trace of the selected function will correspond to the associated channel, that is, func 1 uses the same color as chan 1 and func 2 uses the same color as chan 2.

The next key allows the display of the selected function to be turned on/off. When a function is turned on it takes the place of the associated channel. For example, if func 1 is turned on the trace on the display will change from chan 1 to func 1. If you select chan 1 menu the ch1 mode will indicate func1 on. If this key is pressed the ch1 mode will change to Normal, and func1 display will be replaced by chan 1. You may toggle the ch1 mode switch and cycle back to func1.

The next key allows the selection of the first operand. The fourth key is used to select the function operator. The choices are; +, -, Invert, Only and Versus. If Invert or Only are selected the second operand is not used.

The next key is used to select the second operand. Your choices are the same as for the first operand.

The last key on the wfm math menu is the DISPLAY SCALING key. This key allows you to slave either the vertical sensitivity (volts/div) or the vertical offset to the entry devices for the display of the selected function. The initial DISPLAY SCALING sensitivity and offset are based on the voltage range of the operands that define the function. When ever the operator or operands are changed the display scaling sensitivity and offset are set to the initial values.

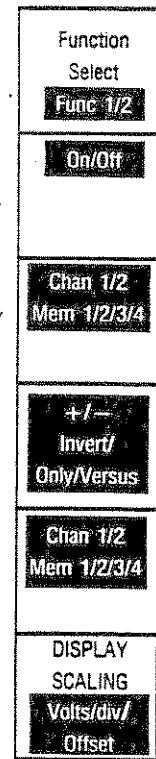

6-16. MEASURE

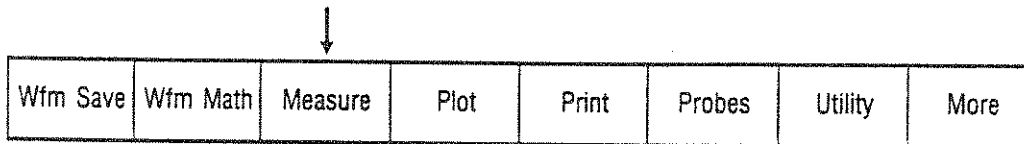

When you press the Measure menu select key, you will have access to three function menus which can be accessed by pressing the more key on the function menu. (See Figure 6-11.) If neither of the channels or the funcs are activated measure will default to chan 1 and measurements will automatically will activate the chan 1 display. In order to make automated measurements on chan 2, func 1, 2 or mem 1 through 4 they must be turned on. To make a measurement on a single waveform memory use the Wfm Save menu and turn the desired memory on. The instrument will not make measurements on a func if the operator is "Versus".

The second key in the first measure menu is the Precision Fine/Coarse. This instrument will perform two types of automatic measurements fine precision and coarse precision. Coarse measurements are made on displayed data. If there is insufficient data on screen, new data is acquired in order to make the measurement. Fine measurements begin with a coarse measurement to locate the edge(s). Each edge is then expanded to achieve maximum resolution. The coarse measurements take less time to accomplish, this should be considered if through-put is a more important issue than measurement resolution. Peak to peak, preshoot, and overshoot measurements are always coarse measurement and use on screen data.

The next function key is the All key, when press the 54110D automatically makes the measurements below and lists the results in the factors area. The More key at the bottom of the menu allows you to select the next measure menu when pressed.

Freq (Frequency)	+ Width	Peak-to-Peak Voltage
Period	- Width	Preshoot
	Duty Cycle	Overshoot
	Rise Time (10-90%)	RMS Voltage
	Fall Time (10-90%)	

The instrument will also make a course measurement, that is, using only data on screen, when the 54110D is in the STOP mode. The stop mode can be selected by pressing the STOP/SINGLE system control key. The instrument will only make course measurements on any of the waveform memories or functions that contain a waveform memory as an operand.

6-17. PLOT

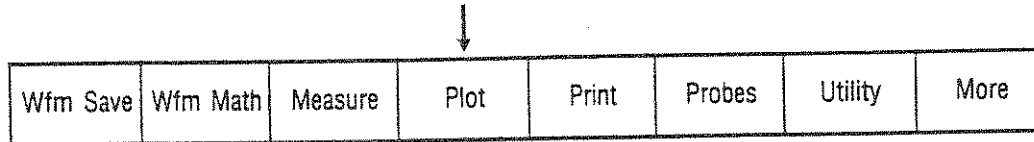

The plot menu allows display data to be output over HP-IB to a digital plotter that is HPGL (Hewlett Packard Graphics language) compatible. (See figure 6-12) The 54110D must be in "Talk Only" and the HP-GL plotter must be in the "Listen Only" mode. The HP-IB mode can be set by using one of the Utility function menus.

The first option on the plot menu is the Auto Pen selection. When this function is On a new pen will be selected when a different function is chosen to be plotted, that is, if the plotter has multi pen capability. If Auto Pen is Off the plotter will not load or change pens when a plot function selected.

The next plot option is Pen Speed. You may choose Fast or Slow if your plotter has this feature. Use slow when you are making overhead transparencies. For best results use slow for Leroy pens.

When Plot Graticule is selected the displayed graticule, including display factors, will be output to the plotter.

If the Display menu is in the Averaged mode, the output from the 54110D will cause the plotter to draw a continuous line plot of the active display.

If the Display menu is in the Normal mode the output from the 54110D is formatted such that the plotter will plot the waveform in a pixel format, that is, dot by dot if you are plotting an active display.

Waveform memories will always be plotted with a continuous line and pixel memories are always plotted dot by dot.

While a plot is being accomplished you can stop the plot by pressing the Abort Plot key. If you would like to stop for a moment and then continue press the Pause/Continue key.

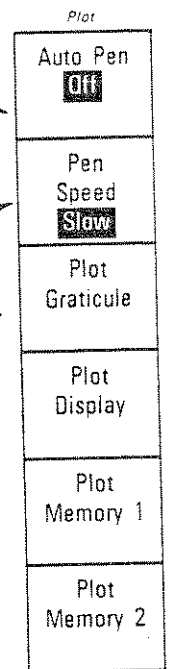

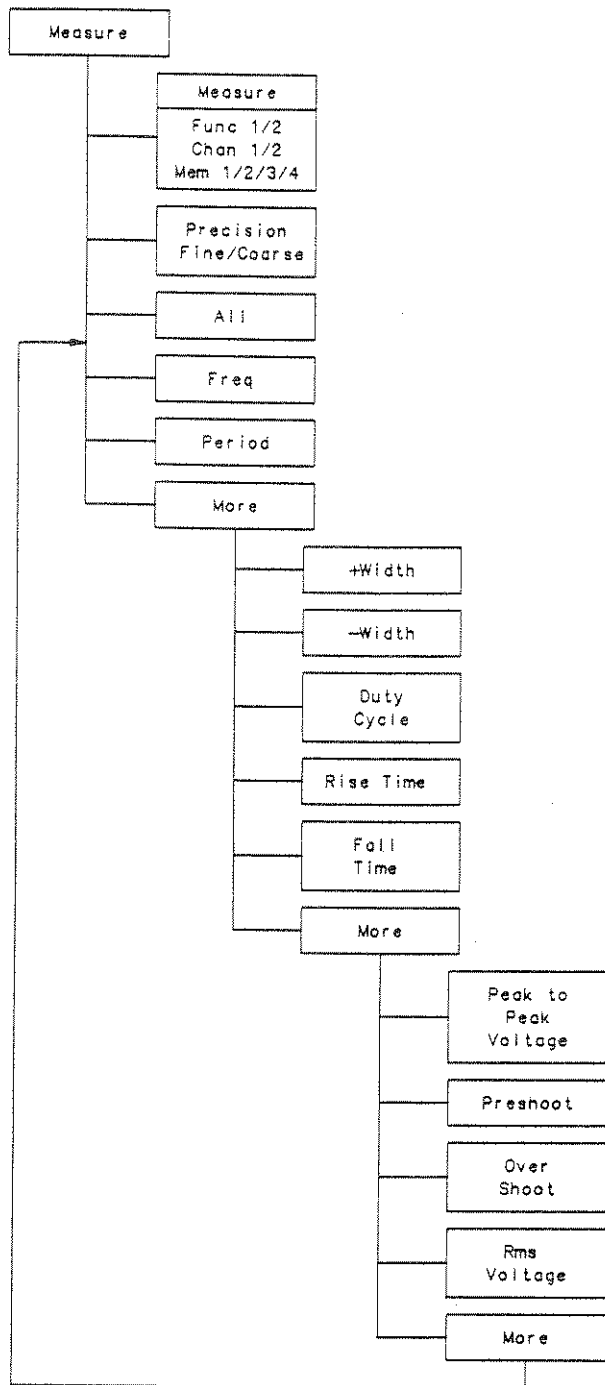
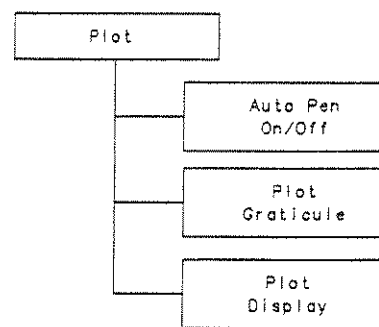

Figure 6-11. Measure Menu



85411937

Figure 6-12. Plot Menu

6-18. PRINT

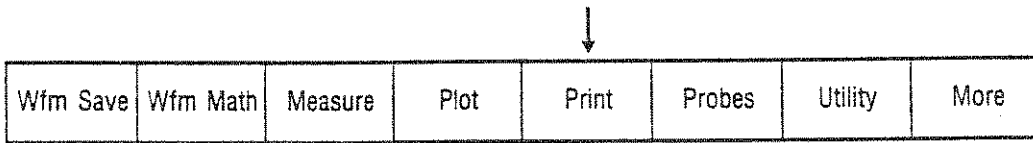

The Print menu allows display data to be output over HP-IB to a graphic printer that is compatible with Hewlett-Packard Raster Scan Standard. (See Figure 6-13.)

The 54110D must be in the "Talk Only" mode and the printer must be in the "Listen Only" mode. The 54110D can be set to talk only when in one of the Utility function menus.

The print function menu offers you two print options, an automatic form feed option and a Start Print key. The two print options allow the selection of the data that is to be output to the graphics printer. Both sources, factors and display may be output separately or at the same time to the printer. The display data includes the graticule and the active display.

If you desire automatic form feed after a hardcopy, key this function on. After the data has been selected for copying, press the Start Print key to initiate the hardcopy. Signal acquisition stops during printing. To stop printing press the Abort Print key.

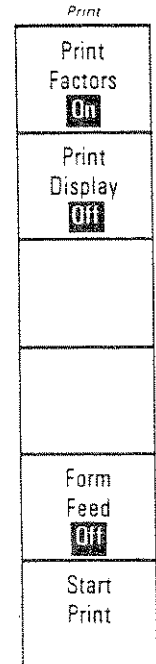

6-19. PROBES

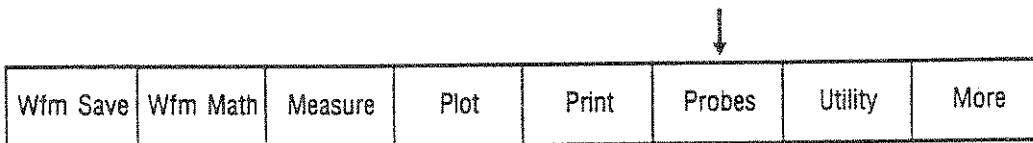

When the Probes menu is selected you can enter any arbitrary attenuation ratio from 1 to 1000 for any of the inputs. Any of the entry devices can be used, however, the key pad allows three digit resolution and can be used as a cal factor for Vmarker measurements. (See figure 6-14.)

When you define a Probe Attenuator Ratio the actual sensitivity at the input of the instrument does not change, all that is changed are the reference constants that are used for scaling the display factors and for automatic measurements, trigger levels, etc.

Attenuation ratios can be saved with the rest of the front panel set up in the Save/Recall registers, however, when power is cycled the attenuator ratios will automatically be reset to the nominal 1:1 for the 54002A and 54003A, and 10:1 for the 54001A active probe, since the 54110D queries the input pod receptacles to determine what pods are installed at power-up.

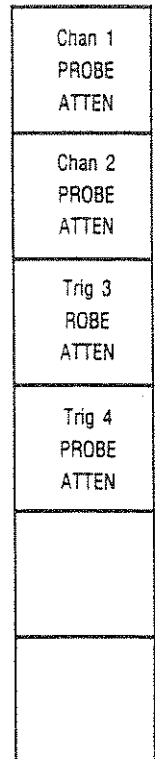

6-18. PRINT

Wfm Save	Wfm Math	Measure	Plot	Print	Probes	Utility	More
----------	----------	---------	------	-------	--------	---------	------

54110/BL12

The Print menu allows display data to be output over HP-IB to a graphic printer.

The HP 54110D must be in the "Talk Only" mode and the printer must be in the "Listen Only" or "Listen Always" mode. The HP 54110D can be set to "Talk Only" in the HP-IB submenu of the Utility menu.

The print function menu offers you three print options, an automatic form feed option, and a Start Print key. The print options allow you to select the data that is to be output to the graphics printer and the type of graphics printer that is in use. Displayed data and factors may be output separately or at the same time to the printer. The displayed data includes the graticule and the active display. The Printer Type option allows the user the choice of printing to a black and white printer or a color printer.

If the Printer Type is set to MONO with a PaintJet connected, a black and white output is produced. However, if the Printer Type is set to COLOR and a black and white printer is connected the system will not work properly.

If you desire automatic form feed after a hardcopy, press the Form Feed key to On. After the data has been selected for copying, press the Start Print key to initiate the hardcopy. Data will not be

Wfm Save	Wfm Math	Measure	Plot	Print	Probes	Utility	More
----------	----------	---------	------	-------	--------	---------	------

54110/BL12

acquired while printing. To stop the print, press the Abort Print key.

6-19. PROBES

When the Probes menu is selected you can enter any attenuation from 1 through 1000 for each of the inputs. Any of the entry devices can be used, however, the key pad allows three digit resolution and can be used as a cal factor for Vmarker measurements. (See figure 6-14.)

When you define a Probe Attenuator Ratio the actual sensitivity at the input of the instrument does not change, all that is changed are the reference constants that are used for scaling the display factors and for automatic measurements, trigger levels, etc.

Attenuation ratios can be saved with the rest of the front panel setup in the Save/Recall registers, however, when power is cycled the attenuator ratios will automatically be reset to the nominal 1:1 for the 54002A and 54003A, and 10:1 for the 54001A active probe, since the HP 54110D queries the input pod receptacles to determine what pods are installed at power-up.

Print Factors <input type="checkbox"/> On
Print Display <input type="checkbox"/> Off
Form Feed <input type="checkbox"/> Off
Printer Type <input type="checkbox"/> MONO
Start Print

54110/BL13

Chan 1 PROBE ATTEN
Chan 2 PROBE ATTEN
Trig 3 PROBE ATTEN
Trig 4 PROBE ATTEN

54110/BL14

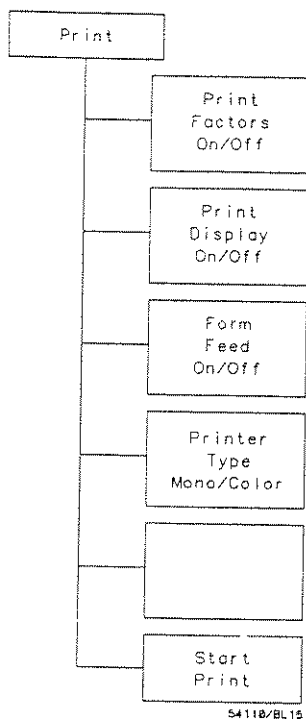

Figure 6-13. Print Menu

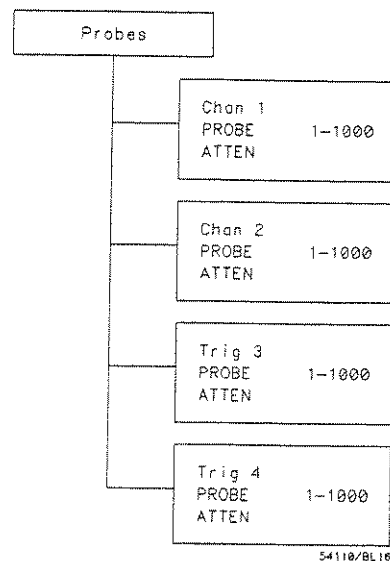

Figure 6-14. Probes Menu

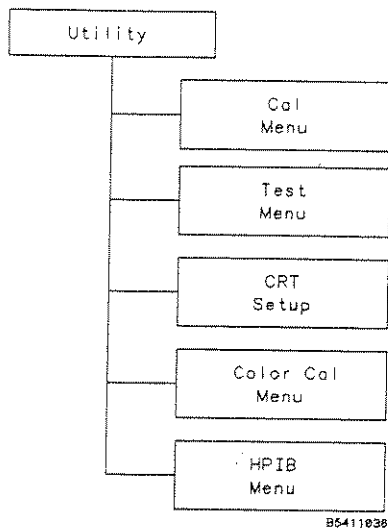

Figure 6-15. Utility Menu

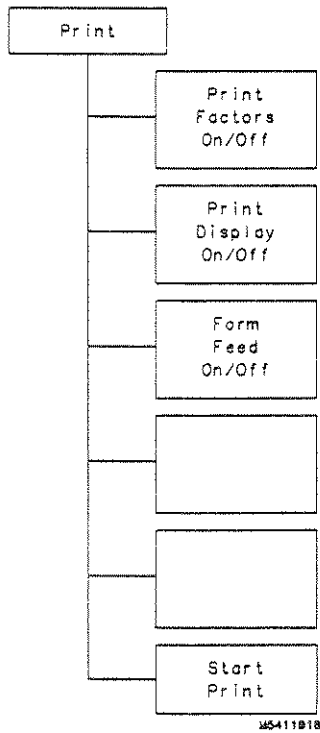

Figure 6-13. Print Menu

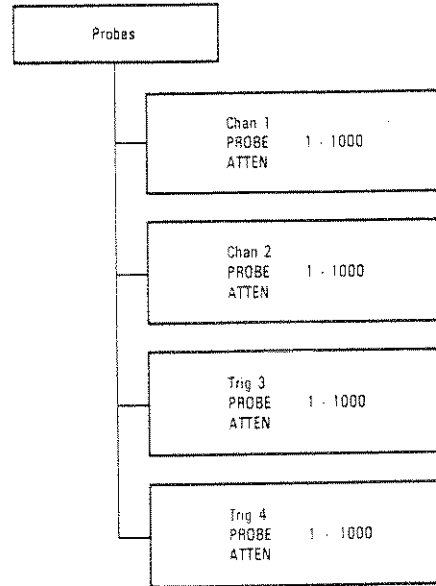

Figure 6-14. Probes Menu

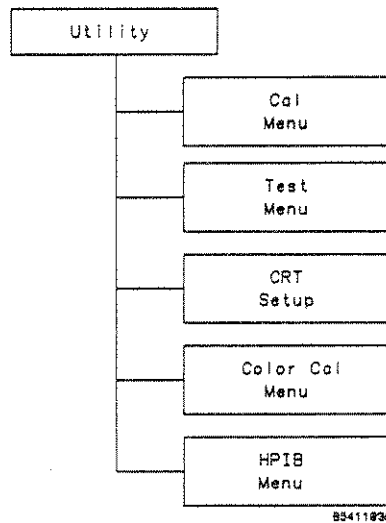
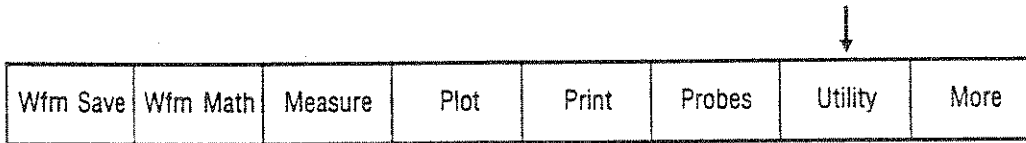

Figure 6-15. Utility Menu

6-20. UTILITY



The Utility menu select key allows access to five submenus that can be selected by pressing the appropriate key at the right of the CRT. These submenus include:

1. Cal Menu
2. Test Menu
3. Crt Setup
4. Color Cal Menu
5. HP-IB Menu

The Test Menu and the Crt Setup Menu are discussed in the 54110D Service Manual and will not be covered here.

6-21. CAL MENU

The Cal menu is provided so you can null differences between trigger and data acquisition paths. This would include acquisition differences internal and external to the instrument. See Appendix B for a discussion of this topic. (See figure 6-16.)

In order to obtain the proper cal for a particular system configuration it is necessary to adjust each channel's sensitivity, offset and trigger level as well as the external trigger levels to the values you intend to use. This will establish each input to the configuration that will be used in the actual measurement.

The objective of the cal procedure is to apply a fast edge simultaneously to inputs of the instrument and null out the systematic delay between these inputs. The fastest available edge source should be used (< 1 ns transition time is desirable), however, a signal of the same general characteristics as the signal you intend to measure is a reasonable alternative. For each cal step the inputs should be connected to the calibration source as closely to one another as possible. BNC Tee's and probe adapters are useful to accomplish this.

Be sure to set up all sensitivities, offsets, and trigger levels before beginning the cal menu. The cal menu function allows you to null any differences in propagation delay between signal paths in software in the 54110D. This is important so that time-difference measurement results accurately reflect time referenced to the probe tips or the points where the input coaxial cables are connected to the circuit under test.

There are two cal signal outputs on the rear panel. Only one cal source should be used for the cal menu adjustment exercise because the two cal signals are separately buffered and the time differential between the outputs is not characterized.

Connect a BNC Tee to one of the cal signal outputs on the rear of the instrument and connect two equal length 50 ohm cables to the BNC Tee. Connect these two cables to the chan 1 and chan 2 inputs. Next, select the axes graticule.

For this exercise press AUTO-SCALE and set offset and trig level to equal values for chan 1 & 2 . Move the signal input from chan 2 to trig 3 and then to trig 4 and set the trig level for trig src 3 and trig src 4 as close as possible to the trig level used for chan 1 & 2. Change the Trig Src back to Chan 1. Now move the input cable back to Chan 2.

Press the Utility key and then press the cal menu function key (top key) and follow the instructions on the CRT (but don't AUTO-SCALE again), press the TRIG DELAY-Chan 1 function key, again the top key. As the key is pressed TRIG DELAY will be highlighted and a single channel will be presented on the display.

Press the Expand Waveform function key several times until the waveform is expanded and approximates figure 6-17. Use the entry devices and adjust the position of the signal on the X-axis so that it intersects the crossing of the graticule at center screen. The value of chan 1 trigger delay is listed at the top of the waveform display area.

Press the top function menu key and the label will change to SKEW Ch to Ch, also the chan 1 & 2 signals will be in the split screen format and should resemble figure 6-18. The chan 1 signal is in the upper half of the display and chan 2 is in the lower half. The chan 1 signal should be positioned so that it intersects the graticule crossing, this is a result of the previous chan 1 trig delay adjustment. Press the expand waveform key for an appropriate display. Use the entry devices and adjust the chan 2 waveform on the X-axis so that it intersects the graticule crossing at center screen. When you make this adjustment you are nulling the difference in signal acquisition times from chan 1 to chan 2. Chan to chan skew time is listed at the top of the waveform display area.

The next adjustment to be made is the Chan 2 TRIG DELAY. Press the top function menu key, the label for this key will change to TRIG DELAY-Chan 2 and there will be a single signal on the display similar figure to 6-17. Use the entry devices and position the displayed signal on the x-axis so that it intersects the graticule crossing at the center of the display. The ch 2 trigger delay time will be listed at the top of the waveform display area.

Press the top function menu key and the label will change to TRIG DELAY-Trig 3. Connect the cable that has been attached to chan 2 to trig 3. Adjust the entry devices and move the signal on the X-axis so that it intersects the graticule at the center crossing. The value of the trig 3 delay will be listed at the top of the waveform display area.

Press the top function menu key and the label will change to TRIG DELAY-Trig 4. Connect the cable that has been attached to Trig 3 to Trig 4. Adjust the entry devices and move the signal on the X-axis so that it intersects the graticule at the center crossing. The value of trig 4 delay will be listed at the top of the waveform display area. Press the top function menu key again and the label will change to Chan 1. You may now save the cal factors by pressing the Exit Cal Menu key.

Cal factors are kept as part of the SAVE/RECALL setup and different sets of factors may be kept with each front panel setup. When the instrument is powered down these factors will be maintained in nonvolatile memory.

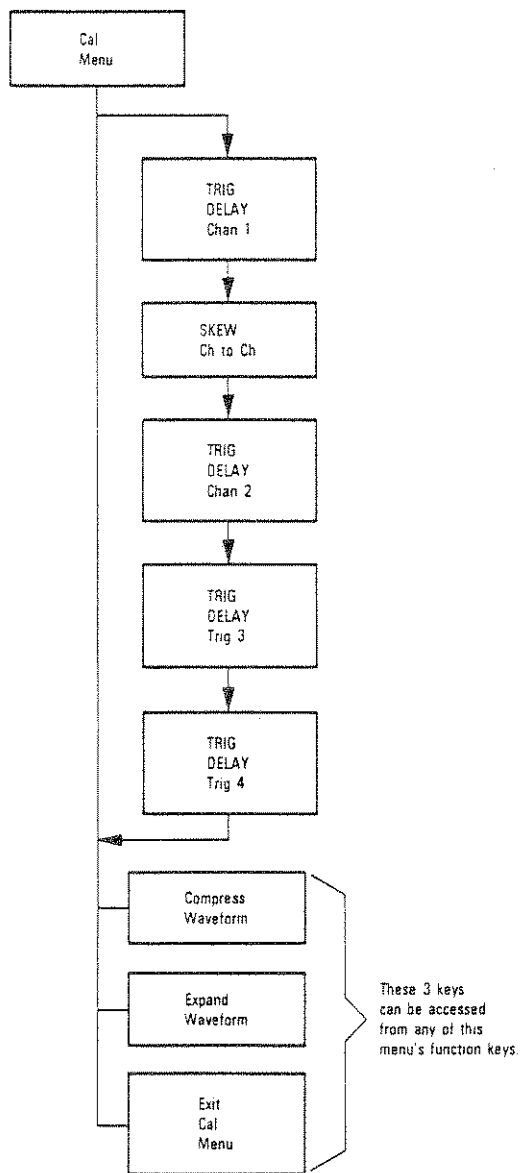

Figure 6-16. Cal Menu

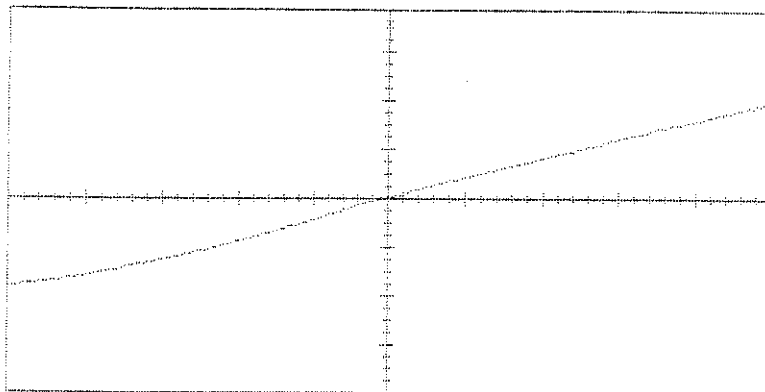

Figure 6-17. Trigger Delay

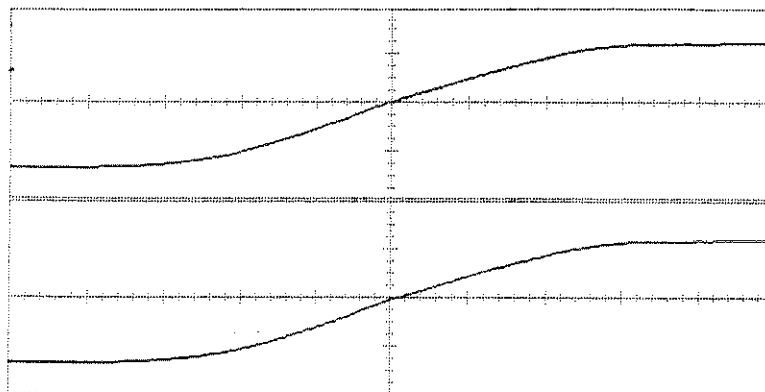

Figure 6-18. Chan to Chan Skew

6-21. COLOR CAL MENU

The color cal menu provides a flexible system that allows you to define the 16 (0-15) colors that are available on this instrument. Colors 0-7 and 15 have specific functions on the instrument's display, colors 8-14 are not used. You may, however, use them for user definable text via HP-IB. All 16 colors can be individually modified to suit a specific need. Color selections are maintained in nonvolatile memory See figure 6-21 for a listing of the default colors and their uses.

After you have selected the utility menu and then in turn selected the color cal menu, the top key in the function menu will be the Selected Color key. When you press this key you will sequence the inverse video text field to the next color number. After you have selected a color you can use the HUE, SATURATION, and LUMINOSITY functions to modify it.

The hue function allows you to change the gradation of color. The range of the hue function is from 0 to 100 with red located at 0/100, green at 33, and blue at 67. The hue can be varied by using the entry devices.

The saturation function defines the percent of pure color that is to be mixed with white. The range of this function is from 0 to 100, with 0 being white (irregardless of the hue setting) and 100 being the pure color (determined by hue). Use the entry devices to change the saturation level.

The luminosity function defines the relative brightness of the color with 0 being black and 100 being maximum brightness. Luminosity is varied by using the entry devices.

The next key allows you to set all colors to their default states.

The bottom key allows you to exit the color cal menu and return to the utility menu.

Figure 6-22 shows the HSL model (hue, saturation and luminosity) with the angular coordinate demonstrating the hue. Saturation is the height coordinate and the radial coordinate is the luminosity.

6-22. HP-IB MENU

When you want to connect the 54110D to other HP-IB devices you would select the HP-IB menu. This menu allows you to establish the 54110D as a HP-IB talker, listener, or do both.

The EOI instruction can be sent at your discretion for such applications as binary dumps or when required by a controller when under program control.

When the instrument is in the Talk/Listen mode the HP-IB address can be changed by using the Entry devices. Refer to the programming section of this manual for a complete discussion of the HP-IB capabilities of the 54110D.

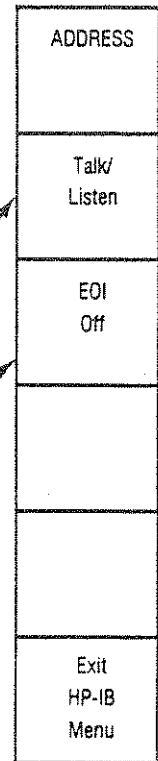
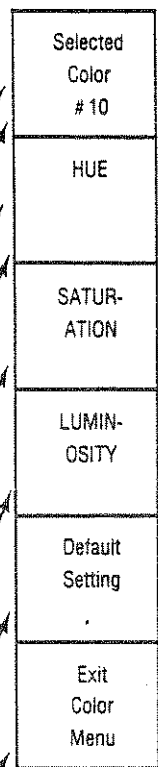

6-21. COLOR CAL MENU

The color cal menu provides a flexible system that allows you to define the 16 (0-15) colors that are available on this instrument. Colors 0-7, 10-12, and 15 have specific functions on the instrument's display, colors 8, 9, 13, and 14 are not used. You may, however, use them for user definable text via HP-IB. All 16 colors can be individually modified to suit a specific need. Color selections are maintained in nonvolatile memory. See figure 6-21 for a listing of the default colors and their uses.

After you have selected the utility menu and then in turn selected the color cal menu, the top key in the function menu will be the Selected Color key. When you press this key you will sequence the inverse video text field to the next color number. After you have selected a color you can use the HUE, SATURATION, and LUMINOSITY functions to modify it.

The hue function allows you to change the gradation of color. The range of the hue function is from 0 to 100 with red located at 0/100, green at 33, and blue at 67. The hue can be varied by using the entry devices.

The saturation function defines the percent of pure color that is to be mixed with white. The range of this function is from 0 to 100, with 0 being white (regardless of the hue setting) and 100 being the pure color (determined by hue). Use the entry devices to change the saturation level.

The luminosity function defines the relative brightness of the color with 0 being black and 100 being maximum brightness. Luminosity is varied by using the entry devices.

The next key allows you to set all colors to their default states.

The bottom key allows you to exit the color cal menu and return to the utility menu.

Figure 6-22 shows the HSL model (hue, saturation, and luminosity) with the angular coordinate demonstrating the hue. Saturation is the height coordinate and the radial coordinate is the luminosity.

6-22. HP-IB MENU

When you want to connect the HP 54110D to other HP-IB devices you would select the HP-IB menu. This menu allows you to establish the HP 54110D as a HP-IB talker, listener, or do both.

The EOI can be sent at your discretion for such applications as binary dumps or when required by a controller when under program control.

When the instrument is in the Talk/Listen mode the HP-IB address can be changed by using the Entry devices. Refer to the programming section of this manual for a complete discussion of the HP-IB capabilities of the HP 54110D.

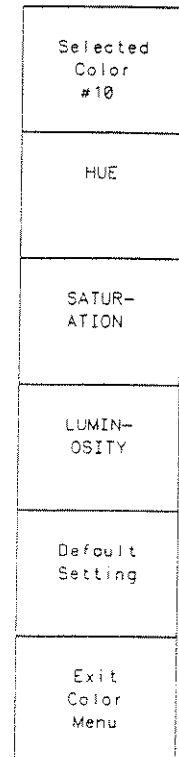

54110/BL10

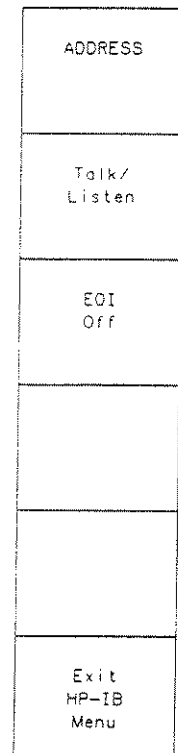

54110/BL11

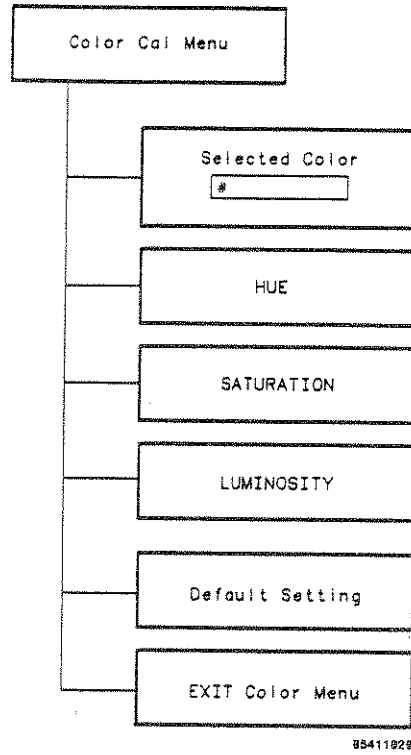

Figure 6-19. Color Cal Menu

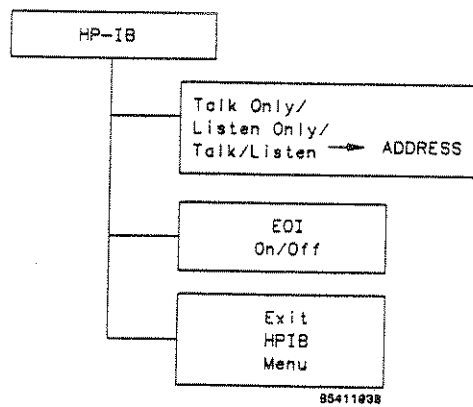

Figure 6-20. HP-IB Menu

COLOR #	COLOR	USE	HUE	SATURATION	LUMINOSITY
0	Beige	Highlighting	11	51	100
1	Grey	Halfbright	0	0	55
2	Red	Advisory	0	100	100
3	Yellow	Chan 1	17	100	100
4	Green	Chan 2	33	100	100
5	Orange	Markers	8	100	100
6	Cyan	Stored waveforms	50	85	90
7	Magenta	Trace overlap	90	100	100
8	Pink	Not used	95	60	100
9	Lt Blue	Not used	58	40	100
10	Olive Drab	Not used	20	100	40
11	White	Not used	0	0	100
12	Brown	Not used	6	100	60
13	Blue	Not used	67	75	100
14	Mauve	Not used	83	100	100
15	Black	Background	0	0	0

Figure 6-21. Color Chart

Model 54110D - Menus

COLOR #	COLOR	USE	HUE	SATURATION	LUMINOSITY
0	Beige	Highlighting	11	51	100
1	Grey	Halfbright	0	0	55
2	Red	Advisory	0	100	100
3	Yellow	Chan 1	17	100	100
4	Green	Chan 2	33	100	100
5	Orange	Markers	8	100	100
6	Cyan	Stored waveforms	50	85	90
7	Magenta	Trace overlap	90	100	100
8	Pink	Not used	95	60	100
9	Lt Blue	Not used	58	40	100
10	Purple	Chan 1 for 3630A	84	91	54
11	White	Background for 3630A	0	0	100
12	Black	Overlap for 3630A	0	0	0
13	Blue	Not used	67	75	100
14	Mauve	Not used	83	100	100
15	Black	Background	0	0	0

Figure 6-21. Color Chart

1
2
3
4
5
6
7
8
9
10
11
12
13
14
15
16
17
18
19
20
21
22
23
24
25
26
27
28
29
30
31
32
33
34
35
36
37
38
39
40
41
42
43
44
45
46
47
48
49
50
51
52
53
54
55
56
57
58
59
60
61
62
63
64
65
66
67
68
69
70
71
72
73
74
75
76
77
78
79
80
81
82
83
84
85
86
87
88
89
90
91
92
93
94
95
96
97
98
99
100

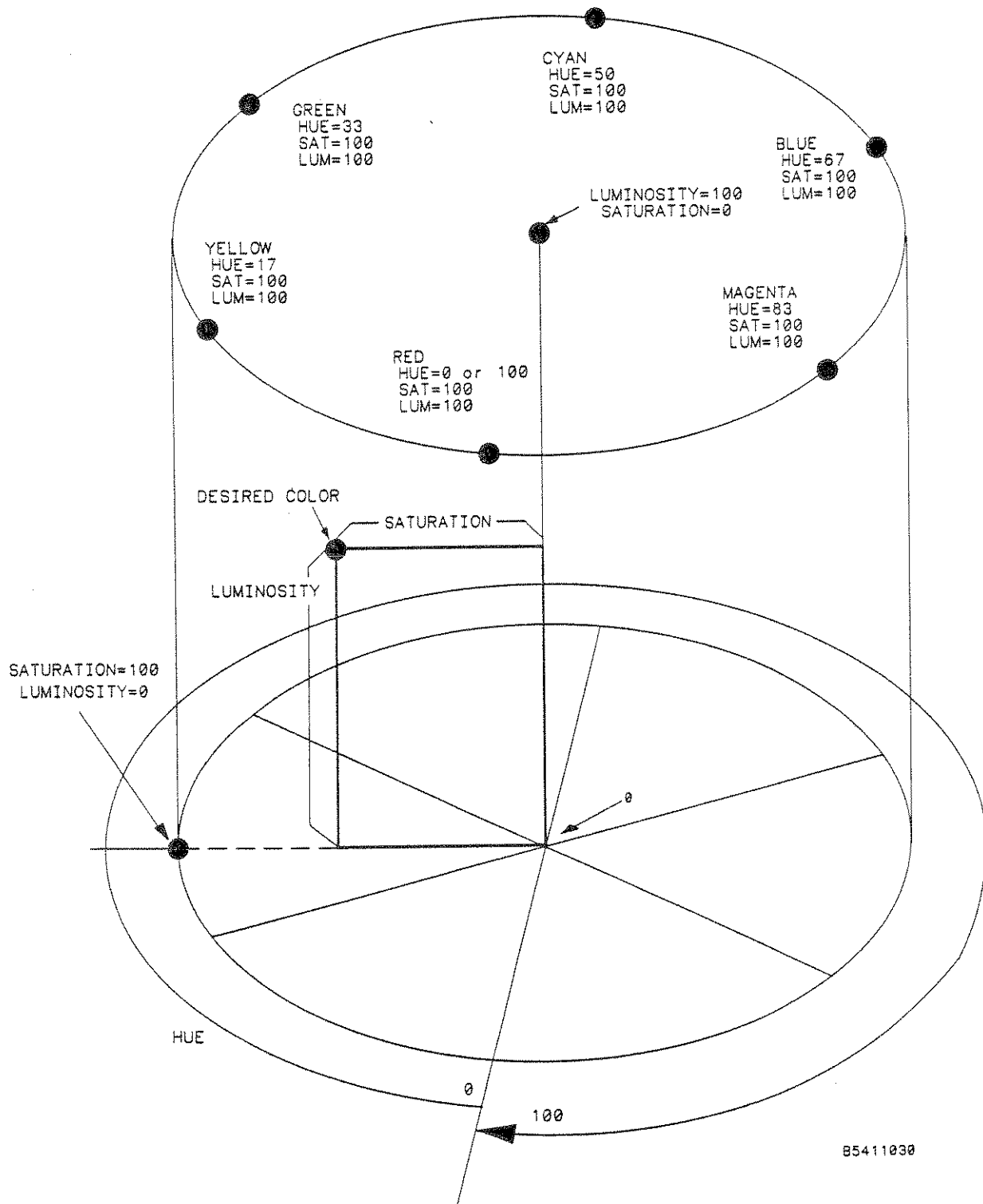

Figure 6-22. HSL Color Model

NOTES:

SECTION 7

FRONT PANEL EXERCISES

7-1. INTRODUCTION

This section provides exercises that will help you to become more familiar with local (front panel) operation. Section 6 includes a preliminary discussion on front panel operation and should be read before continuing with Section 7.

7-2. INPUTTING A SIGNAL

The 54110D has four inputs, two are vertical signal inputs and the third and fourth are external trigger inputs.

For the instrument to accept signals, input pods must be installed. Refer to section 3 for pod specifications. The characteristics of all inputs are dependent on the pod chosen. The appropriate input pod should be chosen after characterizing the source impedance, speed/bandwidth and magnitude of the signal to be measured.

7-3. FRONT PANEL REVIEW

Refer to figure 7-1 for a review of the front panel layout. The keys at the bottom of the CRT are referred to as the menu select keys. When one of these keys is pressed, the appropriate function menu will appear on the right side of the CRT. Additional control of the unit is available through the use of the SYSTEM CONTROL keys which are located at the top of the right side of the front panel. These SYSTEM CONTROL keys give you immediate access to those functions which are appropriate in any menu.

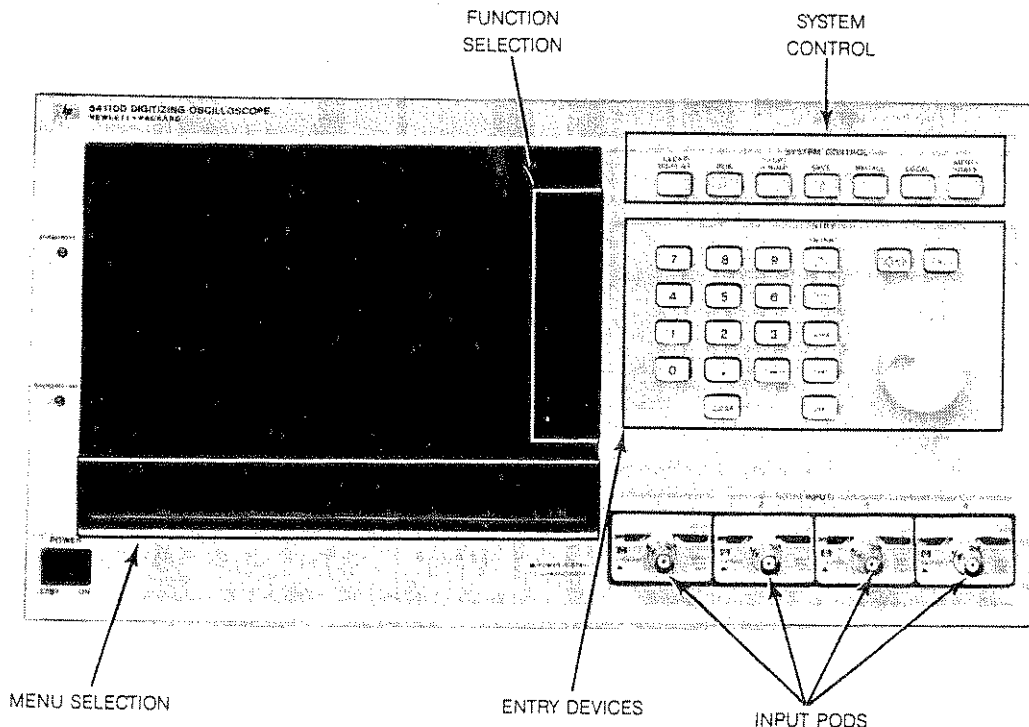

Figure 7-1. HP 54110D Front Panel

The ENTRY devices are used to input values for variables. The input devices on this instrument include the key pad, step keys and the knob. If you need further information concerning the front panel refer to Section 6.

7-4. MAKE A VOLTAGE MEASUREMENT

This oscilloscope gives you the capability of making either a manual or automatic voltage measurement. In this discussion the instruments cal signal is used as the signal source. To make a voltage measurement manually you may use this procedure.

1. Connect the cal signal to channel 1.
2. Press AUTO SCALE
3. Select the Display menu.
4. Insure the Display Mode is Averaged.
5. Press the Delta V menu key
6. Key the V markers on.
7. Position MARKER 1 at the top of the cal signal.
8. Position MARKER 2 at the base of the cal signal

The difference between the voltage levels of the two Vmarkers will be shown in the factors area at the bottom of the CRT labeled ΔV . In this example the cal signal measured 444 mV p-p. The positive delta voltage indicates that MARKER 2 was more positive than MARKER 1. If the markers were reversed ΔV would indicate a negative voltage (see figure 7-2).

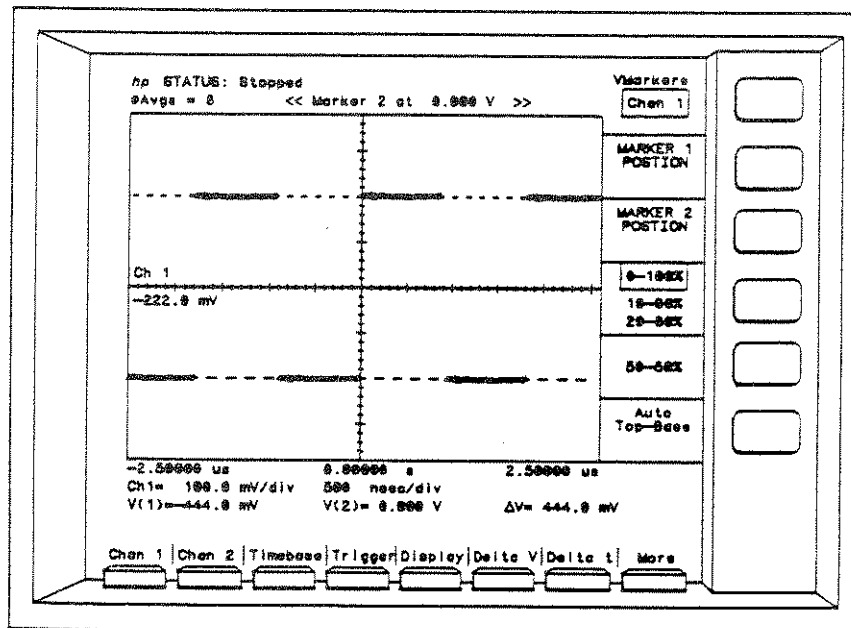

54110D/0001

Figure 7-2. Manual Vmarker Measurement

Another method of making this measurement would be to use the Auto Top-Base function on the Delta V menu. The instrument will make an automatic voltage measurement by evaluating a histogram of the data points that are displayed on the CRT (see figure 7-3). When the Auto Top-Base key is pressed, MARKER 2 moves to the top of the Cal signal and MARKER 1 moves to the base. ΔV will indicate approximately 444 mV; this indicates that MARKER 2 is 444 mV more positive than MARKER 1 (see figure 7-4). The results of the manual and the automated measurements in this case turned out to be identical. This is not always the case. The manual measurement is accomplished by using visual resolution and the automated results are acquired mathematically. Cal signals vary slightly from unit to unit; therefore, results may vary accordingly.

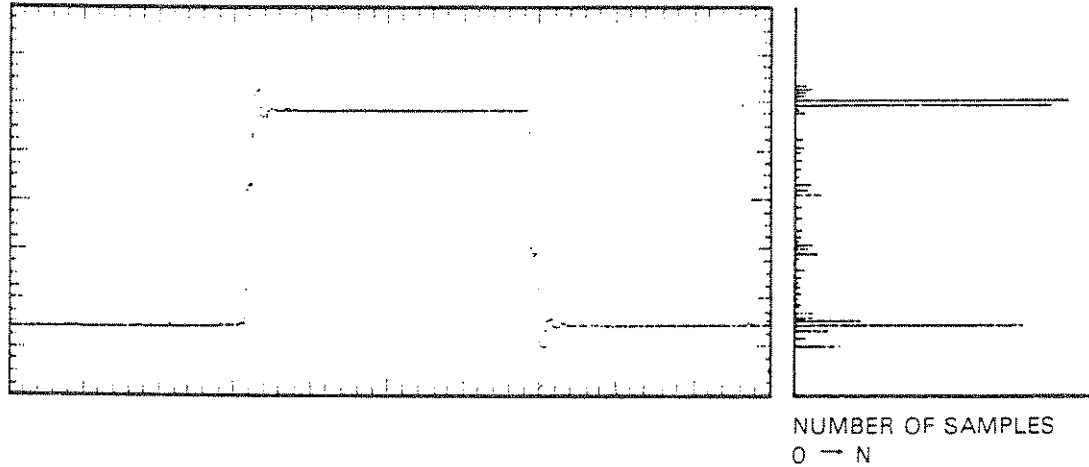

Figure 7-3. The Histogram of a Waveform.

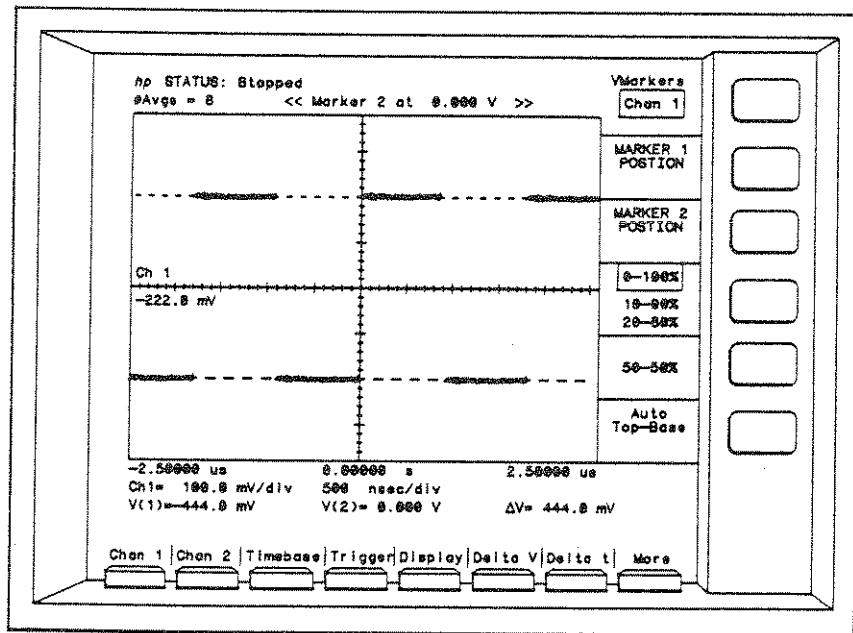

Figure 7-4. Auto Top-Base Voltage Measurement.

Another way to make voltage measurements would be to use the automated capability by using the the Peak-to-Peak Voltage function. When the Peak-to-Peak Voltage key is pressed, the unit determines the minimum and maximum voltage on the CRT, calculates the difference, and provides the answer in the factors area.

1. Press the More menu key (bottom of the CRT).
2. Select the Measure menu.
3. Press the More key (side of CRT) until the Peak-to-Peak label appears.
4. Press the Peak-to-Peak Voltage key.

Note the results in the factors are (P-P Volts). With the example unit the value was 446 mV. This is a slightly greater absolute value than we acquired when we used Auto Top-Base. This would be expected as the peak-to-peak voltage is the difference between the minimum and maximum voltages on the display and the Auto Top-Base measurement is derived from a histogram of the same data (see figure 7-5).

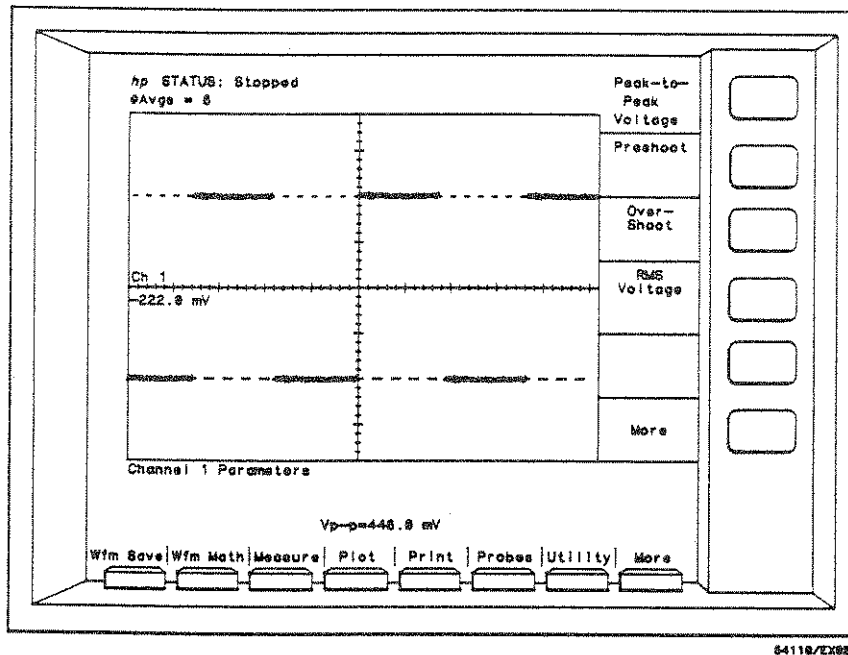

Figure 7-5. Peak-to-Peak Voltage

An important capability of the Vmarkers is that the Vmarkers can be assigned to chan 1 and chan 2 independently, i.e., marker 1 to chan 1 and marker 2 to chan 2. The next exercise will help clarify how this feature works:

1. Connect the cal signal to channel 1 & 2.
2. Press AUTO-SCALE.
3. Select the Delta V menu.
4. Turn the Vmarkers on.
5. Press the top key on the function menu twice. (Vmarkers Dual)
6. Position MARKER 1 and MARKER 2 randomly.

As the markers are moved you notice that MARKER 1 is associated with chan 1 and MARKER 2 is associated with chan 2. The DC voltage level of each marker as well as the difference between them (ΔV) is listed in the factors area. This feature allows comparisons to be made between signals on chan 1 and chan 2. To demonstrate this:

1. Position MARKER 1 level with the top of the cal signal on chan 1.
2. Position MARKER 2 level with the base of the cal signal on chan 2.

NOTE

ΔV in the factors area lists the voltage difference between the two markers (see figure 7-6).

3. Select Chan 1.
4. Press the OFFSET function.
5. Move Chan 1 display using the entry devices.

As the chan 1 signal is positioned on the display, note that the Vmarker maintains its relative location with respect to the signal on the channel.

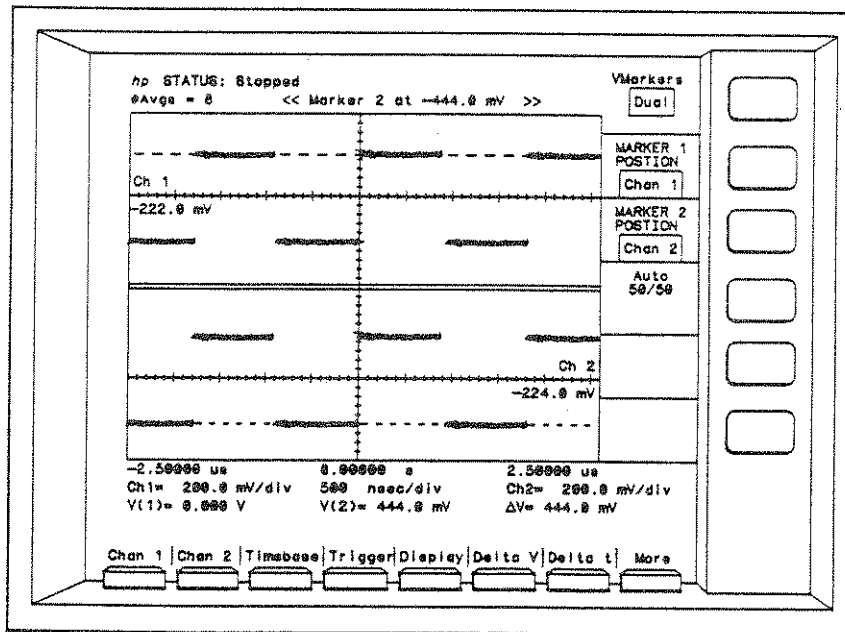

Figure 7-6. Delta V markers on Split Screen.

7-5. TIME DOMAIN MEASUREMENTS

This section provides a discussion and exercises that demonstrate some of the time domain measurement capabilities of the 54110D.

The time domain is referenced to the 10 division CRT display with a resolution of 100 ps to 1 sec/div on the horizontal axis. The two time markers can be used as horizontal references to show where an automatic measurement is being made, or to relocate signals displayed time using the DELAY function; or they can be manually located on the display for timing measurements. To demonstrate the manual time interval measurement capability, complete the following exercise:

1. Connect the cal signal to channel 1.
2. Press AUTO-SCALE.
3. Select the Delta t menu.
4. Key the Tmarkers on.

NOTE

Both Tmarkers will be located at the "0.00000S" Delay Ref. (trigger event). Auto-Scale sets the Delay Ref. at center screen.

5. Move the START MARKER to the leading edge of the first pulse.
6. Move the STOP MARKER to the trailing edge of the first pulse.

The time intervals between each marker and the trigger point as well as the time interval between START MARKER and STOP MARKER to the trailing edge of the first (Δt) are listed in the factors area (see figure 7-7).

In this example the START MARKER is -2.00 us (before trigger) and the STOP MARKER is -1.00 us (before trigger) and Δt is 1 us.

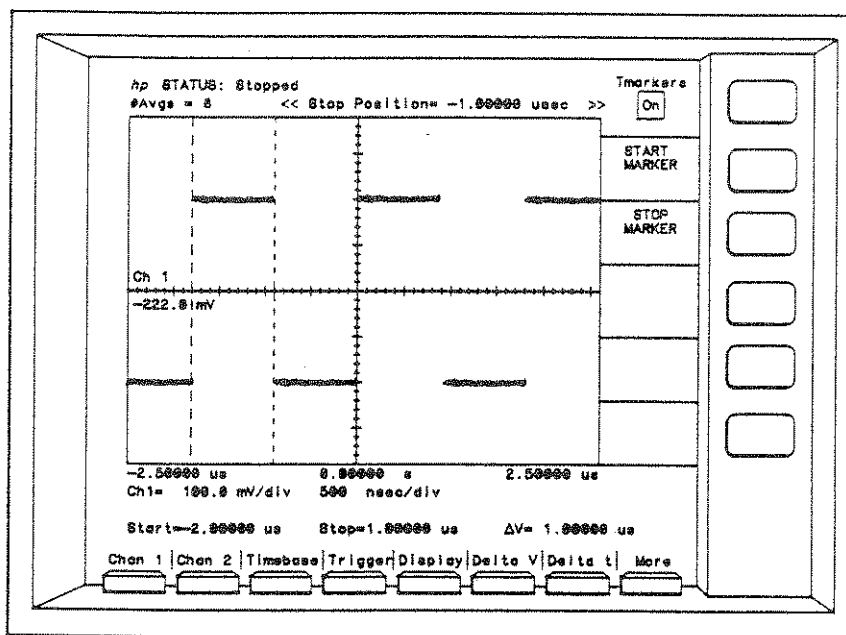

Figure 7-7. Manual Time Interval Measurement

Another method that can be used to make a time interval measurement is to take advantage of the automatic edge finding capability, which requires setting a reference with the Vmarkers for defining edges:

1. Select the Delta V menu.
2. Key Vmarkers on.
3. Press Auto Top-Base.
4. Press 50-50%.

NOTE

Step 4 places the Vmarkers at the 50% level of the cal signal and provides references for the delta t measurements we are about to make, i.e., the unit senses the transition of the cal signal through the Vmarkers.

5. Select the Delta t menu.

NOTE

The Delta t menu has 3 additional functions; START ON EDGE, STOP ON EDGE and Precise Edge Find. These functions require the use of the Vmarkers and are only displayed when Vmarkers are on.

6. Set START ON EDGE to Pos 1.
7. Set STOP ON EDGE to Neg 1.

NOTE

When you select START ON EDGE or STOP ON EDGE as in steps 6 and 7, the first key stroke selects the function and the second changes the polarity of the edge.

The unit will automatically locate the transition level (50-50%) on the first positive and negative edges and measure the time interval between the two and define the +pulse width. Check the factors area of the CRT for the results (Δt)(see figure 7-8).

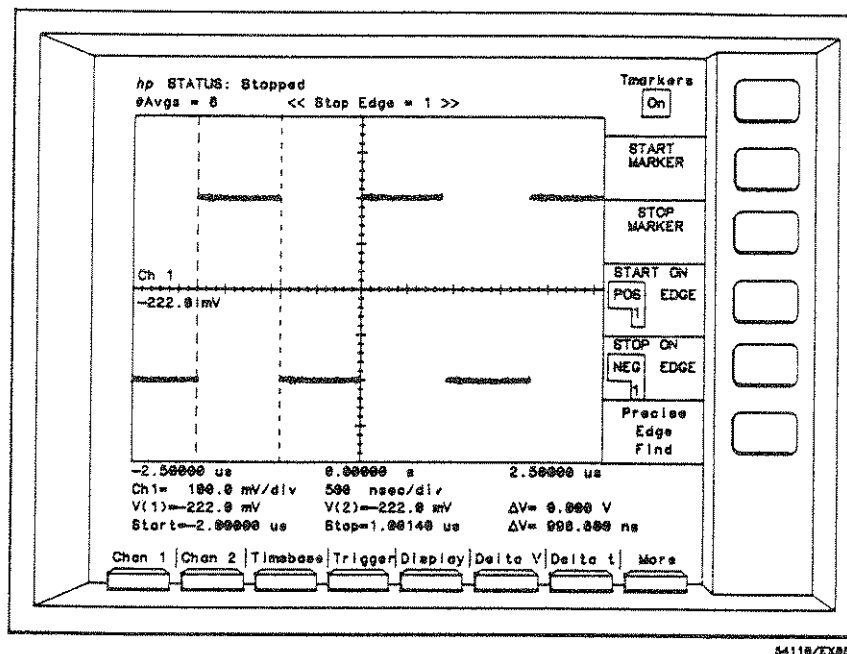

Figure 7-8. Edge Find

Model 54110D - Exercises

When the START and STOP ON EDGE functions are used, the displayed waveform is used as the data base for developing the time interval measurements. This limits the resolution to 1/50th of a division.

Now press Precise Edge Find. This causes the unit to rescale the horizontal axis to a faster sweep speed while it locates the Vmarkers on the edge(s) of interest.

Because of the additional scaling, Precision Edge Find requires a longer period of time to acquire a result than does the START and STOP ON EDGE functions; this should be considered if throughput is a concern.

Precise Edge Find uses averaging, which also makes it take longer. The number of averages selected in the Display menu will be acquired each time the timebase is rescaled to locate the edges. For greater precision, the NUMBER OF AVERAGES can be increased; for a faster result, the NUMBER OF AVERAGES can be reduced. Extremely low repetition rate signals will also slow down the precise edge finders.

To terminate the measurement routine at any time, just press any other front panel key.

Another method of measuring the +pulse width would be to use the automated capabilities available on the Measure menus.

1. Connect the cal signal to chan 1.
2. Press AUTO-SCALE.
3. Press More menu key (bottom of CRT).
4. Select Measure menu.
5. Select Fine Precision.
6. Press More (on the side of the CRT).
7. Press +Width.

The +Width value will be listed in the factors (see figure 7-9).

When any of the automated measurements in the measure menus require a time interval measurement, you have the choice making "Coarse" or "Fine" precision measurement. When a coarse measurement is executed the instrument makes the measurement on previously acquired data. In most cases fine precision measurements, when executed, acquire new data and rescale the timebase for increased resolution.

NOTE

All fine precision measurements require an active signal input.

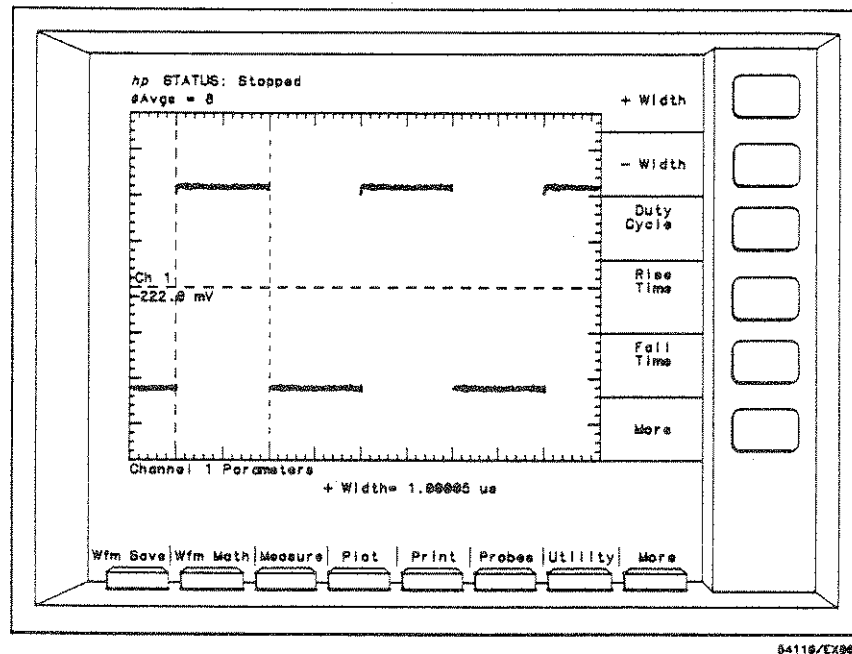

Figure 7-9. +Pulse Width

If measurement speed is a prime concern, you may make automated time interval measurements using coarse precision by setting the Precision key in the Measure menu to Coarse.

For demonstration purposes repeat the + width measurement with precision set to coarse. Notice the difference in time required for a coarse precision measurement vs. a fine precision measurement.

7-6. DELAY

The DELAY function provides horizontal windowing capability as well as calibrated pre and post triggering delays. Negative delay represents time before the trigger event and positive delay represents time after the trigger event. Try the following procedure to familiarize yourself with the DELAY function.

1. Connect the cal signal to channel 1.
2. Press AUTO-SCALE
3. Select the DELAY function.

NOTE

In this exercise the Delay is referenced to center screen; the left or right side of the graticule could just as easily have been used as the reference.

4. Key in 2 sec delay using the key pad and the sec ENTER key. An error message will display "Value out of range.....Set to limit". The maximum + delay on this sweep speed (500 ns/div) is 1.6 sec.
5. Key in -1 second delay. Again the unit displays the error message and sets the delay to the limit. Maximum - delay on this sweep speed is 200ms.

NOTE

Maximum \pm delays vary depending on sweep speeds and delay reference, e.g., on 1 sec/div sweep speed, maximum positive delay is 6×10^5 seconds, maximum negative delay is -10 seconds.

6. Press AUTO-SCALE.
7. Select DELAY.
8. Vary Delay by rotating the knob. CW rotation provides negative delay and CCW rotation provides positive delay.

The DELAY function allows viewing of the signal before and after the trigger event. In this last example, 1.6 seconds delay and 500 ns/div sweep speed were used. A small amount of time jitter would be obvious when viewing the delayed signal under these conditions, e.g., 1 cm of jitter represents approximately 3.2 ppm. To demonstrate the effect of time jitter, complete the following exercise:

1. Connect the cal signal to channel 1
2. Press AUTO-SCALE.
3. Select the DELAY function.
4. Enter 1.6 sec. Delay using the key pad.
5. Select the display menu.
6. First view the signal in the normal mode with infinite persistence then switch the unit to the averaged mode (top key on the function menu).
7. Set Averages = 8 by using the entry devices.

NOTE

After the unit has been allowed to acquire data for a short period, the rising and falling edges of the pulse appear to slope (see figure 7-10); this is a function of the time jitter on the signal and the fact that the unit is in the averaged mode. In this example where time jitter is present and a relatively long delay is used, the averaged mode does not faithfully reproduce the input signal.

8. Change the display mode to normal.
9. Set the DISPLAY TIME to Infinite using the entry devices. Notice that after several acquisitions, the leading and lagging edges are undefined (see figure 7-11). This is caused by time jitter on the input signal. Unless a signal source is extremely stable it is common to see time jitter of this magnitude when long delays are used. The sample unit that was used demonstrated approximately 500 ns time jitter with 1.6 sec delay. This technique is a perfectly valid measurement of the jitter in the source signal, which you might typically want to measure. This type of jitter measurement is made possible by the extremely stable crystal referenced timebase. See Section 3 for timebase jitter specifications.

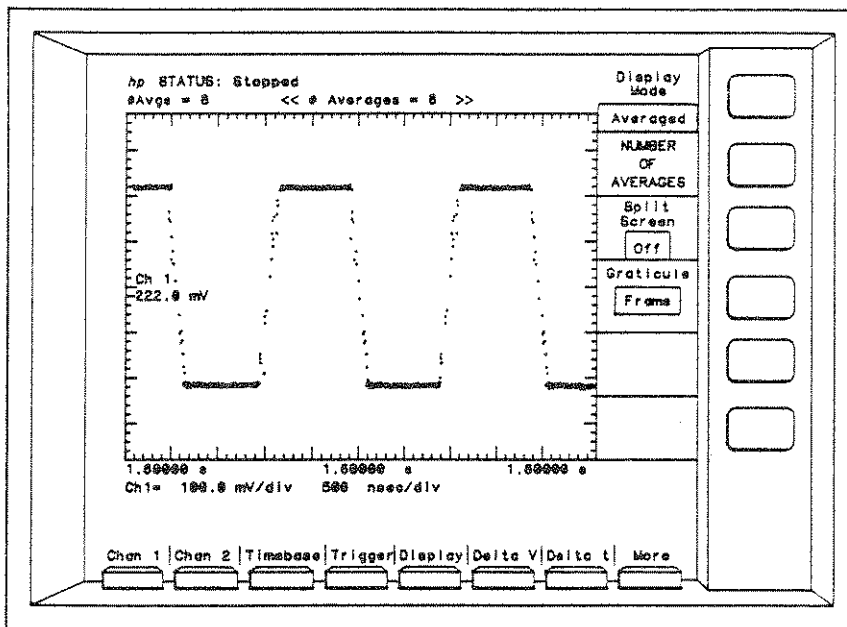

54110/EX07

Figure 7-10. Time Jitter in the Averaged Mode

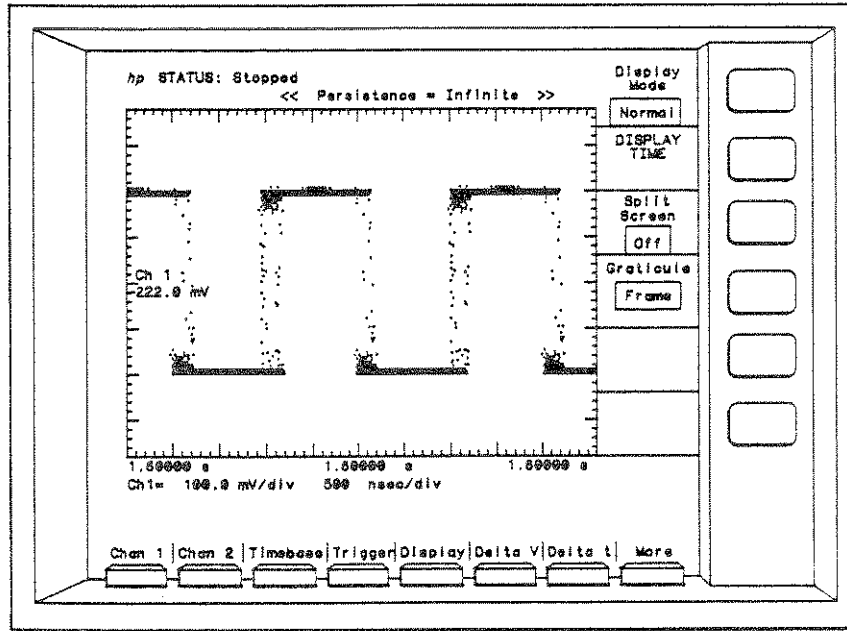

54110/1208

Figure 7-11. Time Jitter in the Normal Mode

Figure 7-12 compares the results obtained with the normal mode and the averaged mode when using a long delay with time jitter present.

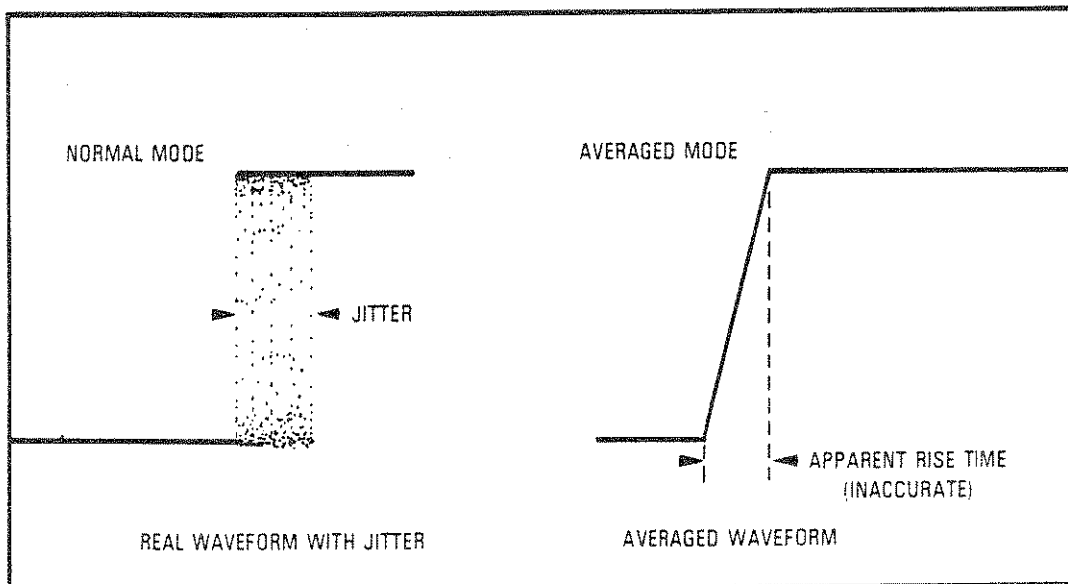

Figure 7-12. Time Jitter with Normal/Averaged Mode.

The 54110D provides two additional techniques of delaying the display window by delaying the actual trigger; Event Delay and Time Delay. These two functions are part of the trigger menu and can be selected by pressing the trigger menu key. They are different from the Timebase delay in that they provide a trigger for the display after the Event/Time delay. This eliminates the time jitter that is seen when the timebase delay is used. Let's first look at event delay.

1. Connect the cal signal to channel 1.
2. Press AUTO-SCALE.
3. Change from Auto to Trg'd sweep.

NOTE

When AUTO-SCALE is pressed, the unit establishes itself in the auto sweep mode. If the trigger is delayed longer than approximately 50 ms, the auto sweep mode will cause the unit to sweep before the delay period has elapsed. The signal will appear untriggered (see figure 7-13). To eliminate this problem put the unit in the Trg'd mode.

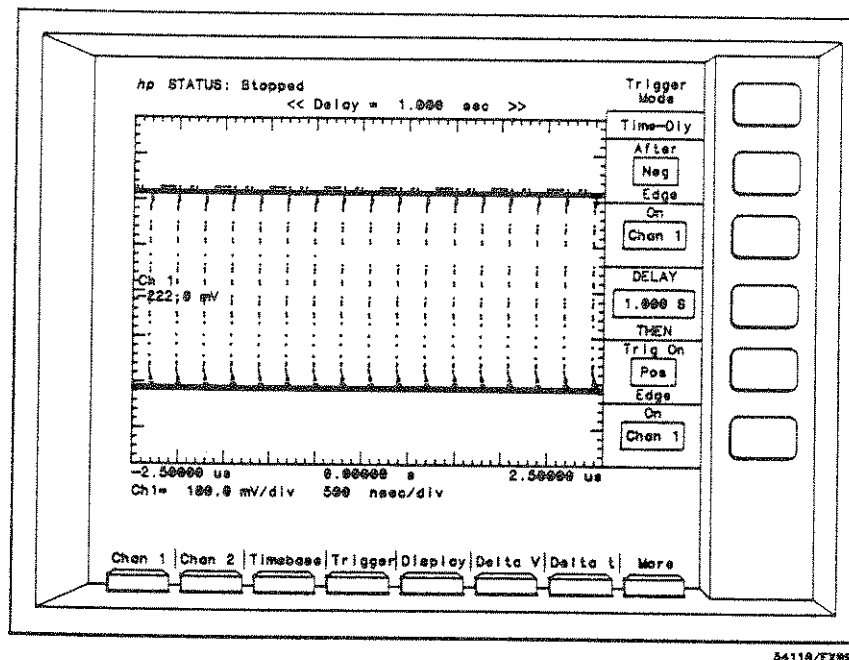

Figure 7-13. Auto Sweep Mode with Delay > 50 ms.

4. Select the Trigger menu.
5. Set the trigger mode to Event-Dly.
6. Using the function keys and entry devices, set the Event-Dly menu to read: "After Neg Edge On Chan 1, TRIG on 1,000,000 events Of Pos Edge on chan 1".
7. Press CLEAR DISPLAY

NOTE

After a qualifying negative edge on chan 1, the unit will delay the defined number of pulses and then trigger on the last pulse. In this example the 1,000,000th pulse will be presented at center screen (if the delay is referenced to center screen). This mode would be used if it is necessary to look at a specific pulse in a train but the signal is not stable enough to use timebase delay.

The next method of delaying the display window would be Time Dly. To demonstrate time delay, perform the next exercise:

1. Connect the cal signal to channel 1.
2. Press AUTO-SCALE.
3. Select Trg'd sweep.
4. Select the Trigger menu.
5. Select the Time Dly trigger mode.
6. Using the function keys and entry devices, set the Time-Dly menu to read: "After Neg Edge on Chan 1 DELAY 1.000 S THEN Trig On Pos Edge On Chan 1".
7. Press the CLEAR DISPLAY key. In this mode the unit waits a defined period of time after a qualifying event, in this example 1 second, and then triggers on the edge selected.
8. Change the WAIT time to 0.5 sec. Notice that the acquisition rate is influenced by WAIT time because the effective trigger repetition rate is limited by WAIT time.

The Time-Delay mode would be used to view a signal that occurs a relatively long time after a sync signal. This would eliminate the time jitter (induced by the input signal) that would be present if the timebase delay were used. Event-Delay accomplishes essentially the same thing as Time-Delay except that events are used to delay the display window. The effect is similar when using either mode, i.e., the affect of time jitter is the source signal is eliminated.

The timebase delay on the 54110D is always referenced to the trigger edge that is generated in a particular trigger mode. Trigger delay, both event and time, should not be confused with the timebase delay as they are independent functions. Event-Delay and Time-Delay modes are a means of selecting which edge on the signal is used as a reference for timebase delay.

7-7. TRIGGER

In this section some of the triggering capabilities of the 54110D will be discussed.

The edge mode is similar to the trigger on a conventional oscilloscope. The trigger level can be defined, the polarity of the trigger can be selected and the source of the trigger can be determined. This instrument has two external trigger inputs and provides four trigger sources.

In the pattern mode this instrument provides 4-channel pattern recognition capability. Try this exercise to demonstrate some of the triggering capabilities of the edge mode:

1. Connect the cal signal to channel 1 & 2.
2. Press AUTO-SCALE. The unit will establish itself in the split screen mode with chan 1 at the top and chan 2 at the bottom of the display. Chan 1 will be defined as the trigger source.
3. Select the trigger menu.
4. Select TRIG LEVEL. The trigger level will be indicated by a horizontal line through the chan 1 signal (see figure 7-14).
5. Change the trigger level by rotating the knob.

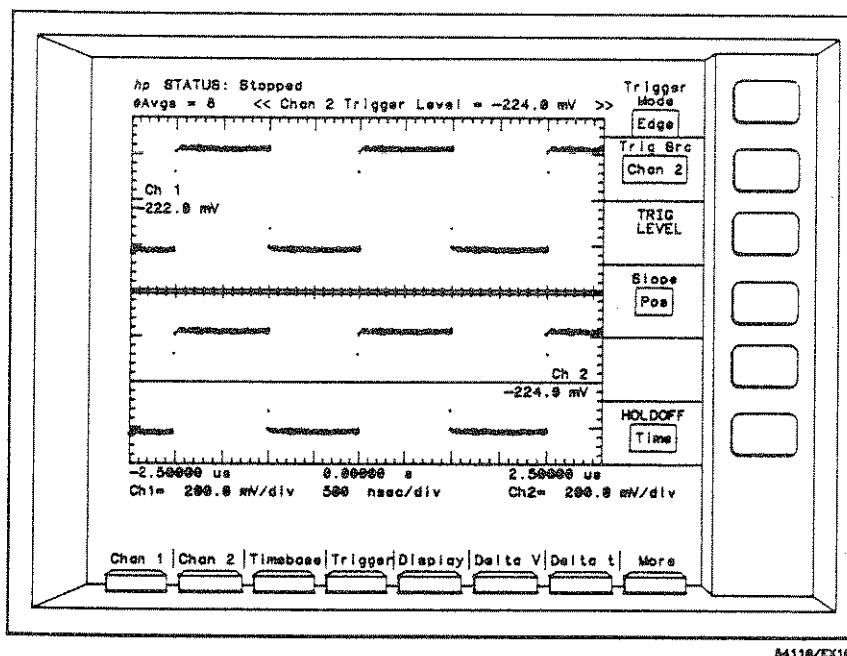

Figure 7-14. Split Screen with Trigger on Chan 1

NOTE

If the trigger level trace is moved above or below the chan 1 signal, the signals on chan 1&2 will loose sync. The step keys and the key pad may also be used to change the trigger level.

6. Select chan 2 as the Trig Src. The unit is now triggering on chan 2. The line showing the trigger level will be on the chan 2 display. The trigger level on chan 2 can be varied by using the input devices (see figure 7-15). The trigger level function is shown at the top of the waveform display area and at the bottom of the display in the factors area.
7. Select Trig 3 as the trig src. Notice that the signals are untriggered.
8. Move the chan 1 input to trig 3 (trigger 3 input). The initial trigger level for trig 3 will be 0 V and the signal on the display will not be triggered. The cal signal is negative and does not cross through the 0 V threshold and therefore does not cause a trigger.
9. Vary trig level 3 until the signal on chan 2 triggers. Trig 3 is now being used as a trigger for the signal on chan 2. You could also use trig 4 as a trigger source in the edge mode.

NOTE

If any of the previously used inputs are selected as the trigger source, the trigger level remains where previously set for that source.

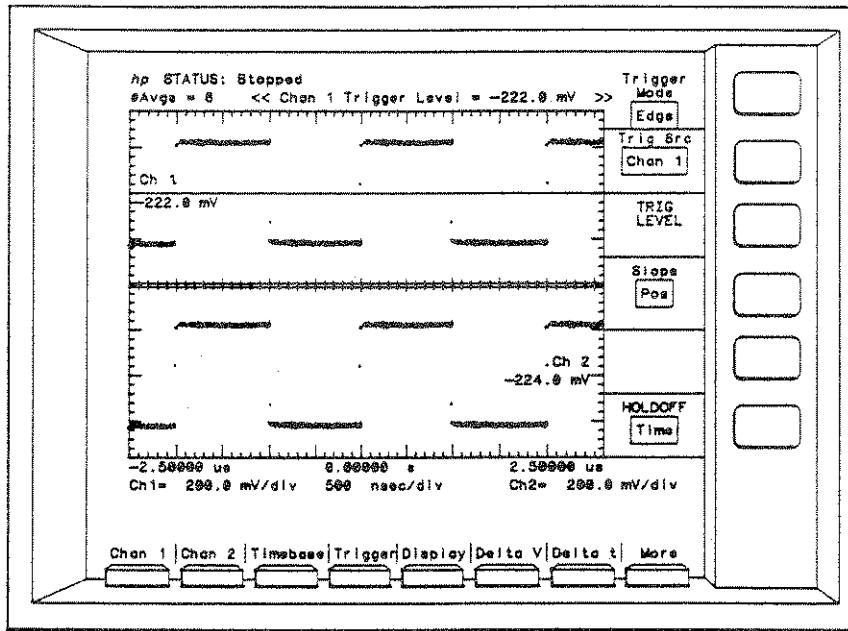

54110/EX11

Figure 7-15. Split Screen with Trigger on Chan 2

7-8. PATTERN MODE

In the pattern trigger mode each input is converted to a digital signal which is high, or true, when the input signal is above its trigger threshold and is low, or false, when below its trigger threshold. The trigger can then be set to occur when a pattern of signal levels, relative to each inputs' trigger threshold, becomes true or false.

When the Pattern mode is used, insure that the trigger level for each input is adjusted so that the input signals cross each respective trigger level during transition. This is done in the edge mode. It should be noted that each input has a separately adjustable trigger level and is independent of the other. This feature allows mixing different types of logic signals. Use this example to become more familiar with the pattern trigger mode:

1. Connect one cal signal to channel 1 using a 1 metre BNC cable.
2. Connect the other cal signal to channel 2 using 3 metres of BNC cable. 2 metres will work as well but will not give as much signal delay on channel 2.
3. Press AUTO-SCALE
4. Set the sweep speed to 5 ns/div.
5. Select the display menu and set split screen off.
6. Select the trigger menu.
7. Select the edge trigger mode.
8. Select chan 2 as the trigger source.

NOTE

In figures 7-16 and 7-17, the signal path for chan 2 is approximately 2 meters longer than that of the signal path for chan 1. This provides the time differential between the two signals.

9. Set trigger mode to pattern.
10. Set Trig On PATTERN to read: "HHXX".

 H = High State (above trigger threshold)
 L = Low State (below trigger threshold)
 X = Don't Care
11. On the trigger menu insure "When Entered" is set. With the instrument in this configuration it will generate a trigger on the last edge that makes the pattern HHXX. In this example the positive edge on chan 2 is the trigger.

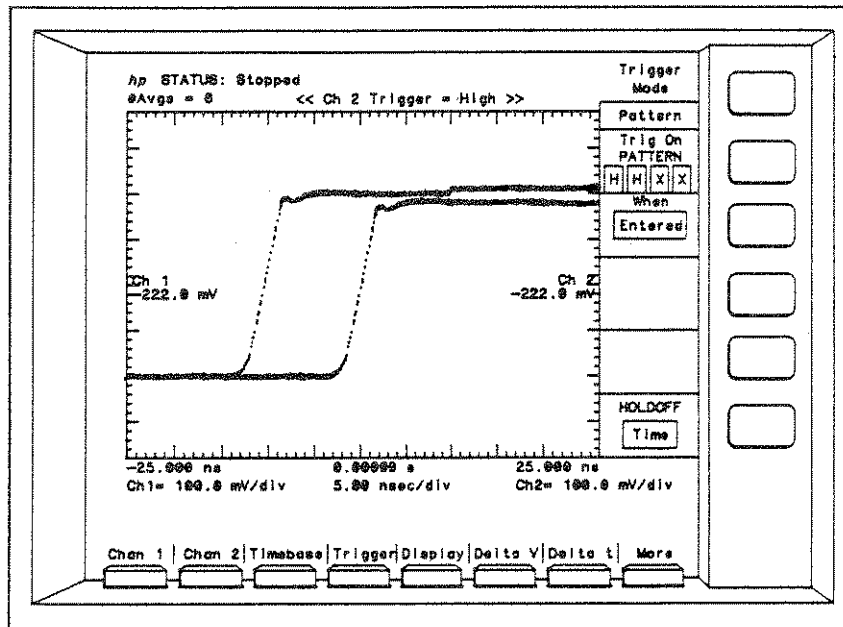

Figure 7-16. Pattern When Entered "HHXX"

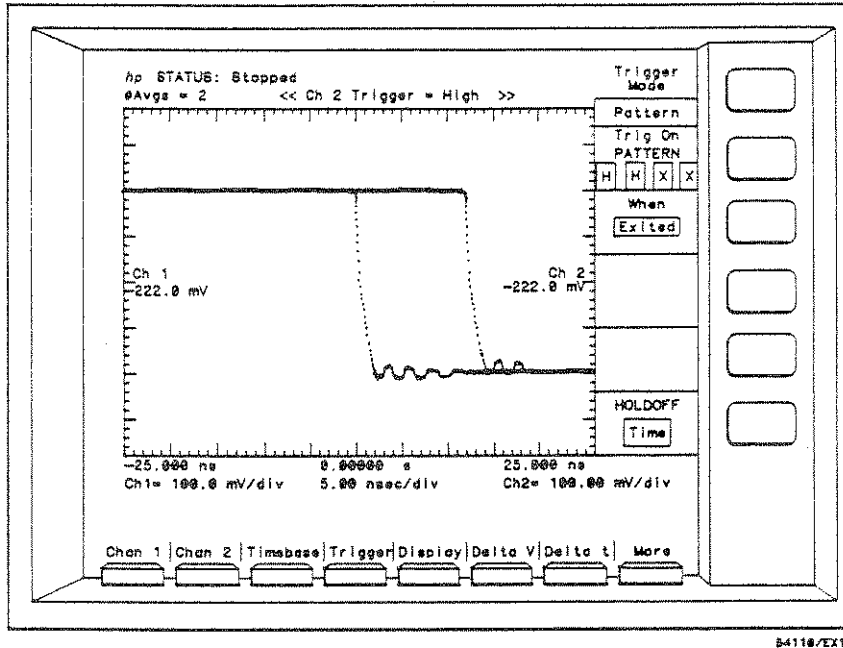

Figure 7-17. Pattern When Exited

This menu allows triggering when entering or exiting a defined logic pattern. If the When Entered function is selected, the unit will trigger on the last pulse edge that makes the pattern true (see figure 7-16). If the When Exited function is selected, the unit will trigger on the first pulse edge that makes the pattern false (see figure 7-17).

This trigger mode would be an advantage while troubleshooting logic circuitry, or any other application where it would be desirable to make parametric measurements while using logic sources for a trigger. In addition to the When Entered/Exited functions, time qualification is provided for the Pattern mode: When Present> and When Present<. The When Present> mode allows the user to specify that the trigger pattern must be present for a minimum period of time (that the user defines) before being accepted as a trigger. If the pattern does not remain true long enough it will be ignored. The When Present < mode is just the opposite. Here the pattern will generate a trigger only if it remains true for less than the time specified. If the pattern is true longer than this time it will be ignored. Both modes generate a trigger when the pattern is exited, only if the time qualifier is true. The range of the time qualifier is from 10 ns to 5 sec.

For the case of the simplest pattern, HXXX, the pattern is true when chan 1 is high and it is false when chan 1 is low. The time qualification can then be used to trigger on pulses that are wider than a specified time and ignore shorter ones (When Present>) or it can be used to trigger on pulses that are shorter than the time qualifier and ignore the longer ones (When Present<). Use this exercise to become familiar with the time qualification feature:

1. Connect the cal signal to channels 1&2.
2. Press AUTO-SCALE
3. Select the Trigger menu.
4. Select the Pattern Trigger mode.
5. Set the Trig On PATTERN to read HHXX.
6. Select the When Present> function
7. Set TIME to 1.5 us. This requires that the pattern be present for greater than 1.5 us to generate a trigger. In this example this will not be true as the + portion of the cal signal is approximately 1 us duration.

- Set TIME to .5 us. The display will now trigger.

The ability of this unit to qualify the trigger pattern with a min-max time interval provides an excellent technique for glitch detection.

7-9. STATE MODE

The next trigger mode is the State mode. This mode allows using simple edge detection combined with pattern recognition to generate a trigger. When this mode is selected, one of the four inputs is chosen as the edge source and the user determines a 3-bit pattern defined over the remaining three inputs.

A trigger will be generated when an appropriate (\pm) edge occurs only when the pattern is true (When Present) or false (When Not Present) as specified by the user. The State function differs from the Pattern Entered/Exited function in that the trigger is generated from a specified edge source for State, while in the Pattern Entered/Exited mode any input can initiate a trigger if it causes the pattern to be true/false. To become more familiar with this function, complete the following exercise:

- Connect the cal signal to channels 1&2.
For chan 1 use a 1 metre cable; for chan 2 use 2 or 3 metres.
- Press AUTO-SCALE
- Select the trigger menu.
- Set the trigger mode to state.
- Set Trig On Edge to Pos.
- Set On Chan When to Chan 1.
- Set PATTERN to -HXX
- = Input being used for edge source.
X = Don't care
H = High State (above trigger threshold)
L = Low State (below trigger threshold)
- Set the Present/Not Present function to Not Present.
The display should be triggered.

With the instrument in this configuration it will generate a trigger on a positive edge on chan 1 if chan 2 is low. Change Not Present to Present -- the display will loose it's trigger.

7-10. DISPLAY

The display menu provides control of how data is displayed on the CRT:

- Whether data on the display is Normal or Averaged.
- The type of graticule that is to be used, grid, frame or axis.
- The format of the display, split screen On/Off.

7-11. NORMAL MODE

When the Normal mode is used, high speed A to D converters digitize the incoming signal and write it to a display memory that in turn provides information to the CRT. The data points that are acquired from the A to D converters are displayed on the CRT for a user-defined period of time from 200 ms to Infinity. To become more familiar with the Normal mode functions, complete the following exercise:

Model 54110D - Exercises

1. Connect the cal signal to channel 1.
2. Press AUTO-SCALE.
3. Select the Display menu.
4. Select the Normal mode.
5. Set DISPLAY TIME to 200 ms. Data points written on the CRT will fade shortly thereafter unless they are refreshed by new input data.
6. Select the Timebase menu.
7. Change the sweep speed to 100 ps/div. This faster sweep speed allows the user to more easily see the effects of changing the DISPLAY TIME. Select the display menu.
8. Change DISPLAY TIME to 1 sec. Notice the change in persistence.
9. Change DISPLAY TIME to 11 sec. The unit will now have infinite persistence (any DISPLAY TIME greater than 10 sec defaults to Infinite).
10. Change DISPLAY TIME to 11 sec. The unit will now have infinite persistence (any DISPLAY TIME greater than 10 sec defaults to Infinite).

The infinite persistence mode causes all acquired data to remain on the CRT until the function is changed.

Long persistence times work well for capturing low repetition rate, relatively fast or narrow (low duty cycle) signals. Infinite persistence also allows viewing worst case jitter, noise, and timing variations; or to view extremely infrequent glitches or other anomalies.

To see the effect of persistence on a low rep rate signal connect the cal signal to chan 1 and press AUTO-SCALE, go to the timebase menu and use 500 ns/div sweep speed with 1.6 sec DELAY. Return to the display menu and vary the DISPLAY TIME from 200 ms to 11 sec notice the differences.

In the infinite persistence mode the data points will remain on the display until the CLEAR DISPLAY key is pressed or until the display is moved with an instrument control such as, sweep speed, vertical sensitivity, or trigger level. Move one of these controls while in the infinite mode and notice the results.

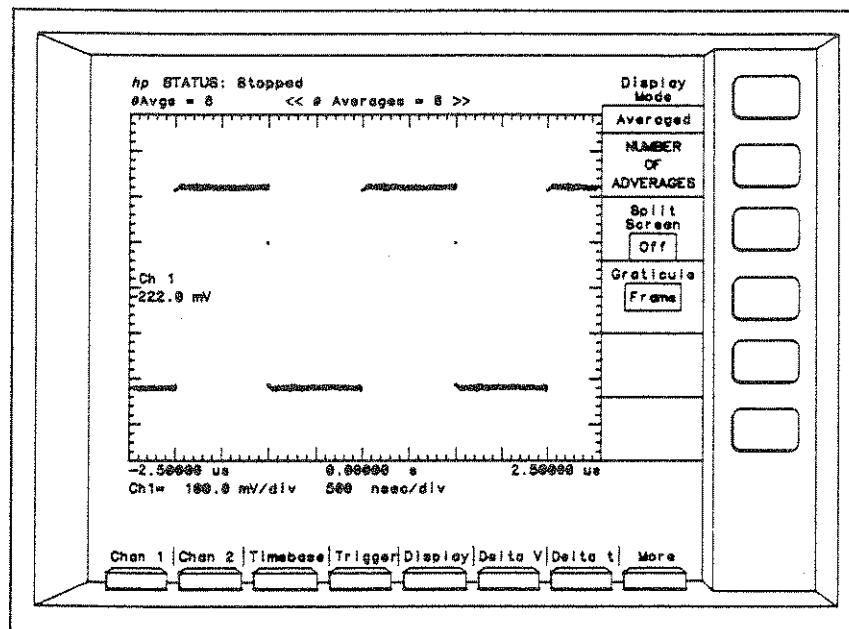

Figure 7-18. Averaged Mode (8 Averages)

7-12. AVERAGED

As the input signal is digitized, each data point is assigned a time coordinate relative to the trigger. In the averaging mode the unit calculates the average of the most recent data point with the previous values in the same time bucket. You can define the number of data points that are to be averaged from 1 to 2048. Each average is calculated from data acquired for each time slot--data for adjacent time slots is not averaged together.

If 8 is chosen for the number of averages, 1/8 of the vertical value of each new data point will be added to 7/8 of the value previously in the time bucket. If 16 averages had been selected, 1/16th of the new data would be averaged with 15/16ths of the previous value.

The effect of using the average mode is to cancel out all phenomena that is not related to the trigger event, i.e., noise and nonrecurring events.

To demonstrate some of the differences between the normal mode and the averaged mode, complete the following exercise:

1. Connect the cal signal to chan 1.
2. Press AUTO-SCALE
3. Select the display menu.
4. Select the averaged mode.
5. Set NUMBER OF AVERAGES to 8. (See figure 7-18).
6. Select the normal mode (see figure 7-19). Compare figures 7-18 and 7-19 and notice the reduction of noise on the averaged display. The larger the number of averages the greater the reduction of the displayed noise and the longer it takes to respond to any change in the input signal.

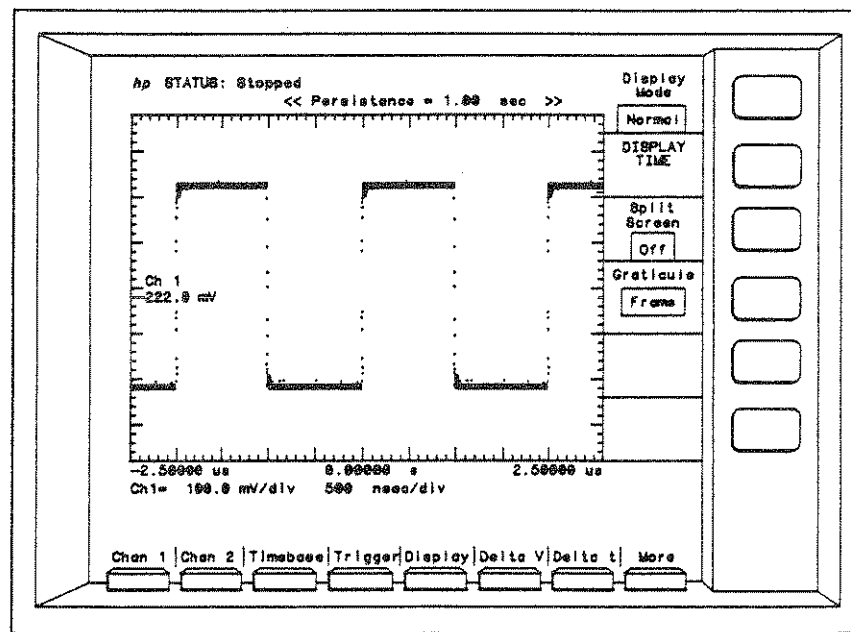

Figure 7-19. Normal Mode

The next exercise shows the effect of the averaged mode and the use of the averaged mode in conjunction with the Magnify mode.

1. Connect the cal signal to chan 1
2. Press AUTO-SCALE.
3. Select the display menu.
4. Select the normal mode.
5. Select chan 1 menu.
6. Select the magnify mode and adjust the WINDOW SIZE and POSITION so that the window is near the top of the cal signal (see figure 7-20).
7. Turn magnify on (see figure 7-21).
8. Select the display menu.
9. Set NUMBER OF AVERAGES = 2 (see figure 7-22).
10. Change NUMBER OF AVERAGES = 512 (see figure 7-23). Notice that with a greater NUMBER OF AVERAGES there will be less noise on the signal and the display will appear to be more stable.

NOTE

With only 1 or a small number of averages, the quantization levels of the A/D converter are also very evident. With a larger number of averages, the actual usable resolution increases as the display fills between quantization levels with averaged data.

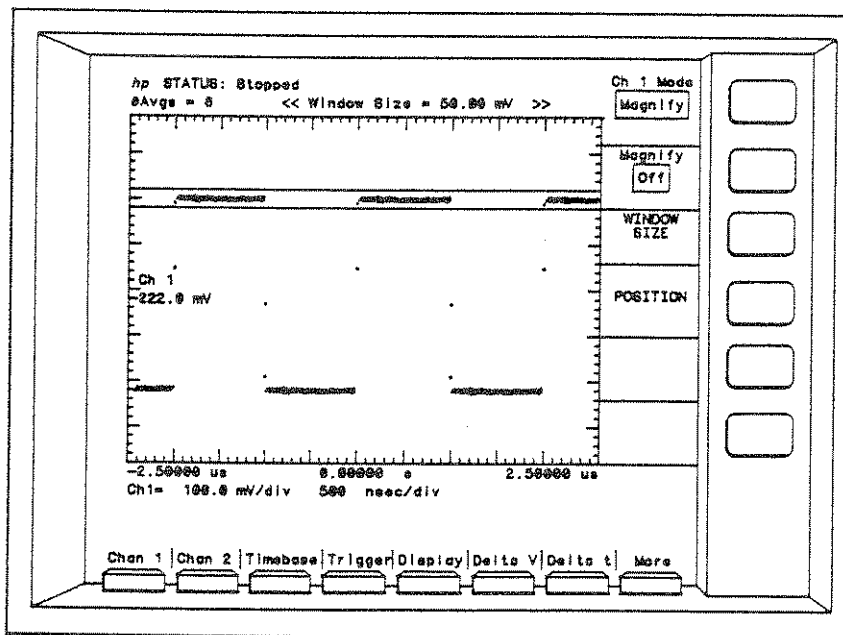

64110/EX16

Figure 7-20. Magnify Window in the Normal Mode.

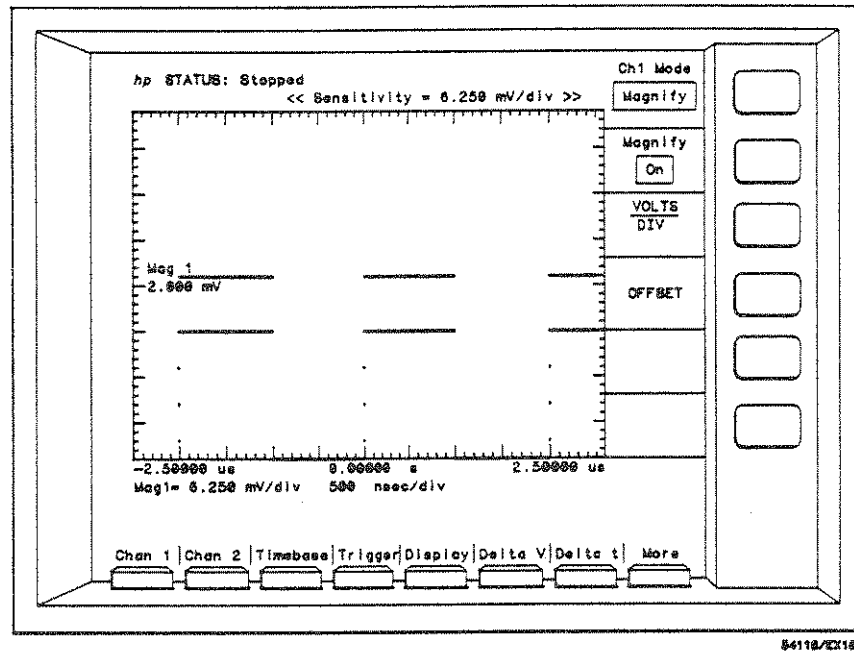
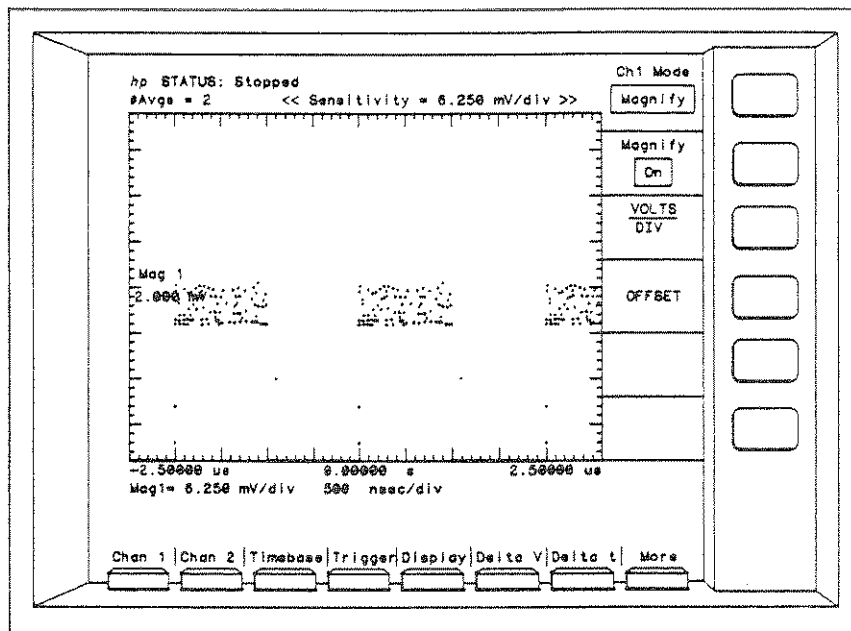

Figure 7-21. Magnify Using Normal Mode

The next exercise will help illustrate how averaging works.

1. Connect the cal signal to chan 1.
2. Press AUTO-SCALE.
3. Select the display menu.
4. Set NUMBER OF AVERAGES to 256.
5. Remove the cal signal from chan 1 and notice the reaction of the display.

As the input signal was removed, the existing values in each time bucket are now being averaged with the new data which is "0". If the number of averages were reduced, the display would converge to the new signal levels in a shorter period of time.



54110/EX17

Figure 7-22. Magnify in the Averaged Mode with 2 Averages

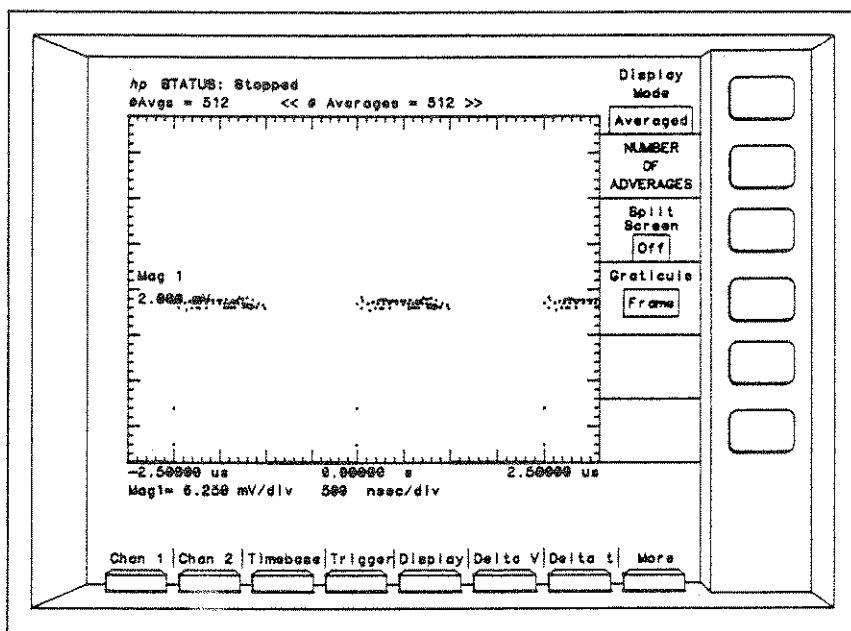

54110/EX18

Figure 7-23. Magnify in the Averaged Mode with 512 Averages

7-13. PROBES

This instrument provides you with the capability of changing the attenuation factor on any input. When this attenuation factor is changed, the actual voltage division ratio of the inputs does not change; however, the scale factors in firmware that are used to generate the answers for the automated parametric measurements and voltage related items on the screen are modified appropriately.

The variable Atten (attenuation) factors would be used so that the display factors would accurately reflect the actual voltage levels at the source when accessory probes or voltage dividers are being used.

The Atten factors are saved with the rest of the front panel setup when the Save/Recall registers are used. When the power is cycled the Atten Factors will automatically set themselves to the value appropriate for the input pod that is installed in each input. For the 54002A and the 54003A, the Atten Factors would be set to 1:1. If the 10:1 accessory probe that is supplied with the 54003A is used, set the Atten Factor for that input to 10:1. This will insure that the correct answers are provided in the factors area on the screen, and that the vertical scale factors previously set (VOLTS/DIV and OFFSET) are correctly referenced to the probe tip.

When the 54001A active probe is used, the Atten Factors will automatically be set to 10:1 when the instrument power is turned on. Use the following exercise to see the effect of changing the Atten Factors:

1. Connect the cal signal to chan 1 and press AUTO-SCALE.
2. Select the Delta V menu.
3. Select the Vmarkers for Chan 1 and press Auto Top-Base. Notice the voltage readings in the factors area.
4. Select the Probes menu. The Ch1 Atten Factor will be set to 1:1 (if the 54002A or 54003A is used).
5. Set the Ch1 Atten Factor to 10:1 by using the entry devices. Notice that as the Atten Factor is changed, the voltage readings in the factors area will change to reflect the new ratio.
6. Connect the cal signal to chan 1 and trig 3.
7. Select the trigger menu.
8. Set the Trig Src to Trig 3 and the TRIG LEVEL to approximately -200 mV (the signal should be triggered).
9. Return to the probes menu and set the Trig 3 PROBE ATTEN to 10:1.

NOTE

Factors can also be used, if you have a known source, to calibrate out systematic errors in gain and attenuation ratio of the 54001A, 54003A or other divider probes. The Atten Factor could be arbitrarily set to yield the correct answer.

10. Return to the trigger menu and notice that the trig 3 level reflects the new ratio.
11. Select the Measure menu and press the All function key. Notice that all of the voltage related factors reflect the 10:1 ratio that has been chosen.

The range of the Atten Factor is from 1 to 1000. The Knob and the step keys will give you up to 3 digits of resolution and the key pad provides up to 4 digits of resolution for setting Atten Factor.

7-14. WAVEFORM MATH

This oscilloscope gives you the capability of defining the two waveform functions using the signals on channel 1 and/or 2 and/or the four waveform memories. After you have defined a waveform function and displayed it you can make automated or manual measurements on that function following the same rules as you would use measuring a signal on a channel.

To demonstrate some of these capabilities perform the following exercises:

1. Connect a cal signal to chan 1 using a 1 metre BNC cable, connect the other cal signal to chan 2 using a 2 metre cable. The time delay between the signals that is created by the unequal cables is approximately 6.4 ns. (See figure 7-24)
2. Press the more key.
3. Select the Wfm Math menu.
4. Insure Func 1 (function 1) is the selected function (see figure 7-25).
5. Insure that Func 1 is set to Chan 1 - Chan 2 with func 1 keyed on.

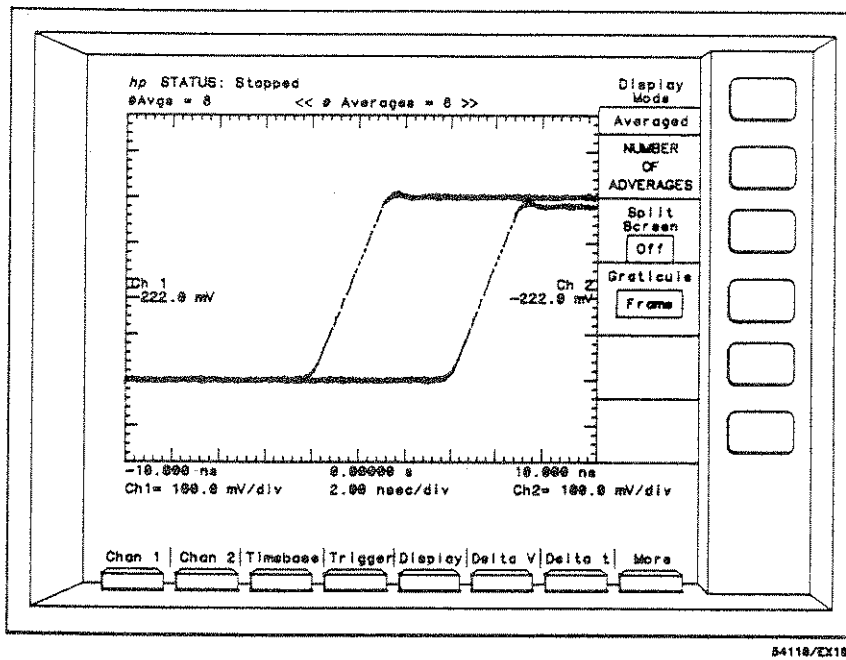
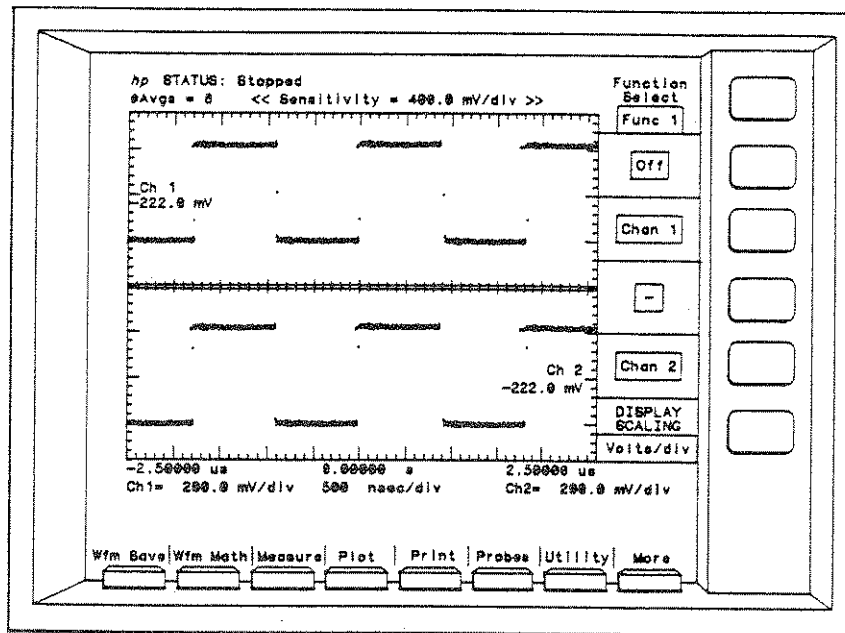

Figure 7-24. Time delay Chan 1 to Chan 2.



54110/EX28

Figure 7-25. Selecting Func 1.

NOTE

Func 1 should be displayed in the top half of the split screen. At this sweep speed Func 1 appears as a narrow voltage spike occurring at the same time as the leading and trailing edges of the cal signal (see figure 7-26). The difference between chan 1 and chan 2 is created by the fact that the signal arrives at the chan 2 input after the signal arrives at chan 1. Remove the input from chan 2 and notice the effect on Func 1. To continue with this exercise reconnect chan 2 to the cal signal.

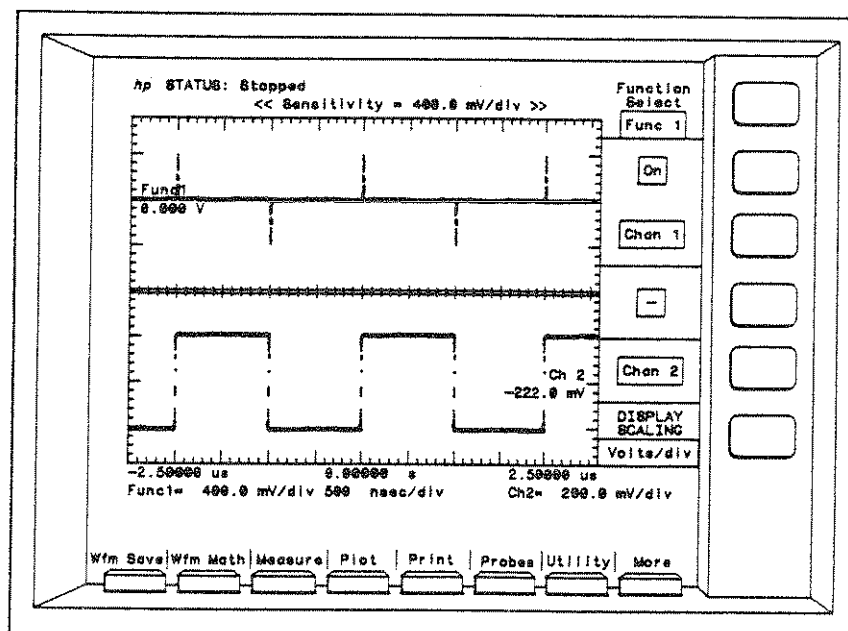

54110/EX21

Figure 7-26. Func 1.

6. Set the function select to Func 2.
7. Define func 2 as chan 1 + chan 2 and key Func 2 on
8. Press the more key and select the timebase menu.
9. Set the sweep speed to 5 ns/div.

NOTE

The display should resemble figure 7-27 with func 1 (chan 1 - chan 2) at the top of the display and func 2 (chan 1 + chan 2). If you has stored one of these functions in a waveform memory, mem 1-4 could have been used as an operand instead of chan 1 or 2.

This instrument also has the capability of making automated measurements on func 1 & 2. This next exercise demonstrates making automated measurements on these function. Leave the instrument configured the same as it was for the previous exercise, that is, cal signals connected to chan 1 and 2 with 1 metre cable on chan 1 and a 2 metre cable on chan 2. Func 1 = chan 1 - chan 2 and func 2 = chan 1 + chan 2. The display should resemble 7-27. Do not change any of the instrument settings until you start the next exercise.

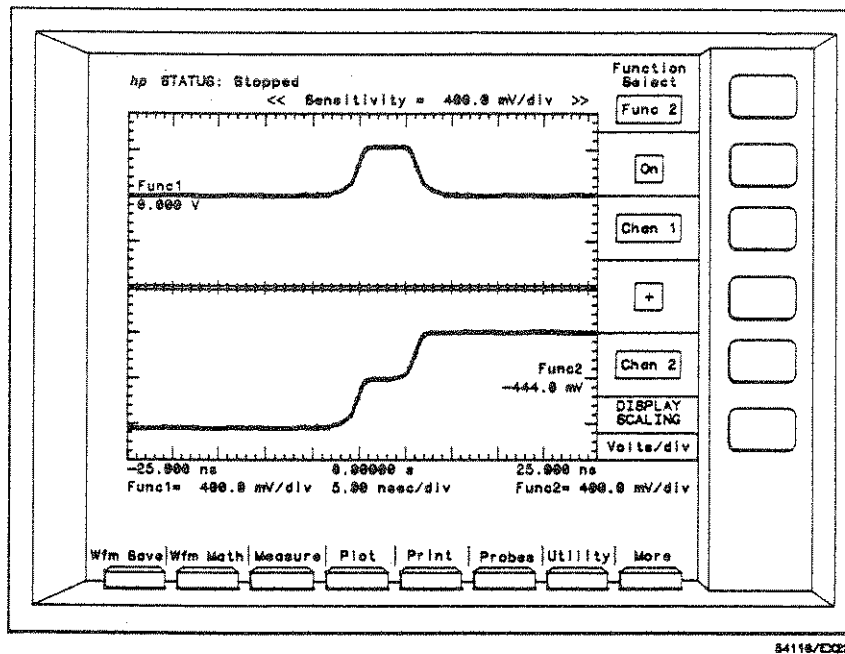

Figure 7-27. Waveform Math Func 1 & 2.

This exercise shows you how to make some of the automated measurements on func 1 & 2.

1. Select the timebase menu and set the sweep speed to 500 ns/div.
2. Press the more key and select the measure function menu.
3. Insure that func 1 is the selected measure source. (top key)
4. Press the more key on the function menu twice, this will place the Peak-to-Peak voltage key at the top of the function menu.
5. Press the peak-to-peak key and notice Vmarker appear on the func 1 trace. Press this key repeatedly. (see figure 7-28)

NOTE

As you continue to press the peak-to-peak voltage key, notice that the Vmarkers change levels. This is caused by the fact that the voltage measurement is being made on the last acquired data and because of the narrowness of func 1 with respect to the display window. Because of this the sampled data may or may not occur at the actual peak value of the waveform. To increase the accuracy and repeatability you can increase the sweep speed.

6. Press the more key (bottom of CRT).
7. Select the timebase menu and set the sweep speed to 5 ns/div.

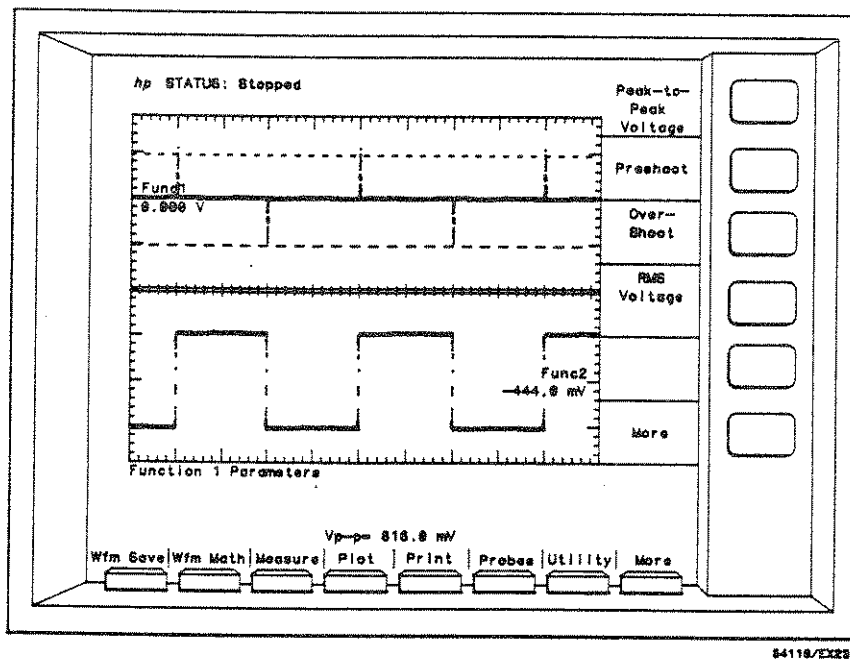
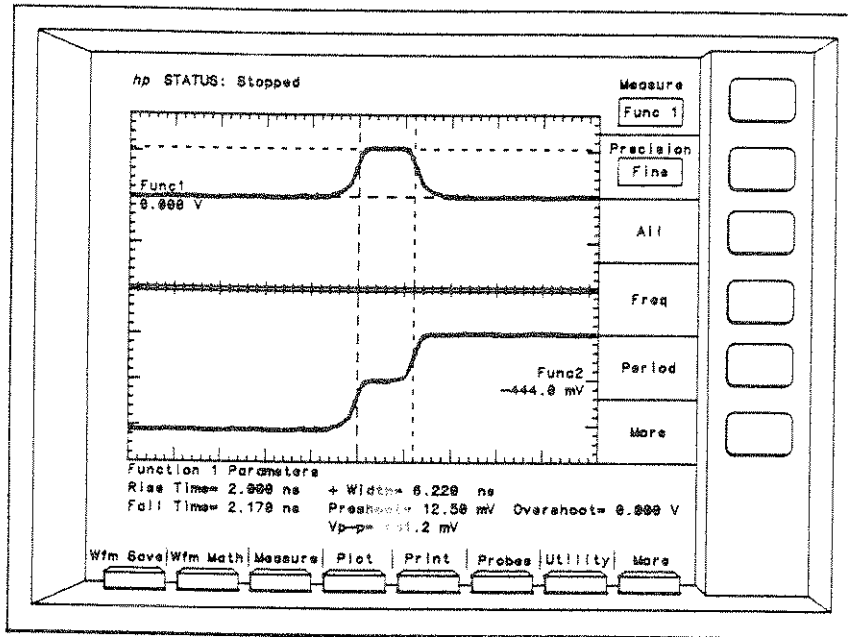

Figure 7-28. Measuring Func 1 Parameters.

8. Return to the measure menu and measure "All" parameters on func 1 (see figure 7-29). The instrument will make the measurements that it can using the the displayed data.
9. Select func 2 and again measure "All" parameters (see figure 7-30).

Notice that after the automated measurements were performed on func 2 that the Delta t and Delta V markers moved from func 1 to func 2.



54110/EX24

Figure 7-29. Automated Measurements on Func 1.

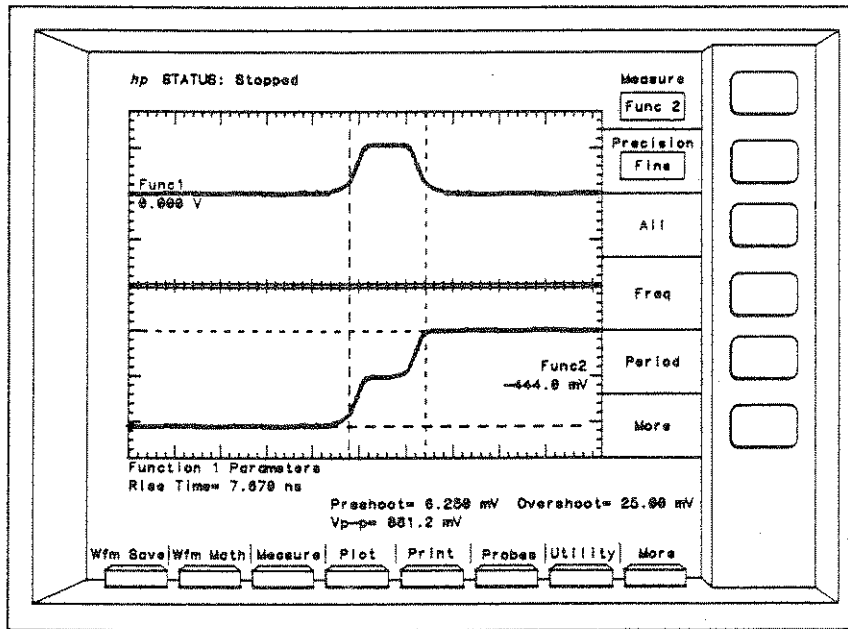

54110/EX25

Figure 7-30. Automated Measurements on Func 2.

The 54110D also provides the capability of making an X,Y or Versus measurements where channels 1 or 2, or memories 1,2,3 or 4 can be used as operands. In the following exercise, a versus measurement is made between channel 1 and channel 2. NOTICE THE REQUIREMENT FOR PRECISE TIME RESOLUTION ON THE WAVEFORM EDGES WHEN YOU ARE MAKING A VERSUS MEASUREMENT.

1. Place a BNC tee on a cal signal output on the rear panel of the instrument and connect 1 metre BNC cables from the tee to channel 1 and channel 2 inputs. It is important that these BNC cables be of equal length so that the cal signal arrives at the channel 1 & 2 inputs at approximately the same time.
2. Press AUTO-SCALE and perform a front panel calibration on the instrument. This nulls the differences between the trigger and data acquisition paths. See Section 6-21 for this procedure. See, also, Appendix B for a discussion of this topic.
3. Select the Display menu and set Mode to Normal and the Display Time to Infinite.
4. Select the Timebase menu and set the SEC/DIV to 1 nsec/div (Figure 7-31). Notice the more precise time resolution (number of data points) on the edges of the signal as compared to the low timing resolution.
5. Press the More key and select the Wfm Math menu. Turn Func 1 On and select Chan 1 Versus Chan 2. (See Figure 7-32).

If waveform edges are measured with inadequate time resolution, the resulting versus waveform will not look as predicted. For Example:

6. Turn Func 1 off and select the Timebase menu. Set the SEC/DIV to 10 nsec/div (see Figure 7-33). Note the near vertical edges, (this indicates lower time resolution).
7. Return to the Wfm Math menu and turn Func 1 on. The resulting chan 1 versus chan 2 (top of Figure 7-34) shows rectangular steps that occur when insufficient edge resolution is used. This is a result of the random repetitive sampling technique used in the 54110D, where by, many voltage points can be taken in the same time interval (as referenced to the trigger). Channel to channel timing skew may further aggravate this situation. To eliminate this phenomena, you should increase time resolution on the edges as shown in figures 7-31 and 7-32. These expanded waveforms allow for more data points on the given waveforms. The increased number of data points on the waveforms reduce the potential for inaccuracies.

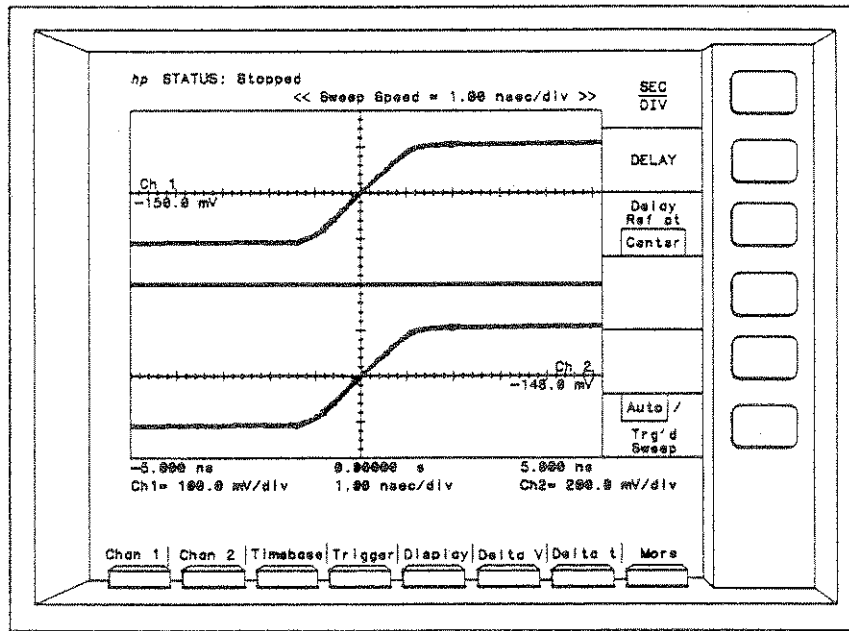

54110/EX26

Figure 7-31. Precise Timing Resolution on Channels 1 & 2.

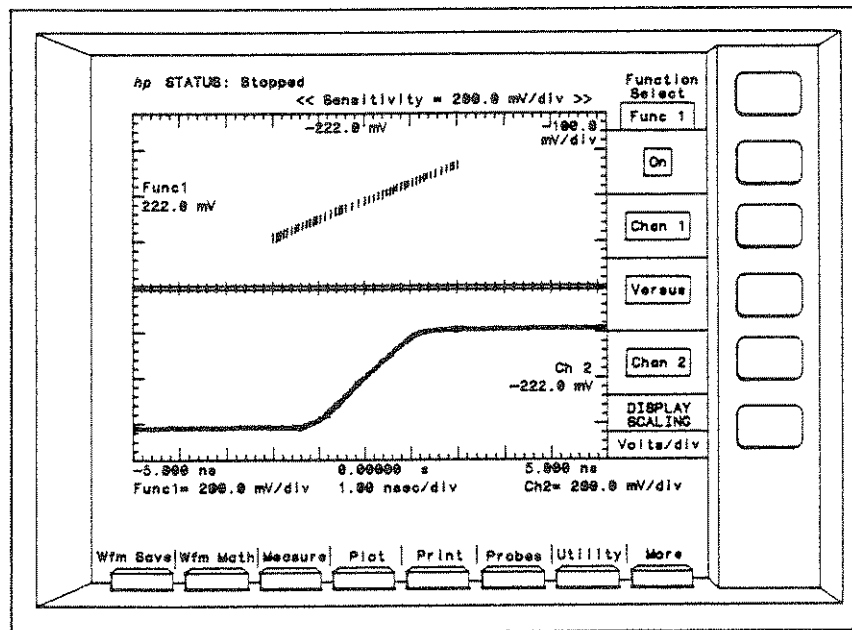

54110/EX27

Figure 7-32. Chan 1 Versus Chan 2 with Precise Timing Resolution.

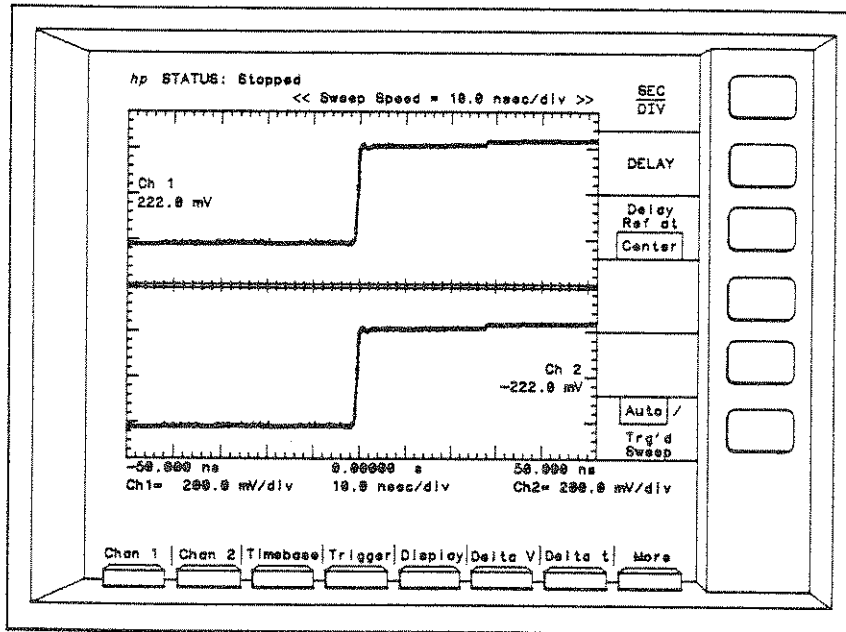

54110/EX23

Figure 7-33. Low Timing Resolution on Channels 1 & 2.

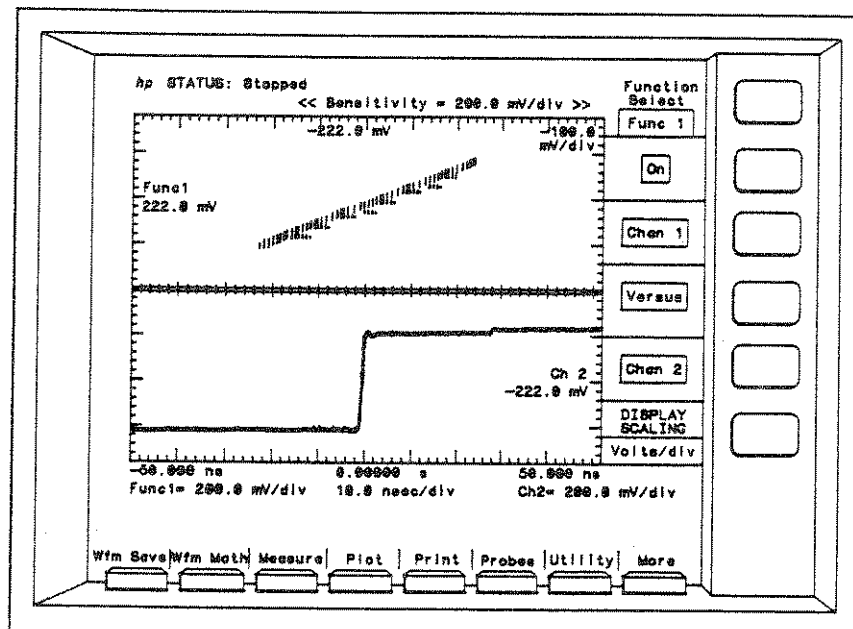

54110/EX23

Figure 7-34. Chan 1 Versus Chan 2 with Low Timing Resolution.

The calibration menu contains an adjustment for nulling the timing skew of channel 2 with respect to channel 1. The following exercise demonstrates how the channel-to-channel skew adjustment can effect waveform math functions:

1. Connect a BNC tee to a cal signal output on the rear panel of the instrument and connect 1 metre BNC cables from the tee to channel 1 and channel 2 inputs. It is important that these BNC cables be of equal length so that the cal signal arrives at the channel 1 & 2 inputs at approximately the same time.
2. Press AUTO-SCALE.
3. Select the Utility menu.
4. Press the Cal menu function
5. Press the top function key twice (SKEW Ch to Ch) will be selected.
6. Use the key pad and set the Ch to Ch SKEW to 10 ns.
7. Press the Exit Cal Menu Key.
8. Select the Timebase menu.
9. Set the sweep speed to 25 ns/div.
10. Press the STOP/SINGLE system control key.
11. Press the CLEAR system control key.
12. Press the STOP/SINGLE key to initiate a single acquisition. See Figure 7-35.

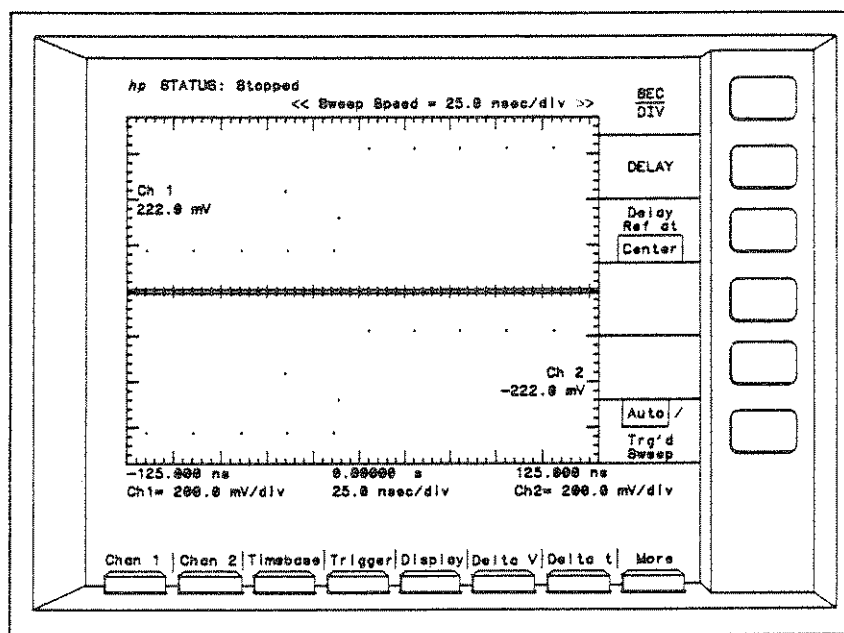

Figure 7-35. Effects of Ch to Ch SKEW on Waveform Math.

The minimum sampling interval is 25 ns therefore will be 10 points displayed there will be 10 data points displayed on each channel and they will be one division apart. The data points for channel 2 were acquired at the same time as the channel 1 data points but are offset by 10 ns because of the channel to channel skew setting. (Press the RECALL key and the 1 key to restore the channel to channel skew cal factor once the display has been evaluated).

When the waveform math functions are used the screen is divided into 500 time buckets. Each pixel column on the screen corresponds to a time bucket. A function which has two operands is performed by matching the data points of one operand with the corresponding data points of the other.

There are several waveform math applications where non-zero channel to channel skew settings can effect the results:

1. A **single shot** measurement on a waveform function using two channels such as Channel 1 + Channel 2 may result in not displaying a waveform. This will occur when the data points acquired for Channel 1 do not correspond in time with the data points acquired for Channel 2.
2. **Common noise on differential signals** may not always cancel when when Channel 1 - Channel 2 function is used. This happens when the Channel 1 data points are matched with Channel 2 data points acquired on another sweep. This effect can be minimized by setting the display mode to Averaged.
3. An **untriggered Channel 1 versus Channel 2** function may result in a misleading display. Again, this happens when data points acquired for Channel 1 on one sweep are matched with data points from Channel 2 acquired on another sweep. In an untriggered mode there is no timing relationship between each sweep.

These effects are less pronounced at slower sweep speeds and disappear at sweep speeds slower than $2 \mu\text{s}/\text{div}$. At $2 \mu\text{s}/\text{div}$ sweep speed and slower more than 500 data points are acquired on each acquisition.

When making these measurements, it may be necessary to set the channel to channel skew to 0. This will allow the data acquired for channel 1 to align with the data acquired for channel 2 for each sweep.

NOTES:

SECTION 8 MAKING A HARDCOPY

8-1. INTRODUCTION

The HP 54110D has the capability of making a hardcopy dump to various HP-IB graphics printers and plotters without the use of a controller. This section will show how to use the HP 54110D with the graphics printers and plotters.

8-2. SETTING UP THE HP 54110D

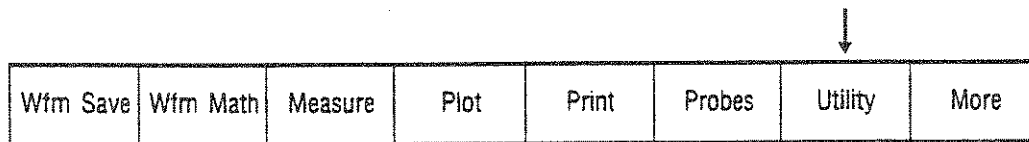

In all cases, without a controller on the system, to dump to a graphics printer or a plotter from the HP 54110D, select the Utility menu then select the HP-IB menu and set the HP-IB function key to "Talk Only".

If you are operating the 54110D and a graphics printer or plotter on a system with a controller, refer to Appendix A of this manual for a sample program.

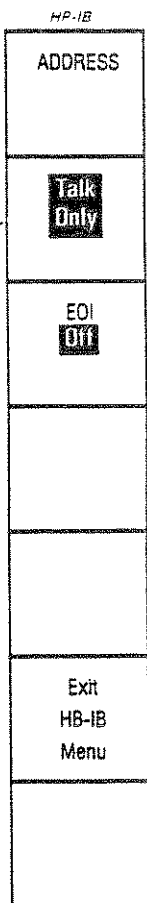

8-3. GRAPHICS PRINTER

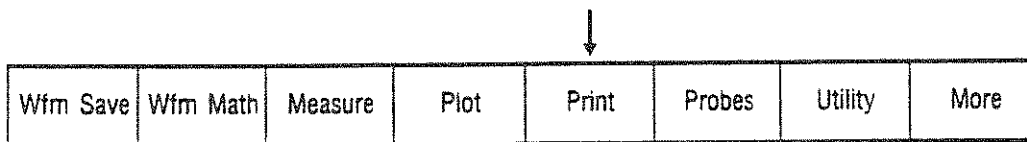

The HP 54110D will interface directly with a graphics printer that uses the Hewlett-Packard Raster Graphics Standard and the HP-IB.

Connect the graphics printer to the 54110D with a HP-IB interface cable (refer to figure 4-4 for a list of available HP-IB mating cables). Before the graphics printer is energized, refer to the printer manual to locate the HP-IB configuration switch on the printer and set the LISTEN ALWAYS(LISTEN ONLY) switch to the true (1) position. It is important that you set this switch before power is applied to the printer as most printers only read these switch settings when the power is first applied. If the switch settings have been changed, the printer must be turned off for several seconds and then back on before printing.

After the HP 54110D has been connected to the graphics printer and the configuration switch has been set to the LISTEN ALWAYS mode, select the Print menu on the HP 54110D.

The print menu will be displayed on the right side of the CRT. The factors (listed below the signal display area) and the Display can be printed separately or at the same time depending of whether they are keyed On or Off.

Data from all sources, i.e., the active display, or the the factors area, that have been selected, will be printed when the Start Print key is pressed. Waveform acquisition stops while print data is output to the printer.

If you chose to stop the print while it is in process, press the Abort Print key.

8-4. COMPATIBLE PRINTERS

The Hewlett-Packard printers that are compatible with the 54110D include:

HP 2225A	HP 2932A	HP 9876A
HP 2671G	HP 2933A	
HP 2673A	HP 2934A	

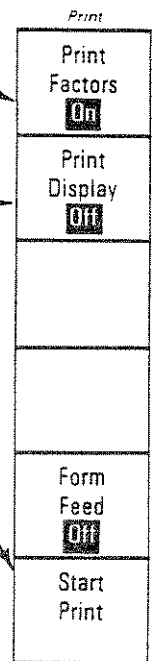

8-5. PLOTTERS

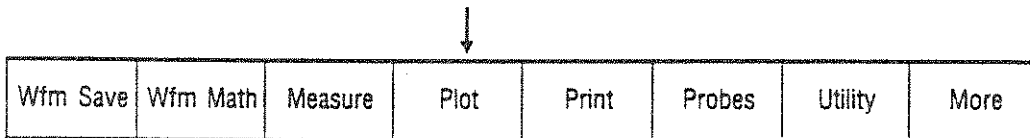

The HP 54110D will interface directly with plotters that use the HEWLETT-PACKARD GRAPHICS LANGUAGE (HP-GL) and a HP-IB interface.

The HP 54110D must be in the "Talk Only" mode when making a graphics dump to a plotter. The status of the HP-IB on the HP 54110D is listed at the top of the display when you are in the Print or Plot menus; "Talk Only", "Listen Only", or the HP-IB address will be listed if the unit is in the Talk/Listen mode. The status of the HP-IB interface can be changed if you select the HP-IB menu.

The plotter must be in the Listen Always (Listen Only) mode. Check the plotter manual for the location of the HP-IB configuration switch and set the Listen Always switch to the true(1) position. Set this switch before the plotter is energized as most plotters read these switch settings when the power is first applied.

Connect the HP 54110D and the plotter using one of the HP-IB interface cables listed in figure 4-4.

After the HP 54110D is connected to the plotter and set to the correct HP-IB configuration for each instrument, select the Utility menu then select the Plot menu. Once this is done, the Plot function menu will be displayed at the right of the CRT.

Section 8 Hardcopy Menu

8-1. Section Contents

The Hardcopy Menu allows you to get a hardcopy of all screen data with either an HP graphics printer or a plotter without an external controller. The hardcopy will include the displayed waveform, measurement factors, graticule and time references. This chapter contains information on how to configure the system and a description of all the hardcopy keys.

8-2. Configuring the System

The following settings are necessary when making a hardcopy using the HP 54110D:

After displaying the waveform to be copied, push the Utility key and select the HP-IB Menu.

Set the HP54110D to talk only mode (see figure 8-1).

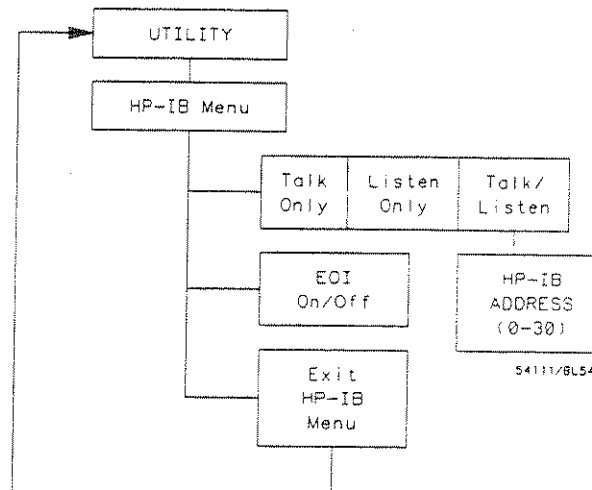

Figure 8-1. HP-IB Menu

Set the printer or plotter to "Listen Only" or "Listen Always." If there is no Listen Only switch, set the address of the printer or plotter to 31 (all 1's on the address switch). This is an invalid address and will automatically set the peripheral to the "Listen Only" mode.

Initialize the printer or plotter by cycling power.

8.3. The Printer Menu

To Print waveform data, press the Print key. The figure below shows the Printer Menu.

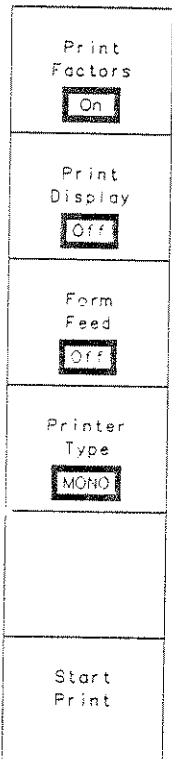

54110/BL13

Print Factors When On, the measurement factors displayed under the waveform area are printed.

Print Display When the Print Display key is on, both the waveform and the graticule are printed.

Form Feed If Form Feed is on, the paper in the printer will automatically form feed after the print is complete.

Printer Type This key selects an HP Graphics printer (MONO) or the HP PaintJet (COLOR) Printer.

Start Print After all options are selected, press Start Print to begin printing.

After the print sequence has begun, the printer menu is changed to another menu containing the following two options:

Pause/Continue This option allows you to stop the print sequence until you push the Continue key again.

Abort This key stops the printing sequence entirely.

8.4. The Color Printer

The oscilloscope is compatible with the HP PaintJet printer. Except for the three color assignments listed in the table below, the PaintJet color assignments correspond to those on the display. For colors other than the three exceptions, changes made in the color menu affect both the display and the PaintJet printer. The three exceptions are necessary for better veiwability of the printed data. This means that if the colors used by the printer are changed, using the color settings in the color menu, the colors on the PaintJet printer will change. The assignments are shown below.

Display	Display Color No.	PaintJet Output
Background Overlap Channel 1	15 (Black) 7 (Magenta) 3 (Yellow)	11 (White) 12 (Black) 10 (Purple)

Example: If the background (color 15) menu is changed to blue, the PaintJet background will remain white, while the displays background will become blue.

8.5. The Plotter Menu

To plot waveform data select the plot menu. The figure on the next page shows the plot menu. Any plotters that are compatible with HP-GL (Hewlett-Packard Graphics Language) may be used as the hardcopy device.

If the Display is in the persistence mode, or if you are plotting pixel memories, the output from the HP 54110D causes the plotter to plot each data point of the display.

In all other cases, waveforms are plotted in a continuous line.

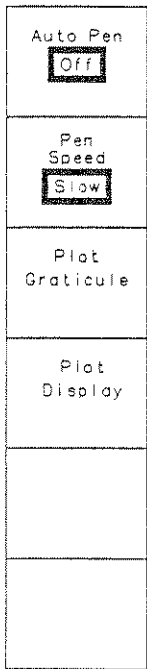

54110/BLOC8

Auto Pen The HP 54110D supports multi-pen plotters. If the Auto Pen option is on the plotter selects a new pen when a different portion of the screen data is plotted.

The pen selection is as follows:

Pen No.	Usage
1	Graticule, timebase factors, channel 3, function 1 and associated factors.
2	Channel 1 and associated factors.
3	Waveform memories and associated factors and both pixel memories.
4	Channel 2 and associated factors.
5	Channel 4, function 2 and associated factors

If Auto Pen is off, the plotter does not change pens when a new screen item is to be plotted.

Pen Speed The Pen Speed key allows you to select fast or slow speeds if the plotter has that capability.

Start Plot When this key is pushed the plotter sequence starts.

While the plotter sequence is in progress, the original menu is changed to another containing the following options:

Pause/Continue This key allows you to momentarily interrupt the plotting sequence. When the Continue key is pushed, plotting will continue from the point of interruption.

Abort This key allows you to stop plotting and return to the menu.

When the Auto Pen function is On, a new pen will be selected when a different function is chosen to be plotted, if the plotter has multi-pen capability. If Auto Pen is Off, the plotter will not load or change pens when the Plot function is selected. In this case, it will be necessary for the operator to load a pen before starting the plot.

The next function key, Pen Speed, allows you to select Fast or Slow, if the plotter in use has this feature. Slow is normally chosen when making transparencies. For best results when using Leroy pens use the slow pen speed.

The next key allows you to plot the displayed graticule including the display factors at the bottom of the CRT.

When Plot Display is selected, all on-screen waveforms will be output to the plotter. This does not include the graticule or the display factors.

If the Display menu is in the Averaged mode, the output from the HP 54110D will cause the plotter to draw a continuous line plot of the active display.

If the Display menu is in the Normal mode the output from the HP 54100D is formatted such that the plotter will plot the waveform(s) in a pixel format, i.e., dot by dot if you are plotting an active display

Waveform memories will always be plotted with a continuous line and pixel memories are always plotted dot by dot.

While a plot is being accomplished you can stop the plot by pressing the Abort Plot key. If you would like to stop for a moment and then continue, press the Pause/Continue.

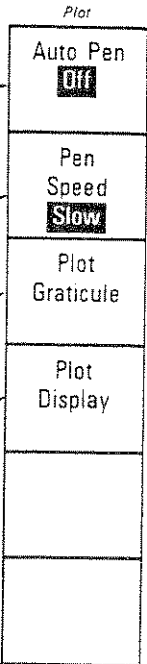

8-6. COMPATIBLE PLOTTERS

The Hewlett-Packard plotters that are compatible with the 54110D include:

- HP 7470A HP 7580B
- HP 7475A HP 7585B
- HP 7550A HP 7586A
- HP 7480A HP 7090A
- HP 9872T

NOTES:

SECTION 9

REMOTE OPERATION

9-1. INTRODUCTION

This section discusses the remote operation of the 54110D over the Hewlett Packard Interface Bus (HP-IB). With the exception of the line switch, all the front panel functions and some instrument features that are remote only operations can be controlled by sending the appropriate commands over the HP-IB.

In this manual 54110D program codes are listed in ASCII code. Table 9-1 lists ASCII characters and some commonly used equivalent codes.

For additional information concerning HP-IB, refer to IEEE std. 488-1978 or the identical ANSI Standard MC1.1, "IEEE Standard Digital Interface for Programmable Instrumentation".

9-2. HP-IB COMPATIBILITY

The 54110D's HP-IB compatibility as defined in the IEEE std. 488-1978 appears in table 9-2.

Twelve HP-IB Meta messages are listed in the left hand column of table 9-2. The most significant of these is the Data message as they contain the program codes that set the instruments mode of operation.

9-3. HP-IB STATUS

The status of the 54110D's HP-IB interface is shown on the CRT by the HP-IB status message. This message describes the remote/local status, address status, and whether or not the instrument is requesting service via the SRQ control line.

9-4. REMOTE MODE

The 54110D communicates over HP-IB in both the local and remote modes. In the remote mode, all front panel controls except the LINE switch and the LOCAL key are disabled. When Local Lockout is enforced the LOCAL key is also disabled.

The 54110D can be addressed to listen or talk while in the remote mode. When addressed to listen, the instrument automatically stops talking and responds to Data messages. When addressed to talk, the instrument stops listening and sends either a Data message or the Status Byte. Whether addressed or not, The 54110D responds to the Local, Local Lockout, Clear Lockout/Set Local, Trigger, and Abort Messages. The instrument may also output a Require Service Message.

The local to remote mode change is accomplished when a remote message is sent to the 54110D. This message contains two parts:

- Remote enable (REN) bus control line true.
- Device listen address (MLA) received once while REN is true.

All instrument settings remain unchanged with the local-to-remote transition. The local-to-remote transition disables the front panel with the exception of the power switch and the LOCAL key.

Table 9-1. Commonly Used Code Conversions

HP-IB	ASCII	Decimal	Binary	Octal	Hexa-decimal	HP-IB	ASCII	Decimal	Binary	Octal	Hexa-decimal		
Addressed Command Group ACG	GTL	NUL	0	00 000 000	000	00	Talk Address	T0	@	64	01 000 000	100	40
		SOH	1	00 000 001	001	01	T1	A	65	01 000 001	101	41	
		STX	2	00 000 010	002	02	T2	B	66	01 000 010	102	42	
	SDC PPC	ETX	3	00 000 011	003	03	T3	C	67	01 000 011	103	43	
		EOT	4	00 000 100	004	04	T4	D	68	01 000 100	104	44	
		ENQ	5	00 000 101	005	05	T5	E	69	01 000 101	105	45	
		ACK	6	00 000 110	006	06	T6	F	70	01 000 110	106	46	
	GET TCT	BEL	7	00 000 111	007	07	T7	G	71	01 000 111	107	47	
		BS	8	00 001 000	010	08	T8	H	72	01 001 000	110	48	
		HT	9	00 001 001	011	09	T9	I	73	01 001 001	111	49	
		LF	10	00 001 010	012	0A	T10	J	74	01 001 010	112	4A	
		VT	11	00 001 011	013	0B	T11	K	75	01 001 011	113	4B	
	Universal Command Group UCG	LLO	FF	12	00 001 100	014	0C	T12	L	76	01 001 100	114	4C
			CR	13	00 001 101	015	0D	T13	M	77	01 001 101	115	4D
			SO	14	00 001 110	016	0E	T14	N	78	01 001 110	116	4E
SI			15	00 001 111	017	0F	T15	O	79	01 001 111	117	4F	
DCL PPU		DLE	16	00 010 000	020	10	T16	P	80	01 010 000	120	50	
		DC1	17	00 010 001	021	11	T17	Q	81	01 010 001	121	51	
		DC2	18	00 010 010	022	12	T18	R	82	01 010 010	122	52	
SPE SPD		DC3	19	00 010 011	023	13	T19	S	83	01 010 011	123	53	
		DC4	20	00 010 100	024	14	T20	T	84	01 010 100	124	54	
		NAK	21	00 010 101	025	15	T21	U	85	01 010 101	125	55	
	SYN	22	00 010 110	026	16	T22	V	86	01 010 110	126	56		
	ETB	23	00 010 111	027	17	T23	W	87	01 010 111	127	57		
FS GS RS US	CAN	24	00 011 000	030	18	T24	X	88	01 011 000	130	58		
	EM	25	00 011 001	031	19	T25	Y	89	01 011 001	131	59		
	SUB	26	00 011 010	032	1A	T26	Z	90	01 011 010	132	5A		
	ESC	27	00 011 011	033	1B	T27	[91	01 011 011	133	5B		
	FS	28	00 011 100	034	1C	T28]	92	01 011 100	134	5C		
	GS	29	00 011 101	035	1D	T29	^	93	01 011 101	135	5D		
Listen Address Group LAG Note 1	L0	RS	30	00 011 110	036	1E	T30	_	94	01 011 110	136	5E	
		US	31	00 011 111	037	1F	T31	~	95	01 011 111	137	5F	
		SP	32	00 100 000	040	20	UNT	—	96	01 011 111	137	5F	
	Secondary Command Group SCG Note 3	L1	33	00 100 001	041	21	S0	·	96	01 100 000	140	60	
		L2	34	00 100 010	042	22	S1	a	97	01 100 001	141	61	
		L3	35	00 100 011	043	23	S2	b	98	01 100 010	142	62	
		L4	#	35	00 100 011	043	23	S3	c	99	01 100 011	143	63
			\$	36	00 100 100	044	24	S4	d	100	01 100 100	144	64
			%	37	00 100 101	045	25	S5	e	101	01 100 101	145	65
		L5	&	38	00 100 110	046	26	S6	f	102	01 100 110	146	66
			'	39	00 100 111	047	27	S7	g	103	01 100 111	147	67
		L6	(40	00 101 000	050	28	S8	h	104	01 101 000	150	68
)	41	00 101 001	051	29	S9	i	105	01 101 001	151	69
		L7	*	42	00 101 010	052	2A	S10	j	106	01 101 010	152	6A
			+	43	00 101 011	053	2B	S11	k	107	01 101 011	153	6B
L8		,	44	00 101 100	054	2C	S12	l	108	01 101 100	154	6C	
		-	45	00 101 101	055	2D	S13	m	109	01 101 101	155	6D	
L9		.	46	00 101 110	056	2E	S14	n	110	01 101 110	156	6E	
	/	47	00 101 111	057	2F	S15	o	111	01 101 111	157	6F		
L10	0	48	00 110 000	060	30	S16	p	112	01 110 000	160	70		
	1	49	00 110 001	061	31	S17	q	113	01 110 001	161	71		
L11	2	50	00 110 010	062	32	S18	r	114	01 110 010	162	72		
	3	51	00 110 011	063	33	S19	s	115	01 110 011	163	73		
L12	4	52	00 110 100	064	34	S20	t	116	01 110 100	164	74		
	5	53	00 110 101	065	35	S21	u	117	01 110 101	165	75		
L13	6	54	00 110 110	066	36	S22	v	118	01 110 110	166	76		
	7	55	00 110 111	067	37	S23	w	119	01 110 111	167	77		
L14	8	56	00 111 000	070	38	S24	x	120	01 111 000	170	78		
	9	57	00 111 001	071	39	S25	y	121	01 111 001	171	79		
L15	:	58	00 111 010	072	3A	S26	z	122	01 111 010	172	7A		
	;	59	00 111 011	073	3B	S27	{	123	01 111 011	173	7B		
L16	<	60	00 111 100	074	3C	S28		124	01 111 100	174	7C		
	=	61	00 111 101	075	3D	S29	~	125	01 111 101	175	7D		
L17	>	62	00 111 110	076	3E	S30	·	126	01 111 110	176	7E		
	?	63	00 111 111	077	3F	S31	DEL	127	01 111 111	177	7F		

NOTES. 1. L<n>#MLA assigned to device number <n>. 2. T<n> = MTA assigned to device number <n>. 3. Meaning defined by Primary Command Group code.

Table 9-2. HP-IB Message Reference Table

HP-IB Meta Message	Applicable	Instrument Response	Related Commands and Control Lines	Interface Functions
Data	Yes	All front panel, menu, and remote functions except LINE switch. Also, all instrument settings may be read via the HP-IB.	DAB EOI EOS MLA UNL MTA UNT OTA	L3 T5
Trigger	Yes	Responds as if the "RUN" System command were issued.	GET MLA	DT1
Clear	Yes	Responds by: <ul style="list-style-type: none"> • Terminating bus communication • Clearing serial poll bits • Clearing input and output buffers • Clearing error queue and key register • Stopping measurements and acquisitions. 	DCL SDC	DC1
Remote	Yes	Enabled to remote mode when the REN bus control line is true. However, it remains in local until it is addressed to listen the first time.	REN MLA	RL1
Local	Yes	Returns from remote to local when it receives the Local message or the LOCAL key is pressed. Settings remain unchanged after the remote-to-local transition.	GTL MLA	RL1
Local Lockout	Yes	When in remote, and local lockout is in effect, the front panel is disabled. Only the system controller can return the instrument to local.	LLO	RL1
Clear Lockout Set/ Local	Yes	Returns to local and local lockout is clear when the REN bus control line goes false.	REN	RL1
Pass/ Take Control	No	The controller subset is not implemented.	TCT	C0
Require Service	Yes	Sets the SRQ line true when one of the service request conditions occur, if it has been enabled to send the RQS message for that condition.	SRQ	SR1

Table 9-2. HP-IB Message Reference Table (continued)

HP-IB Meta Message	Applicable	Instrument Response	Related Commands and Control Lines	Interface Functions
Status Byte	Yes	Responds to a Serial Poll Enable (SPE) bus command by sending an 8-bit byte when it is addressed to talk. Bit 6 (RQS bit) is true if the 54100A/D has set the SRQ bus control line true. The byte is cleared after it is read by the HP-IB controller if the RQS bit was set.	SPE SPD STB	T5
Status Bit	No	Does not respond to a parallel poll.	PPE PPC PPD PPU	PP0
Abort	Yes	Is unaddressed to listen or talk.	IFC	T5 L3

The unit must be in the Talk/Listen mode before the local to remote transition can be made.

The 54110D supports the following HP-IB interface functions: SH1, AH1, T5, TE0, L3, LE0, SR1, RL1, PP0, DC1, DT1, C0, E1.

9-5. LOCAL MODE

When the 54110D is in the local mode all the front panel controls are operational and the instrument will not respond to input data over the bus. If the unit is addressed to talk it can send data messages and the status byte. Whether addressed or not the 54110D will respond to the remote, local, local lockout, clear lockout/set local, trigger and abort messages. The unit can also output a require service message in the local mode.

This instrument always switches to local from remote whenever it receives the local message (GTL) or the clear lockout/set local message. The clear lockout/set local message sets the remote enable control line (REN) false. If the unit is in the local lockout mode the LOCAL key on the front panel will be disabled.

The instrument's settings remain unchanged during remote-to-local transition. The "Remote" indication on the HP-IB status line on the CRT will disappear as the remote-to-local change is made.

9-6. LOCAL LOCKOUT

If the unit was under remote (program) control and the front panel LOCAL key were inadvertently pressed the instrument would return to local control. Data and/or settings could be changed. To prevent this you may use the local lockout message. This command allows return-to-local only under program control.

NOTE

Return-to-local can be accomplished by cycling the power switch, however, this technique has two potential disadvantages:

- *The system controller may lose control of the instrument.*
- *Other HP-IB conditions reset to default states at power up.*

9-7. ADDRESSING

If the bus is in the command mode i.e., the attention control line (ATN) is true, the 54110D interprets the byte on the eight data lines as an address or as a bus command. When the "Talk/Listen" HP-IB function is selected from the front panel the instrument may be addressed to talk or to listen.

If you address the instrument to listen it will remain configured to listen until it receives an abort message (IFC), its own talk address (MTA), or a universal unlisten command (UNL) from the controller.

If you address the instrument to talk it will remain configured to talk until it receives an abort message (IFC), another instrument's talk address (OTA), its own listen address (MLA), or a universal untalk command (UNT). The HP-IB status line on the CRT will indicate "Talk" when the instrument is addressed to talk and "Listen" when the instrument is addressed to listen.

The 54110D is shipped from the factory in the addressable mode, with the talk and listen addresses set to "7", i.e., T7 and L7. Refer to table 9-1 for equivalent address codes. The instrument can also be configured in the talk-only or listen-only mode. These modes enable limited bus operation without an HP-IB controller being connected. The instrument's address and addressing mode may be displayed or changed from the front panel. Refer to Section 6 for complete instructions.

If the instrument is set to the listen-only mode it responds to all data messages sent on the HP-IB. However, it cannot output data messages and is inhibited from responding to the remote, local, local lockout, clear lockout/ set local, or abort messages. In this mode the unit cannot issue the require service message and cannot respond to a serial poll.

NOTE

The front panel is enabled in the listen-only mode. This allows you to change settings while a program is executing.

If the instrument is set to the talk-only mode it does not respond to any of the bus messages. You would select this mode if the 54110D was to output data directly to an HP-IB plotter or printer without the aid of a HP-IB controller.

9-8. HP-IB TURN-ON DEFAULT CONDITIONS

Several HP-IB parameters are reset during power-up, however, both the unit's address and addressing mode are saved in nonvolatile memory.

HP-IB default conditions are:

- HP-IB local mode
- Local-lockout cleared
- Unaddressed (if in normal addressing mode)
- RQS mask set to decimal 32546 (bits 1,5,8,-14 set)
- Status byte register cleared
- WAVE FORMAT set to WORD
- EOI is asserted at the end of messages sent by 54110D
- LONGFORM is OFF
- HEADER is OFF
- ARGUMENT is NUMERIC

Refer to Section 10 for a complete discussion of the WAVE FORMAT, EOI, LONGFORM, HEADER, and ARGUMENT commands.

9-9. DATA MESSAGES

The 54110D communicates on the HP-IB primarily with data messages. The instrument interprets a byte on the eight data lines as a data message when the bus is in the data mode i.e., attention control line (ATN) is false.

This instrument can both receive and send data messages. Input data messages include the instrument's program commands (device dependent commands) used to program front panel functions and all remote functions. Output data messages include instrument status information, the settings of of specific functions, measurement results, and the learn and cal strings.

The learn and cal strings are binary data strings that contain a condensed coding of the entire instrument state and the delay cal factors. Refer to paragraph 9-12 and the descriptions of the key words: SETUP, SETUP?, CALIBRATE, and CALIBRATE?, in Section 10.

9-10. RECEIVING THE DATA MESSAGE

The 54110D responds to data messages when it is in the remote mode (REN is true) and the unit is addressed to listen or when it is in the listen-only mode.

Input data messages contain a string of device dependent commands (program commands) and an end-of-string message. The program codes within a data message are executed after the EOS message is received. The following format rules must be observed for all input data messages:

- A linefeed (<LF>) or an EOI is used as the EOS message. Each data message must be terminated by a <LF> or by asserting the EOI (end or identify), bus signal line with the last byte in the message.
- The carriage return character (<CR>) is not required before <LF>.
- When more than one command is sent in a data message, a semicolon, colon, or a space must be used to separate the program commands.

- Multiple arguments for a command must be separated by commas.
- The total length of a data message string may not exceed 300 characters.

Syntax errors in a data message are trapped and can be reported over HP-IB. Refer to key words "STATUS?", and "ERR?" in Section 10 for details concerning detecting and reporting format errors.

9-11. PROGRAM ORDER CONSIDERATIONS

Commands are interpreted and setups are changed in the 54110D's memory as they are received and found to be syntactically correct. The actual hardware settings are changed at the end of a message (EOS) unless a command to initiate a process is encountered. Process commands are immediate execution commands and include autoscale, system commands such as "DIGITIZE", and measurement commands. In these cases, hardware affected by commands preceding the process command is changed before the process is initiated. Program lines with more than 1 command are executed up to the point where an error is detected. This provides consistent operation whether commands are sent one per message or several per message.

If multiple pulse parameter measurement queries are sent in one message, the answers from those measurements will be queued for output in the order that the queries were received. Outputs in response to other queries are not queued. The last query will determine the message output by the 54110D when it is next addressed to talk.

9-12. PROGRAM COMMAND FORMAT

Program commands consist of a header followed by a parameter field. Headers can be of a long or short form. The long form allows easier understanding of program code and the short form allows more efficient use of the computer. Refer to Section 10 for a thorough discussion of short and long forms.

Program command parameters may be of four types:

Strings - Any group of ASCII characters, excluding quotation marks (decimal 34), surrounded by quotation marks.

Blocks - A block of binary data in the #A format as defined in IEEE Std. 728-1982. This format is a binary block with the format:

<#><A><length word><DAB...DAB>

Length word is a 15-bit binary integer representing the number of DABs. DABs are the data bytes. <A> and <#> are ASCII bytes. 4) **Numeric** - Any integer, floating point, or exponential value. The characters <E> or <e> are used to delimit the mantissa of exponential parameters. Spaces are allowed between <+>, <->, or <E> and digits, but not between digits or <.> and digits.

Alpha - Some commands require or allow alpha arguments such as "ON", or "OFF". These arguments are ASCII strings that start with an alpha character and are followed by a printable character except a <SP>, <,>, <,>, <#>, <">, or <_> (delete).

The general rules for program command formatting are:

- The 54110D sends and receives data messages in standard ASCII code.

- The instrument responds equally to upper and lower case characters.
- Parameter fields containing multiple parameters require a (,) to delimit individual parameters. Syntax errors in data messages are trapped and can be reported via HP-IB. Refer to Section 10 for a discussion of the key words "STATUS?" and "ERROR".

9-13. SENDING DATA MESSAGES

The 54110D can send data messages in local or remote mode, when addressed to talk, or when in the talk-only mode.

NOTE

Before the instrument is addressed to talk, the desired output data must be specified with the appropriate input data message. Otherwise, the instrument outputs the over range value "1E38" by default to complete the bus transaction. If the ERR service request is enabled, a service request will be generated with the "Output Buffer Empty" error in the ERRor queue.

Output data messages include the settings of individual functions, instrument status information, and binary learn string or cal string data. Excluding the learn and cal strings there are two output data types; integer and exponential. All output data messages contain a leading space (<SP>) or minus sign (<->) followed by the function value or status data. <CR> and <LF> are sent as the EOS message for all output data. An EOI can be sent with the <LF> if the EOI has been keyed on from the front panel or by the "EOI" program command.

Refer to Section 10 for a description of key words "LONGFORM", "HEADER", and "ARGUMENT".

NOTE

The 54110D outputs exponential values with the ASCII character "E" between the mantissa and the exponent e.g., 6.02E23.

9-14. LEARN AND CAL STRINGS

If a "SETUP?" command is sent to the 54110D and then the 54110D is addressed to talk the unit will output a learn string. The learn string consists of 236, 8-bit bytes containing information about front panel configuration. This binary data can be stored in the controller's memory for future use. The learn string includes only those parameters that determine the front panel setup of the instrument.

If a "CALIBRATE?" command is sent to the 54110D and then the unit is addressed to talk, it will output a cal string. The cal string consists of 24, 8 bit bytes containing the delay cal factors. This binary data can be stored in the controller's memory for future use.

The learn string and cal string data comprise the same information that is in the instrument's SAVE/RECALL registers. Refer to Section 6 for additional information concerning these registers.

These binary data blocks i.e., the learn string and the cal string, can be returned to the 54110D by preceding the data blocks with the "SETUP" or "CALIBRATE" commands as appropriate. Refer to Section 10 for a discussion of these two key words.

9-15. RECEIVING THE CLEAR MESSAGE

The 54110D responds to the clear message <DCL> and selected device clear message <SDC> by:

1. Clearing all serial poll status bits.
2. Clearing the input and output buffers.
3. Clearing the error queue and key register.
4. Stopping any measurement or acquisition processes except the normal background acquire-display cycle.

9-16. RECEIVING THE TRIGGER MESSAGE

The trigger message (GET bus command) causes the 54110D to make a single acquisition if the unit was in the STOP/SINGLE mode. If the unit is in the AUTO or TRIGereD mode the trigger message will cause the instrument to enable the trigger repeatedly and display the data it acquires on the CRT. See the RUN command in Section 10.

9-17. RECEIVING THE REMOTE MESSAGE

The remote message has two parts: The remote enable bus control line (REN) is held true, then the controller sends a device listen address <MLA>. Instrument settings are unchanged during the transition from local to remote. When the unit is in the remote mode the HP-IB status line on the CRT will indicate "Remote".

9-18. RECEIVING THE LOCAL MESSAGE

The local message returns the 54110D to front panel control. The local message (GTL bus command) addresses the instrument to listen and then switches it from remote to local. The HP-IB status line on the CRT will be eliminated when you go from remote to local. None of the instrument settings are changed during this transition.

Although the local message returns the instrument to front panel control, it does not clear the local lockout if it has been previously set.

9-19. RECEIVING THE LOCAL LOCKOUT MESSAGE

The local lockout message (LLO bus command) disables the 54110D's front panel LOCAL key. Local lockout can be set when the instrument is either in the local or remote modes. After the local lockout is set and the unit is in the remote mode, local lockout will be enforced. While the unit is in remote and the local lockout is set, the remote to local transition can only be made over HP-IB.

9-20. RECEIVING THE CLEAR LOCKOUT/SET LOCAL MESSAGE

The clear lockout/set local message sets the REN control line false and returns the instrument from the remote mode to the local mode and clears the local lockout condition. Instrument settings are not changed by this message. It can be sent when the instrument is either in the remote or local mode. The affect of sending this message when the instrument is in the local mode is to clear the local lockout if it is set.

9-21. SENDING THE REQUIRE SERVICE MESSAGE

The 54110D sends the require service message by setting the SRQ bus control line and bit 6 of the status byte true when a previously programmed condition occurs. The instrument can send the require service message in either local or remote mode. The require service message is cleared when a serial poll is executed by the system controller. During serial poll, the SRQ control line is reset immediately before the instrument places the status byte message on the bus. Table 10-1 includes the conditions that can be selected to cause the require service message. If no conditions are selected, the require service message is disabled.

The 54110D indicates having sent the require service message by displaying "SRQ" on the HP-IB status line. This indicator is turned off when, during a serial poll, the SRQ control line is reset.

The 54110D will not send a require service message unless it is in the Talk/Listen mode.

9-22. THE STATUS WORD

The instrument status word is a 16-bit integer containing information about the instrument condition that set the ready bit in the status byte and/or generate a require service message. Refer to tables 10-1&2 for a description of the bits in the status word. The upper 8 bits of the status word are known collectively as the ready byte and the lower 8 bits correspond to the status byte sent during a serial poll.

The request mask is a 16-bit word that is used to specify both the conditions in the ready byte that set the ready bit in the status byte and the conditions in the status byte that generate the require service message.

The bits in the request mask have the same meaning as those in the instrument status word. The ready bit in the status byte is set when all of the conditions corresponding to bits in the ready mask are true at the same time. This bit is actually set on the transition of the last required condition to become true.

9-23. SENDING THE STATUS BYTE MESSAGE

The status byte message consists of one 8-bit byte. Refer to table 10-1 for the meaning of each bit. The 54110D sends the status byte message when it is addressed to talk and it receives the serial poll enable (SPE) bus command from the HP-IB system controller.

The instrument must be in the Talk/Listen mode in order to send the status byte or respond to the SPE or SPD (serial poll disable) commands.

Bits in the status byte are set depending on the state of the instrument. If a condition occurs that causes one of the bits in the status byte to be set and if its corresponding bit in the request mask is set, the require service message will be sent.

If the RQS bit is set, indicating that the instrument sent the require service message, and a serial poll is executed, all bits in the status byte will be cleared. If the RQS bit is clear and a serial poll is executed, the status byte will be left unchanged.

If a condition that causes one of the bits in the status byte to be set is removed and if the corresponding bit in the request mask is clear, the corresponding bit in the status byte will be cleared.

To supplement the information in the status byte, the ERRor query can be used to determine what specific error occurred.

9-24. RECEIVING THE ABORT MESSAGE

The abort message (IFC control line true) halts all bus activity. When the 54110D receives the abort message, it becomes unaddressed and stops talking or listening. The require service message and the status byte are unaffected by the abort message.

NOTES:

NOTES:

SECTION 10

COMMAND SET OVERVIEW

10-1. INTRODUCTION

With the exception of the line switch, all the front panel controls as well as some instrument features that are remote only operations can be controlled by sending the appropriate commands over the HP-IB.

NOTE

Before you get started programming your 54110D make sure to review Section 4 for information concerning HP-IB address selection and HP-IB interconnections. You should also review Section 9 before continuing with this section.

10-2. COMMAND SET ORGANIZATION

The command set for the 54110D is conveniently divided into eleven separate groups, ten have been organized into functional groups such as the Trigger Subsystem, which contains all the HP-IB commands that control the instrument's triggering functions.

These subsystems include:

1. Acquire Subsystem

The commands in The Acquire Subsystem determine the conditions for the DIGITIZE command.

2. Channel Subsystem

The commands in the Channel Subsystem are used to control the two vertical inputs. (See the VIEW and BLANK System commands for viewing channels 1 & 2 on the CRT.)

3. Display Subsystem

The commands in the Display Subsystem are used to control how data, time & voltage markers, text, and the graticules are displayed on the CRT.

4. Function Subsystem

The commands in the Function Subsystem are used to control the waveform math features of the instrument.

5. Graph Subsystem

The commands in the Graph Subsystem control the vertical magnifier on the instrument.

6. Hardcopy Subsystem

The Hardcopy Subsystem commands control parameters used during the printing and plotting of waveforms from the 54110D.

7. Measure Subsystem

The commands in the Measure Subsystem control the automated measurements that can be made with the 54110D.

8. Timebase Subsystem

The commands in the Timebase Subsystem control the timebase section of the 54110D.

9. Trigger Subsystem

The commands in the Trigger Subsystem control the trigger modes of the 54110D.

10. Waveform Subsystem

The commands in the Waveform Subsystem Control the transfer of data to and from the HP-IB buffer memories in the 54110D.

The 11th group is the **System Commands**. They control the HP-IB operations as well as the basic operation of the 54110D.

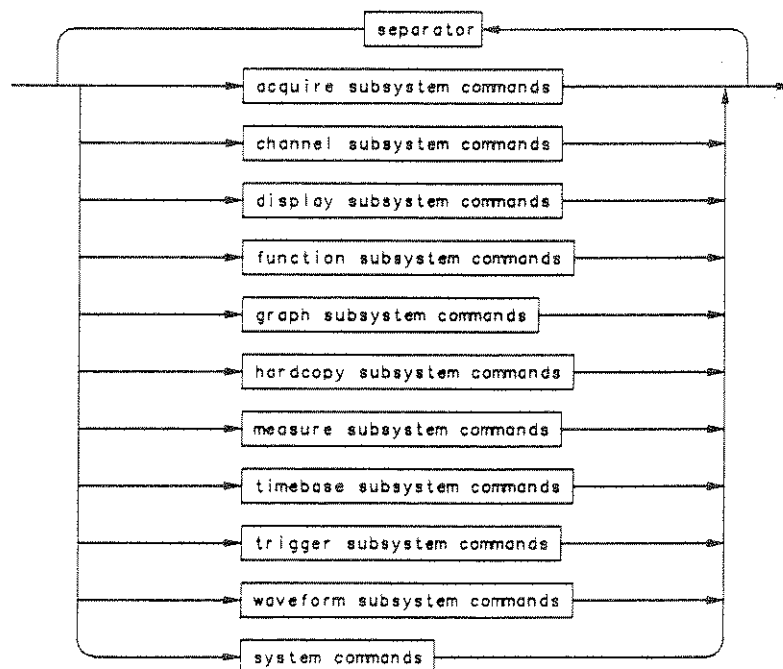
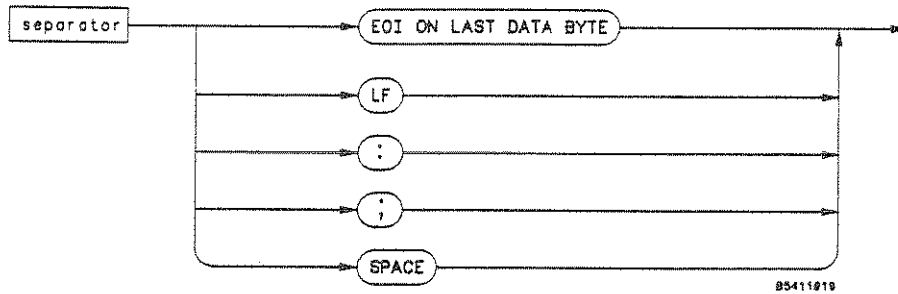

Figure 10-1. Command Set Syntax Diagram.



Command Syntax Diagram (continued).

When programming the 54110D you can initially issue a Subsystem Select Command or a System Command from the controller to the 54110D. If you have selected a particular subsystem you may execute any number of the commands in that subsystem, call System commands indiscriminately or select another subsystem. Calling a System command does not change the Selected Subsystem. Refer to figure 10-1.

NOTE

System commands can be invoked at any time and do not change the subsystem selection.

NOTES:

10-2. NOTATION CONVENTIONS AND DEFINITIONS

The following conventions are used in this manual in descriptions of remote (HP-IB) operation:

< > Angular brackets enclose words or characters that are used to symbolize a program code parameter or an HP-IB command, e.g., <A> represents the ASCII character "A".

| "or": Indicates a choice of one element from a list. For example, <A> | indicates <A> or but not both.

... Trailing dots (an ellipsis) are used to indicate that the preceding element may be repeated one or more times.

[] Square brackets indicate that the enclosed items are optional.

{ } When several items are enclosed by braces, one, and only one of these statements must be selected.

The following definitions are used:

d:: = A single ASCII character, 0-9.

n:: = A single ASCII character, 1-9.

<LF>:: = ASCII linefeed (decimal 10).

<CR>:: = ASCII carriage return (decimal 13).

<sp>:: = ASCII space (decimal 32).

10-3. COMMAND ABBREVIATIONS

Every command and every alpha parameter has at least two forms, a shortform and a longform, in some cases they will be the same. The shortform is obtained by using the following rule:

If the longform has more than 4 characters,
then if the 4th character is a vowel or the same as the 3rd character,
then truncate to 3 characters,
else truncate to 4 characters.

EXAMPLE - LONGFORM abbreviates to LONG.
SERIAL abbreviates to SER.
YOFFSET abbreviates to YOF.

In the case where two short forms would be identical, one of them will be changed slightly to differentiate between the two. In the command descriptions that follow, each command is given in both long and shortforms. Some commands also have industry standard forms and these have been included in the instruction set. This means that some commands will have three forms.

10-4. ALPHA AND NUMERIC ARGUMENTS

Most of the programming commands that require parameters can use either ALPHA or NUMERIC arguments for their parameters.

EXAMPLE - OFF is the same as 0.
ON is the same as 1.

10-5. DATA OUTPUT (QUERY) FORMAT

When a query command (command followed by a "?") is sent to the 54110D, a response message is generated and sent back to the controller the next time the 54110D is addressed to talk.

The command header will be returned if the HEADER command has been set ON and will not be returned if set to OFF.

The command argument will be returned as an alpha argument if the ARGUMENT command has been set to ALPHA and will be returned as a numeric argument if set to NUMERIC. Headers and alpha arguments will be returned in the longform if LONGFORM command has been set ON and will be returned in the shortform if set OFF.

All output fields are an even number of bytes in length. There are four types of output arguments; (1) Headers and Alpha arguments, (2) Integers, (3) Real numbers and (4) Enumerated output. The enumerated output may be alpha or integer depending on whether the ARGUMENT command is set to ALPHA or NUMERIC.

10-6. COMMAND ORDER CONSIDERATIONS

Commands are interpreted and setups are changed in the 54110D as they are received and found to be syntactically correct. Commands preceding an error in multi-command messages are executed up to the point where the error is detected. This provides consistent operation whether commands are sent one per message or several per message.

When a query is executed the reply is placed in the output buffer of the 54110D. Multiple queries on one line result in the last reply overwriting the previous replies. The exception to this is when multiple parameter measurement queries are sent on one command line. In this case the replies to the measurement queries are buffered in the order that the queries occurred in the command line.

10-7. DEFAULT SETTINGS

When power is cycled on the instrument several interface parameters are put in the preset condition. Specifically the request mask (RQS mask) is set to 32546 (bit 1,5,8-14 set).

If you hold a front panel key down at the same time the unit is energized (key down power-up) the unit will initialize a more complete set of parameters. These include selecting arguments to be numeric, headers off and longform off, and EOI to be asserted with the last data byte of a message. This has the same effect as sending a "RESET" command except that the reset command does not change the EOI selection.

10-8. STATUS WORD

The instrument status word is a 16-bit integer containing information about the instrument conditions that set the ready bit in the status byte and/or generate a Require Service message. See Tables 10-1 and 10-2 for a description of the bits in the Status Word. The upper 8 bits of the Status Word are known collectively as the ready byte. The lower 8 bits correspond to the status byte sent during a serial poll.

A companion 16 bit word, the request mask, is used to specify both those conditions in the ready byte that set the ready bit in the status byte, and those conditions in the status byte that generate a Require Service Message. The bits in the request mask have the same meanings as those in the instrument status word. The ready bit in the status byte is set when all of the conditions corresponding to bits in the ready mask are true at the same time. This bit is actually set on the last transition of the last required condition to become true.

The "REQuest" programming command is used to specify the request mask while the "STAtus" programming query can be used to read the instrument status word.

NOTES:

BIT	MASK WEIGHT	STATUS BIT CONDITION
7	128	MSG = High indicates that a message was displayed on the status line of the display. A MSG query is used to determine the message code.
6	64	RQS = Requesting service - High indicates that this instrument requested service.
5	32	ERR = Error - High indicates an error occurred. An ERROR query is used to determine error code.
4	16	RDY = Ready - High indicates the instrument is ready. This is based on the ready mask. A RDY query is used to determine condition.
3	8	LCL = Local switch or power cycle - High indicates that the instrument has been switched to local from the front panel or power was cycled off then on again.
2	4	FPS = Front panel service request - High indicates a front panel key has been pressed. A KEY query is used to determine the key code.
1	2	PWR = Not used, always 0.
0	1	RQC = Request control - Not used, always 0.
<p>Notes:</p> <ol style="list-style-type: none"> 1. To set the RQS bit and SRQ bus control line true, the condition must be enabled in the RQS mask. 2. If no condition is enabled, the 54110D can not set the SRQ bus control line nor the RQS bit true. However, bits 1-5 and 7 of the status byte are set to indicate which conditions have occurred. 3. The Ready bit (bit 4) is set when all conditions in the Ready Byte (Table 10-2) enabled in the request mask are true. 		

Table 10-1. The Lower Byte of the Status Word
(The Status Byte)

BIT	MASK WEIGHT	READY BIT CONDITION
15	32768	Not used, always 0.
14	16384	Cal = High indicates that self calibration has completed execution.
13	8192	Test = High indicates that the requested self test has completed execution.
12	4096	Hard = Hardcopy complete - High indicates that the last byte of printer or plotter dump has been sent and received
11	2048	Data = Data available - High indicates that something is in the buffer waiting to be read.
10	1024	Acq = Acquisition complete - High indicates that all waveforms are acquired.
9	512	Trig = Triggered - High indicates that the instrument is receiving triggers.
8	256	Parse = Parse complete - High indicates that the last command has completed parsing.
<p>Note: The Ready bit (bit 4) of the Status Byte (Table 10-1) is set if all of the ready conditions specified in the RQS mask are true.</p>		

Table 10-2. The Upper Byte of the Status Word
(The Ready Byte)

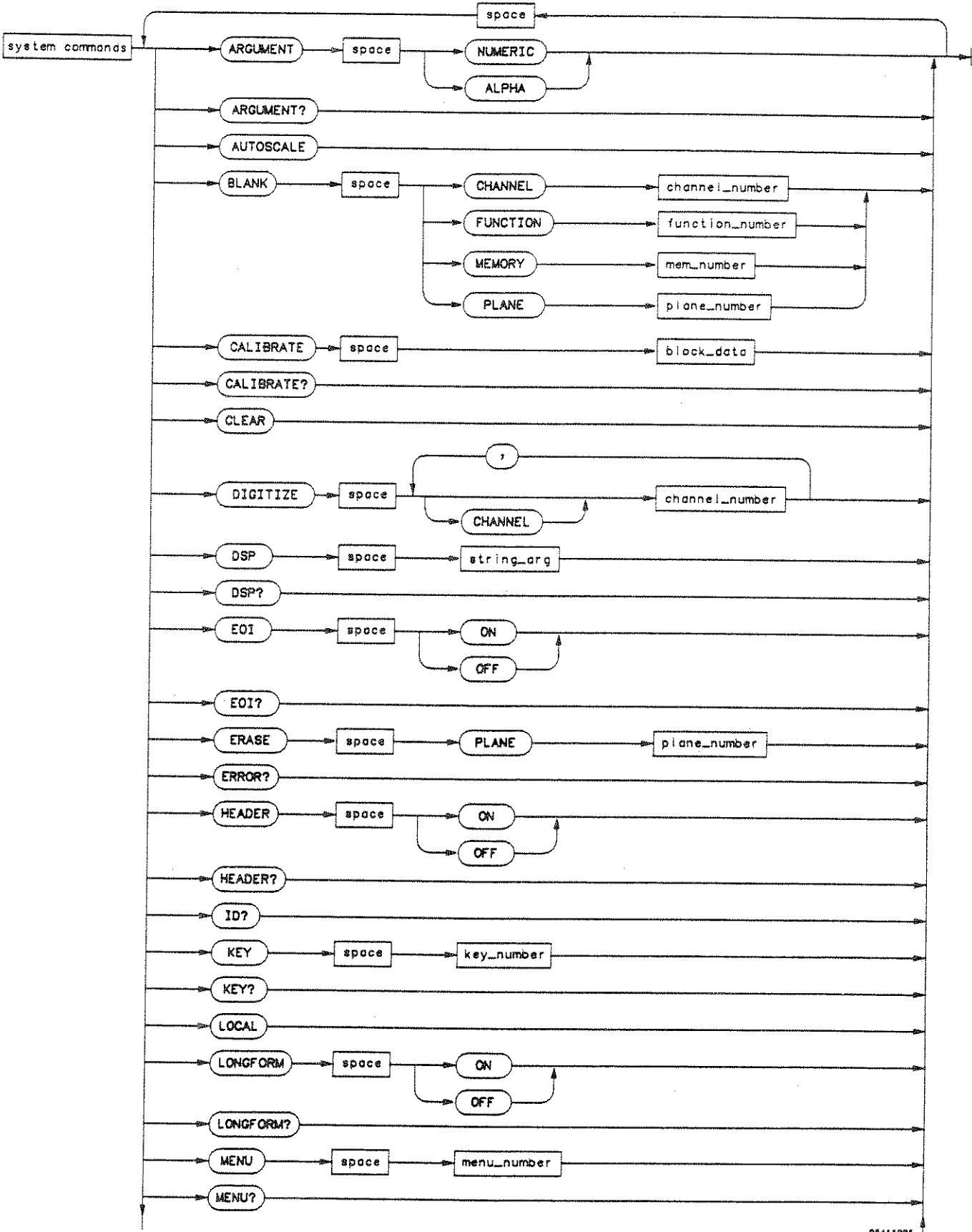
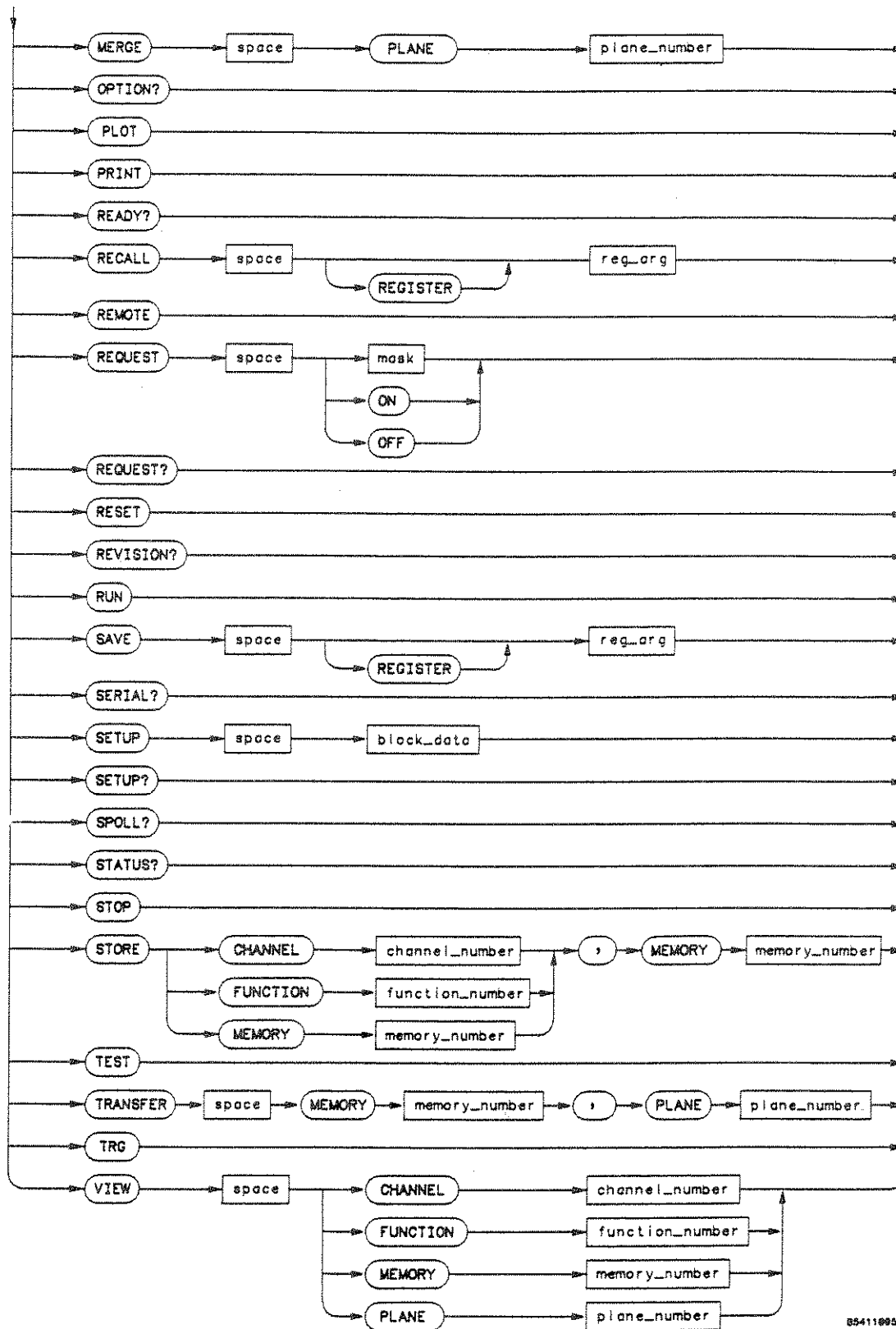

Figure 10-2. System Commands

82411885



85411095

Figure 10-2. System Commands

WHERE:

MENU_NUMBER = An integer from 1 to 14.

KEY_NUMBER = An integer from 1 to 63 (see table 10-3 for keycodes)

STRING_ARG = Any collection of ASCII characters excluding quotes, surrounded by quotes.

REG_ARG = An integer from 0-9.

MASK = An integer between 0 and 65535. This number is the sum of all the bits in the request mask corresponding to conditions that are to be enabled. See tables 10-1 and 10-2 for the bit definitions in the request mask.

BLOCK_DATA = A block of data in #A format as defined in IEEE Std 728-1982.

CHANNEL_NUMBER = An integer 1 or 2.

PLANE_NUMBER = An integer from 0 to 2.

MEMORY_NUMBER = An integer from 1 to 4.

FUNCTION_NUMBER = An integer 1 or 2.

Figure 10-2. System Commands (cont'd)

10-9. SYSTEM COMMANDS

System commands control HP-IB operations as well as the basic operation of the oscilloscope. They can be called at anytime and when the system command has been executed the unit will return to the subsystem that it was in before the system command was executed. Refer to Figure 10-2 for syntax of these commands.

ARGument

command/query

This command sets the output mode for the instrument's response to a query for commands that have both alpha and numerical arguments. If the alpha response is selected the arguments are returned in the alpha format and follow the same abbreviation rules as the commands. If the numeric response is selected the arguments are returned in the numeric format. This command does not affect the input data messages to the 54110D, that is, arguments maybe in either alpha or numeric form regardless of how the ARGUMENT command is set. The response to a query will be returned in the current argument mode.

(continued on next page)

ARGument (cont'd)

Command Syntax: ARGument { [ALPHa | 1]
[NUMeric | 0] }

Example: OUTPUT 707;"ARGUMENT NUMERIC"

Query Syntax: ARGument?

Returned Format: [ARGument]<argument><crlf>

Example: OUTPUT 707;"ARGUMENT?"
ENTER 707;Argument\$
PRINT Argument\$

AUToscale

command

The AUToscale command causes the instrument to automatically select the vertical sensitivity, vertical offset, trigger level and sweep speed for a display of the input signal. If input signals are present at both vertical inputs the sweep will be triggered on Chan 1 and the display will go to the split screen mode and the vertical sensitivity for each channel will be scaled appropriately. If only one of the vertical inputs has a signal on it, the split screen function will be turned off. See Operating Characteristics for input signal requirements for proper AUToscale operation.

When the AUToscale cycle is complete, the Timebase menu will be selected, the input devices will be assigned to the SEC/DIV and the unit will be in the Remote Listen mode.

Command Syntax: AUToscale

Example: OUTPUT 707;"AUTOSCALE"

BLANK

command

The BLANK command causes the instrument to turn off, (stop displaying), an active channel display, function, pixel memory or waveform memory. If you want to turn off an active display channel use the parameter **Channel 1|2**, if you want to turn off a pixel memory use the parameter **Plane 1|2**, where plane 1 = pixel memory 5 and plane 2 = pixel memory 6.

Command Syntax: BLANK { [CHANnel { 1 | 2 }]
[PLANE { 1 | 2 }]
[FUNCTION { 1 | 2 }]
[MEMory { 1 | 2 | 3 | 4 }] }

Example: OUTPUT 707;"BLANK CHANNEL1"

CALibrate

command/query

This command sends a Cal String to the instrument. A Cal String consists of 24 8-bit bytes containing the Delay Calibration factors that are setup in the Cal Menu. These Cal factors are also saved during a front panel SAVE operation and are recalled during a front panel RECALL operation. The CALibrate query sends the Cal String to the controller using the same format as required by the CALibrate command. This means that no modification needs to be made to the string between the time that it is received from the instrument after the query and the time that it is sent back to the instrument.

Command Syntax: CALibrate<Cal String>

Example: OUTPUT 707;"CAL"

Query Syntax; CALibrate?

Returned Format; [CALibrate]<Cal String><crlf>

Example: DIM Cal\${24}
OUTPUT 707;"EOI ON; HEADER OFF"
OUTPUT 707;"CAL?"
ENTER 707 USING "-K";Cal\$
OUTPUT 707;"CAL ";Cal\$

CLEAR

command

The CLEAR command performs an operation similar to a Device Clear <DCL> or the Selected Device Clear<SDC>. The 54110D responds to the CLEAR message by:

1. Terminating all bus communications in process by untalking and unlistening.
2. Clearing all serial poll status bits.
3. Clearing the input and output buffers.
4. Clearing the error queue and key register.
5. Stopping any measurement or acquisition processes except the normal background acquire-display.

Command Syntax: CLEAR

Example: OUTPUT 707;"CLEAR"

DIGitize**command**

This command is used to acquire waveform data for transfer over the HP-IB. It causes an acquisition to take place on the specified channel(s) with the resulting data being stored in the corresponding waveform memory i.e., channel 1 data is stored to waveform memory 1 etc. If ACQUIRE TYPE is ENVELOPE, minimum and maximum data for channel 1 will go in waveform memories 1 and 3 respectively. Similarly, minimum and maximum data from channel 2 will go into waveform memories 2 and 4. The ACQUIRE subsystem commands are used to setup conditions such as TYPE, COMPLETION criteria, number of POINTS and the average COUNT for the next DIGITIZE command. See the ACQUIRE subsystem for a description of these commands.

Command Syntax: DIGitize [CHANne]{ 1 | 2 | 1,2 }

Example: OUTPUT 707;"DIGITIZE CHANNEL 1,2"

DSP**command/query**

This command writes a string to the advisory line (line 15) on the CRT. The query returns the string last written to the advisory line. This may be a string written with a DSP command or an internally generated advisory.

Command Syntax: DSP<ASCII string>

Example: OUTPUT 707;"DSP" "COLOR DISPLAY" ""

Query Syntax: DSP?

Returned Format: [DSP]<string><crLf>

Example: DIM Dsp\$[40]
OUTPUT 707;"DSP?"
ENTER 707;Dsp\$
PRINT Dsp\$

EOI

command/query

This command specifies whether or not the last byte of a reply from the 54110D is to be sent with the EOI bus control line set true or not. The query returns the current status of EOI.

Command Syntax: EOI {[ON | 1] | [OFF | 0]}

Example: OUTPUT 707;"EOI OFF"

Query Syntax: EOI?

Returned Format: [EOI]<argument><crlf>

Example: OUTPUT 707;"EOI?"
ENTER 707;Eoi\$
PRINT Eoi\$

ERASe

command

This command erases a specified display memory plane. Plane 1 is pixel memory 5. Plane 2 is pixel memory 6. Erasing plane 0 is the same as pressing the CLEAR DISPLAY front panel key. If the scope is running and being triggered and ERASe plane 0 is executed the instrument will momentarily stop acquiring data, clear the CRT and then continue with data acquisition.

Command Syntax: ERASe PLANE { 0 | 1 | 2 }

Example: OUTPUT 707;"ERASE PLANE 0"

ERRor?

query

The query causes the 54110D to output the next error number in the error queue over HP-IB. This instrument has an error queue that is 16 errors deep and operates on a first-in first-out basis. Successively sending the query, ERRor? returns the error numbers in the order that they occur until the queue is empty. Any further queries then return 0's until another error occurs. See Table 10-2 for a list Error numbers.

Query Syntax: ERRor?

Returned Format: [ERRor]<NR1><crlf>

Example: OUTPUT 707;"ERRor?"
ENTER 707 USING "-K";Error\$
PRINT USING "K";Error\$

The error numbers and definitions below are the ones reported during an ERROR? query.

ERROR NUMBER	DESCRIPTION
-100	Unknown command
-101	Invalid character received
-110	Command header error
-119	Command header expected
-120	Numeric argument error
-121	Numeric data expected
-123	Numeric overflow
-125	Numeric syntax error
-130	Non-numeric argument error
-131	Character data expected
-132	String data expected
-133	Block data (binary data) expected
-134	String length error
-135	Block length error
-142	Too many arguments
-143	Argument delimiter error
-144	Message unit delimiter error
-149	Missing argument
-150	Query expected
-151	Query not allowed
-201	Command not executable in local mode
-202	Setting lost on power up
-211	Settings conflict
-212	Argument out of range
-222	Insufficient capability/configuration
-230	Transmission aborted
-231	Input buffer full or overflow
-233	Output buffer empty
-301	Interrupt fault
-302	System error
-311	RAM failure (hard error)
-312	RAM data loss (soft error)
-321	ROM checksum error
-340	Self test failed
-350	Timer error
-360	Analog hardware error
-370	Digital hardware error
-399	Power supply failure

Table 10-3. Error Numbers

Positive error numbers are reported after a Self Test Failed error (-340). These refer to the internal self test loops that failed to pass self test.

HEADER

command/query

This command sets the command echo mode for query responses. When HEADER is set to ON query responses will include the command header. The query form of this command tells you whether the echo mode is ON or OFF.

Command Syntax: HEADER ([OFF | 0][ON | 1])

Example: OUTPUT 707;"HEADER ON"

Query Syntax: HEADER?

Returned Format: [HEADER]<argument><crlf>

Example: OUTPUT 707;"HEADER?"
ENTER 707;Header\$
PRINT Header\$

ID?

query

This query returns the instrument model number, 54110D.

Query Syntax: ID?

Returned Format: [ID]<54110D><crlf>

Example: DIM Id\$[10]
OUTPUT 707;"ID?"
ENTER 707;Id\$
PRINT Id\$

KEY

command/query

This command simulates the pressing of a specified front panel key. Keys may be pressed over the HP-IB in any order that is legal from the front panel. Use caution to insure that the instrument is in the desired mode before executing the KEY command. The query returns the key code for the last key pressed over the HP-IB. Key codes range from 1 to 63 with 0 representing no key (returned after power-up). See table 10-3 for a list of key codes.

Command Syntax: KEY<keycode>

Example: OUTPUT 707;"KEY 48"

Query Syntax: KEY?

Example: OUTPUT 707;"KEY?"
ENTER 707;Key\$
PRINT Key\$

KEY	KEYCODE	KEY	KEYCODE
Menu Select 1	1	"-(minus)	23
Menu Select 2	2	0	24
Menu Select 3	3	1	25
Menu Select 4	4	2	26
Menu Select 5	5	3	27
Menu Select 6	6	4	28
Menu Select 7	8	5	29
Menu Select 8	9	6	30
Function Select 1	15	7	31
Function Select 2	14	8	32
Function Select 3	13	9	33
Function Select 4	12	CLEAR DISPLAY	40
Function Select 5	11	RUN	41
Function Select 6	10	STOP/SINGLE	42
sec/Volt	16	SAVE	43
msec/mV	17	RECAL	44
μsec	18	LOCAL	45
nsec	19	AUTOSCALE	48
psec	20	↑	56
CLEAR	21	↕	63
."(decimal pt.)	22	no key	0

NOTE

The Menu Select Keys are located at the bottom of the screen with menu select 1 at the lower left of the screen. The Function Select Keys are located at the right of the screen with function select 1 located at the upper right of the screen.

Table 10-4. 54110D Front Panel Key Codes

LOCAL**command**

This command performs a similar operation to the Clear Lockout/Set Local message. It is provided for controllers with limited HP-IB control capability. The HP-IB Clear Lockout/Set Local Message is the preferred method of switching the instrument from Remote to Local and clearing the Local Lockout. See paragraphs 9-6 and 9-18 for more information.

Command Syntax: LOCAL

Example: OUTPUT 707;"LOCAL"

LONGform**command/query**

This command sets the longform for the instrument's responses to queries. If the LONGform command is set OFF command headers and alpha arguments are sent from the 54110D in the abbreviated form. If the the LONGform command is set ON the whole word will be output. This command does not affect the input data messages to the 54110D -- headers and arguments may be input to the 54110D in either the long or short form regardless of how the LONGform command is set. The query returns the status of the LONGform command.

Command Syntax: LONGform ([OFF | 0]
[ON | 1])

Example: OUTPUT 707;"LONG 1"

Query Syntax: LONGform?

Returned Format: [LONGform]<argument><crlf>

Example: OUTPUT 707;"LONGFORM?"
ENTER 707;Long\$
PRINT Long\$

MENU

command/query

This command allows you to select one of the 14 menus on the front panel. The Query returns the current menu.

Command Syntax: MENU {[1] -Channel 1
 [2] -Channel 2
 [3] -Timebase
 [4] -Trigger
 [5] -Display
 [6] -Delta V
 [7] -Delta t
 [8] -Waveform Save
 [9] -Waveform Math
 [10] -Measurements
 [11] -Plot
 [12] -Print
 [13] -Probes
 [14] } -Utility

Example: OUTPUT 707;"MENU 4"

Query Syntax: MENU?

Returned Format: [MENU] <menu #><cr><lf>

Example: OUTPUT 707;"MENU?"
 ENTER 707;Menu\$
 PRINT Menu\$

MERGE

command

This command stores the contents of the active display to the specified pixel memory. Where plane 1 = pixel memory 5 and plane 2 = pixel memory 6.

Command Syntax: MERGE {[PLANE1 | PLANE2]}

Example: OUTPUT 707;"MERGE PLANE2"

OPTion?

query

This query returns a list of options that are installed on your instrument. If no options are installed a "0" will be returned. (There are currently no internal options for the 54110D.)

Query Syntax: OPTion?

Returned Format: [OPTion] <0><crlf>

Example: OUTPUT 707;"OPT?"
 ENTER 707;Opt\$
 PRINT Opt\$

PLOT

command

This command causes the 54110D to make a hardcopy dump of the display and/or the waveform memories to an HPGL compatible plotter as soon as the oscilloscope is next addressed to talk. The context of the output is controlled with the programming commands in the HARDCOPY subsystem.

Command Syntax: PLOT

Example:

```
CLEAR 707          ! Clear interface buffers.
OUTPUT 707;"PLOT"  ! Starts print buffer.
SEND 7;UNT UNL     ! Clears bus and
!                 ! sets ATN line at controller true.
SEND 7;LISTEN 5    ! Sets plotter at address 5 to listen.
SEND 7;TALK 7      ! Sets 54110D to talk mode.
SEND 7;DATA        ! Sets ATN line at controller false so
!                 ! so data can be transferred.
WAIT 50           ! Wait 50 seconds for transfer to complete
```

NOTE

When programming the 54110D use the SRQ capabilities to determine if the transfer is complete. Attempting to program the instrument while making a hardcopy dump will cause errors.

PRINT

command

This command causes the 54110D to make a hardcopy dump of the display and/or waveform memories using the HP RASTER GRAPHICS STANDARD when the oscilloscope is next addressed to talk. The content of the hardcopy dump is controlled with programming commands in the HARDCOPY subsystem.

Command Syntax: PRINT

Example:

```
CLEAR 707          ! Clears interface buffers.
OUTPUT 707;"PRINT" ! Starts print buffer.
SEND 7;UNT UNL     ! Clears bus, sets ATN line at controller true.
SEND 7;LISTEN 1    ! Sets printer at address 1 to listen
SEND 7;TALK 7      ! Sets the 54110D to talk mode.
SEND 7;DATA        ! Sets ATN line at controller to false
!                  ! so data can be transferred.
WAIT 25            ! Wait 25 seconds for transfer to finish.
```

NOTE

When you are programming the 54110D use the SRQ capabilities to determine if the transfer is complete. Attempting to program this instrument while making a hardcopy dump will cause errors.

READY? | RDY?

query

This query returns the ready byte (the upper byte of the status word). See Table 10-2.

Query Syntax: { READY | RDY }?

Returned Format: [READY]<NR1><crlf>

```
Example: OUTPUT 707;"READY?"
          ENTER 707;Ready$
          PRINT Ready$
```

RECall

command

This command recalls an instrument setup and color settings from a specified save-recall register.

Command Syntax: RECa11[REGISTER]<d>

Example: OUTPUT 707;"RECALL0"

PRINT

command

The PRINT command outputs a copy of the display using the HP RASTER GRAPHICS STANDARD when the oscilloscope is addressed to talk.

The contents of the Hardcopy output is controlled with the programming commands in the HARDCOPY subsystem.

Any HP Graphics printer may be used as the Print Hardcopy device.

Command Syntax: PRINT

Example:

```
10 CLEAR 707 ! Clear interface buffers
20 OUTPUT 707;"HARDCOPY PRINTER COLOR" ! Select the color printer as the hardcopy device
30 OUTPUT 707;"HARDCOPY SOURCE MEM0" ! Selects screen as information to be printed
40 OUTPUT 707;"HARDCOPY PAGE AUTOMATIC" ! Sends a form feed after print is complete
50 OUTPUT 707;"PRINT" ! Command to start printing
60 SEND 7;UNL UNT ! Unaddress bus, asserts ATN line
70 SEND 7;LISTEN 1 ! Address printer @ 701 to listen
80 SEND 7;TALK ! Sets the HP 54110 to talk
90 SEND 7;DATA ! Sets ATN line to allow data transfer
100 WAIT 30 ! Wait for data transfer to complete
110 END
```

Note

When you are programming the HP 54110D you should use the SRQ (Service Request) capabilities to determine if the transfer is complete. Attempting to program this instrument while making a hardcopy will cause errors.

REMOTE

command

This command performs a similar operation as a Remote message followed by a Local Lockout message. It is provided for use by controllers that have a limited HP-IB control capability. The HP-IB Remote and Local Lockout messages are the preferred method of switching the instrument from Local to Remote and invoking Local Lockout. Refer to paragraphs 9-17 and 9-20. If the REN line is false, the REMOTE command will have no affect..

Command Syntax: REMOTE

Example: OUTPUT 707;"REMOTE"

REQuest | RQS

command/query

The REQuest command sends an SRQ enable code which is an integer representing the binary weighted values of the condition bits in the ready mask and the RQS mask.

The ready mask determines what ready conditions cause the ready bit in the status byte to be set. The RQS mask determines what conditions will cause an SRQ to be issued.

Setting the SRQ enable code clears any pending SRQ, as well as all errors, messages and keys awaiting query. See paragraph 10-7 and Tables 10-1 and 10-2.

Another form of this command allows you to follow the REQUEST command with ON or OFF. This command enables or disables the ability of the 54110D to generate the require service message without changing the request mask. Any unmasked conditions that occur with REQUEST OFF will be saved until the REQUEST ON command is received. At that time, unmasked conditions that occurred before and after the REQUEST ON command will generate the require service message.

Command Syntax: { REQuest | RQS }
{ ON | OFF | SRQ enable code }

Example: OUTPUT 707;"REQUEST 36"

Query Syntax: { REQuest | RQS }?

Returned Format: [REQuest]<SRQ enable code><crlf>

Example: OUTPUT 707;"REQUEST?"
ENTER 707;Request\$
PRINT Request\$

RESet | RST

command

This command presets the instrument to default settings. These settings are the same as those established during a key down power up. See Table 10-4 for a list of the default conditions.

Command Syntax: {RESet | RST}

Example: OUTPUT 707;"RST"

REVision?

query

This query returns an integer corresponding to the revision date of the internal firmware.

Query Syntax: REVision?

Example: OUTPUT 707;"REV?"
ENTER 707;Rev\$
PRINT Rev\$

RUN

command

This command causes the instrument to acquire data for the active waveform display on the CRT based on the timebase mode. If the time base mode is in SINGLE, the RUN command will cause the instrument to enable the trigger once and display the data it acquires on the active on the CRT. This is the same thing that happens when the front panel STOP/SINGLE key is pressed when the instrument is STOPPED. If the timebase mode is AUTO or TRIGGERED, the RUN command will cause the instrument to enable the trigger repeatedly and display the data it acquires continuously on the display. This is the same thing that happens when the front panel RUN key is pressed. See the TIMEbase MODE command for a description of the various modes.

Command Syntax: RUN

Example: OUTPUT 707;"RUN"

RESET CONDITIONS FOR THE 54110D

Ch1/Ch2 Mode	-Normal
Ch1/Ch2 Display	-On
Ch1/Ch2 Volts/div.	-1.0 volts/div
Ch1/Ch2 Offset	-0.0 volts
Ch1/Ch2 Magnify	-Off
Ch1/Ch2 Magnify Window Size	-7.0 volts
Ch1/Ch2 Magnify Window Position	-0.0 volts
Seconds/div	-1.0 usec/div
Delay	-0.0 sec
Delay Reference	-Center Screen
Auto/Triggered Sweep	-Auto
Trigger Mode	-Edge
Trigger Source (edge mode)	-Channel 1
Trigger Level (all sources)	-0.0 volts
Trigger Slope (all sources)	-Positive
Holdoff Mode (edge mode)	-Time
Holdoff Events (edge mode)	-2
Holdoff Time (edge mode)	-70.0ns
Trigger Pattern(pattern mode)	-Ch1; High -Ch2; Dontcare -Trig3; Dontcare -Trig4; Dontcare
Pattern Edge (pattern mode)	-Entering
Holdoff Mode (pattern mode)	-Time
Holdoff Time (pattern mode)	-70.0ns
Holdoff Events (pattern mode)	-2
Display Mode	-Normal
Display Time/Persistence	-0.5s
Number of Averages	-8
Split Screen	-Off
Graticule	-Axes
Completion Criteria (For HP-IB DIGitize command)	-100%
Voltage Markers	-Off
Marker1 Position	--2.5 volts
Marker2 Position	+2.5 volts
Topbase Reference	-100%

Table 10-5. Reset Conditions

Model 54110D - System Commands

Time Markers	-Off
Start Marker Position	--3.5us
Stop Marker Position	++3.5us
Start Marker Edge Slope	-Positive
Stop Marker Edge Slope	-Negative
Start Marker Edge Number	-1
Stop Marker Edge Number	-1
Waveform Memories	-Off
SOURce for Store	-Channel 1
Selected Memory	-Memory 1
Pixel memories	-Off
Waveform Data	-0V
Pattern Duration	-10.0ns
Pattern (pattern edge mode)	-Ch1; Clock -Ch2; Dontcare -Trig3; Dontcare -Trig4; Dontcare
Pattern Present/Not Present	-Present
Holdoff Time (pattern edge mode)	-70.0ns
Arming Slope (time delayed mode)	-Negative
Arming Channel (time delayed mode)	-Channel 1
Time Delay (time delayed mode)	-20.0ns
Trigger Slope (time delayed mode)	-Positive
Trigger Channel (time delayed mode)	-Channel 1
Arming Slope (event delayed mode)	-Negative
Arming Chan. (event delayed mode)	-Channel 1
Events Delay (event delayed mode)	-1
Trigger Slope (event delayed mode)	-Positive
Trigger Chan. (event delayed mode)	-Channel 1
Functions 1&2	-OFF
Functions (definition)	-(Chan 1 - Chan 2)
Functions (volts/div)	-2.0 volt
Functions (offset)	-0.0 volts

RESET VALUES FOR THE HP-IB FOR THE 54110D

Service Request Mode	-Disabled (RQS OFF)
Service Request Mask	-Decimal 32546
Serial Poll Status Byte	-Clear
Error Queue	-Empty
WAVEform Format	-WORD
EOI	-ON
LONGform	-OFF
HEADer	-OFF
ARGument	-NUMERIC

Table 10-5. Reset Conditions

SAVE

command

This command saves an instrument setup and color settings in the specified save/recall register. It's action is the same as performing a SAVE operation from the front panel.

Command Syntax: SAVE[REGISTER]<d>

Example: OUTPUT 707;"SAVE1"

SERial?

query

This query returns the instrument serial number as a quoted string.

Query Syntax: SERial?

Example: OUTPUT 707;"SER?"
ENTER 707; Ser\$
PRINT Ser\$

SETup

command/query

This command sets up the 54110D according to the learn string. The query returns the learn string from the oscilloscope.

Command Syntax: SETup

Example: OUTPUT 707;"SETUP ";Set\$

Query Syntax: SETup?

Returned Format: [SETup]<block type A>

Example: DIM Set\$[276]
OUTPUT 707;"HEADER ON EOI ON"
OUTPUT 707;"SETUP?"
ENTER 707 USING "-K";Set\$
OUTPUT 707;"SETUP ";Set\$

NOTE

The logical order for this instruction would be to send the query first followed by the command at a time of your choosing. The query causes the learn string to be sent to the controller and the command causes the learn string to be returned to the 54110D.

SPOLI? | STB?

query

This query returns the status byte (the lower byte of the status word). This command is similar in operation to conducting a serial poll from the controller except that all bits in the byte returned by this query are dynamic and reflect the state of the instrument at the time of the query. Bits in the byte returned by a serial poll stay set if the require service message was sent and are cleared after a serial poll. This command is provided for use by controllers that have a limited HP-IB control capability. Using the serial poll is the preferred method of reading the status byte.

Query Syntax: { SPOL1 | STB }?

Example: OUTPUT 707;"STB?"
ENTER 707;Stb\$
PRINT Stb\$

STatus

query

This query returns the instrument status word. The instrument status word is a 16-bit word which is returned as an integer, and contains information about the instrument conditions that set the ready bit in the status byte and/or generate a Require Service message. The upper 8 bits of the status word are known collectively as the ready byte, while the lower 8 bits correspond to the status byte sent during a serial poll. The STatus query is used to read the status word representing the current status of the 54110D. Unlike the response to serial poll, the conditions are dynamic, not latched. Therefore the status response reflects the current status.

A companion 16 bit word, the request mask, is used to specify both those conditions in the ready byte that set the ready bit in the status byte, and those conditions in the status byte that generate a Require Service message. The bits in the request mask have the same meanings as those in the instrument status word. The ready bit in the status byte is set when all of the conditions corresponding the bits in the ready mask are true at the same time. This bit is actually set on the transition of the last condition to become true. The REQuest system command is used to specify the request mask.

Query Syntax: STATus?

Example: OUTPUT 707;"STA?"
ENTER 707;Sta\$
PRINT Sta\$

STOP

command

This command causes the instrument to stop acquiring data for the active display on the CRT. The RUN command must be executed in order to restart the acquisition.

Command Syntax: STOP

Example: OUTPUT 707;"STOP"

STORE

command

This command allows you to move stored waveforms from one place to another internal to the instrument. This command has two parameters. The first is the source of the waveform which can be Channel 1 | 2, Function 1 | 2, or Memory 1 | 2 | 3 | 4. The second parameter is the destination of the waveform which can be Memory 1 | 2 | 3 | 4.

Command Syntax: STORE { [CHANnel 1 | 1]
 [CHANnel 2 | 2]
 [FUNction 1 | 9]
 [FUNction 2 | 10]
 [MEMory 1 | 11]
 [MEMory 2 | 12]
 [MEMory 3 | 13]
 [MEMory 4 | 14] } <, >
 { [MEMory 1 | 11]
 [MEMory 2 | 12]
 [MEMory 3 | 13]
 [MEMory 4 | 14] }

Example: OUTPUT 707;"STORE CHANNEL2, MEMORY4"

TEST | TST

command

This command causes the instrument to perform a self-test. This is the same test that is executed when the instrument is powered up. The Tst bit in the Status Word (bit 13) will go to a 1 when the test is complete.

Command Syntax: {TEST | TST}

Example: OUTPUT 707;"TEST"

VIEW**command**

The VIEW command causes the instrument to turn on, (start displaying), an active channel, function, pixel memory or waveform memory. If you want to turn on an active display use the parameter **Channel 1|2**. If you want to turn on a pixel memory use the parameter **PLANE 1 | 2**, where plane 1 = pixel memory 5 and plane 2 = pixel memory 6. Using the **VIEW MEMory { 1 | 2 | 3 | 4 }** command in the split screen mode causes memories 1 and 3 to be displayed on the upper screen and memories 2 and 4 to be displayed on the lower screen.

Command Syntax: VIEW {[CHANnel { 1 | 2 }}
 [PLANE { 1 | 2 }}
 [FUNcTion { 1 | 2 }}
 [MEMory { 1 | 2 | 3 | 4 }]]

Example: OUTPUT 707;"VIEW CHANNEL 1"

NOTES:

NOTES:

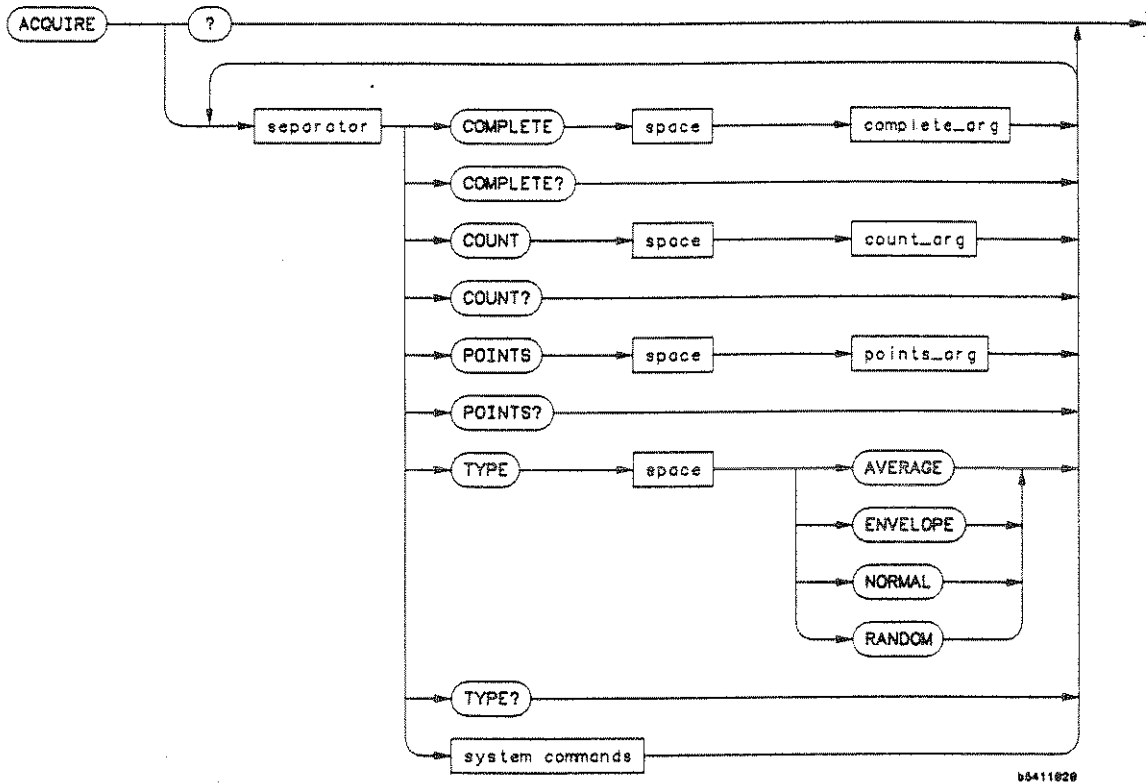

COMPLETE_ARG ::= An integer from 0 to 100, specifying, in percent, the number of buckets that must be filled before acquisition is considered complete.

COUNT_ARG ::= An integer from 1 to 2048 specifying the number of values to average for each point when in the averaged mode, and the number of values to use for each point when constructing the envelope.

POINTS_ARG ::= An integer specifying the number of points to be collected for each waveform record. Acceptable values are 128, 256, 500, 512, or 1024.

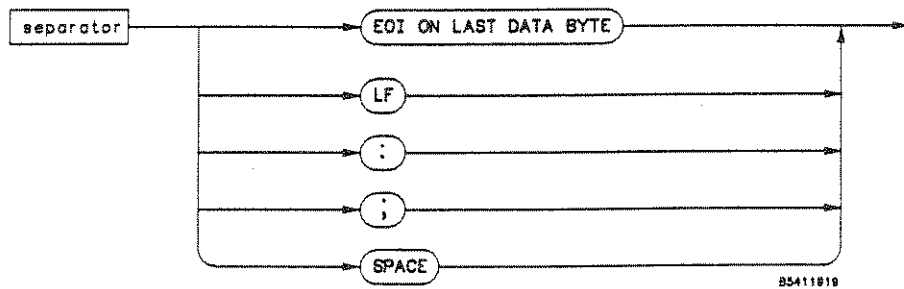

Figure 10-3. Acquire Subsystem Commands.

POINTS | PNTS

command/query

This command specifies the number of points for each acquisition record. The command has one parameter and may be specified to be 128, 256, 500, 512 or 1024. 500 points is preferred if the acquired data is to be used for automatic measurements or function operands. There are two cases where the POINTS command has no affect:

For sweep speeds faster than 2 ns/div., the number of points is based on 10 ps resolution of the instrument's timebase. This means:

```
If (2.0 ns/div)>(time per div)>=(1.0 ns/div) then POINTS = 1000(500 if selected)
If (1.0 ns/div)>(time per div)>=(500 ps/div) then POINTS = 500
If (500 ps/div)>(time per div)>=(200 ps/div) then POINTS = 200
If (200 ps/div)>(time per div)>=(100 ps/div) then POINTS = 100
```

If the TYPE is RANDOM, the number of points is based on the number of complete data records (the points collected on each trigger) that can be gathered and not to exceed 1024. The data acquisition hardware allows the data points gathered after a trigger event to vary with time per division and delay. It can also vary by one data point from one trigger event to the next. This makes it difficult to predict the number of points that will be gathered for any DIGITIZE command when the TYPE is RANDOM. Before the data is read from the instrument with the WAVEFORM DATA? query, the WAVEFORM POINTS? query may be used to determine the actual number of points collected. The query returns the last specified value.

Command Syntax: {POINTs | PNTS}

Example: OUTPUT 707;"PNTS 128"

Query Syntax: {POINTs | PNTS}?

Returned Format: [POINTs] <NR1><crlf>

Example: OUTPUT 707;"POINTS?"
ENTER 707;Points\$
PRINT Points\$

TYPE

command/query

This command lets you select the type of acquisition that is to take place when a DIGITIZE system command is executed. This command has one parameter and may be one of the following:

NORMAL

Last data value to be collected in each acquisition bucket. The data is returned to the controller as a series of voltage values that represent the evenly spaced data points on the CRT.

RANDOM

The Random mode simulates the way the instrument collects data for display on the CRT. This data is returned to the controller as a list of time-voltage pairs.

AVERAGE

The average of the data values collected in each acquisition bucket. The data is returned to the controller as a series of voltage values that represent the evenly spaced data points on the CRT.

ENVELOPE

The max and min value in each acquisition bucket. The data is returned to the controller as two lists of voltage values, the min values first then the max values.

When you change TYPE to AVERAGE the front panel display mode is changed to averaged. Changing TYPE to NORMAL, ENVELOPE, or RANDOM switches the front panel display mode to Normal.

Command Syntax: TYPE { [NORMAL | 1]
[AVERAGE | 2]
[ENVELOPE | 3]
[RANDOM | 4] }

Example: OUTPUT 707;"ACQUIRE; TYPE RANDOM"

Query Syntax: TYPE?

Returned Format: [TYPE]<argument><crlf>

Example: OUTPUT 707;"TYPE?"
ENTER 707;Type\$
PRINT Type\$

NOTES:

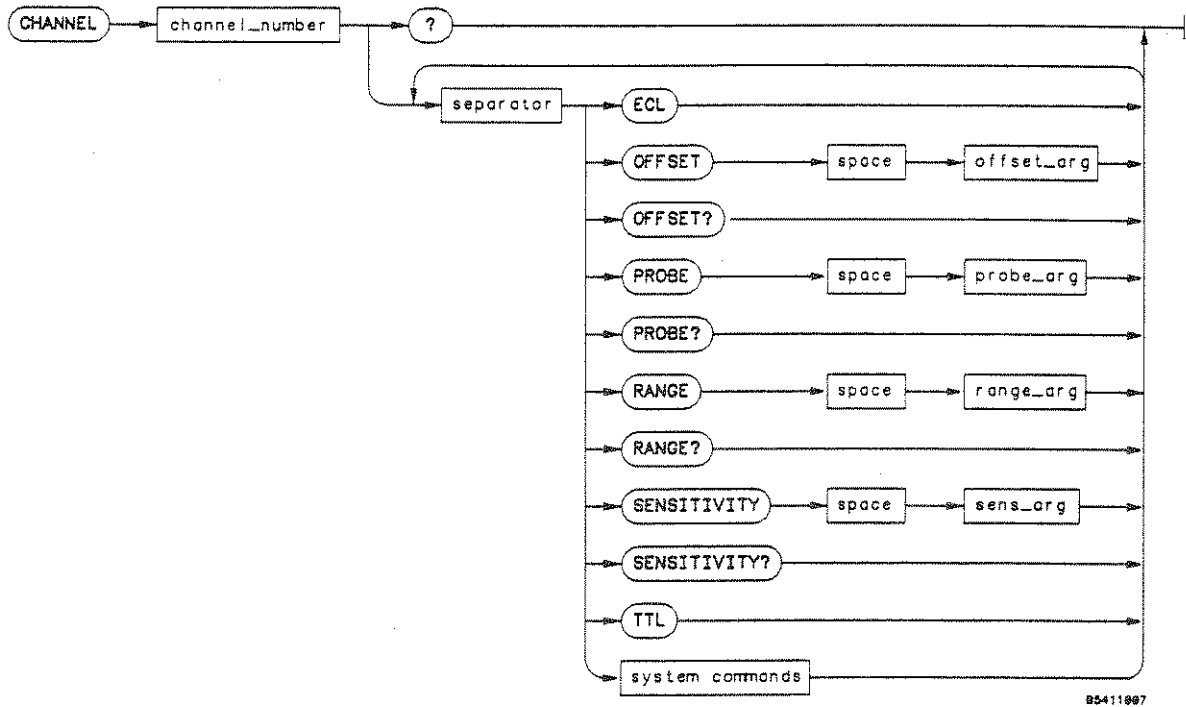

CHANNEL_NUMBER = 1 or 2

OFFSET_ARG = A real number defining the voltage at the center of the voltage range smaller than 1.5 X voltage range.

PROBE_ARG = A real number from 1.0 to 1000.0 specifying the probe attenuation with respect to 1.

RANGE_ARG = A real number specifying the size of the acquisition window in volts. Acceptable values are 0.08, 0.16, 0.4, 0.8, 1.6, 4.0, 8.0. (With the probe attenuation ratio set at 1:1)

SENS_ARG = A real number specifying the size of the acquisition window in volts/div. Acceptable values are 0.01, 0.02, 0.05, 0.1, 0.5, or 1.0 when the split screen display format is off. When the unit is in the split screen mode the acceptable values are: 0.02, 0.04, 0.1, 0.2, 0.4, 1.0, 2.0. (With the probe attenuation ratio set at 1:1)

Figure 10-4. Channel Subsystem Commands

10-11. CHANNEL SUBSYSTEM

The CHANNEL subsystem allows you to control all vertical or Y axis functions of the 54110D. Channel 1 and channel 2 are independently programmable for all functions. See Figure 10-4.

CHANnel | CH

command/query

This command allows you to select the vertical subsystem with the specified channel designated as the destination for the subsystem commands. The query responds with all the settings for the specified channel.

Command Syntax: (CHANnel | CH) { 1 | 2 }

Example: OUTPUT 707;"CHANNEL 1"

Query Syntax: (CHANnel | CH) { 1 | 2 }?

Returned Format: [CHANnel | CH]<NR1><crlf>
[PROBe]<NR3><crlf>
[RANGe]<NR3><crlf>
[OFFSet]<NR3><crlf>
[COUPling]<DC><crlf>

Example: DIM Chan\$[100]
OUTPUT 707;"EOI ON"
OUTPUT 707;"CHANNEL 2?"
ENTER 707 USING "-K";Chan\$
PRINT USING "K";Chan\$

ECL

command

This command sets the vertical range and offset and the trigger level for the selected channel for optimum viewing of ECL signals. The offset and trigger level are set to -1.30 volts and the range will be set to 1.6 volts.

Command Syntax: ECL

Example: OUTPUT 707;"ECL"

OFFSet

command/query

This command allows you to set the voltage that is represented at center screen for the selected channel. The range of OFFSet is $\pm 1.5X$ RANGE of the selected channel.

Command Syntax: OffSet <OFFSET_ARG>

Example: OUTPUT 707;"OFFSET 650E-3"

Query Syntax: OFFSet?

Returned Format: [OFFSet] <NR3><crlf>

Example: OUTPUT 707;"OFFSET?"
ENTER 707;Offset\$
PRINT Offset\$

PROBe

command/query

This command allows you specify the probe attenuation factor for the selected channel. The range of the probe attenuation factor is from 1.0 to 1000.0. This command does not change the actual input sensitivity of the 54110D, it changes the reference constants that are used for scaling the display factors and for automatic measurements, trigger levels, etc.

Command Syntax: PROBe <PROBE_ARG>

Example: OUTPUT 707;"PROBE 15.5"

Query Syntax: PROBe ?

Returned Format: [PROBe]<NR3><crlf>

Example: OUTPUT 707;"PROBE?"
ENTER 707;Probe\$
PRINT Probe\$

RANGe

command/query

This command allows you to define the full scale vertical axis of the selected channel. If you use a 1:1 probe attenuation factor the acceptable values for RANGe are: 0.08, 0.16, 0.4, 0.8, 1.6, 4.0, and 8.0. These values represent the full scale deflection factor of the vertical axis in volts. These values change as the probe attenuation factor is changed, e.g., if the probe attenuation factor is changed from 1:1 to 10:1 the Maximum RANGe value changes from 8 to 80 volts full scale. The query returns the current range setting.

Command Syntax: RANGe <RANGE_ARG>

Example: OUTPUT 707;"RANGE 4"

Query Syntax: RANGe?

Returned Format: [RANGe]<NR3><crlf>

Example: OUTPUT 707;"RANGE?"
ENTER 707;Range\$
PRINT Range\$

SENSitivity

command/query

This command allows you to specify the vertical deflection in volts/division as opposed to volts full scale as specified with the RANGe command. With the probe attenuation ratio set to 1:1 the allowable values for SENSitivity when you are using the single display format are 0.010, 0.020, 0.050, 0.100, 0.200, 0.500, and 1.000. All of these values represent volts/vertical division when using the grid graticule. The SENSitivity command takes the probe attenuation ratio into account so the SENSitivity value programmed should be the desired sensitivity at the probe tip. The query returns the current sensitivity setting.

Command Syntax: SENSitivity <SENS_ARG>

Example: OUTPUT 707;"SENSITIVITY 1"

Query Syntax: SENSitivity ?

Returned Format: [SENSitivity] <NR3><crlf>

Example: OUTPUT 707;"SENS?"
INPUT 707;Sens\$
PRINT Sens\$

TTL

command

This command sets the vertical range and offset and the trigger level for the selected channel for optimum viewing of TTL signals. Offset and trigger level will be set to 1.6 volts and the range will be set to 8.0 volts.

Command Syntax: TTL

Example: OUTPUT 707;"TTL"

NOTES:

NOTES:

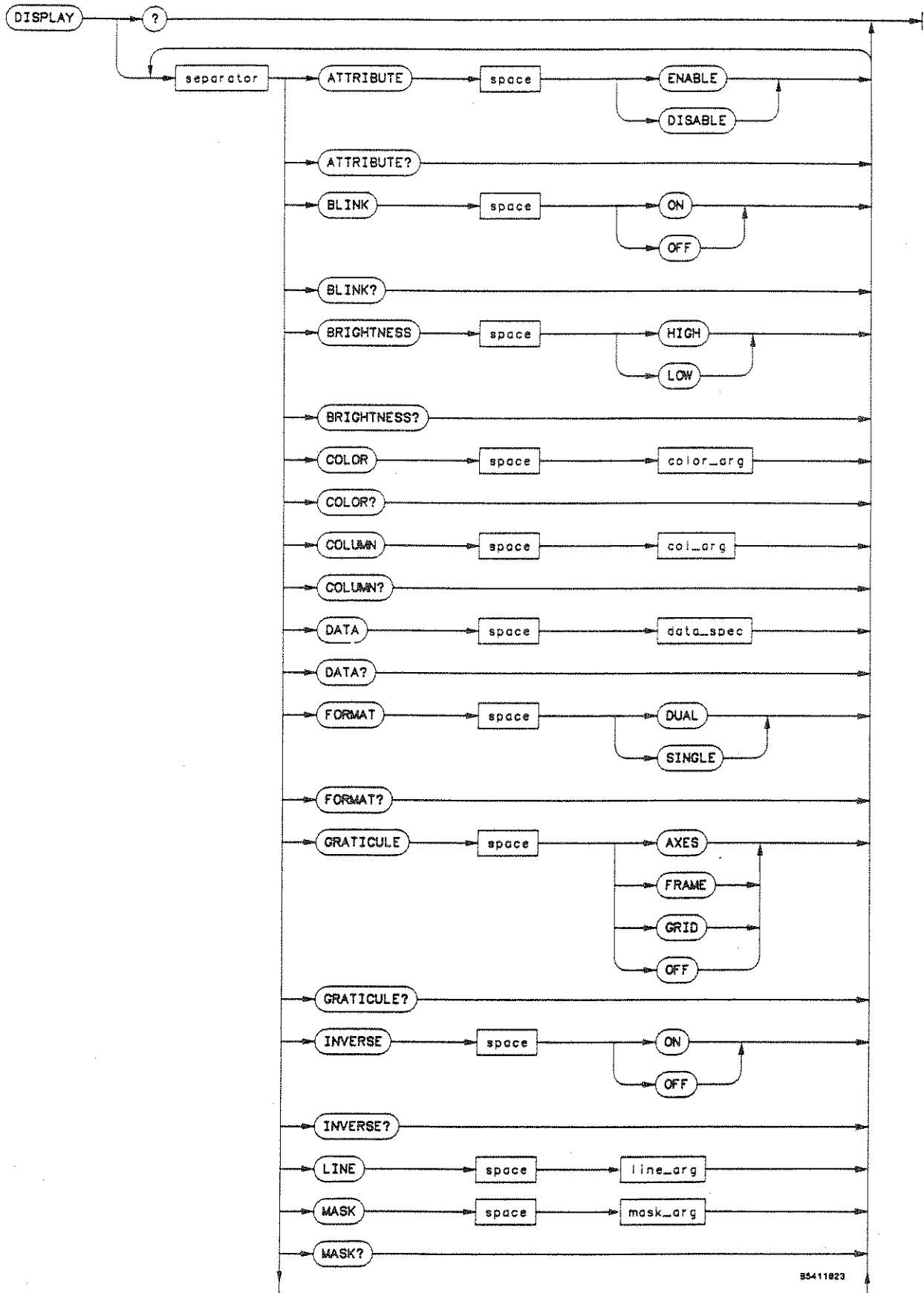
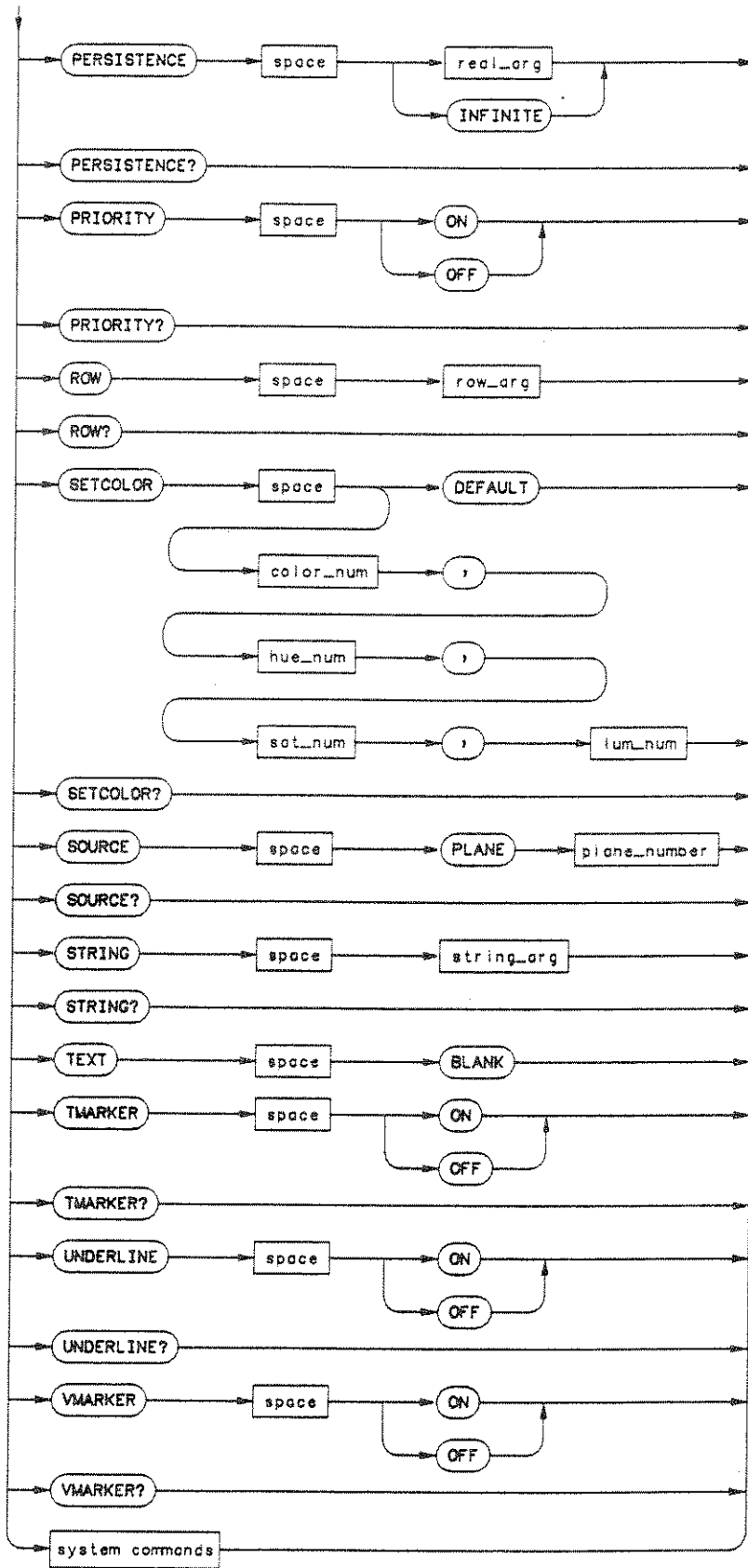

Figure 10-5. Display Subsystem Commands



B5411023

Figure 10-5. Display Subsystem Commands

DATA_SPEC = A block of data in EA format as defined in IEEE Std. 728-1982.

PLANE_NUMBER An integer from 0 to 6.

REAL_ARG = A real number from 0.2 to 10.0 in steps of 0.1.

COL_NUMBER = An integer from 0 to 71.

LINE_ARG = Any quoted string.

ROW_NUMBER = An integer from 0 to 22.

STRING_ARG = Any quoted String.

COLOR_NUMBER = An integer from 0 to 15.

HUE_NUM = An integer from 0 to 100.

SAT_NUM = An integer from 0 to 100.

LUM_NUM = An integer from 0 to 100.

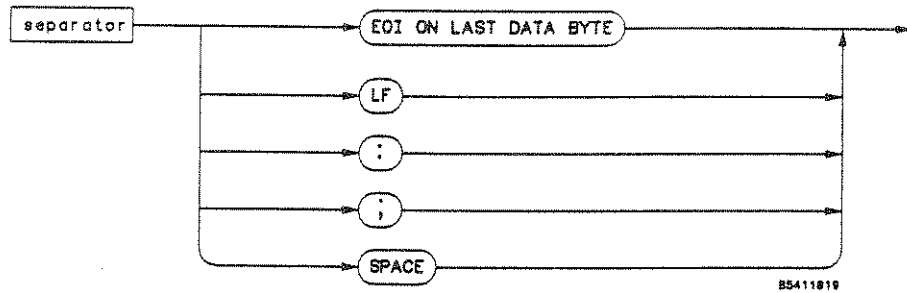

Figure 10-5. Display Subsystem Commands

10-12. DISPLAY SUBSYSTEM

The Display subsystem is used to control the display of data, markers, text, graticules and the use of color. See Figure 10-5 for the syntax of the Display subsystem commands. The commands which control the display mode and number of averages are listed in the ACQUIRE subsystem as TYPE and COUNT.

DISPly

command/query

This commands selects the display subsystem as the destination for the subsystem commands. The query returns all the parameters for this subsystem.

Command Syntax: DISPlay

Example: OUTPUT 707;"DISP"

Query Syntax: DISPlay?

Returned Format:

```
[ DISPlay ]<crLf>
[ FORMat ]{[ SINGLE | 1 ]
            [ DUAL | 2 ]}<crLf>
[ GRATicule ]{[ OFF | 0 ]
              [ GRID | 1 ]
              [ AXES | 2 ]
              [ FRAME | 3 ]}<crLf>
[ ROW ]<NR1><crLf>
[ COLUmN ]<NR1><crLf>
[ ATTRibute ]{[ DISABLE | 0 ]
              [ ENABLE | 1 ]}<crLf>
[ INVerse ]{[ OFF | 0 ]
            [ ON | 1 ]}<crLf>
[ BLINK ]{[ OFF | 0 ]
          [ ON | 1 ]}<crLf>
[ BRIGHtness ]{[ LOW | 0 ]
               [ HIGH | 1 ]}<crLf>
[ VMARker ]{[ OFF | 0 ]
            [ ON | 1 ]}<crLf>
[ TMARker ]{[ OFF | 0 ]
            [ ON | 1 ]}<crLf>
[ PERSistence ]<NR3><crLf>
[ COLor ]<NR1>
[ PRIority ]{[ OFF | 0 ]
             [ ON | 1 ]}
[ SETColor ] <NR1> <NR1> <NR1> <NR1>
```

Example:

```
10 DIM Display$[500]
20 OUTPUT 707;"EOI ON"
30 OUTPUT 707;"DISPLAY?"
40 ENTER 707 USING "-K";Display$
50 PRINT USING "K";Display$
```

ATTRIBUTE BYTE

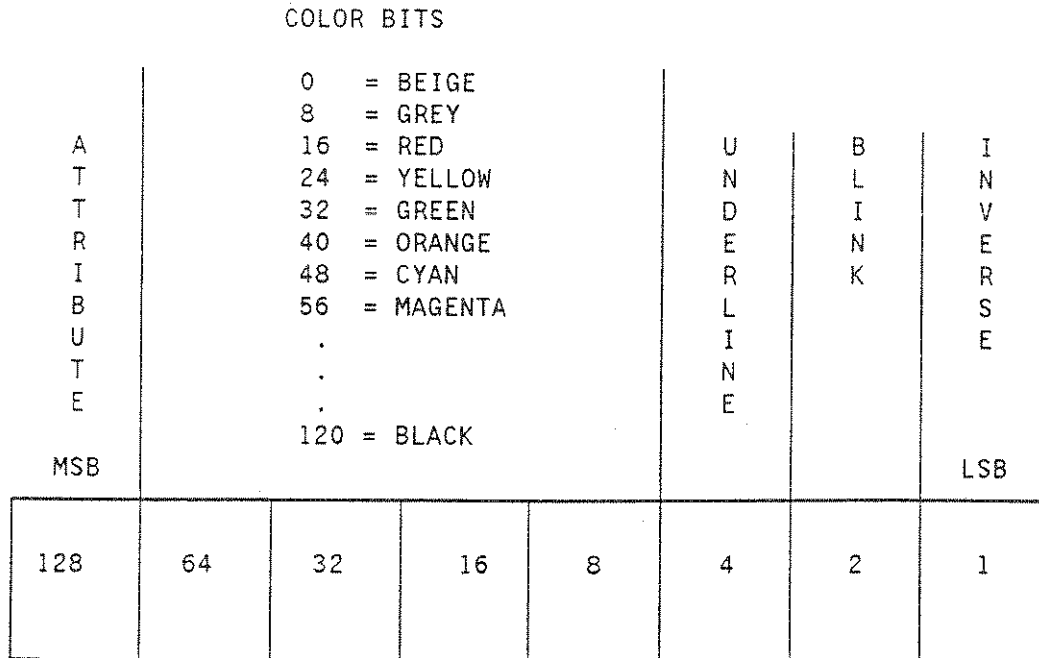

When you want to set the attribute byte you must sum the binary values of the byte and send them via the HP-IB to the instrument. These selected attributes can be turned off/on by disabling/enabling the ATTRIBUTE command. These attributes affect the text that is sent to the display of the instrument when you use the LINE or STRING commands. This example causes "HELLO" to be written in red in the upper left corner of the display using the inverse video and the blinking attributes.

```
OUTPUT 707;"DISPLAY TEXT BLANK ATTRIBUTE ENABLE"
OUTPUT 707 USING "8A,B,6A";"STRING """,128+16+2+1,"HELLO"""
```

Where 128 indicates that this is an attribute byte, 16 indicates the color red, 2 indicates the blink attribute, and 1 indicates the invert attribute. This could just as easily been output to the instrument as "147".

Figure 10-6. Attribute Byte

ATTRibute

command/query

This command controls embedded attributes in the strings that are sent with the DISPLAY, LINE or STRING commands. Refer to Figure 10-6 for more information. These text attributes include:

INVerse
UNDerline
BLINK
COLOR

When this command is enabled the embedded attribute bytes in strings sent with the LINE or STRING commands will be used to override previously set attributes. The query returns the enable/disable state of the command.

Command Syntax: ATTRibute {[DISABLE | 0] [ENABLE | 1]}

Example: OUTPUT 707;"ATTRIBUTE ENABLE"

Query Syntax: ATTRibute?

Returned format: [ATTRibute]<argument><crlf>

Example: OUTPUT 707;"ATTRIBUTE"
ENTER 707;Attribute\$
PRINT Attribute\$

BLINK

command/query

This command determines whether text sent with the DISPLAY, LINE or STRING commands is to be written with the BLINK attribute, that is, when the text is displayed it will flash on and off. The query returns the state of the BLINK attribute.

Command Syntax: BLINK {[OFF | 0]
[ON | 1]}

Example: OUTPUT 707;"BLINK ON"

Query Syntax: BLINK?

Returned Format: [BLINK]<argument><crlf>

Example: OUTPUT 707;"BLINK?"
ENTER 707;Blink\$
PRINT Blink\$

COLOR

command/query

This command specifies what color the text will be when sent with the DISPLAY, LINE, or STRING commands. The query returns the color of the COLOR attribute. Colors 10, 11, and 12 are used for the color printer output colors. Colors 8, 9, 13, and 14 are not defined by the instrument but are available over HP-IB for user defined text strings. The COLUMN uses the shortform COL. This command overrides a previous brightness command.

Command Syntax: COLOR {[0] (beige, highlighted text)
 [1] (grey, text fields & graticule)
 [2] (red, advisories & errors)
 [3] (yellow, channel 1 waveforms)
 [4] (green, channel 2 waveforms)
 [5] (orange, markers)
 [6] (cyan, stored waveforms)
 [7] (magenta, overlapped traces)
 [10] (purple, channel 1 for 3630A)
 [11] (white, background for 3630A)
 [12] (black, overlap for 3630A)
 [15] (black, background)

Example: OUTPUT 707;"COLOR 2"

Query Syntax: COLOR?

Returned Format: [COLOR] <argument> <crlf>

Example: OUTPUT 707;"COLOR?"
 ENTER 707;Color\$
 PRINT Color\$

BRIGHtness

command/query

This command specifies whether text sent with the DISPLAY, LINE or STRING commands are to be displayed in beige or grey. LOW or 0 provides gray text and HIGH or 1 provides beige text. The query returns the HIGH/LOW state of the BRIGHtness attribute. This command overrides a previous COLOR commands.

Command Syntax: BRIGHtness {[LOW | 0]
[HIGH | 1]}

Example: OUTPUT 707;"BRIGHTNESS LOW"

Query Syntax: BRIGHtness?

Returned Format: [BRIGHtness]<argument><crlf>

Example: OUTPUT 707;"BRIGHTNESS?"
ENTER 707;Brightness\$
PRINT Brightness\$

COLOR

command/query

This command specifies what color the text will be when sent with the DISPLAY, LINE or STRING commands. The query returns the color of the COLOR attribute. Colors 8-14 are not defined by the instrument but are available over HP-IB for user defined text strings. The COLUMN uses the shortform COL. This command overrides a previous brightness command.

Command Syntax: COLOR {[0] (beige, highlighted text)
[1] (grey, text fields & graticule)
[2] (red, advisories & errors)
[3] (yellow, channel 1 waveforms)
[4] (green, channel 2 waveforms)
[5] (orange, markers)
[6] (cyan, stored waveforms)
[7] (magenta, overlapped traces)
[15] (black, background)

Example: OUTPUT 707;"COLOR 2"

Query Syntax: COLOR?

Returned Format: [COLOR]<argument><crlf>

Example: OUTPUT 707;"COLOR?"
ENTER 707;Color\$
PRINT Color\$

COLumn

command/query

This command specifies the starting column for subsequent STRING and LINE commands. The query returns the column where the next LINE or STRING will start.

Command Syntax: COLumn <COL_NUMBER>
 <COL_NUMBER> ::= 0..71

Example: OUTPUT 707;"COLUMN 50"

Query Syntax: COLumn?

Returned Format: [COLumn]<NR1><crlf>

Example: OUTPUT 707;"COLUMN?"
 ENTER 707;CoLumn\$
 PRINT CoLumn\$

DATA

command/query

The DATA command is used to write to or from one of the seven pixel memory planes in the 54110D. The memory planes available are plane0 through plane6 and are specified by the DISPLAY SOURce command.

The DATA query causes the 54110D to output waveform data from the specified memory plane. If plane 0 is specified the 54110D will transfer the logical or of the channel 1 and channel 2 planes. In all other cases the specified plane will be transferred.

The DATA command is followed by a block of binary data that is transferred from the controller to a specific plane in the 54110D. If plane 0 is specified, that data will be transferred into the channel 1 plane. In all other cases the data will be transferred into the specified plane.

The data is in the form of 16032 bytes with four header bytes. The header contains:

```

<#> ::= (decimal 35) = byte 1
<A> ::= (decimal 65) = byte 2
       (decimal 62) = byte 3
       (decimal 160) = byte 4
    
```

The third and fourth bytes make up a 16-bit integer whose value is decimal 16032, or the length of the binary block. This binary format complies with the "#A" Block Data Field in IEEE 728-1982.

(Data continued on next page)

DATA (cont'd)

command/query

Command Syntax: DATA <binary block type A>

Query Syntax: DATA?

Returned Format: [DATA]<2sp><#><A><decimal 62><decimal 160>
<binary waveform data>

```
Example: 10 CLEAR 707
          20 DIM Plane$ [17000]
          30 OUTPUT 707;"HEADER ON EOI ON"
          40 OUTPUT 707;"DISPLAY SOURCE PLANE0 DATA?"
          50 ENTER 707 USING "-K";Plane$
          60 OUTPUT 707;"SOURCE PLANE1"
          70 OUTPUT 707 USING "-K";Plane$
          80 END
```

This example transfers data from the active display memory to the controller and then back to pixel memory 5 in the 54110D.

FORMat

command/query

This command allows you to turn the split screen mode on or off. FORMat 1 turns the split screen mode off and uses 8 divisions for the full scale range. FORMat 2 turns the split screen mode on and uses 4 divisions for the full scale range. The query returns the current number of display areas on the screen.

Command Syntax: FORMat { [SINGLE | 1]
[DUAL | 2] }

Example: OUTPUT 707;"FORMat SINGLE"

Query Syntax: FORMat?

Returned Format: [FORMat]<argument><crlf>

```
Example: OUTPUT 707;"FORMat?"
          ENTER 707;Format$
          PRINT Format$
```

GRATicule

command/query

This command allows you to determine the type of graticule that is displayed. The query returns the type of graticule displayed.

Command Syntax: GRATicule {[OFF | 0]
[GRID | 1]
[AXES | 2]
[FRAME | 3]}

Example: OUTPUT 707;"GRATICULE AXES"

Query Syntax: GRATicule?

Returned Format: [GRATicule]<argument><crlf>

Example: OUTPUT 707;"GRATICULE?"
ENTER 707;Grat\$
PRINT Grat\$

INVerse

command/query

This command sets inverse video on or off for subsequent DISPLAY, LINE or STRING commands. The query responds with the on/off state of this command.

Command Syntax: INVerse {[OFF | 0]
[ON | 1]}

Example: OUTPUT 707;"INVERSE OFF"

Query Syntax: INVerse?

Returned format: [INVerse]<argument><crlf>

Example: OUTPUT 707;"INVERSE?"
ENTER 707;Inv\$
PRINT Inv\$

LINE

command/query

This command causes the string parameter to be written to the screen, starting at the location established by the ROW and COLUMN commands. Text may be written up to column 62. If the characters in the string parameter does not fill the line, the rest of the line is blanked. If the string is longer than the available space on the current line the excess characters will be discarded. In any case, ROW is incremented and COLUMN remains the same. The next LINE command will write on the next line of the display. After writing line 21, the last line in the display area, ROW is reset to 2. The query of this command outputs the quoted string at the current ROW and COLUMN values and causes ROW to be incremented by 1. The LINE command and query works on rows 2 through 21.

Command Syntax: LINE < any quoted string >

Example: OUTPUT 707:"LINE ""ENTER PROBE ATTENUATION"""

Query Syntax: LINE?

Returned Format: [LINE?] < quoted string ><crlf>

Example: DIM Line\$[100]

Example: OUTPUT 707;"DISPLAY;ROW 12;COLUMN 14;LINE?"
ENTER 707;Line\$
PRINT Line\$

MASK

command/query

This command inhibits the instrument from writing to selected areas of the screen. Text sent over the HP-IB using the line and string commands is not effected by this command. The purpose of the command is to allow HP-IB text to be written anywhere on screen and to prevent the instrument from overwriting the text through its normal operation.

The mask parameter is an 8 bit integer in which each bit controls writing to an area of the screen. A 0 inhibits writing to the area represented by the bit, and a 1 enables writing to the area. Note: This command's parameters will not be reset with a RESET command.

Command Syntax: MASK <NR1>

Example: OUTPUT 707;"MASK 254" ! Inhibits advisories only

Query Syntax: MASK?

Returned Format: [MASK]<NR1><crlf>

Example: OUTPUT 707;"MASK?"
 ENTER 707;Mask\$
 PRINT Mask\$

Bit	Mask Weight	Screen Area Effected
7	128	Function Key Underlines - lines below the function softkeys. The underlines are turned on and off by the mask command.
6	64	Function Softkeys - Softkey labels on the right side of the display (rows 0-17, columns 62-71).
5	32	Menu Selection Softkeys - text on the bottom line of the display (row 22, columns 0-71).
4	16	Parameter Values - Text below the graticule (rows 18-21, columns 0-71)
3	8	Graticule Labels - text inside the graticule (rows 2-17, columns 0-61)
2	4	Value Label - displays value of selected knob function (row 1, columns 19-61).
1	2	Status Line - status information on the first two lines - (row 0, columns 0-71 and row 1, columns 0-18).
0	1	Advisory - Advisory and Error messages appear on row 15, columns 0-61.

PERSistence

command/query

This command sets PERSistence for the acquired signal on the display in the Normal display mode. The display mode is set to Normal when the ACQUIRE TYPE is NORMAL, ENVELOPE, or RANDOM. The parameter for this command is the keyword INFINITE or a real number from 0.2 to 10.0 representing the persistence in seconds. Any value greater than 10 seconds will set the PERSistence to infinite. The query returns the value of the current persistence value. If persistence is set to infinite the query response will be 1.1E+1

Command Syntax: PERSistence { NR2 | INFINITE }

Example: OUTPUT 707;"PERSISTENCE INFINITE"

Query Syntax: PERSistence?

Response Format: [PERSistence]<NR3><crlf>

Example: DIM Pers\$[30]
OUTPUT 707;"PERSISTENCE?"
ENTER 707;Pers\$
PRINT Pers\$

PRIority

command/query

This command sets the priority on or off for subsequent DISPLAY, LINE, STRING commands. It allows you to determine whether text or graphics will be overwritten by the other on the CRT. When PRIority is ON text overwrites the displayed signal(s). When PRIority is OFF the displayed signal(s) overwrites any text in the display area.

Command Syntax: PRIority { [OFF | 0]
[ON | 1] }

Example: OUTPUT 707;"PRIORITY OFF"

Query Syntax: PRIority?

Returned Format: [PRIority]<argument><crlf>

Example: OUTPUT 707;"PRIORITY?"
ENTER 707;Pri\$
PRINT Pri\$

ROW

command/query

The ROW command specifies the starting row on the CRT for subsequent STRING and LINE commands. The ROW number remains constant until another ROW command is received or it is incremented by the LINE command. The single parameter for this command is an integer from 0 to 22. The query returns the row that the next LINE or STRING will start on.

Command Syntax: ROW <row number>

<row number> ::= 0..22

Example: OUTPUT 707;"ROW 10"

Query Syntax: ROW?

Returned Format: [ROW]<NR1><crlf>

Example: OUTPUT 707;"ROW?"
ENTER 707;Row\$
PRINT Row\$

SETColor

command/query

This command allows you to change one of the color selections on the CRT. This command has four parameters: Color Number, Hue, Saturation, and Luminosity.

The hue portion of this command allows you to determine the gradation of color. Hue can have a value of 0 to 100. As the hue number is increased, the selected color will cycle through the color spectrum. There is no difference between hue 0 and hue 100.

The saturation portion of this command allows you to choose the percentage of the pure color that gets mixed with white. The acceptable values for saturation are 0 to 100 where 0 is white and 100 is maximum saturation of the chosen hue.

The luminosity portion of this command determines the brightness of the chosen hue. The acceptable values for luminosity are 0 to 100 where 0 is black and 100 is maximum brightness. The SETColor command followed by DEFault sets all colors to the default settings. The query of this command returns the specified color number, hue, saturation, and luminosity. Refer to section 6 of this manual for more information concerning color.

Note: This command's parameters will not be reset with a RESET command.

Command Syntax: SETColor{[<COLOR_NUM>,<HUE_NUM>,<SAT_NUM>,<LUM_NUM>
[DEFault]}

COLOR_NUM ::= integer from 0 to 15

HUE_NUM ::= integer from 0 to 100

SAT_NUM ::= integer from 0 to 100

LUM_NUM ::= integer from 0 to 100

Example: OUTPUT 707;"SETColor 0,0,100,50"

Query Syntax: SETColor<color number>?

Returned Format: [SETColor] <NR1><,><NR1><,><NR1><,><NR1><crlf>

Example: DIM Set\$[35]
OUTPUT 707;"SETCOLOR 2?"
ENTER 707;Set\$
PRINT Set\$

SOURCE | SRC

command/query

This command allows you to specify the source or destination for the DISPLAY DATA query and command. The SOURCE command has 1 parameter, PLANE0..PLANE6. The query returns the currently specified SOURCE.

Command Syntax: { SOURCE | SRC }

[PLANE0		0]	(active display)
[PLANE1		1]	(pixel memory 5)
[PLANE2		2]	(pixel memory 6)
[PLANE3		3]	(graticule, markers)
[PLANE4		4]	(displayed stored waveforms, markers)
[PLANE5		5]	(channel 1)
[PLANE6		6]	(channel 2)

```
Example: 10 CLEAR 707
          20 DIM Plane$ [17000]
          30 OUTPUT 707;"HEADER ON EOI ON"
          40 OUTPUT 707;"DISPLAY SOURCE PLANE0 DATA?"
          50 ENTER 707 USING "-K";Plane$
          60 OUTPUT 707;"SOURCE PLANE1"
          70 OUTPUT 707 USING "K";Plane$
          80 END
```

This example transfers data from the active display memory to the controller and then back to pixel memory 5 in the 54110D.

Query Syntax: { SOURCE | SRC }?

Returned Format: [SOURCE]<argument><crlf>

```
Example: OUTPUT 707;"SRC?"
          ENTER 707;Src$
          PRINT Src$
```

STRing

command/query

This command allows you to write text to the CRT of the 54110D. The text will be written starting at the current ROW and COLUMN values. If the column limit is reached (71) the excess text is discarded. The query returns the text on the line defined by the ROW and COLUMN values.

Command Syntax: STRing <quoted string>

Example: OUTPUT 707;"STRING ""INPUT SIGNAL TO CHANNEL 2"""

Query Syntax: STRing?

Example: DIM Str\$[90]
OUTPUT 707;"STRING?"
ENTER 707;Str\$
PRINT Str\$

TEXT

command

This command allows you to blank the user text area on the CRT. The user text area includes rows 2 through 17, columns 0 through 62, and rows 18 through 21, columns 0 through 71. This command has only one parameter, BLANK or 2.

Command Syntax: TEXT { BLANK | 2 }

OUTPUT 707;"TEXT 2"

TMARKer

command/query

This command allows you to turn the time markers on or off. The query tells you whether they are on or off.

Command Syntax: TMARKer{ [OFF | 0]
[ON | 1] }

Example: OUTPUT 707;"TMAR OFF"

Query Syntax: TMARKer?

Returned Format: [TMARKer]<argument><crlf>

Example: OUTPUT 707;"TMARKER?"
ENTER 707;Tmar\$
PRINT Tmar\$

UNDERline

command/query

This command lets you underline subsequent text sent with the DISPLAY, LINE or STRING commands. The query tells you whether the UNDERline attribute is on or off.

Command Syntax: UNDERline ([OFF | 0]
[ON | 1])

Example: OUTPUT 707;"UNDERLINE ON"

Query Syntax: UNDERline?

Returned Format: [UNDERline]<argument><crlf>

Example: OUTPUT 707;"UNDERLINE?"
ENTER 707;Under\$
PRINT Under\$

VMARKer

command/query

This command allows you to turn the voltage markers on and off. The query tells you whether they are on or off.

Command Syntax: VMARKer ([OFF | 0]
[ON | 1])

Example: OUTPUT 707;"VMARKER ON"

Query Syntax: VMARKer?

Returned Format: [VMARKer]<argument><crlf>

Example: OUTPUT 707;"VMARKER?"
ENTER 707;Vmark\$
PRINT Vmark\$

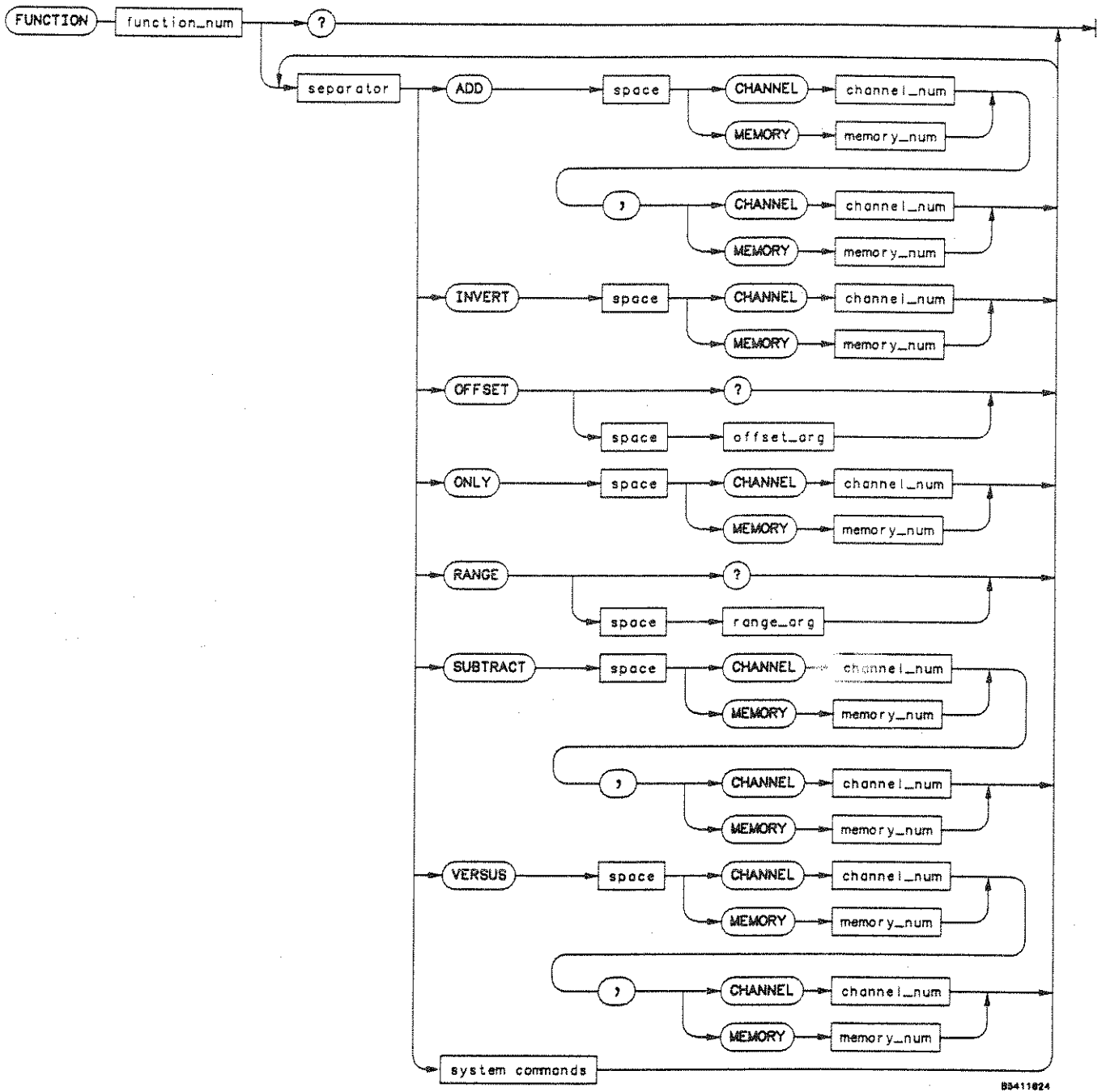

B3411024

Figure 10-7. Function Subsystem Commands

10-13. FUNCTION SUBSYSTEM

The Function subsystem allows you to define two functions using the displayed channels and/or the waveform memories as operands. The waveform operators are: ADDition, SUBTraction, INVErt, VErSus, and ONLY. The vertical scaling and offset and the display of these functions can be controlled remotely. See Figure 10-7 for a syntax diagram of the function subsystem commands.

When a function is first defined, its initial vertical values are calculated with respect to the operands' vertical settings. The functions' range and offset may be changed using the range and offset commands. Changing any of the operands' vertical settings or redefining of the function will cause the the functions' vertical settings to be recalculated with respect to the new operand values. Any previously programmed vertical settings for the function will be lost.

The functions work on operands containing 500 points. If a function is defined and turned on, a memory which contains other than 500 points, the memory will be reformatted to 500 points. Also, memory operands that are in the RANDOM type will be reformatted to the NORMAL type with the number of points equal to 500.

FUNCTION

command/query

This command allows you to select the Function subsystem and define a waveform function. This command selects the function subsystem as the destination for the commands that follow. The query returns the definition of the selected function. Refer to Figure 10-7 for a syntax diagram of the Function subsystem commands.

Command Syntax: FUNCTION{ 1 | 2 }

Example: OUTPUT 707;"FUNCTION1 ADD CHANNEL1 CHANNEL2

Query Syntax: [FUNCTION]{ 1 | 2 }?

Returned Format: [FUNCTION]{ 1 | 2 }<crlf>
 {ADD | INVErt| ONLY | SUBTract | VErSus}
 {[CHANnel 1 | 2] | [MEMory 1 | 2 | 3 | 4]}<,>
 [{[CHANnel 1 | 2] | [MEMory 1 | 2 | 3 | 4]}]<crlf>
 [OFFSet]<NR3><crlf>
 [RANGe]<NR3><crlf>

Example: DIM Fun\$[300]
 OUTPUT 707;"EOI ON"
 OUTPUT 707;"FUNCTION1?"
 ENTER 707 USING "-K";Fun\$
 PRINT USING "K";Fun\$

ADD

command

The ADD command causes the unit to algebraically sum the two defined operands.

Command Syntax: ADD<operand1><,><operand2>

operand 1 & 2 ::= {channel 1 | channel 2 | memory 1 |
memory 2 | memory 3 | memory 4}

Example: OUTPUT 707;"FUNCTION1 ADD MEMORY3,MEMORY4"

INVERT

command

This command allows you to invert the operand, that is channel 1 | 2, or memory 1 | 2 | 3 | 4. Note that the shortform of the command is INVE. The INVERSE command in the display subsystem uses the short form INV.

Command Syntax: INVERT<operand>

Example: OUTPUT 707;"FUNCTION2 INVERT MEMORY3"

OFFSet

command/query

The OFFSet command allows you to define the vertical voltage at center screen for the selected function. The query returns the voltage at center screen for the defined function.

Command Syntax: OFFSet<Offset_Arg>

Example: OUTPUT 707;"FUNCTION1 OFFSET .05"

Query Syntax: OFFSet?

Returned Format: [OFFSet]<NR3>

Example: DIM Off\$[30]
OUTPUT 707;"FUNCTION2 OFFSET?"
ENTER 707;Off\$
PRINT Off\$

1
2
3
4
5
6
7
8
9
10
11
12
13
14
15
16
17
18
19
20
21
22
23
24
25

ONLY

command

The ONLY command allows you to define a function as either channel 1 or 2, or memory 1, 2, 3, or 4. The ONLY command is useful for scaling channels and memories.

Command Syntax: ONLY<operand>

Example: OUTPUT 707;"FUNCTION1 ONLY MEMORY1"

RANGe

command/query

This command allows you to define the full scale vertical axis of a function's display.

Command Syntax: RANGe<Range_Arg>

Example: OUTPUT 707;"FUNCTION1 RANGE .01"

Query Syntax: RANGe?

Returned Format: [RANGe]<NR3>

Example: DIM Range\${30}
OUTPUT 707;"RANGE?"
ENTER 707;Range\$
PRINT Range\$

SUBTract

command

This command allows you to algebraically subtract one operand from another. Operand2 is subtracted from operand1.

Command Syntax: SUBTract <operand1><,><operand2>

operand1 & 2 ::= {channel1 | channel2 | memory1 |
memory2 | memory3 | memory4}

Example: OUTPUT 707;"FUNCTION2 SUBTRACT CHANNEL1,CHANNEL2"

(In this example channel 2 would be algebraically subtracted from channel 1.)

VERSus**command**

This command allows X vs Y displays with two operands. The first operand defines the Y axis and the second defines the X axis. The Y axis range and offset is initially equal to the first operand's and can be adjusted using the range and offset commands in this subsystem. The X axis range and offset is always equal to that of the second operand. It can only be changed by changing the vertical settings of the second operand. This will also change the Y axis vertical sensitivity and offset.

Command Syntax: VERSus<operand1><,><operand2>

operand1 & 2 ::= {channel 1 | channel 2 | memory 1 |
memory 2 | memory 3 | memory 4}

Example: OUTPUT 707;"FUNCTION2 VERSUS CHANNEL1,MEMORY3"

NOTES:

NOTES:

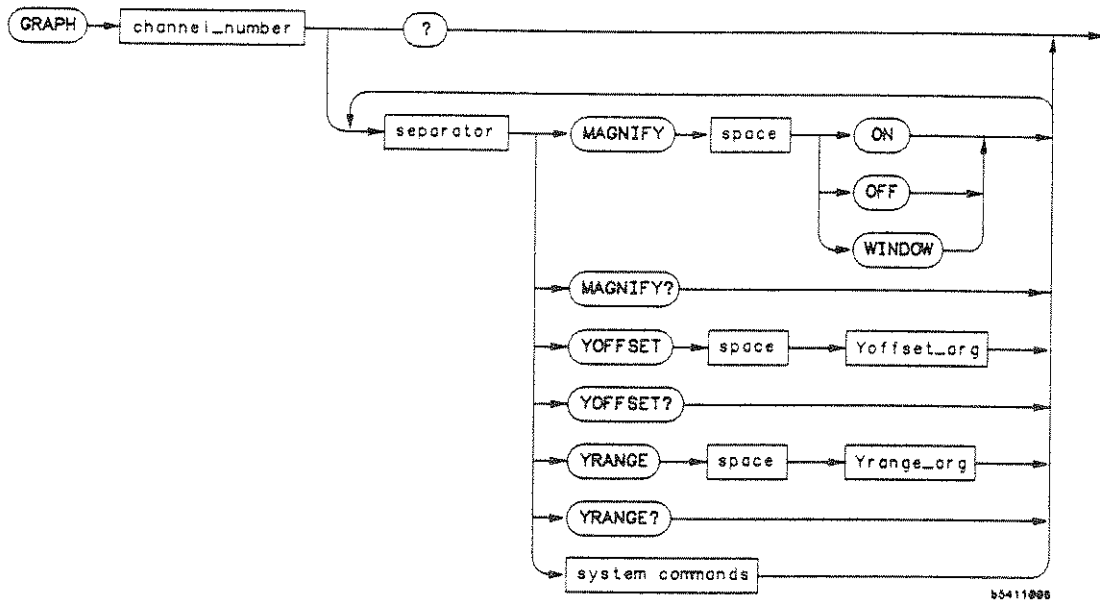

YOFFSET_ARG = A real number less than or equal to the vertical range.

YRANGE_ARG = A real number between 1/16(vertical range) and the vertical range.

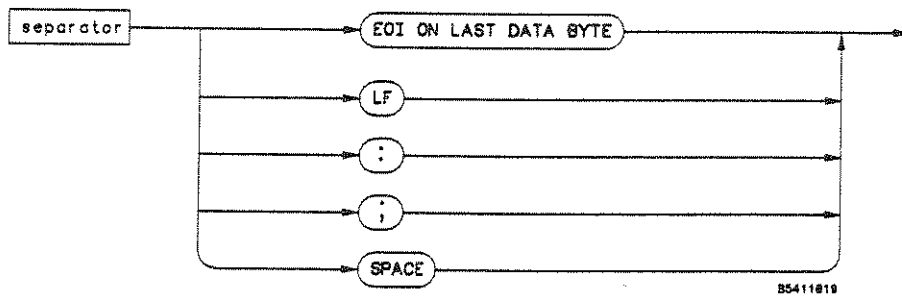

Figure 10-8. Graph Subsystem Commands

10-14. GRAPH SUBSYSTEM

The Graph subsystem allows you to control y-axis windowing, offset and the magnification for the two channels. See Figure 10-8 for a syntax diagram of the GRAPh subsystem commands.

GRAPH

command/query

This command allows you select the graph subsystem and specify which input channel will be the destination for the graph subsystem commands that follow. The query responds with all the parameters in the subsystem.

Command Syntax: GRAPH { 1 | 2 }

Example: OUTPUT 707;"GRAPH1"

Query Syntax: GRAPH { 1 | 2 }?

Returned Format: [GRAPH]<NR1><crlf>
[MAGNify]<argument><crlf>
[YOFFset]<NR3><crlf>
[YRANge]<NR3><crlf>

Example: DIM Graph\$[100]
OUTPUT 707;"EOI ON"
OUTPUT 707;"GRAPH1?"
ENTER 707 USING "-K";Graph\$
PRINT USING "-K";Graph\$

MAGNify

command/query

This command controls the MAGNify function for a specific channel. This command has one parameter: OFF, ON, or WINDOW. Off specifies that the channel will be displayed on the CRT in the unmagnified form. On specifies that the channel will be displayed in the magnified form. Window specifies that the channel will be displayed in the unmagnified form with the magnifier window displayed. The window is only displayed when the menu for the specified channel is on.

Command Syntax: MAGNify ([OFF | 0] [ON | 1] [WINDOW | 2])

Example: OUTPUT 707;"MAGNIFY OFF"

Query Syntax: MAGNify?

Returned Format: [MAGNify]<argument><crlf>

Example: OUTPUT 707;"MAGNIFY?"
ENTER 707;Mag\$
PRINT Mag\$

YOffset

command/query

This command allows you to control the voltage at the center of the magnify window. This voltage must be within the vertical range that is setup with the CHANNELn RANGE and OFFSET commands. The query returns the current value of YOffset.

Command Syntax: YOffset { NR1 | NR2 | NR3 }

Example: OUTPUT 707;"YOFFSET 1E-3"

Query Syntax: YOffset?

Returned Format: [YOffset]<NR3><crlf>

Example: OUTPUT 707;"YOFFSET?"
ENTER 707;Y\$
PRINT Y\$

YRANge

command/query

This command allows you to control the size (in volts) of the magnify window. The combination of this command and the YOffset command must define a window that is completely enclosed by the vertical range that is setup with the CHANNELn RANGE and OFFSET commands. The query returns the current value of YRANge.

Command Syntax: YRANge { NR1 | NR2 | NR3 }

Example: OUTPUT 707;"YRANGE .01"

Query Syntax: YRANge?

Returned Format: [YRANge]<NR3><crlf>

Example: OUTPUT 707;"YRANGE?"
ENTER 707;Yr\$
PRINT Yr\$

Model 54110D - Graph Subsystem

NOTES:

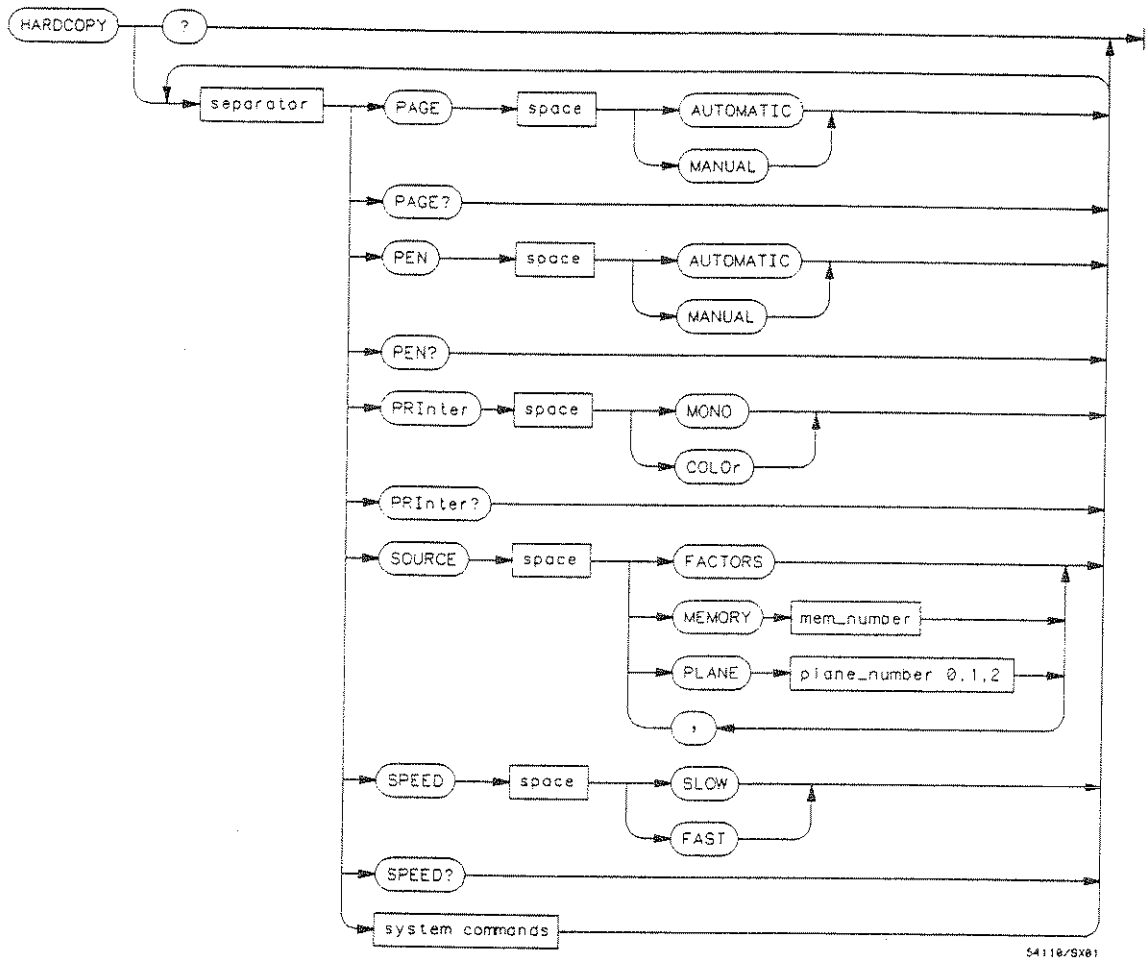

54110/SX01

MEM_NUMBER = A integer from 11 to 14.

PLANE_NUMBER = An integer from 0 to 2.

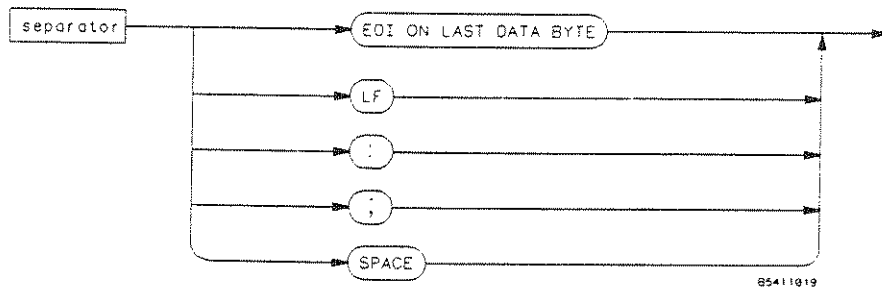

85411019

Figure 10-9. Hardcopy Subsystem commands

PRINter

command/query

The PRINter command selects the black and white printer or the color printer.

Except for the three exceptions shown in the table below, the PaintJet color assignments correspond to those on the display and the color menu of the oscilloscope. These exceptions are necessary for better viewability of printed data. This means that changing color settings in the oscilloscope color menu will change colors on the display and the PaintJet. The assignments are shown below.

The PRINter query returns the current printer selection.

Display	Display Color No.	PaintJet Output
Background Overlap Channel 1	15 (Black) 7 (Magenta) 3 (Yellow)	11 (White) 12 (Black) 10 (Purple)

The RESET command does not alter the state of the printer parameter, however, a keydown power up will set the printer selection to MONO.

The printer selection is not saved into the HP 54110D Learn String.

Command Syntax: PRINter {MONO | COLOr}

Example: OUTPUT 707;"PRINter MONO"

Query Syntax: PRINter?

Returned Format: [PRINter] {MONO | COLOr} <crlf>

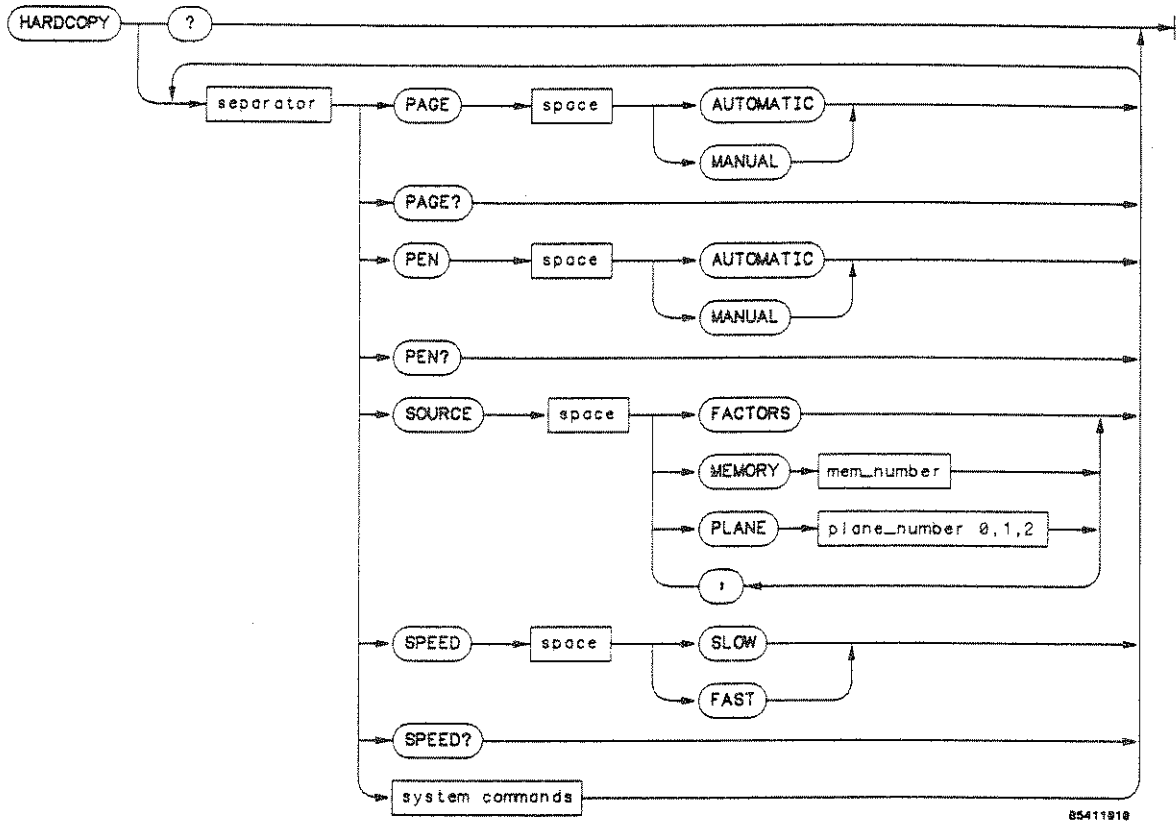

MEM_NUMBER = An integer from 11 to 14.
 PLANE_NUMBER = An integer from 0 to 2.

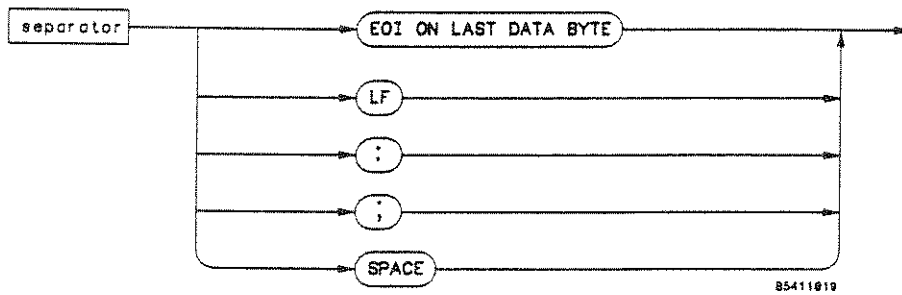

Figure 10-9. Hardcopy Subsystem commands

10-15. HARDCOPY SUBSYSTEM

The commands in the HARDCopy subsystem allow you to set various parameters used during the plotting and printing waveforms from the 54110D. Refer to Figure 10-9 for the syntax diagram of the HARDCopy subsystem commands.

HARDCopy

command/query

The HARDCopy command selects the hardcopy subsystem as the destination for the commands that follow.

Command Syntax: HARDCopy

Example: OUTPUT 707;"HARDCOPY"

Query Syntax: HARDCopy?

Returned Format: [HARDCopy]<crlf>
[PAGE]<argument><crlf>
[PEN]<argument><crlf>
[SPEEd]<argument><crlf>

Example: DIM Hard\$[100]
OUTPUT 707;"EOI ON"
OUTPUT 707;"HARDCOPY?"
ENTER 707 USING "-K";Hard\$
PRINT USING "-K";Hard\$"

PAGE

command/query

The page command allows you to send a form feed after a hardcopy dump to a printer. During a hardcopy dump the 54110D ignores page boundaries. The query returns the current state of the page command parameter.

Command Syntax: PAGE ([MANua1 | 0]
[AUTOMatic | 1])

Example: OUTPUT 707;"PAGE AUTO"

Query Syntax: PAGE?

Returned Format: [PAGE]<argument><crlf>

Example: OUTPUT 707;"PAGE?"
ENTER 707;Page\$
PRINT Page\$

PEN

command/query

The PEN command allows you to set the 54110D's pen control function. When this command is set to AUTOMATIC the unit assigns the following pen numbers to these functions:

Pen #	Usage
1	Graticule and timebase factors
2	Channel 1 and associated factors
3	Waveform memories and associated factors
4	Channel 2 and associated factors
5	Markers and delta measurement results
6	Pixel memories

When the command is put in the MANUAL mode the plotter will not be instructed to select a pen when a plot is requested, at the completion of the plot an instruction will be sent to cause the plotter to put away the pen. The query returns the state of the pen control parameter.

Command Syntax: PEN {[MANUAL | 0]
[AUTOMATIC | 1]}

Example: OUTPUT 707;"PEN AUTOMATIC"

Query Syntax: PEN?

Returned Format: [PEN]<argument><crLf>

Example: OUTPUT 707;"PEN?"
ENTER 707;Pen\$
PRINT Pen\$

SOURCE | SRC

command

The SOURCE command specifies the source(s) to be output during a hardcopy dump. Commas should be used when specifying multiple sources.

Command Syntax: { SOURCE | SRC }
 {[PLANE0 | 0] (active display)
 [PLANE1 | 1] (pixel memory 5)
 [PLANE2 | 2] (pixel memory 6)
 [FACTORS | 4] (scale factors)
 [MEMORY1 | 11] (waveform memory 1)
 [MEMORY2 | 12] (waveform memory 2)
 [MEMORY3 | 13] (waveform memory 3)
 [MEMORY4 | 14] (waveform memory 4)

Example: OUTPUT 707;"SOURCE PLANE2, MEMORY1"

SPEEd

command/query

The SPEEd command allows you to specify the pen speed to be used during plotting. FAST is intended for use on normal paper and SLOW should be used when plotting transparencies. The query returns the current pen speed.

Command Syntax: SPEEd { [SLOW | 0]
[FAST | 1] }

Example: OUTPUT 707;"SPEED FAST"

Query Syntax: SPEEd?

Returned Format: [SPEEd]<argument><crlf>

Example: OUTPUT 707;"SPEED?"
ENTER 707;Speed\$
PRINT Speed\$

NOTES:

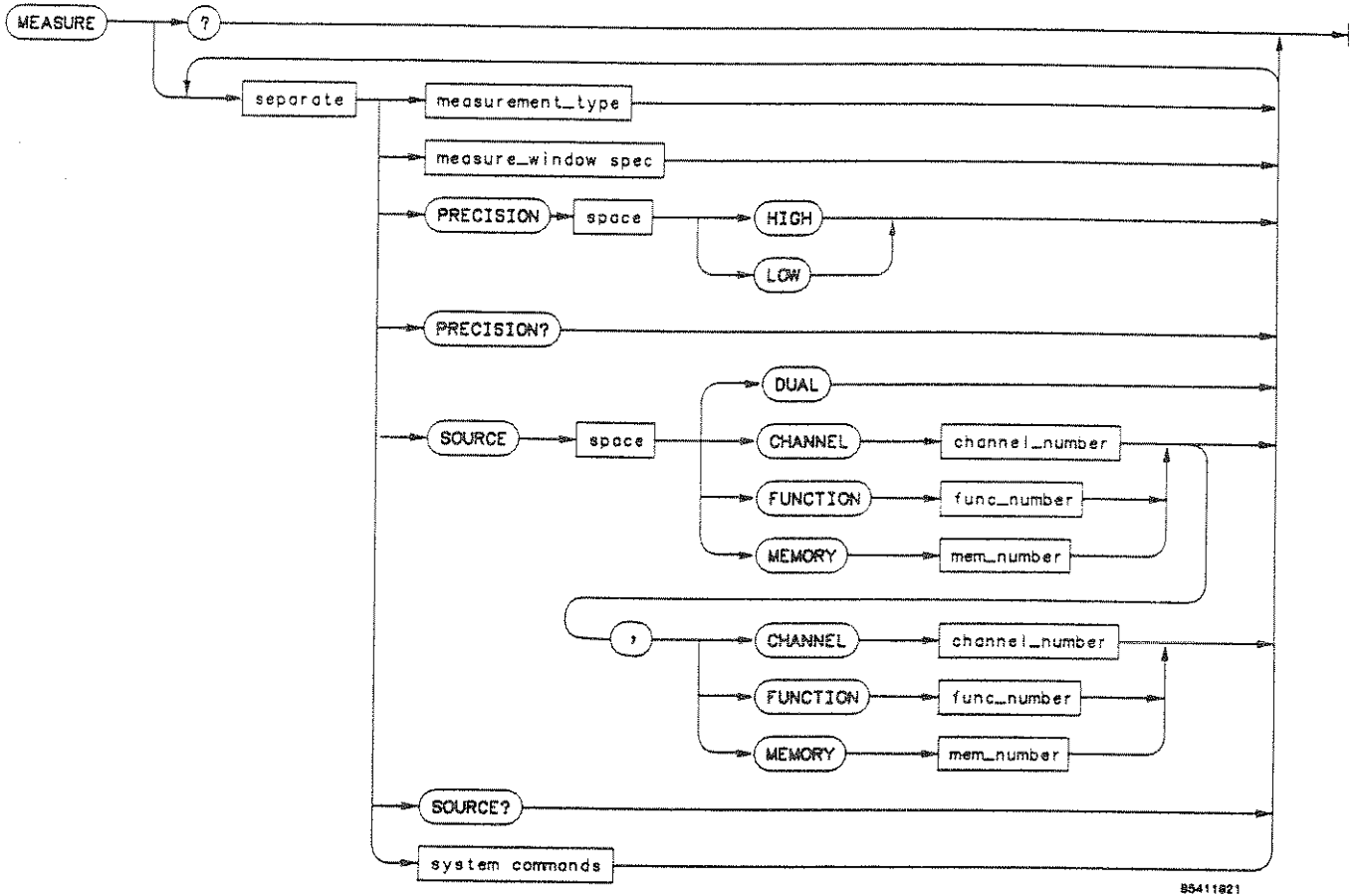

B5411821

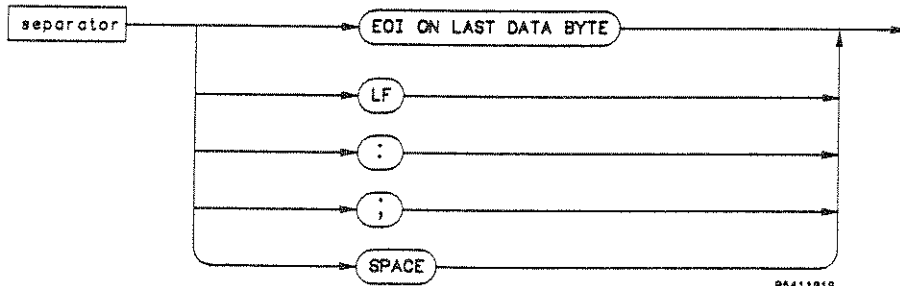

B5411919

Figure 10-10. Measure Subsystem Commands

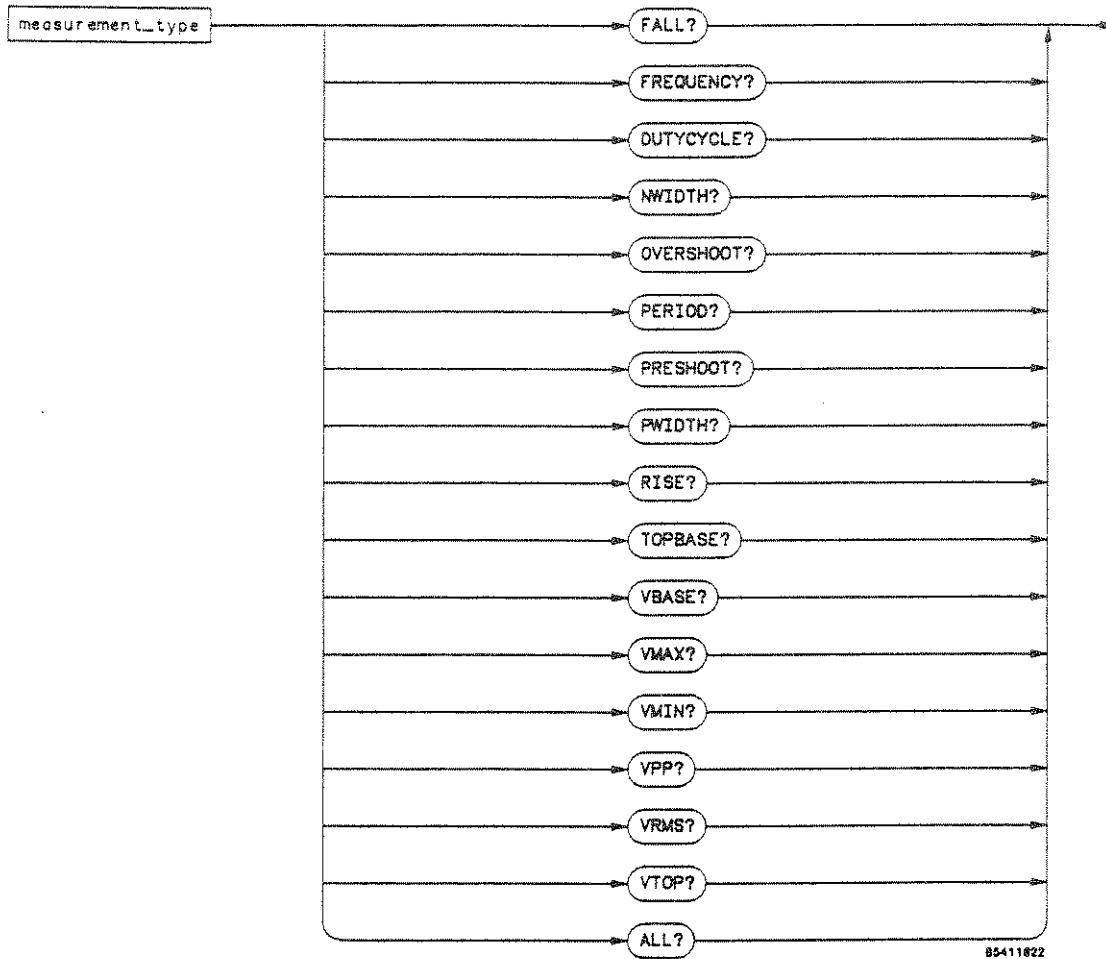

Figure 10-10. Measure Subsystem Commands

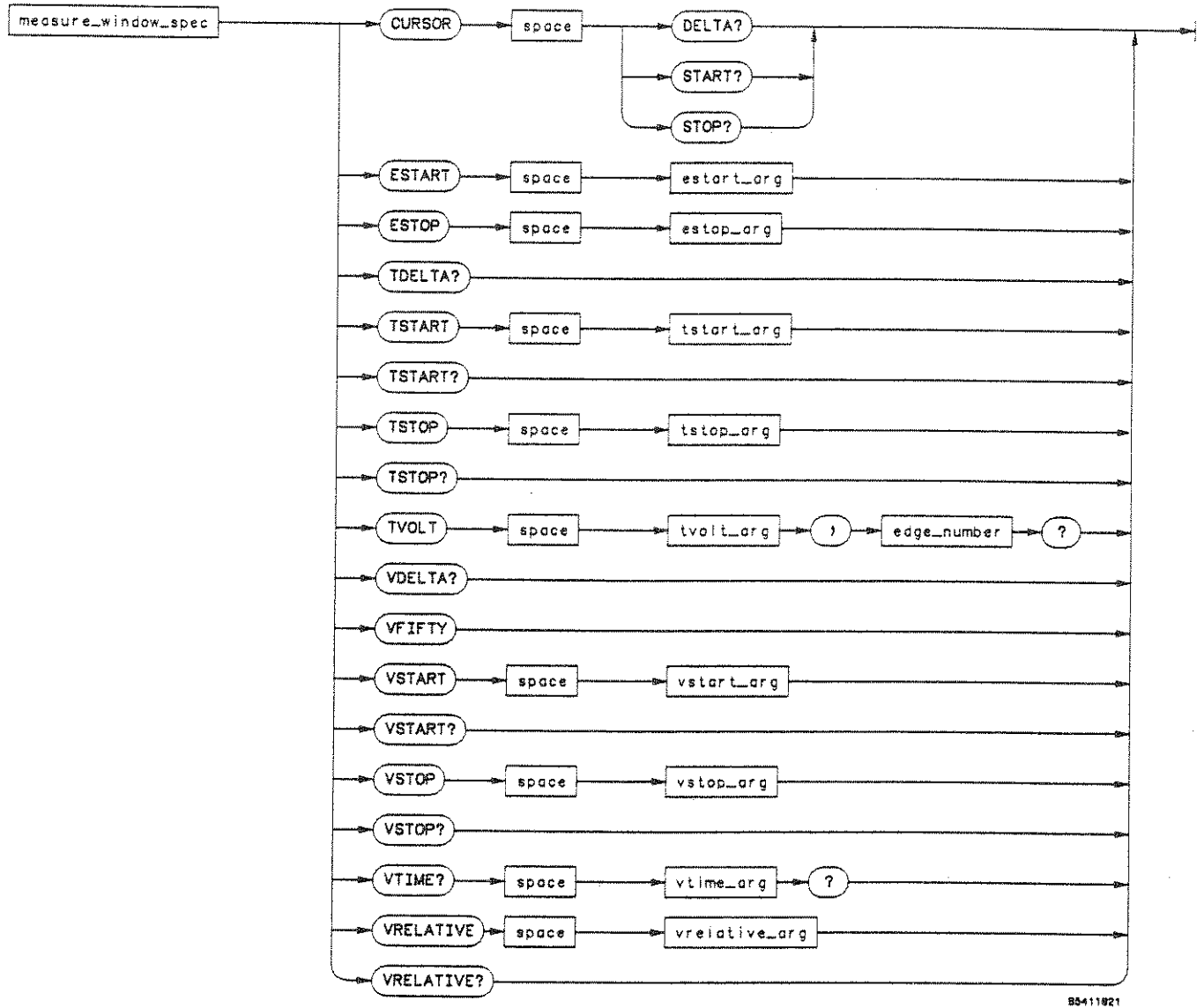

Figure 10-10. Measure Subsystem Commands

CHANNEL_NUMBER = An integer, 1 or 2.

EDGE_NUMBER = An integer from 1 to 100.

FUNC_NUMBER = An integer from 1 to 2.

MEM_NUMBER = An integer from 1 to 4.

VTIME_ARG = A real number that is within the horizontal display window.

VSTART_ARG = A real number $\leq 2 \times$ voltage range.

VSTOP_ARG = A real number $\leq 2 \times$ voltage range.

TSTART_ARG = A real number with the following restrictions:

Maximum is $60,000 \times$ timebase range or 1.6sec, whichever is greater
If the delay reference is left
then minimum is 200 ms or $-(\text{timebase range})$, whichever is smaller
Else if the delay reference is center
then minimum is $-5(\text{timebase range})$ or $-200 \text{ ms} + (\text{timebase range})$
whichever is smaller.
Else if the delay reference is right
then minimum is 0 or $-200 \text{ ms} + 10(\text{timebase range})$,
whichever is smaller.

TSTOP_ARG = A real number with the same restrictions as **TSTART_ARG**.

ESTART_ARG = An integer between 0 and 100.

ESTOP_ARG = An integer between 0 and 100.

VREL_ARG = An integer 0, 10, 20, 50.

Figure 10-10. Measure Subsystem Commands

10-16. MEASURE SUBSYSTEM

The commands in the MEASure subsystem allow you to make pulse parameter and voltage measurements. You may also make custom measurements using the voltage and time markers. Pulse parameter measurements are made on the left side of the display. If there isn't enough signal present on the display to make a measurement, 1E38 is returned. Measurements are made using previously specified PRECision. If PRECision is set to LOW, the waveform will not be expanded. If PRECision is set HIGH the unit will attempt to increase the precision of the measurement by making the sweep faster. Low precision measurements typically are accomplished faster than high precision measurements because of the additional time required for expansion. All predefined pulse parameter measurements cause an Auto Top-Base operation to be performed on the displayed signal. This operation determines the 10, 90, and 50 percent levels that are used to make the measurements. For more detailed information concerning the automated measurements refer to Appendix C. Refer to Figure 10-10 for a syntax diagram of the measure subsystem commands.

MEASure

command/query

The MEASure command selects the measure subsystem as the destination for the commands that follow. The query responds with selected measurement parameters.

Command Syntax: MEASure

Example: OUTPUT 707;"MEASURE"

Query Syntax: MEASure?

Returned Format: [MEASure]<crLf>
 [SOURce][CHANnel]<NR1>[FUNction]<NR1>
 [MEMory]<NR1><crLf>
 [PRECision]<argument><crLf>
 [VDELta]<NR3><crLf>
 [VSTArt]<NR3><crLf>
 [VSTOp]<NR3><crLf>
 [TDELta]<NR3><crLf>
 [TSTArt]<NR3><crLf>
 [TSTOp]<NR3><crLf>

Example: DIM Mea\$[200]
 OUTPUT 707;"EOI ON"
 OUTPUT 707;"MEASURE?"
 ENTER 707 USING "-K";Mea\$
 PRINT USING "K";Mea\$

ALL?

query

This query makes as many measurements as possible on the displayed signal and buffers the answers for output over HP-IB. If the measurement cannot be made the instrument will respond with 1.00000E+38.

Query Syntax: ALL?

Returned Format: [FREQuency]<NR3><crlf>
 [PERiod]<NR3><crlf>
 [PWIDth]<NR3><crlf>
 [NWIDth]<NR3><crlf>
 [RISE]<NR3><crlf>
 [FALL]<NR3><crlf>
 [TOPBase]<NR3><crlf>
 [VPP]<NR3><crlf>
 [PREShoot]<NR3><crlf>
 [OVERshoot]<NR3><crlf>
 [DUTYcycle]<NR3><crlf>
 [VRMS]<NR3><crlf>
 [VMAX]<NR3><crlf>
 [VMIN]<NR3><crlf>
 [VTOP]<NR3><crlf>
 [VBASe]<NR3><crlf>

Example: DIM A11\$[500]
 OUTPUT 707;"EOI ON"
 OUTPUT 707;"ALL?"
 ENTER 707 USING "-K";"A11\$"
 PRINT USING "K";A11\$

CURSOR?

query

This query returns time and voltage values of the specified marker as an ordered pair of time/voltage values. If delta is specified the instrument returns the value of delta V and delta T. If start is specified the positions of Vmarker1 and the start marker are returned. If stop is specified the positions of Vmarker2 and the stop marker are returned.

Query Syntax: CURSOR {[DELTA | 0]
 [START | 1]
 [STOP | 2] }?

Returned Format: [CURSOR]<NR3><,><NR3><crlf>

Example: DIM Cursor\$[30]
 OUTPUT 707;"CURSOR1?"
 ENTER 707;Cursor\$
 PRINT Cursor\$

DUTYcycle? | DUT?

query

This query causes the instrument to determine the duty cycle of the signal. The pulse width is measured at the 50% voltage point. The duty cycle is computed using the following formula:

$$\text{duty cycle} = (+\text{pulse width}/\text{period}) \times 100$$

Query Syntax: { DUTYcycle | DUT }?

Returned Format: [DUTYcycle]<NR3><crlf>

Example: DIM Dut\$[30]
 OUTPUT 707;"DUTYCYCLE?"
 ENTER 707;Dut\$
 PRINT Dut\$

ESTArt

command/query

This command causes the instrument to position the start marker on the specified edge and slope at the voltage level corresponding to voltage marker 1. A positive integer looks for a specific positive transition and a negative integer looks for a specific negative transition through the voltage level equal to the voltage level of voltage marker 1. The query responds with the currently specified edge.

Command Syntax: ESTArt<NR1>

Example: OUTPUT 707;"ESTART 2"

Query Syntax: ESTArt?

Returned Format: [ESTART]<NR1><crlf>

Example: OUTPUT 707;"ESTART?"
 ENTER 707;Es\$
 PRINT Es\$

ESTOp

command/query

This command causes the instrument to position the stop marker on the specified edge and slope at the voltage level corresponding to voltage marker 2. A positive integer looks for a specific positive transition and a negative integer looks for a specific negative transition through the voltage level equal the level of voltage marker 2. The query returns the currently specified edge.

Command Syntax: ESTOp

Example: OUTPUT 707;"ESTOP-2"

Query Syntax: ESTOP?

Returned Format: [ESTOP]<NR1><crlf>

Example: OUTPUT 707;ESTOP?
ENTER 707;Es\$
PRINT Es\$

FALL?

query

This query causes the instrument to measure the fall time of the first falling edge whose 10% and 90% points are on screen using the formula:

$$\text{fall time} = \text{time at 10\% point} - \text{time at 90\% point.}$$

Query Syntax: FALL?

Returned Format: [FALL]<NR3><crlf>

Example: OUTPUT 707;"FALL?"
ENTER 707;Fall\$
PRINT Fall\$

FREQuency?

query

This query causes the instrument to measure the frequency of the first complete period on screen using the 50% levels. The algorithm used is:

```
if first edge on screen is rising
  then
    frequency = 1/(time at second rising edge
                  - time at first rising edge)
  else
    frequency = 1/(time at second falling edge
                  - time at first falling edge)
```

Query Syntax: FREQuency?

Example: DIM Freq\$[30]
OUTPUT 707;"FREQuency?"
ENTER 707;Freq\$
PRINT Freq\$

NWIDth?

query

This query causes the instrument to measure the negative pulse width of the first negative pulse on screen using the 50% levels. The algorithm used is:

```
if first edge on screen is rising
  then
    width = (time at second rising edge
             - time at first falling edge)
  else
    width = (time at first rising edge
             - time at first falling edge)
```

Query Syntax: NWIDth?

Returned Format: [NWIDth]<NR3><cr|f>

```
Example: DIM Nwids[30]
         OUTPUT 707;"NWIDTh?"
         ENTER 707;Nwids
         PRINT Nwids
```

OVERshoot?

query

This query causes the instrument to measure the overshoot of a selected signal. Overshoot uses the first edge on screen using the following algorithm:

```
if the first edge on screen is rising
  then
    overshoot = Vmax - Vtop
  else
    overshoot = Vbase - Vmin
```

Query Syntax: OVERshoot?

Returned format: [OVERshoot]<NR3><cr|f>

```
Example: DIM Over$[30]
         OUTPUT 707;"OVERSHOOT?"
         ENTER 707;Over$
         PRINT Over$
```

PERiod?

query

This command causes the instrument to measure the period of the first complete cycle on screen using the 50% level. The algorithm is:

```

if first edge on screen is rising
  then
    period = (time at second rising edge
              - time at first rising edge)
  else
    period = (time at second falling edge
              - time at first falling edge)

```

Query Syntax: PERiod?

Returned format: [PERiod]<NR3><crLf>

Example: DIM Period\$[30]
 OUTPUT 707;"PERIOD?"
 ENTER 707;Period\$
 PRINT Period\$

PRECision

command/query

This command allows you to specify the precision that is used on subsequent measurements. When PRECision is set to HIGH the edges used for making a measurement are evaluated by making the sweep speed faster until the edge has a slope of approximately 45 degrees or the limit of the horizontal system has been reached. This increases the resolution of the measurement. When PRECision is set to LOW no horizontal expansion is accomplished. Low precision allows you increase measurement speed with the potential of reduced accuracy.

Command Syntax: PRECision {[LOW | 0]
 [HIGH | 1]}

Example: OUTPUT 707;"PRECISION LOW"

Query Syntax: PRECision?

Returned Format: [PRECision]<argument><crLf>

Example: DIM Prec\$[30]
 OUTPUT 707;"PREC?"
 ENTER 707;Prec\$
 PRINT Prec\$

PREShoot?

query

This query causes the instrument to measure the preshoot of the selected SOURCE. The PRESShoot command uses the first edge on screen using the following algorithm:

```
if the first edge on screen is rising
  then
    preshoot = Vbase - Vmin
  else
    preshoot = Vmax - Vtop
```

Query Syntax: PRESShoot?

Returned Format: [PRESShoot]<NR3><crlf>

```
Example: DIM Pres$[30]
         OUTPUT 707;"PRESHOOT?"
         ENTER 707;Pres$
         PRINT Pres$
```

PWIDTH?

query

This query causes the instrument to measure the positive pulse width of the first positive pulse on screen using the 50% levels. The algorithm used is:

```
if first edge on screen is falling
  then
    width = (time at second falling edge
             - time at first rising edge)
  else
    width = (time at first falling edge
             - time at first rising edge)
```

Query Syntax: PWIDTH?

Returned Format: [PWIDTH]<NR3><crlf>

```
Example: DIM Pw$[30]
         OUTPUT 707;"PWIDTH?"
         ENTER 707;Pw$
         PRINT Pw$
```

RISE?

query

This query causes the instrument to measure the rise time of the first rising edge whose 10% and 90% points are on screen using the formula:

$$\text{rise time} = (\text{time at 90\% point} - \text{time at 10\% point})$$

Query Syntax: RISE?

Returned Format: [RISE]<NR3><crlf>

Example: OUTPUT 707;"RISE?"
 ENTER 707;Rise\$
 PRINT Rise\$

SOURCE | SRC

command/query

This command selects the source(s) to be used for subsequent measurements. If the source is specified as CHANNEL1 or CHANNEL2, that channel will be used as the source for subsequent MEASURE commands. For dual measurements, 2 parameters are specified after the source command. Vmarker 1 the start marker will be assigned to the first and Vmarker 2 and the stop marker will be assigned to the second. If the keyword DUAL is used as the measurement source the markers will be assigned to chan 1 and 2 respectively. The marker measurement commands that work in DUAL are: ESTART, ESTOP, TSTART, TSTOP, TDELTA, VSTART, VSTOP, AND VDELTA.

Command Syntax: { SOURCE | SRC }{ [DUAL | 0] | [<, >]
 [CHANNEL1 | 1] | { [CHANNEL1 | 1]
 [CHANNEL2 | 2] | [CHANNEL2 | 2]
 [FUNCTION1 | 9] | [FUNCTION1 | 9]
 [FUNCTION2 | 10] | [FUNCTION2 | 10]
 [MEMORY1 | 11] | [MEMORY1 | 11]
 [MEMORY2 | 12] | [MEMORY2 | 12]
 [MEMORY3 | 13] | [MEMORY3 | 13]
 [MEMORY4 | 14] } | [MEMORY4 | 14] } }

Example: OUTPUT 707;"SOURCE CHANNEL1;MEMORY1"

Query Syntax: { SOURCE | SRC }?

Returned Format: [SOURCE | SRC]<argument><crlf>

Example: DIM Src\${50}
 OUTPUT 707;"SRC?"
 ENTER 707;Src\$
 PRINT Src\$

TOPBase?

query

This query returns the signal amplitude using the formula:

$$\text{amplitude} = V_{\text{top}} - V_{\text{base}}$$

V_{top} and V_{base} are located using a histogram of the voltage values of the waveform record. After a waveform record is collected the absolute min and max voltages are determined and a histogram of the voltage values is completed. Next, the waveform record is scanned to find the voltage values with the largest number of data points. If the maximum number of data points is greater than the limit criteria (approximately 5% of the maximum number of points in the record) that voltage level is used for the top or the base. If the limit criteria is not satisfied the absolute min, max values are used as the base and the top.

Query Syntax: TOPbase?

Returned Format: [TOPBase]<NR3><crlf>

Example: DIM Top\${30}
OUTPUT 707;"TOPBASE?"
ENTER 707;Top\$
PRINT Top\$

TDELta?

query

This query returns the time difference between the start and stop time markers, that is;

$$T_{\text{delta}} = T_{\text{stop}} - T_{\text{start}}$$

Where T_{start} is the time at the start marker and T_{stop} is the time at the stop marker.

Query Syntax: TDELta?

Returned Format: [TDELta]<NR3><crlf>

Example: DIM Td\${30}
OUTPUT 707;"TDELTA?"
ENTER 707;Td\$
PRINT Td\$

TSTArt

command/query

This command moves the start marker to the specified time with respect to the trigger time. The query returns the start marker position.

Command Syntax: TSTArt<start marker time>

Example: OUTPUT 707;"TSTArt -.001"

Query Syntax: TSTArt?

Returned Format: [TSTArt]<NR3><crlf>

Example: DIM Ts\$[30]

Example: OUTPUT 707;"TSTART?"
ENTER 707;Ts\$
PRINT Ts\$

TSTOp

command/query

This command moves the stop marker to a specified time with respect to the trigger. The query returns the stop marker position.

Command Query: TSTOp<stop marker time><crlf>

Example: OUTPUT 707;"TSTOP -1.0E-6"

Query Syntax: TSTOp?

Returned Format: [TSTOp]<NR3><crlf>

Example: DIM Ts\$[30]
OUTPUT 707;"TSTOP?"
ENTER 707;Ts\$
PRINT Ts\$

TVOLT?

query

When the TVOLT query is sent, the on screen signal is searched for the defined voltage level and transition. The time interval between the trigger event and this defined occurrence is returned as the response to this query.

The sign of <slope & occurrence> selects a rising(+) or falling(-) edge. The magnitude of this parameter defines the number of occurrences. For example, if <slope & occurrence> = +3 the on screen signal would be searched for the third occurrence of the specified voltage on a positive slope.

Query Syntax: TVOLT<voltage><,><slope & occurrence>?

Returned Format: [TVOLT]<NR3><crlf>

Example: DIM Tvolt\$[30]
OUTPUT 707;"TVOLT -.250,+3 ?"
ENTER 707;Tvolt\$
PRINT TVolt\$

VBASe?

query

This query returns the voltage level of the base of the waveform data. VBASe is determined by using a histogram of the voltage values of the waveform record. After a waveform record is collected the absolute min and max voltages are determined and a histogram of the voltage values is completed. Next, the waveform record is scanned to find the voltage values with the largest number of data points. If the maximum number of data points is greater than the limit criteria (approximately 5% of the maximum number of points in the record) that voltage level is used for the top or the base. If the limit criteria is not satisfied the absolute min, max values are used as the base and the top.

Query Syntax: VBASe?

Returned format: [VBASe]<NR3><crlf>

Example: OUTPUT 707;"VBASe?"
ENTER 707;Base\$
PRINT Base\$

VDELta?

query

This query returns the difference in voltage between voltage marker 1 & 2. That is:

$$\text{VDELta} = \text{Marker2} - \text{Marker1}$$

Where Marker1 is the voltage at marker 1 and Marker2 is the voltage at marker 2.

Query Syntax: VDELta?

Returned Format: [VDELta]<NR3><crlf>

Example: OUTPUT 707;"VDELta?"
 ENTER 707;Vdelta\$
 PRINT Vdelta\$

VFIFty

command

For a single source this command sets the voltage markers at the 50% level. For dual source measurements Vmarker1 is sent to the 50% level of the first source and Vmarker 2 is set to the 50% level of the second source. For a single source, this command has the same effect as pressing the front panel Auto Top-Base key and then pressing the 50-50% key.

Command Syntax: VFIFty

Example: OUTPUT 707;"VFIFTY"

VMAX?

query

This query returns the absolute maximum voltage present at the selected source.

Query Syntax: VMAX?

Returned Format: [VMAX]<NR3><crlf>

Example: OUTPUT 707;"VMAX?"
 ENTER 707;Vmax\$
 PRINT Vmax\$

VMIN?

query

This query returns the minimum voltage present on the selected source.

Query Syntax: VMIN?

Returned Format: [VMIN]<NR3><crlf>

Example: OUTPUT 707;"VMIN?"
ENTER 707;Vmin\$
PRINT Vmin\$

VPP?

query

This query returns the peak-to-peak voltage computed using the formula:

$$V_{pp} = V_{max} - V_{min}$$

Where Vmax and Vmin are the maximum and minimum voltages present on the selected source.

Query Syntax: VPP?

Returned Format: [VPP]<NR3><crlf>

Example: OUTPUT 707;"VPP?"
ENTER 707;Vpp\$
PRINT Vpp\$

VRELative

command/query

The VRELative command moves the voltage markers to defined percentage points of their last established positions. For example: after a TOPBase operation voltage marker 1 would be located at the base (0%) of the signal and voltage marker 2 would be at the top (100%) of the signal. If VRELative 10 command was executed, voltage marker 1 would be moved to the 10% level and voltage marker 2 would be moved to the 90% level the signal. VREL 100 would move the markers back to their original locations. VREL 50 would move both markers to the 50% point of their original positions. The query returns the current relative position of the markers i.e., 10, 20, 50, or 100.

Command Syntax: VRELative<percentage>

Example: OUTPUT 707;"VRELative 20"

Query Syntax: VRELative?

Returned Format: [VRELative]<NR1>

Example: OUTPUT 707;"VREL?"
ENTER 707;Vr\$
PRINT Vr\$

VRMS?

query

This query returns the RMS voltage of the selected SOURCE. The RMS voltage is computed over one complete period using the formula:

$$V_{rms} = \left[\frac{1}{n} \sum_{j=1}^{j=n} V_j^2 \right]^{\frac{1}{2}}$$

M5410001

Where there are n time buckets in 1 period and V_j is the voltage at bucket j of the period data. Since it is rare for a period to fall precisely within an integral number of time buckets, the algorithm rounds to the nearest time bucket at the beginning and end and uses these as the limits.

Query Syntax: VRMS?

Returned Format: [VRMS]<NR3><crlf>

Example: OUTPUT 707;"VRMS?"
 ENTER 707;V\$
 PRINT V\$

VSTArt

command/query

This command moves voltage marker 1 to the specified voltage. The query returns the current voltage level of voltage marker 1.

Command Syntax: VSTArt<voltage level>

Example: OUTPUT 707;"VSTART -.01"

Query Syntax: VSTArt?

Returned Format: [VSTArt]<NR3><crlf>

Example: OUTPUT 707;"VSTART?"
 ENTER 707;Vs\$
 PRINT Vs\$

VSTOp

command/query

This command moves voltage marker 2 to the specified voltage. The query returns the current voltage level of voltage marker 2.

Command Syntax: VSTOp<voltage level>

Example: OUTPUT 707;"VSTOP -.1"

Query Syntax: VSTOp?

Returned Format: [VSTOP]<NR3><crlf>

Example: OUTPUT 707;"VSTOP?"
ENTER 707;Vstop\$
PRINT Vstop\$

VTIME?

query

This query returns the voltage at a time, this time is referenced to the trigger event and must be on screen. The time may be + or - (before or after the trigger event). This command functions on single valued waveform records only. If the time with respect to the trigger event is off screen 1E38 will be returned. If the time bucket of interest does not contain any voltage values, due to the completion criteria being less than 100%, the VTIME value will be interpolated using linear interpolation between the closest points before and after the time bucket.

Query Syntax: VTIME?

Returned Format: [VTIME]<NR3><crlf>

Example: OUTPUT 707;"VTIME -.001?"
ENTER 707;Vt\$
PRINT Vt\$

10-17. TIMEBASE SUBSYSTEM

The Timebase Subsystem commands control the horizontal axis, "X axis", oscilloscope functions. See Figure 10-11 for a syntax diagram of the timebase subsystem commands.

TIMEbase

command/query

The TIMEbase command selects the timebase as the destination for the commands that follow. The query responds with all the settings of the timebase.

Command Syntax: TIMEbase

Example: OUTPUT 707;"TIMEBASE"

Query Syntax: TIMEbase?

Returned Format: [TIMEbase]<crlf>
[MODE]<argument><crlf>
[RANGE]<NR3><crlf>
[DELAY]<NR3><crlf>
[REFERENCE]<NR3><crlf>

Example: DIM Time\$[100]
OUTPUT 707;"EOI ON"
OUTPUT 707;"TIMEBASE?"
ENTER 707 USING "-K";Time\$
PRINT USING "K";Time\$

DElay | DLY

command/query

This command sets the timebase delay. This delay is the time interval between the trigger event and the on screen delay reference point. The query returns the current delay value.

Command Syntax: {[DElay][DLY]}<timebase delay>

Example: OUTPUT 707;"DELAY 2E-3"

Query Syntax: {[DElay][DLY]}?

Returned Format: [DElay]<NR3><crlf>

Example: OUTPUT 707;"DELAY?"
ENTER 707;De1\$
PRINT De1\$

MODE

command/query

This command selects the timebase mode. If the AUTO mode is selected the unit will provide a baseline on the display in the absence of a signal. If a signal is present but is not triggered the display will be unsynchronized but will not be a baseline. If the TRIGGERED mode is selected and no trigger is present the unit will not sweep, and the data acquired on the previous trigger will remain on-screen. The SINGLE mode causes the unit to make a single acquisition when the next trigger event occurs. The query returns the current mode.

Command Syntax: MODE([AUTO | 0]
 [TRIGGERED | 1]
 [SINGLE | 2])

Example: OUTPUT 707;"MODE SINGLE"

Query Syntax: MODE?

Returned Format: [MODE]<argument><crlf>

Example: OUTPUT 707;"MODE?"
 ENTER 707;Mode\$
 PRINT Mode\$

OFFSet

command/query

This command sets the timebase delay. This delay is the time interval between the trigger event and the on screen delay reference point. The query returns the current delay value. This command performs exactly the same function as the DELay command.

Command Syntax: OFFSet<timebase delay>

Example: OUTPUT 707;"OFFSET 1E-4"

Query Syntax: OFFSet?

Returned Format: [OFFSet]<NR3><crlf>

Example: OUTPUT 707;"OFFSET?"
 ENTER 707;Offs\$
 PRINT Offs\$

RANGe

command/query

This command defines the full scale horizontal time interval. RANGE = 10 X SENSITIVITY. The query returns the current range.

Command Syntax: RANGe<horizontal time interval>

Example: OUTPUT 707;"RANGE 1"

Query Syntax: RANGe?

Returned Format: [RANGe]<NR3><crlf>

Example: OUTPUT 707;"RANGE?"
ENTER 707;Range\$
PRINT Range\$

REFerence

command/query

This command sets the delay reference to the left, center, or right side of the screen. The query returns the current delay reference.

Command Syntax: REFerence {[LEFT | 0]
[CENTER | 1]
[RIGHT | 2]}

Example: OUTPUT 707;"REFERENCE LEFT"

Query Syntax: REFerence?

Returned Format: [REFerence]<argument><crlf>

Example: OUTPUT 707;"REFERENCE?"
ENTER 707;Ref\$
PRINT Ref\$

SENSitivity

command/query

This command sets the horizontal time/division to the defined value.
SENSitivity = RANGE/10. The query returns the current time/division.

Command Syntax: SENSITIVITY<time/division>

Example: OUTPUT 707;"SENSITIVITY 1E-7"

Query Syntax: SENSitivity?

Returned Format: [SENSitivity]<NR3><crLf>

Example: OUTPUT 707;"SENSITIVITY?"
ENTER 707;Sens\$
PRINT Sens\$

NOTES:

Model 54110D - Timebase Subsystem

NOTES:

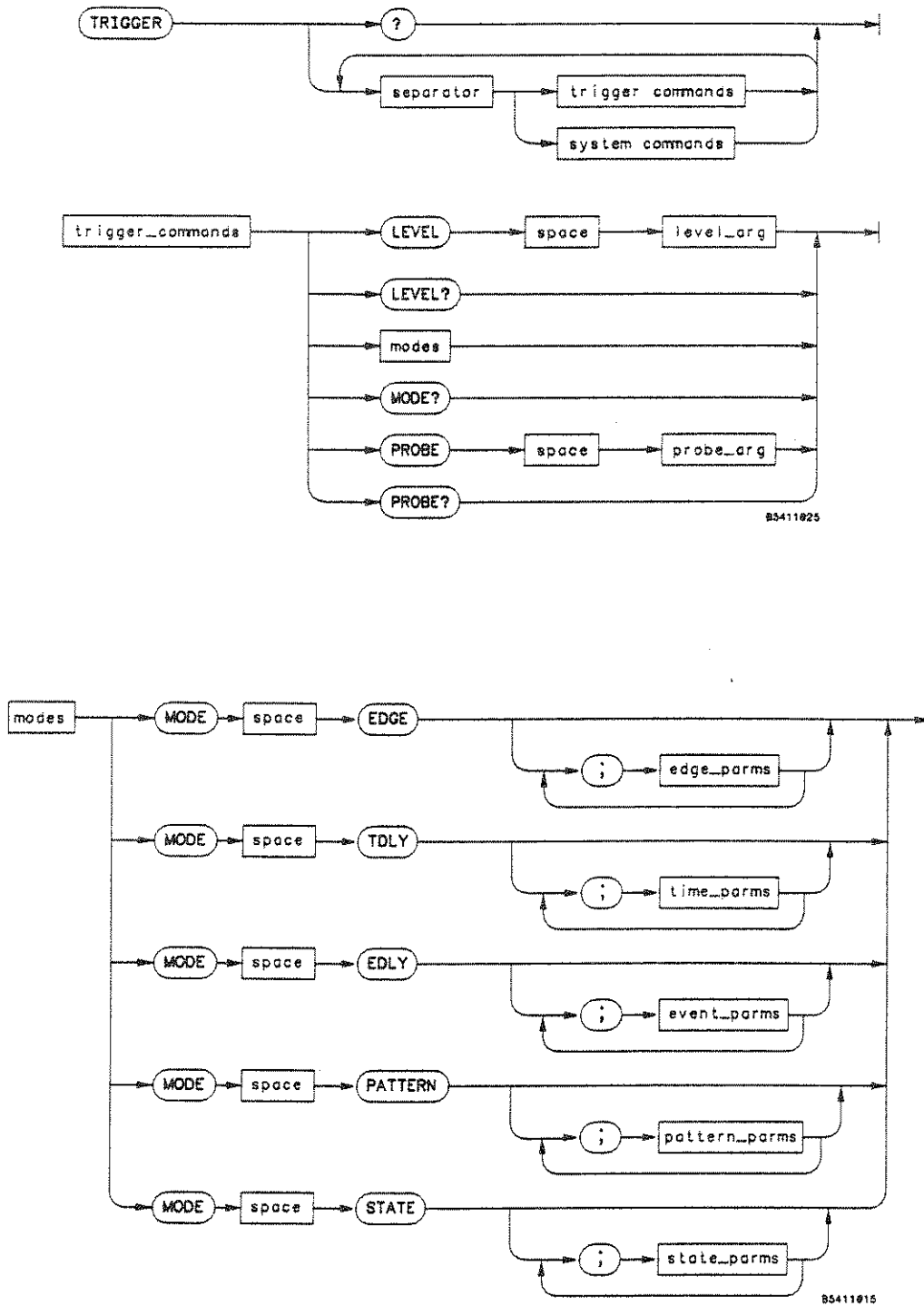

Figure 10-12 Trigger Subsystem Commands

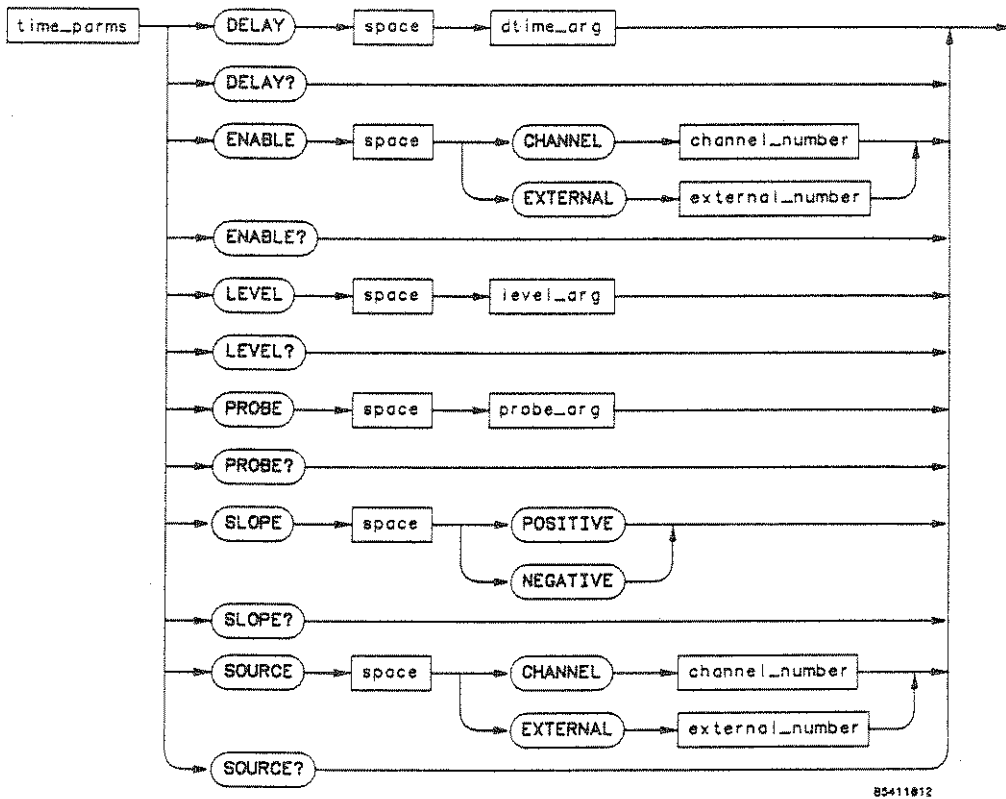
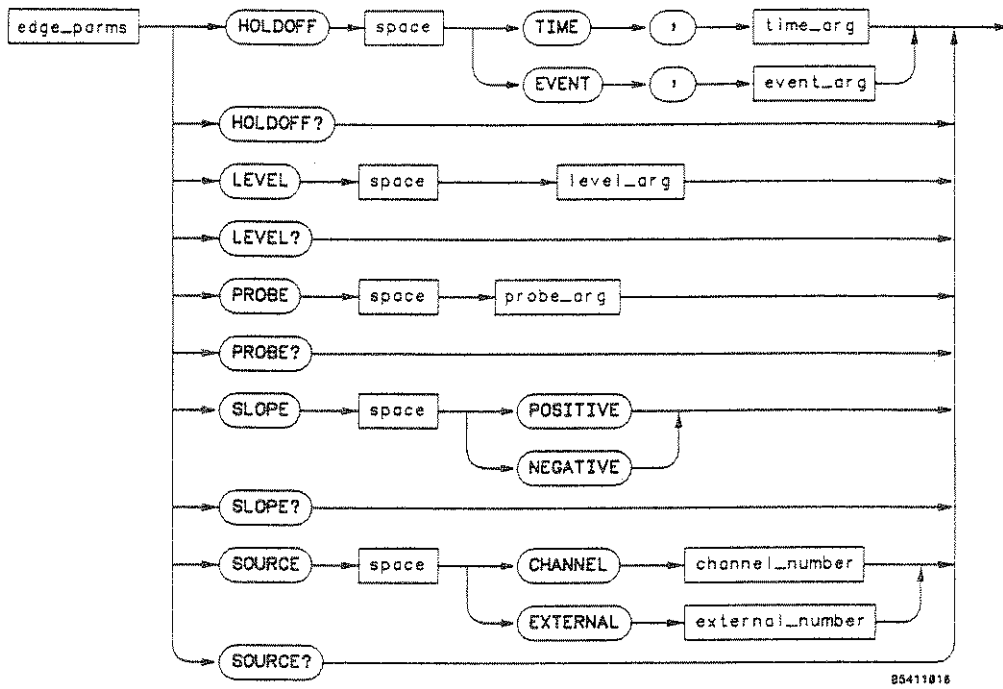

Figure 10-12 Trigger Subsystem Commands

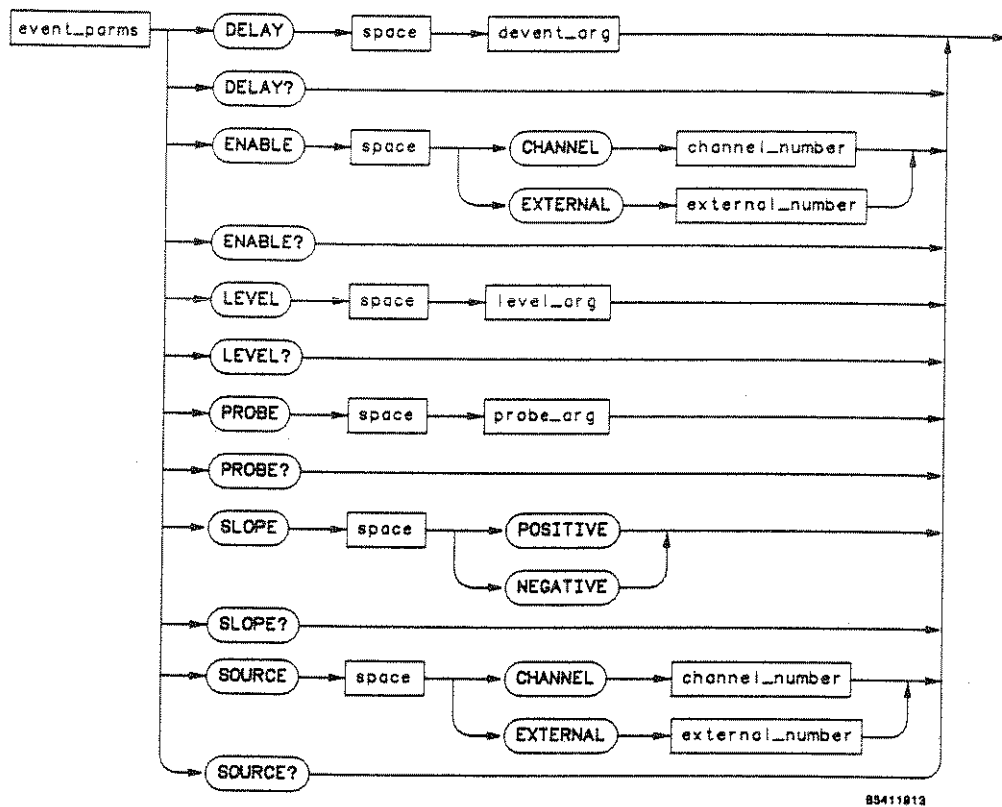

Figure 10-12 Trigger Subsystem Commands

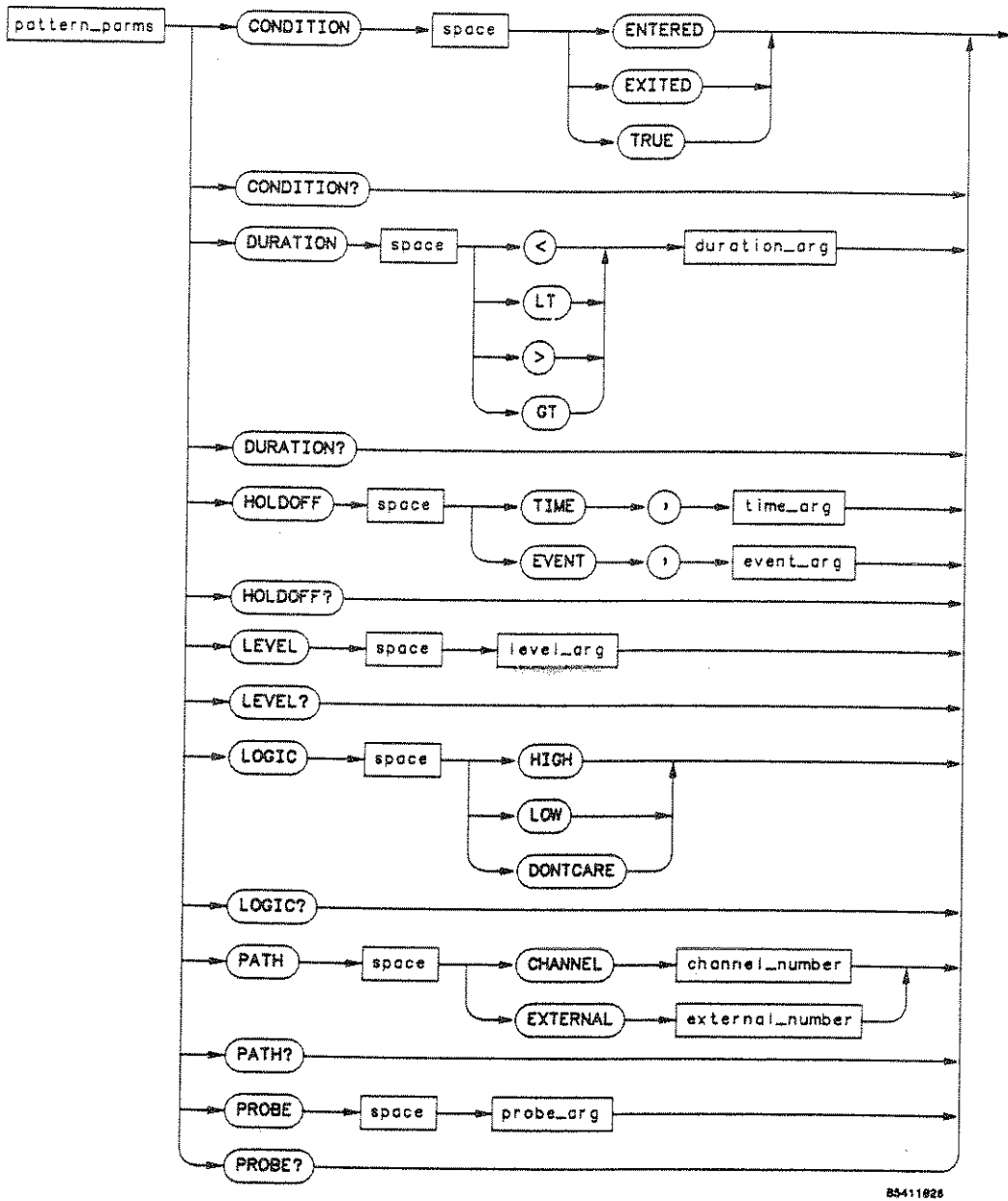

Figure 10-12 Trigger Subsystem Commands

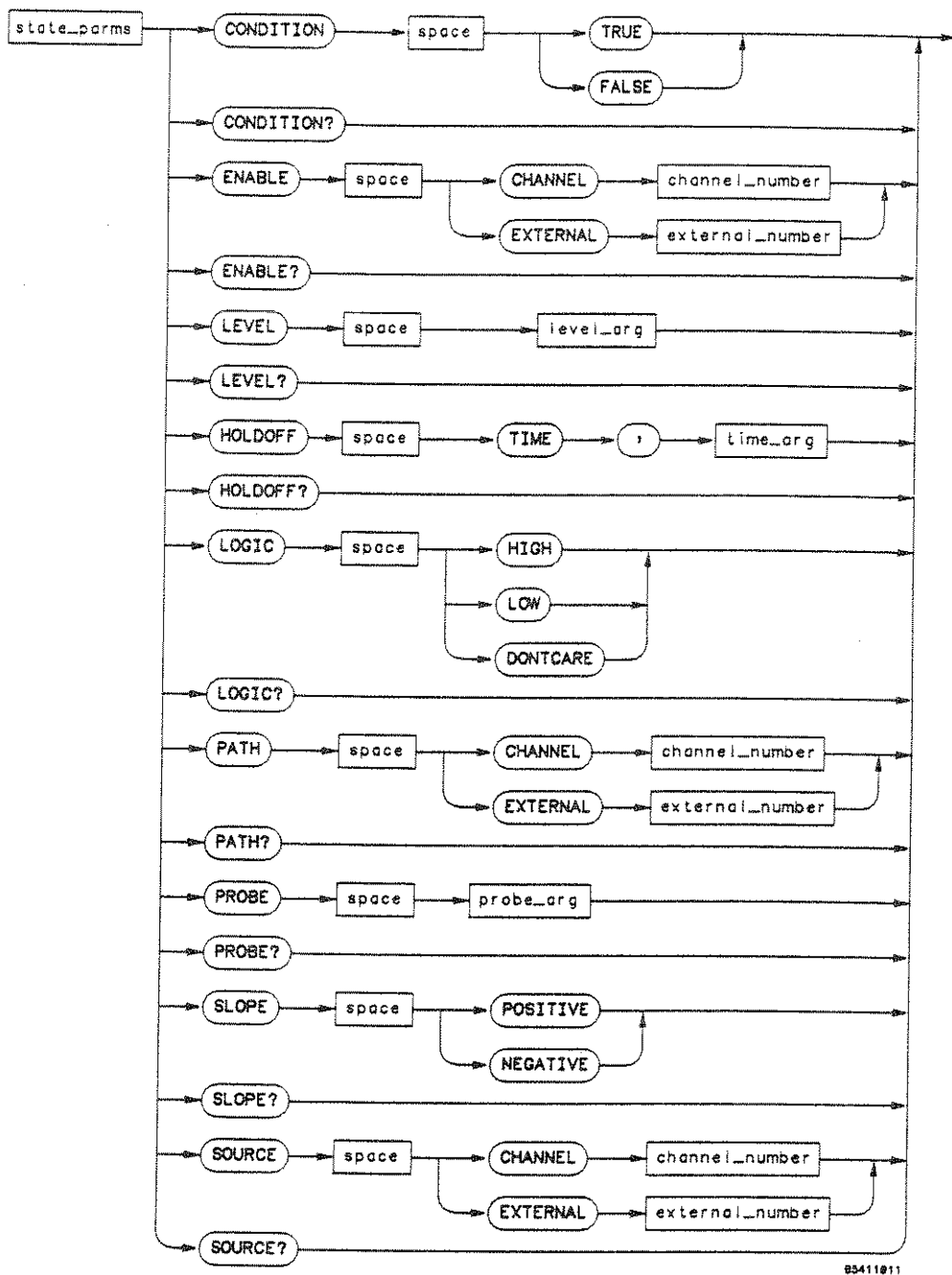

Figure 10-12 Trigger Subsystem Commands

10-18. TRIGGER SUBSYSTEM

The commands in the Trigger Subsystem are used to define the conditions for a trigger. This instrument provides five trigger modes: EDGE mode, PATTERN mode, EVENT DELAY mode, TIME DELAY mode, and the STATE mode.

In the edge mode each trigger source has an associated level, slope, and probe attenuation factor which are used when it is selected as a trigger source. These levels and probe attenuation factors are applicable to other modes however, the slope will depend on the particular mode used.

The SOURCE, ENABLE and PATH commands are related in that they select the source for commands like LOGIC or LEVEL, however each is used in a slightly different way. The SOURCE command is used to specify the trigger source for the EDGE, STATE, TDLY, and EDLY modes. This is the source that the actual trigger is generated from. The ENABLE command is used in the TDLY and EDLY modes to specify the source that is used to qualify the trigger. The PATH command is used in the PATTERN and STATE modes to select a pattern element for setup.

Each individual trigger mode keeps track of the last referenced source and it is this source that is addressed by any SLOPE, LOGIC, etc. commands when that mode is re-entered.

See Figure 10-12 for Trigger Subsystem syntax diagram.

TRIGger

command/query

The trigger command selects the trigger subsystem as the destination for the trigger commands that follow. The query responds with the subsystem parameters for the current trigger mode.

Command Syntax: TRIGger

Example: OUTPUT 707;"TRIGGER"

Query Syntax: TRIGger?

```
Returned Format:  MODE EDGE<crLf>
                  SOURce<path name><crLf>
                  PROBe<NR1><crLf>
                  LEVe1<NR3><crLf>
                  SLOPe<argument><crLf>
                  {[HOLDoff TIME]<NR3><crLf> |
                  [HOLDoff EVENTS]<NR1><crLf>}

                  MODE PATTERN<crLf>
                  CONDition<argument><crLf>
                  DURation<argument><crLf>
                  PATH<path name 1><crLf>
                  PROBe<NR3><crLf>
                  LEVe1<NR3><crLf>
                  LOGic<argument><crLf>
                  PATH<path name 2><crLf>
                  PROBe<NR3><crLf>
                  LEVe1<NR3><crLf>
                  LOGic<argument><crLf>
                  PATH<path name 3><crLf>
                  PROBe<NR3><crLf>
                  LEVe1<NR3><crLf>
                  LOGic<argument><crLf>
                  PATH<path name 4><crLf>
                  PROBe<NR3><crLf>
                  LEVe1<NR3><crLf>
                  LOGic<argument><crLf>
                  {[HOLDoff TIME]<NR3><crLf> |
                  [HOLDoff EVENTS]<NR1><crLf>}
```

(continued on next page)

DElay | DLY

command/query

This command/query is valid only in the events delay (EDLY) or time delay (TDLY) modes. In the time delay mode this command specifies the delay in seconds. In the events delay mode this command specifies the number of trigger events. The query returns the delay for the current mode.

Command Syntax: {DElay | DLY}{<event delay>|<time delay>}

Example: OUTPUT 707;"DELAY 10"

Query Syntax: DElay | DLY?

Returned Format: [DElay]{<NR1>|<NR3>}<crlf>

Example: OUTPUT 707;"DELAY?"
ENTER 707;Delay\$
PRINT Delay\$

DURation

command/query

This command/query is valid only in the pattern mode. It specifies the time limit (minimum time for ">", or maximum time for "<") a pattern must be present to generate a trigger. Pattern duration trigger is implicitly an "EXITED" condition, that is, the trigger coincides with the first event that makes the pattern false. The query returns the current selections for duration type and time.

Command Syntax: DURation{ [LT | 1 | <]
[GT | 2 | >] }

Example: OUTPUT 707;"DURATION LT 1E-3"

Query Syntax: DURation?

Returned Format: [DURation]<argument><crlf>

Example: OUTPUT 707;"DURATION?"
ENTER 707;Dur\$
PRINT Dur\$

ENABLE

command/query

This command/query is valid in the STATE, TDLY, or EDLY modes. It is used to specify the source that is to be used as the trigger enable, which is also the source for subsequent SLOPE and PROBE commands. The query returns the current trigger enable source of the present mode.

```
Command Syntax:  ENABle{ [ CHANne11 | 1 ]
                        [ CHANne12 | 2 ]
                        [ EXTerna11 | 3 ]
                        [ EXTerna12 | 4 ] }
```

Example: OUTPUT 707;"ENABLE CHANNEL3"

Query Syntax: ENABle?

Returned Format: [ENABle]<argument><crlf>

```
Example: OUTPUT 707;"ENABLE?"
         ENTER 707;Enable$
         PRINT Enable$
```

HOLDoff

command/query

This command allows you to specify the holdoff time in the EDGE, PATTERN, or the STATE modes, or the holdoff number of events in the EDGE or PATTERN modes. Each mode has its own holdoff parameters and "remembers" whether it was using holdoff by time or holdoff by events. The holdoff query is valid in the EDGE, PATTERN, or STATE modes and returns the current holdoff setting for the presently selected mode. Time holdoff ranges from 70 ns to 670 ms. Events holdoff ranges from 2 to 67,000,000 events.

```
Command Syntax:  HOLDoff { [EVENT<# of events>]
                          [TIME<holdoff time>] }
```

Example: OUTPUT 707;"HOLDOFF EVENT 100"

Query Syntax: HOLDoff?

Returned Format: [HOLDoff]<current holdoff mode>
<holdoff value><crlf>

```
Example: DIM Hold$[40]
         OUTPUT 707;"HOLDOFF?"
         ENTER 707;Hold$
         PRINT Hold$
```

LEVe1 | LVL

command/query

This command sets the trigger level of the selected SOURCE or PATH. The query returns the trigger level of the selected SOURCE or PATH.

Command Syntax: {[LEVe1 | LVL]} <trigger level>

Example: OUTPUT 707;"LEVEL .1"

Query Syntax: {[LEVe1 | LVL]}?

Returned Format: [LEVe1]<NR3><crlf>

Example: OUTPUT 707;"LEVEL?"
ENTER 707;Level\$
PRINT Level\$

LOGic

command/query

This command/query is valid in the STATE and PATTERN modes. The LOGic command is used to specify the relation between the signal and the predefined voltage level that must exist before that part of the pattern is considered valid. If the signal on a selected source or path is greater than the trigger level that signal is considered HIGH. If it less than the trigger level it is considered LOW. The query returns the last specified logic level of the currently enabled source.

Command Syntax: LOGic{[LOW | 0]
 [HIGH | 1]
 [DONTCARE | 2]}

Example: OUTPUT 707;"LOGIC DONTCARE"

Query Syntax: LOGic?

Returned Format: [LOGic]<argument><crlf>

Example: DIM Log\$[40]
OUTPUT 707;"LOGIC?"
ENTER 707;Log\$
PRINT Log\$

MODE

command/query

This command allows you to select the trigger mode. The query returns the current trigger mode.

Command Syntax: MODE([EDGE | 0]
 [PATTERN | 1]
 [STATE | 2]
 [TDLY | 3]
 [EDLY | 4])

Example: OUTPUT 707;"MODE EDGE"

Query Syntax: MODE?

Returned Format: [MODE]<argument><cr lf>

Example: OUTPUT 707;"MODE?"
 ENTER YOU;Mode\$
 PRINT Mode\$

PATH

command/query

This command/query is valid in the PATTERN and STATE modes. This command allows you select a pattern bit as the source for future probe and logic commands. The query returns the current trigger source of the present mode.

Command Syntax: PATH {[CHANNEL1 | CHAN1 | 1]
 [CHANNEL2 | CHAN2 | 2]
 [EXTERNAL1 | EXT1 | 3]
 [EXTERNAL2 | EXT2 | 4]}

Example: OUTPUT 707;"PATH CHANNEL3"

Query Syntax: PATH?

Returned Format: [PATH]<argument><cr lf>

Example: DIM Path\$[30]
 OUTPUT 707;"PATH?"
 ENTER 707;Path\$
 PRINT Path\$

PROBe

command/query

This command specifies the attenuation factor for the last specified SOURCE or PATH for the current trigger mode. If the trigger source is also a channel, the last specified probe attenuation for that channel is the one used. See the CHANNEL PROBE command in Paragraph 10-10. The query returns the current source's probe attenuation factor.

Command Syntax: PROBe<attenuation ratio>

Example: OUTPUT 707;"PROBE 10"

Query Syntax: PROBe?

Returned Format: [PROBe]<NR3><crlf>

Example: DIM Probe\${30}
OUTPUT 707;"PROBE?"
ENTER 707;Probe\$
PRINT Probe\$

SLOPe

command/query

This command allows you to specify the trigger slope for the previously specified source. The query returns the current slope for the last selected source of the current mode.

Command Syntax: SLOPe { [NEGATIVE | 0]
[POSITIVE | 1] }

Example: OUTPUT 707;"SLOPE POSITIVE"

Query Syntax: OUTPUT 707;"SLOPE?"

Returned Format: [SLOPe]<argument><crlf>

Example: OUTPUT 707;"SLOPE?"
ENTER 707;Slope\$
PRINT Slope\$

SOURCE | SRC

command/query

This command /query is valid in the EDGE, STATE, TDLY or EDLY modes and is used to specify the trigger source. This command also identifies the source for any subsequent SLOPe and PROBe commands. The query returns the current trigger source of the present mode.

Command Syntax: {[SOURCE | SRC]} ([CHANNEL1 | 1]
[CHANNEL2 | 2]
[EXTERNAL1 | 3]
[EXTERNAL2 | 4])

Example: OUTPUT 707;"SOURCE CHANNEL1"

Query Syntax: {[SOURCE | SRC]}?

Returned Format: [SOURCE]<argument><crlf>

Example: DIM Src\$[30]
OUTPUT 707;"SOURCE?"
ENTER 707;Src\$
PRINT Src\$

NOTES:

54110D - Trigger Subsystem

NOTES:

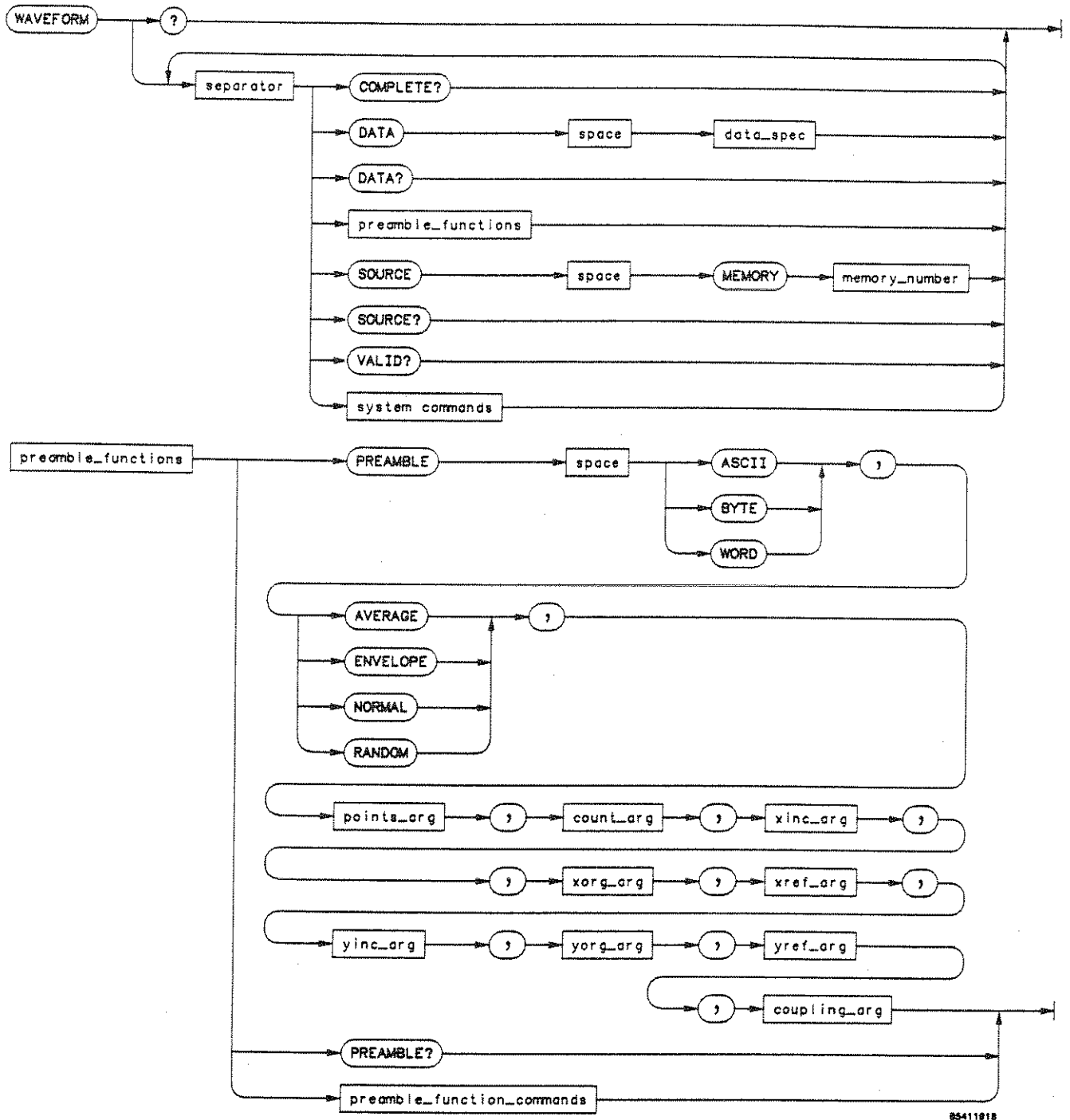

Figure 10-13. Waveform Subsystem Commands

MEMORY_NUMBER = An integer 1 through 4.

DATA_SPEC = A block of data in #A format as defined in IEEE Std. 728-1982.

POINTS_ARG = An integer = 128, 256, 500, 512, 1024.

COUNT_ARG = An integer from 1 to 2048.

XINC_ARG = A real number from 10 ps to 2 ms.

XORG_ARG = A real number with the following restrictions:

The maximum value is 60,000 X timebase range or 1.6 sec, which ever is greater.

If the delay reference is left then the minimum value is -200 ms or -(timebase range) whichever is smaller

Else if the delay reference is center

then the minimum value is the lesser of -5X(timebase range) and -200 ms + (10 X timebase range).

Else if the delay reference is right

then the minimum value is the lesser of 0 and -200 ms+(10Xtimebase range).

XREF_ARG = 0

YINC_ARG = A real number equal to 1/128 X voltage range.

YORG_ARG = A real number with a magnitude less than 1.5 X voltage range.

YREF_ARG = 64 for byte format; 16384 for word or ASCII format.

COUPLING = DCFIFTY or the integer 3.

Figure 10-13. Waveform Subsystem Commands

10-19. WAVEFORM SUBSYSTEM

The waveform subsystem commands are used to transfer waveforms to and from the four waveform memories. Waveform data consists of a preamble and a data record. The preamble contains scaling information useful for interpreting the data record while the data record contains the actual waveform data values.

Each element of the waveform preamble can be individually set or queried. This can cause you problems if not done judiciously, for example, setting POINTS in the preamble to a value different from the actual number of points in the waveform could result in inaccurate data being sent. For this reason only the query form of most of the preamble commands is documented here.

The actual values set in the preamble are determined when the DIGITIZE command is executed and are based on the settings of variables in the ACQUIRE subsystem. For more information on the DIGITIZE process and the ACQUIRE subsystem variables, see Section 10-8. For Syntax diagrams of the waveform subsystem commands see Figure 10-13.

The four waveform types are:

NORMAL:

Normal data consists of the last data point (hit) in each time bucket. This data is transmitted over HP-IB in a linear fashion starting with time bucket 0 and going through time bucket n, where n is the number returned by the WAVEform POINTs query. Time buckets that don't have data in them return -1. Only the voltage values of each data point transmitted, the time values correspond to the position in the data array. The first voltage value corresponds to the first time bucket on the left of the CRT and the last value corresponds to the next to last time bucket on the right side of the CRT.

AVERAGE:

Average data consists of the average of the first n hits in a time bucket, where n is the value returned by WAVEform COUNT query. Time buckets that have fewer than n hits return the average of what data they do have. Again, if a time bucket doesn't have any data in it, it will return -1. This data is transmitted over the HP-IB in a linear fashion starting with time bucket 0 and proceeding through time bucket n-1, where n is the number returned by the WAVEform POINTs query. The first value corresponds to a point at the left side of the screen and the last value is one point away from the right side of the screen.

ENVELOPE:

Envelope data consists of two arrays of data, one containing the minimum of the first n hits in each time bucket and the other consisting of the maximum of the first n hits in each time bucket, where n is the value returned by the count query. If a time bucket does not have any hits in it then -1 is returned for both the minimum and maximum values. The two arrays are transmitted one at a time over the HP-IB linearly, starting with time bucket 0 (on the left side of the CRT) and proceeding through time bucket $m-1$, where m is the value returned by the WAVEform POINTs query. The array with the minimum values is sent first. The first value of each array corresponds to the data point on the left side of the CRT. The last value is one data point away from the right side of the CRT.

When envelope data is acquired, the minimum and maximum data for channel 1 is stored in memories 1 and 3 respectively and the minimum and maximum data for channel 2 is stored in memories 2 and 4. Memories 1 and 2 are set to the envelope type and memories 3 and 4 are set to the normal type.

The data in the memories is transferred to a controller using the data query. The memory source for the transfer is specified by the waveform source command. When memory 1 is specified as the source, the minimum and maximum data from memories 1 and 3 is transferred over HP-IB, and when memory 3 is specified as the source, only the maximum data in memory 3 is transferred over HP-IB. Similarly, when memory 2 is specified as the source, the data from memories 2 and 4 is transferred over HP-IB, and when memory 4 is specified as the source only the maximum data in memory 4 is transferred over the bus.

If it is desirable to transfer only the data in memory 1 or 2, it can be accomplished by changing the memory 1 or memory 2 type from envelope to normal using the waveform type command.

Data is transferred into the instrument from a controller using the waveform data command. Envelope data can be transferred into memory 1 or memory 2 by specifying the type for the memories as envelope. The data is then transferred as two arrays. If memory 1 is specified as the source, the first array is transferred into memory 1 and the second array is transferred into memory 3. Similarly, if memory 2 is specified as the source, the first array is transferred into memory 2 and the second array is transferred into memory 4.

RANDOM:

Random data consists of all the data that can be gathered, but not to exceed 1024 points. This data is transmitted over the HP-IB in ordered time-voltage pairs. You should not use the BYTE format for this mode since the time bucket numbers range up to 500 and it is impossible to represent numbers this large in a byte without loss of precision. The time data is acquired using 500 time buckets. If ASCII and WORD format are used these time values are multiplied by 64 allowing values from 0 to 32,000. If BYTE format is used the allowed values are from 0 to 125, this demonstrates how precision is lost in the BYTE mode.

The three FORMATS that are used to transmit data over the HP-IB:

WORD:

Word formatted waveform records are transmitted using the binary block format (the #A format specified in IEEE STD. 728-1982). The character string "#A" is sent first, then followed by a two byte length value (16 bit binary) specifying the number of bytes to follow. The number of bytes is twice the number of words. The number of words is also the value returned by the WAVEform POINTs query. This is followed by a sequence of bytes representing the data words, with the most significant byte of each word being transmitted first. The A/D conversion in the 54110D yields a 7 bit result and is contained in the upper half of the data words transmitted by the instrument. The lower byte contains zeros unless the TYPE was average. In this case any increased resolution achieved through averaging will show up in the lower byte of the data. Values are always positive and between 0 and 32,767.

BYTE:

The BYTE formatted waveform records are transmitted over the HP-IB using the binary block format (the #A format specified in IEEE Std. 728-1982). The character string "#A" is sent first, then followed by a two byte length value (16 bit binary) specifying the number of bytes to follow. The number of bytes when the FORMat is BYTE is the same as the value returned by the WAVEform POINTs query. BYTE formatted transfers run approximately twice as fast as WORD and ASCII transfers, but should be used with caution if there are any data values to be sent that are larger than decimal 127. If the data values have a larger range than 127 as is the case when TYPE is RANDOM, the values are shifted until they fit within a byte. For example, when TYPE is RANDOM, the X values normally range from 0 to 500. Trying to transmit RANDOM data in BYTE FORMAT results in the time bucket numbers being rescaled so that they range from 0 to 125. This lumps time buckets 0 through 3 into one x coordinate, time buckets 4 through 7 into the next X coordinate, etc.

ASCII:

ASCII formatted waveform records are transmitted one value at a time, separated by <cr><lf>s. The data values transmitted are the same as would be sent in the WORD FORMAT except that they are converted to an integer ASCII format (six characters) before being sent over HP-IB.

The data values can be converted to voltage and time values using the following formulas:

$$\text{Voltage}(j) = [(Y\text{value}(j) - Y\text{reference}) * Y\text{increment}] + Y\text{origin}$$

$$\text{Time}(j) = (j * X\text{increment}) + X\text{origin} \quad (\text{non-RANDOM type})$$

$$\text{Time}(j) = (X\text{value}(j) * X\text{increment}) + X\text{origin} \quad (\text{RANDOM type})$$

Where Yvalue(j) is the value of the jth point and Yreference, Y increment, Yorigin, Xincrement, and Xorigin are the preamble values. In the RANDOM mode Xvalue(j) is the jth time point.

WAVEform

command/query

The WAVEform command selects the waveform subsystem as the destination for the waveform commands that follow. The query returns the waveform subsystem parameters. The COUPLing parameter is always DC or 1 depending on whether argument is set to alpha or numeric.

Command Syntax: WAVEform

Example: OUTPUT 707;"WAVEFORM"

Query Syntax: WAVEform?

Returned Format: [WAVEform]<crlf>
 [SOURce]<specified source><crlf>
 [VALid]<NR1><crlf>
 [FORMat]<argument><crlf>
 [TYPE]<argument><crlf>
 [POINTs]<NR1><crlf>
 [COUNT]<NR1><crlf>
 [XINCrement]<NR3><crlf>
 [XORigin]<NR3><crlf>
 [XREFerence]<NR1><crlf>
 [YINCrement]<NR3><crlf>
 [YORigin]<NR3><crlf>
 [YREFerence]<NR1><crlf>
 [COUPLing]<argument><crlf>
 [COMPlete]<NR1><crlf>

Example: DIM Wav\$[300]
 OUTPUT 707;"EOI ON"
 OUTPUT 707;"WAVEFORM?"
 ENTER 707 USING "-K";Wav\$
 PRINT USING "K";Wav\$

COMPlete

query

This query returns the completion criterion that was used for the last acquisition to the currently selected memory from its preamble.

Query Syntax: COMPlete?

Returned Format: [COMPlete]<NR1><crlf>

Example: DIM Comp\$[30]
 OUTPUT 707;"COMPLETE?"
 ENTER 707;Comp\$
 PRINT Comp\$

COUNT? | CNT?

query

This query returns the count field of the waveform preamble. The count field contains the number of averages if the TYPE is AVERAGED, or if the TYPE is ENVELOPE it contains the number of hits in each time bucket.

Query Syntax: ([COUNT | CNT])?

Returned Format: [COUNT]<NR1>

Example: OUTPUT 707;"COUNT?"
ENTER 707;Count\$
PRINT Count\$

DATA

command/query

This command causes the instrument to accept a waveform data record over the HP-IB from the controller and store it in the previously specified waveform memory. Note: The record format must match the format previously specified for the memory by its preamble. The query returns the waveform record stored in the previously specified waveform memory.

Command Syntax: DATA

Example: OUTPUT 707;"DATA"

Query Syntax: DATA?

Returned format: [DATA]#A<binary block length in bytes>
<binary block><crlf>

(continued on next page)

DATA (cont'd)

The following program moves data from the 54110D to the controller and then back to the 54110D using the WAVEFORM DATA command and query. For this example program use the instrument's cal signal and connect it to channel 1.

```
10 CLEAR 707
20 OUTPUT 707;"RESET"
30 OUTPUT 707;"AUTOSCALE"
40 ASSIGN @Fast TO 707;FORMAT OFF
50 OUTPUT 707;"ACQUIRE"
60 OUTPUT 707;"TYPE ENVELOPE COUNT 256 COMPLETE 90"
70 OUTPUT 707;"DIGITIZE 1"
80 OUTPUT 707;"HEADER OFF"
90 OUTPUT 707;"WAVEFORM SOURCE MEMORY1 FORMAT WORD"
100 OUTPUT 707;"DATA?"
110 ENTER 707 USING "#,2A"Header$
120 ENTER 707 USING "#,W";Byte_len
130 Word_len=Byte_len/2
140 ALLOCATE INTEGER waveform(1:Word_len)
150 ENTER @Fast;Waveform(*)
160 DIM Preamble$[120]
170 OUTPUT 707;"LONGFORM OFF"
180 OUTPUT 707;"PREAMBLE";Preamble$
190 ENTER 707;Preamble$
200 OUTPUT 707;"PREAMBLE";Preamble$
210 Header$="DATA #A"
220 OUTPUT 707 USING "#,7A,W";Header$;Byte_len
230 OUTPUT @Fast;Waveform(*)
240 OUTPUT 707;"TRANSFER MEMORY2,PLANE2"
250 OUTPUT 707;"VIEW PLANE2 BLANK CHANNEL1"
260 END
```

FORMat

command/query

This command allows you to set the data transmission mode for the waveform data points. When the ASCII mode is selected the data is sent as ASCII digits with each data value separated by a <crLf>. If the BYTE mode is selected the data is sent as eight bit integers, while a WORD formatted transfer transfers the data as 16 bit integers. The query returns the current transfer format for the previously specified memory.

```
Command Format; FORMat {[ ASCII | 0 ]
                        [ BYTE | 1 ]
                        [ WORD | 2 ]}
```

Example: OUTPUT 707;"FORMAT WORD"

Query Syntax: FORMat?

Returned Format: [FORMat]<argument><crLf>

```
Example: OUTPUT 707;"FORMAT?"
        ENTER 707;Format$
        PRINT Format$
```

POINTs? | PNTS?

query

This query returns the points value in the currently selected waveform preamble, which is the number of points acquired in the last DiGitize command to the selected waveform memory.

Query Syntax: {[POINTs | PNTS]}?

Returned Format: [POINTs]<NR1><crLf>

```
Example: OUTPUT 707;"POINTS?"
        ENTER 707;Points$
        PRINT Points$
```

PREamble

command/query

This command sends a waveform preamble to the selected waveform memory in the instrument. The query returns the previously specified memory.

Command Syntax: PREamble <preamble block>

```
<preamble block> ::= <format>,  
                    <type>,  
                    <points>,  
                    <count>,  
                    <xincrement>,  
                    <xorigin>,  
                    <xreference>,  
                    <yincrement>,  
                    <yorigin>,  
                    <yreference>,  
                    <coupling>
```

Query Syntax: PREamble?

```
Returned Format: [PREamble]<format parameter>,  
                <type parameter>,  
                <points NR1>,  
                <count NR1>,  
                <xincrement NR3>,  
                <xorigin NR3>,  
                <xreference NR1>,  
                <yincrement NR3>,  
                <yorigin NR3>,  
                <yreference NR1>,  
                <coupling parameter>
```

Example: This example program uses both the command and query form of the key word.

```
10 DIM Points$[120]  
20 OUTPUT 707;"HEADER OFF"  
30 OUTPUT 707;"WAVEFORM"  
40 OUTPUT 707;"PREAMBLE?"  
50 ENTER 707;Points$  
60 PRINT Points$  
70 OUTPUT 707 USING "#,K";"PREAMBLE",Points$
```

SOURCE | SRC

command/query

This command selects the memory that is to be used as the source in following waveform commands. The query returns the currently selected source.

Command Syntax: {[SOURCE | SRC]} {[MEMory1 | 1]
 [MEMory2 | 2]
 [MEMory3 | 3]
 [MEMory4 | 4]}

Example: OUTPUT 707;"SOURCE MEMORY3"

Query Syntax: SOURCE?

Returned format: [SOURCE]<argument><crlf>

Example: OUTPUT 707;"SOURCE?"
 ENTER 707;Src\$
 PRINT Src\$

TYPE

command/query

This command sets the data type for the currently selected memory. The query returns the data type for the previously specified memory.

Command Syntax: TYPE {[INVALID | 0] (query response only)
 [NORMAl | 1]
 [AVErage | 2]
 [ENVelope | 3]
 [RANDom | 4]}

Example: OUTPUT 707;"TYPE ENVELOPE"

Query Syntax: TYPE?

Returned Format: [TYPE]<argument><crlf>

Example: OUTPUT 707;"TYPE?"
 ENTER 707;Type\$
 PRINT Type\$

VALid?

query

This query returns 0 if there is not data in the memory. If there is valid data in the previously selected memory the response will be 1.

Query Syntax: VALid?

Returned format: [VALid] ([0 | 1])

Example: OUTPUT 707;"VALID?"
ENTER 707;Va\$
PRINT Va\$

XINCrement?

query

This query returns the x-increment value currently in the preamble. This value is the time difference between consecutive data points for NORMAL, AVERAGED, or ENVELOPE data.

Query Syntax: XINCrement?

Returned Format: [XINCrement]<NR3><cr lf>

Example: DIM Xin\$[30]
OUTPUT 707;"XINCREMENT?"
ENTER 707;Xin\$
PRINT Xin\$

XORigin?

query

The query returns the x-origin value currently in the preamble. This value is the time of the first data point in the memory with respect to the trigger point.

Query Syntax: XORigin?

Returned Format: [XORigin]<NR3><cr lf>

Example: DIM Xor\$[30]
OUTPUT 707;"XORIGIN?"
ENTER 707;Xor\$
PRINT Xor\$

XREference?

query

This query returns the current x-reference value in the preamble. This value specifies the data point that is associated with the x-origin data values.

Query Syntax: XREference?

Returned Format: [XREference]<NR1><crlf>

Example: DIM Xr\$[30]
OUTPUT 707;"XREFERENCE?"
ENTER 707;Xr\$
PRINT Xr\$

YINCrement?

query

This query returns the y-increment value currently in the preamble. This value is the voltage difference between consecutive data points.

Query Syntax: YINCrement?

Returned Format: [YINCrement]<NR3><crlf>

Example: DIM Yin\$[30]
OUTPUT 707;"YINCREMENT?"
ENTER 707;Yin\$
PRINT Yin\$

YORigin?

query

This query returns the y-origin currently in the preamble. This value is the voltage at center screen.

Query Syntax: YORigin?

Returned Format: [YORigin]<NR3><crlf>

Example: DIM Yor\$[30]
OUTPUT 707;"YORIGIN?"
ENTER 707;Yor\$
PRINT Yor\$

YREference

query

This query returns the current y-reference value in the preamble. This value specifies the data point where the y-origin occurs.

Query Syntax: YREference?

Returned Format: [YREference]<NR1><crlf>

Example: DIM Yref\$[30]
OUTPUT 707;"YREFERENCE?"
ENTER 707;Yref\$
PRINT Yref\$

Note

*For example: if the y reference is 64, and the y-origin is 1.1 V and the y-increment is 150 mV, then a data point whose y value is 93 would correspond to a voltage of $(93 - 64) * 150 \text{ mV} + 1.1 \text{ V}$ or 5.45 V.*

NOTES:

NOTES:

10-18. DATA MOVEMENT IN THE 54110D

Data in the 54110D may be moved inside the instrument between several different memories. Each of these memories has a specific function. These memories are diagrammed in Figure 10-14.

Fast ECL memory stores the data from the Analog to Digital converters for Channel 1 and Channel 2.

The active display memory contains the information that is currently being displayed on the 54110D's CRT. This memory is organized as 4 pixel arrays of 256 (vertical) by 501 (horizontal) bits or 64K bytes.

The waveform memories are the same waveform memories that are accessible from the front panel. These memories may contain up to 1024 data points. If the ACQUIRE TYPE is ENVELOPE, minimum and maximum data for channel 1 will be stored in memories 1 and 3 respectively, similarly, minimum and maximum data from channel 2 will be stored in memories 2 and 4.

The pixel memories are used to store copies of pictures from the active display memory. These two memories are organized the same way as the active display memory.

The HP-IB commands that control the movement of data in the 54110D are listed below and are shown in Figure 10-14 in the data paths that they control.

RUN causes the 54110D to acquire data for the active display memory.

MERGE copies the contents of the active display memory into either pixel memory 5 or 6.

TRANSFER allows the movement of data from any of the 4 waveform memories to either of the pixel memories.

DIGITIZE instructs the instrument to acquire data based on the conditions setup in the ACQUIRE subsystem. Data from channel 1 is placed in waveform memory 1 and data from channel 2 is placed in waveform memory 2, unless the ACQUIRE TYPE is ENVELOPE, then minimum and maximum data from channel 1 is stored in waveform memories 1 and 3 respectively, similarly, minimum and maximum data from channel 2 will be stored in waveform memories 2 and 4.

DATA may be moved to and from the waveform memories with the WAVEFORM DATA(?) commands.

DATA may also be moved to and from the pixel storage memories or the active display memory with DISPLAY DATA(?) commands.

Measurements (MEASURE subsystem) are performed using data from the fast ECL memory when the source is an active channel or function.

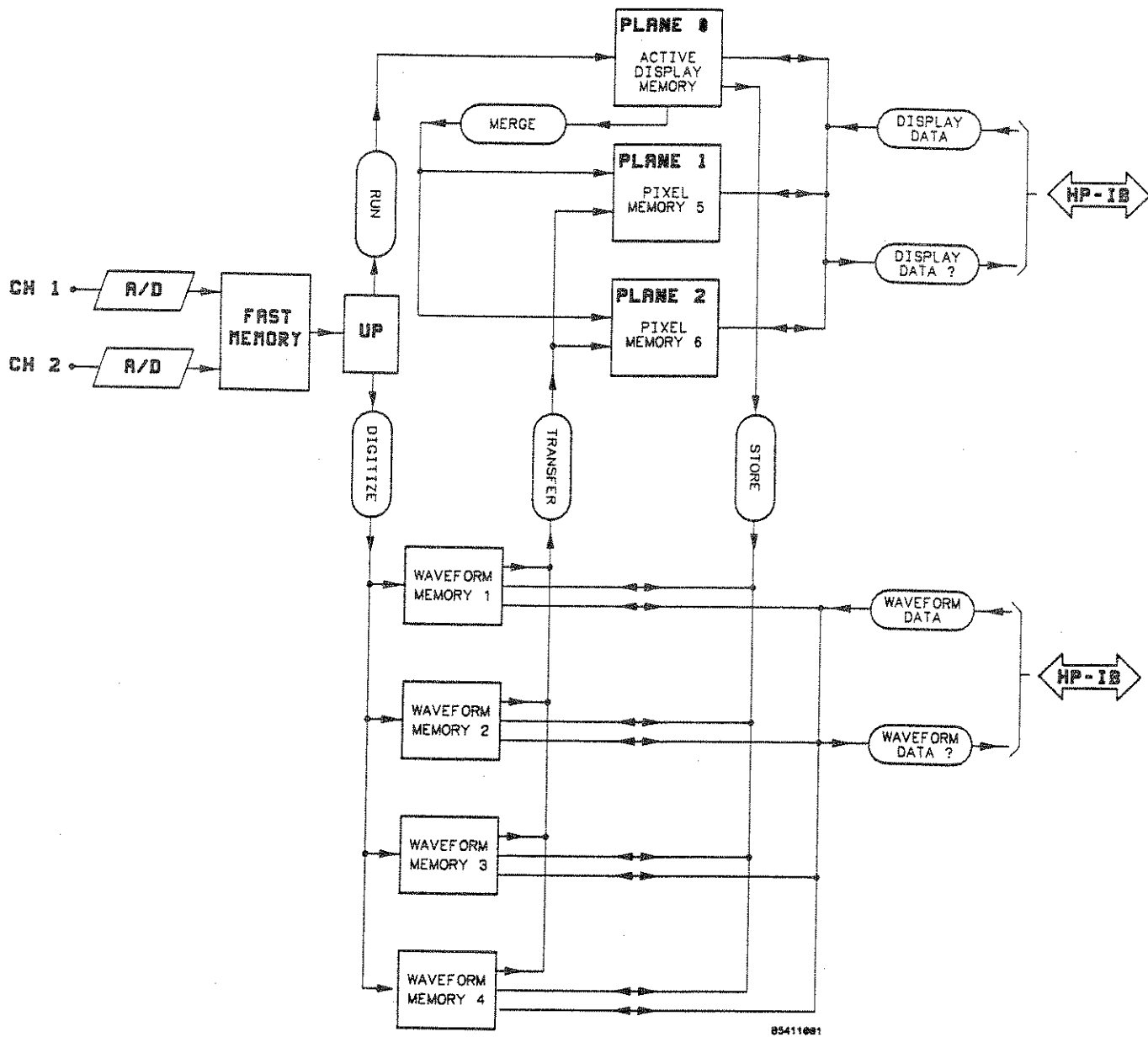

Figure 10-14. Data Flow

NOTES:

NOTES:

Appendix A

Example/Demo Programs

INTRODUCTION

This section contains example programs using the command set for the 54110D. In general, they use the longform of the command with alpha, (as opposed to numeric), arguments with each command using a separate output statement for clarity. To optimize speed, switch to concatenated shortform numerics.

Throughout these examples the 54110D is assumed to be at address 7, the hardcopy devices are assumed to be at address 1, and the system bus is at 700. The input signal used is the calibration signal available from the rear panel of the instrument connected to channel 1.

All programs were developed on an HP 200 series scientific computer using HP Basic 4.0. Several examples use the BASIC command "ENTER 2". This pauses program execution until the "ENTER" key is depressed on the controller. This is used to separate different blocks in the example for feature dramatizations, for user interaction, or to wait for the 54110D to finish something such as a hardcopy dump or an acquisition.

```

10      | This sample program demonstrates some of the commands
20      | used to set a vertical channel, in this case channel 1.
30      | This program works well using the cal signal from the
40      | rear panel of the instrument. The program assumes that
45      | the probe attenuation factor for channel 1 is 1.
50      CLEAR 707
60      | Device clear command,
70      | initializes HP-IB registers.
80      OUTPUT 707;"AUTOSCALE"      | Autoscales the unit
90      OUTPUT 707;"CHANNEL1"      | Enter Ch1 subsystem
100     OUTPUT 707;"OFFSET 0.0"    | Set offset to 0 volts
110     REAL Offset,Range
120     INTEGER J
130     Offset=0.
140     FOR J=1 TO 11
150         OUTPUT 707;"OFFSET";Offset | Set next offset
160         Offset=Offset-.04
170         WAIT .3
180     NEXT J
190     |
200     |
210     |

```

Model 54110D - Appendix A

```

220 OUTPUT 707;"AUTOSCALE"           ! Does as it says
230 OUTPUT 707;"RANGE .080"         ! Set vertical range to 80 mvolts (min)
240 !                               ! Can also use "SENSITIVITY" for
250 !                               ! volts/div
260 Range=.08                        ! Set range variable to minimum range
270 !                               ! or maximum sensitivity
280 FOR J=1 TO 7
290     OUTPUT 707;"RANGE";Range     ! Set new range
300     Range=Range*2
310     WAIT .3
320     NEXT J
330 !
340 !
350 OUTPUT 707;"GRAPH1"             ! Enter GRAPH subsystem
370 OUTPUT 707;"YOFFSET -.1"        ! Set magnified offset
380 OUTPUT 707;"YRANGE 4.0"         ! Set magnified range
390 OUTPUT 707;"MAGNIFY WINDOW"     ! Turns on magnify window
400 Range=4.0
410 FOR J=1 TO 5
420     OUTPUT 707;"YRANGE";Range    ! Set new magnified range
430     Range=Range/1.5              ! Automatically moves markers
440     WAIT .3                      ! to reflect new range
450     NEXT J
460 !
470 OUTPUT 707;"MAGNIFY ON"         ! Puts unit in the magnify mode.
480 LOCAL 707                       ! Returns the 54110D to local
490 END                               ! operation.

```

```

10 ! This is a sample program demonstrating the TIMEBASE
20 ! subsystem. The rear panel cal signal works well
30 ! with this program.
40 CLEAR 707                         ! Device clear command
50 !                                 ! initializes the HP-IB registers.
60 !
70 OUTPUT 707;"AUTOSCALE"           ! Does as it says.
80 REAL Sens,Delay
90 INTEGER J
100 OUTPUT 707;"TIMEBASE"           ! Enter TIMEBASE subsystem.
110 OUTPUT 707;"SENSITIVITY 200E-9" ! Set timebase to 200 nsec/div.
120 !                               ! Can also use "RANGE" for
130 !                               ! full scale setting.
140 !
150 OUTPUT 707;"DELAY 0.0 "         ! Set delay to 0.
160 OUTPUT 707;"REFERENCE LEFT"     ! Puts delay reference at left
170 !                               ! side of graticule.
180 !

```

```

190 Delay=0. ! Sets delay to 0.
200 FOR J=1 TO 25
210 OUTPUT 707;"OFFSET ";Delay ! "OFFSET" = "DELAY".
220 WAIT .23
230 Delay=Delay-1.00E-7
240 NEXT J
250 |
260 |
270 |
280 OUTPUT 707;"AUTOSCALE" ! Does as it says.
290 Range=.080 ! Sets full scale to 80 msec
300 | ! i.e., 8 ms/div.
310 FOR J=1 TO 25
320 OUTPUT 707;"RANGE";Range ! Next full scale range.
330 Range=Range/2
340 WAIT .4
350 NEXT J
360 |
370 WAIT 1
380 |
390 |
400 | NOTICE HOW DATA IS ACQUIRED AND
410 | THAT DATA POINTS ARE 25 ns APART
420 | FOR EVERY ACQUISITION.
430 |
440 |
441 OUTPUT 707;"HEADER OFF" ! Turn off headers in query reply,
450 OUTPUT 707;"AUTOSCALE" ! Does as it says.
460 OUTPUT 707;"SENSITIVITY?" ! Ask for time/div.
470 ENTER 707;Sens ! Read time/div.
480 Sens=Sens/8
490 OUTPUT 707;"SENSITIVITY";Sens ! Set faster sweep speed.
500 OUTPUT 707;"STOP" ! Halt acquisition (system command)
510 OUTPUT 707;"ERASE PLANE@" ! Clears the active display plane
520 | ! This is a system command.
530 OUTPUT 707;"MODE SINGLE" ! Sets for single shot operation.
540 FOR J=1 TO 20
550 OUTPUT 707;"RUN" ! One acquisition.
560 |
570 WAIT 1
580 NEXT J
590 |
600 |
610 OUTPUT 707;"MODE TRIGGERED" ! Puts unit in the triggered mode.
620 OUTPUT 707;"RUN" ! Starts acquisition.
630 END

```

Model 54110D - Appendix A

```

10  | This sample program demonstrates some of the commands in the
20  | Hardcopy subsystem and the PLOT command. It assumes that
30  | the scope is at address 7, the printer is at address 1, and
40  | that the system bus is 700.
50  CLEAR 707
60  OUTPUT 707;"HARDCOPY"           | Puts the scope in the HARDCOPY
70  |                               | subsystem.
80  OUTPUT 707;"PEN AUTO"          | Sets the 54110D to the auto
90  |                               | pen mode.
100 OUTPUT 707;"SOURCE PLANE0,FACTORS" | Selects the active display
110 |                               | (plane0) and the scale factors
120 |                               | for output.
130 |
140 OUTPUT 707;"PLOT"              | Outputs data to the plotter
150 SEND 7;UNT UNL                  | Clears bus
160 SEND 7;LISTEN 1                | Tells printer to listen
170 SEND 7;TALK 7                  | Sets scope to talk mode
180 SEND 7;DATA
190 WAIT 180                        | Wait 3 minutes for transfer to
200 |                               | complete.
210 |                               | Note: If programming, use the
220 |                               | SRQ capabilities of the 54110D
230 |                               | to determine when the transfer
240 |                               | is complete.
245 |                               | Attempting to program the
250 |                               | program the 54110D while making
260 END                             | a hardcopy dump will cause errors.

```

```

10  | This sample program demonstrates some of the commands in the
20  | Hardcopy subsystem. The service request is used to detect
30  | when printing is complete. The program assumes that a
40  | graphics printer is used and its address is set to 1.
50  CLEAR 707
60  OUTPUT 707;"REQUEST 4112"      | Request mask where:
70  |                               | Bit 12 = Hardcopy complete = 4096
80  |                               | Bit 4 = Ready bit = 16
90  |                               | Set so bit 12 causes SRQ
100 OUTPUT 707;"REQUEST ON"       | Enables scope's Service Request
110 ON INTR 7 GOTO 270            | Exit printing routine after SRQ
120 ENABLE INTR 7;2               | Enables SRQ on bus #7
130 DISABLE INTR 7                | Disables all interrupts on bus #7
140 OUTPUT 707;"HARDCOPY"         | Puts the scope in the HARDCOPY
150 |                               | subsystem.
160 OUTPUT 707;"PAGE AUTO"        | Sets the scope to automatically
170 |                               | output a formfeed
180 OUTPUT 707;"SOURCE PLANE0,FACTORS" | Selects the active display
190 |                               | (plane0) and the scale factors.

```

```

200 OUTPUT 707;"PRINT"           | Starts print buffering
210 SEND 7;UNT UNL              | Clears bus
220 SEND 7;LISTEN 1            | Tells printer to listen
230 SEND 7;TALK 7              | Puts the scope in talk mode
240 SEND 7;DATA                | Lowers the ATN line @ controller
250 ENABLE INTR 7              | Enables SRQ interrupt
260 GOTO 260                    | Loops until printing is complete
270 A=SPOLL(707)                | Clear service request
280 END

```

```

10 | This sample program demonstrates using the memories for
20 | measurements and performing measurements on single shot
40 | data. Before running the program, connect the cal signal
50 | on the rear panel of the instrument to the Channel 1 input.
70 |
80 | Setup signal.
90 |
100 CLEAR 707                   | Initialize HP-IB registers.
110 OUTPUT 707;"AUTOSCALE"      | Scale the signal.
120 OUTPUT 707;"TIMEBASE RANGE 250E-9" | Set to 25 nsecs/division.
130 |
140 | Acquire single sweep of signal - 10 points.
150 |
160 OUTPUT 707;"ACQUIRE POINTS 500 " | Full screen is 500 points.
170 OUTPUT 707;"TYPE 1"        | Acquisition type is normal.
180 OUTPUT 707;"COMPLETE 0"    | Acquire 1 sweep.
190 OUTPUT 707;"DIGITIZE CHANNEL 1" | Acquire Ch1 data to Memory 1.
200 OUTPUT 707;"BLANK CHANNEL 1" | Turn off Ch1.
210 |
220 | Measure peak to peak voltage of memory 1.
230 |
240 OUTPUT 707;"MEAS SOURCE MEMORY1" | Set measurement source.
250 OUTPUT 707;"VPP?"          | Measure peak to peak voltage.
260 DIM Vpp$(20)
270 ENTER 707;Vpp$
280 PRINT Vpp$                  | Print results.
290 END

```

Model 54110D - Appendix A

```

10      |
20      | This program demonstrates some of the learn string capabilities.
30      CLEAR 707
40      |
50      |
60      DIM Setting$(276)      | 266 = # of bytes in learn string
70      |                      | plus 10 = "SETUP #A**"
80      |                      | Where SET = header
90      |                      | #A = indicates binary block
100     |                      | ** = 2 byte integer = length
110     OUTPUT 707;"LONGFORM ON" | Use longform of mnemonics.
120     OUTPUT 707;"HEADER ON"  | Tells the 54110D to precede the
130     |                      | learn string with a header.
140     OUTPUT 707;"EOI ON "    | Tells the 54110D to output an EOI
150     |                      | with the last byte.
160     OUTPUT 707;"SETUP?"     | This asks the scope for the learn string
170     ENTER 707 USING "-K";Setting$ | Reads in header and string. (-K tells
180     |                      | computer to treat CR & LF as data).
190     LOCAL 707               | Puts scope in local operation.
200     |
210     |
220     |
230     ENTER 2                 | This allows you to change the scope's
240     |                      | setup.
250     |                      | Hit 'ENTER' to continue
260     |
270     |
280     OUTPUT 707;Setting$     | Outputs the learn string and header.
290     |                      | Scope is reset to previous setup.
300     |
310     LOCAL 707               | Returns scope to local operation.
320     |
330     END

```

```

10      | This sample program demonstrates some of the commands in the
20      | MEASURE Subsystem.
30      |
40      CLEAR 707
50      OUTPUT 707;"AUTOSCALE"  | Does as it says
60      OUTPUT 707;"ACQUIRE TYPE NORMAL" | Sets display mode to Normal
70      OUTPUT 707;"DISPLAY"    | Selects DISPLAY Subsystem
80      OUTPUT 707;"TMARKER ON" | Turn on Tmarkers
90      |
100     |
110     OUTPUT 707;"MEASURE"     | Selects MEASURE subsystem
120     OUTPUT 707;"PRECISION HIGH" | Sets precision for maximum accuracy
130     OUTPUT 707;"SOURCE CHANNEL 1" | Channel 1 is the measurement source

```

```

140 OUTPUT 707;"VSTART -.2"           ! Sets voltage markers to
150 OUTPUT 707;"VSTOP -.2"           ! -200 mV. This will be used as a
160 !                                 ! reference for the edge find
170 !                                 ! function.
180 INTEGER J
190 FOR J=1 TO 2
200     OUTPUT 707;"ESTART +";J       ! Find Jth positive edge
210     WAIT .75
220     OUTPUT 707;"ESTOP -";J       ! Find Jth negative edge
230     WAIT .75
240     NEXT J
250 !
260 ENTER 2                           ! This statement causes a pause in the
270 !                                 ! program, press ENTER on the control-
280 !                                 ! ler to continue.
290 !
300 !
310 REAL Delay,Offset
320 Delay=2.4E-6                       ! Initialize delay variable
330 Offset=.4                          ! Initialize offset variable
340 FOR J=1 TO 20
350     OUTPUT 707;"TSTART";Delay     ! Move time start marker
360     OUTPUT 707;"TSTOP";-Delay     ! Move time stop marker
370     OUTPUT 707;"VSTART";-.19-Offset ! Move voltage start marker
380     OUTPUT 707;"VSTOP";-.19+Offset ! Move voltage stop marker
390     Offset=Offset-.04
400     Delay=Delay-2.40E-7
410     NEXT J
420 !
430 ENTER 2                           ! Same as line 230.
440 !
450 !
460 OUTPUT 707;"PRECISION LOW"        ! Sets the PRECISION flag low.
470 !                                 ! Low precision uses previously
480 !                                 ! acquired data for measurements.
490 !                                 ! This allows faster completion of
500 !                                 ! measurements at the expense of some
510 !                                 ! accuracy and repeatability.
520 OUTPUT 707;"ALL?"                ! Measure all parameters. They will be
530 !                                 ! displayed on scope, and are
540 !                                 ! available over HP-IB.
550 !
560 !
570 !
580 ENTER 2                           ! Pause
590 !
600 !

```

Model 54110D - Appendix A

```

610 OUTPUT 707;"RISE?"           ! Measure RISE time using low
620 !                             precision. You set precision
630 !                             flag earlier.
640 ENTER 2                       ! Pause
650 !
660 !
670 OUTPUT 707;"PRECISION HIGH"  ! Set PRECISION flag high.
680 OUTPUT 707;"RISE?"           ! Measure precise RISE time.
690 !                             Watch the display during this
700 !                             measurement.
710 !
720 !
730 !
740 OUTPUT 707;"PRECISION LOW"   ! Sets PRECISION flag low.
750 LOCAL 707                     ! Puts the 54110D in local operation.
760 END

```

```

10 !
20 ! This sample program demonstrates more uses of the Service
30 ! Requests (SRQ's). This set of instructions uses: Hardcopy
40 ! Done, Local, Front Panel Service, Ready bit and Ready Masks.
50 ! The scope will monitor the front panel for SRQ's and echo
60 ! any activity. Any Advisories or Acquisitions initiated
70 ! by the front panel will be disclosed. These examples assume
80 ! the scope to be at address 7 and the plotter to be at address
90 ! 1 on bus #7.
100 !
110 CLEAR 707
120 PRINTER IS 1                   ! Display is PRINT destination
130 DIM K$(80),A$(80)
140 !
150 ON INTR 7 GOSUB Srq_svc        ! Goto 'Srq_svc' on Service Request
160 ENABLE INTR 7;2               ! Enables SRQ on bus #7
170 DISABLE INTR 7                ! Disables all interrupts on bus #7
180 !
190 PRINT
200 OUTPUT 707;"RESET"            ! Resets 54110D.
210 OUTPUT 707;"AUTOSCALE"       ! Does as it says
220 OUTPUT 707;"ACQUIRE MODE AVERAGE" ! Puts scope into averaged mode.
230 WAIT 4                        ! Wait for data accumulation
240 INTEGER Rqsmask
250 Rqsmask=4096+16+4             ! request mask
260 !                             4096 = Hardcopy done - bit 12
270 !                             16 = Ready - bit 4
280 !                             4 = Front Panel Service - bit 2
290 !                             Set so bit 12 causes an SRQ

```



```

300  OUTPUT 707;"REQUEST";Rqsmask           ! Send Request Mask
310  OUTPUT 707;"REQUEST ON"                ! Sets RQS - bit 8 on request mask
320  OUTPUT 707;"LONGFORM ON"              ! Sets longform for headers.
330  OUTPUT 707;"HEADER ON"                ! Sets headers on for queries.
340  Stat=SPOLL(707)                        ! Serial Poll scope, should be 0.
350  PRINT "Result of Serial Poll is ";Stat
360  !
370  Dump_flag=0
380  OUTPUT 707;"HARDCOPY SOURCE PLANE0,FACTORS" ! Selects active display and
390  !                                       scale factors for output.
400  OUTPUT 707;"PEN AUTO"                 ! Sets auto pen on.
410  OUTPUT 707;"PRINT"                    ! Starts Plot.
420  SEND 7;UNT UNL                         ! Turns off entire bus.
430  SEND 7;LISTEN 1                       ! Sets plotter to listen.
440  SEND 7;TALK 7                          ! Sets scope to talk.
450  SEND 7;DATA                            ! Lower ATN line @ controller
460  !
470  ENABLE INTR 7                          ! Enables interrupts on bus #7.
480  !
490  IF Dump_flag=0 THEN
500  PRINT
510  PRINT " Waiting for hardcopy transfer to complete."
520  PRINT " Time available for other tasks."
530  PRINT " !!!!! Bus is NOT available          !!!!!"
540  WAIT 2
550  GOTO 490
560  END IF
570  GOTO 570
580  !
590  !
600  !
610  ! Service request interrupt routine,
620  !
530  Srq_svc:|
540  Stat=SPOLL(707)                        ! Perform serial poll
650  !                                       and clear SRQ.
660  INTEGER J
670  PRINT
680  PRINT "Service Request Status= ";Stat
690  !
700  !
710  IF BIT(Stat,0) THEN                    ! 54110D is not a controller.
720  PRINT "RQC should not be set - PROBLEM" ! RQC cannot be set by 54110D.
730  END IF
740  !
750  !
760  IF BIT(Stat,1) THEN                    ! RAM power failure
770  PRINT "PWR status has been set-WHY?"
780  END IF
790  !
800  !

```

Model 54110D - Appendix A

```

810   IF BIT(Stat,2) THEN
820     PRINT "FPS status has been set"
830     OUTPUT 707;"KEY?"
840     ENTER 707;K$
850     OUTPUT 707;K$
860     PRINT "      "&K$
870   END IF
880   !
890   !
900   IF BIT(Stat,3) THEN
910     PRINT "LCL operation has occurred"
920   END IF
930   !
940   !
950   IF BIT(Stat,4) THEN
960     PRINT "Hardcopy Complete !!"
970     IF Dump_flag=0 THEN
980       SEND 7;UNT UNL
990       Dump_flag=1
1000    END IF
1010    PRINT "Now try pressing keys, they will echo from controller"
1020  END IF
1030  !
1040  !
1050  IF BIT(Stat,5) THEN
1060    REPEAT
1070      OUTPUT 707;"ERR?"
1080      ENTER 707;A$
1090      PRINT "Error was : ";A$
1100      UNTIL VAL(A$[9,12])=0
1110    END IF
1120    !
1130    !
1140    IF BIT(Stat,6) THEN
1150      OUTPUT 707;"REQUEST?"
1160      ENTER 707;A$
1170      PRINT A$&" is the mask value"
1180    END IF
1190    !
1200    !
1210    IF BIT(Stat,7) THEN
1220      OUTPUT 707;"DSP?"
1230      ENTER 707;A$
1240      PRINT A$&" is the Advisory"
1250    END IF
1260    !
1270    !
1280    ENABLE INTR 7
1290    RETURN
1300    !
1310  END

```

! Front Panel Service

! Asks for key code.

! Reads key code.

! Outputs key code.

! Local operation occurred.

! Ready bit - only bit active
! in the Ready byte is Hardcopy
! Complete.

! Go read the errors.

! Asks for next error in queue.

! Reads next error.

! Prints next error.

! Until error queue is empty.

! A SRQ was generated by someone.

! Asks for mask value.

! Reads mask value.

! Advisory has been initiated

! Asks for advisory.

! Reads advisory.

! Prints advisory.

```

10      |
20      | This sample program demonstrates some of the uses of
30      | Service Requests (SRQ's). This set of instructions uses
40      | the Acquisition Done, Local, Front Panel Service,
50      | Ready and Ready masks. An acquisition that will produce
60      | buffered results will be started. When a SRQ is sent the
70      | results will be read and displayed. The scope will then
80      | monitor the front panel keys using SRQ's and echo any
90      | activated. Any Advisories or Acquisitions initiated from
100     | the front panel will be disclosed.
110     |
120     CLEAR 707
130     |
140     PRINTER IS 1                               ! Display is PRINT destination
150     DIM B$(1:16)[30],K#[80],A#[80]
160     |
170     ON INTR 7 GOSUB Srq_svc                     ! Goto 'Srq_svc' on Service Request.
180     ENABLE INTR 7;2                             ! Enables SRQ on bus #7.
190     DISABLE INTR 7                             ! Disables all interuppts on bus #7.
200     |
210     PRINT
220     OUTPUT 707;"RESET"                          ! Resets 54110D
230     OUTPUT 707;"AUTOSCALE"                     ! Does as it says.
240     INTEGER Rqsmask
250     Rqsmask=1024+16+4                           ! Request mask where:
260     |                                           1024 = Acquisition done - bit 10.
270     |                                           16 = Ready - bit 4.
280     |                                           4 = Front Panel Service - bit 2.
290     |
300     OUTPUT 707;"REQUEST";Rqsmask               ! Sends Request Mask.
310     OUTPUT 707;"REQUEST ON"                    ! Sets RQS - bit 6 in Request mask.
320     OUTPUT 707;"LONGFORM ON"                  ! Turns on longform for headers.
330     OUTPUT 707;"HEADER ON"                    ! Turns headers on for queries.
340     Stat=SPOLL(707)                             ! Serial Poll scope, should be 0
350     PRINT "Result of Serial Poll is ";Stat
360     |
370     Meas_flag=0
380     OUTPUT 707;"MEASURE "                       ! Enters MEASURE subsystem.
390     OUTPUT 707;"SOURCE CHANNEL 1"              ! Channel 1 is source for measurement

```

Model 54110D - Appendix A

```

400  OUTPUT 707;"PRECISION HIGH; ALL?"      ! Sets PRECISION flag high and
410  !                                       measures all.
420  ENABLE INTR 7                          ! Enables interupts on bus #7.
430  !
440  PRINT " Waiting for measurement to complete."
450  PRINT " Time available for other tasks."
460  PRINT " Bus is available."
470  !
480  GOTO 480                                ! Loop until Service Request occurs.
490  !
500  !
510  !
520  ! Service Request Interupt Routine
530  !
540  Srq_svc:
550  Stat=SPOLL(707)                         ! Performs a Serial Poll
560  !                                       and clears SRQ.
570  INTEGER J
580  PRINT
590  PRINT "Service Request Status= ";Stat
600  !
610  !
620  IF BIT(Stat,0) THEN                     ! Request Control - 54110D is
630  PRINT "RQC should not be set - PROBLEM" ! not a controller and
640  END IF                                   ! cannot send a RQC.
650  !
660  !
670  IF BIT(Stat,1) THEN                     ! RAM power failure.
680  PRINT "PWR status has been set. WHY?"
690  END IF
700  !
710  !
720  IF BIT(Stat,2) THEN                     ! Front Panel Service.
730  PRINT "FPS status has been set"
740  OUTPUT 707;"Key?"                      ! Asks for key code.
750  ENTER 707;K$                           ! Reads key code.
760  OUTPUT 707;K$                          ! Outputs key code.
770  PRINT "      "&K$
780  END IF
790  !
800  !
810  IF BIT(Stat,3) THEN                     ! Local operation occurred
820  PRINT "LCL operation has occurred"
830  END IF
840  !
850  !

```

```

860 IF BIT(Stat,4) THEN ! Ready bit - only bit active
870 PRINT "Acquisition done !" ! in the Ready byte is Acq done
880 IF Meas_flag=0 THEN ! first time through
890 FOR J=1 TO 16 !
900 ENTER 707;B$(J) ! Reads measurement results
910 PRINT B$(J) ! and prints them.
920 NEXT J
930 Meas_flag=1
940 PRINT
950 PRINT "Press some keys. The key number will be printed."
960 END IF
970 END IF
980 !
990 !
1000 IF BIT(Stat,5) THEN ! Go read the errors.
1010 REPEAT
1020 OUTPUT 707;"ERR?" ! Asks for next error in queue.
1030 ENTER 707;A$ ! Reads error.
1040 PRINT "Error was : ";A$ ! Prints error.
1050 UNTIL VAL(A$[9,12])=0 ! Until error queue is empty.
1060 END IF
1070 !
1080 !
1090 IF BIT(Stat,6) THEN ! A SRQ has been generated.
1100 OUTPUT 707;"REQUEST?" ! Ask for mask value.
1110 ENTER 707;A$ ! Reads mask value.
1120 PRINT A$&" is the mask value" ! Prints mask value.
1130 END IF
1140 !
1150 !
1160 IF BIT(Stat,7) THEN ! Advisory has been initiated.
1170 OUTPUT 707;"DSP?" ! Asks for advisory.
1180 ENTER 707;A$ ! Reads advisory.
1190 PRINT A$&" is the Advisory" ! Prints the advisory.
1200 END IF
1210 !
1220 !
1230 ENABLE INTR 7 ! SRQ disables interrupts.
1240 RETURN ! This reenables them.
1250 !
1260 END

```

Model 54110D - Appendix A

```

10  |
20  | This sample program demonstrates some of the uses of
30  | Service Requests (SRQ's). This set of instructions uses
50  | the Acquisition Done, Local, Front Panel Service,
60  | Ready and Ready masks. An acquisition that will produce
65  | buffered results will be started. When a SRQ is sent the
75  | results will be read and displayed. The scope will then
80  | monitor the front panel keys using SRQ's and echo any
90  | activity. Any Advisories or Acquisitions initiated from
100 | the front panel will be disclosed.
110 |
120 CLEAR 707
130 |
140 PRINTER IS 1                               ! Display is PRINT destination
150 DIM B$(1:16)[30],K$(80),A$(80)
160 |
170 ON INTR 7 GOSUB Srq_svc                     ! Goto 'Srq_svc' on Service Request.
180 ENABLE INTR 7:2                             ! Enables SRQ on bus #7.
190 DISABLE INTR 7                             ! Disables all interuppts on bus #7.
200 |
210 PRINT
220 OUTPUT 707;"RESET"                         ! Resets 54100A/D.
230 OUTPUT 707;"AUTOSCALE"                    ! Does as it says.
240 INTEGER Rqsmask
250 Rqsmask=1024+16+4                           ! Request mask where:
260 |                                           1024 = Acquisition done - bit 10.
270 |                                           16 = Ready - bit 4.
280 |                                           4 = Front Panel Service - bit 2.
290 |                                           Set so bit 10 causes an SRQ
300 OUTPUT 707;"REQUEST";Rqsmask              ! Sends Request Mask.
310 OUTPUT 707;"REQUEST ON"                   ! Sets RQS - bit 6 in Request mask.
320 OUTPUT 707;"LONGFORM ON"                 ! Turns on longform for headers.
330 OUTPUT 707;"HEADER ON"                  ! Turns headers on for queries.
340 Stat=SPOLL(707)                           ! Serial Poll scope, should be 0
350 PRINT "Result of Serial Poll is ";Stat
360 |
370 Meas_flag=0
380 OUTPUT 707;"MEASURE "                     ! Enters MEASURE subsystem.
381 OUTPUT 707;"SOURCE CHANNEL 1"            ! Channel 1 is source for measurement
390 OUTPUT 707;"PRECISION HIGH; ALL?"       ! Sets PRECISION flag high and
400 |                                         measures all.
410 ENABLE INTR 7                             ! Enables interuppts on bus #7.
420 |
430 PRINT " Waiting for measurement to complete."
440 PRINT " Time available for other tasks."
450 PRINT " Bus is available."
460 |
470 GOTO 470                                   ! Loop until Service Request occurs.
480 |

```

```

490 |
500 |
510 | Service Request Interupt Routine
520 |
530 Srq_svc:|
540 Stat=SPOLL(707) | Performs a Serial Poll
550 | | and clears SRQ.
560 INTEGER J
570 PRINT
580 PRINT "Service Request Status=" ;Stat
590 |
600 |
610 IF BIT(Stat,0) THEN | Request Control - 54110D is
620 PRINT "RQC should not be set - PROBLEM" | not a controller and
630 END IF | cannot send a RQC.
640 |
650 |
660 IF BIT(Stat,1) THEN | RAM power failure.
670 PRINT "PWR status has been set. WHY?"
680 END IF
690 |
700 |
710 IF BIT(Stat,2) THEN | Front Panel Service.
720 PRINT "FPS status has been set"
730 OUTPUT 707;"Key?" | Asks for key code.
740 ENTER 707;K$ | Reads key code.
750 OUTPUT 707;K$ | Outputs key code.
760 PRINT " "&K$
770 END IF
780 |
790 |
800 IF BIT(Stat,3) THEN | Local operation occurred
810 PRINT "LOL operation has occured"
820 END IF
830 |
840 |
850 IF BIT(Stat,4) THEN | Ready bit - only bit active
860 PRINT "Acquisition done !" | in the Ready byte is Acq done
870 IF Meas_flag=0 THEN | First time thru?
880 FOR J=1 TO 16 |
890 ENTER 707;B$(J) | Reads measurement results
900 PRINT B$(J) | and prints them.
910 NEXT J
920 Meas_flag=1
930 PRINT
940 PRINT "Press some keys. The key number will be printed out."
950 END IF
960 END IF
970 |
980 |

```

Model 54110D - Appendix A

```
990   IF BIT(Stat,5) THEN
1000     REPEAT
1010       OUTPUT 707;"ERR?"
1020       ENTER 707;A$
1030       PRINT "Error was : ";A$
1040       UNTIL VAL(A$(9,12))=0
1050     END IF
1060     !
1070     !
1080   IF BIT(Stat,6) THEN
1090     OUTPUT 707;"REQUEST?"
1100     ENTER 707;A$
1110     PRINT A$&" is the mask value"
1120   END IF
1130   !
1140   !
1150   IF BIT(Stat,7) THEN
1160     OUTPUT 707;"DSP?"
1170     ENTER 707;A$
1180     PRINT A$&" is the Advisory"
1190   END IF
1200   !
1210   !
1220   ENABLE INTR 7
1230   RETURN
1240   !
1250   END
```

! GO read the errors.
! Asks for next error in queue.
! Reads error.
! Prints error.
! Until error queue is empty.
! A SRQ has been generated.
! Ask for mask value.
! Reads mask value.
! Prints mask value.
! Advisory has been initiated.
! Asks for advisory.
! Reads advisory.
! Prints the advisory.
! SRQ disables interrupts.
! This reenables them.

```
10  ! This sample program demonstrates some of the text commands
20  ! in the Display subsystem.
40  !
50  ! Disable the instrument from writing text to the screen and
60  !   set the colors.
70  !
80  CLEAR 707
90  OUTPUT 707;"DISPLAY MASK 0"  ! Disable the instrument from
100 !                               writing text to the screen
105 OUTPUT 707;"ATTRIBUTE ENABLE" ! Enable embedded attributes
110 OUTPUT 707;"PRIORITY ON"    ! Text overwrites graphics
120 OUTPUT 707;"SETCOLOR DEFAULT" ! Turn on the default colors
130 !
140 ! Write a color block to each position on screen
150 !
160 FOR Row=0 TO 22
170 FOR Column=0 TO 71
180   Attribute=129                ! Use the inverse video attribute
190   Attribute=Attribute+8*((Row+Column) MOD 16) ! Set the color
200   OUTPUT 707;"ROW ";Row;"COLUMN ";Column ! Send row and column
210   ! Output a single character block with its attribute
220   OUTPUT 707 USING "8A,B,2A";"STRING """,Attribute," """
230 NEXT Column
240 NEXT Row
250 !
260 ! To get back to the normal display, turn the instrument off
270 ! and then on again. This resets the display MASK.
290 !
300 END
```

NOTES:

Appendix B

SOFTWARE DELAY CALIBRATION AND TRIGGER DELAY OPTIMIZATION

The trigger delay and channel to channel skew calibrations in the Cal menu on the 54110D are provided to null delay differences in the trigger and data acquisition paths of the trigger and the data. This would include acquisition time differences both internal and external to the instrument.

Channel to channel skew adjustment is used to change the placement of the channel 2 data relative to channel 1 so delay differences in the data acquisition paths do not introduce offsets in channel-to-channel time interval measurements.

Differences in internal delays as well as differences in external delays caused by dissimilar probes, cable lengths etc. can be nulled. This is done by injecting the cal signal at the probe tips or other desired points when performing the calibrations.

The trigger delay calibrations are used to position waveforms horizontally so that the zero reference corresponds with the trigger event. When both the internal and external delays have been compensated for, the instrument provides a timebase delay that is calibrated in an absolute sense to the trigger point. The timebase delay tells you where the display window is located relative to the trigger.

Trigger delay calibrations do not affect channel-to-channel measurements as the vertical inputs are always displayed relative to each other depending on the setting of the ch-to-chCC Skew cal factor. As long as the Ch-to-Ch Skew cal factor is set correctly you can make accurate channel-to-channel measurements even if the trigger delay cal factors are not set correctly.

The delay calibration feature, a consequence of the 54110D's negative time and digital architecture, is convenient for referencing measurements to the probe tips, or other points, even if different types of probes or a probe multiplexer is used. To calibrate a given probe configuration inject a fast risetime signal at the probe tips, or wherever you want your measurement to be referenced and follow the instructions in the Cal menu. Refer to Section 6 for a discussion of the cal menu.

Once the cal procedure is completed the trigger edge will be displayed at the time-zero reference, and if you use an external trigger the time-zero reference will correspond to the time of the trigger event at the Trig 3 or 4 probe tip, or other point of interest. The cal factors are stored in the nonvolatile SAVE/RECALL registers. This allows the instrument to retain calibrations for up to 10 different probe or measurement configurations. By using the time interval measurements built into the 54110D, the display skew and trigger delay cal factors can be determined and programmed via the HP-IB.

The trigger delay calibrations compensate for delays to a first order approximation. Actual trigger delays, in addition to probe length, are function of signal characteristics such as risetime, amplitude, and rep. rate. If these signal characteristics are not the same when making measurements as they were during calibration, the trigger edges will be displaced from time-zero. The error, however, will be small and will rarely result in any confusion as to which edge is the

trigger. For fast risetime signals (<3 ns) this displacement will be less than ± 400 ps. Because of these second order effects it should not be assumed that the trigger edge is at precisely time-zero when making time interval measurements unless the edges are fast and 400 ps error can be tolerated. These effects apply only to trigger delays as channel-to-channel skew has no dependency on signal characteristics.

For signals with slower edge speeds, trigger hysteresis can cause a displacement from time-zero, however, compared to the sweep speed at which the signal would be viewed the displacement usually would be small. Trigger hysteresis on the 54110D is 1 minor division on channels 1 & 2 and 10 mV (with 50 ohm pods) on Trig 3 & 4. The trigger level is at the center of the hysteresis band and the trigger comparator actually begins to switch when the input voltage is 1/2 a minor division from the programmed threshold. This causes the actual threshold crossing to be displaced from time-zero by the amount of time it takes the signal to traverse 1/2 a minor division vertically. The direction of the displacement depends on the trigger slope. At sweep speeds where the signal appears as anything but a near-horizontal line, this displacement is not significant for viewing but can affect time interval measurements if ignored.

With trigger delay calibration captured signals can be correctly plotted relative to the time-zero reference with a small error caused by the second order effects. This applies for the Edge, State, Time-Delayed, and Event-Delayed modes. In the Pattern mode, however, the instrument does not know which input will provide the trigger and does not know which cal factor to use. In this case the average of Channel 1 and Channel 2 trigger delay cal factors is used as a compromise. This will result in a minimal displacement when the trigger edge comes from one of the vertical channels but a large displacement can result if the trigger comes from Trig 3 or 4.

Large delay differences in the signal paths for channel 1 and channel 2 will result in a large displacement, so it is desirable to match these paths as close to one another as possible if an accurate time-zero reference is needed in the pattern mode. Also of concern, when you are in the pattern mode is the relative skew between the inputs. This skew results from delay differences in the acquisition paths internal and external to the instrument. For example, when using the time qualified pattern, skew can cause the pattern true-time seen by the filter timer to be different than the actual time at the probe tips. Just how much skew, or differential delay, exists between paths is reflected in the trigger delay cal factors (assuming the instrument is calibrated) because the cal factor for each input is referenced to the same channel (channel 1). The difference in the cal factors is equal to the amount of skew in the trigger paths. A more negative cal factor means that the trigger path delay for that channel is longer.

The differential delay between channel 1 & 2 and between Trig 3 & 4 is usually less than 400 ps. This assumes the use of 54002A 50 ohm pods and is referenced to the BNC connectors.

The delay through Channel 1 & 2 is nominally 1.6 ns longer than the delay through Trig 3 & 4. This can cause erroneous pattern triggering unless the extra delay is compensated for by inserting extra delay by using longer cables on Trig 3 and Trig 4. Inserting delay(s) to reduce skew for pattern triggering will also reduce time-zero offset in the Pattern mode.

While skew is not of concern with respect to the time-zero reference in other than Pattern mode, it can affect the operation of the other modes. For example, the setup and hold times in the State mode can be different at the probe tips than they are at the instrument's inputs because of dissimilar probes or cable lengths. This is caused by the fact that the trigger circuitry operates on signals in real-time, thus ruling out software calibration.

Appendix C

Detailed Operation of the Automatic Measurements

INTRODUCTION

The automatic parameter and time interval measurements resident in the 54110D are designed to allow you to optimize measurement speed and accuracy for your application. Depending upon a number of factors such as display mode, number of averages, type of measurement, and state of the precision key or the PRECISION flag (HP-IB), the instrument uses different criteria for establishing how much data needs to be acquired for measurement.

DISPLAY MODE CONSIDERATIONS

The measurements are based on the data that is on the screen. The instrument maintains internal copies of the screen data, on which the measurements are made. If the unit is in the Normal mode it uses only the most recent y axis information in each time bucket to make the measurement.

The waveform area of the screen is 256 pixels high by 501 pixels wide. For most measurements 501 time buckets are used, however, if the sweep is faster than 500 ps/div the number of time buckets is equal to $(10 * (\text{time_per_div} / 10 \text{ ps})) + 1$. The reason for this is that the maximum time resolution for the 54110D is 10 ps.

Most of the measurements use 90% criterion. In the normal mode at least 90% of the time buckets have one data point. In the averaged mode the 90% criterion means that at least 90% of the time buckets have received N data points where N is the number of averages.

One method of trading measurement speed for accuracy is to increase the number of averages in average mode. The larger the number of averages, the more time that will be required to make a measurement, but also, the better the accuracy and repeatability.

FINE PRECISION AND COARSE PRECISION MEASUREMENTS

The 54110D performs two types of automatic measurements; coarse and fine (coarse precision and fine precision). Coarse measurements are made based on the data on screen. If there is insufficient data on the screen, then new data is acquired in order to make the measurement. Fine measurements begin with a course measurement to locate the edge(s). Each edge is then expanded to achieve maximum resolution.

The coarse measurements are: the voltage measurements; the front panel start on edge and stop on edge time interval measurements; a high or low instrument is "Stopped", and all HP-IB measurements when the PRECISION flag is low.

The precise measurements are; the front panel Precise Edge Find measurement, the front panel parameter measurements when the instrument is "Running, and HP-IB time related measurements when the PRECISION flag is high.

The coarse measurements are as accurate as the precise measurements when the waveforms are fully expanded (edges at a 45 degree angle) and the display data is 90% complete.

COARSE MEASUREMENTS

As mentioned above, coarse measurements use the data on screen unless there is insufficient data. For front panel coarse measurements only 5 data points need to be present on the screen. For HP-IB coarse measurements the screen data must meet the 90% completion criterion. If the data is insufficient, the instrument acquires new data until the 90% completion criterion is met before the measurement is made.

Coarse measurements are faster but their accuracy, unlike precise measurements depends on the sweep speed. The front panel measurements can be made on very limited amount of data. This is important for single shot signals and low rep rate signals when only a limited amount of data has been acquired.

It is a good programming practice to clear the screen when the input signal is changed before making a coarse measurement. This is especially true when a high number of averages or a long persistence has been selected. (Note: in many cases the screen will be cleared automatically when an instrument setting is changed. The exceptions are changes in settings that don't effect the waveform e.g., moving the time or voltage markers.)

PRECISE MEASUREMENTS

Precise measurements in general, but not always, automatically rescale the timebase to expand signal edges for maximum resolution. This technique provides maximum accuracy and results that are independent of the initial sweep speed setting.

When a precise time interval measurement is made the instrument will first perform a coarse calculation to locate the edge(s) of interest. Next, for each edge, the display window will be positioned so that the edge of interest is at center screen and the sweep speed is increased causing the signal to be expanded on the horizontal axis. The instrument will continue to do this until one of three conditions is met: (1) The slope of the signal is 45 degrees or less. (2) The sweep speed equals 500 ps/div (maximum resolution). (3) Signal jitter at the current sweep speed makes it pointless to increase the sweep speed further. At each faster sweep speed a calculation is made to determine if any of these conditions are met. If so, expansion is stopped and the edge crossing time is determined.

If the sweep speed is 500 ps/div or faster or if the measurement requires only a single edge that already has less than 45 degrees slope as displayed, a precise measurement will revert to a coarse measurement.

LOCATING THE EDGE

The edges are measured at the point where the waveform edge crosses the voltage level. For the time interval measurements the level is defined by the voltage markers. For the parameter measurements, the level is defined by the measurement at 10%, 50%, or 90% level on the waveform relative to the top and base.

The measurement routine uses a dual threshold technique. The upper threshold is defined to be 2 A/D values above the level and the lower threshold is defined to be 2 A/D values below the level.

In terms of the screen, the threshold region is one minor division wide in the full screen mode and half a minor division in the split screen mode. The advantage of this technique is that edges can be determined accurately in the presence of a limited amount of noise.

The edge is determined by performing a linear regression (curve fit) on the points that fall inside the threshold region plus the first point below the threshold region and the first point above the threshold region. The edge crossing is defined as the point where the line generated by the linear regression crosses the level. In many cases, there are no points inside the threshold region and the linear regression becomes a linear interpolation between the two points above and below the threshold region. (e.g., nearly perpendicular edges).

A limitation of this technique is that there are cases which may result in the edge not being found, notably very small signals and measurements made near the top of waveforms.

NOTES:

INDEX

A	PAGE
Abort Message (IFC)	9-11
Abbreviations	10-4
Accessories	1-1
ACQuire	10-33
Acquire Subsystem	10-32
ADD	10-62
Address(HPIB)	9-5
ALL?	10-77
Alpha Arguments	10-5
ARGument	10-11
Attenuation Ratio	6-25, 7-25
ATTRibute	10-47
Attribute Byte	10-46
Auto Pen	6-23
AUToscale	10-12
Auto-Scale	5-2, 6-1
Auto Top-Base	6-14
Auto Trigger	6-5, 7-13
Averaged Display	6-11, 7-21
B	
BLANK	10-12
BLINK	10-47
BRIGHtness	10-48
C	
Cal Menu	6-27
Cal Strings	9-8
CALibrate	10-13
CHANnel/CH	10-38
Channel 1/2 Menus	6-1
Channel Subsystem	10-37
CLEAR	10-13
Clear Display	5-2, 6-11
Clear Message	9-1
COLOR	10-48
Color Cal Menu	6-31
Color Display	4-3
COLumn	10-49

Command Abbreviations.....	10-4
Command Format.....	9-7
Command Order.....	10-5
Command Set.....	10-1
Compatible Plotters.....	8-3
Compatible Printers.....	8-2
COMPLete (Acquire).....	10-34
COMPLete (Waveform).....	10-120
CONDition.....	10-107
Conventions.....	10-4
COUNT/CNT (Acquire).....	10-34
COUNT/CNT (Waveform).....	121
CURSOr.....	10-77

D

DATA (Display).....	10-49
Data Message.....	9-6, 9-8
Data Movement.....	10-129
Data Output Format.....	10-5
DATA (Waveform).....	10-121
Default Settings.....	10-5
Delay.....	6-4, 7-9
Delay Reference.....	6-4
DELay/DLY (Timebase).....	10-95
DELay/DLY (Trigger).....	10-108
Delta t Menu.....	6-15
Delta V Menu.....	6-13
Device listen Address (MLA).....	9-1
Device Clear (DCL).....	9-9
DIGitize.....	10-14
DISPlay.....	10-45
Display Menu.....	6-11
Display Scaling.....	6-20
Display Subsystem.....	10-45
DSP.....	10-14
DURation.....	10-108
DUTYcycle?/DUT?.....	10-78

E

ECL.....	6-3
ECL (HPIB).....	10-38
ENABle.....	10-109
Entry Devices.....	5-3, 7-1
Environmental Conditions.....	3-10, 4-1
EOI.....	10-15
ERASe.....	10-15
ERRor?.....	10-15
Error Numbers.....	10-16
ESTArt.....	10-78
ESTOP.....	10-79

F

FALL..... 10-80
 Format..... 9-7
 FORMat (Display)..... 10-50
 FORMat (Waveform)..... 10-123
 FREQuency? 10-80
 Front Panel..... 5-1
 FUNction 10-61
 Function 1/2..... 6-1, 6-20, 7-26
 Function Subsystem 10-61

G

GET/TRG 10-30
 GRAPh..... 10-65
 Graph Subsystem 10-65
 Graticule..... 6-13, 6-23
 GRATicule 10-51
 GTL (Local Message) 9-9

H

Hardcopy 8-1
 HARDcopy..... 10-69
 Hardcopy Subsystem 10-69
 HEADer 10-17
 HOLDoff 10-109
 GPIB Address Selection..... 4-3, 9-5
 GPIB Compatibility 9-1
 GPIB Default Conditions 9-6
 GPIB Interconnections 4-3, 4-4
 GPIB Interface..... 4-4
 GPIB Menu 6-31
 GPIB Status 9-1
 Hue 6-31

I

ID?..... 10-17
 Inspection 1-3
 INVERse..... 10-51
 INVERt..... 10-62

J

Jitter 7-11

K

KEY	10-17
key Codes	10-18
Key Pad	5-3
Knob	5-3

L

Learn String	9-8
LEVel/LVL	10-110
LINE	10-52
Local	5-2, 9-4
LOCAL	10-19
Local Lockout (LLO)	9-5
Local Message (GTL)	9-9
LOGic	10-110
LONGform	10-19
Luminosity	6-31

M

Magnify	6-3
MAGNify	10-66
MASK	10-53
Math	7-26
Measure	6-22
MEASure	10-76
Measure Subsystem	10-76
Measurement Aids	3-8
Memories	6-13, 6-18
MENU	10-20
Menu Selection	5-3
MERGE	10-20
MLA (Device Listen)	9-9
MODE (Timebase)	10-96
MODE (Trigger)	10-111
More	6-13

N

Normal Mode	6-2
Numeric Arguments	10-5
NWIDth?	10-81

O

OFFSet (Channel)	10-39
OFFSet (Function)	10-62
OFFSet (Timebase)	10-96

ONLY	10-63
OPTion?	10-21
Options	1-3
OVERshoot?	10-81

P

PAGE	10-69
PATH	10-111
Pattern Mode	7-16
Peak-to-Peak Voltage	7-4
PEN	10-70
Pen Speed	6-23
PERiod?	10-82
Persistence	10-54
Pixel Memories	6-17, 6-18, 6-23
PLOT	10-21
Plot Menu	6-23
POINTs/PNTS (Acquire)	10-35
POINTs/PNTS (Waveform)	10-123
Power Cable	1-3, 1-4, 4-3
Power module	4-2
Power Requirements	3-9, 4-1
PREamble	10-124
Precise Edge Find	6-17, 6-18, 7-18
PRECision	10-82
Precision Coarse/Fine	6-22
PREShoot?	10-83
PRINT	10-22
Print Menu	6-25, 8-1
PRiority	10-55
PROBe (Channel)	10-39
PROBe (Trigger)	10-112
Probes	1-2, 6-25, 7-25
Program Format	9-7
Program Order	9-7
PWIDth?	10-83

Q

Query Format	10-5
--------------------	------

R

RANGE (Channel)	10-40
RANGE (Function)	10-63
RANGE (Timebase)	10-97
READY?/RDY?	10-22
Rear Panel	4-2
RECall	10-22
REFerence	10-97

REMOTE	10-23
Remote Enable (REN).....	9-1
Remote Mode	9-1
REQuest/RQS	10-23
Require Service Message (SRQ).....	9-10
RESET/RST	10-24
Reset Conditions	10-25, 10-26
REVision?	10-24
RISE?.....	10-84
ROW.....	10-55
RUN	10-24

S

Safety.....	<i>ii, iii</i> , 1-1
Saturation	6-31
SAVE	10-27
Save/Recall.....	5-2
SENSitivity (Channel).....	10-40
SENSitivity (Timebase)	10-98
SERial?	10-27
Serial Poll (SPE).....	9-10
Serial Poll Disable (SPD)	9-10
SETColor	10-56
SETup	10-27
Setup Aids.....	3-9
SLOPe.....	10-112
SOURce/SRC (Display)	10-57
SOURce/SRC (Hardcopy).....	10-70
SOURce/SRC (Measure).....	10-84
SOURce/SRC (Trigger).....	10-113
SOURce/SRC (Waveform)	10-125
Source to Store	6-18
Specifications	3-1
SPEed	10-71
Split Screen Mode.....	6-12
SPOLI?/STB?.....	10-28
SRQ (Require Service)	9-10
Start Marker	6-15
State Mode	7-19
STATus?	10-28
Status Byte	9-10
Status Word	9-10, 10-6
Step Keys.....	5-3, 6-2
STOP	10-29
Stop/Single Key	5-2
Stop Marker	6-15
STORe.....	10-29
STRing.....	10-58
SUBTract.....	10-63
Supplemental Characteristics.....	3-6
System Commands	10-9
System Control Keys.....	5-1 to 5-3

T

TDELta? 10-85
 TEST/TST..... 10-29
 TEXT..... 10-58
 TIMEbase 10-95
 Timebase Menu 6-4, 6-5
 Timebase Subsystem 10-95
 Time Domain Measurements 7-5
 TMArker 10-58
 TOPBase? 10-85
 TRANsfer/XFER 10-30
 TRG/GET 10-30
 Trg'd Sweep..... 6-5
 Trigger..... 7-15
 TRIGger 10-105
 Trigger Menu..... 6-6
 Trigger Message 9-9
 Trigger Modes..... 6-6 to 6-8
 Trigger Subsystem 10-104
 TSTOp?..... 10-86
 TTL 6-3
 TTL (HPIB)..... 10-41
 TVOLT? 10-87
 TYPE (Acquire) 10-36
 TYPE (Waveform)..... 10-125

U

UNDerline..... 10-59
 Utility Menu..... 6-20

V

VALid? 10-126
 Variable Persistence..... 6-11
 VBASe?..... 10-87
 VDELta? 10-88
 VERSus..... 10-64
 VFIFty 10-88
 VIEW..... 10-31
 VMArker 10-59
 Vmarkers 6-13
 VMIN? 10-89
 Voltage Measurements..... 7-4
 VPP?..... 10-89
 VRELative 10-90
 VRMS? 10-91
 VSTArt 10-91
 VSTOp..... 10-92
 VTIME? 10-92
 VTOP? 10-93

W

WAVEform	10-120
Waveform Subsystem	10-117
Wfm Math (Waveform Math)	6-20, 7-27
Wfm Save (Waveform Save)	6-17
Window	6-3

X

XFER/TRANSfer	10-30
XINCrement?	10-126
XORigin?	10-126
XREFerence?	10-127

Y

YINCrement?	10-127
YOFFset	10-67
YORigin?	10-127
YRANge	10-67
YREFerence	10-128

1
2
3
4
5
6
7
8
9
10
11
12
13
14
15
16
17
18
19
20
21
22
23
24
25
26
27
28
29
30
31
32
33
34
35
36
37
38
39
40
41
42
43
44
45
46
47
48
49
50
51
52
53
54
55
56
57
58
59
60
61
62
63
64
65
66
67
68
69
70
71
72
73
74
75
76
77
78
79
80
81
82
83
84
85
86
87
88
89
90
91
92
93
94
95
96
97
98
99
100

MANUAL CHANGES

MANUAL IDENTIFICATION

Model Number: 54110D
 Date Printed: JUNE 1988
 Part Number: 54110-90901

This supplement contains important information for correcting manual errors and for adapting the manual to instruments containing improvements made after the printing of the manual.

To use this supplement:
 Make all ERRATA corrections.
 Make all appropriate serial number related changes indicated in the tables.

Serial Prefix or Number	Make Manual Changes	Serial Prefix or Number	Make Manual Changes
2826A and above	1		

► NEW ITEM

Change 1

Page 6-24.

Replace: Pages 6-24, 6-25, 6-30, and 6-32 with the revised pages.

Chapter 8.

Replace: Chapter 8 with the revised chapter 8.

Page 10-22.

Delete: The Print command.

Add: Page 10-22A, the revised print command.

NOTE

Manual change supplements are revised as often as necessary to keep manuals as current and accurate as possible. Hewlett-Packard recommends that you periodically request the latest edition of this supplement. Free copies are available from all HP offices. When requesting copies quote the manual identification information from your supplement, or the model number and print date from the title page of the manual.

Page 10-51.

Delete: The Color command.

Add: Page 10-51A the revised Color command.

Page 10-73.

Replace: Page 10-73 with the revised page 10-73.

Page 10-74.

Add: Page 10-74A, the Hardcopy Printer command.

Free Manuals Download Website

<http://myh66.com>

<http://usermanuals.us>

<http://www.somanuals.com>

<http://www.4manuals.cc>

<http://www.manual-lib.com>

<http://www.404manual.com>

<http://www.luxmanual.com>

<http://aubethermostatmanual.com>

Golf course search by state

<http://golfingnear.com>

Email search by domain

<http://emailbydomain.com>

Auto manuals search

<http://auto.somanuals.com>

TV manuals search

<http://tv.somanuals.com>