

**HP 8118A
100 MBIT/S
PULSE/PATTERN
GENERATOR**

**OPERATING and
PROGRAMMING MANUAL**

Serial Numbers:

This manual applies to all instruments.



**HEWLETT
PACKARD**

**Edition 1
E0988**

**Manual Part Number: 08118-90011
Microfiche Part Number: 08118-95011
Printed in FRG, 09/88**

RANDOMIZE

Data **[Entry]** -----

Display **[both Channels]** Base: **[Bin]** Cursor on Word : **[]**
 Words : 2 Cursor on Digit: **[X]**
 Digits: 20

----- Channel 1 ----- Channel 2 -----

Word Digit → 0 0
 ↓ ↓ ↓

0 1111111111 1111111111 1111111111 1111111111
 1← **[XXXXXXXXXX]** **[XXXXXXXXXX]** **[XXXXXXXXXX]** **[XXXXXXXXXX]**

[RANDOMIZE] **[Channel 1]** from Word **[0]** through **[1]**

EDITOR KEY

BLUE/MODIFY

FIELDS

Channel selection:
 [Channel 1]
 [Channel 2]
 [both Channels]

'from':
 '_(1)'

'through':
 '_(2)'

EXECUTION

EXEC key

SET

DEFINITION

All bits within the block specified by the 'from' and 'through' fields are set to one.

'from' word < 'through' word

EXAMPLE

In the figure on the following page:

Channel:	1	2
Before setting:	000000	000000
After setting:	111111	000000

If the set function applies to one channel, no change occurs to the other channel as illustrated by channel 2 in the example above.

SET

Data **[Enter]** -----

Display **[Both Channels]** Base: **[Bin]** Cursor on Word : **[]**
 Words : 1 Cursor on Digit: **[]**
 Digits: 6

----- Channel 1 ----- Channel 2 -----

Word Digit → 0 0
 ↓ ↓ ↓

←

[000000]

[000000]

[SE]

[Channel 1] from Word **[0]** through **[4]**

EDITOR KEY

BLUE/MODIFY

FIELDS

Channel selection:
 [Channel 1]
 [Channel 2]
 [both Channels]

'from':
 '_(1)'

'through':
 '_(2)'

EXECUTION

EXEC key

CHAPTER 10

EDITOR BIT MODE

CONTENTS

ALPHA LIST

Clear
Copy Digit
Delete Digit
Insert Digit
Move Digit
Randomize Digit
Set

KEY LIST

COPY

Copy Digit

DELETE

Delete Digit

INSERT

Insert Digit

MODIFY

Clear
Randomize
Set

MOVE

Move Digit

CLEAR

DEFINITION

All bits within the block of digits specified by the 'from' and 'through' fields are cleared to zero.

'from' digit < 'through' digit

EXAMPLE

In the figure on the opposite page:

Channel:	1
Before clearing:	1111111111
After clearing:	0000011111

If the clear function applies to one channel, no changes are made to the other channel as illustrated by channel 2 in the example above.

CLEAR

Data [Empty] -----
Display [Channel 1] Base: [Bin] Cursor on Digit: []
Digits: 10 ----- Channel 1 -----
Digit
↓

← []

[CLEAR] from Digit [0] through [4]

EDITOR KEY

BLUE/MODIFY

FIELDS

Channel selection:
[Channel 1]
[Channel 2]
[both Channels]

'from':
'Digit_(1)'
'through':
'_(2)'

EXECUTION

EXEC key

COPY DIGIT

DEFINITION

The digits specified by the 'from' and 'through' fields are copied to the 'to' channel beginning at the digit specified by the 'to' field.

'from' digit < 'through' digit

The copy function can not increase the number of digits in the frame. Thus, the digits copied must be copied to locations within the current frame. Copying writes over or replaces the old data. Thus, the old data is destroyed.

EXAMPLE

In the figure on the opposite page:

Channel:	1	2
Before copying:	001111	111111
After copying:	001100	111111

In the example, the copy function cannot begin at digit 5 because the frame does not contain enough digits in which to copy digits zero and one.

If the copy function applies to one channel, no change occurs in the other channel as illustrated by channel 2 in the example above.

COPY DIGIT

Data **[Enter]** -----
Display **[both Channels]** Base: **[Hex]** Cursor on Digit: **[2]**
Digits: 6 ----- Channel 1 ----- Channel 2 -----
Digit
↓

0← **[0000]** **[0000]**

COPY Digit from **[Channel 1]** **[0]** through **[1]**
to **[Channel 1]** **[4]**

EDITOR KEY

BLUE/COPY

FIELDS

Channel selection:
[Channel 1]
[Channel 2]

'from':
'_(1)_ through _(2)_'

'to':
'_(3)_'

EXECUTION

EXEC key

DELETE DIGIT

DEFINITION

The digits from the digit pointed to by the 'Cursor on Digit' field to the 'through' field are deleted.

The following relationship applies:

'Cursor on Digit' < 'through' digit

The number of bits in the frame is reduced by the number of bits deleted.

The following relationship applies:

digits deleted \leq (No. of Bits - 3), that is,
 $3 \leq$ 'No. of Bits' \leq 16384

EXAMPLE

In the figure on the opposite page:

Cursor on Digit = 0

Channel:	1	2
Before delete:	001111	111100
After delete:	1111	1111

If the delete function applies to only one channel, the other channel is reduced by the same number of digits at the end of its frame as illustrated by channel 2 in the example above.

DELETE DIGIT

Data [Entry] -----
Display [both Channels] Base: [Bin] Cursor on Digit: [0]
Digits: 6 ----- Channel 1 ----- Channel 2 -----
Digit
↓

0←

000000

111100

DELETE Digit at [Channel 1] through [1]

EDITOR KEY

BLUE/DELETE

FIELDS

Channel selection:
[Channel 1]
[Channel 2]
[both Channels]

'through':
'_(1)_'

EXECUTION

EXEC key

INSERT DIGIT

DEFINITION

A specified number of 'zero' digits are inserted before the digit pointed to by the 'Cursor on Digit' field.

The number of bits in the frame is increased by the number of bits inserted, however, the following relationship applies:

3 bits \leq 'No. of Bits' \leq 16834 bits

EXAMPLE

In the figure on the opposite page:

Cursor on Digit = 0

Channel:	1	2
Before insert:	111111	111111
After insert:	0111111	1111110

If the insert function applies to one channel, a 'zero' digit is appended to channel 2 as illustrated in the example above.

INSERT DIGIT

Data **[Entry]** -----
 Display **[both Channels]** Base: **[Bin]** Cursor on Digit: **[2]**
 Digits: 6 ----- Channel 1 ----- Channel 2 -----
 Digit
 ↓

0←

[11111]

[11111]

INSERT Digit at **[Channel 1]** **[1]** times

EDITOR KEY

BLUE/INSERT

FIELDS

Channel selection:
 [Channel 1]
 [Channel 2]
 [both Channels]

Number of digits
 to be inserted:
 '_(1)_ times'

EXECUTION

EXEC key

MOVE DIGIT

DEFINITION

The digits specified by the 'from' and 'through' fields are transferred to a new location within the current frame. The location begins in front of the digit specified by the 'to' field.

'from' digit < 'to' digit

The digit specified by the 'to' field cannot be a digit specified by the 'from' and 'through' fields; otherwise, a 'range overlap' error occurs.

EXAMPLE 1

A forward move is illustrated in the figure on the opposite page:

Base [HEX]
'to' field = 1

	DIGIT	CH.1	CH.2
Before moving:	0	ABCDEF	ABCDEF
After moving:	0	ADEFBC	ABCDEF

If the move function applies to only one channel no change occurs to the other channel as illustrated by channel 2 in the example above.

MOVE DIGIT

Data [Entry 1] -----
 Display [both Channels] Base: [Hex] Cursor on Digit: [2]
 Digits: 7 ----- Channel 1 ----- Channel 2 -----
 Digit
 ↓

←

ABCDEF

ABCDEF

MOVE Digit from [Channel 1] [4] through [5]
 to [1]

EDITOR KEY

BLUE/MOVE

FIELDS

Channel selection:
 [Channel 1]
 [Channel 2]
 [both Channels]

'from':

'_(1)_ through _(2)_'

'to':

'_(3)_'

EXECUTION

EXEC (image)
 UPDATE (active)

MOVE DIGIT

EXAMPLE 2

A backward move is illustrated in the figure on the opposite page.

Base [HEX]
'to' field = 6

	DIGIT	CH.1	CH.2
Before moving:	0	ABCDEF	ABCDEF
After moving:	0	DEFBCA	ABCDEF

If the move function applies to one channel, no changes occur in the other channel as illustrated by channel 2 in the example above.

MOVE DIGIT

Data [Entry] -----
Display [both Channels] Base: [Hex] Cursor on Digit: [0]
Digits: ? Channel 1 Channel 2
Digit
↓

←

[0123456789A]

[0123456789A]

MOVE Digit from [Channel 1] [1] through [2]
to [6]

EDITOR KEY

BLUE/MOVE

FIELDS

Channel selection:
[Channel 1]
[Channel 2]
[Both Channels]

'from':

'_(1)_ through _(2)_'

'to':

'_(3)_'

EXECUTION

EXEC (image)
UPDATE (active)

RANDOMIZE

DEFINITION

The bits within the block of digits specified by the 'from' and 'through' fields are assigned values from sequences with lengths generated according to the following formula:
Length = $((2^{\text{exponent } n}) - 1)$ bits.

'from' bit < 'through' bit

A pseudo-random binary sequence, PBRs, is assigned when the bit length of the block equals $((2^{\text{exponent } n}) - 1)$ bits, where $2 \leq n \leq 14$.

The start value for the random generator is defined by the first n-bits of the block, where n is the exponent from the expression $((2^{\text{exponent } n}) - 1)$. The start value cannot equal zero.

The value for n is the smallest value substituted into the expression that yields a result which is equal to or greater than the number of bits in the block.

EXAMPLE

In the figure on the opposite page:

block length = 20 (bits 0 - 19)
 $n = 5, (2^{\text{exponent } n}) - 1 = 31 > 20$
start value = 11111

Channel:		1
Before randomizing:	1111111111	1111111111
After randomizing:	1111100110	1001000010

If the randomize function applies to one channel, no changes are made to the other channel.

RANDOMIZE

Data **[Enter]** -----

Display **[Channel 1]** Base: **[Hex]** Cursor on Digit: **[0]**

Digits: 20 ----- Channel 1 -----

Digit
↓

0← **[XXXXXXXXXX]** **[XXXXXXXXXX]**

[RANDOMIZE] from Digit **[0]** through **[19]**

EDITOR KEY

BLUE/MODIFY

FIELDS

Channel selection:
[Channel 1]
[Channel 2]
[both Channels]

'from':
'Digit (1)'

'through':
'(2)'

EXECUTION

EXEC key

SET

DEFINITION

All bits within the block of digits specified by the 'from' and 'through' fields are set to one.

'from' bit < 'through' bit

EXAMPLE

In the figure on the opposite page:

Channel:	1	2
Before setting:	0000000000	0000000000
After setting:	1111100000	0000000000

If the set function applies to one channel, no changes are made to the other channel as illustrated by channel 2 in the example above.

SET

Data **[Enter]** -----
Display **[Both Channels]** Base: **[HEX]** Cursor on Digit: **[0]**
Digits: 10 ----- Channel 1 ----- Channel 2 -----
Digit
↓

←

[XXXXXXXXXX]

[XXXXXXXXXX]

[SET]

[Channel 1] from Digit **[0]** through **[4]**

EDITOR KEY

BLUE/MODIFY

FIELDS

Channel selection:
[Channel 1]
[Channel 2]
[both Channels]

'from':
'Digit_(1)'

'through':
'_(2)'

EXECUTION

EXEC key

CHAPTER 11 COMMON COMMANDS

MNEMONIC	NAME
*CLS	Clear Status
*ESE	Standard Event Status Enable
*ESE?	Standard Event Status Enable Query
*ESR?	Standard Event Status Register Query
*IDN?	Identification Query
*LRN?	Learn Device Setup Query
*OPC	Operation Complete
*OPC?	Operation Complete Query
*RCL	Recall
*RST	Reset
*SAV	Save
*SRE	Service Request Enable
*SRE?	Service Request Enable Query
*STB?	Read Status Byte Query
*TRG	Trigger
*TST?	Self Test Query
*WAI	Wait to Continue

*CLS

CLEAR STATUS COMMAND

-----*CLS-----

DEFINITION

The *CLS command clears the following:

1. Error queue
2. Standard event status register (ESR)
3. Status byte register bit 5 (STB)
4. A service request
5. OCAS and OQAS

No changes are made to the following:

1. Status byte register bits 6, 4, 2-0 (STB)
2. Output queue
3. Event status enable register (ESE)
4. Service request enable register (SRE)

State:

1. IDLE state
2. Setting prior to *CLS
3. *OPC/*OPC? actions are cancelled.

If the *CLS command occurs directly after a program message terminator, the output queue and MAV, bit 4, in the status byte register are cleared, and if condition bits 2-0 of the status byte register are zero, MSS, bit 6 of the status byte register is also zero.

Related commands: none

EXAMPLE

OUTPUT 718:!"*CLS"

STANDARD EVENT STATUS ENABLE COMMAND

-----*ESE-----<value>-----

0 <= value <= 255

DEFINITION

The *ESE command sets bits in the standard event status enable register (ESE) which enable the corresponding bits in the standard event status register (ESR).

The register is cleared:

1. At power-on
2. By sending a value of zero

The register is not changed by the *RST and *CLS commands.

<u>BIT</u>	<u>MNEMONIC</u>	<u>BIT VALUE</u>
7	PON	128
6	Not used	0
5	CME	32
4	EXE	16
3	DDE	8
2	QYE	4
1	Not used	0
0	OPC	1

Related commands: *ESE?

EXAMPLE

OUTPUT 718; " *ESE 21"

*ESE?

STANDARD EVENT STATUS ENABLE QUERY

-----*ESE?-----

DEFINITION

The standard event status enable query returns the contents of the standard event status enable register.

0 <= contents <= 255

<u>BITS</u>	<u>MNEMONICS</u>	<u>BIT VALUE</u>
7	PON	128
6	Not used	0
5	CME	32
4	EXE	16
3	DDE	8
2	QYE	4
1	Not used	0
0	OPC	1

Related commands: *ESE

EXAMPLE

```
OUTPUT 718; "*ESE?"  
ENTER 718: A$
```

*ESR?

STANDARD EVENT STATUS REGISTER QUERY

-----*ESR?-----

DEFINITION

The standard event status register query returns the contents of the standard event status register. The register is cleared after being read.

0 <= contents <= 255

<u>BITS</u>	<u>MNEMONICS</u>	<u>BIT VALUE</u>
7	PON	128
6	Not used	0
5	CME	32
4	EXE	16
3	DDE	8
2	QYE	4
1	Not used	0
0	OPC	1

Related commands: *ESR

EXAMPLE

OUTPUT 718;"*ESR?"
ENTER 718: A\$

*IDN?

IDENTIFICATION QUERY

-----*IDN?-----

DEFINITION

The identification query commands the instrument to identify itself over the interface.

Response: HEWLETT-PACKARD, 8118A, 0, 1.0

HEWLETT-PACKARD	=	manufacturer
8118A	=	instrument model number
0	=	indicates serial numbers are not provided.
1.0	=	firmware revision level

EXAMPLE

```
DIM A$ [100]
OUTPUT 718; "*IDN?"
ENTER 718; A$
```

LEARN DEVICE SETUP QUERY

-----*LRN?-----

DEFINITION

The learn query returns the status of the instrument's setting.

The response message can be retransmitted as a program message without requiring any alterations.

Only commands relevant to the instrument configuration at the time of the *LRN? query are returned.

The returned commands are listed in Tables 11-1 and 11-2.

The learn response message is a single ASCII string without image specifiers. The format of Tables 11-1 and 11-2 is for legibility only.

EXAMPLE

```
DIM A$ [25000]
OUTPUT 718; "*LRN?"
ENTER 718; A$
```

*LRN?

TABLE 11-1. PULSE *LRN?

:SYST	:GEN
:INP:TRIG	:STAT :MODE :SLOP :THR
:INP:CONT	:STAT :MODE :RANG
:PULS:TIM	:PER
:PULS1:TIM	:WIDT :DEL :DOUB :DOUB:MODE
:PULS2:TIM	:WIDT :DEL :DOUB :DOUB:MODE

***LRN?**

:PULS1:LEV :AMPL
 :OFFS
 :LIM

:PULS2:LEV :AMPL
 :OFFS
 :LIM

:PULS1:EDGE :TRAN
 :LEAD
 :TRA

:PULS2:EDGE :TRAN
 :LEAD
 :TRA

:OUTP2:PULS :POL
 :STAT

:OUTP1:PULS :POL
 :ADD
 :STAT

*LRN?

TABLE 11-2. PATTERN *LRN?

:SYST	:GEN
:INP:TRIG	:STAT :MODE :STAR :STOP :THR
:INP:CONT	:STAT :MODE :RANG
:INP:CLOC	:STAT
:PULS:TIM	:PER
:PULS1:TIM	:WIDT :DEL
:PULS2:TIM	:WIDT :DEL
:PULS3:TIM	:WIDT :DEL
:PULS1:LEV	:AMPL :OFFS :LIM

***LRN?**

:PULS2:LEV	:AMPL :OFFS :LIM
:PULS1:EDGE	:TRAN :LEAD :TRA
:PULS2:EDGE	:TRAN :LEAD :TRA
:DATA3	:STR
:DATA	:CYCL :MODE :LENG :BRE :BRE:ADDR
:DATA1	:FORM :PATT
:DATA2	:FORM :PATT
:DATA	:UPD
:OUTP2:PULS	:POL :STAT
:OUTP1:PULS	:POL :ADD :STAT

***OPC**

OPERATION COMPLETE COMMAND

-----*OPC-----

DEFINITION

The instrument parses all program message units in the message and after a wait period of two seconds, sets the operation complete bit in the standard event status register (ESR).

Related commands: *OPC?, *WAI

EXAMPLE

OUTPUT 718;"*CLS;*ESE 1;*SRE 32"
OUTPUT 718;"*OPC"

***OPC?**

OPERATION COMPLETE QUERY

-----*OPC?-----

DEFINITION

The instrument parses all program message units in the message and after a wait period of two seconds, places an ASCII '1' in the output queue.

Related commands: *OPC, *WAI

EXAMPLE

OUTPUT 718;"*OPC?"
ENTER 718;A\$

*RCL

RECALL COMMAND

-----*RCL-----<location>-----

0 <= location <= 4

DEFINITION

A setting stored in RAM is made the instrument setting.

The instrument can store five settings, locations 0-4.

The hardware is automatically updated for all parameters that are part of the recalled setting.

The *RCL command is identical to 'recall' at the save internal display.
See Chapter 8, RECALL (internal).

Related commands: *SAV

EXAMPLE

OUTPUT 718,"*RCL 3"

RESET COMMAND

-----*RST-----

DEFINITION

The reset setting (standard setting) stored in ROM is made the instrument setting.

Updating is automatic for all parameters of the standard setting.

Pending *OPC/*OPC? actions are cancelled

Instrument state: the instrument is placed in the IDLE state awaiting a command.

The *RST command clears the key queue.

The following are not changed:

1. HP-IB (interface) state
2. Instrument interface address
3. Output queue
4. Service request enable register (SRE)
5. Standard event status enable register (ESE)

The commands and parameters of the reset state are listed in the following table.

Related commands: none

EXAMPLE

OUTPUT 718: "RST"

*RST

TABLE 11-3. RESET STATE

<u>COMMANDS</u>	<u>PARAMETERS</u> (DEFAULTS)	<u>CHANNEL</u>
:INPUT		
:TRIG		
:STAT	OFF	
:MODE	AUTO	
:SLOP	POS	
:STAR	POS	
:THRE	+2.4V	
:CONT		
:STATE	OFF	
:MODE	DEL	
:RANG	99.9 ns	
:CLOC		
:STAT	OFF	
:PULS		
:TIM		
:PER	1.00ms	
:WIDT	100us	1/2/3
:DEL	75.0ns	1/2/3
:DOUB	200.0us	1/2
:MODE	OFF	1/2
:LEV		
:HIGH	1.00V	1/2
:LOW	0.00V	1/2
:AMPL	1.00V	1/2
:OFFS	0.500V	1/2
:LIM	OFF	1/2
:EDGE		
:TRAN	LIN	1/2
:LEAD	10.0ns	1/2
:TRA	10.0ns	1/2

*RST

COMMANDS

PARAMETERS

CHANNEL

:DATA

:STR	BIT	3
:FORM	RZ	1/2
:CYCL	AUTO	
:MODE	WORD	
:LENG	8,2048	!!WORD MODE!!
:LENG	16384	!!BIT MODE!!
:BRE	OFF	
:ADDR	7,2047	!!WORD MODE!!
:ADDR	16383	!!BIT MODE!!

:OUTP

:PULS		
:STAT	OFF	1/2
:POL	NORM	1/2
:ADD	OFF	1

:SYST

:GEN	PULS	
:BEEP	OFF	

NOTE: Channel 1 and 2 pattern data are cleared to zero.

***SAV**

SAVE COMMAND

-----*SAV-----<location>-----

0 <= location <= 4

DEFINITION

The instrument setting is stored in RAM.

The instrument can store five settings, locations 0-4.

The scope of the saved setting is identical to the scope of the standard setting except that the pulse generator settings do not contain the pattern generator related parameters.

The *SAV command is identical to 'Save' at the internal display.
See Chapter 8, SAVE (internal).

Related commands: *RCL

EXAMPLE

OUTPUT 718; "*SAV 3"

SERVICE REQUEST ENABLE REGISTER

-----*SRE-----<value>-----

0 <= value <= 255

DEFINITION

The service request enable command sets bits in the service request enable register which enable the corresponding status byte register bits

The register is cleared:

1. At power-on
2. By sending a value of zero.

The register is not changed by the *RST and *CLS commands.

<u>BITS</u>	<u>MNEMONICS</u>	<u>BIT VALUE</u>
7	Not used	0
6	RQS/MSS	64
5	ESB	32
4	MAV	16
3	Not used	0
2	S	4
1	H	2
0	W	1

Related commands: *SRE?, *STB?

EXAMPLE

OUTPUT 718;"*SRE 48"

***SRE?**

SERVICE REQUEST ENABLE QUERY

-----*SRE?-----

DEFINITION

The service request enable query returns the contents of the service request enable register.

0 <= contents <= 255

Related commands: *SRE, *STB?

EXAMPLE

OUTPUT 718; "*SRE?"
ENTER 718; A\$

*STB?

READ STATUS BYTE QUERY

-----*STB?-----

DEFINITION

The read status byte query returns the contents of the status byte register.

0 <= contents <= 255

The MSS message is reported in bit six of the status byte register.

<u>BITS</u>	<u>MNEMONICS</u>	<u>BIT VALUE</u>
7	Not used	0
6	MSS/RQS	64
5	ESB	32
4	MAV	16
3	Not used	0
2	S	4
1	H	2
0	W	1

Related commands: *SRE, *SRE?

EXAMPLE

```
OUTPUT 718; " *STB?"  
ENTER 718; A$
```

*TRG

TRIGGER COMMAND

-----*TRG-----

DEFINITION

The trigger command has the same effect as a GROUP EXECUTE TRIGGER (GET).

Pulse generator: If the trigger mode 'trigger' is selected, a trigger event occurs, and one pulse or double pulse is generated.

Pattern generator, a START event is generated and cycling begins.

<u>BITS</u>	<u>MNEMONICS</u>	<u>BIT VALUE</u>
7	Not used	0
6	MSS	64
5	ESB	32
4	MAV	16
3	Not used	0
2	S	4
1	H	2
0	W	1

Related commands: GET (interface command)

EXAMPLE

OUTPUT 718; " *TRG "

***TST?**

SELF-TEST QUERY

-----*TST?-----

DEFINITION

The self-test query commands the instrument to perform a self-test and place the results of the test in the output queue. The pattern generator must be in the stopped state before the test can be run.

Returned value: 0 <= value <= 657.

A value of zero indicates no errors.

Explanations of the non-zero results of the self-test are given in Appendix F, Table F-1.

No entries are allowed while the test is running.

The instrument is returned to the setting that was active at the time the self-test query was processed.

The self-test does not require operator interaction beyond sending the *TST? query.

Related command: none

EXAMPLE

OUTPUT 718; "*TST?"
ENTER 718; A\$

***WAI**

WAIT-TO-CONTINUE-COMMAND

-----*WAI-----

DEFINITION

The wait-to-continue command prevents the instrument from executing any further commands for two seconds. All pending operations are completed during the wait period.

Related commands: *OPC, *OPC?

EXAMPLE

OUTPUT 718; "WAI"

CHAPTER 12

DEVICE

COMMANDS

:DATA

<u>COMMAND</u>	<u>PARAMETER</u>	<u>PULS</u>	<u>PATT</u>	<u>STOP</u>	<u>UPD</u>
:DATA					
:BREak	ON OFF 1 0	-	X	-	X
:ADDRes	<value>[,<value>]	-	X	-	X
:ADDRes?		-	X	-	-
:BREak?		-	X	-	-
:CYCLing	AUTO SINGle	-	X	-	-
:CYCLing?		-	X	-	-
:FORM	RZ NRZ DNRZ	-	X	X	-
:FORM?		-	X	-	-
:LENGth	<value>[,<value>]	-	X	-	X
:LENGth?		-	X	-	-
:MODE	BIT WORD	-	X	-	X
:MODE?		-	X	-	-
:PATTern	<value>,<data>	-	X	-	X
:PATTern?		-	X	-	-
:STRobe	BIT WORD FSTart FEND	-	X	-	X
:STRobe?		-	X	-	-
:UPDate		-	X	X	-

:INPut

<u>COMMAND</u>	<u>PARAMETER</u>	<u>PULS</u>	<u>PATT</u>	<u>STOP</u>	<u>UPD</u>
:INPut					
:CLOCK					
:STATE	ON OFF 1 0	-	X	X	-
:STATE?		-	X	-	-
:CONTROL					
:MODE	PERiod DELay WIDth HLEVel	X	X	-	-
:MODE?		X	X	-	-
:RANGE	<value> MIN MAX	X	X	-	-
:RANGE?		X	X	-	-
:STATE	ON OFF 1 0	X	X	-	-
:STATE?		X	X	-	-
:TRIGGER					
:CONTINUE		-	X	-	-
:MODE	AUTO TRIG GATE	X	X	-	-
:MODE?		X	X	-	-
:SLOPE	POSitive NEGative BOTH	X	-	-	-
:SLOPE?		X	-	-	-
:SSTEP		-	X	X	-
:START	IMMediate POSitive NEGative BOTH	-	X	-	-
:START?		-	X	-	-
:STATE	ON OFF 1 0	X	X	-	-
:STATE?		X	X	-	-
:STOP		-	X	-	-
:THRESHOLD	<value> MIN MAX	X	X	-	-
:THRESHOLD?		X	X	-	-

:OUTPut

<u>COMMAND</u>	<u>PARAMETER</u>	<u>PULS</u>	<u>PATT</u>	<u>STOP</u>	<u>UPD</u>
:OUTPut					
:PULSe					
:ADDition	ON OFF 1 0	X	X	-	-
:ADDition?		X	X	-	-
:POLarity	NORMAl COMPLement	X	X	-	-
:POLarity?		X	X	-	-
:STATe	ON OFF 1 0	X	X	-	-
:STATe?		X	X	-	-

:PULSe

<u>COMMAND</u>	<u>PARAMETER</u>	<u>PULS</u>	<u>PATT</u>	<u>STOP</u>	<u>UPD</u>
:PULSe					
:EDGE					
:LEADing	<value> MIN MAX	X	X	-	-
:LEADing?		X	X	-	-
:TRAILing	<value> MIN MAX	X	X	-	-
:TRAILing?		X	X	-	-
:TRANSition	LINEar GAUSSian FIXEd	X	X	-	-
:TRANSition?		X	X	-	-
:LEVel					
:AMPLitude	<value> MIN MAX	X	X	-	-
:AMPLitude?		X	X	-	-
:HIGH	<value> MIN MAX	X	X	-	-
:HIGH?		X	X	-	-
:LIMit	ON OFF 1 0	X	X	-	-
:HIGH?		X	X	-	-
:LOW?		X	X	-	-
:AMPLitude?		X	X	-	-
:OFFSet?		X	X	-	-
:LIMit?		X	X	-	-
:LOW	<value> MIN MAX	X	X	-	-
:LOW?		X	X	-	-
:OFFSet	<value> MIN MAX	X	X	-	-
:OFFSet?		X	X	-	-
:TIMing					
:DELay	<value> MIN MAX	X	X	-	-
:DELay?		X	X	-	-
:DOUBle	<value> MIN MAX	X	-	-	-
:MODE	ON OFF 1 0	X	-	-	-
:MODE?		X	-	-	-
:DOUBle?		X	-	-	-
:PERiod	<value> MIN MAX	X	X	-	-
:PERiod?		X	X	-	-
:WIDTh	<value> MIN MAX	X	X	-	-
:WIDTh?		X	X	-	-

:SYSTem

<u>COMMAND</u>	<u>PARAMETER</u>	<u>PULS</u>	<u>PATT</u>	<u>STOP</u>	<u>UPD</u>
:SYSTem					
:BEEPer	ON OFF 1 0	X	X	-	-
:BEEPer?		X	X	-	-
:DERRor?	[NUMeric STRing]	X	X	-	-
:ERRor?	[NUMeric STRing]	X	X	-	-
:GENerator	PULSe PATTern	X	X	-	-
:GENerator?		X	X	-	-
:KEY	<mnemonic>	X	X	-	-
:KEY?		X	X	-	-
:RUNing?		-	X	-	-
:SET	<data>	X	X	X	-
:SET?		X	X	-	-

:DATA

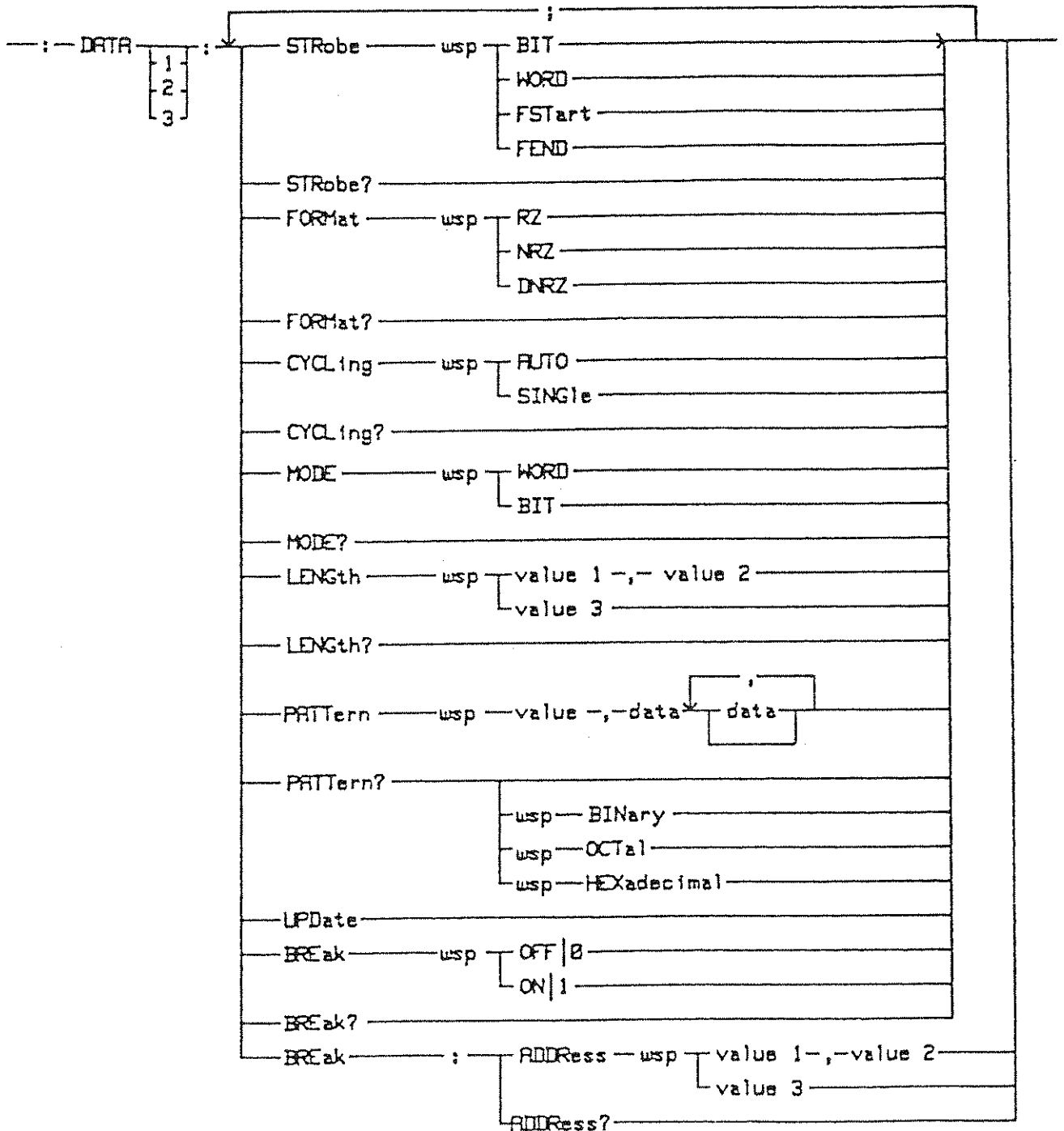

:DATA<channel>

:DATA

Bypass

No channel specified

Application:

FORM and PATT commands: Channel 1/Output 1

STR command: not allowed

All other commands: allowed

1

Channel 1 (Output 1)

Application:

FORM and PATT commands: Channel 1/Output 1

STR command: not allowed

All other commands: allowed

2

Channel 2 (Output 2)

Application:

FORM and PATT commands: Channel 2/Output 2

STR command: not allowed

All other commands: allowed

3

Channel 3 (Strobe)

Application:

FORM and PATT commands: not allowed

STR command: required

All other commands: not allowed

:DATA:BRERak

:BRERak

OFF = 0, default mode

The break function is disabled.

ON = 1

The break function is enabled.

Execution: the :DATA:UPD command is required to change the hardware.

Display: Data Format (Break)

:BRERak?

Response: 1 or 0

EXAMPLE:

OUTPUT 718;":DATA:BRER ON"

OUTPUT 718;":DATA:UPD"

!!Change the hardware!!

OUTPUT 718;":DATA:BRER?

ENTER 718;A\$

:DATA:BRBreak:ADDRESS

:BRBreak:ADDRESS

value 1 (Frame Mode = Word)

0 <= Break Bit <= (Word Length - 1)

Default: 7

Value 1 specifies which bit in the word is the break bit. Value 1 is not coupled to value 3.

value 2 (Frame Mode = Word)

0 <= Break Word <= (No. of Words - 1)

Default: 2047

Value 2 specifies which word is the break word.

value 3 (Frame Mode = Bit)

0 <= Break Bit <= (No. of Bits - 1)

Default: 16383

Value specifies which bit is the break bit. Value 3 is not coupled to value 1.

Execution: the :DATA:UPD command is required to change the hardware.

Display: Data Format (Break)

:DATA:BRake:ADDRess?

:BRake:ADDRess?

Response: frame specification in integer form
for the current mode, for example,
word mode = 7,2047 / bit mode = 16383.

EXAMPLE:

OUTPUT 718;":DATA:BRake:ADDR 7,2047"

or

OUTPUT 718;":DATA:BRake:ADDR 16383"

OUTPUT 718;":DATA:UPD"

!!Change the hardware!!

OUTPUT 718;":DATA:BRake:ADDR?"

ENTER 718;A\$

:DATA:CYCLing

:CYCLing

AUTO, default

Automatic: upon receiving a START event, the pattern is repeatedly cycled until a STOP event occurs. See :INP:TRIG:STAR and STOP.

SINGle

Single: upon receiving a START event the pattern is cycled one time unless a STOP event occurs. See :INP:TRIG:STAR and STOP.

Start Events:

1. START key
2. CONTINUE key
3. :INP:TRIG:STAR IMM
4. :INP:TRIG:CONT
5. Trigger function: trigger or gate
6. *TRG

Stop Events:

1. STOP key
2. :INP:TRIG:STOP
3. Trigger function: gate
4. :DATA:BRE

Display: Control, Data Format (Cycling)

:CYCLing?

Response: AUTO or SING

EXAMPLE:

OUTPUT 718;":DATA:CYCL AUTO"

OUTPUT 718;":DATA:CYCL?"

ENTER 718;A\$

:DATA:FORMat

:FORMat

RZ, default

Return to zero output data format

Maximum external clock frequency:
50 MHz

NRZ

Non-return to zero output data format

Maximum external clock frequency:
100 MHz

Conflict: :DATA:FORM NRZ and
:INP:CONT:MODE DEL and WIDT are
incompatible.

DNRZ

Delayed non-return to zero output data format

Maximum external clock frequency:
50 MHz

Execution: The pattern generator must be
in the stopped state.

Conflict: :DATA:FORM DNRZ and
:INP:CONT:MODE WIDT are incompatible.

Display: Data Format (Data Format)

:FORMat?

Response: RZ, NRZ, or DNRZ

EXAMPLE:

OUTPUT 718;":DATA:FORM RZ"

OUTPUT 718;":DATA:FORM?"
ENTER 718;A\$

:DATA:LENGth

:LENGth

value 1 (:DATA:MODE WORD)

3 <= Word Length <= 256

Default: 8.

Value 1 specifies the word length (number of bits/word). It is not coupled to value 3.

value 2 (:DATA:MODE WORD)

1 <= No. of Words <= 3640

Default: 2048.

Value 2 specifies the number of words/frame.

NOTE: (Word Length)(Number of Words) <= 16384 bits

Number of bits/frame restrictions:

Word Length of 3 = 10920 bits

Word Length of 4 = 14560 bits

value 3 (:DATA:MODE BIT)

3 <= No. of Bits <= 16384

Default: 16384

Value 3 specifies the number of bits/frame.

Value 3 is not coupled to value 1.

Execution: the :DATA:UPD command is required to change the hardware.

Display: Data Format (Frame)

:DATA:LENGth?

:LENGth?

Response: frame specifications in integer form for the active mode, for example, word mode = 8,2048 / bit mode = 16384.

EXAMPLE:

OUTPUT 718;":DATA:LENG 8,2048"

or

OUTPUT 718;":DATA:LENG 16384"

OUTPUT 718;":DATA:UPD"

!!Update the hardware!!

OUTPUT 718;":DATA:LENG?"

ENTER 718;A\$

:DATA:MODE

:MODE

WORD, default

The frame data are word formatted.

BIT

The frame data are bit formatted.

Execution: the :DATA:UPD command is required to update the current setting.

Display: Data Format (Frame)

:MODE?

Response: BIT or WORD

EXAMPLE:

OUTPUT 718;":DATA:MODE BIT"

OUTPUT 718;":DATA:UPD"

!!Update the hardware!!

OUTPUT 718;":DATA:MODE?"

ENTER 718;A\$

:DATA:PATtern

:PATtern

value

Value is the word (word mode) or bit (bit mode) at which the data changes begin.

data

Data are the base and data specifications which are used to alter the data (See example.).

Execution: the :DATA:UPD command is required to change the hardware.

:PATtern?

BINary|OCTal|HEXadecimal

Specifies in which base the response is to be returned: binary, octal, or hexadecimal.
See Example.

EXAMPLE: WORD MODE

This example consists of three parts (channel 1 only is described):

1. Create a word mode data frame.
2. Create and transmit changes(Channel 1).
3. Query and print the response message.

:DATA:PATtern

STEP 1: Create a word mode data frame.

```
OUTPUT 718;":*RST" !!Known state!!  
OUTPUT 718;":DATA:MODE:LENG 8,8"
```

Data entry display, Base = BIN:

Word 0:	00000000
Word 1:	00000000
Word 2:	00000000
Word 3:	00000000
Word 4:	00000000
Word 5:	00000000
Word 6:	00000000
Word 7:	00000000

STEP 2. Transmit the data changes.

```
OUTPUT 718;":DATA:PATT 2,#HFF,#B1111,#Q377,.,#H0F  
OUTPUT 718;":DATA:UPD" !!Change the hardware!!
```

Data entry display, Base = BIN:

Word 0:	00000000
Word 1:	00000000
Word 2:	11111111
Word 3:	11110000
Word 4:	11111111
Word 5:	00000000
Word 6:	00001111
Word 7:	00000000

:DATA:PATtern

Explanation:

Value:

Value = 2: the changes begin at Word 2.
Thus, Words 0 and 1 remain unchanged.

Data:

Each word or part of a word to be changed is separated by commas. #B, #Q, and #H specify to the instrument that the incoming data is in binary, octal, or hexadecimal base.

Word 2: #HFF is sent which is displayed above as 11111111 in Word 2.

Word 3: #B1111 is sent which is displayed above as 11110000 in Word 3. Only four bits of the word were sent. Thus, four bits remain unchanged.

Word 4: #Q377 is sent which is displayed above as 11111111 in Word 4.

Word 5: Word 5 remains unchanged. The two consecutive commas ',,' indicate that no changes are to be made to the word.

Word 6: #H0F is sent which is displayed as 00001111 in Word 6. In this case, since the first four bits of the word are not to be changed, the required pattern of bits for the entire word must be sent. Compare this with Word 3.

Word 7: No information regarding Word 7 was transmitted. Thus, no changes are made to Word 7.

:DATA:PATtern

STEP 3. Query and print the response message.

```
DIM A$ [100] !!Response Message!!  
OUTPUT 718;":DATA:PATT? HEX"  
ENTER 718;A$  
PRINT A$
```

Printed response:

```
#H00,#H00,#HFF,#HF0,#HFF,#H00,#H0F,#H00
```

Dimension the A\$ according to the frame size and the base of the message to be read.

The query returns the complete frame data.

:DATA:PATtern

EXAMPLE: BIT MODE

This example consists of three parts
(channel 1 only is described):

1. Create a bit mode data frame.
2. Create and transmit changes.
3. Query and print the response message.

STEP 1: Create a bit mode data frame.

```
OUTPUT 718;":*RST" !!Known State"  
OUTPUT 718;":DATA:MODE BIT"  
OUTPUT 718;":DATA:MODE:LENG 64"
```

Data entry display, Base = BIN:

Bit 0:	0000000000	0000000000
Bit 20:	0000000000	0000000000
Bit 40:	0000000000	0000000000
Bit 60:	0000	

STEP 2: Transmit the data changes.

```
OUTPUT 718;":DATA:PATT 16,#HFFF0FF000F  
OUTPUT 718;":DATA:UPD" !!Change the hardware!!
```

Data entry display, Base = BIN:

Bit 0:	0000000000	0000001111
Bit 20:	1111111100	0011111111
Bit 40:	0000000000	0011110000
Bit 60:	0000	

:DATA:PATtern

Explanation:

The value,data transmitted: 16,#HFFF0FF000F

Value:

Value = 16: the changes begin at digit 16. Thus, Bit 0 through Bit 15 remain unchanged.

Data:

#H specifies to the instrument that the incoming data is in hexadecimal format. This example can be performed with binary,#B, or octal, #Q, data also.

Bits	0-15:	No changes. Value = 16.
Bits	16-27:	FFF is sent which is displayed above as 111111111111.
Bits	28-31:	0 is sent which is displayed above as 0000.
Bits	32-39	FF is sent which is displayed above as 11111111.
Bits	40-51	000 is sent which is displayed above as 000000000000.
Bits	52-55	F is sent which is displayed above as 1111.
Bits	56-64	No changes. No change data was sent.

:DATA:PATtern

STEP 3. Query and print the response.

```
DIM A$ [100]
OUTPUT 718;":DATA:PATT? HEX"
ENTER 718;A$
PRINT A$
```

Printed response:

```
#H0000FFF0FF000F00
```

:DATA:STRobe

:STRobe

BIT, default mode

One strobe per bit.
Allowed in frame modes 'bit' and 'word'.

WORD

One strobe per word at the first bit
of the word. Allowed in frame mode 'word' only.

FStart

Frame start: one strobe per frame
at the first bit of the frame.
Allowed in frame modes 'bit' and 'word'.

FEND

Frame end: one strobe per frame
at the last bit of the frame.
Allowed in frame mode 'bit' and 'word'.

Execution: the :DATA:UPD command is required
to change the hardware.

Display: Output (Strobe Mode)

:STRobe?

Response: BIT, WORD, FST, OR FEND

EXAMPLE:

```
OUTPUT 718;":DATA3:STR BIT"  
OUTPUT 718;":DATA3:UPD"  
!!Update the hardware!!  
OUTPUT 718;":DATA3:STR?"  
ENTER 718;A$
```

:DATA:UPDate

:UPDate

The update function copies the pattern data from the setting to the hardware.

Execution: The pattern generator must be in the stopped state. It is only necessary to execute :SYST:UPD one time after all commands requiring updating are processed.

The following commands require the update function. See also Chapter 5, UPDATING.

:DATA:BRE
:DATA:BRE:ADDR
:DATA:LENG
:DATA:MODE
:DATA:PATT
:DATA:STR

Display: None. See UPDATE key.

:INP:CLOCK

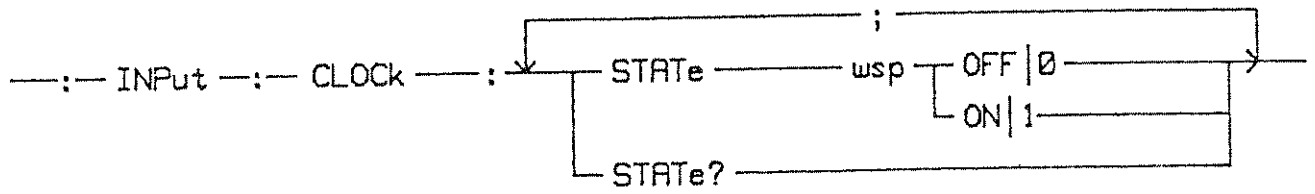

:INPut:CLOCK:STATE

:STATE

OFF = 0, default

The internal clock source is enabled.

ON = 1

The external clock source is enabled.

Maximum external clock frequencies:

RZ = 50 MHz

NRZ = 100 MHz

DNRZ = 50 MHz

Execution: The pattern generator must be in the stopped state.

Conflict: :INP:CLOC:STAT ON and :INP:CONT:MODE PER are incompatible.

Display: Control (External Clock)

:STATE?

Response: 1 or 0.

EXAMPLE:

OUTPUT 718;":INP:CLOC:STAT ON"

OUTPUT 718;":INP:CLOC:STAT?"

ENTER 718;A\$

:INP:CONTrol

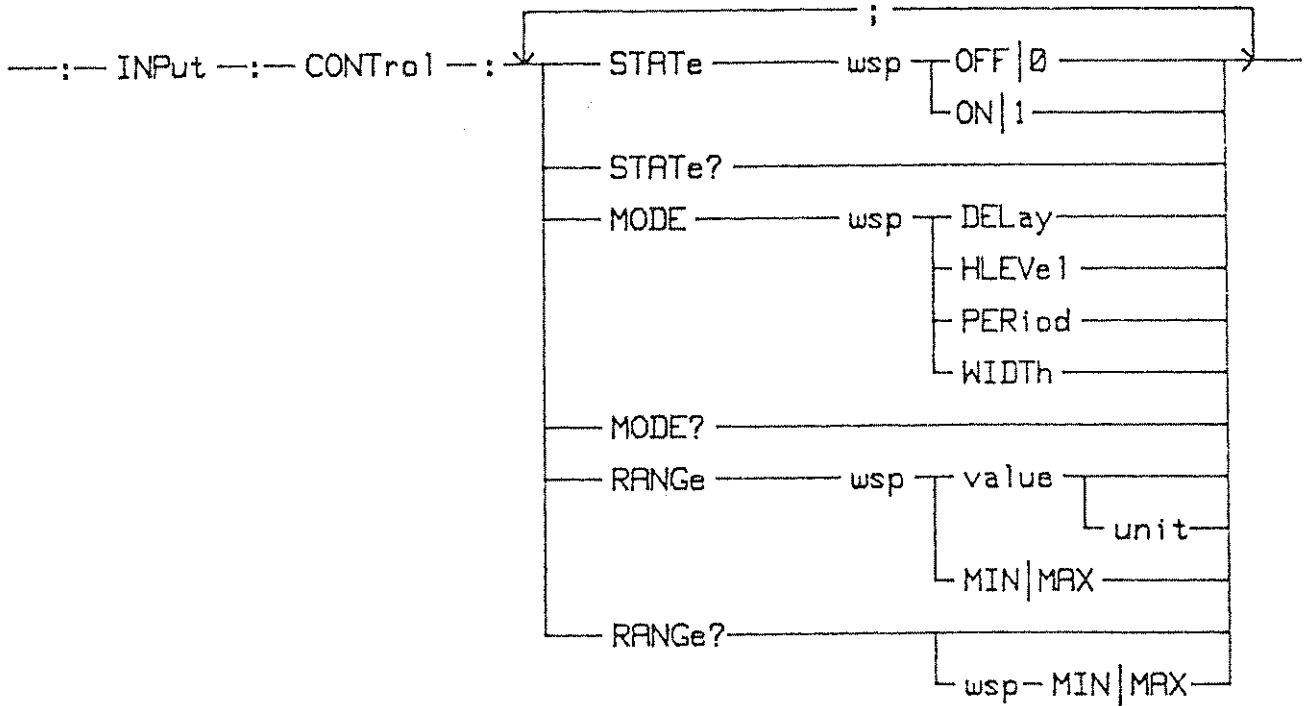

:INP:CONTRol:MODE

:MODE

DELAy, default mode

Pulse generator: the delay or double pulse delay of channels 1 and 2 are controlled by an external voltage.

The minimum delay (75.0 ns) occurs at 7.5 V on Range 1.

The minimum double pulse delay (20.0 ns) occurs at 2.0 V on Range 1.

A range specification is required.

See :INP:TRIG:RANG.

Related command: :PULS:TIM:DOUB MODE OFF|ON
OFF selects delay and ON selects double pulse delay.

Pattern generator: the delay of channels 1 and 2 are controlled by an external voltage. Double pulse is not available in the pattern generator.

The minimum delay (75.0 ns) occurs at 7.5 V on Range 1.

A range specification is required.

See :INP:TRIG:RANG.

Conflict: :INP:CONT:MODE DEL and :DATA:FORM NRZ are incompatible.

PERIOD

The periods of channels 1, 2, and 3 are controlled by an external voltage.
Control voltage: 1.0 V to 10.0 V

The minimum period for data formats RZ and DNRZ occurs at 2.0 V on Range 1.

:INPut:CONTRol:MODE

A range specification is required.
See :INP:TRIG:RANG.

Conflicts: :INP:CONT:MODE PER is incompatible
with:

1. :INP:TRIG:MODE TRIG
2. :INP:CLOC

WIDTH

The width of channels 1 and 2 are controlled
by an external voltage.

Control voltage: 1.0 V to 10.0 V

A range specification is required.
See :INP:TRIG:RANG.

Conflicts: :INP:CONT:MODE:WID and
:DATA:FORM NRZ or DNRZ are
incompatible.

HLEVeI

The high level of channels 1 and 2 are
controlled by an external voltage.

Control voltage: -8.0 V to 8.0 V
Output voltage: -8.0 to 8.0 V

CAUTION: :PULS:LEV:LIM is inactive when HLEV
is enabled.

Conflict: :INP:CONT:MODE HLEV and
:OUTP:PULS:ADD ON are incompatible.

Display: Control (Control)

:INPut:CONTRol:MODE?

MODE?

Response: PER, DEL, WIDT, or HLEV.

EXAMPLE:

OUTPUT 718;":INP:CONT:MODE DEL"

OUTPUT 718;":INP:CONT:MODE?"

ENTER 718;A\$

:INPut:CONTRol:RANGe

RANGe

<value>[<unit>]|MIN|MAX

The :RANG command specifies the operating range of the period, delay, or width when they are externally controlled. See :INP:CONT:MODE.

See the following table for the values and units.

A parameter can be varied within a range of values. If the required value is outside the current range, a new range specification is required.

Programming any value within a range makes that range the current range.

<u>RANGE</u>		<u>value</u>		<u>unit</u>	<u>RESOLUTION</u>
1	***	-	99.9	ns	100 ps
2	100	-	999	ns	1 ns
3	1	-	9.99	un	10 ns
4	10	-	99.9	un	100 ns
5	100	-	999	un	1 un
6	1	-	9.99	ms	10 un
7	10	-	99.9	ms	100 un
8	100	-	999	ms	1 ms

*** The lower limit of RANGE 0 depends on the parameter being controlled:

DEL: Pulse delay = 75 ns
Double pulse delay = 20 ns

PER: Pulse, RZ, DNRZ = 20 ns
NRZ = 10.0 ns.

WIDT: 10.0 ns.

Default: Range 1

Display: Timing (...Range)

:INPut:CONTRol:RANGe?

:RANGe?

**Response: the upper limit value of the current range in exponential format|MIN|MAX
Example: 99.9 E-6.**

EXAMPLE:

OUTPUT 718;":INP:CONT:MODE DEL"
OUTPUT 718;":INP:CONT:RANG 95.5 E-6"
or
OUTPUT 718;":INP:CONT:RANG 95.5 US"

OUTPUT 718;":INP:CONT:RANG?"
ENTER 718;A\$

:INPut:CONTRol:STATe

COMMAND

DESCRIPTION

:STATe

OFF = 0, default state
The control input is disabled.

ON = 1
The control input is enabled.

Display: Control (Control)

:STATe?

Response: 1 or 0

EXAMPLE:

OUTPUT 718;":INP:CONT:STAT ON"

OUTPUT 718;":INP:CONT:STAT?"
ENTER 718;A\$

:INPut:TRIGger

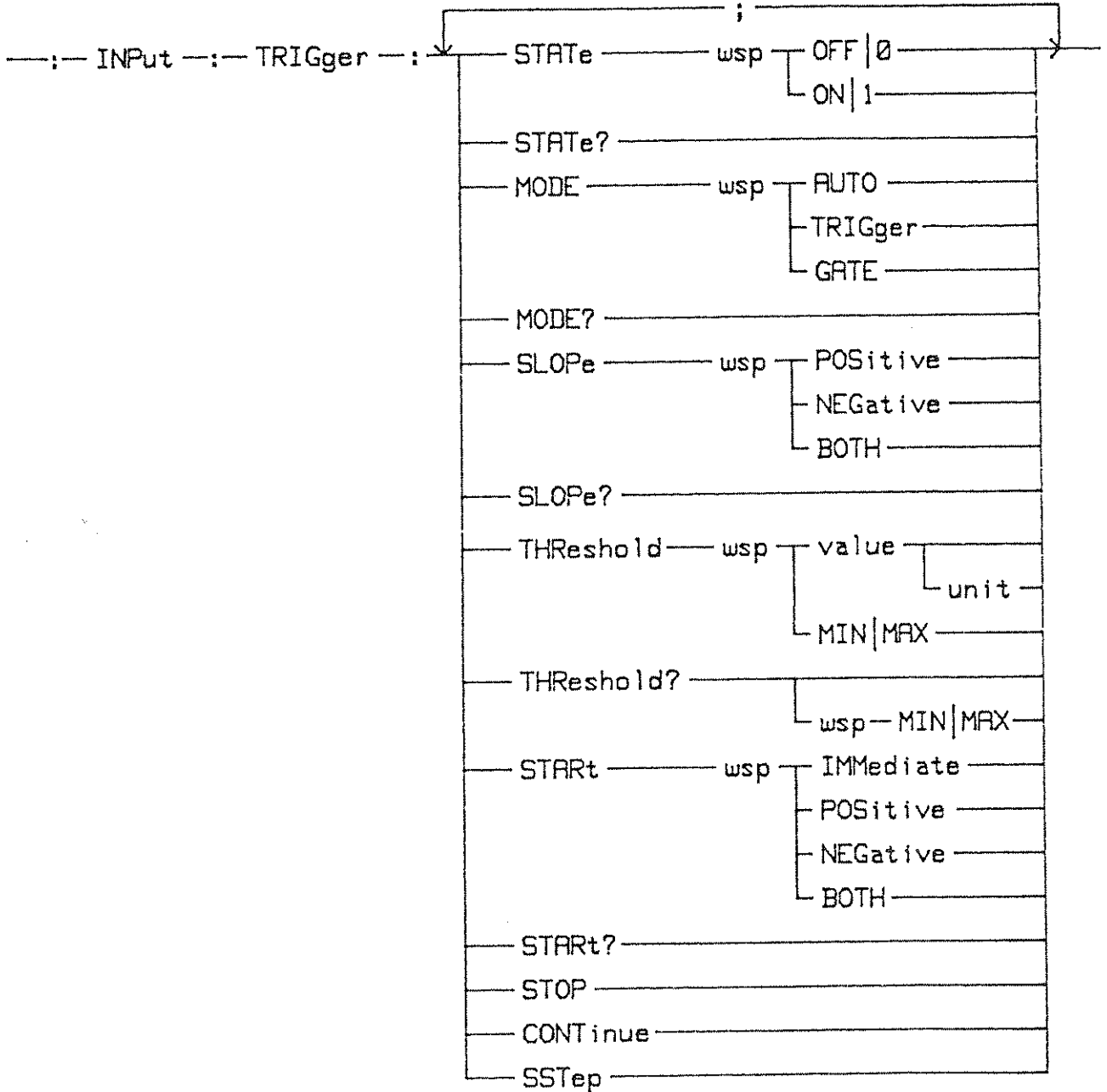

:INPut:TRIGger:CONTInue

:CONTInue

Cycling resumes from the point at which it was halted.

EXAMPLE:

OUTPUT 718;":INP:TRIG:CONT"

Display: none. See CONTINUE key.

:INPut:TRIGGer:MODE

:MODE

AUTO, default mode

Pulse generator: A continuous pulse stream is generated. The external input is disabled.

Pattern generator: cycling starts when an :INP:TRIG:STAR IMM or a *TRG command is received. The external input is disabled.

TRIGger

Pulse generator: one pulse or double pulse signal is generated per trigger (external input) signal or *TRG command.

Pattern generator: cycling starts when a trigger (external input) signal, an :INP:TRIG:STAR IMM or a *TRG command is received.

Conflict: :INP:TRIG:MODE:TRIG and :INP:CONT:PER are incompatible.

GATE

Pulse generator: pulses are generated for the duration of the gate. The last pulse is completed.

Pattern generator: the first gate edge is a START event and the second gate edge is a STOP event. See :INP:TRIG:STAR.

Conflict: :INP:TRIG:MODE GATE and :INP:TRIG:SLOP|STAR BOTH are incompatible.

Display: Control (Trigger)

:MODE?

Response: AUTO, TRIG, or GATE

EXAMPLE:

```
OUTPUT 718;":INP:TRIG:MODE AUTO"
```

```
OUTPUT 718;":INP:TRIG:MODE?"  
ENTER 718;A$
```

:INPut:TRIGger:SLOPe

:SLOPe

POSitive, default mode

Positive edge triggering

NEGative

Negative edge triggering

BOTH

Either positive or negative edge triggering

Conflict: :INP:TRIG:SLOP BOTH and
:INP:TRIG:MODE:GATE are incompatible.

Display: Control (Trigger)

:SLOPe?

Response: POS, NEG, or BOTH

EXAMPLE:

OUTPUT 718;":INP:TRIG:SLOP POS"

OUTPUT 718;":INP:TRIG:SLOP?"
ENTER 718; A\$

:INPut:TRIGger:SSTep

:SSTep

The pattern is advanced one bit (single stepped).

Execution: The pattern generator must be in the stopped state.

Display: none. See MANUAL key.

EXAMPLE:

OUTPUT 718;":INP:TRIG:SST"

:INPut:TRIGger:START

:START

POSitive, default mode

Positive: cycling starts on a positive slope.

NEGative

Negative: cycling starts on a negative slope.

BOTH

Both: cycling starts on either a positive or negative slope.

IMMEDIATE

Immediate: cycling begins immediately.

Conflict: :INP:TRIG:STAR BOTH and
:INP:TRIG:MODE GATE are incompatible.

Display: Control (Trigger)

:START?

Response: POS, NEG, or BOTH

EXAMPLE:

OUTPUT 718;":INP:TRIG:STAR POS"

OUTPUT 718;":INP:TRIG:STAR?"
ENTER 718;A\$

:INPut:TRIGger:STATe

:STATe

OFF = 0, default state

The external input is disabled.

ON = 1

The external input is enabled.

Display: Control (Trigger)

:STATe?

Response: 1 or 0

EXAMPLE:

OUTPUT 718;":INP:TRIG:STAT ON"

OUTPUT 718;":INP:TRIG:STAT?"

ENTER 718;A\$

:INPut:TRIGger:STOP

:STOP

cycling stops

Display: none. See STOP key.

EXAMPLE:

OUTPUT 718;":INP:TRIG:STOP"

:INPut:TRIGger:THReshold

:THReshold

-12.0 <= value <= 12.0|MIN|MAX

Range: -12.0V to 12.0V

Resolution: 00.1V

Default: 2.4V

The external clock and the trigger (external input) thresholds are coupled. Both thresholds are simultaneously set by the :INP:TRIG:THR command path.

Display: Control (Trigger/Threshold)

:THReshold?

Response: -12.0 <= response <= 12.0|MIN|MAX

EXAMPLE:

OUTPUT 718;":INP:TRIG:THR 3.5V"

OUTPUT 718;":INP:TRIG:THR?"

ENTER 718;A\$

:OUTPut:PULSe

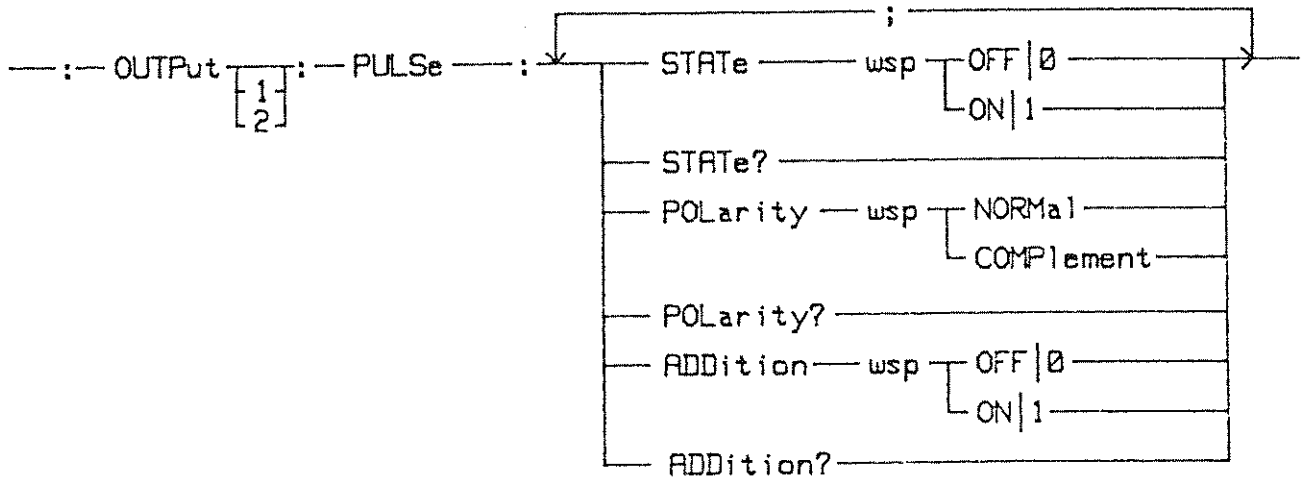

:OUTPut <channel>

:OUTPut

Bypass

No channel specified

Application:

All commands: Channel 1

1

Channel 1 (Output 1)

Application:

All commands Channel 1

2

Channel 2 (Output 2)

Application:

ADD command: not allowed

All other commands: Channel 2

:OUTPut:PULSe:ADDition

:ADDition

OFF = 0, default

Addition is disabled. Channels 1/2 are output seperately.

ON = 1

Addition: channel 1 is added to channel 2 and output at Output 1.

Observe the maximum levels for channel 1 when adding channels 1 and 2.

If channel 2's output state = [On], it will change to [Off] when addition is enabled.

Conflict: :OUTP:PUL:ADD and :INP:CONT:MODE HLEV are incompatible.

Display: Output (Addition)

:ADDition?

Response:1 or 0

EXAMPLE:

OUTPUT 718;":OUTP1:PULS:ADD ON"

OUTPUT 718;":OUTP1:PULS:ADD?"
ENTER 718;A\$

:OUTPut:PULSe:POLarity

:POLarity

NORMAl, default

Output 1 and 2 are output as specified.

COMPLement

Output 1 and 2 are inverted.

Display: Output (Polarity)

:POLarity?

Response:NORM or COMP

EXAMPLE:

OUTPUT 718;":OUTPI:PULS:POL COMP"

OUTPUT 718;":OUTPI:PULS:POL?"

ENTER 718;A\$

:OUTPut:PULSe:STATe

:STATe

OFF, default

Output 1 or 2 is disabled.

ON = 1

Output 1 or 2 is enabled.

When enabled, the messages 'Output 1' and 'Output 2' appear in the second message line.

Display: Output (State)

:STATe?

Response: 1 or 0

EXAMPLE:

OUTPUT 718;":OUTPI:PULS:STAT ON"

OUTPUT 718;":OUTPI:PULS:STAT?"

ENTER 718;A\$

:PULSe:EDGE

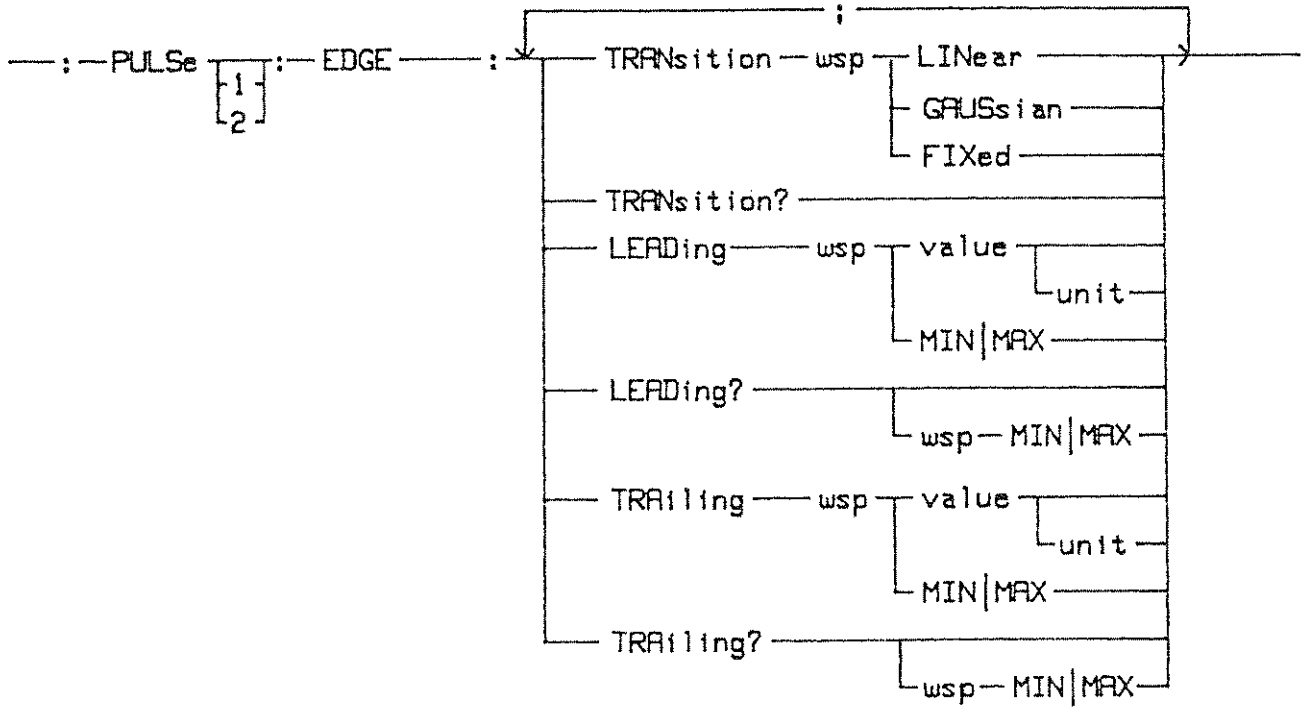

:PULSe <channel>

:PULSe

Bypass

No channel specified

Application:

All commands: Channel 1/Output 1

1

Channel 1 (Output 1)

Application:

All commands: Channel 1/Output 1

2

Channel 2 (Output 2)

Application:

All commands: Channel 2/Output 2

:PULSe:EDGE:LEADing

:LEADing

05.5 <= value <= 99.9|MIN|MAX

Range: 05.5 ns to 99.9 ms

Resolution: LSD/See Table 8-1.

Default: 10.0 ns

The amplitude is reduced if the edge values are long(excessive) with respect to other timing values.

Leading and trailing edges must be programmed within a common range. See Table 8-2 and Figure 8-2 for edge information.

Display: Timing (Leading)

:LEADing?

**Response:leading edge value
in exponential form|MIN|MAX
Example: 25.5E-9.**

EXAMPLE:

OUTPUT 718;":PULSI:EDGE:LEAD 25.5E-9"

or

OUTPUT 718;":PULSI:EDGE:LEAD 25.5NS"

OUTPUT 718;":PULS:EDGE:LEAD?"

ENTER 718;A\$

:PULSe:EDGE:TRANSition

:TRANSition

LINear, default

Linear: linear edges, programmable

GAUSSian

Gaussian: cosinusoidal edges, programmable

FIXed

Fixed linear edges, 5.5 NS

The leading and trailing edges are programmed within a common range; otherwise, an error results.

Display: Timing (Transition)

:TRANSition?

Response: FIX, GAUS, or LIN

EXAMPLE:

OUTPUT 718;":PULSI:EDGE:TRAN LIN"

OUTPUT 718;":PULSI:EDGE:TRAN?"

ENTER 718;A\$

:PULSe:EDGE:TRailing

:TRailing

05.5 <= value <= 99.9|MIN|MAX

Range: 05.5 ns to 99.9 ms

Resolution: LSD/See Table 8-1.

Default: 10.0 ns

The amplitude is reduced if the edge values are long(excessive) with respect to other timing values.

Leading and trailing edges must be programmed within a common range. See Table 8-1 and Figure 8-2 for edge information.

Display: Timing (Trailing)

:TRailing?

**Response:trailing edge value
in exponential form|MIN|MAX
Example: 25.5E-9.**

EXAMPLES:

OUTPUT 718;":PULSI:EDGE:TRA 25.5E-9"

or

OUTPUT 718;":PULSI:EDGE:TRA 25.5NS"

OUTPUT 718;":PULSI:EDGE:TRA?"

ENTER 718;A\$

:PULSe:LEVel

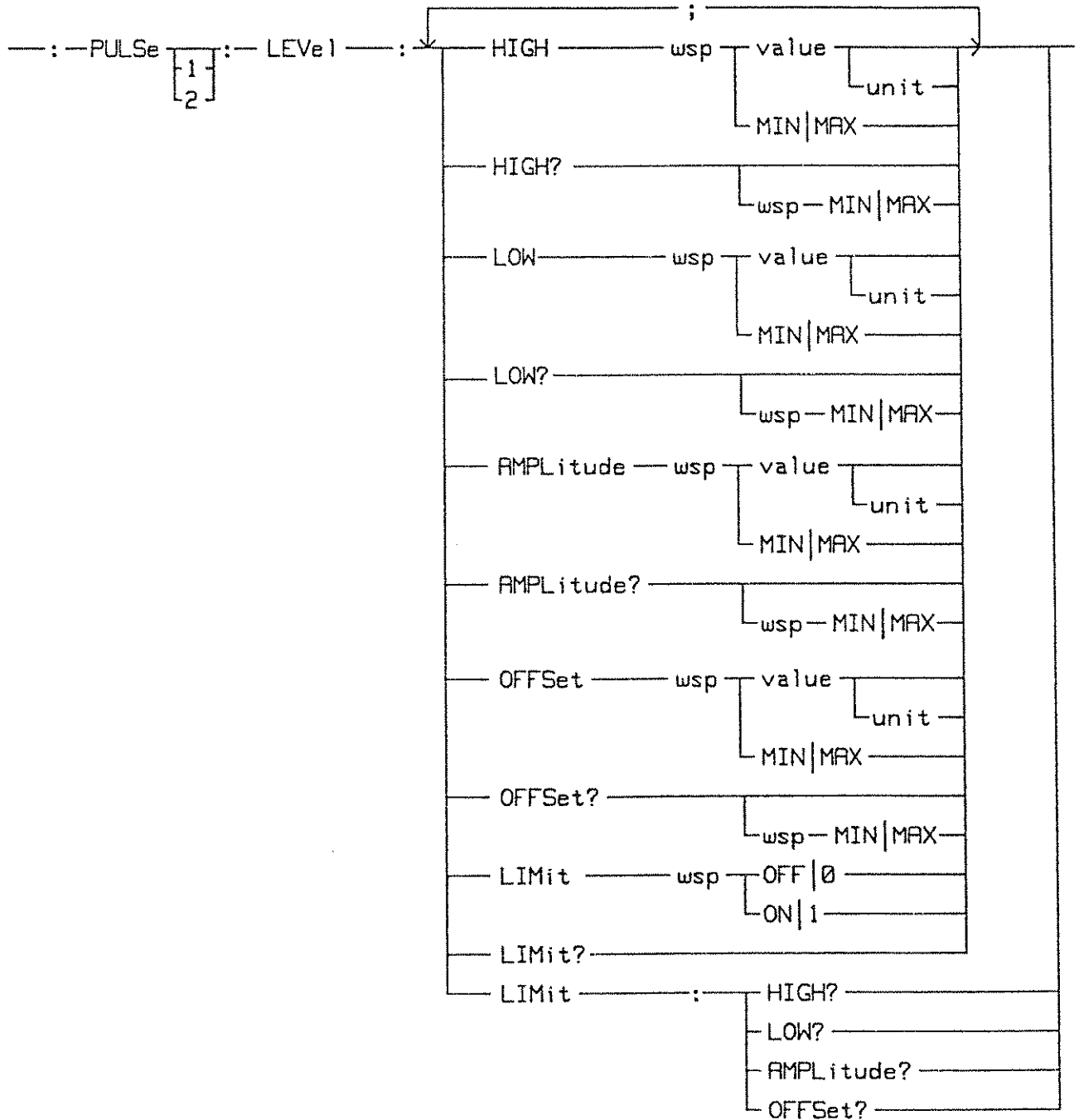

:PULSe:LEVel <channel>

:PULSe

Bypass

No channel specified

Application:

All commands: Channel 1/Output 1

1

Channel 1 (Output 1)

Application:

All commands: Channel 1/Output 1

2

Channel 2 (Output 2)

Application:

All commands: Channel 2/Output 2

:PULSe:LEVel:AMPLitude

:AMPLitude

0.08 <= value <= 16.40|MIN|MAX

Range: 0.08V to 16.40 V

Resolution: 0.01V

Default: 1.00V

Amplitude = High Level - Low Level

Amplitude, offset, and levels are coupled.

Display: Output (Amplitude)

:AMPLitude?

Response: amplitude value in decimal form|MIN|MAX

Example: 3.55.

EXAMPLE:

OUTPUT 718;":PULSI:LEV:AMPL 3.55V"

OUTPUT 718;":PULSI:LEV:AMPL?"

OUTPUT 718;A\$

:PULSe:LEVeL:HIGH

:HIGH

-8.12 <= value <= 8.20|MIN|MAX

Range: -8.12V to 8.00V

Resolution: 0.01V

Default: 1.00V

High Level = Offset + (Amplitude/2)

High level, low level, amplitude, and offset
are coupled.

Display: Output (High Level)

:HIGH?

Response: high level value in decimal form|MIN|MAX

Example: 6.55.

EXAMPLE:

OUTPUT 718;":PULSI:LEV:HIGH 6.55V"

OUTPUT 718;":PULSI:LEV:HIGH?"

ENTER 718;A\$

:PULSe:LEVel:LIMit

:LIMit

OFF = 0, default

The limit function is disabled.

ON = 1

The limit function is enabled.

CAUTION: the limit function is inactive if control mode 'high level' is enabled.

The levels , amplitude, and offset commands are coupled commands and are processed before a limit enabling command within the same program message.

The high and low level limits are set as follows:

1. Disable the limit function if it is enabled.
2. Set the levels to the required limit values.
3. Enable the limit function.

The limit values are included in the limit and level HELP messages.

Display: Output (Limit)

:LIMit?

Response: 1 or 0

EXAMPLE:

OUTPUT 718;":PULSe:LEVel:LIM ON"

OUTPUT 718;":PULSe:LEVel:LIM?"
ENTER 718;A\$

:PULSe:LEVel:LIMit

:LIMit:HIGH?
:LIMit:LOW?
:LIMit:AMPLitude?
:LIMit:OFFSet?

**Response: limit value queried in decimal form,
for example, 2.5.**

EXAMPLE:

OUTPUT 718;":PULS:LEV:LIM:OFFS?"
OUTPUT 718;A\$

:PULSe:LEVel:LOW

:LOW

-8.20 <= value <= 8.12|MIN|MAX

Range: -8.20V to 8.12V

Resolution: 0.01V

Default: 0.00V

Low Level = Offset - (Amplitude/2)

Low level, high level, amplitude, and offset are coupled.

Display: Output (Low Level)

:LOW?

Response: low level value in decimal form|MIN|MAX
Example: 1.45.

EXAMPLE:

OUTPUT 718;":PULSI:LEV:LOW 1.45V"

OUTPUT 718;":PULSI:LEV:LOW?"
ENTER 718;A\$

:PULSe:LEVel:OFFSet

:OFFSet

-8.160 <= value <= 8.160|MIN|MAX

Range: -8.160 V to 8.160 V

Resolution: 0.005V

Default: 0.500V

Offset = (High Level + Low Level) / 2

Offset, amplitude, and levels are coupled.

Display: Output (Offset)

:OFFSet?

Response: offset value in decimal form|MIN|MAX

Example: 2.555.

EXAMPLE:

OUTPUT 718,":PULS:LEV:OFFS 2.555V"

OUTPUT 718,":PULS:LEV:OFFS?"

ENTER 718:A\$

:PULSe:TIMing

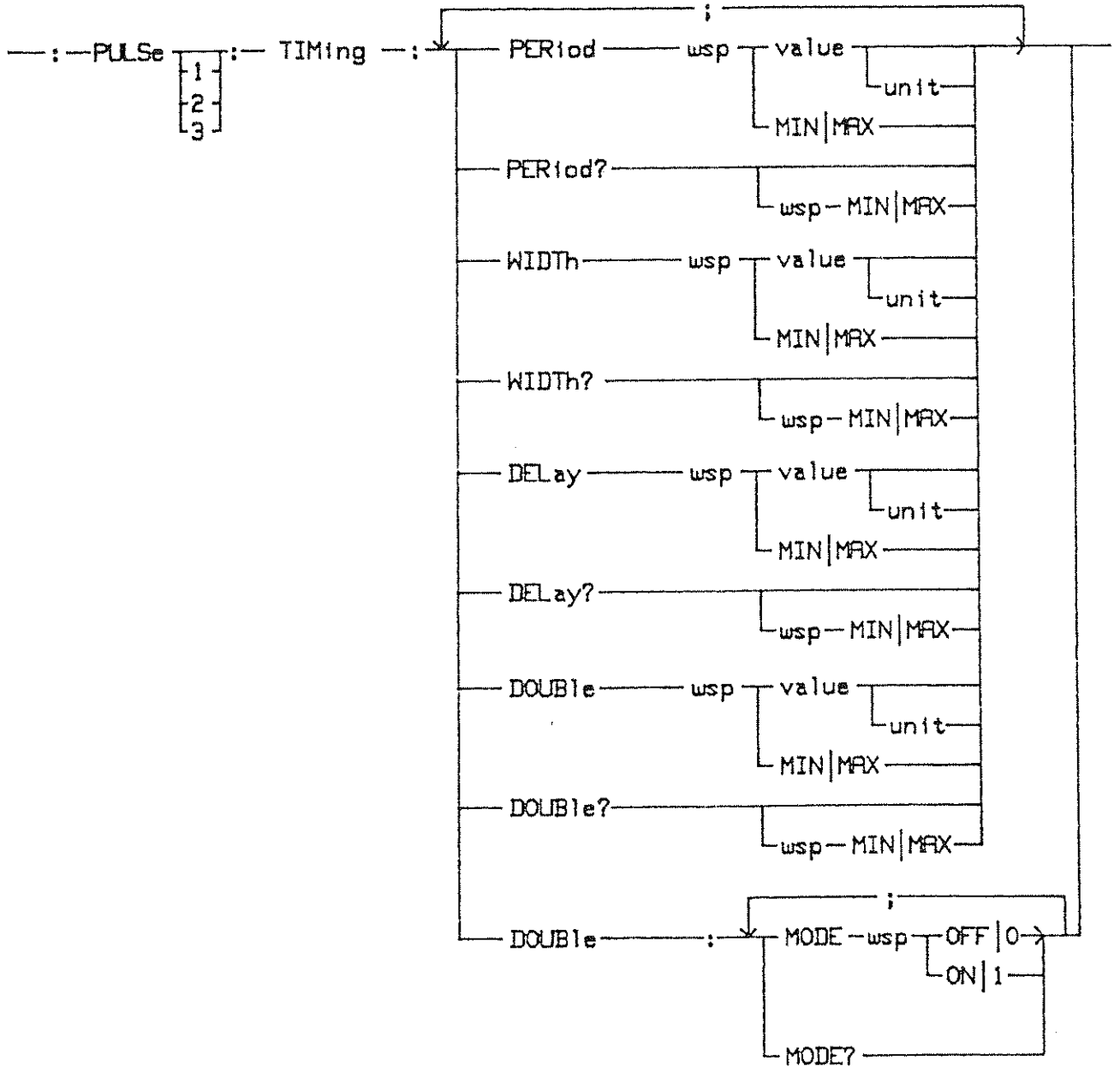

:PULSe <channel>

:PULSe

Bypass

No channel specified

Applications:

PER programming

All other commands: Channel 1/Output 1

1

Channel 1 (Output 1)

Applications:

PER programming

All other commands: Channel 1/Output 1

2

Channel 2 (Output 2)

Applications:

PER programming

All other commands: Channel 2/Output 2

3

Strobe (pattern generator only)

Applications:

PER programming

WIDT and DEL programming: Strobe

:PULSe:TIMing:DELay

:DELay

74.0 <= value <= 999|MIN|MAX

Range: 74.0 ns to 999 ms

Resolution: LSD/See Table 8-1.

Default: 75.0 ns

Related command: :PULS:TIM:DOUB:MODE OFF|ON
OFF selects delay and ON selects double pulse delay.

Display: Timing (Delay)

:DELay?

Response:delay value in exponential form|MIN|MAX
Example; 75.5E-9.

EXAMPLE:

OUTPUT 718,":PULS1:TIM:DEL 75.5E-9"

or

OUTPUT 718,":PULS1:TIM:DEL 75.5NS"

OUTPUT 718,":PULS:TIM:DEL?"

ENTER 718;A\$

:PULSe:TIMing:DOUBle

:DOUBle

18.0 <= value <= 999|MIN|MAX

Range: 18.0 ns to 999 ms

Resolution: LSD/See Table 8-1.

Default: 200 us

Related command: :PULS:TIM:DOUB:MODE OFF|ON

OFF selects delay and ON selects double pulse.

Display: Timing (Double)

:DOUBle?

Response:double pulse delay value in exponential form|MIN|MAX

Example: 95.5E-9.

EXAMPLE:

OUTPUT 718;":PULS:TIM:DOUB 95.5E-9"

or

OUTPUT 718;":PULS:TIM:DOUB 95.5NS"

OUTPUT 718;":PULS:TIM:DOUB?"

ENTER 718;A\$

:PULS:TIM:DOUB:MODE

:DOUBle:MODE

OFF = 0, default mode
Pulse delay is selected.

ON = 1
Double pulse is selected.

:DOUBle:MODE?

Response:1 or 0

EXAMPLE:

OUTPUT 718;":PULS:TIM:DOUB:MODE ON"

OUTPUT 718;":PULS:TIM:DOUB:MODE?"
ENTER 718;A\$

:PULSe:TIMing:PERiod

PERiod

Pulse: 18.0 <= value <= 999|MIN|MAX
Range: 18.0 ns to 999 ms

Pattern: 9.0 <= value <= 999|MIN|MAX
Range, RZ/DNRZ: 18.0 ns to 999 ms
Range, NRZ: 09.0 ns to 999 ms

Resolution: 0.1 LSD/See Table 8-1.
Default: 1.00 ms

The period parameter is common to Channels 1/2/3.

Pattern generator: when the external clock is enabled, the period is controlled by the clock rate.

Pulse generator: when the trigger mode 'trigger' is enabled, the period is controlled by the external input trigger signal.

Pulse and pattern generator: when control mode 'period' is enabled, the period is controlled by an external voltage.

:PERiod?

Response: the period value
in exponential form|MIN|MAX
Example: 95.5E-3.

EXAMPLE:

OUTPUT 718;":PULS2:TIM:PER 95.5E-3" or
OUTPUT 718;":PULS2:TIM:PER 95.5MS"

OUTPUT 718;":PULS2:TIM:PER?"
ENTER 718;AS

:PULSe:TIMing:WIDTh

:WIDTh

9.0 <= value <= 999|MIN|MAX

Range: 09.0 ns to 999 ms

Resolution: LDD/See Table 8-1.

Default: 100 us

:WIDTh?

Response: width value in exponential form|MIN|MAX
Example: 55.5E-9.

EXAMPLE:

OUTPUT 718;":PULSI:TIM:WIDT 55.5E-9"

or

OUTPUT 718;":PULSI:TIM:WIDT 55.5NS"

OUTPUT 718;":PULSI:TIM:WIDT?"

ENTER 718;A\$

:SYSTem

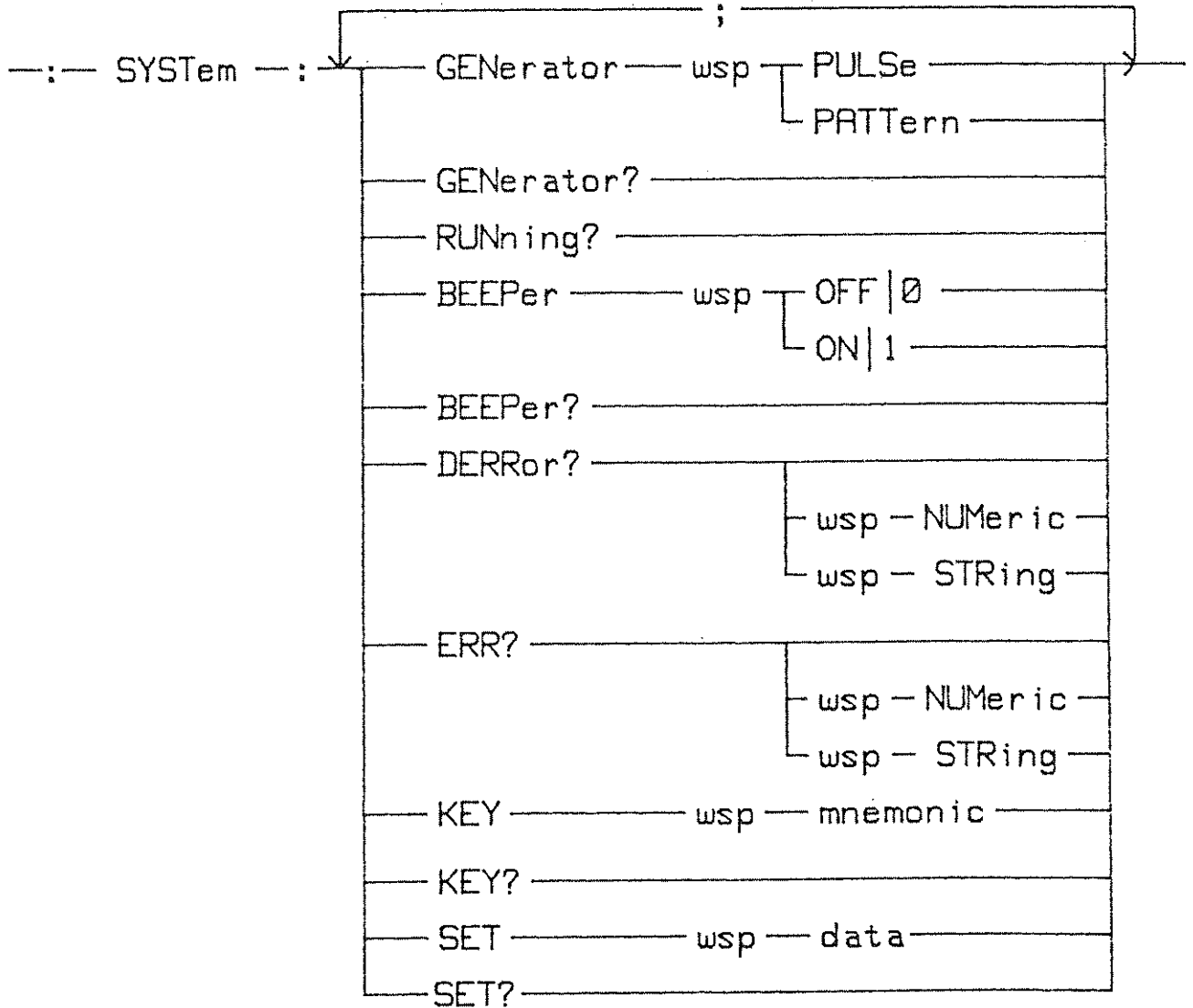

:SYSTem:BEEPer

:BEEPer

OFF = 0, default

The beeper is disabled.

ON = 1

The instrument beeper is enabled. An audible tone is generated when a disallowed action is attempted.

:BEEPer?

Response:1 or 0

EXAMPLE:

OUTPUT 718;":SYST:BEEP ON"

OUTPUT 718;":SYST:BEEP?"

ENTER 718;A\$

:SYSTem:DERRor?

:DERRor?

Bypass, default

Device dependent error codes are returned, for example, 100.

NUMeric

Device dependent error codes are returned, for example, 100.

STRing

Device dependent error codes are returned plus a brief description of the error, for example, 100,<Ext. Input Mode - Slope>.

See Chapter 7 for additional information.

Appendix F contains a list of errors reported by the :DERR? query.

EXAMPLE:

```
DIM A$ [5000]
```

```
OUTPUT 718;":SYST:DERR?"
```

```
or
```

```
OUTPUT 718;":SYST:DERR? NUM"
```

```
or
```

```
OUTPUT 718;":SYST:DERR? STR"
```

```
ENTER 718;A$
```

:SYSTem:ERRor?

:ERRor?

Bypass, default

The oldest error code is returned, for example, -350.

NUMeric

The oldest error code is returned, for example, -350.

STRing

The oldest error code plus a brief description of the error is returned, for example, -350,<Too Many Errors>.

Only one error is returned per query.

Appendix F contains a list of errors reported by the :ERR? query.

EXAMPLE:

```
DIM A$ [1000]
```

```
OUTPUT 718;":SYST:ERR?"
```

```
or
```

```
OUTPUT 718;":SYST:ERR? NUM"
```

```
or
```

```
OUTPUT 718;":SYST:ERR? STR"
```

```
ENTER 718;A$
```

:SYSTem:GENerator

:GENerator

PULSe, default

The pulse generator configuration is selected.

PATTeM

The pattern generator configuration is selected.

:GENerator?

Response:PULS or PATT

EXAMPLE:

OUTPUT 718;"SYST:GEN PULS"

OUTPUT 718;"SYST:GEN?"

ENTER 718;A\$

:SYSTem:KEY

:KEY

<mnemonic>

The :KEY command simulates the pressing of a front panel key. The mnemonics are listed in the following table.

:KEY?

Response:a key mnemonic, for example, PR.

Only real key presses are recorded in the key queue. See Chapter 7, Key Queue.

The mnemonics are listed in the following table.

If the queue is empty, two question marks (??) are returned.

See Chapter 7 for additional information.

EXAMPLE:

OUTPUT 718;":SYST:KEY PR"

OUTPUT 718;":SYST:KEY?"

ENTER 718;A\$

:SYSTEM:KEY

KEY	MNEMONIC
0	0
1	1
2	2
3	3
4	4
5	5
6	6
7	7
8	8
9	9
A	A
ABORT	AB
SAVE DISPLAY	AM
B	B
C	C
CLEAR ENTRY	CE
CONTINUE	CN
CONTROL DISPLAY	CM
COPY	CP
CURSOR DOWN	CD
CURSOR LEFT	CL
CURSOR RIGHT	CR
CURSOR UP	CU
D	D
DELAY CHANNEL 1	D1
DELAY CHANNEL 2	D2
DATA DISPLAY	DM
DECIMAL POINT	DP
DELETE	DE
DON'T CARE	DC
E	E
EXECUTE	EX

:SYSTem:KEY

KEY	MNEMONIC
F	F
HELP	HE
HIGH CHANNEL 1	H1
HIGH CHANNEL 2	H2
INSERT	IN
RETURN TO LOCAL	LO
LEADING CHANNEL 1	L1
LEADING CHANNEL 2	L2
LOW CHANNEL 1	O1
LOW CHANNEL 2	O2
MANUAL	MA
MODIFY	MD
MOVE	MO
NEXT	NX
OUTPUT DISPLAY	OM
PERIOD	PE
POLARITY CHANNEL 1	P1
POLARITY CHANNEL 2	P2
PREVIOUS	PV
PRINT	PR
PRINT ALL	PA
RETURN TO LOCAL	LO
ROLL DOWN	RD
ROLL LEFT	RL
ROLL RIGHT	RR
ROLL UP	RU
SAVE DISPLAY	AM
SHIFT CURSOR DOWN	SD
SHIFT CURSOR LEFT	SL
SHIFT CURSOR RIGHT	SR
SHIFT CURSOR UP	SU

:SYSTEM:KEY

KEY	MNEMONIC
START	SA
STATE CHANNEL 1	SI
STATE CHANNEL 2	S2
STOP	SO
SYSTEM DISPLAY	SM
TIMING DISPLAY	TM
TRAILING CHANNEL 1	T1
TRAILING CHANNEL 2	T2
UPDATE	UD
WIDTH CHANNEL 1	W1
WIDTH CHANNEL 2	W2

:SYSTem:RUNning?

:RUNning?

Response: RUN or STOP

Run indicates that the pattern generator is cycling, and STOP indicates that it is not cycling.

Example:

```
OUTPUT 718;":SYST:RUN?"  
ENTER 718;A$
```

:SYSTem:SET

:SET

<data>

The :SYST:SET command transfers binary data.

See the example for the application of :SYST:SET.

Execution: The pattern generator must be in the stopped state.

:SET?

Response: binary data is returned which contains the instrument's current setting.

The block of data is identical to the block of data saved and recalled by the *SAV and *RCL commands.

:SYSTem:SET

EXAMPLE:

```
10    DIM Query$[100],Setting$[11000]BUFFER
20    !
30    ASSIGN @Hpib_device TO 718
40    ASSIGN @Path TO BUFFER Setting$
50    !
60    !Read current setting from the HP 8118A
70    Query$=":SYST:SET?"
80    GOSUB Fetch
90    !
100   !Write stored setting to the HP 8118A
110   Count_out=10258
120   GOSUB Write
130   !
140   STOP
150   !
160   Fetch: !
170   Output @Hpib_device;Query$
180   TRANSFER @Hpib-device TO @Path;END,WAIT
190   RETURN
200   !
210   Write: !
220   TRANSFER @Path TO @Hpib_device;
      COUNT count_out, WAIT
230   RETURN
240   !
250   END
```

A

SPECIFICATIONS

INTRODUCTION

The specifications describe the instrument's warranted performance characteristics unless indicated as being supplemental or typical in nature. The performance tests and recommended test equipment listed in Appendix E can be used to verify the performance characteristics.

Supplemental, Specifications

Supplemental specifications are typical, non-warranted, performance characteristics provided for customer convenience.

Restrictions

The specifications apply to 50 ohm loads unless stated otherwise.

Ambient temperature.

0 to 55 degrees Celcius: The first or only value specified is for this range.

20 to 30 degrees Celcius: The specified values for this range are given in brackets, [], following the 0 to 55 degree Celcius specification.

The instrument warm-up period is thirty minutes.

Period, width, delay, and double pulse are specified at:

1. Minimum transition times
2. Amplitude 50% points.

Edges are measured at the amplitude 10% and 90% points.

Under and over programming is allowed.

Accuracy refers to the programmed values.

WARRANTED SPECIFICATIONS

TIMING

Period	Range	See the following table.
	Accuracy	$\pm 5\% \pm 2 \text{ ns}$ [$\pm 2\% \pm 1 \text{ ns}$]
Delay	Range	75 ns to 950 ms (max: Period + 55 ns)
	Accuracy	$\pm 5\% \pm 4 \text{ ns}$ [$\pm 2\% \pm 4 \text{ ns}$]
Double Pulse	Range	20 ns to 950 ms (max: Period - Width)
	Accuracy	$\pm 5\% \pm 2 \text{ ns}$ [$\pm 2\% \pm 2 \text{ ns}$]
Width	Range	10 ns to 950 ms (max: Period - 10 ns)
	Accuracy	$\pm 5\% \pm 2 \text{ ns}$ [$\pm 2\% \pm 2 \text{ ns}$]
Linear Transitions	Range	6.5 ns to 95 ms (low limit can increase to 7.0 ns if the low level < -5 V)
	Accuracy	$\pm 5\% \pm 2 \text{ ns}$

Resolution: 3 digits (best case: 100 ps)
 Repeatability: factor of 4 better than accuracy
 rms-jitter: 0.05% of the programmed value plus 30 ps

GENERATOR MODE

PULSE

PATTERN

Data Format	----	RZ	DNRZ	NRZ
Minimum Period	20 ns	20 ns	20 ns	10 ns
Maximum Period	950 ms	950 ms	950 ms	950 ms
Delay	YES	YES	YES	NO
Width	YES	YES	NO	NO
Double Pulse	YES	NO	NO	NO

OUTPUT

High Level
Low Level

-7.90 V to +8.00 V
-8.00 V to +7.90 V

Resolution	3 digits (best case: 10 mV)
Accuracy	±1% of programmed value ±3% of amplitude ±40 mV [±1% ±1% ±20 mV]
Repeatability	Factor of 4 better than accuracy
Settling Time	100 ns + transition time
Preshoot, Overshoot, Ringing	±5% ±10 mV (% may increase to ±7% for edges <10 ns)

Output levels double when driving into open circuits.

DATA

Data Capacity

16384 bits per channel

Word Length

3 ≤ Word Length ≤ 256 bits

Number of Words

1 ≤ Number of Words ≤ 3640 Words

Number of bits/frame restrictions:

Word Length of 3 = 10920 bits/frame maximum

Word Length of 4 = 14560 bits/frame maximum

Output Formats

RZ, DNRZ, NRZ

**Random
Patterns**

3 ≤ Length ≤ 16384 bits

A PRBS is generated if the specified frame is $2^{(n-1)}$, $n=\{2,3,\dots,14\}$, bits long.

INTERFACE

The interface conforms to IEEE Standard 488.1,
Digital Interface for Programmable Information.

HP-IB

IEEE Std. 488 interface function subsets:
AHI, SH1, T6, L4, SR1, RL1, PP0, DC0, DT1, CO.

For information regarding interface codes,
formats, protocols, and common commands,
use IEEE Draft Standard 488.2,
Codes, Formats, Protocols, and Common Commands,
as a guide. No claim of conformance is made.

SUPPLEMENTAL PERFORMANCE CHARACTERISTICS

CONTROL MODES

**Period,
Delay,
Width**

Control Voltage	1 V to 10 V
Bandwidth	10 kHz
Ratio	1:10
Range	Same ranges as specified under TIMING

High Level

Control Voltage	-8 V to +8 V input which varies the high level over the same range.
High Level Window	-8 V to +8 V into 50 ohms, regardless of the low level.
Settling Time	200 us (within 5% of final value).

INPUTS

External Input

Threshold	± 9.9 V, programmable
Maximum input voltage	± 20 V
Minimum amplitude	600 mV (p-p)
Minimum overdrive	250 mV or 30% of amplitude, whichever is greater
Minimum pulse width	10 ns
Input impedance	10 k ohms

Control Input

Maximum input voltage ± 20 V
Input Impedance 10 k ohms

Clock Input

Clock rate DC to 100 MHz
Threshold ± 9.9 V
Maximum input voltage ± 20 V
Min amplitude 600 mV (p-p)
Min overdrive 250 mV or 30% of
amplitude,
whichever is greater
Input impedance 10 k ohms

OUTPUTS

Channels 1/2

Amplitude 100 mV_{pp} to 16 V_{pp}
into 50 ohms
Source impedance 50 ohms ± 5 %
Maximum external volt ± 5 V

Trigger

Levels TTL level into 50 ohms
Output impedance 50 ohms

Strobe

Levels TTL level into 50 ohms

ADDITIONAL FEATURES

Battery

After 10 hours of operation, all stored
settings are maintained for at least 3 weeks.

GENERAL

Environmental

Storage Temperature	-40 to +65 degrees C
Operating Temperature	0 to 55 degrees C
Humidity	95% R.H. (0 to 40 degrees C)

Power

100-120/220-240 Vrms \pm 10%
450 VA maximum
48-66 Hz

Weight

Net	17,5 kg (38.8 lb)
Shipping	24,0 kg (53.0 lb)

Dimensions

Height x width x depth
190mm x 426mm x 584mm
7.5in x 16.75in x 23in

Recalibration Period

1 year recommended

B

OPTIONS ACCESSORIES

OPTIONS

- 908** Rack Flange Kit
(P/N 5061-9678)
- 910** One Operating and Programming Manual and
one Service Manual
- 915** One Service Manual
(P/N 08118-90001)
- 916** One Operating and Programming Manual
(P/N 08118-90011)
- H01** The instrument's frame hardware is outfitted
for rack-slide mounting
(P/N 1494-0059 required)
- W30** Two additional years of Return-to-HP service

ACCESSORIES

- Slide kit** Rack Slide Kit for HP 8118A #H01)
P/N 1494-0059

PERIPHERALS

- Printer** HP 2225A Thinkjet graphics printer
- Disc Drive** HP 9122D dual disc-drive, 3.5 inch/double sided

C

INSTALLATION and MAINTENANCE

CONTENTS

Safety	C-3
Electro-static Discharge	C-3
AC Power	
Requirements	C-3
Line Voltage Selection	C-4
Line Fuse Selection	C-4
Cord	C-5
Cords, Types of	C-6
Cord Modification	C-7
HP-IB (Interface)	
Networks	C-8
Cable, Adapter	C-8
Connector	C-9
Operating Environment	C-10
Mounting Hardware	C-10
(OPTIONS AND ACCESSORIES)	
Preventive Maintenance	C-10
Customer Self-service	C-10
HP Service	C-10

FIGURES

C-1 AC Power Cords	C-6
C-2 HP-IB Connector	C-9



1



1



SAFETY

The HP 8118A is a Safety Class I instrument.

It has an exposed metal chassis that is directly connected to earth potential through the line power cord.

Before installing the instrument, review:

1. The Safety Summary (red page)
2. The Instrument Reference Manuals
3. The instrument safety markings.

ALTERNATING CURRENT (AC) POWER

Requirements

The alternating current power requirements are:

1. 100-120 Vrms $\pm 10\%$
2. 220-240 Vrms $\pm 10\%$
3. 50 to 60 Hz
4. Single Phase
5. 450 VA maximum.

Line Voltage Selection

Before connecting the line power cord to the instrument, check the line voltage selector setting on the rear panel.

Slide the switch to the 115V position to select the 100V-120V range or to the 230V position to select the 220V-240V range.



Line Fuse Selection

Before connecting the line power cord to the instrument, check the line fuse rating.

1. 115 Volt operation requires an 8 A, fast blow fuse.
2. 230 Volt operation requires a 4 A fast blow fuse.

Cord

In accordance with international safety standards, this instrument is equipped with a three wire alternating current power cord.

WARNING

The following precautions must be followed before the instrument is connected to the line power:

1. If this instrument is to be energized via an auto transformer for voltage reduction, the common terminal must be connected to the earth terminal of the power source.
2. The line power cord plug must only be inserted into an outlet with a protective earth contact.

The protective earth action must not be interrupted.

3. Before switching on the instrument, the protective earth terminal of the instrument must be connected to the protective earth conductor of the power cord.











This is accomplished by using the power cord which is supplied with the instrument.

4. Intentional interruption of the protective earth connection is prohibited.

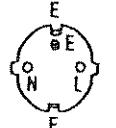
**Cords,
Types of**

See the following figure for the types of cords and part numbers of available power cords.

**FIGURE C-1.
POWER CORDS**

POWER CORD (MALE PLUG) OPTIONS					
OPTION NO.	PLUG CONFIGURATION*	SPEC. CONT. DWG. MJR. USING ENTRIES	OPTION NO.	PLUG CONFIGURATION*	SPEC. CONT. DWG. MJR. USING ENTRIES
900		A-8120-9051-1 U.K.	905		A-8120-9052-1 (SYSTEMS, CABINET, USE)
901		A-8120-9085-1 AUSTRALIA, NEW ZEALAND CHINA	906		A-8120-9100-1 SWITZERLAND
902		A-8120-9059-1 EUROPEAN CONTINENT	912		A-8120-9134-1 DENMARK
903		A-8120-9050-1 USA, CANADA (120 V),	917		A-8120-9239-1 SOUTH AFRICA, INDIA
904		A-8120-0698-1 USA, CANADA (240 V)	918		A-8120-9252-1 JAPAN**
<p>NOTE: OPTION NO. 904 <u>CANADA:</u> REQUIRES NEUTRAL CONDUCTOR IDENTIFIED RELATED TO 3 PHASE, 4 WIRE, 416 V CIRCUITS. <u>USA:</u> REQUIRES NO POLARITY BECAUSE BOTH "L" AND "N" TERMINALS ARE CONSIDERED TO BE LINE TERMINALS. **NOTE: OPTION 918 USE OPTION 918 FOR CORD SETS ONLY, FOR POWER CORDS USE OPTION 903</p>					

WARNING

Power Cord Modification

Modification must be performed only by a qualified electrician.

All local electrical codes must be observed.

If a new plug is to be connected, the plug must meet local safety requirements and include:

1. Adequate load carrying capacity (see the instrument Specifications).
2. Three terminals
 1. Line
 2. Neutral
 3. Earth
3. Cable Clamp.

HP-IB INTERFACE

Networks

The network may be:

1. A star network
2. A linear network
3. A combination star and linear network.

Limitations:

1. The total cable length cannot exceed 20 meters
2. The maximum cable length per device is 2 meters
3. No more than 15 devices may be interconnected on one bus.



1. It is recommended that no more than three connectors be stacked one on top of the other.
2. Hand tighten the connector lock screws. Do not use a screwdriver.

Cables and Adapter

The HP-IB connector is compatible with the connectors on the following cables and adapter.

1. HP-IB Cable, 10833A, 1 m (3.3 ft.)
2. HP-IB Cable, 10833B, 2 m (6.6 ft.)
3. HP-IB Cable, 10833C, 4 m (13.2 ft.)
4. HP-IB Cable, 10833D, 0.5 m (1.6 ft.)
5. HP-IB Adapter, 10834A, 2.3 cm. extender.

Connector

The following figure shows the connector and pin assignments.

Connector Part Number: 1251-0293

FIGURE C-2
HP-IB CONNECTOR

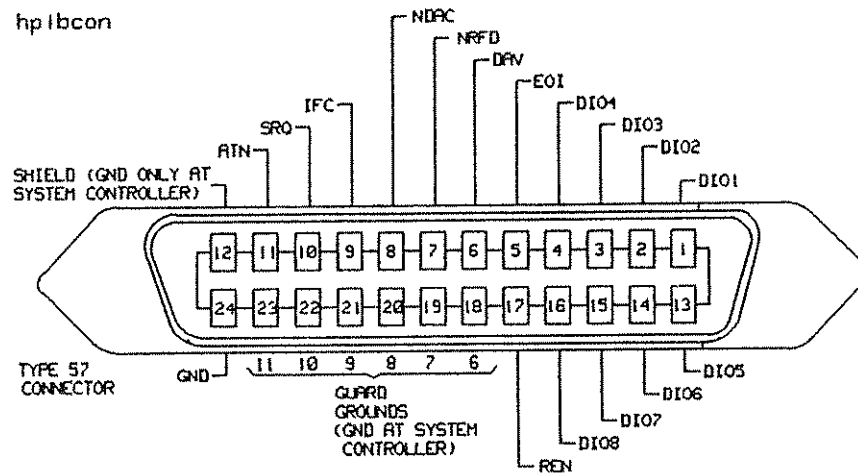

CAUTION

Connector Lock Screw Compatibility

HP products delivered now are equipped with connectors having ISO metric-threaded lock screws and stud mounts (ISO M3.5x0.6) which are black in color.

Earlier connectors may have lock screws and stud mounts with English-threaded lock screws and stud mounts (6-32 UNC) which have a shiny nickel finish.

OPERATING ENVIRONMENT

See appendix A.

MOUNTING HARDWARE

See appendix B.

PREVENTIVE MAINTENANCE

None required.

CUSTOMER SELF-SERVICE

The Service Manual contains the following service information:

1. Performance Tests
2. Adjustment Procedures
3. Theory and schematics
4. Replaceable Parts List.

HP SERVICE

HP offers the following services:

1. Performance Testing
2. Adjustment
3. Repair
4. Calibration

E

PERFORMANCE TESTS

CONTENTS

Introduction	E.0-3
Safety	E.0-3
Test Record	

Performance Tests

1. Period	E.1-1
2. Delay	E.2-1
3. Double Pulse	E.3-1
4. Width	E.4-1
5. Jitter	E.5-1
6. Transition Time	E.6-1
7. High Level, Low Level	E.7-1
8. Pulse Aberration	E.8-1
9. Data Capacity Test	E.9-1

Test Record	E.10-1
-------------	--------

TABLE

Recommended Test Equipment	E.11-1
----------------------------	--------

FIGURE

50 Ohm Feed-through	E.11.5
---------------------	--------

INTRODUCTION

The performance tests verify the instruments specified performance characteristics.

They are suitable for incoming inspection, preventative maintenance, troubleshooting, and final test.

Make the Performance Tests in the order of occurrence in the manual.

Recommended test equipment is listed in Table 1.

SAFETY

The HP 8118A is a Safety Class I instrument. It has an exposed metal chassis that is directly connected to earth potential through the line power cord.

Before testing the instrument review:

1. The Safety Summary, page ix (red page)
2. The Instrument Reference Manuals
3. The instrument safety markings.

TEST RECORD

A test record is located at the end of this chapter.

The test results are identified as TR ENTRIES in the performance tests and on the test record.

1. PERIOD TEST

SPECIFICATIONS

- Range: 20.0 ns to 950 ms
Resolution: 3 digits (best case: 100 ps)
* Accuracy: 5 % [2 %] of programmed value \pm 2 ns [1 ns]
rms Jitter: 0.05 % of programmed value + 30 ps
Repeatability: Factor 4 better than accuracy
* [value] at 20 dec C to 30 dec C ambient temperature.

EQUIPMENT

1. Counter.
2. Cable, 50 ohm, BNC to BNC, coaxial.

SET-UP

1. Connect the HP 8118A's OUTPUT (1/2) to the counter's channel A input (HP5335A) FREQ input (HP5370B).
2. Set the HP 8118A to a defined status:
SAVE = Operation : [Reset] to Standard Setting
EXEC
3. Set the HP 8118A:
 - a. SYSTEM = Pulse Generator (PULSE)
 - b. TIMING = Period : 20 [ns]
 - c. Width : 10 [ns] | 10 [ns]
 - d. Leading : 6.5 [ns] | 6.5 [ns]
 - e. Trailing : 6.5 [ns] | 6.5 [ns]
 - f. OUTPUT = State : [On] | [On]
 - g. [High Level] : [+] 1.00 V | [+] 1.00 V
 - h. Low Level : [-] 1.00 V | [-] 1.00 V

4. Set counter:
 - a. FUNCTION = PERIOD
 - b. CHANNEL A = 50 ohm
 - c. TRIGGER LEVEL= PRESET

PROCEDURE

1. Check the HP 8118A period at the following settings:

	Period	<u>ACCEPTABLE RANGE</u>			<u>TR ENTRY</u>		
1.*	20.0 ns	17 ns	[18.6 ns	-	21.4 ns]	23 ns	1-1
2.	99.9 ns	93 ns	[96.6 ns	-	102.9 ns]	107 ns	1-2
3.	100 ns	93 ns	[97 ns	-	103 ns]	107 ns	1-3
4.	500 ns	473 ns	[489 ns	-	511 ns]	527 ns	1-4
5.	999 ns	947 ns	[978 ns	-	1.02 us]	1.05 us	1-5
6.	10 us	9.5 us	[9.8 us	-	10.2 us]	10.5 us	1-6
7.	500 us	475 us	[490 us	-	510 us]	525 us	1-7
8.	1.0 ms	950 us	[980 us	-	1.02 ms]	1.05 ms	1-8
9.	950 ms	902.5 ms	[931 ms	-	969 ms]	997.5 ms	1-9

*Underprogramming to 18 ns is allowed to meet this specification.

2. Disconnect the cables from th 8118A.

2. DELAY TEST

This test consists of two parts:

1. Minimum Delay Test
2. Long Delay Test

NOTES: Repeat the entire delay test procedure for the second channel.

The specifications and tests are for the 50 % point of amplitude and fastest edges (LINEAR 6.5 ns).

SPECIFICATIONS

- Range: 75 ns to 950 ms (max.: Period + 55 ns)
 - Resolution: 3 digits (best case: 100 ps)
 - * Accuracy: 5 % [2 %] of programmed value \pm 4 ns
 - rms Jitter: 0.05 % of programmed value + 30 ps
 - Repeatability: Factor 4 better than accuracy
- * [value] at 20 dec C to 30 dec C ambient temperature.

EQUIPMENT

1. HP 54120T Digitizing Oscilloscope with Accessory
2. Pulse Generator
3. Counter
4. Cable, 50 ohm, BNC to BNC, coaxial, 2 each.

PART 1 MINIMUM DELAY TEST

SET-UP

1. Set pulse generator:
 - a. PER = 500 ns
 - b. WID = 50 ns
 - c. HIL = 1.0 V LOL = 0.0 V
 - d. Fixed Transition Time

2. Set HP 8118A:
 SAVE = Operation : [Reset] to Standard Setting
 EXEC

3. Set the HP 8118A:
 - a. SYSTEM = Pulse Generator (PULSE)
 - b. CNTRL = Trigger
 - c. State : [On]
 - d. Mode : [Trigger]
 - e. Slope : [pos]
 - f. Threshold : [+] 0.5 V
 - g. TIMING = Width : 50 [ns] | 50 [ns]
 - h. Leading : 6.5 [ns] | 6.5 [ns]
 - i. Trailing : 6.5 [ns] | 6.5 [ns]
 - j. OUTPUT = State : [On] | [On]
 - k. [High Level] : [+] 1.4 V | [+] 1.4 V

4. Connect the pulse generator's Output via a 50 ohm feedthrough to the HP 8118A's EXT INPUT.
5. Connect the HP 8118A's TRIG OUTPUT via a BNC (m) - SMA (f) Adapter, Cable assy-coaxial SMA (m-m), and APC 3.5 mm 20dB Attenuator (f-m) to the Input 3 of the HP 54121A.
6. Connect the HP 8118A OUTPUT 1/2 via a similar second accessory assembly to the Input 4 of the HP 54121A.
7. Connect the pulse generator's Trigger Output via a similar third accessory assembly to the TRIG input of the HP 54121A.

PROCEDURE

1. Set HP 54120T Oscilloscope:
 - press AUTOSCALE
 - set TIME/DIV = 20 ns/div and DELAY = 90 ns
 - select the Display menu and set the Screen function to Single
set the Number of Averages to 64
 - select the Channel menu and set the Atten factor to 10
 - select the Delta V menu and turn the voltage markers On and assign marker 1 to channel 3 and marker 2 to channel 4
 - set Preset Levels = 50-50% and press Auto Level Set
 - select the Delta t menu and turn the time markers On
 - set START ON EDGE = POS1 and STOP ON EDGE = POS1
 - Press Precise Edge Find
2. Press the Precise Edge Find key for each new Delay setting.
3. Check the HP 8118A delay at the following settings:

	<u>Delay</u>	<u>ACCEPTABLE RANGE</u>	<u>TR ENTRY</u>
1.*	75 ns	[80.5 ns]	82.75 ns 2-1
2.	80 ns	72 ns [74.4 ns - 83.6 ns]	88 ns 2-2
3.	90 ns	81.5 ns [84.2 ns - 95.8 ns]	98.5 ns 2-3
4.	99.9 ns	90.9 ns [93.9 ns - 105.8 ns]	108.9 ns 2-4

*Underprogramming to 74 ns is allowed to meet this specification.

4. Disconnect the cables from the 8118A.

PART 2 LONG DELAY TEST

SET-UP

1. Set the HP 8118A:
 - a. CNTRL = Trigger
 - b. Mode : [Auto]
 - c. TIMING = Period : 95 [us]
 - d. Width : 100 [ns] | 100 [ns]
 - e. Leading : 6.5 [ns] | 6.5 [ns]
 - f. Trailing : 6.5 [ns] | 6.5 [ns]
 - g. OUTPUT = State : [On] | [On]
 - h. [High Level] : [+] 2.4 V | [+] 2.4 V
2. Set the counter:
 - a. FUNCTION = TI A to B
 - b. START = 50 ohm, POS (+) slope, DC, XI
 - c. STOP = 50 ohm, POS (+) slope, DC, XI
 - d. Gate Time = as necessary
 - e. INPUT MODE = SEP (SEPARATE)
 - f. START/STOP trigger levels = 50% of pulse amplitudes
3. Connect the HP 8118A TRIG OUTPUT to the counter's START input.
4. Connect the HP 8118A OUTPUT 1/2 to the counter's STOP input.

PROCEDURE

1. Check the HP 8118A delay at the following Period and Delay settings:

	<u>Period</u>	<u>Delay</u>	<u>ACCEPTABLE RANGE</u>	<u>TR ENTRY</u>
1.	95 us	100 ns	91 ns [94 ns - 106 ns]	109 ns 2-5
2.	95 us	500 ns	471 ns [486 ns - 514 ns]	529 ns 2-6
3.	95 us	999 ns	945 ns [977 ns - 1023 ns]	1053 ns 2-7
4.	95 us	10 us	9.5 us [9.8 us - 10.2 us]	10.5 us 2-8
5.	999 ms	10 ms	9.5 ms [9.8 ms - 10.2 ms]	10.5 ms 2-9
6.	999 ms	950 ms	902.5ms [931 ms - 969 ms]	997.5 ms 2-10

2. Disconnect the cables from the 8118A.

3. DOUBLE PULSE TEST

This test consists of two parts:

1. Minimum Double Pulse Test
2. Long Double Pulse Test

NOTES: Repeat the entire delay test procedure for the second channel.

The specifications and tests are for the 50 % point of amplitude and fastest edge:
(LINEAR 6.5 ns).

SPECIFICATIONS

- Range: 20 ns to 950 ms (max.: Period - Width)
 - Resolution: 3 digits (best case: 100 ps)
 - * Accuracy: 5 % [2 %] of programmed value \pm 2 ns
 - rms Jitter: 0.05 % of programmed value + 30 ps
 - Repeatability: Factor 4 better than accuracy
- * [value] at 20 dec C to 30 dec C ambient temperature.

EQUIPMENT

1. HP 54120T Digitizing Oscilloscope with Accessory
2. Counter
3. Cable, 50 ohm, BNC to BNC, coaxial, 2 each.

PART 1 MINIMUM DOUBLE PULSE TEST

SET-UP

1. Set HP 8118A:
SAVE = Operation : [Reset] to Standard Setting
EXEC
2. Set the HP 8118A:
 - a. TIMING = Period : 500 [ns]
 - b. Width : 100 [ns] | 100 [ns]
 - c. Leading : 6.5 [ns] | 6.5 [ns]
 - d. Trailing : 6.5 [ns] | 6.5 [ns]
 - e. OUTPUT = State : [On] | [On]
 - f. [High Level] : [+] 1.4 V | [+] 1.4 V
3. Connect the HP 8118A's TRIG OUTPUT via a BNC (m) - SMA (f) Adapter, Cable assy-coaxial SMA (m-m), and APC 3.5 mm 20dB Attenuator (f-m) to the TRIG Input of the HP 54121A.
4. Connect the HP 8118A OUTPUT 1/2 via a similar second accessory assembly to the Input 4 of the HP 54121A.

PROCEDURE

1. Setup HP 54120T Oscilloscope:
 - press AUTOSCALE
 - center one pulse horizontal and vertical on screen (TIME/DIV = 20 ns/div, VOLT/DIV = 500 mV/div)
 - select the Display menu and set the Number of Averages to 64
 - select the Channel menu and set the Atten factor to 10
 - select the Delta V menu and turn the voltage markers On
 - set Preset Levels = 50-50% and press Auto Level Set
 - select the Delta t menu and turn the time markers On
 - set START ON EDGE = POS1 and STOP ON EDGE = POS2
2. Change the HP8118A Width to 10 [ns].
and the [Delay] to [Double]: 20 [ns].
3. Press the Precise Edge Find key for each new Double setting.
4. Check the HP 8118A double pulse delay at the following settings:

Double

ACCEPTABLE RANGE

TR ENTRY

1.	20 ns	17 ns [17.6 ns	-	22.4 ns]	23 ns	3-1
2.	50 ns	45.5 ns [47 ns	-	53 ns]	54.5 ns	3-2
3.	80 ns	74 ns [76.4 ns	-	83.6 ns]	86 ns	3-3
4.	99.9 ns	93 ns [95.9 ns	-	103.9 ns]	107 ns	3-4

5. Disconnect the cables from the 8118A.

PART 2 LONG DOUBLE PULSE TEST

SET-UP

1. Set the HP 8118A:
 - a. TIMING = Period : 95 [us]
 - b. Width : 100 [ns] | 100 [ns]
 - c. Leading : 6.5 [ns] | 6.5 [ns]
 - d. Trailing : 6.5 [ns] | 6.5 [ns]
 - e. OUTPUT = State : [On] | [On]
 - [High Level] : [+] 1.0 V | [+] 1.0 V
 - low level : [-] 1.0 V | [-] 1.0 V

2. Set the counter:
 - a. FUNCTION = TI A to B
 - b. START = 50 ohm, POS (+) slope, DC, X1
 - c. STOP = 50 ohm, POS (+) slope, DC, X1
 - d. Gate Time = as necessary
 - e. INPUT MODE = COM
 - f. START/STOP trigger levels = Preset

3. Connect the HP 8118A OUTPUT 1/2 to the counter's START input.

PROCEDURE

1. Check the HP 8118A double pulse delay at the following Period and Double settings:

	<u>Period</u>	<u>Double</u>	<u>ACCEPTABLE RANGE</u>				<u>TR ENTRY</u>	
1.	95 us	1 us	948 ns	[978 ns	-	1.02 us]	1.05 us	3-5
2.	95 us	10 us	9.5 us	[9.8 us	-	10.2 us]	10.5 us	3-6
3.	95 ms	100 us	95 us	[98 us	-	102 us]	105 us	3-7
4.	95 ms	1 ms	950 us	[980 us	-	1.02 ms]	1.05 ms	3-8
5.	95 ms	10 ms	9.5 ms	[9.8 ms	-	10.2 ms]	10.5 ms	3-9
6.	999 ms	100 ms	95 ms	[98 ms	-	102 ms]	105 ms	3-10
6.	999 ms	500 ms	475 ms	[490 ms	-	510 ms]	525 ms	3-11

2. Disconnect the cables from the 8118A.

4. WIDTH TEST

This test consists of two parts.

1. Minimum Width Test
2. Long Width Test

NOTES: Repeat the entire width test procedure for the second channel.

The specifications and tests are for the 50 % point of amplitude and fastest transition edges (LINEAR 6.5 ns).

SPECIFICATIONS

- Range: 10.0 ns to 950 ms (max.: Period - 10 ns)
 - Resolution: 3 digits (best case: 100 ps)
 - *Accuracy: 5 % [2 %] of programmed value \pm 2 ns
 - rms Jitter: 0.05 % of programmed value + 30 ps
 - Repeatability: Factor 4 better than accuracy
- *[value] at 20 dec C to 30 dec C ambient temperature.

EQUIPMENT

1. HP 54120T Digitizing Oscilloscope with Accessory
2. Counter
3. Cable, 50 ohm, BNC to BNC, coaxial, 2 each.

PART 1 MINIMUM WIDTH TEST

SET-UP

1. Set HP 8118A:
SAVE = Operation : [Reset] to Standard Setting
EXEC
2. Set the HP 8118A:
 - a. TIMING = Period : 500 [ns]
 - b. Width : 100 [ns] | 100 [ns]
 - c. Leading : 6.5 [ns] | 6.5 [ns]
 - d. Trailing : 6.5 [ns] | 6.5 [ns]
 - e. OUTPUT = State : [On] | [On]
 - f. [High Level] : [+] 1.4 V | [+] 1.4 V
3. Connect the HP 8118A's TRIG OUTPUT via a BNC (m) - SMA (f) Adapter, Cable assy-coaxial SMA (m-m), and APC 3.5 mm 20dB Attenuator (f-m) to the TRIG Input of the HP 54121A.
4. Connect the HP 8118A OUTPUT 1/2 via a similar second accessory assembly to the Input 4 of the HP 54121A.

PROCEDURE

1. Setup HP 54120T Oscilloscope:
 - press AUTOSCALE
 - center one pulse horizontal and vertical on screen (TIME/DIV = 20 ns/div, VOLT/DIV = 500 mV/div)
 - select the Display menu and set the Number of Averages to 64
 - select the Channel menu and set the Atten factor to 10
 - select the Delta V menu and turn the voltage markers On
 - set Preset Levels = 50-50% and press Auto Level Set
 - select the Delta t menu and turn the time markers On
 - set START ON EDGE = POS1 and STOP ON EDGE = NEG1
2. Change the HP8118A Width to 10 [ns].
3. Press the Precise Edge Find key for each new Width setting.

4. Check the HP 8118A pulse width at the following settings:

	<u>Width</u>	<u>ACCEPTABLE RANGE</u>				<u>TR ENTRY</u>	
1.	10 ns	7.5 ns	[7.8 ns	-	12.2 ns]	12.5 ns	4-1
2.	20 ns	17 ns	[17.6 ns	-	22.4 ns]	23 ns	4-2
3.	50 ns	45.5 ns	[47 ns	-	53 ns]	54.5 ns	4-3
4.	80 ns	74 ns	[76.4 ns	-	83.6 ns]	86 ns	4-4
5.	99.9 ns	93 ns	[95.9 ns	-	103.9 ns]	107 ns	4-5

5. Disconnect the cables from the 8118A.

PART 2 LONG WIDTH TESTS

SET-UP

1. Set the HP 8118A:

a.	TIMING	= Period	: 95 [us]		
b.		Width	: 500 [ns]		500 [ns]
c.		Leading	: 6.5 [ns]		6.5 [ns]
d.		Trailing	: 6.5 [ns]		6.5 [ns]
e.	OUTPUT	= State	: [On]		[On]
f.		[High Level]	: [+] 1.0 V		[+] 1.0 V
		low level	: [-] 1.0 V		[-] 1.0 V

2. Set the counter:

- FUNCTION = TI A to B
- START = 50 ohm, POS (+) slope, DC, X1
- STOP = 50 ohm, NEG (-) slope, DC, X1
- Gate Time = as necessary
- INPUT MODE = COM
- START/STOP trigger levels = Preset

3. Connect the HP 8118A OUTPUT 1/2 to the counter's START input.

PROCEDURE

1. Check the HP 8118A pulse width at the following Period and Width settings:

	<u>Period</u>	<u>Width</u>	<u>ACCEPTABLE RANGE</u>	<u>TR ENTRY</u>
1.	95 us	1 us	948 ns [978 ns - 1.02 us]	1.05 us 4-6
2.	95 us	10 us	9.5 us [9.8 us - 10.2 us]	10.5 us 4-7
3.	95 ms	100 us	95 us [98 us - 102 us]	105 us 4-8
4.	95 ms	1 ms	950 us [980 us - 1.02 ms]	1.05 ms 4-9
5.	95 ms	10 ms	9.5 ms [9.8 ms - 10.2 ms]	10.5 ms 4-10
6.	999 ms	100 ms	95 ms [98 ms - 102 ms]	105 ms 4-11
7.	999 ms	500 ms	475 ms [490 ms - 510 ms]	525 ms 4-12

5. JITTER TESTS

This test consists of three parts: Period Jitter, Delay Jitter, and Width Jitter.

Repeat the tests for the second channel.

SPECIFICATIONS

rms Jitter: 0.05% of programmed value + 30 ps

EQUIPMENT

1. HP 54120T Digitizing Oscilloscope with Accessory

PART 1 PERIOD JITTER TEST

SET-UP

1. Set HP 8118A:
SAVE = Operation : [Reset] to Standard Setting
EXEC
2. Set the HP 8118A:
 - a. TIMING = Period : 100 [ns]
 - b. Width : 50 [ns] | 50 [ns]
 - c. Leading : 6.5 [ns] | 6.5 [ns]
 - d. Trailing : 6.5 [ns] | 6.5 [ns]
 - e. OUTPUT = State : [On] | [On]
 - f. [High Level] : [+] 5.00 V | [+] 5.00 V
 - g. Low Level : [-] 5.00 V | [-] 5.00 V

3. Connect an APC 3.5 mm 20dB Attenuator (f-m), 1 each to the TRIG Input and to the Input 4 of the HP 54121A.
4. Connect one output, APC 3.5 mm (f), of the Power Splitter HP 11667B via a SMA (m-m) Adapter to the 20dB Attenuator at the TRIG Input of the 54121A.
5. Connect to the other output of the Power Splitter a SMA (m) - BNC (f) Adapter and connect 4 BNC (m-m) cables (61 cm) together to this adapter (use BNC Adapters (f-f), 3 each).
6. Connect this cable assembly via a BNC (f) - SMA (m) Adapter to the 20dB Attenuator at the Input 4 of the 54121A.
7. Connect the 8118A OUTPUT 1/2 via a BNC (m) - SMA (f) Adapter, Cable assy-coaxial SMA (m-m) to the Input of the Power Splitter.

PROCEDURE

1. Setup HP 54120T Oscilloscope:
 - press AUTOSCALE
 - select the Display menu and set the Number of Averages to 128
 - select the Timebase menu and set the TIME/DIV to 500 ps/div
 - center the first positive going edge of the signal (approx. Delay = 21.x ns)
 - select the Channel menu and set the Atten factor to 1 (Channel 4)
 - set the VOLT/DIV to 20 mV/div
 - select the Delta V menu and turn the V Markers On
 - set the Marker 1 Position to -50 mV and the Marker 2 Position to -45 mV
 - select the Delta t menu and turn the T Markers On
 - set START ON EDGE = POS1 and STOP ON EDGE = POS1
 - press the Precise Edge Find key
2. Record the delta t! It is the risetime of the ref. signal within a 1% amplitude window of the signal connected to Input 4. This value is needed later to calculate the correct jitter.

3. Select the scopes Timebase menu and center the second positive going edge of the signal (actual Delay + 10x.x ns = approx. Delay 120 ns)
4. Press More and Histogram.
5. Select the Window submenu and set:
 - Source is Channel 4
 - choose the time Histogram
 - press WINDOW MARKER 1 and set it to -50 mV
 - press WINDOW MARKER 2 and set it to -45 mV
6. Select the Acquire submenu and set the Number of Samples to 1000.
Press Start Acquiring.
7. After the data for the time histogram is acquired (#Samples = 100%), select the Result submenu.
8. Press Mean and Sigma. Notice the value of Sigma!
9. The rms jitter has to be calculated as follows:

$$\frac{(\text{Sigma} \times 6) - \text{delta t of ref. signal}}{6}$$
10. Max. rms jitter (period = 100 ns) is 80 ps

TR ENTRY 5-1

PART 2 WIDTH JITTER TEST

SET-UP

1. Same set-up as before.
2. Set the HP 8118A:
 - a. TIMING = Period : 1 [us]
 - b. Width : 500 [ns] | 500 [ns]

PROCEDURE

1. Setup HP 54120T Oscilloscope:
 - press the More key
 - select the Display menu and set the #Aves = 256
 - select the Timebase menu and center the first negative going edge of the signal (approx. Delay = 52x.x ns)
 - select the Delta V menu and set the Marker 1 Position to +50 mV and the Marker 2 Position to +45 mV
 - select the Delta t menu and set START ON EDGE = NEG1 and STOP ON EDGE = NEG1
 - press the Precise Edge Find key
2. Record the delta t! It is the risetime of the signal within a 1% amplitude window of the signal connected to Input 4. This value is needed later to calculate the correct jitter.
3. Press More = Histogram.
4. Select the Window submenu and
 - press WINDOW MARKER 1 and set it to +50 mV
 - press WINDOW MARKER 2 and set it to +45 mV
5. Select the Acquire submenu and press Start Acquiring.
6. After the data for the time histogram is acquired (#Samples = 100%), select the Result submenu.

7. Press Mean and Sigma. Notice the value of Sigma!

8. The rms jitter is calculated as follows:

$$\frac{(\text{Sigma} \times 6) - \text{delta t of signal}}{6}$$

9. Max. rms jitter (width = 500 ns) is 280 ps

TR ENTRY 5-2

10. Disconnect the cables from the 8118A.

PART 3 DELAY JITTER TEST

SET-UP

1. Set the HP 8118A:
 - a. TIMING = Period : 500 [ns]
 - b. Delay : 250 [ns] | 250 [ns]
 - c. Width : 50 [ns] | 50 [ns]
 - ! d. OUTPUT = [High Level] : [+]
! e. Low Level : [-]
2. Connect the HP 8118A's TRIG OUTPUT via a BNC (m) - SMA (f) Adapter, Cable assy-coaxial SMA (m-m), and APC 3.5 mm 20dB Attenuator (f-m) to the TRIG Input of the HP 54121A.
3. Connect the HP 8118A OUTPUT 1/2 via a same second accessory assembly to the Input 4 of the HP 54121A.

PROCEDURE

1. Setup HP 54120T Oscilloscope:
 - press AUTOSCALE
 - select the Display menu and set the #Aves = 128
 - select the Timebase menu and set the TIME/DIV = 200 ps/div
 - center the first positive going edge of the signal (approx. Delay = 24x.x ns)
 - select the Channel menu and set the VOLT/DIV = 20 mV/div
2. Press More = Histogram.
3. Select the Window submenu and
 - press WINDOW MARKER 1 and set it to -50 mV
 - press WINDOW MARKER 2 and set it to -45 mV

4. Select the Acquire submenu and press Start Acquiring.
5. After the data for the time histogram is acquired (#Samples = 100%), select the Result submenu.
6. Press Mean and Sigma. Notice the value of Sigma!
7. The rms jitter has to be calculated as follows:

$$\frac{(\text{Sigma} \times 6) - \text{delta t of ref. signal}}{6}$$

8. Max. rms jitter (delay = 250 ns) is 155 ps
9. Disconnect the cables from the 8118A.

TR ENTRY 5-3

6. TRANSITION TIME TEST

This test consists of two parts.

1. Fast Transition Time Test
2. Slow Transition Time Test

NOTE: Repeat the entire transition time test procedure for the second channel.

SPECIFICATIONS

Range: 6.5 ns to 95 ms
Resolution: 3 digits (best case: 100 ps)
*Accuracy: 5 % of programmed value \pm 2 ns

EQUIPMENT

1. HP 54120T Digitizing Oscilloscope with Accessory
2. Counter
3. DVM
4. Time Interval Probes and T. I. Probe Adapter
5. Cable, 50 ohm, BNC to BNC, coaxial, 4 each.
6. 50 ohm feedthrough termination, **0.1%**, **10 W**
7. Adapter, BNC to dual banana plug

PART 1 FAST TRANSITION TIME TEST

SET-UP

1. Set HP 8118A:
SAVE = Operation : [Reset] to Standard Setting
EXEC

2. Set the HP 8118A:
 - a. TIMING = Period : 1 [ms]
 - b. Width : 500 [us] | 500 [us]
 - c. Leading : 6.5 [ns] | 6.5 [ns]
 - d. Trailing : 50 [ns] | 50 [ns]
 - e. OUTPUT = State : [On] | [On]
 - f. [High Level] : [+] 1.4 V | [+] 1.4 V

3. Connect the HP 8118A's TRIG OUTPUT via a BNC (m) - SMA (f) Adapter, Cable assy-coaxial SMA (m-m), and APC 3.5 mm 20dB Attenuator (f-m) to the TRIG Input of the HP 54121A.

4. Connect the HP 8118A OUTPUT 1/2 via a similar second accessory assembly to the Input 4 of the HP 54121A.

PROCEDURE

1. Setup HP 54120T Oscilloscope:
 - press AUTOSCALE
 - center one pulse horizontal and vertical on screen (TIME/DIV = 100 us/div, VOLT/DIV = 200 mV/div)
 - select the Display menu and set the Number of Averages to 64
 - select the Channel menu and set the Atten factor to 10
 - select the Delta V menu and turn the voltage markers On
 - set Preset Levels = 10-90% and press Auto Level Set
 - select the Timebase menu and set TIME/DIV = 20 ns, DELAY = 16 ns
 - select the Delta t menu and turn the time markers On
 - set START ON EDGE = POS1 and STOP ON EDGE = POS1

2. Set HP 8118A: Period: 500 [ns] Width: 250 [ns]
3. While the Oscilloscope is in the Delta t menu, press the Precise Edge Find Key.
4. For each new 8118A leading setting, CLEAR DISPLAY and after the #Avs = 64 press the Precise Edge Find key.
5. Check the 8118A output signal rise times at the following leading settings.

	<u>Leading</u>	<u>ACCEPTABLE RANGE</u>		<u>TR ENTRY</u>
1.*	6.5 ns		8.83 ns	6-1
2.	10 ns	7.5 ns	12.5 ns	6-2
3.	50 ns	45.5 ns	54.5 ns	6-3
4.	99.9 ns	93 ns	107 ns	6-4

*Underprogramming to 5.5 ns is allowed to meet this specification.

6. Set HP 8118A: Leading: 50 [ns] Trailing: 6.5 [ns]
7. Select the scopes Timebase menu and set DELAY = 780 ns
Select the scopes Delta t menu and set START ON EDGE = NEG1 and STOP ON EDGE = NEG1
8. While the Oscilloscope is in the Delta t menu, press the Precise Edge Find Key.
9. For each new 8118A trailing setting, CLEAR DISPLAY and after the #Avs = 64 press the Precise Edge Find key.
10. Check the 8118A output signal fall times at the following trailing settings.

	<u>Trailing</u>	<u>ACCEPTABLE RANGE</u>		<u>TR ENTRY</u>
1.*	6.5 ns		8.83 ns	6-5
2.	10 ns	7.5 ns	12.5 ns	6-6
3.	50 ns	45.5 ns	54.5 ns	6-7
4.	99.9 ns	93 ns	107 ns	6-8

*Underprogramming to 5.5 ns is allowed to meet this specification.

11. Disconnect the cables from the 8118A.

PART 2 SLOW TRANSITION TIME TEST

SET-UP

1. Set the Multimeter (HP 3478):
 - a. SGL TRIG = Single Trigger
 - b. Blue/AUTO ZERO = Auto Zero off
 - c. BLUE/4 = 4 digits
2. Set the counter:
 - a. FUNCTION = TI A to B
 - b. INPUT MODE = SEP (SEPARATE)
 - c. START = 50 ohm, POS (+) slope, DC, X1
 - d. STOP = 50 ohm, POS (+) slope, DC, X1
 - e. START/STOP Trigger Levels = Preset
 - f. EXT ARM
 - g. EXT Level and Slope as necessary
3. Set the time interval probes:
 - a. Start channel = 'A +0.5 POSITIVE SLOPE'
 - b. Stop channel = 'A +4.5 POSITIVE SLOPE'
4. Connect the Time Interval Channel A probe to a TI probe adapter.
5. Attach the TI probe adapter to the TEE, BNC (f).
6. Attach the 50 ohm feedthrough termination to the TEE, BNC (m).
7. Attach a BNC cable to the TEE, BNC (f).
8. **CALIBRATE** the time interval probes!
Perform the LEVEL operation; hold the CAL switch in the LEVEL position until the channel leds are on.
NOTE: Perform the calibration with the TEE, 50 ohm termination, and the cable attached.
9. Connect the TI Probe's rear panel outputs to the counter inputs.
 - a. START output to Channel A input.
 - b. STOP output to Channel B input.
10. Connect the BNC cable from the TEE, BNC to the HP 8118A's OUTPUT I/2
11. Connect the 50 ohm terminator via a BNC/banana plug adapter to the DVM.
12. Connect the 8118A TRIGGER OUTPUT to the DVM trigger input and the counter's EXT Input.

PROCEDURE

1. Set the HP 8118A:

TIMING	= Period	: 100 [ms]		
	Delay	: 30 [ms]		30 [ms]
	Width	: 50 [ms]		50 [ms]
	Leading	: 500 [ns]		500 [ns]
	Trailing	: 500 [ns]		500 [ns]
OUTPUT	= State	: [On]		[On]
	[High Level]	: [+] 4.9x V		[+] 4.9x V
2. Change the high level with the up/down ROLL key = VERNIER to get the best 5.00x V reading on the DVM.
3. Set the HP 8118A:

TIMING	= Delay	: 30 [us]		30 [us]
OUTPUT	= Low Level	: [+] 0.0x V		[+] 0.0x V
4. Change the low level with the up/down ROLL key = VERNIER to get the best 0.00x V reading on the DVM.
5. Press the 8118A TIMING key and check the 8118A OUTPUT risetime at the following settings.

	<u>Trailing</u>	<u>Leading</u>	<u>ACCEPTABLE RANGE</u>		<u>TR ENTRY</u>
1.	500 ns	500 ns	473 ns	527 ns	6-9
2.		999 ns	947 ns	1.05 us	6-10
3.		5 us	4.75 us	5.25 us	6-11
4.		9.99 us	9.49 us	10.49 us	6-12
5.	50 us	50 us	47.5 us	52.5 us	6-13
6.		99.9 us	94.9 us	104.9 us	6-14
7.		500 us	475 us	525 us	6-15
8.		999 us	949 us	1.049 ms	6-16
9.	5 ms	5 ms	4.75 ms	5.25 ms	6-17
10.		10 ms	9.5 ms	10.5 ms	6-18
*11.		95 ms	90.25 ms	99.75 ms	6-19

NOTES: Repeat steps 1 to 4 to obtain the best +5.00x V/0.00x V reading on the DVM.

* Change the 8118A setting to Period : 500 ms Width : 250 ms

6. Set the time interval probes:
 - a. Start channel = 'A +4.5 NEGATIVE SLOPE'
 - b. Stop channel = 'A +0.5 NEGATIVE SLOPE'
7. Set the 8118A Period : 100 ms Width : 50 ms
8. Check the 8118A OUTPUT falltime at the following settings.

	<u>Leading</u>	<u>Trailing</u>	<u>ACCEPTABLE RANGE</u>		<u>TR ENTRY</u>
1.	500 ns	500 ns	473 ns	527 ns	6-20
2.		999 ns	947 ns	1.05 us	6-21
3.		5 us	4.75 us	5.25 us	6-22
4.		9.99 us	9.49 us	10.49 us	6-23
5.	50 us	50 us	47.5 us	52.5 us	6-24
6.		99.9 us	94.9 us	104.9 us	6-25
7.		500 us	475 us	525 us	6-26
8.		999 us	949 us	1.049 ms	6-27
9.	5 ms	5 ms	4.75 ms	5.25 ms	6-28
10.		10 ms	9.5 ms	10.5 ms	6-29
*11.		95 ms	90.25 ms	99.75 ms	6-30

NOTES: Repeat steps 1 to 4 to obtain the best +5.00x V/0.00x V reading on the DVM.

* Change the 8118A setting to Period : 500 ms Width : 250 ms

9. Disconnect the cables from the 8118A.

7. HIGH LEVEL AND LOW LEVEL TESTS

Repeat the high level and low level tests for the second channel.

SPECIFICATIONS

NOTE: This specification applies to 50 ohm sources and 50 ohm loads.

High Level: -7.90 V to 8.00 V.

Low Level: -8.00 V to 7.90 V.

Resolution: 3 digits (best case: 10.0 mV).

* Level Accuracy: 1% of programmed value \pm 3% [1%] of pulse amplitude, \pm 40 mV [20 mV].

Repeatability: Factor 4 better than accuracy

Settling time: 100 ns + transition time.

* [value] at 20 dec C to 30 dec C ambient temperature.

EQUIPMENT

1. Multimeter
2. 50 ohm feedthrough termination, **0.1%, 10 W**
3. Adapter, BNC to dual banana plug
4. Cables, BNC to BNC, two each.

SET-UP

1. Set HP 8118A:
SAVE = Operation : [Reset] to Standard Setting
EXEC

2. Set the HP 8118A:
 - a. TIMING = Period : 100 [ms]
 - b. [Delay] : 30 [ms] | 30 [ms]
 - c. Width : 50 [ms] | 50 [ms]
 - d. Leading : 6.5 [ns] | 6.5 [ns]
 - e. Trailing : 6.5 [ns] | 6.5 [ns]
 - f. OUTPUT = State : [On] | [On]

3. Set the Multimeter (HP 3478).
 - a. SGL TRIG = Single Trigger
 - b. Blue/AUTO ZERO = Auto Zero off
 - c. BLUE/4 = 4 digits

4. Connect the HP 8118A OUTPUT 1/2 to the Multimeter's input via a 50 ohm feedthrough (**0.1%**, **10 W**) and a BNC to dual banana plug adapter.

5. Connect the HP 8118A TRIG OUTPUT to the Multimeter's trigger input.

PROCEDURE

HIGH LEVEL TEST

1. Check the 8118A high level at the following [High Level] settings with the Low Level set to 0.00 V.

	<u>High Level</u>	<u>ACCEPTABLE RANGE</u>			<u>TR ENTRY</u>	
1.	[+]0.1 V	56 mV [78 mV -	122 mV]	144 mV	7-1
2.	[+]0.5 V	440 mV [470 mV -	530 mV]	560 mV	7-2
3.	[+] 1 V	920 mV [960 mV -	1.04 V]	1.08 V	7-3
4.	[+] 5 V	4.76 V [4.88 V -	5.12 V]	5.24 V	7-4
5.*	[+] 8 V	7.64 V [7.82 V -	8.18 V]	8.36 V	7-5

* Overprogramming to 8.2 V is allowed to meet this spec.

The low level 0.0 V may vary within $\pm 3\%$ [1%] of pulse amplitude, ± 40 mV [20 mV].

LOW LEVEL TEST

1. Set the HP 8118A:

a.	TIMING	= [Delay]	: 30 [us]		30 [us]
b.	OUTPUT	= [High Level]	: [+] 0.00 V		[+] 0.00 V
		[Low Level]	: [-] 0.10 V		[-] 0.01 V

2. Check the 8118A low level at the following Low Level settings with the High Level set to 0.00 V.

	<u>Low Level</u>	<u>ACCEPTABLE RANGE</u>	<u>TR ENTRY</u>
1.	[-] 0.1 V	- 56 mV [- 78 mV - - 122 mV]	- 144 mV 7-6
2.	[-] 0.5 V	- 440 mV [- 470 mV - - 530 mV]	- 560 mV 7-7
3.	[-] 1 V	- 920 mV [- 960 mV - - 1.04 V]	- 1.08 V 7-8
4.	[-] 5 V	- 4.76 V [- 4.88 V - - 5.12 V]	- 5.24 V 7-9
5.*	[-] 8 V	- 7.64 V [- 7.82 V - - 8.18 V]	- 8.36 V 7-10

* Overprogramming to -8.2 V is allowed to meet this spec.

The high level 0.0 V may vary within $\pm 3\%$ [1%] of pulse amplitude, ± 40 mV [20 mV].

3. Disconnect the cables from the 8118A.

8. PULSE ABERRATION TEST

Repeat this test for the second channel.

SPECIFICATIONS

Preshoot, Overshoot, and Ringing: $\leq 5\%$ of the pulse amplitude ± 10 mV.
(may increase to $\leq 7\%$ for edges < 10 ns)

EQUIPMENT

1. HP 54120T Digitizing Oscilloscope with Accessory

SET-UP

1. Set HP 8118A:
SAVE = Operation : [Reset] to Standard Setting
EXEC
2. Set the HP 8118A:
 - a. TIMING = Period : 500 [ns]
 - b. Width : 250 [ns] | 250 [ns]
 - c. Leading : 6.5 [ns] | 6.5 [ns]
 - d. Trailing : 6.5 [ns] | 6.5 [ns]
 - e. OUTPUT = State : [On] | [On]
 - f. [High Level] : [+] 5.0 V | [+] 5.0 V
3. Connect the HP 8118A's TRIG OUTPUT via a BNC (m) - SMA (f) Adapter, Cable assy-coaxial SMA (m-m), and APC 3.5 mm 20dB Attenuator (f-m) to the TRIG Input of the HP 54121A.
4. Connect the HP 8118A OUTPUT 1/2 via a same second accessory assembly to the Input 4 of the HP 54121A.

PROCEDURE

1. Setup HP 54120T Oscilloscope:
 - press AUTOSCALE
 - select the Display menu and set the Number of Averages to 64
 - select the Channel menu and set the Atten factor to 10
 - center one pulse horizontal and vertical on screen (TIME/DIV = 50 ns/div, VOLT/DIV = 800 mV/div)
 - select the Delta V menu and turn the voltage markers On
 - set Preset Levels = variable
 - set the VARIABLE LEVELS to 93-107% and press Auto Level Set
 - select the Channel menu and center vertical the pulse top with OFFSET (Offset=5V)
 - set the VOLTS/DIV to 100 mV/div
 - select the Timebase menu
 - set the TIME/DIV to Sweep Speed = 50 ns/div and Delay to 70 ns

2. Check that the 8118A Overshoot, Ringing (and Preshoot) is within the limits ($\leq 7\%$).
TR ENTRY 8-1.

3. Change the 8118A leading and trailing edges to 10 ns.

4. Select the scopes Delta V menu and set the variable levels to 95-105%

5. Check that the 8118A Overshoot, Ringing (and Preshoot) is within the limits ($\leq 5\%$).
TR ENTRY 8-2.

(Take the scopes trace flatness error (GaAs input circuit) into account.)

6. Disconnect the cables from the 8118A.

9. DATA CAPACITY TEST

Repeat this test for the second channel.

SPECIFICATIONS

Data Capacity: 16384 bits per channel

EQUIPMENT

1. HP 54120T Digitizing Oscilloscope with Accessory
2. Counter HP 5335A
3. Cable, 50 ohm, BNC to BNC, coaxial

SET-UP

1. Set the HP 8118A:
 - SAVE = Operation : [Reset] to Standard Setting
 - EXEC

2. Set the HP 8118A:
 - a. SYSTEM = Pattern Generator (PATTERN)
 - b. TIMING = Period : 200 [ns]
 - c. Width : 100 [ns] | 100 [ns]
 - d. Strobe Width : 50 [ns]
 - e. OUTPUT = State : [On] | [On]
 - f. [High Level] : [+] 1.00 V | [+] 1.00 V
 - g. Low Level : [-] 1.00 V | [-] 1.00 V
 - h. Strobe : Word
 - i. DATA = Data [Entry]
 - j. blue OUTPUT = MODIFY
 - k. [SET] [both Channels] from Word [0] through [2047]
 - l. EXEC
 - m. blue EXEC = UPDATE
 - n. START

3. Set counter (5335A):
 - a. FUNCTION = TOT A
 - b. CHANNEL A = 50 ohm
 - c. TRIGGER LEVEL = PRESET
 - d. GATE MODE = MANUAL
4. Connect the HP 8118A's OUTPUT 1 to the counter's Channel A input (HP5335A).
5. Connect the 8118A's STROBE OUTPUT (rear panel) via a BNC (m) - SMA (f) Adapter, Cable assy-coaxial SMA (m-m), and APC 3.5 mm 20dB Attenuator (f-m) to the TRIG Input of the 54121A.
6. Connect the 8118A's OUTPUT 2 via a similar accessory assembly to the Input 4 of the HP 54121A.

PROCEDURE

1. Setup HP 54120T Oscilloscope:
 - press AUTOSCALE
 - select the Display menu and set the Screen function to Single
 - set the Number of Averages to 64
 - select the Channel menu and set the Atten factor to 10
 - select the Measure menu
2. Check the 8118A OUTPUT 2 Period and Width.
3. Set the HP 8118A:

DATA and NEXT[]	= Data [Format]
	Cycling Mode : [Single]
4. Reset the counter, and open the gate.
5. After pressing the HP 8118A START key, the counter reading must be 16384.

6. Set the HP 8118A:
 - a. TIMING = Period : 20 [ns]
 - b. Width : 10 [ns] | 10 [ns]
 - c. Leading : 6.5 [ns] | 6.5 [ns]
 - d. Trailing : 6.5 [ns] | 6.5 [ns]
 - e. Strobe Width : 10 [ns]
 - f. DATA = Data [Format]
 - g. Cycling Mode : [Auto]
 - h. START

7. Press on scope the CLEAR DISPLAY key.

8. Check the HP 8118A Period and Width.

9. Set the HP 8118A:
 - DATA = Data [Format]
 - Cycling Mode : [Single]

10. Reset the counter and open the gate.

11. After pressing the 8118A's START key, the counter reading must be 16384.
TR ENTRY 9-1.

12. Exchange the 8118A's OUTPUT 1/2 cables, and repeat the complete test.

13. Disconnect the cables from the 8118A.

PERFORMANCE TEST RECORD

MODEL: HP 8118A

TESTED BY: _____

SERIAL NUMBER: _____

DATE: _____

COMMENTS: _____

<u>TEST</u>	<u>LIMIT MINIMUM</u>	<u>ACTUAL (TR ENTRY)</u>	<u>LIMIT MAXIMUM</u>	<u>PASS</u>	<u>FAIL</u>
PERIOD:					
20 ns	17 ns	(1-1) _____	23 ns	_____	_____
99.9 ns	93 ns	(1-2) _____	107 ns	_____	_____
100 ns	93 ns	(1-3) _____	107 ns	_____	_____
500 ns	473 ns	(1-4) _____	527 ns	_____	_____
999 ns	947 ns	(1-5) _____	1.05 us	_____	_____
10 us	9.5 us	(1-6) _____	1.05 us	_____	_____
500 us	475 us	(1-7) _____	525 us	_____	_____
1 ms	950 us	(1-8) _____	1.05 ms	_____	_____
950 ms	902.5 ms	(1-9) _____	997.5 ms	_____	_____

<u>TEST</u>	<u>LIMIT MINIMUM</u>	<u>ACTUAL (TR ENTRY)</u>	<u>LIMIT MAXIMUM</u>	<u>PASS</u>	<u>FAIL</u>
-------------	--------------------------	------------------------------	--------------------------	-------------	-------------

MINIMUM DELAY:

75 ns		(2-1) _____	82.75 ns	_____	_____
80 ns	72 ns	(2-2) _____	88 ns	_____	_____
90 ns	81.5 ns	(2-3) _____	98.5 ns	_____	_____
99.9 ns	90.0 ns	(2-4) _____	108.9 ns	_____	_____

LONG DELAY

100 ns	91 ns	(2-5) _____	109 ns	_____	_____
500 ns	471 ns	(2-6) _____	529 ns	_____	_____
999 ns	945 ns	(2-7) _____	1053 ns	_____	_____
10 us	9.5 us	(2-8) _____	10.5 us	_____	_____
10 ms	9.5 ms	(2-9) _____	10.5 ms	_____	_____
950 ms	902.5 ms	(2-10) _____	997.5 ms	_____	_____

MINIMUM DOUBLE PULSE:

20 ns	17 ns	(3-1) _____	23 ns	_____	_____
50 ns	45.5 ns	(3-2) _____	54.5 ns	_____	_____
80 ns	74 ns	(3-3) _____	86 ns	_____	_____
99.9 ns	93 ns	(3-4) _____	107 ns	_____	_____

LONG DOUBLE PULSE:

1 us	948 ns	(3-5) _____	1.05 us	_____	_____
10 us	9.5 us	(3-6) _____	10.5 us	_____	_____
100 us	95 us	(3-7) _____	105 us	_____	_____
1 ms	950 us	(3-8) _____	1.05 ms	_____	_____
10 ms	9.5 ms	(3-9) _____	10.5 ms	_____	_____
100 ms	95 ms	(3-10) _____	105 ms	_____	_____
500 ms	475 ms	(3-11) _____	525 ms	_____	_____

<u>TEST</u>	<u>LIMIT MINIMUM</u>	<u>ACTUAL (TR ENTRY)</u>	<u>LIMIT MAXIMUM</u>	<u>PASS</u>	<u>FAIL</u>
MINIMUM WIDTH:					
10 ns	7.5 ns	(4-1) _____	12.5 ns	_____	_____
20 ns	17 ns	(4-2) _____	23 ns	_____	_____
50 ns	45.5 ns	(4-3) _____	54.5 ns	_____	_____
80 ns	74 ns	(4-4) _____	86 ns	_____	_____
99.9 ns	93 ns	(4-5) _____	107 ns	_____	_____

LONG WIDTH:

1 us	948 ns	(4-6) _____	1.05 us	_____	_____
10 us	9.5 us	(4-7) _____	10.5 us	_____	_____
100 us	95 us	(4-8) _____	105 us	_____	_____
1 ms	950 us	(4-9) _____	1.05 ms	_____	_____
10 ms	9.5 ms	(4-10) _____	10.5 ms	_____	_____
100 ms	95 ms	(4-11) _____	105 ms	_____	_____
500 ms	475 ms	(4-12) _____	525 ms	_____	_____

PERIOD JITTER

Period Jitter \leq 80 ps (5-1) _____

WIDTH JITTER

Delay Jitter \leq 280 ps (5-2) _____

DELAY JITTER

Delay Jitter \leq 155 ps (5-3) _____

<u>TEST</u>	<u>LIMIT MINIMUM</u>	<u>ACTUAL (TR ENTRY)</u>	<u>LIMIT MAXIMUM</u>	<u>PASS</u>	<u>FAIL</u>
-------------	--------------------------	------------------------------	--------------------------	-------------	-------------

FAST TRANSITION:

6.5 ns		(6-1) _____	8.83 ns	_____	_____
10 ns	7.5 ns	(6-2) _____	12.5 ns	_____	_____
50 ns	45.5 ns	(6-3) _____	54.5 ns	_____	_____
99.9 ns	93 ns	(6-4) _____	107 ns	_____	_____
6.5 ns		(6-5) _____	8.83 ns	_____	_____
10 ns	7.5 ns	(6-6) _____	12.5 ns	_____	_____
50 ns	45.5 ns	(6-7) _____	54.5 ns	_____	_____
99.9 ns	93 ns	(6-8) _____	107 ns	_____	_____

SLOW TRANSITION, LEADING EDGE:

500 ns	473 ns	(6-9) _____	527 ns	_____	_____
999 ns	947 ns	(6-10) _____	1.05 us	_____	_____
5 us	4.75 us	(6-11) _____	5.25 us	_____	_____
9.99 us	9.49 us	(6-12) _____	10.49 us	_____	_____
50 us	47.5 us	(6-13) _____	52.5 us	_____	_____
99.9 us	94.9 us	(6-14) _____	104.9 us	_____	_____
500 us	475 us	(6-15) _____	525 us	_____	_____
999 us	949 us	(6-16) _____	1.049 ms	_____	_____
5 ms	4.75 ms	(6-17) _____	5.25 ms	_____	_____
10 ms	9.5 ms	(6-18) _____	10.5 ms	_____	_____
95 ms	90.25 ms	(6-19) _____	99.75 ms	_____	_____

<u>TEST</u>	<u>LIMIT MINIMUM</u>	<u>ACTUAL (TR ENTRY)</u>	<u>LIMIT MAXIMUM</u>	<u>PASS</u>	<u>FAIL</u>
-------------	--------------------------	------------------------------	--------------------------	-------------	-------------

SLOW TRANSITION, TRAILING EDGE:

500 ns	473 ns	(6-20) _____	527 ns	_____	_____
999 ns	947 ns	(6-21) _____	1.05 us	_____	_____
5 us	4.75 us	(6-22) _____	5.25 us	_____	_____
9.99 us	9.49 us	(6-23) _____	10.49 us	_____	_____
50 us	47.5 us	(6-24) _____	52.5 us	_____	_____
99.9 us	94.9 us	(6-25) _____	104.9 us	_____	_____
500 us	475 us	(6-26) _____	525 us	_____	_____
999 us	949 us	(6-27) _____	1.049 ms	_____	_____
5 ms	4.75 ms	(6-28) _____	5.25 ms	_____	_____
10 ms	9.5 ms	(6-29) _____	10.5 ms	_____	_____
95 ms	90.25 ms	(6-30) _____	99.75 ms	_____	_____

HIGH LEVEL:

0.1 V	56 mV	(7-1) _____	144 mV	_____	_____
0.5 V	440 mV	(7-2) _____	560 mV	_____	_____
1 V	920 mV	(7-3) _____	1.08 V	_____	_____
5 V	4.76 V	(7-4) _____	5.24 V	_____	_____
8 V	7.64 V	(7-5) _____	8.36 V	_____	_____

LOW LEVEL:

-0.1 V	-56 mV	(7-6) _____	-144 mV	_____	_____
-0.5 V	-440 mV	(7-7) _____	-560 mV	_____	_____
-1 V	-920 mV	(7-8) _____	-1.08 V	_____	_____
-5 V	-4.76 V	(7-9) _____	-5.24 V	_____	_____
-8 V	-7.64 V	(7-10) _____	-8.36 V	_____	_____

PULSE ABERRATION

$\leq 7\%$

(8-1) _____

$\leq 7\%$

(8-2) _____

DATA CAPACITY

16384

(9-1) _____

TABLE E-1. RECOMMENDED TEST EQUIPMENT

Other equipment can be used provided it meets the specifications of this equipment.

<u>TYPE (QUANTITY)</u>	<u>MODEL</u>	<u>SPECIFICATIONS</u>
1:1 Probe (1)	HP 10026A	100 V max., 1:1, 50 ohm,
10:1 Probe (1)	HP 10017A	300 V max., 10:1, 1 M ohm, 8 pF.
50 ohm feedthrough (1) termination	HP 10100C	50 ohm, 2W, 1%.
50 ohm feedthrough (1) termination	See Figure 11-1.	50 ohm, 10 W, 0.1 %.
Adapter, (1) BNC to Banana	HP 1251-2277	BNC(f) to dual banana plug, 50 ohm.
Cable Assembly (5)	HP 8120-1839	50 ohm, 24 inches, coax, 2 BNC (m).

Counter (1)	HP 5335A/ HP 5370B	50 uHz to 50 MHz; 8 digit display; INPUT: 50 ohm/1M ohm, X1/X10, AC/DC, seperate/common; variable trigger level; TI/PERIOD/FREQUENCY.
Isolation Transformer (1)		Suitable for use with the variac.
Multimeter (1)	HP 3478A/ HP 3456A	4 1/2 digit display; VDC: 30 mV to 300 V; 30 to 35 readings/second; external trigger; input resistance: >10 M ohm.
Oscilloscope (1) (Realtime)	HP 1725A	275 MHz bandwidth; external trigger; 50 ohm/1 M ohm inputs; 0.1 to 5 V.
Oscilloscope (1) (Sampling)	HP 54120T	20 GHz
Sampling Scope Accessories		
Attenuator (3)	33340C	APC 3.5 mm (f-m), 20 dB
Adapter (2)	1250-1200	SMA (m) to BNC (f)
Cable (3)	8120-4948	SMA (m-m) coaxial
Adapter (1)	1250-1159	SMA (m-m)
Adapter (2)	1250-1700	SMA (f) to BNC (m)
Power Splitter (1)	11667B	APC 3.5 mm

Power Supply (1)	HP 6205A/ HP 6237A	0-60 VDC, 0-3 A.
Pulse Generator (1)	HP 8112A/ HP 8161A	1 Hz to 50 MHz; variable delay; variable width; variable pulse; external trigger; output amplitude: > 5 V.
Signature Analyzer (1)	HP 5005A/ HP 5006A	TTL, 4 digit display, HEX, 25 M Hz clock, setup time = 20 ns, probe = 50 ohm to ground.
TEE (1)	HP 1250-0781	50 ohm, BNC(m)(f)(f).
Time Interval (1) Adapter	HP 10218A	50 ohm, BNC(m)
Time Interval Probes (1)	HP 5363B	Dynamic Range: +9.99 V to -9.99 V.
Variac (1) (Variable AC Poser Supply).		>= 5 A, 0-300 VAC

FIGURE 11-1.

**50 OHM, 0.1%,
10 W
FEEDTHROUGH
TERMINATION**

This feedthrough must be used only where specified for DC voltage measurements.

The following figure provides a schematic and a parts list except for the case. The case must provide shielding and maintain grounding integrity.

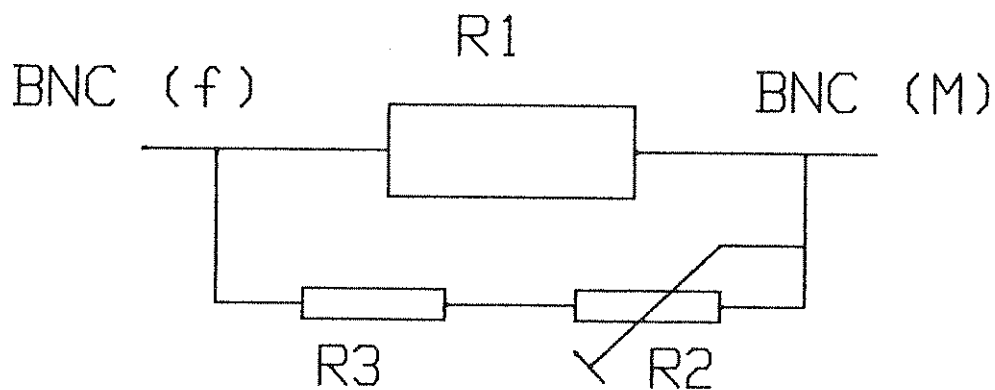

- R1 = 53.6 ohm, 1%, 10 W;
HP Part Number: 0699-0146.
- R2 = 200 ohm, 10%, 0.5 W, Variable trimmer;
HP Part Number: 2100-3350.
- R3 = 681 ohm, 1%, 0.5 W;
HP Part Number: 0757-0816.
- BNC (M): HP Part Number: 1250-0045.
- BNC (F): HP Part Number: 1250-0083.

F

ERRORS

Power-on Self-test

TABLE F-1

The instrument tests the microprocessor, clock, amplifier, and data boards. Error conditions are reported at the display immediately after performing the tests.

*TST?

TABLE F-1

The self-test query causes the instrument to test the clock, amplifier, and data boards by performing the power-on parametric board tests.

:SYST:ERR?

TABLE F-2

Command, execution, device dependent, and query error events are reported in response to the :ERR? query.

:SYST:DERR?

TABLE F-3

Device dependent error conditions are reported in response to the :DERR? query. The table contains all local messages.

Local Messages

TABLE F-4

Status is reported locally in the message lines. Abnormal messages will be preceded by one of the following labels: ERROR, CONFLICT, or WARNING.

All local messages are listed except device command paths (See Chapter 12.).

TABLE F-1. POWER-ON and *TST? ERROR MESSAGES

CPU BOARD TESTS

Processor Board Errors

Dynamic RAM U407 and/or U408
Read/Write error

Device Bus Failure
Read/Write error.

Static RAM U211 and/or U212
Read/Write error

Program ROM U205 - U210
ROM contents invalid

20 ms System Interrupt Circuit
Interrupt circuit error

Configuration Errors

Doubled Board
A non-required duplicate board is installed.

False Board-Code
The board address switch setting is
inconsistent with the boards usage.

Board located in wrong Slot

Board missing

PARAMETRIC BOARD TESTS

Clock Board

<u>*TST? CODE</u>	<u>POWER-ON/*TST? ERROR MESSAGE</u>
100	Period Timing Circuit
101	EEPROM Check failed
102	Man. Start/Stop/Cont Manual Start/Stop/Continue pattern generator running error
103	Stop from Data Board Pattern generator running error

Amplifier Board

*TST CODE

<u>MESSAGE</u>	<u>CHANNEL 1</u>	<u>CHANNEL 2</u>	<u>POWER-ON/*TST?</u>	<u>ERROR</u>
	210	430	Delay Timing Circuit Pulse timing	
	211	431	Width Timing Circuit Pulse timing	
	212	432	Slope Gen. Function Mode	
	213	433	Offset +8V	
	214	434	Offset -8V	
	215	435	Amplitude +16V Normal	
	216	436	Amplitude +16V Complement	
	217	437	Gate ON +16V Amplitude	
	320	540	Gate OFF +16V Amplitude	
	321	541	Leading Edge 999us	
	322	542	Trailing Edge 999us	
	323	543	Leading Edge 9.99ms	
	324	544	Trailing edge 2.5ms	
	325	545	Amplitude +9.5V	
	326	546	Amplitude +1.77V	
	327		Addition	

Data Board

<u>*TST CODE</u>	<u>POWER-ON/*TST? ERROR MESSAGE</u>
650	Data Memory Channel 1
651	Data Memory Channel 2
652	Data Register Channel 1
653	Data Register Channel 2
654	Addr. Counter Auto Cycle
655	Stop at Single Cycle
656	Delay Timing Circuit Strobe timing
657	Width Timing Circuit Strobe timing

TABLE F-2.
:SYST:ERR?
ERROR MESSAGES

ERROR CODE

QUERY ERRORS

The occurrence of query errors also set bit two (QYE) of the standard event status register (ESR).

-400

<Generic Query Error>

An unspecified query error has occurred. Check for deadlock, unterminated, or interrupted actions.

ERROR CODE

DEVICE ERRORS

The occurrence of device dependent errors also sets bit three (DDE) of the standard event status register (ESR).

-350

<Too Many Errors>

More than ten error conditions are present. Error code -350 was loaded into the error queue replacing the last error, error number 10.

-340

<Self Test Failed>

Amplifier, clock, and or data board failure. See Chapter 11, *TST? and Appendix F, Table F-1.

-330

<Power-on Test Failed>

Error conditions are presented on the display. See Tables F-1.

-312

<RAM Data Loss>

RAM memory failure.

ERROR CODE

EXECUTION ERRORS

The occurrence of execution errors also sets bit four (EXE) of the standard event status register (ESR).

-212

<Argument Out of Range>

The received value is out of its allowed range.

See the syntax diagrams for the ranges.

-211

<Legal Command but Settings Conflict>

A command was received which is not a member of the command-set of the current generator configuration. See Chapter 12, Device Dependent Commands.

-200

<Generic Execution Error>

The entry is not allowed while the machine is running.

A :SYST:SET binary transfer has failed.

An error condition was present when a configuration change was attempted.

A remotely programmed level conflict occurred.

ERROR CODE

COMMAND ERRORS

The occurrence of command errors also sets bit five (CME) of the standard event status register (ESR).

-130 <Non-Numeric Argument Error>,<Mnemonic>

The non-numeric argument is invalid.
<mnemonic> = the command with the invalid argument.

-120 <Numeric Argument Error>,<Mnemonic>

The numeric argument is invalid.
<mnemonic> = the command with the invalid argument.

-100 <Command Error>,<Mnemonic>

The command is invalid.

1. The required command is incorrectly transmitted.
2. The command is not allowed in:
 - a. The current instrument configuration
 - b. The command path transmitted.

<mnemonic> = the command mnemonic.

0 <No error>

**TABLE F-3.
:DERR?
ERRORS?**

<u>ERROR CODE</u>	<u>SOFTWARE ERROR MESSAGE</u>
100	<p><Ext.Input Mode - Slope></p> <p><External Input Mode - Slope></p> <p>Input-trigger-mode = GATE and input-trigger-slope = BOTH are incompatible in the pattern generator.</p> <p>Only positive or negative slope selections are allowed in the gate mode.</p>
101	<p><Break Address - Frame></p> <p>The break address and the frame specifications are incompatible.</p> <p>The break address is not an address within the frame in which the break is to occur.</p> <p>Check the break-bit and break-word values and the frame specifications.</p>
102	<p><Limit Ch 1. - Addition></p> <p><Limit Channel 1 - Addition></p> <p>Addition = on and the added levels exceed the hardware limits of the instrument.</p>

103

<Slope Range Conf. Ch 2.>

<Slope Range Conflict Channel 2>

Leading edge and
Trailing edge
in Channel 2 are incompatible.

Programming the leading and trailing edges
of channel 2 in different ranges is not allowed.
See slope generator ranges, Chapter 14.

104

<Slope Range Conf. Ch 1.>

<Slope Range Conflict Channel 1>

Leading edge
Trailing edge
in Channel 1 are incompatible.

Programming the leading and trailing edges
of channel 1 in different ranges is not allowed.
See slope generator ranges, Chapter 14.

105

<Ext.Input Mode - Cont.Mode>

<External Input Mode - Control Mode>

Tringgr mode = TRIGGER and
Control mode = PERIOD
are incompatible.

The period is regulated either by the period
of the external input trigger signal or by
the period set by control mode 'Period' but
not by both at the same time.

106

<Ext.Input Mode - Slope>

<External Input Mode - Slope>

Trigger mode = GATE and
Trigger slope = BOTH
are incompatible in the pulse generator.

Only positive or negative slopes are allowed
in the GATE mode.

107

<Control Mode - Addition>

Control mode = HIGH LEVEL and
Pulse addition = ON
are incompatible.

When the high level control is active,
adding output 2 to output 1 is not allowed.

110

<Cont.Mode - Format Ch.2>

Control-mode = WIDTH and
channel 2 data-format = DNRZ
are incompatible.

When the control-mode WIDTH is active,
data-format DNRZ is not allowed.

111

<Cont.Mode - Format Ch.1>

Control-mode = WIDTH and
channel 1 data-format = DNRZ
are incompatible.

When the control-mode WIDTH is active,
data-format DNRZ is not allowed.

- 112** **<Cont.Mode - Format Ch.2>**
- Control-mode = DELAY and
channel 2 data-format = NRZ
are incompatible.
- When the control-mode DELAY is active,
data-format NRZ is not allowed.
- 113** **<Cont.Mode - Format Ch.1>**
- Control-mode = DELAY and
channel 1 data-format = NRZ
are incompatible.
- When the control-mode DELAY is active,
data-format NRZ is not allowed.
- 114** **<Cont.Mode - Format Ch.2>**
- Control-mode = WIDTH and
channel 2 data-format = NRZ
are incompatible.
- When control-mode WIDTH is active,
data-format NRZ is not allowed.
- 115** **<Cont.Mode - Format Ch.1>**
- Control-mode = WIDTH and
channel 1 data-format = NRZ
are incompatible.
- When control-mode WIDTH is active,
data-format NRZ is not allowed.

116

<External Clock - Cont.Mode>

External-clock-state = ON and
Control mode = PERIOD
are incompatible.

The period is regulated either by
period of the external clock or by
the period set by control mode 'Period' but
not by both at the same time.

117

<Data Mode - Strobe Mode>

Frame-mode = BIT and
Strobe-mode = WORD
are incompatible.

ERROR CODE **HARDWARE ERROR MESSAGE**

230

<Period - Width Ch.2>

External clock = OFF

Channel 2: The pulse period and width are incompatible.

231

<Double - Width Ch.2>

External clock = OFF

Channel 2: The double pulse delay and pulse width are incompatible.

232

<Period - Double Ch.2>

External clock = OFF

Channel 2: the pulse period and double pulse delay are incompatible.

233

<Period - Delay Ch.2>

External clock = OFF

Channel 2: the pulse period and delay are incompatible.

234

<Period - Width Ch.1>

External clock = OFF

Channel 1: the pulse period and width are incompatible.

235

<Double - Width Ch.1>

External clock = OFF

Channel 2: the double pulse delay and pulse width are incompatible.

236

<Period - Double Ch.1>

External clock = OFF

Channel 1: the pulse period and the double pulse delay are incompatible.

237

<Period - Delay Ch1.>

External clock = OFF

Channel 1: the pulse period and delay are incompatible.

246

<Period - Strobe Width>

External clock = OFF

The pulse period and strobe width are incompatible.

247

<Period - Strobe Delay>

External clock = OFF

The pulse period and strobe delay are incompatible.

- 252** **<Period - Strobe Width>**
External clock = ON.
Channel 1/2 Data Format = RZ or DNRZ
- The strobe width is incompatible with the period defined by the external clock frequency.
- 253** **<Period - Strobe Delay>**
External clock = ON.
Channel 1/2 Data Format = RZ or DNRZ
- The strobe delay is incompatible with the period defined by the external clock frequency.
- 254** **<Period - Width Ch.2>**
External clock = on
Channel 2 Data Format = RZ
- The pulse width is incompatible with the period defined by the external clock frequency.
- 255** **<Period - Delay Ch.2>**
External clock = on
Channel 2 Data Format = RZ or DNRZ
- The pulse delay is incompatible with the period defined by the external clock frequency.
- 256** **<Period - Width Ch.1>**
External clock = on
Channel 1 Data Format = RZ
- The pulse width is incompatible with the period defined by the external clock frequency.
- 257** **<Period - Delay Ch. 1>** External clock = on
Channel 1 Data Format = RZ or DNRZ
- The pulse delay is incompatible with the period defined by the external clock frequency.

ERROR CODE

HARDWARE WARNINGS

262

<Clock Rate too Fast>

External clock = on
Frequency > 100 MHz
Channel 2: Data Format = NRZ.

The clock frequency exceeds 100 MHz and the data format is NRZ.

263

<Clock Rate too Fast>

External clock = on
Frequency > 100 MHz
Channel 1: Data Format = NRZ.

The clock frequency exceeds 100 MHz and the data format is NRZ.

264

<Period < 20 ns>

External clock = on
Frequency > 50 MHz
Channel 2: Data Format = RZ or DNRZ.

The clock frequency exceeds 50 MHz and the data format is RZ or DNRZ.

265

<Period < 20 ns>

Channel 1: Data Format = RZ or DNRZ.

External Clock = on
Frequency > 50 MHz
Channel 1 Data Format = RZ or DNRZ

The clock frequency exceeds 50 MHz and the data format is RZ or DNRZ.

266

<Period < 20 ns>

External Clock = OFF

Period < 20 ns

Channel 2 Data Format = RZ or DNRZ

The period is less than 20 ns
and the data format is RZ or DNRZ.

267

<Period < 20 ns>

External Clock = OFF

Period < 20 ns

Channel 1 Data Format = RZ or DNRZ

The period is less than 20 ns
and the data format is RZ or DNRZ.

ERROR CODE

SOFTWARE WARNING MESSAGE

373

<Excessive Slopes Ch. 2>

The values programmed for the slopes are long with respect to other pulse timing parameters; consequently, the pulse levels are reduced. Check the period, width, delay, or double pulse delay parameters.

374

<Excessive Slopes Ch. 1>

See code 373.

375

<Cont. Mode - Limit Ch.2>

Channel 2 Limit = on
Control Mode = High Level

The high level is hardware controlled via the rear panel control input. The limit function is inactive.

376

<Cont. Mode - Limit Ch.1>

Channel 1 Limit = on
Control Mode = High Level

The high level is hardware controlled via the rear panel control input. The limit function is inactive.

377

<Limit Ch. 1 - Addition>

Addition = on
Limit = on

The added levels exceed the limits set by the limit function.

TABLE F-4.

LOCAL MESSAGES

The numbers following the messages are Table 26-3 error codes.

"Actual Setting Destroyed"

A save or recall operation failed. The RAM data is invalid.

"Address Required"

An editor function needs an address input.

"Break Address - Frame"... 101

The break address is outside of the specified frame.

"Break Point out of Range"

The break point is outside of the physical limits of the instrument.

"Cannot Continue"

See Chapter 2, page 3, Abnormal State.

"Check HP-IB Bus Configuration"

Check at the peripherals display.

"Clock Rate too Fast"...262, 263

The external clock is enabled and the input frequency exceeds the limit for a particular parameter or mode.

"Command Ignored"

The attempted action is not allowed. Thus, the command was not implemented. Check attempted action: is the configuration correct, is an edit function active, is the pattern generator running, is the command syntax correct, etc.

"Cont. Mode - Format Ch. 1/2"...110-115

Cont. = control

A data format mode and a control mode are not compatible.

"Cont. Mode - Limit Ch. 1/2"...375, 376

Cont. = control

"Control Mode - Addition"...107

"Copy Overwrites Destination"

The original data in the 'to' location is replace/destroyed by the incoming data. Overwriting is a destructive operation.

"Checking disc"

"Checking directory"

"Creating directory"

"Cursor Addr. > End Addr."

The cursor address/start address > end address in the DELETE editor function. The 'Cursor on ...' address is greater than the 'to' address.

"Data Mode - Strobe Mode"...117

"Declare Printer Type"

"Delete too Large"

"Directory full"

"Disc changed"

"Disc failure"

"Disc is not LIF disc"

"Disc is write protected"

"Disc unformatted"

"DON'T CARE not Allowed"

"Double - Width Ch.1"...231, 235

"Enter C to confirm"

Entering 'C' starts the disc formatting operation.

"Excessive Slopes Ch. 1/2"...373, 374

"External Clock - Control Mode"...116

"Ext. Input Mode - Cont. Mode"...105

Ext. = external

Cont. = control

"Ext. Input Mode - Slope"...100/106

Ext. = external

"Ext. Input State: [OFF]"

Ext. = external

"File does not fit"

The recalled file is not an HP 8118A file.

"File not Found"

"Fix Problem First"

"Fix" means correct the conflicting conditions first.

"Format failed"

"Formatting disc"

"Frame exceeded"

A block to be copied cannot exceed the limits of the frame. All data must be copied to locations within the existing frame. The COPY edit function cannot increase the frame size.

"Frame Spec. out of Range"

Spec. = specification. (Word Length)(Number of Words) <= 16384 bits

"Generator type changed"

The generator type (pulse or pattern) was changed during a recall operation because the recalled setting required the change in type.

"High Level <= Low Level"**"HP-IB Address Conflict"**

Interface addresses are duplicated. Check the address assignments at the peripherals display.

"HP-IB in Controlled Mode"

The instrument is in the device mode. The controller/controlled mode is set at the peripherals display.

"Illegal File Name"

File name contains spaces or a '?.

"Internal: bad file length"

Disc error

"Internal: bad file type"

Disc error

"Internal: bad request"

Disc error

"Internal: disc error"**"Internal: undefined error"**

Disc error

"Invalid Start Value"

The RANDOMIZE start value cannot be zero.

"Leave Editor First"

Execute or abort the editor function first. The base specification [BIN|OCT|HEX] cannot be changed if an editor operation is pending.

"Level conflict CH. 1/2"

"LIF directory too big"

Disc error

"Limit Ch. 1 - Addition"...102/377

"LOCAL LOCKOUT"

The front panel controls are inactive.

"Machine Type Changed"

"Memory Exceeded"

An action was attempted that tried to exceed the specified frame.
Check the frame specifications at the data format display. NOTE:
the first bit/word in the frame is bit/word zero not one.

"MOVE in Execution"

"No disc drive present"

"No disc media present"

"No room on disc"

"Numeric Entry Required"

"Only one point allowed"

Point = (.)

"Operation time out"

Disc error

"OUTPUT 1" or "OUTPUT 2"

Indicates when Output 1/2 output states are enabled.

"Output State Ch.2 [OFF]"

"Out of Range"

"Parameter not Available"

The selected parameter is not available. For example, if the external clock is enabled, the period parameter is not available.

"Period < 20 ns"...264-267

"Period Adjusted"

The generator type was changed to pulse, and the period was changed to 20 ns because the period was < 20 ns.

"Period - Delay Ch.1/2"...233, 237, 255, 257

"Period - Double Ch. 1/2"...232/236

"Period - Strobe Delay"...247, 253

"Period - Strobe Width"...246, 252

"Period - Width Ch. 1/2"...230, 234, 254, 256

"Power-up Complete"

"Press any key to continue"

This message appears after power-on-test parametric-failures.
The BLUE key is not included.

"Press EXEC to Activate Function"

EXEC = execute. EXEC executes the selected internal or external storage operation.

"Press EXEC to check disc"

EXEC = execute

"Press Stop Key First"

The attempted action is only possible when the generator is not the running state.

"Press UPDATE First"

"Printer Down/Press Stop"

The printer is out of operation./Press the Stop key.
Check the cable, power, interface address, paper, top-of-form, etc.

"Printing in Progress"

"Purging file"

"Randomize in Execution"

"Range Overlap"

The destination address of the MOVE block cannot be within the address range of the specified block.

"Reading description"

"Reading directory"

"Recalling Setting from File"

"REMOTE"

The instrument is remotely enabled.

"Resolution 10 ns"

"Resolution 10 us"

"Resolution 100 ps"

"Response can be Read"

The query response message is now in the output queue and can be read.

"Roll to Change Configuration"

Roll = press a ROLL key

"RUN"

The pattern generator is cycling a pattern.

"Saving setting into File"

"SHIFT"

The shift function is active. See BLUE key, Chapter 3.

"Single Channel Disp. only"

Disp. = display

PRINT ALL at the data entry display is not possible when both channels are displayed and the word length is > 20 bits.

"Single Step in Execution"

"Slope Range Conf. Ch. 1/2"...103/104

Conf. = conflict

Remote programming of the leading and trailing edges in different ranges is not allowed.

"Start Addr. > End Addr."

Addr. = address

Editor error: the starting address must be less than the ending address.

"Switch to Controller Mode"

The instrument is in the controlled mode (device mode) and the attempted action requires the instrument to be in the controller mode. Controller/controlled changes are made at the peripherals display.

"To confirm, press EXEC"

EXEC = execute (EXEC key)

The purge file operation is active. Pressing EXEC will purge the specified file.

"To overwrite File, press EXEC"

EXEC = execute (EXEC key)

A setting is stored into an existing file and the old data is destroyed. Overwrite replaces data; it is a destructive process.

"Transfer Failed"

A storage operation or a binary transfer (:SYST:SET) failed.

"Transfer in Process"

"Unaddress or Poll First"

Take the instrument to the listener idle state and/or serial poll.

"Unexpected EOI"

"Unused Key"

"UPDATE"

Updating is required to transfer the changes from the current setting to the hardware.

"Use 0 or 1"

"Use 0, 1, or '.'"

"Use 0 through 3"

"Use 0 through 3 or '.'"

"Use 0 through 7"

"Use 0 through 7 or '.'"

"Use Alphanumeric keys"

"Use Hexidecimal Keys"

"Use [NEXT][PREV] Keys"

"Use Shift Curs. arrows to get Char."

Curs. = cursor

Char. = character

See Chapter 3, Cursor keys: display alphabet.

"Value is too Large"

"Value is Too Low"

"Value Not Allowed"

"Value out of Range"

INDEX

A	ABORT	3-3, 5-5
	Accessories	B-1
	Address, instrument	8-26
	Addition	8-3, 12-49
	Amplitude	8-4, 12-61
	Append Column	9-2
	Auto-ranging	3-10
B	Base	5-6, 8-5
	Beeper	8-6
	BLUE Key	3-1
	Break	5-3 & 5, 8-7, 12-9 & 14
	Bypass	6-6
C	Cannot continue	2-3
	Carriage return <cr>	
	Certification	iv
	Claims (warranty iii)	CA-5
	Clear (edit)	
	Bit mode	10-2
	Word mode	9-4
	CLEAR ENTRY	3-3
	Clock, external	3-12, 8-21, 12-28
	Commands	
	Common	11-1
	Coupled	6-3
	Device Dependent	12-1
	Legal	6-3
	Long/Short form	6-3
	Common Commands	12-1
	Command Hierarchy (tree)	6-7
	Complement(Polarity)	8-33, 12-50
	Conf. (conflict)	

Configuration	1-1, 8-9
Configuration Display	4-12
Cont.(control)	
Contd.(continued)	
Cont. (control)	
Contents	xv
Continue	3-4, 8-14, 8-47, 12-38
Continuous Pulse Stream	8-47
Control	8-10
(control input)	
Control Display	4-16
Control Input	3-12, 8-10, 12-29
Controls	3-1
Conventions(syntax diagrams)	6-6
Copy (edit)	
Bit mode	10-5
Word mode	9-6
Copyright Notice	ii
Coupled commands	6-3
<cr> carriage return	
Curs. (cursor)	
Cursor	2-6, 2-7, 2-13, 8-13
Cursor on	8-13
Cycling	8-14, 12-12
D	
<data>	6-6
Data Entry Display	4-7, 4-10, 4-11
Data Entry Field	4-9, 8-15
Data Format	8-16, 12-13
Data Format Display	4-7, 4-10, 4-11
Data Pattern	5-3
Delay	
Pulse	8-17, 12-69
Double Pulse	8-20, 12-70
Delete (edit)	
Bit mode: Digit	10-6
Word mode:	
Column	9-8
Digit	9-10
Word	9-12

	Description, Instrument	1-1
	Device Dependent Commands	12-1
	Dimensions, Physical	A-7
	Disc (drive)	8-18
	Display(function)	8-18
	Display Alphabet	
	See CURSOR keys	3-4
	Display Selection	2-6, 4-3
	Display Types	2-6, 4-3
	Don't Care	3-5
	Double Pulse	
	Double Pulse Delay	8-20, 12-70
E	Edge Ranges	3-11, 8-52
	Editor	5-5
	Bit Mode	10-1
	Word mode	9-1
	Edition	v
	Effective pages	vi
	Environmental	A-7
	Error Queue	7-12
	Errors	7-4, 12-77, 12-78, F-1
	ESB	7-8, 7-9, 7-14
	ESE	7-11, 7-14, 11-3, 11-4
	ESR	7-10, 7-14, 11-5
	Exclusive remedies	iii
	EXEC (execute) key	3-6
	Execute	
	editing	5-5
	key	3-6
	SAVE display operations	Chapter 8
	Ext. (external)	
	External Clock	3-12, 8-21, 12-28
	External Display	4-15
	External Input(TRIGGER)	3-12, 8-47, 12-37

F	Fields	4-4
	Fix	F-22
	Fixed Transition	8-46, 12-56
	Format, Data	8-16, 12-13
	Format (disc)	8-22
	Frame	5-3 & 4, 8-23 & 24, 12-14 to 16
	Fuse, Line	C-4
G	Gate	3-18, 8-47, 12-39
	Gaussian	8-46, 12-56
	GREEN key(HELP)	2-45, 3-6
H	Sales and Support Office	
	Directory	SSO-1
	HELP	
	key (GREEN)	3-6
	Programming Information	2-4
	Operating State Info.	2-5
	High Level	8-25, 12-62
	HP-IB	3-13, 8-26
	Adapter	C-8
	Address Selection	8-26
	Cables	C-8
	Connectors	C-8
	Functions	A-4
	Lock Screw	C-9
	Logic Levels	C-8
Networks	C-8	
I	Input Buffer	7-12
	Insert (edit)	
	Bit mode: Digit	10-8
	Word mode	
	Column	9-14
	Digit	9-16
Word	9-18	

	Inspection, Incoming	CA-3
	Installation	C-3
	Instrument Setting	5-3
	Interface Address	8-26
	Interface (HP-IB)	C-8, 8-26
	See HP-IB.	
	Internal Display	4-14
	Introduction	xi
J/K		
	Key Queue	7-12, 12-80
	keys	3-1
	Key Codes	12-81
	Known State,	11-16
L		
	Label	4-4
	Leading Edge	8-27, 12-55
	Learn (*LRN?)	11-7
	Levels	8-25, 8-29, 12-62, 12-65
	<lf> line feed	
	Limit	8-28, 12-63
	Limitation of Warranty	iii
	Line Feed <lf>	
	Line Voltage Selector	C-4
	Linear transition	8-46, 12-56
	Local Messages	6-3
	Low Level	8-29, 12-65
M		
	Markers	4-8
	MAV	7-8, 7-9, 7-14
	MAX (maximum)	6-6
	Message Lines	2-7, 4-6

	Messages	
	Program	6-3, 6-4
	Response	6-3, 6-5
	MIN (minimum)	6-6
	<mnemonic>	6-6
	Modify edit function	9-20
	Modify (edit)	
	Bit mode	
	Clear	10-2
	Randomize	10-14
	Set	10-16
	Word mode	9-20
	Clear	9-4
	Modify	9-20
	Randomize	9-26
	Set	9-28
	Move (edit)	
	Bit mode	10-10
	Word mode	9-22
N	New Line (NL)	6-4, 6-5, 6-6
	NL, <lf>/new line	6-4, 6-5, 6-6
	Normal(Polarity)	8-33, 12-50
O	Offset	8-30, 12-66
	Operating Environment	A-7
	Options	B-1
	Output Queue (Buffer)	7-12, 7-14
	Outputs 1 and 2	3-13, 8-41, 12-51
P	Packaging	C-7
	Pattern	5-3
	Parser	7-3
	Performance Tests	Appendix E
	Period	8-31, 12-72

Peripherals	
Recommended types	B-1
Disc Drive	8-18
Printer	8-34
Peripherals Display	4-13
<pmt>	6-4
<pmus>	6-4
Polarity	8-33, 12-50
Polling	7-5, 7-6
Power	
Cord	C-5
Cord Modification	C-6
Cord, types of	C-6
Requirements	C-3
Power-on	2-3, 7-3
Cannot continue	2-3
Power-on test	2-3, F-1
"Press any key to continue"	2-3,
Normal State	2-3
Abnormal State	2-3
PRBS	
Bit mode	10-14
Word mode	9-26
"Press any key to continue"	2-3
PRINT	3-8
PRINT ALL	3-8, 3-14
Printer	8-34
Printing History	vi
Product Warranty	iii
Program Message	6-3, 6-4
Program Message Unit	6-4
Program Message Unit Separator	6-4
Program Message Syntax	6-4
Program Message Terminator	6-4

Pseudo-random Binary Sequence (PRBS)	
Bit mode	10-14
Word mode	9-26
Purge	8-35
Q/R	
Randomize	
Bit mode	10-14
Word mode	9-26
Range, Control	
Delay	8-17, 8-51, 12-30, 12-33
Double	8-20, 8-51, 12-30, 12-33
Width	8-50, 8-51, 12-30, 12-33
Period	8-32, 8-51, 12-30, 12-33
Recall	
External	8-36
Internal	8-37
Remote Messages	2-7, 6-3
Reset(*RST)	8-38(11-15)
Reset State	11-16
Response Message	6-3, 6-5
Response Message Unit	6-5
Response Message Unit	
Seperator	6-5
Response Message Syntax	6-5
Response Message Terminator	6-5
Returns	CA-6
<rmt>	6-5
<rmu>	6-5
<rmus>	6-5
RUN = Running = Cycling	4-6, 8-14, 12-12

S

Safety	ix, C-3
Safety Summary	ix
Sales and Support Offices	SSO-1
Save	
External	8-39
Internal	8-40

Save Display	4-14, 4-15
Seperators	6-4, 6-5
Sequential Commands	7-13
Serial Number	i v, CA-8
Serial Poll	7-5, 7-6
Service Request Enable	
Register (SRE)	7-9, 7-14, 11-19, 11-20
Set (edit)	
Bit mode	10-16
Word mode	9-28
Setting, Instrument	5-3
known	11-16
reset	11-16
standard	11-16
SHIFT, See Key Functions.	3-3
Single Step	3-7, 12-41
Specifications	A-1
Interface	A-4 Restrictions A-1
Typical	A-1
Warranted	A-1
SRE	7-9, 7-14, 11-19, 11-20
Standard Event Status	7-11, 7-14, 11-3, 11-4
Enable Register (ESE)	
Standard Event Status	7-10, 7-14, 11-5
Register (ESR)	
Standard Setting	11-16
Standard units	6-6
Start	3-9, 8-14, 8-47, 11-22 12-37, 12-28, 12-42
Stop	3-9, 8-14, 8-48, 11-22 12-37, 12-38, 12-44
State, Output 1 and 2	3-13,8-41, 12-51
Status Byte	7-7
Status Byte Register (STB)	7-8, 7-14, 11-21
STB	7-8, 7-14, 11-21

Strobe	
Delay	3-13, 5-3 & 6, 8-42 12-67, 12-69
Width	3-13, 5-3 & 6, 8-42 12-67, 12-73
Mode	3-13, 5-3 & 6, 8-43 12-7
Subject Matter Notice	ii
Synchronization	7-13, 11-12 & 13, 11-24
Syntax	
Conventions	6-6
Diagrams	
Common	11-1
Device Dependent	
:DATA	12-7
:INPut:CLOCK	12-27
:INPut:CONTRol	12-29
:INPut:TRIGger	12-37
:OUTPut:PULSe	12-47
:PULSe:EDGE	12-53
:PULSe:LEVel	12-59
:PULSe:TIMing	12-67
:SYSTEM	12-75
T	
Terminators	6-4, 6-5
Threshold	8-44, 12-45
Title Page	ii
Trailing Edge	8-45, 12-57
Transitions	8-46, 12-56
Trigger(External Input)	3-12, 8-47, 12-37
Trigger Output	3-13

U/V

Undefined Data	5-4
Under-programming	2-7, A-1
<unit>	6-6
Updating	
Definition	5-3, 5-4
Key	3-9
Remote command	12-25
<value>	6-6
Vernier Function	3-10
Auto-ranging	3-10
Viel Spass = Enjoy!!!!!!!!!!!!!!	
Voltage Selection	C-4

W/X/Y/Z

Warranty	iii
Width	8-50
<wsp> (white space)	6-6

CUSTOMER ASSISTANCE

CONTENTS

Introduction	CA-3
Sales and Support Offices	CA-3
Incoming Inspection	CA-3
Contents	CA-4
Discrepancies	CA-4
Performance Tests	CA-5
Warranty	CA-5
Claims	CA-5
Shipment Damage	CA-5
Returns	CA-6
Instrument Identification	CA-6
Shipment	CA-6
Storage	CA-6
Packaging	CA-7
Parts Ordering Information	CA-8
Serial Number	CA-8

INTRODUCTION

Product maintenance agreements and other customer assistance agreements are available for Hewlett-Packard products.

For any assistance, contact your nearest Hewlett-Packard Sales and Support Office.

SALES AND SUPPORT OFFICES

Sales and Support Offices are listed in the Sales and Support Office Directory at the back of all instrument reference manuals.

The Service Manual contains an expanded directory containing local offices.

INCOMING INSPECTION

Inspect the shipment for the following:

1. Packaging Material Condition
2. Invoice
3. Contents
4. Serial Number
5. Physical condition
6. Electrical condition.

NOTE: If the instrument is damaged during shipment, the packaging material must be saved for the carrier's inspection.

Contents

The contents of the shipment are:

1. Invoice
2. The standard instrument
3. Line power cord, 1 each
4. Line fuse, 1 each
5. Operating and Programming Manual, 1 each
6. Manual updates when required, 1 each

PLUS

8. Options as ordered
9. Accessories as ordered.

NOTE: Service Manuals are available as options.
See Appendix B, Options and Accessories.

Discrepancies

If there are any discrepancies, contact a Hewlett Packard Sales and Support Office before doing anything further with the contents of the shipment.

PERFORMANCE TESTS

Performance Tests for checking the instrument's electrical operation are in Appendix E, which also contains a list of recommended test equipment.

The tests verify the instruments specified performance characteristics as described in Appendix A.

WARRANTY

The WARRANTY is on page iii.

CLAIMS

See the WARRANTY on page iii

Shipment Damage

If damage is caused during shipment, a Hewlett Packard Sales and Support Office will arrange for repair or replacement of the damaged items without waiting for settlement of a claim against the carrier.

The shipping material must be retained for the carrier's inspection.

RETURNS

See the WARRANTY on page iii.

Instrument Identification

Attach a tag with the following information to the instrument when returning it:

1. Owner Identification
 - a. Contact's name
 - b. Contact's telephone number
 - c. Owner's return address
2. HP Identification
 - a. Representative's name
 - b. Telephone number
 - c. Office name
3. Model number of the instrument
4. Instrument's complete serial number
5. Description of the service required.

Shipment

Shipment or storage:

1. The instrument can be shipped or stored at temperatures between -40 degrees Celsius and 65 degrees Celsius.
2. The instrument must be protected from conditions which cause condensation within the instrument.

Storage

The conditions are the same as those given for SHIPMENT.

Packaging

Use the original shipping carton and packaging material if they are not damaged.

A Hewlett Packard Sales and Support Office will provide recommendations on packaging material to be used.

General instructions for packing:

1. Wrap the instrument in heavy paper or plastic.
2. Use a strong shipping container.

A double wall carton made of 350 pound/159 kg test material is adequate.
3. Protect the front panel with cardboard.
4. Use a 3 to 4 inch layer of shock absorbing material around the instrument to provide a firm cushion and to prevent instrument movement inside the container.
5. Seal the shipping container securely.
6. Mark the shipping container with "FRAGILE".

PARTS ORDERING INFORMATION

Parts and parts ordering information is contained in the Service Manual.

SERIAL NUMBER

The instrument's serial number (identification number) is located on the rear panel of the instrument.

SALES AND SUPPORT OFFICES

SALES AND SUPPORT OFFICE DIRECTORY

This directory contains Headquarters Offices only.

The Service Manual contains an expanded directory containing local Sales and Support Offices.

AFRICA

Hewlett Packard S.A.
7, Rue du Bois-du-Lan
CH-1217 Meyrin 1
Switzerland

Telephone: (022) 83 12 12
Telex: 27835 hmea ch
Telefax: (022) 83 15 35

ASIA

Hewlett Packard Asia Ltd.
47/F, 26 Harbour Road
Wanchai
Hong Kong
G.P.O. Box 863, Hong Kong

Telephone: 5 83 30 83 3
Telex: 76793 HPA HX
Cable: HPASIAL TD

CANADA

Hewlett Packard Ltd.
6877 Goreway Drive
Mississauga
Ontario L4V 1M8
Canada

Telephone: (416) 678-9430
Telex: 069-8644

EUROPE

Hewlett Packard GmbH
Lieblgasse 1
P.O. Box 72
A-1222 Vienna
Austria

Telephone: (222) 2500-0
Telex: 13 4425 HEPA A

Hewlett Packard S.A.
V.D. Hooplaan 241
P.O. Box 999
NL-118 LN 15 AG Amstelveen
The Netherlands

Telephone: 20 547 9999
Telex: 18919 hpner

Hewlett Packard S.A.
World Trade Center
110 Avenue Louis Casai
1215 Cointrin
Geneva
Switzerland

Telephone: (022) 98 96 51
Telex: 27225 hpser

MIDDLE EAST

Same as for Africa

UNITED KINGDOM

Hewlett Packard Ltd.
Nine Mile Ride
Wokingham
Berkshire, RG 113LL

Telephone: 0344 773 100
Telex: 848805/848814/848912

**OTHER
INTERNATIONAL
OFFICES**

Hewlett Packard Co.
Intercontinental Headquarters
3495 Deer Creek Road
Palo Alto
California 94304

Telephone: (415) 857-1501
Telex: 034-8300
Cable: HEWPACK

**UNITED STATES
OF AMERICA**

Customer Information Center
(800) 752-0900
6:00 AM to 5:00 PM, Pacific Time Zone

Hewlett Packard Co.
4 Choke Cherry Road
Rockville
Maryland 20850

Telephone: (301) 948-6370

Hewlett Packard Co.
5201 Tollview Drive
Rolling Meadows
Illinois 60008

Telephone (312) 255-9800

Hewlett Packard Co.
2000 South Park Place
Atlanta
Georgia 30339

Telephone: (404) 955-1500

Hewlett Packard Co.
5161 Lankershim Boulevard
North Hollywood
California 91601

Telephone: (818) 505-5600



HEWLETT
PACKARD

08118-90011

Edition 1

E0988

Reorder Number: 08118-90011

Printed in Germany, 10/91, American English

NOTICE

SUBJECT MATTER

The information in this document is subject to change without notice.

Hewlett Packard shall not be liable for errors contained herein or for incidental or consequential damages in connection with the furnishing, performance, or use of this material.

COPYRIGHT

This document contains proprietary information which is protected by copyright. All rights are reserved.

No part of this document may be photocopied, reproduced, or translated to another language without the prior written consent of Hewlett Packard GmbH.

© Copyright 1988 by:

Hewlett Packard GmbH
Herrenberger Str. 130
7030 Boeblingen
Federal Republic of Germany

front cover photograph

The instrument photograph on the front cover shows the HP 8118A.

PRODUCT WARRANTY

This Hewlett-Packard instrument product is warranted against defects in material and workmanship for a period of one year from date of shipment. During the warranty period, Hewlett Packard will, at its option, either repair or replace products which prove to be defective.

For warranty service or repair, this product must be returned to a service facility designated by Hewlett Packard.

Buyer shall prepay shipping charges to Hewlett Packard and Hewlett Packard shall pay shipping charges to return the product to Buyer. However, Buyer shall pay all shipping charges, duties, and taxes for products returned to Hewlett Packard from another country.

Hewlett Packard warrants that its software and firmware designated by Hewlett Packard for use with an instrument will execute its programming instructions when properly installed on that instrument. Hewlett Packard does not warrant that the operation of the instrument, or software, or firmware will be uninterrupted or error free.

LIMITATION OF WARRANTY

The foregoing warranty shall not apply to defects resulting from improper or inadequate maintenance by Buyer, Buyer-supplied software or interfacing, unauthorized modification or misuse, operation outside of the environmental specifications for the product, or improper site preparation or maintenance.

No other warranty is expressed or implied. Hewlett Packard specifically disclaims the implied warranties of Merchantability and Fitness for a Particular Purpose.

EXCLUSIVE REMEDIES

The remedies provided herein are Buyer's sole and exclusive remedies. Hewlett Packard shall not be liable for any direct, indirect, special, incidental, or consequential damages whether based on contract, tort, or any other legal theory.

CERTIFICATION

Hewlett-Packard Company certifies that this product met its published specifications at the time of shipment from the factory.

Hewlett-Packard further certifies that its calibration measurements are traceable to the United States National Bureau of Standards, to the extent allowed by the Bureau's calibration facility, and to the calibration facilities of other International Standards Organization members.

PRINTING HISTORY

**CONTROL
SERIAL
NUMBER**

Edition 1 applies directly to all instruments.

**PRINTING
HISTORY**

EDITION

DATE

PART NUMBER CODE

Edition 1

09/01/88

08118-90011

E09/88

LIST OF EFFECTIVE PAGES

EDITION

Edition 1, 09/01/88

<u>PAGE</u>	<u>EFFECTIVE DATE</u>	<u>PAGE</u>	<u>EFFECTIVE DATE</u>
Title Page (i)			
ii to vi			
Safety Summary (ix)			
xi to xii			
xv			
1-1 to 1-4		A-1 to A-7	
2-1		B-1	
2-3 to 2-8		C-1	
3-1		C-3 to C-10	
3-3 to 3-14		D none	
4-1		E.0-1	
4-3 to 4-18		E.0-3e	
5-1		E.1-1 to E.1-2	
5-3 to 5-6		E.2-1 to 2-4	
6-1		E.3-1 to E.3-4	
6-3 to 6-7		E.4-1 to E.4-4	
7-1		E.5-1 to E.5-7	
7-3 to 7-14		E.6-1 to E.6-6	
8-1 to 8-53		E.7-1 to E.7-4	
9-1 to 9-29		E.8-1 to E.8-2	
10-1 to 10-17		E.9-1 to E.9-3	
11-1 to 11-24		E.10-1 to E.10-5	
12-1 to 12-5		E.11-1 to E.11-4	
12-7 to 12-25		F-1 to F-28	
12-27 to 12-35		Index-1 to Index-11	
12-37 to 12-45		CA-1	
12-47 to 12-51		CA-3 to CA-8	
12-53 to 12-57		SSO-1 to SSO-4	
12-59 to 12-73			
12-75 to 12-86			

SAFETY SUMMARY

The following general safety precautions must be observed during all phases of operation, service, and repair of this instrument. Failure to comply with these precautions or with specific warnings elsewhere in this manual violates safety standards of design, manufacture, and intended use of the instrument. Hewlett-Packard Company assumes no liability for the customer's failure to comply with these requirements.

GENERAL — This is a Safety Class I instrument (provided with terminal for protective earthing) and has been manufactured and tested according to international safety standards.

OPERATION — BEFORE APPLYING POWER — comply with the installation section. Additionally, the following shall be observed:

Do not remove instrument covers when operating.

Before the instrument is switched on, all protective earth terminals, extension cords, auto-transformers, and devices connected to it should be connected to a protective earth via a ground socket. Any interruption of the protective earth grounding will cause a potential shock hazard that could result in serious personal injury.

Whenever it is likely that the protection has been impaired, the instrument must be made inoperative and be secured against any unintended operation.

Make sure that only fuses with the required rated current and of the specified type (normal blow, time delay, etc.) are used for replacement. The use of repaired fuses and the short-circuiting of fuseholders must be avoided.

Adjustments described in the manual are performed with power supplied to the instrument while protective covers are removed. Energy available at many points may, if contacted, result in personal injury.

Any adjustment, maintenance, and repair of the opened instrument under voltage should be avoided as much as possible, and when inevitable should be carried out only by a skilled person who is aware of the hazard involved. Do not attempt internal service or adjustment unless another person, capable of rendering first aid and resuscitation is present. Do not replace components with power cable connected.

Do not operate the instrument in the presence of flammable gas or fumes. Operation of any electrical instrument in such an environment constitutes a definite safety hazard.

Do not install substitute parts or perform any unauthorized modification to the instrument.

Capacitors inside the instrument may still be charged even if the instrument has been disconnected from its source of supply.

SAFETY SYMBOLS



The apparatus will be marked with this symbol when it is necessary for the user to refer to the instruction manual in order to protect the apparatus against damage.



Indicates dangerous voltages.



Earth terminal.

WARNING

The WARNING sign denotes a hazard. It calls attention to a procedure, practice, or the like, which if not correctly performed or adhered to, could result in injury or loss of life. Do not proceed beyond a WARNING sign until the indicated conditions are fully understood and met.

CAUTION

The CAUTION sign denotes a hazard. It calls attention to an operating procedure, practice, or the like, which if not correctly performed or adhered to, could result in damage to or destruction of part or all of the equipment. Do not proceed beyond a CAUTION sign until the indicated conditions are fully understood and met.



Dangerous voltages, capable of causing serious personal injury, are present in this instrument. Use extreme caution when handling, testing, and adjusting.



INTRODUCTION

The manual information is arranged into four categories:

INSTRUMENT DESCRIPTION

Descriptions of selected operating principles:
Chapters 1-7.

QUICK REFERENCE GUIDES

Local and remote programming and editing information:
Chapters 8-12.

REFERENCE DATA

Supporting information of a non-operational nature:
Appendices A-F.

CUSTOMER ASSISTANCE

Sales and Service information:
Customer Assistance Information
Sales and Support Offices Directory.

Application programming level knowledge of IEEE Standards 488.1 and 488.2 is desirable for programming the HP 8118A.

Viel Spass!
Hewlett-Packard GmbH

CONTENTS

MANUAL DESCRIPTION xi

INSTRUMENT DESCRIPTION

Features	1-1
Getting Started	2-1
Controls	3-1
Display	4-1
Data Pattern	5-1
Remote Messages	6-1
Operating State	7-1

QUICK REFERENCE GUIDES

Display Functions	8-1
Editor-Word Mode	9-1
Editor-Bit Mode	10-1
Common Commands	11-1
Device Dependent Commands	12-1

REFERENCE DATA

Specifications	A-1
Options and Accessories	B-1
Installation and Maintenance	C-1
Backdating	D-1
Performance Tests	E-1
Errors	F-1

INDEX Index-1

CUSTOMER ASSISTANCE

Customer Assistance Information	CA-1
Sales and Support Office Directory	SSO-1

CHAPTER 1

INSTRUMENT FEATURES

INTRODUCTION

The HP 8118A has two configurations:

1. 50 MHz pulse generator
2. 100 Mbit/s (NRZ) or 50 Mbit/s (RZ/DNRZ) pattern generator

The pattern generator provides 16 kbits of pattern data per channel and an internal data editor.

The instrument has internal(RAM) and external(disc) storage capability and external printer capability.

The interface (HP-IB) is a byte-serial, bit-parallel, asynchronous interface. It is defined in Appendix A, Specifications.

Specifications: see Appendix A.

Options and Accessories: see Appendix B.

The instrument features are outlined in Tables 1-1 and 1-2.

**TABLE 1-1.
PULSE
GENERATOR
FEATURES**

TRIGGER (EXTERNAL INPUT)

Automatic
Trigger
Gate

CONTROL (CONTROL INPUT)

Timing
Period
Width
Delay
Level
High Level

TIMING

Period
Delay
Double Pulse (pulse generator only)
Width
Transition Type
Leading Edge
Trailing Edge

OUTPUT (CHANNELS 1 AND 2)

State
Polarity
Addition
Level
High and Low
Amplitude and Offset
Limit

TRIGGER OUTPUT

**TABLE 1-2.
PATTERN
GENERATOR
FEATURES**

TRIGGER (EXTERNAL INPUT)

Automatic
Trigger
Gate

CONTROL INPUT (See pulse features.)

EXTERNAL CLOCK

TIMING (See pulse features.)

CYCLING

Autocycle
Single cycle
Single-step
Start/Stop/Continue

STROBE

Timing
Delay, Width
Mode
Bit, Word, Frame Start/End

DATA FORMATS

RZ, NRZ, DNRZ

PATTERN MODES (DATA FRAME)

Bit
Word

EDITOR FUNCTIONS

Insert
Delete
Copy
Move
Modify

OUTPUT (See pulse features.)

BREAK MODE

TRIGGER OUTPUT

PULSE PARAMETERS

Time Reference Point: Median (50% amplitude point on pulse edge).

Pulse Period: The time interval between the leading edge medians of consecutive trigger output pulses.

Trigger Delay: Interval between trigger point of input signal and the trigger output pulse's leading edge median. Applies in trigger, external width, gate and burst modes.

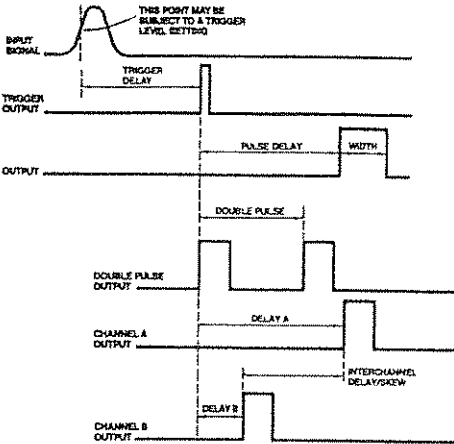

Pulse Delay: Interval between leading edge medians of trigger output pulse and output pulse.

Double Pulse: Interval between leading edge medians of the double pulse.

Interchannel Delay/Skew: Interval between corresponding leading edge medians.

Pulse Width: Interval between leading- and trailing-edge medians.

Duty Cycle: Percentage ratio of pulse width to period. In pulse/function generators, this term is also used to define sine and triangle symmetry.

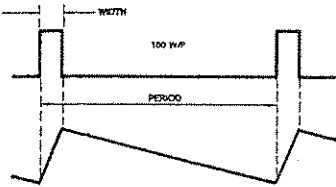

Transition Time: Interval between the 10% and 90% amplitude points on the leading/trailing edge.

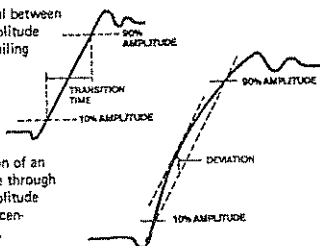

Linearity: Peak deviation of an edge from a straight line through the 10% and 90% amplitude points, expressed as percentage of pulse amplitude.

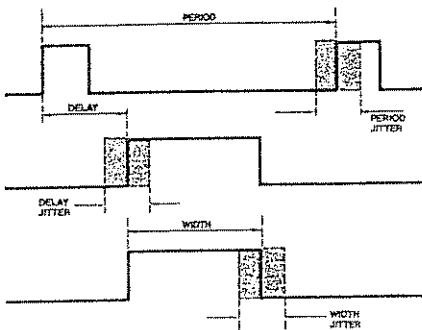

Stability: Long-term average instability, expressed as percentage of main parameter over a specific time duration, e.g. hour, year. Excludes jitter.

Jitter:

Short term timing instability: rms jitter is based on 1000 measurements and is identical to the standard deviation.

Pulse Width: The specified and displayed value is that obtained with fastest edges; essentially equal to the interval from the start of the leading edge to the start of the trailing edge.

By designing so that the pulse edges turn about their start points, the interval from leading edge start to trailing edge start stays unchanged* when transition times are varied. This is more convenient for programming and the width display is easy to interpret.

*In practice, start points may shift with change in transition time.

Delay: The specified and displayed value is that obtained with the fastest leading edge. For a slower edge, the actual delay exceeds the displayed delay by the combined shift of start-point and median.

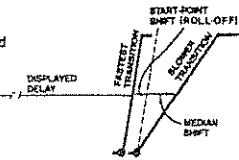
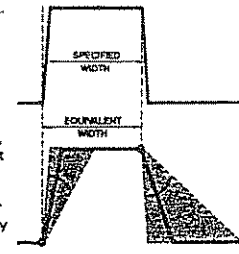

Pulse Level: High level and low level. Any limitation is expressed by an amplitude specification.

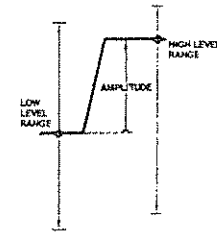

Pulse Amplitude (alternative to level definition): Pulse amplitude and offset* are specified. Any limitation is expressed by a window (max high level, min low level).

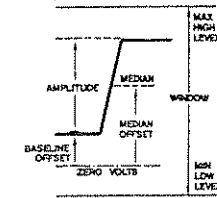

*Pulse generators use baseline offset. Function generator outputs are symmetrical and consequently use median offset.

Preshoot, Overshoot, Ringing: Preshoot and overshoot are peak distortions preceding/following an edge. Ringing is the positive peak and negative peak distortion excluding overshoot, on pulse top or base. A combined preshoot overshoot, ringing specification of e.g. $\pm 5\%$ implies:

- Overshoot/undershoot $< 5\%$,
- Largest pulse-top oscillation $< \pm 5\%$ of pulse amplitude.

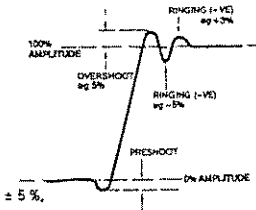

Settling Time: Time taken for pulse levels to settle within level specification, measured from 90% point on leading edge.

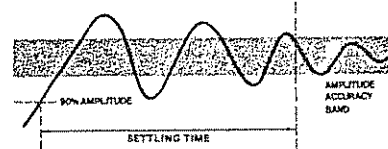

Output Impedance/Resistance: Effective pulse source impedance/dc resistance.

Reflection Coefficient: Reflection at pulse generator output expressed in percent of incident pulse amplitude. (Test pulse edges correspond to generator's fastest transitions).

Repeatability: When an instrument operates under the same environmental conditions; and with the same settings, the value of a parameter will lie within a band inside the accuracy window. Repeatability defines the width of this band.



CHAPTER 2

GETTING STARTED

CONTENTS

Introduction	2-3
Power-on	2-3
Power-on Test	2-3
Normal State	2-3
Abnormal State	2-3
Power-off	2-3
HELP	2-4
Local Control Programming	2-6
Display Selection	2-6
Message Lines	2-7
Data Entry	2-7
Controls	2-7
Remote Control Programming	2-7
Under/Overprogramming	2-7
Programming a Setting	2-8

FIGURES

1 HELP, Programming Information	2-4
2 HELP, Operating State Information	2-5

INTRODUCTION

Getting Started defines several fundamental operating principles for the first time user of the instrument.

POWER-ON

At power-on, the instrument:

1. Performs a power-on test and
2. Enters the normal or abnormal operating state as described below.

Power-on Test

The instrument performs the following tests.

1. Processor Board Test
2. Board Test (Data, Clock, and Amplifier)

See Appendix F, Table F-1.

Normal State

In the normal state (error free condition):

1. The instrument is initialized and enters the IDLE state.
2. The display defaults to the system configuration display.
3. The instrument is now ready for normal operation.
4. The instrument's setting is restored to the setting stored at power-off; however, outputs 1 and 2 are disabled.

Abnormal State

In the abnormal state (error condition exists):

1. If the processor board test fails, the instrument is not operable. The message **'cannot continue'** is displayed.
2. If a parametric board test fails, the message **'Press any key to continue'** is displayed (The BLUE key is excluded.).

It is possible to operate the instrument. Check the errors displayed, and determine where the failures are and how they effect the required performance.

POWER-OFF

At power-off, the instrument's setting is stored in RAM.

HELP

HELP information is available by pressing the GREEN key.

Programming Information

1. In an error free state, HELP provides programming information about the field in which the cursor appears and lists the corresponding remote commands. See the following figure.

The limits are given in the limit, level, amplitude and offset fields.

The Data [Entry] and System [Configuration] HELP messages list commands not listed in other HELP messages.

Output (PULSE) -----

Channel 1		Channel 2	
State	: OFF	State	: OFF
Polarity	: Normal	Polarity	: Normal
Addition	: ON		
High Level	: 1.00V	High Level	: 1.00V
Low Level	: 0.00V	Low Level	: 0.00V
Limit	: OFF	Limit	: OFF

HELP

Selecting On makes the current levels the limit values.
Actual HIGH limit: Off;
Actual LOW limit : Off;

:PULSe1:LEVel:LIMit ON!OFF!110

Operating State Information

2. If an error or warning condition exists, HELP provides information about the error or warning condition and a summary of the errors present in the instrument. See the following figure.

The summary information is contained in the three fields in the upper left corner of the HELP message.

S = total number of software errors

H = total number of hardware errors and warnings

W = total number of software warnings.

See STATUS BYTE, Chapter 7, for additional information.

Output (PULSE)-----WARNING Limit Ch.1 - Addition---

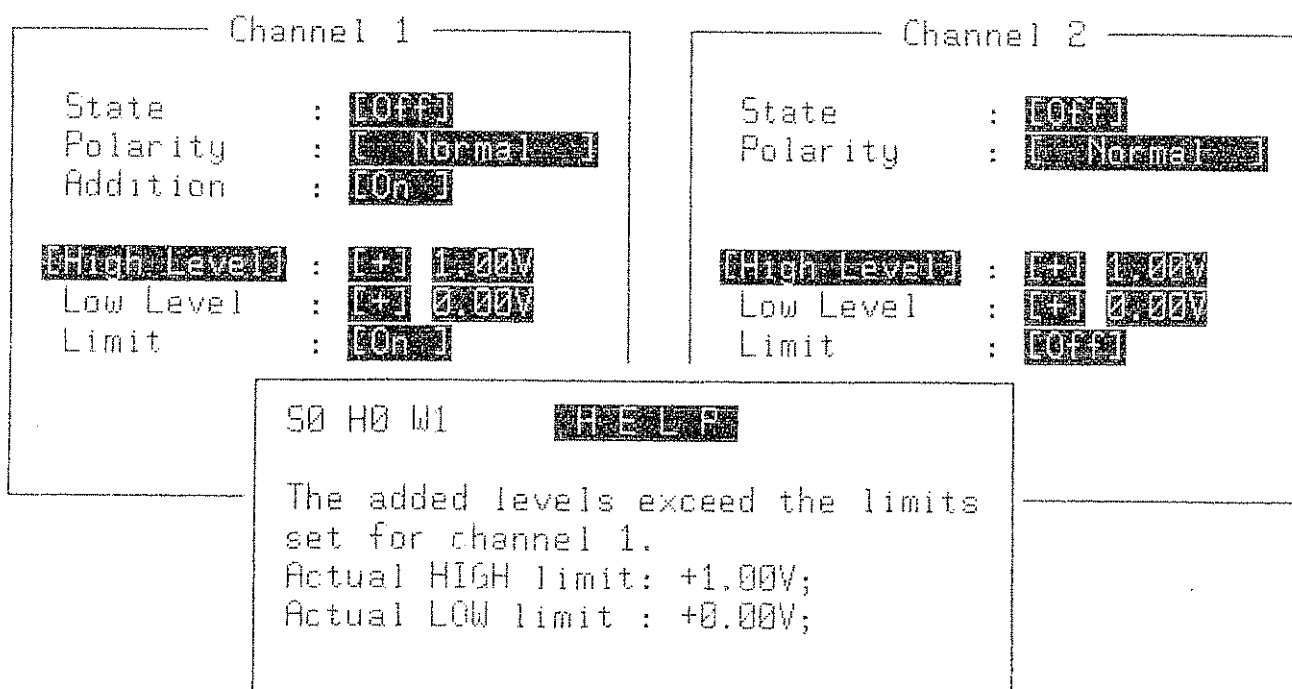

LOCAL CONTROL PROGRAMMING

In the local mode, formatted displays guide instrument programming.

1. Chapter 4 describes the common characteristics of the formatted displays.
2. Chapters 8 describes the specific capabilities of each display.
3. Chapters 9 and 10 describe the edit functions accessible at the data entry display.

There are nine displays:

1. System [Configuration]
2. System [Peripherals]
3. Save [Internal]
4. Save [External]
5. Control (Pulse|Pattern)
6. Timing (Pulse|Pattern)
7. Output (Pulse|Pattern)
8. Data [Format]
9. Data [Entry]

Display Selection

The displays are selected by:

1. Pressing a main display key, for example, DATA.
2. Placing the cursor in the [Alternate] display field (See Message Lines, Chapter 4.) and pressing the NEXT key.

For example, when the data format display is displayed, [Format] appears in the first line of the display. By placing the cursor in this field and pressing the NEXT key, the data entry display is selected and [Entry] appears in line one.

3. Pressing a pulse parameter key, for example, press the BLUE key and then WIDTH to access the WIDTH field at the TIMING display.

Message Lines

The top two lines of the display contain configuration, status, and operating information. The message lines are described in Chapter 4.

Data Entry

The displays contain fields shown in inverse video into which the cursor can be placed. When the cursor is in a field, changes can be made to that field or HELP can be requested, GREEN key.

Fields with square brackets, [], are option fields. The current entry is changed by pressing the NEXT or PREV keys.

Fields without the square brackets require direct entry of data. This is accomplished with the alpha-numeric, POINT, CLEAR ENTRY, and DON'T CARE keys. The special actions of the CLEAR ENTRY and DON'T CARE keys are described in Chapter 3.

Editing and other data pattern operations are described in Chapter 5.

Controls

All controls are defined in Chapter 3.

REMOTE CONTROL PROGRAMMING

The instrument is programmed via program messages in the remote mode.

The remote messages are:

1. Defined in Chapter 6
2. Diagrammed in Chapters 11 and 12.

UNDER and OVER PROGRAMMING

Under and over programming is allowed. See Chapters 8 and 12 for the allowed programming ranges.

PROGRAMMING A SETTING

Programming a setting involves up to six steps.

1. **Known state selection:** the current setting, a stored setting, or the reset setting can serve as a known starting state.
 2. **Configuration selection:** pulse or pattern generator.
 3. **Timing specification:**
 - a. Pulse timing
 - b. Strobe timing (pattern configuration only)
 4. **Data specification** (pattern configuration only):
 - a. Data format
 - b. Data entry or editing
 5. **Control selection:**
 - a. Trigger (external input)
 - b. Control (control input)
 - c. External clock (pattern configuration only)
 - d. Cycling (pattern configuration only)
 6. **Output formatting:**
 - a. Channel 1/2 polarity
 - b. Channel 1/2 addition
 - c. Channel 1/2 pulse levels and limits
 - d. Data format (pattern configuration only)
 - e. Strobe mode (pattern configuration only)
 - f. Channel 1/2 state
- NOTE: Make all level changes before enabling the outputs.**

CHAPTER 3 CONTROLS

CONTENTS

Keys	3-3
Input	3-10
Output	3-12
Interface, HP-IB	3-13

FIGURE

1 Printing Example (Word Length > 40 digits)	3-9
2 Edge Ranges	3-11

9

KEY DESCRIPTIONS

KEY FUNCTIONS

Almost all keys have two functions.

1. One function is printed on the keycap and requires only one key press.
2. One function is printed in blue letters directly above the corresponding key. The blue lettering indicates that these functions require shifted entry. Thus, the BLUE key (shift key) must be pressed first. To cancel the shift, press the BLUE key a second time. When the shift function is active, the message SHIFT is displayed in the second message line except when the messages REMOTE and LOCAL LOCKOUT are displayed.

0-9

See ALPHA-NUMERIC keys.

A-F

See ALPHA-NUMERIC keys.

ABORT

ABORT cancels an edit function.

ALPHA-NUMERIC

Alpha-numeric keys are used:

1. To enter values in data and parameter input fields.
2. Write file names and file descriptions.

ARROWS

See CURSOR, ROLL, or VERNIER keys.

BLUE

The BLUE key is the shift key. See KEY FUNCTIONS.

CLEAR ENTRY

CLEAR ENTRY sets a field to a default value except for interface addresses (See Chapter 8).

CNTRL

CNTRL, control, selects either the pulse control display or the pattern control display.

CONTINUE

CONTINUE restarts pattern cycling in the pattern generator from the bit at which the pattern was stopped.

COPY

COPY selects the editor's COPY function if the data entry display is displayed. If the data entry display is not displayed the command is ignored.

CURSOR

CURSOR keys (4) are marked with arrows. They move the cursor about the display as indicated by the arrow.

The display alphabet used at the save internal and external displays operates as follows:

1. Place the cursor in the required name or description field.
2. Hold the shift key down, and move the character marker to the required alpha character with the left or right arrow cursor keys. Release the shift key. The character marker is the character displayed in inverse video, for example, the character A in the following figure.
3. Press the shift key to activate the shift function, and press the up arrow cursor key to write the alpha character into the name or description field.

```
Operation : [ Save ] into Location [ ]
Description : [ USER SETTING 1 ]
[ A ]BCDEFGHIJKLMNOPQRSTUVWXYZ
```

DATA

DATA selects either the data format display or the data entry display. Changing between data format and entry is accomplished at the current page field.

DELAY

DELAY moves the cursor to the delay field or the delay range field (if control mode 'delay' is enabled) except when data format NRZ is selected. If the timing display is not currently displayed, the display will change to the timing display unless the exception described applies.

DELETE

DELETE selects the editor DELETE function if the data entry display is displayed. If the data entry display is not displayed, the command is ignored.

DISPLAY ALPHABET

See CURSOR keys.

DON'T CARE

DON'T CARE is defined as follows: 'the value of this field position is not significant'.

DON'T CARE has the effect of deleting the entry at the cursor's position.

DON'T CARE can also effect digits to the right of the cursor's current position.

EDIT FUNCTION KEYS

INSERT, DELETE, COPY, MOVE, AND MODIFY are the edit function keys.

EXECUTE (EXEC.)

EXECUTE has two effects:

1. It executes edit functions which change the setting.
2. It executes storage operations.

GREEN

The GREEN key selects the HELP function which provides information regarding:

1. Programming requirements
2. Error and warning conditions.

The information provided is for the field where the cursor is located. See HELP, Chapter 2.

HIGH

HIGH moves the cursor to the high level or amplitude field at the output display except when control mode 'high level' is enabled. If the output display is not currently displayed, the display will change to the output display unless the exception described applies.

INSERT

INSERT selects the editor's INSERT function if the data entry display is displayed. If the data entry display is not displayed, the command is ignored.

LEADING

LEADING moves the cursor to the leading edge field at the timing display. If the timing display is not currently displayed, the display will change to the timing display. There are separate LEADING (edge) keys for each channel.

LOW

LOW moves the cursor to the low level field or the offset field at the output display. If the output display is not currently displayed, the display will change to the output display. There are separate LOW (level) keys for each channel.

MAIN DISPLAY KEYS

SYSTEM, SAVE, CONTROL, TIMING, OUTPUT, and DATA

MANUAL

MANUAL has two functions.

1. Pulse generator configuration:
 - a. Triggers one output pulse/press.
 - b. Gates output pulses until released.
2. Pattern generator configuration:

The pattern is single stepped one bit/press.
The generator must be in the stopped state.

When a MANUAL function is executed, the trigger stated changes to OFF if it is ON.

MODIFY

MODIFY selects the editor's modify function if the data entry display is displayed. If the data entry display is not displayed, the command is ignored.

MOVE

MOVE selects the editor's move function if the data entry display is displayed. If the data entry display is not displayed the command is ignored.

NEXT

NEXT selects the next available option in an option field.

OUTPUT

OUTPUT selects either the pulse output display or the pattern output display.

PERIOD

PERIOD moves the cursor to the period field except when trigger mode 'trigger'(pulse generator only) is enabled or to the period range field if control mode 'period' is enabled(both generators). If the timing display is not currently displayed, the display will change to the timing display unless the exception described applies.

POINT

POINT is used as

1. A parameter field entry (decimal point)
2. Part of a file description
3. To indicate an unchanged digit when using the modify edit operation.

PREV

PREV selects the option before the current option displayed in an option field.

PRINT

The current display is printed.
PRINT can be terminated by pressing the STOP key.

PRINT ALL

The current display is printed for all displays except the save and data entry displays.

With the save displays, all directory files beginning with the file marked by the right bracket,>, are printed.

With the data entry display, all data beginning with the data marked by the data entry field marker are printed.

In the bit mode or with a Word Length < 21 digits both channel are printed. With a Word Length greater than 20 digits only one channel is printed.

If the word size is greater than 40 digits , the words are printed 40 digits per page. Print Page 1.0 includes the first 40 digits, Print Page 1.1 contains the next 40 digits, etc. See the figure on page 3-14.

PRINT ALL can be terminated by pressing the STOP key.

**RETURN
TO LOCAL**

RETURN TO LOCAL returns the instrument to the LOCAL control programming mode unless local lockout is active.

ROLL

The ROLL keys (2) allow data on the data entry display to be moved as indicated by the direction of the arrows.

SAVE

SAVE selects the internal or external display.

FIGURE 3-1. PRINTING (WORD LENGTH > 40 DIGITS)

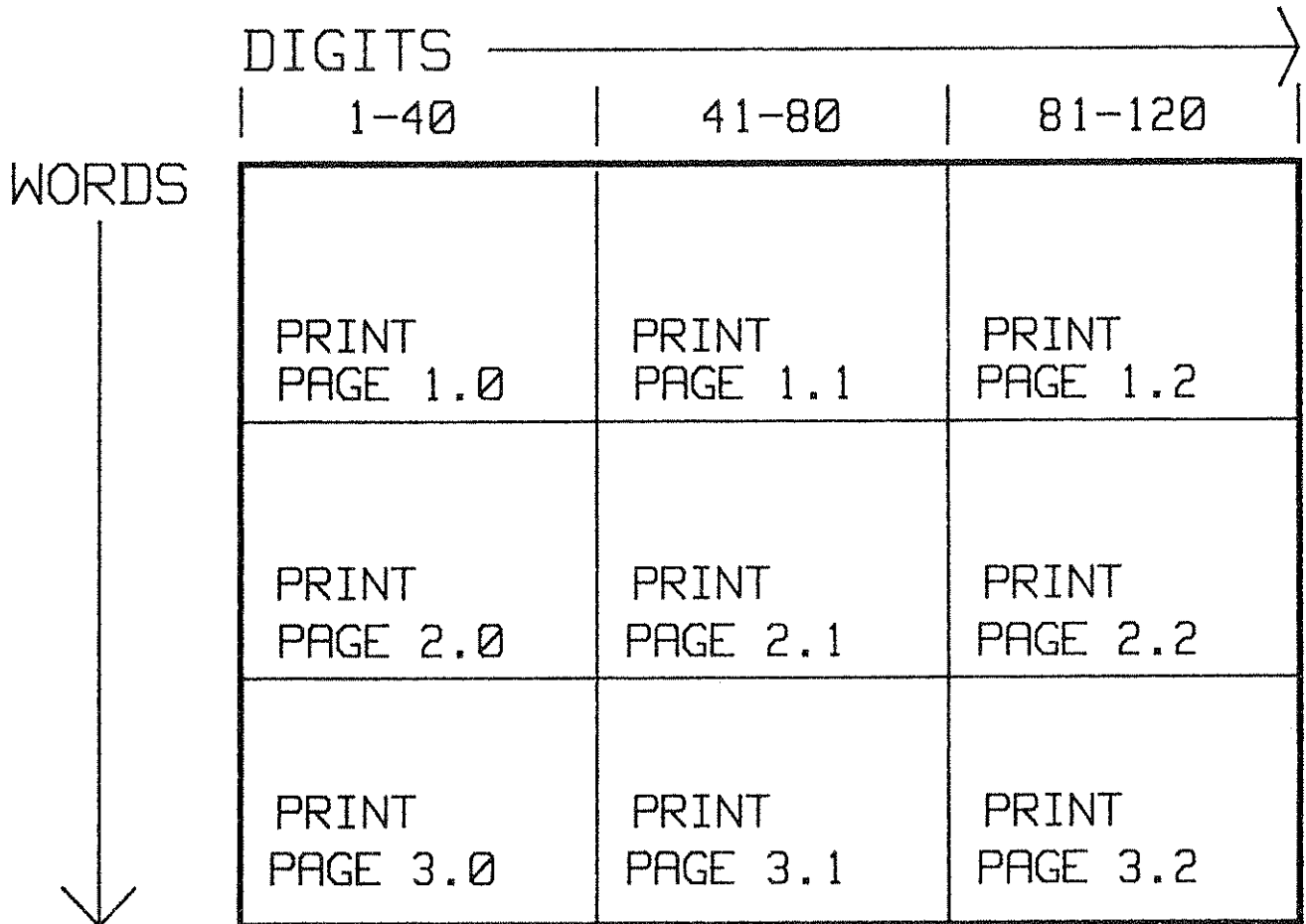

SHIFT	See KEY FUNCTIONS.
SINGLE STEP	See the MANUAL key.
START	<p>START causes the pattern generator to begin repeated (automatic) cycling or a single cycle of the pattern data. When the generator is cycling, it is said to be running or in the RUN mode. A 'RUN' message appears in the second line of the display when the pattern generator is running.</p> <p>START events initialize the data vector; therefore, the pattern begins cycling at the first bit of the frame.</p>
STATE	STATE moves the cursor to the Channel 1/2 state field at the output display.
STOP	STOP causes the pattern generator to stop running and enter a halted state. Cycling can be resumed by pressing the CONTINUE or START keys or sending the equivalent remote commands.
SYSTEM	SYSTEM selects either the configuration display or the peripherals display.
TIMING	TIMING selects either the pulse timing display or the pattern timing display.
TRAILING	TRAILING moves the cursor to the trailing edge field on the timing display. If the timing display is not currently displayed, the display will change to the timing display. There are separate keys for each channel.
UPDATE	UPDATE transfers selected parts of the setting which are related to the pattern data to the hardware. See Chapter 5, UPDATING for additional information.

VERNIER

The VERNIER keys:

1. Allow continuous changing of values
2. Change a value outside a limit to the limit value
3. Reformat decimal values to integer values
4. Resolve slope conflicts.

When changing the leading or trailing edges, auto-ranging can occur which results in a change to a slope's value or resolution. See Figure 3-2.

Example 1. Up-ranging (value change).

1. One edge is not within overlapped ranges, for example, 48.8 ns.
2. The other edge is within overlapped ranges, for example, 99.9 ns.
3. When the 99.9 ns edges is changed to 100 ns, the 48.8 ns edge is auto-ranged to 488 ns(multiplied by 10).

Example 2. Up-ranging (resolution change).

1. Both edges are within overlapped ranges, for example, 78.3 ns and 99.9 ns.
2. When the 99.9 ns edge is changed to 100 ns the 78.3 ns edge changes to 78. ns.

Example 3. Down-ranging (value change).

1. One edge is not within overlapped ranges, for example, 333 ns.
2. The other edge is within overlapped ranges, for example, 050. ns.
3. When the 050. ns edge is changed to 49.0 ns, the 333 ns edge is auto-ranged to 33.3 ns(divided by 10).

Example 4. Down-ranging (resolution change).

1. Both edges are within overlapped ranges, for example, 078. ns and 050. ns.
2. When the 050. ns edge is changed to 49.0 ns the 078. ns edged changes to 78.0 ns.

FIGURE 3-2. EDGE RANGES

RANGE

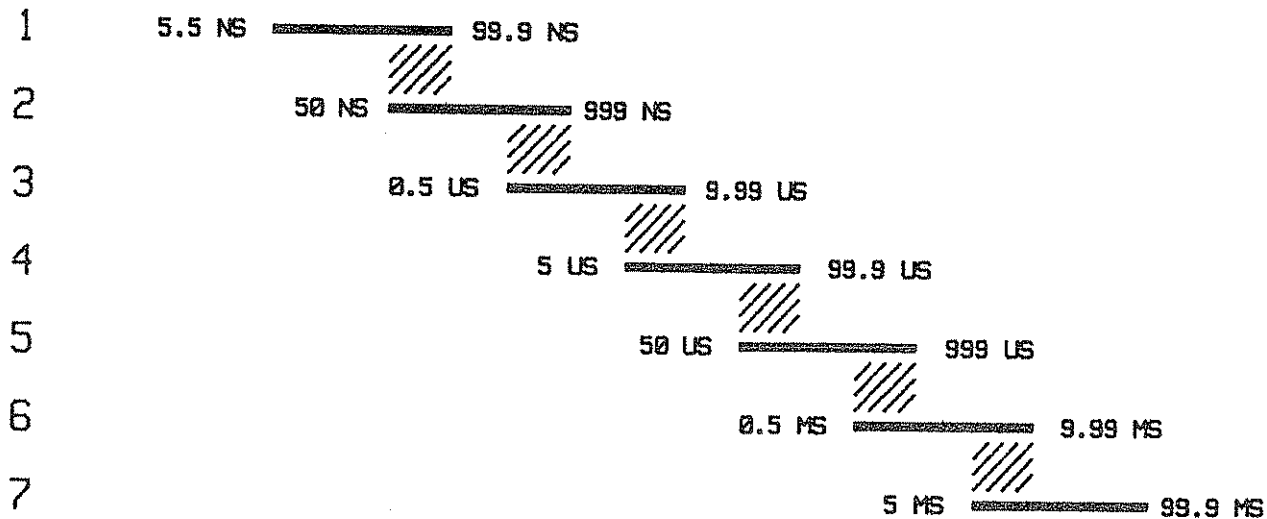

POLARITY

POLARITY defines the output signal format:

1. NORMAL=as specified by the pulse parameters
2. COMPLEMENT=inverted form of NORMAL.

WIDTH

WIDTH moves the cursor to the width field or the width range field (if control mode 'width' is enabled) except when data formats NRZ and DNRZ are selected. If the timing display is not currently displayed, the display will change to the timing unless the exception described applies.

INPUTS

External Input

Pulse generator:

1. Trigger mode: One pulse or pulse pair is generated per trigger event.
2. Gate mode: Pulse or pulse pairs are generated for the duration of the gate. The last pulse is always completed.

Pattern generator:

1. Trigger mode: Each trigger event is a START event.
2. Gate mode: Each gate provides a START and a STOP event.

External input programming is accomplished with the trigger function at the control display or via the :INPut:TRIGger command path.

Control Input

The control input controls the period, delay, double pulse delay, width, and high level of channels 1 and 2 except in the pattern generator where double pulse is not available. The input is located on the rear panel.

Control input programming is accomplished with the control function at the control display or via the :INPut:CONTRol command path.

External Clock

The external clock is the pattern generator's alternate data clock. Maximum frequencies are: RZ and DNRZ = 50 MHz, NRZ = 100 MHz. The generator must be in the stopped state before the external clock state can be changed. The input is located at the rear panel.

External clock programming is accomplished with the external clock function at the control display or via the :INPut:CLOCK command path.

OUTPUTS

Output 1/2

Outputs 1/2 are the pulse generator and pattern generator main outputs and correspond to channels 1/2. The outputs can be disabled at the output display or with the :OUTPut:PULSe command path.

Strobe

The pattern generator strobe has four modes:

1. Bit
2. Word (first bit of the word)
3. Frame start (first bit of the frame)
4. Frame end (last bit of the frame).

Strobe mode programming is accomplished with the strobe function at the output display or via the :DATA:STRobe command path.

The delay and width can be programmed in most circumstances also. See Chapter 8, Strobe for details.

Strobe delay and width programming is accomplished with the Strobe function at the timing display or with the :PULSe:TIMing command path (Channel 3).

Trigger Output

One output trigger pulse is generated for each pulse, pulse pair, bit, or word.

INTERFACE

HP-IB

The interface (HP-IB) is a byte-serial, bit-parallel, asynchronous interface. Interface specifications are listed in Appendix A. The port is located on the rear panel.

CHAPTER 4

DISPLAY

CONTENTS

Introduction	4-3
Display Types	4-3
Display Selection	4-3
Labels	4-4
Fields	4-4
Message Lines	4-6
Data Entry Display	4-8
Markers	4-8
'Cursor on ...' Fields	4-9
Data Entry Field	4-9

FIGURES

1A	Timing (Pulse)	4-5
1B	Timing (Pattern)	4-5
2A	Data [Format]	4-7
2B	Data [Entry]	4-7
3A	Data [Format]	4-10
3B	Data [Entry]	4-10
4A	Data [Format]	4-11
4B	Data [Entry]	4-11
5A	System [Configuration]	4-12
5B	System [Configuration]	4-12
6	System [Peripherals]	4-13
7	Save [Internal]	4-14
8	Save [External]	4-15
9	Control (Pattern)	4-16
10	Timing (Pattern)	4-17
11	Output (Pattern)	4-18

INTRODUCTION

The characteristics common to all displays are described in this chapter. Unique display characteristics are described in Chapter 8.

DISPLAY TYPES

Nine formatted displays are used to program the instrument locally.

1. System [Configuration] display
2. System [Peripherals] display
3. Save [Internal] Display
4. Save [External] Display
5. Control (Pulse|Pattern)
6. Timing (Pulse|Pattern)
7. Output (Pulse|Pattern)
8. Data [Format]
9. Data [Entry]

Display Selection

The displays are selected by:

1. Pressing a main display key, for example, DATA.
2. Placing the cursor in the [Alternate] display field (See MESSAGE LINES.) and pressing the NEXT key.

For example, when the data format display is displayed, [Format] appears in the first line of the display. By placing the cursor in this field and pressing the NEXT key, the data entry display is selected and [Entry] appears in line one. See Figures 4-2A and 4-2B.

3. Pressing a pulse parameter key, for example, press the BLUE key and then WIDTH to access the WIDTH field at the TIMING display.

Labels

Labels (Period , [Delay], etc.) identify the programming fields where parameters are entered or changed. In most cases the labels do not change; however, in four cases, they can change:

1. Optional labels inclosed in brackets,[], can be changed by placing the cursor at the label and pressing the NEXT or PREV keys; for example, [Delay] can be changed to [Double] in the pulse generator. See Figure 4-1A, Channels 1 and 2.
2. Labels change as a result of another action; for example, if control mode [Period] is enabled, the Period label at the timing display changes to Period Range. See Figures 4-1A and 4-1B.
3. Labels are deleted when the programming they describe is not allowed; for example, the Delay and Width labels are not displayed for a channel with data format NRZ. See Figure 4-1B, Channel 2.
4. Labels can change when the configuration is changed. See control mode 'delay', page 8-11.

Fields

There are two types of fields (inverse video).

1. **Direct Entry Field.** Data is entered as required with the alpha-numeric keys and SAVE display alphabet. The use of the VERNIER, DON'T CARE, POINT, and CLEAR ENTRY keys are described in Chapter 3.
2. **Option Field.** Square brackets, [], enclose the current option. By placing the cursor in the field and pressing the NEXT or PREV (previous) key the option is changed.

FIGURE 4-1A/B. LABEL AND FIELD EXAMPLES

Timing (PULSE)

Period : 1.00 [ms]

Channel 1	
[Delay]	: 75.0 [ns]
Width	: 100. [µs]
Transition	: [Linear]
Leading	: 10.0 [ns]
Trailing	: 10.0 [ns]

Channel 2	
[Double]	: 200. [µs]
Width	: 100. [µs]
Transition	: [Fixed]
Leading	: 5.5 ns
Trailing	: 5.5 ns

Timing (PATTERN)

Period Range : 99.9 ns

Channel 1	
Delay	: 75.0 [ns]
Width	: 100. [µs]
Transition	: [Linear]
Leading	: 10.0 [ns]
Trailing	: 10.0 [ns]

Channel 2	
Transition	: [Gaussian]
Leading	: 10.0 [ns]
Trailing	: 10.0 [ns]

Strobe	
Delay	: 75.0 [ns]
Width	: 100. [µs]

Message lines

The message lines are the top two lines of the display and report the following types of information. See Figure 4-2. All local messages are listed in Appendix F except device command paths (See Chapter 12.).

Display-Line number one:

1. **Main Display Label:** This label identifies which type of display is selected, for example, Data in Figure 4-2A.
2. **[Alternate] display field:** This option field is displayed when a SYSTEM, SAVE, or DATA main display is selected, for example, [Format] in Figure 4-2A and [Entry] in Figure 4-2B.
3. **(Configuration):** This label identifies the current instrument configuration at the CONTROL, TIMING, and OUTPUT main displays, for example, (Pattern) in Figure 4-9 on page 4-16.
4. **Instructions:** Operating instructions.
5. **Status:** Error conditions and disallowed events are reported.

Display-Line number two:

6. **OUTPUT 1/2:** OUTPUT 1 or OUTPUT 2 is displayed when the output is enabled.
7. **Command Path:** When a remote programming error occurs, the erroneous command path is listed within angle brackets, < >, followed by three question marks, ???.
8. **REMOTE:** Indicates that the instrument is in the remote control programming mode.
9. **LOCAL LOCKOUT:** Indicates when the front panel controls are disabled.
10. **SHIFT:** Indicates when the shift function is enabled except when the REMOTE and LOCAL LOCKOUT messages are displayed.
11. **UPDATE:** Indicates that updating is required before the hardware is updated/changed.
12. **RUN:** Indicates that the pattern generator is currently cycling the pattern data.

DATA ENTRY DISPLAY

Pattern data can be entered directly or edited at the data entry display.

The editor is described in Chapters 5, 9, and 10.

Markers

Markers are used in place of borders as visual guides. See Figures 4-2B and 4-3B.

There are three types of markers

1. Digit markers indicate which digit of the bit pattern or word pattern is in the left column of the displayed pattern data.
2. Word markers indicate which word of the frame is displayed at that line.
3. Data entry field markers indicate which digits or words are currently positioned at the data entry field.

The markers are arrows with word, digit, or channel labels.

'Cursor on...' Fields

The data in the 'Cursor on Digit' and 'Digit on Word' fields are related to the cursor's location.

1. If the cursor is not in the data entry field, the address defines the entry point for the cursor when it is moved into the data entry field.
2. If the cursor is moved about in the data entry field, the 'Cursor on ...' fields are updated with the current cursor address.

The 'Cursor on ...' fields are used as reference locations for many editor functions. To change this reference location:

1. Directly enter the location in the 'Cursor on ...' fields
2. Move the cursor about in the data entry field.
3. ROLL data

The first bit or word in a frame and the first bit in a word are number zero not number one.

Data Entry Field

Data is entered directly at the data entry field with the alpha-numeric keys.

Updating is required to transfer the data to the current memory(update the hardware).

CLEAR ENTRY is allowed with the effect of clearing all data in the data entry field.

DON'T CARE is not allowed in this field.

FIGURE 4-3A/B. DATA [Entry]...Word Mode

Data **[Format]** ----- UPDATE

Frame

Mode : **[None]**

Word-Length : **[8]** Bits

No. of Words : **[8]**

Cycling

Mode : **[Auto]**

Break

Mode : **[Off]**

Break-Bit : **[7]**

Break-Word : **[7]**

Data-Format

Channel 1 : **[LRZ]**

Channel 2 : **[NRZ]**

Data **[Format]** ----- UPDATE

Display **[Both Channels]** Base: **[Bin]** Cursor on Word : **[7]**
 Words : 8 Cursor on Digit: **[8]**
 Digits: 8

		Channel 1	Channel 2
Word	Digit →	0	0
	↓	↓	↓
0		00000000	00000000
1		00000000	00000000
2		00000000	00000000
3		00000000	00000000
4		00000000	00000000
5		00000000	00000000
6		00000000	00000000
7←		00000000	00000000

FIGURE 4-4A/B. DATA [Entry]...Bit Mode

Data **[Format]** ----- UPDATE

Frame

Mode : **[0:1:1]**

No. of Bits : **[8:4]**

Cycling

Mode : **[Auto]**

Break

Mode : **[0:0]**

Break-Bit : **[8:8]**

Data-Format

Channel 1 : **[RZ]**

Channel 2 : **[NRZ]**

Data **[Entry]** ----- UPDATE

Display **[Both Channels]** Base: **[Bin]** Cursor on Digit: **[80]**

Digits: 84

----- Channel 1 ----- Channel 2 -----

Digit
↓

0	0000000000	0000000000	0000000000	0000000000
20	0000000000	0000000000	0000000000	0000000000
40	0000000000	0000000000	0000000000	0000000000
60	0000000000	0000000000	0000000000	0000000000
80←	[0000]		[0000]	

FIGURE 4-5A/B. SYSTEM [CONFIGURATION]

System **[Configuration]** _____ROLL to Change Configuration_____

Pulse Generator (PULSE)
Pattern Generator (PATTERN)

Pulse Generator Specification

Max. Frequency	: 50 MHz
Var. Transition	: 6.5 ns ... 95 ms
Output Voltage	: 100 mVpp ... 16 Vpp into 50 Ohm
Channels	: 2

System **[Configuration]** _____ROLL to Change Configuration_____

Pulse Generator (PULSE)
Pattern Generator (PATTERN)

Pulse Pattern Generator Specification

Memory Space	: 16384 Bit
Max. Pattern Rate	: 100 MBit/s NRZ
Var. Transition	: 6.5 ns ... 95 ms
Output Voltage	: 100 mVpp ... 16 Vpp into 50 Ohm
Channels	: 2

FIGURE 4-6. SYSTEM [PERIPHERALS]

System [Peripherals]

Printer

Address : 01
Type : Graphics

Disk

Address : 7
Unit : 001

Beeper

State : On

HP-IB

Address : 18
HP 8118A is Controller

FIGURE 4-7. SAVE [INTERNAL]

Save **INTERNAL** -----Use Shift Curs. ←→ to get Char.

Location	Description
# 0	USER1
# 1	USER2
# 2	USER3
# 3	USER4
> # 4	USER5

Operation : **Save** into Location **04**
Description : **USER5**
 ABCDEFGHIJKLMNOPQRSTUVWXYZ

FIGURE 4-8. SAVE [EXTERNAL]

Save **[External]** -----Use Shift Curs. ←→ to get Char.

Disc type : 9121 Bus address : 07
LIF volume : L8118A Disc unit : 0

<u>File Name</u>	<u>File Description</u>
------------------	-------------------------

>USER1	USER SETTING
USER2	USER SETTING
USER3	USER SETTING
USER4	USER SETTING

File	
Operation :	[Save]
Name :	[USER1]
Description :	[USER SETTING] ABCDEFGHIJKLMN OPQRSTUVWXYZ

FIGURE 4-9. CONTROL (PATTERN)

Control (PATTERN)-----

Trigger

State : OFF ON

Mode : Normal Pattern

Start on High Low Edge

Control

State : OFF ON

Mode : Delay Auto

Threshold : 0 25.5V

External Clock

State : OFF ON

Clock Source is internal.

Cycling

Mode : Manual Auto

FIGURE 4-10. TIMING (PATTERN)

Timing (PATTERN)

Period : 1.00 [ms]

Channel 1

Delay	:	75.0	[ns]
Width	:	100.	[us]
Transition	:	[Linear]	
Leading	:	10.0	[ns]
Trailing	:	10.0	[ns]

Channel 2

Delay	:	75.0	[ns]
Width	:	100.	[us]
Transition	:	[Fixed]	
Leading	:	5.5	ns
Trailing	:	5.5	ns

Strobe

Delay	:	75.0	[ns]
Width	:	100.	[us]

FIGURE 4-11. OUTPUT (PATTERN)

Output (PATTERN) -----

Channel 1

State : OFF

Polarity : Normal

Addition : OFF

High Level : 1.20V

Low Level : 0.20V

Limit : OFF

Data Format : RZ

Channel 2

State : OFF

Polarity : Normal

Amplitude : 2.00V

Offset : 0.50V

Limit : OFF

Data Format : RZ

Strobe

Mode : Bit

CHAPTER 5

DATA PATTERN

CONTENTS

Introduction	5-3
Data Pattern	5-3
Updating	5-4
Frame	5-4
Data Entry Field	5-5
Editing	5-5
Break	5-5
Strobe	5-6
Base	5-6

FIGURE

1. Instrument Setting and Hardware	5-3
------------------------------------	-----

INTRODUCTION

This chapter defines several principles involved in operating with data patterns. Data editing is described in Chapters 9 and 10.

DATA PATTERN

The data pattern is part of the instrument's setting as shown in the following diagram.

Note that the data pattern in the setting is not immediately (automatically) transferred to the hardware.

The update function (UPDATE key or :SYST:UPD command) is required to transfer pattern data from the setting to the hardware. This permits editing of the setting pattern while the instrument is cycling the pattern contained in the hardware.

FIGURE 5-1. INSTRUMENT SETTING AND HARDWARE

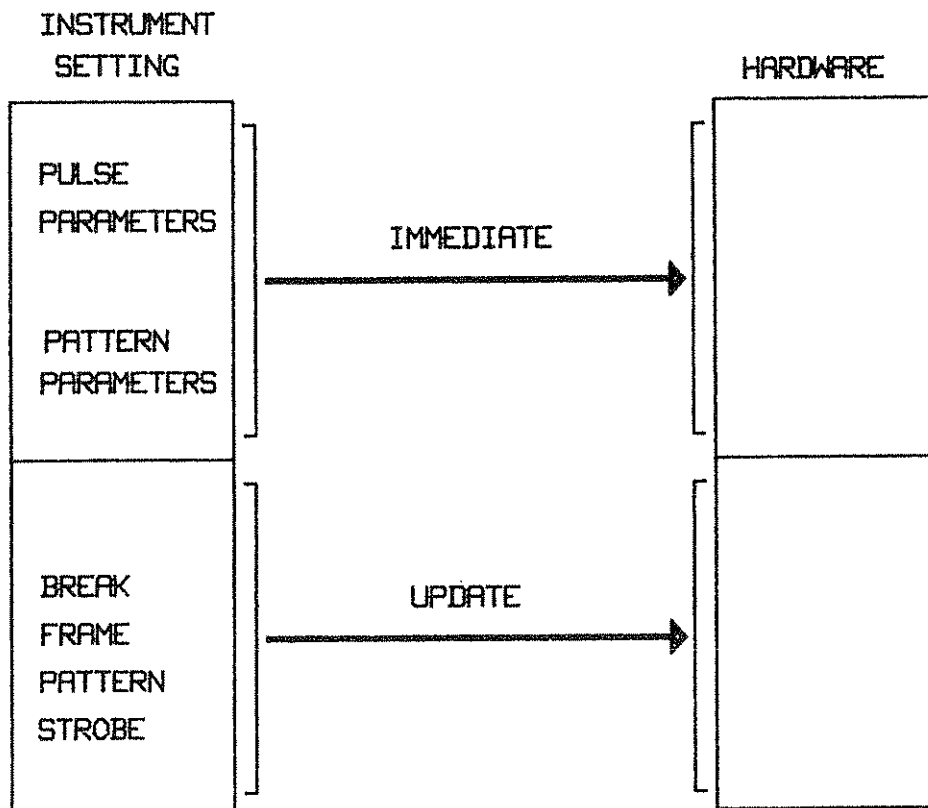

UPDATING

The following changes are made to the instrument's setting but require updating, (UPDATE key or the :SYST:UPD command) to transfer them to the hardware.

1. Frame specification
2. Break mode specification
3. Direct data entry at the data entry field
4. Editing, see EDITING in this chapter,
5. Strobe mode (output display)

Updating is performed when the instrument is in the stopped state (not running/cycling).

Pulse and pattern parameters update the hardware immediately.

FRAME

A frame defines the type and size of the pattern. The specifications apply to channels 1 and 2. That is, the frames are of identical size and type.

There are two types of frames.

1. Bit frame: the number of bits/frame is programmable.
2. Word frame: the number of bits/word and the number of words/frame are programmable.

The number of bits/frame (bit frame) and the number of bits/word (word frame) are not coupled.

The data in the setting remains unchanged from its last state when a new frame is specified. Thus, a newly defined frame contains undefined data from prior patterns which must be edited to the required pattern.

If less than the total 16 kbits of memory is used for a frame, the data outside the frame is ignored unless it is required by the insert editing operations.

DATA ENTRY FIELD

Pattern data can be directly entered into the setting at the data entry field.

EDITING

Pattern data is edited at the data entry display with the insert, delete, copy, move, and modify edit operations (INSERT, DELETE, COPY, MOVE, and MODIFY keys).

NOTE: Save operations save the state contained in the instrument setting not the hardware. Therefore, save a setting before editing it.

All edit operations are executed with the EXEC key.

The edit operations change the instrument's setting, but updating (UPDATE key) is required to transfer the edited data to the hardware.

Edit operations can be canceled with the abort function (ABORT key).

BREAK

One break point can be selected at which pattern cycling is halted. The specifications apply to channels 1 and 2. After the break occurs, the break mode automatically switches off.

The pattern can then be:

1. Single-stepped (from the break point)
2. Continued (cycling begins from the break point)
3. Restarted (cycling begins from the first bit of the pattern).

In word patterns, the break bit and the break word are specified. In bit patterns, the break bit is specified. The word and bit pattern break bits are not coupled.

STROBE

A strobe output which is common to both channels is available. It can be referenced to

1. A bit
2. A word (the first bit of the word)
3. The start of a frame (the first bit)
4. The end of a frame (the last bit).

BASE

For convenience, data can be displayed and modified in one of three bases: Binary, Octal, or Hexadecimal.

Binary data is arranged from left to right, (most significant bit to least significant bit) to create the octal or hexadecimal representations. However, note the bit assignment in the example below when an insufficient number of bits are available to create a complete octal representation.

For example, if the word is eight (8) bits, the octal representation is 3 digits where the least significant octal digit is based on two bits instead of three bits.

Binary = 1 1 0 0 1 1 0 1
Octal = 110 011 01 = 631

NOTE: The missing digit is assigned a value of zero.

An exclamation mark (!) is displayed at the data entry display to indicate that bits are missing from the octal representation. A similar logic applies to incomplete hexadecimal representations.

CHAPTER 6

REMOTE MESSAGES

CONTENTS

Introduction	6-3
Message Types	6-3
Coupled Commands	6-3
Short Form/Long Form	6-3
Legal Commands	6-3
Program Message Syntax	6-4
Response Message Syntax	6-5
Conventions	6-6

FIGURE

Command Hierarchy (tree)	6-7
--------------------------	-----

INTRODUCTION

Message types, commands, and syntax are described in this chapter.

MESSAGE TYPES

Two types of messages are used.

1. Program messages which are sent from a remote controller to the HP 8118A.
2. Response messages which are sent from the HP 8118A to the controller.

COUPLED

Coupled commands or functions influence each other; for example, see the following equations.

The following commands are coupled.

:PULS:LEV:HIGH, :PUL:LEV:LOW,
:PULS:LEV:AMPL, and :PULS:LEV:OFFS

$$\text{High Level} = \text{Offset} + (\text{Amplitude}/2)$$
$$\text{Low Level} = \text{Offset} - (\text{Amplitude}/2)$$
$$\text{Amplitude} = (\text{High level}) - (\text{Low level})$$
$$\text{Offset} = (\text{High level}) + (\text{Low level}) / 2.$$

In the pattern generator the trigger(external input) threshold and the external clock threshold are coupled. However, both are set by a single command.

SHORT FORM LONG FORM

The instrument will accept the short and long forms of the commands in upper and lower case.

LEGAL COMMANDS

Each generator has a unique set of legal commands. In the device commands table, Chapter 12, an 'x' indicates in which generator configuration the command is legal.

PROGRAM MESSAGE SYNTAX

Program messages = <ASCII-string><pmt>:

1. <ASCII-string> is one or more program message units.

Message units are separated by a program message unit separator (<pmus> = ;).

Each path in the syntax diagrams of Chapters 11 and 12 represent a complete program message unit

2. <pmt> = program message terminator

There are three possible <pmt>:

1. <lf>
2. <^END>
- 3' <lf><^END>

'^' indicates that the 'end' message is asserted at the last byte of the program message.

NOTE: <lf> is equivalent to NL.

PROGRAM MESSAGE EXAMPLE

```
OUTPUT 718;  "*"RST;  
             :SYSTEM:GENERATOR PATTERN;  
             :DATA:MODE BIT;  
             BREAK ON;  
             BREAK:ADDRESS 25;  
             :DATA:UPDATE"
```

RESPONSE MESSAGE SYNTAX

Response messages = <ASCII-string><rmt>

1. <ASCII-string> is one or more response message units.

The message units are defined in Chapters 11 and 12.

2. <rmt> = response message terminator

<lf><^END> is the only <rmt> used by the instrument. '^' indicates that the 'END' message is asserted at the last byte of the response message.

NOTE: <lf> is equivalent to NL.

Responses return values only; the base units are implied.

The local message "Response can be Read" indicates that the output queue contains a query response.

A query response must be read before the next program message is parsed or the message is deleted from the output queue.

See Chapters 11 and 12 for examples of response messages.

SYNTAX DIAGRAM CONVENTIONS

Non-terminals, substitute the required characters:
wsp, value, unit, data, mnemonic.

Terminals, all terms not defined as non-terminals are terminals and are input as given. Short and long forms of the commands are allowed.

The instrument accepts character strings in upper and/or lower case equally.

MIN = minimum.

1. MIN in a program message unit sets up the minimum setting allowed for that parameter.
2. MIN in a query message unit returns the minimum value allowed for that parameter.

MAX = maximum.

The action is the same as for MIN except that maximum values are used.

value = integer (12), decimal (85.5)
exponential format (99.9E-9)
(E-12, E-9, E-6, or E-3 are allowed.)

unit bypass and base units:

S (seconds)

V (volts)

units = ps/PS, ns/NS, us/US, ms/MS, s/S
uv/UV, mv/MV, v/V

channel bypass is explained in the diagrams.

NL = ASCII <lf>.

| = either/or

<...> = non-terminal

[...] = optional

white space, wsp = ASCII control characters and the space but excludes the newline.

FIGURE 6-1. COMMAND HIERARCHY (tree)

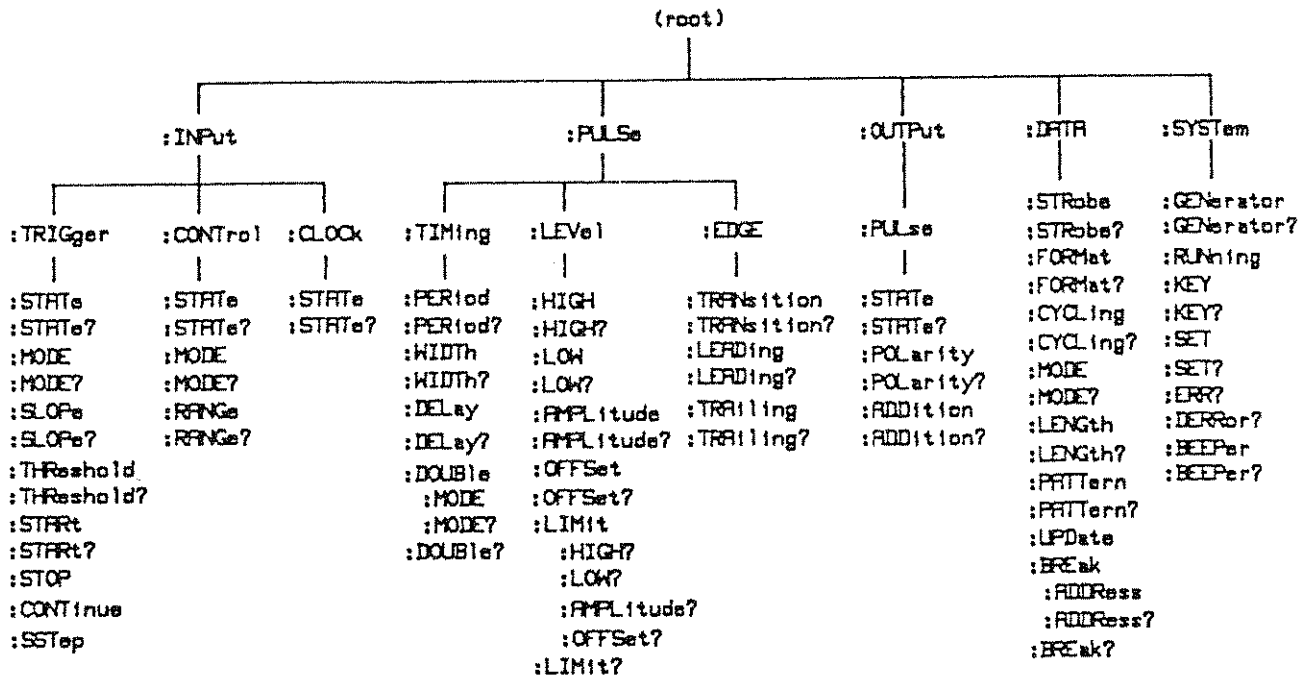

CHAPTER 7

OPERATING STATE

CONTENTS

	Introduction	7-3
	Power-on	7-3
	Parser Operation	7-3
	Error types	7-4
	Local Messages	7-5
	Remote Messages	7-5
	Polling	7-6
	Status Byte	7-7
	Status Byte Register (STB)	7-8
	Service Request Enable Register (SRE)	7-9
	Standard Event Status Register (ESR)	7-10
	Standard Events Status Enable Register (ESE)	7-11
	Input Buffer	7-12
	Output Queue	7-12
	Error Queue	7-12
	Key Queue	7-12
	Register bit assignment	7-13
	Synchronization	7-13
FIGURE	Status Reporting	7-14

INTRODUCTION

Power-on, parser operation, and status data structures are described in this chapter.

POWER-ON

At power-on, the instrument:

1. Initializes itself:
 - a. The input buffer is cleared.
 - b. The output queue is cleared.
 - c. The key queue is cleared.
 - d. STB, SRE, ESR, ESE and the error queue are cleared.
 - e. The parser is reset.
 - f. The execution Control is reset.
 - g. The response formatter is reset.
2. Enters the IDLE state awaiting a command.
3. The setting at power-off is restored as the current setting; however, outputs 1/2 are disabled.

PARSER OPERATION

Normally, the instrument removes all DABs , END, and GET bytes from the interface. Then it parses the bytes in the input buffer.

The exception is when the input buffer is full, and additional bytes remain to be input. In this case, the parser removes one byte from the input buffer and parses it. Then a byte is removed from the interface. If additional bytes remain to be input, the process of parsing one byte and inputting one byte continues until all bytes are input. Then the entire input buffer is parsed.

ERROR TYPES

There are four categories of instrument errors. All errors are listed in Appendix F.

1. Power-on Test errors identify power-on test failures. See Appendix F, Table F-1 for the extent of the test.
2. Self-test (*TST?) errors identify parametric failures. The test is identical to the parametric tests performed at power-on. See Appendix F, Table F-1.
3. Command, execution, device dependent, and query error events are reported in the standard event status register (ESR). These errors can be read in response to the :SYST:ERR? query. See Appendix F, Table F-2.
4. Device dependent error conditions are reported in bits 2-0 of the status byte register. These errors can be read in response to the :SYST:DERR? query. See Appendix F, Table F-3.

LOCAL MESSAGES

Power-on error messages are displayed immediately after the power-on tests are completed.

See Appendix F, Table F-1 for a list of messages.

Other error/warning messages are reported in the top message line of the display.

There are two types:

1. Temporary messages which are deleted after 2-3 seconds or when the next key is pressed. These messages indicate attempted actions which are not allowed, for example, an attempt to update the hardware while the pattern generator is running.
2. Permanent messages which remain until a condition in the instrument is corrected, for example, if two conflicting modes are enabled, one mode must be disabled or changed before the message is deleted and operation can continue.

REMOTE MESSAGES

Remote error/warning messages can be read in response to the following queries:

1. *TST? (See Appendix F, Table F-1)
2. :ERR? (See Appendix F, Table F-2)
3. :DERR? (See Appendix F, Table F-3)

POLLING

The instrument's interface talker subset is T6. Thus, the serial poll method of requesting service is used.

Bit 1 Behavior

In the following discussion, the only status byte bit enabled in the status byte register is Bit 1. The only error condition is related to the external clock frequency.

Bit 1 of the status byte register:

1. Is updated once every second. If Bit 1 is set (1), a service request is generated if a service request is not pending.

For example, if the external clock frequency is out of range and remains out of range, Bit 1 is set and remains set. Thus, each time Bit 1 is updated, a service request is generated if the prior service request has been serviced (polled).

2. Reports only the conditions present at the time of updating.

The controller must poll the instrument in less than one second from the time service is requested to insure that Bit 1's state reflects the condition that caused the service request.

For example, if an out of range external clock frequency causes a service request but the frequency is corrected before the next updating, Bit 1 is cleared at the updating.

If the controller polls the instrument before the updating, as it should, it will read Bit 1 = 1. But if the controller polls the instrument after the updating, it will read Bit 1 = 0.

In both examples, the :SYST:DERR? query provides detailed information regarding the error.

STATUS BYTE

The status byte is transmitted in bits 7 and 5-0 of the status byte register.

Bits 2-0 have the following behavior:

- Bit 2:** Bit 2 is a software-error summary-condition-bit. It reports state and mode conflicts (errors) detected by the software. It is updated after a program message terminator is parsed.
- Bit 1:** Bit 1 is a hardware-error-and-warning summary-condition-bit. It reports conditions not allowed by the hardware(errors) or states and modes which are not totally under control of the hardware(warnings). It is:
1. Updated once every second
 2. Reports only the conditions present at the time of the update.
- NOTE: See POLLING.
- Bit 0:** Bit 0 is a software-warning summary-condition-bit. It reports conditions allowed by the hardware but which require special attention. It is updated after a program message terminator is parsed.

The errors related to bits 2-0 are reported in response to a :DERR? query:

Bit 2 = Error numbers 100-199

Bit 1 = Error numbers 200-299

Bit 0 = Error numbers 300-399

See Appendix F, Table F-3 for a listing of the :SYST:DERR? query errors.

STB

STATUS BYTE REGISTER

The status byte register (STB) is described in the following figure.

The Master Summary Status (MSS) message is true when any enabled bit of the STB register is set excluding Bit 6.

[BIT 7] [BIT 6] [BIT 5] [BIT 4] [BIT 3] [BIT 2] [BIT 1] [BIT 0]

- Bit 7: Not used, value = 0
- Bit 6: RQS / MSS (Request Service / Master Summary Status)
- Bit 5: ESB (Event Status Bit)
- Bit 4: MAV (Message Available)
- Bit 3: Not used, value = 0
- Bit 2: S (Software-error summary-condition-bit)
- Bit 1: H (Hardware-error-and-warning summary-condition-bit)
- Bit 0: W (Software-warning summary-condition-bit)

READING THE STB REGISTER

After reading the status byte register with:

1. An *STB? query:
 - a. The status byte, RQS message, and the master summary message, MSS, are not directly altered as a result of the query.
 - b. MSS is reported in bit six of the status byte register.

NOTE: MSS can be indirectly altered by the query when MAV is enabled.

2. A serial poll:
 - a. The request for service, RQS, message is cleared; the status byte and the MSS message are not altered as a result of the query.
 - b. RQS is reported in bit six of the status byte register.

SRE

SERVICE REQUEST ENABLE REGISTER

The service request enable register (SRE) allows enabling of status byte register (STB) bits. See Chapter 11, *SRE command.

Bit six of the status byte register cannot be disabled. Thus, the bit value of sixty-four, if transmitted in an *SRE message, will be ignored.

The register is masked with the *SRE command and cleared with an *SRE 0' message.

[BIT 7] [BIT 6] [BIT 5] [BIT 4] [BIT 3] [BIT 2] [BIT 1] [BIT 0]

- Bit 7:** Not used, value = 0
- Bit 6:** Not used, value = 0
- Bit 5:** ESB (Event Status Byte)
- Bit 4:** MAV (Message Available)
- Bit 3:** Not used, value = 0
- Bit 2:** S (Software-error summary-condition-bit)
- Bit 1:** H (Hardware-error-and-warning summary-condition-bit)
- Bit 0:** W (Software-warning summary-condition-bit)

READING THE SRE REGISTER

The service request enable register (SRE) is non-destructively read with the *SRE? query.

ESR

STANDARD EVENT STATUS REGISTER

The standard event status register (ESR) is described in the following figure.

[BIT 7] [BIT 6] [BIT 5] [BIT 4] [BIT 3] [BIT 2] [BIT 1] [BIT 0]

- Bit 7: PON, Power-on
- Bit 6: Not used, value = 0
- Bit 5: CME, Command Error
- Bit 4: EXE, Execution Error
- Bit 3: DDE, Device Dependent Error
- Bit 2: QYE, Query Error
- Bit 1: Not used, value = 0
- Bit 0: OPC, Operation Complete

READING THE STANDARD EVENTS STATUS REGISTER

The standard events status register is read with the *ESR? query.

The register is cleared after being read.

Additional CME, EXE, DDE, and QYE status is obtained with the :SYST:ERR? query. See Chapters 12 and Appendix F, Table F-2.

ESE

STANDARD EVENT STATUS ENABLE REGISTER

The standard events status enable register(ESE) described in the following figure, enables bits of the standard events status register, ESR.

The register is masked with the *ESE command and cleared with an *ESE 0' message.

[BIT 7] [BIT 6] [BIT 5] [BIT 4] [BIT 3] [BIT 2] [BIT 1] [BIT 0]

Bit 7: PON, Power-on
Bit 6: Not used, value = 0
Bit 5: CME, Command Error
Bit 4: EXE, Execution error
Bit 3: DDE, Device Dependent Error
Bit 2: QYE, Query Error
Bit 1: Not used, value = 0
Bit 0: OPC, Operation Complete

READING THE ESE REGISTER

The standard event status enable (ESE) register is non-destructively read with the *ESE? query.

INPUT BUFFER

The input buffer is:

1. FIFO buffer (first-in first-out)
2. 100 bytes long.

OUTPUT QUEUE

The output queue is:

1. FIFO queue (first-in first-out)
2. 40 response messages long

The message available, MAV, message is reported in bit four of the status byte when the output queue contains a message.

The output queue and the MAV message are cleared when a new program message is received directly after a program message terminator.

ERROR QUEUE

The error queue is a:

1. FIFO queue (first-in first-out)
2. 10 errors long

If the queue overflows, message '-350 <too many errors>' overlays the last message in the queue.

KEY QUEUE

The key queue records real key presses, not :SYST:KEY simulated key presses.

The key queue is a:

1. FIFO queue (first-in first-out)
2. 15 keys long
3. The queue is cleared when the last key press is read.

If the queue is empty, message '??' is returned in response to the :SYST:KEY? query.

**REGISTER
BIT
ASSIGNMENT**

BIT	WEIGHT	SIGNIFICANCE	INTERFACE ASSIGNMENT
[BIT 7]	128	Most (MSB)	DIO8
[BIT 6]	64		DIO7
[BIT 5]	32		DIO6
[BIT 4]	16		DIO5
[BIT 3]	8		DIO4
[BIT 2]	4		DIO3
[BIT 1]	2		DIO2
[BIT 0]	1	Least (LSB)	DIO1

NOTE: Unused register bits have a value of zero or are ignored.

SYNCHRONIZATION

All commands are sequential commands.

If *OPC or *OPC? is parsed, a delay of two seconds occurs before the OPC bit is set or an ASCII coded 'I' is placed in the output queue.
See Chapter 11.

If *WAI is parsed, a delay of two seconds occurs before executing any other commands.
See Chapter 11.

At the end of two seconds, all operations are complete.

FIGURE 7-1. STATUS REPORTING

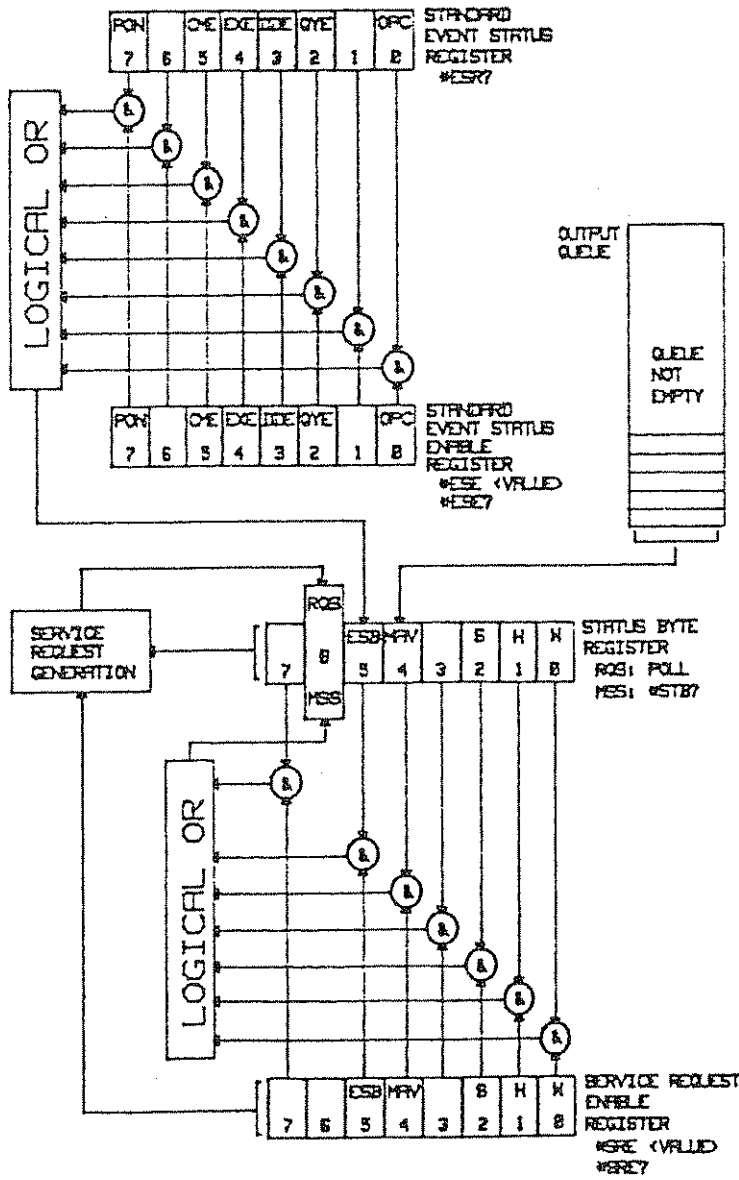

CHAPTER 8

DISPLAY FUNCTIONS

CONTENTS

ADDITION	HP-IB (interface)
AMPLITUDE	interface address
BASE (pattern data)	controller/controlled
BEEPER	LEADING EDGE
BREAK (break point)	LIMIT
CONFIGURATION	LOW LEVEL
pulse generator	OFFSET
pattern generator	PERIOD
CONTROL (control input)	POLARITY
Delay	normal
Delay/Double	complement
Width	PRINTER
Period	PURGE
High Level	RECALL
CURSOR ON	RESET
CYCLING	SAVE
auto	STATE (output 1/2)
singel	STROBE
DATA ENTRY FIELD	timing
DATA FORMAT	mode
RZ, NRZ, DNRZ	THRESHOLD
DELAY	(external input/clock)
DISC	TRAILING EDGE
DISPLAY (pattern data)	TRANSITION
DOUBLE PULSE	linear
EXTERNAL CLOCK	gaussian
FORMAT (disc)	fixed
FRAME	TRIGGER (external input)
mode: bit, word	auto
size	trigger
HIGH LEVEL	gate
	WIDTH

TABLES

- 1 Period, Delay, Double, and Width Ranges
- 2 Edge Ranges
- 3 Data Format and Timing Compatibility
- 4 Control Mode Compatibility

FIGURES

- 1 Control Input
- 2 Edge Ranges

ADDITION

GENERATOR: PULSE AND PATTERN

DISPLAY

LABEL

FIELD

OUTPUT

Addition:

[Off], default state

Addition is disabled.

Channels (outputs) 1/2 are output separately.

[On]

Addition is enabled.

Channels (outputs) 1/2 are added together and output at Output 1.

Observe the maximum level for channel 1 when adding channels 1 and 2.

If channel 2 output state = [On], it will change to [OFF] when addition is enabled.

Conflict: Addition and control mode 'high level' are incompatible.

Device command:

:OUTP:PULS:ADD ON|OFF|1|0

Channel 1

State	:	[OFF]
Polarity	:	[Normal]
Addition	:	[OFF]
High Level	:	[0.20V]
Low Level	:	[0.20V]
Limit	:	[OFF]
Data Format	:	[RZ-1]

AMPLITUDE

GENERATOR: PULSE AND PATTERN

DISPLAY

LABEL

FIELD

OUTPUT

[Amplitude]:
[High Level]

0.08 V <= Amplitude <= 16.40 V
See HIGH LEVEL.

Resolution = 0.01 V
Default value = 1.00 V

Amplitude = High Level - Low Level

Amplitude, offset, and the levels
are coupled.

The limits are given in the HELP
message.

```
Channel 1
State      : OFF
Polarity   : Normal
Addition   : OFF
Amplitude  : 2.1 2.2V
Offset     : 0.1 0.500V
Limit      : OFF
Data Format : RZ
```

```
Channel 1
State      : OFF
Polarity   : Normal
Addition   : OFF
High Level : max. 8 Volt
Low Level  : 0.1 2.100V
Limit      : OFF
Data Format : RZ
```

If control mode 'high level' is
enabled, High Level: max. 8 Volt is
displayed.

Device command:
:PULS:LEV:AMPL <value>|MIN|MAX

BASE

GENERATOR: PATTERN

DISPLAY

LABEL

FIELD

DATA ENTRY

Base:

[Bin], default
Digits are binary digits.

[Oct]
Digits are octal digits.

[Hex]
Digits are hexadecimal digits.

See Chapter 5, BASE, for additional information.

Execution: It is not possible to change the base while the editor is active. ABORT if necessary.

Device command: none

```
Data Enter -----  
Display Both Channels Base: [Bin] Cursor on Word : 7  
Words : 2048 Cursor on Digit: 2  
Digits: 8  
----- Channel 1 ----- Channel 2 -----  
Word Digit → 0 ↓ 00000000 00000000  
↓ 0 00000000 00000000  
1
```

BEEPER

GENERATOR: PULSE AND PATTERN

DISPLAY

LABEL

FIELD

PERIPHERALS

State:

[Off], default state
The beeper is disabled.

Beeper	
State	: [On]

[On]
The beeper is enabled.

An audible tone occurs when a disallowed action is attempted.

Device command:
:SYST:BEEP ON|OFF|1|0

BREAK

GENERATOR: PATTERN

DISPLAY

LABEL

FIELD

DATA FORMAT

Mode:

[Off], default mode

The break function is disabled.

Break	
Mode	: OFF

[On]

The break function is enabled, and is common to channels 1 and 2.

After the break occurs the break function automatically changes to the [Off] mode.

Execution: Updating is required to change the hardware.

Device command:

:DATA:BRE:MODE ON|OFF|1|0

DATA FORMAT

Break-Bit:

Break-Word:

FRAME MODE = WORD

0 <= value 1 <= (Word Length-1)

0 <= value 2 <= (No. of Words-1)

Break	
Mode	: ON
Break-Bit	: 7
Break-Word	: 2047

Defaults: Break-Bit = 7

Break-Word = 2047

Values 1(word mode) and 3 (bit mode) are not coupled.

Execution: Updating is required to change the hardware.

Device command:

:DATA:BRE <value 1>,<value 2>

BREAK

GENERATOR: PATTERN

DISPLAY

LABEL

FIELD

DATA FORMAT

Break-bit:

FRAME MODE = BIT

0 =< value 3 =< (No. of Bits-1)

Default: = 16383

Values 3 (bit mode) and 1 (word mode) are not coupled.

Execution: UPDATE is required to update the current setting.

Device command: :DATA:BRE <value 3>

Break	
Mode	: 000001
Break-Bit	: 16383

CONFIGURATION

GENERATOR: PULSE AND PATTERN

DISPLAY

LABEL

FIELD

CONFIGURATION 'Pulse Generator', default
'Pattern Generator'

A ROLL key is used to select the required instrument configuration.

The active configuration appears in inverse video on the display.

While in the pattern configuration and with the instrument running, the configuration can be changed without stopping the instrument. The generator automatically stops and must be restarted if pattern cycling is again required.

Device command: :SYST:GEN PULS|PATT

System **Configuration** _____ROLL to Change Configuration_____

Pulse Generator (PULSE)
Pattern Generator (PATTERN)

CONTROL (input)

GENERATOR: PULSE AND PATTERN

DISPLAY

LABEL

FIELD

CONTROL

State:

[Off], default

The control function is disabled.

[On]

The control function is enabled.

Device command:

:INP:CONT:STATE ON|OFF|1|0

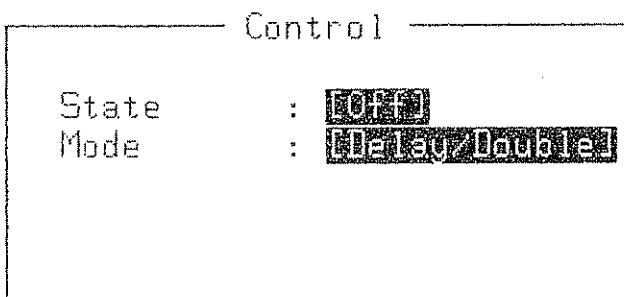

CONTROL

Mode:

[High Level]

The high levels of channels 1 and 2 are controlled by an external voltage. The output voltage equals the input voltage.

CAUTION: The limit function is not active when control mode 'high level' is enabled even though the state = On.

Control voltage: -8.0V to 8.0V

Output voltage: -8.0V to 8.0V

Conflict: Control mode 'high level' and output 'addition' are incompatible.

Device command: :INP:CONT:MODE HLEV

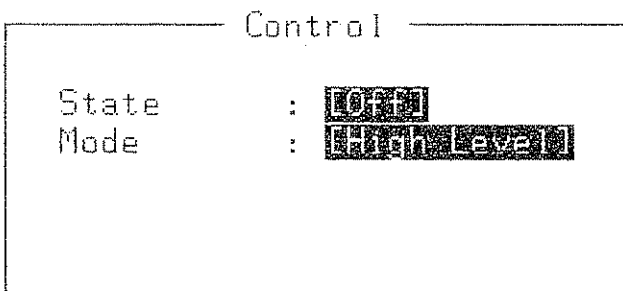

CONTROL (input)

GENERATOR: PULSE AND PATTERN

DISPLAY

LABEL

FIELD

CONTROL

Mode:
(contd.)

**[Delay/Double]: pulse generator,
default mode**

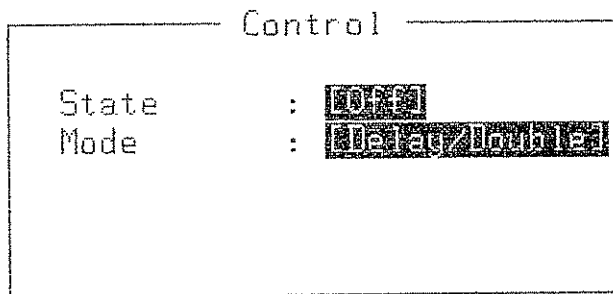

The pulse delay or double pulse delay of channels 1 and 2 are controlled by an external voltage.

Control voltage: 1.0V to 10.0V

A range specification is required at the timing display.

Pulse delay or double pulse delay is selected at the timing display.

Device command: :INP:CONT:MODE DEL

CONTROL

Mode:
(contd.)

**[Delay]: pattern generator,
default mode**

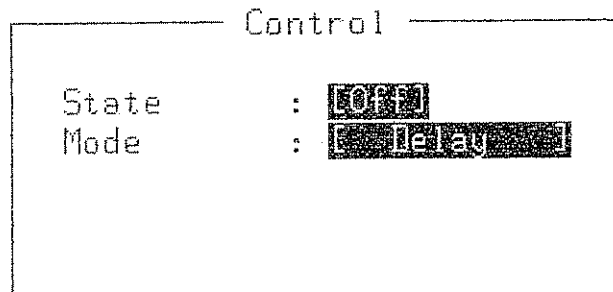

The delays of channels 1 and 2 are controlled by an external voltage.

Control voltage: 1.0V to 10.0V

Conflict: Control mode 'delay' and data format NRZ are incompatible.

A range specification is required at the timing display.

Device command: :INP:CONT:MODE DEL

CONTROL (input)

GENERATOR: PULSE AND PATTERN

DISPLAY

LABEL

FIELD

CONTROL

Mode:
(contd.)

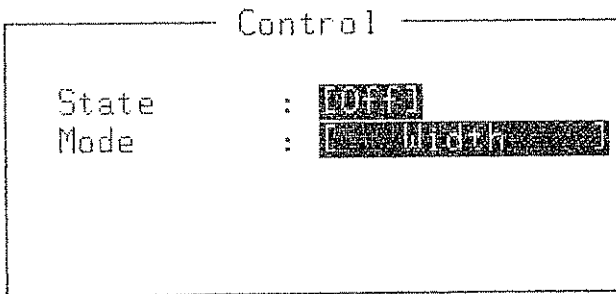

CONTROL

Mode:
(contd.)

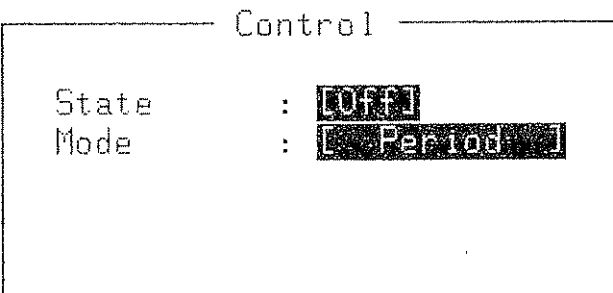

[Width]

The widths of channels 1 and 2 are controlled by an external voltage.

Control voltage: 1.0V to 10.0V

A range specification is required at the timing display.

Conflict: Control mode 'width' and data formats NRZ and DNRZ are incompatible (pattern generator).

Device command: :INP:CONT:MODE WIDT

[Period]

The periods of channels 1, 2, and 3 (strobe) are controlled by an external voltage.

Control voltage: 1.0V to 10.0V

A range specification is required at the timing display.

Conflict: control mode 'period' is incompatible with:

1. External clock (pattern generator)
2. Trigger mode 'trigger'.

Device command: :INP:CONT:MODE PER

CURSOR ON

GENERATOR: PATTERN

DISPLAY

LABEL

FIELD

DATA ENTRY

Cursor on Word:
Cursor on Digit:

If the cursor is not in the data entry field, the address defines the entry point for the cursor when it is moved into the data entry field (fast move mode).

If the cursor is moved about in the data entry field, the 'Cursor on ...' fields are updated with the current cursor address.

To change this reference location when editing:

1. Directly enter the location in the 'Cursor on ...' fields
2. Move the cursor about in the data entry field.
3. ROLL the data

Device command: none

```

Data [Entry] -----
Display [both Channels] Base: [Bin] Cursor on Word : [?]
Words : 2048 Cursor on Digit: [0]
Digits: 8
----- Channel 1 ----- Channel 2 -----
Word Digit → 0 0
↓ ↓
0 00000000 00000000
  
```

CYCLING

GENERATOR: PATTERN

DISPLAY

LABEL

FIELD

CONTROL
DATA FORMAT

Mode:

[Auto], default mode

Automatic: Upon receiving a START event, the pattern is repeatedly cycled until a STOP event occurs.

[Single]

Upon receiving a START event, the pattern cycles one time unless a STOP event occurs.

START events initialize the data vector. Thus, the pattern always starts at the first bit of the frame.

START events:

1. START key
2. CONTINUE key
3. :INP:TRIG:STAR IMM
4. :INP:TRIG:CONT
5. Trigger function: trigger or gate
6. *TRG

STOP events:

1. STOP key
2. :INP:TRIG:STOP
3. Trigger function: gate
4. :DATA:BRE

Device command:

:DATA:CYCL AUTO|SING

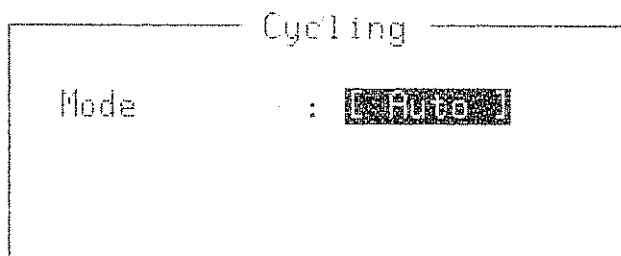

DATA ENTRY FIELD

GENERATOR: PATTERN

DISPLAY

LABEL

FIELD

Data Entry

Data entry field

Direct entry of data into the setting is allowed, for example, in the following figure at word 7.

Data Editing is performed at the data entry display. See Chapters 5, 9, and 10. for a description of editing.

Execution: Updating is required to update the hardware.

Device command: none

```

Data [Entry] -----
OUTPUT 1                                     UPDATE
Display [both Channels]   Base: [Bin]   Cursor on Word : [7]
Words : 2048              Cursor on Digit : [0]
Digits:      8

----- Channel 1 -----   ----- Channel 2 -----
Word   Digit →           0           0
↓           ↓           ↓           ↓
0       00000100         00000100
1       00000100         00000100
2       00000100         00000100
3       00000000         00000000
4       00000000         00000000
5       00000000         00000000
6       00000000         00000000
7+     00000000         00000000
8       00000000         00000000
9       00000000         00000000
    
```

DATA FORMAT

GENERATOR: PATTERN

DISPLAY

LABEL

FIELD

**DATA FORMAT
OUTPUT**

Data Format:

[RZ], return to zero, default
Max. ext. clock frequency=50 MHz.

[NRZ], non-return to zero
Max. ext. clock frequency=100 MHz.

The delay and width labels
for channels 1/2 and strobe are
deleted from the display.

Conflict: data format NRZ and
Control modes 'delay' and 'width'
are incompatible.

[DNRZ] delayed non-return to zero
Max. ext. clock frequency=50 MHz.

The width labels for channels 1/2
are deleted from the display.

Conflict: data format DNRZ and
control mode 'width' are
incompatible.

Execution: The generator must be
in the stopped state before
the data format can be changed.

Device Command:
:DATA:FORM RZ|NRZ|DNRZ

Data-Format	
Channel 1	: [RZ]
Channel 2	: [RZ]

DELAY

GENERATOR: PULSE AND PATTERN

DISPLAY

LABEL

FIELD

TIMING

[Delay]:
Delay:

Pulse Generator
Pattern Generator

74.0 ns <= Delay <= 999 ms

Resolution = LSD/See Table 8-1.
Default value = 75.0 ns

Delay programming and
data format NRZ are incompatible.
The delay label is not displayed.

Device command:

:PULS:TIM:DEL <value>|MIN|MAX

Channel 1

[Delay]	:	75.0	[ns]
Width	:	100.	[ns]
Transition	:	[Linear]	
Leading	:	10.0	[ns]
Trailing	:	10.0	[ns]

[Delay] Range:
Delay Range:

Pulse Generator
Pattern Generator

Ranges: See Table 8-1/Figure 8-1

Default range: 75.0 ns to 99.9 ns

The minimum delay (75.0 ns) occurs
at 7.5 V on Range 1.

If the control mode 'delay' is
enabled, the [Delay] Range label
replaces the [Delay] label and is
used to specify the delay range.

Device command:

:INP:CONT:RANG <value>|MIN|MAX

Channel 1

[Delay] Range	:	199.9 ns	
Width	:	100.	[ns]
Transition	:	[Linear]	
Leading	:	10.0	[ns]
Trailing	:	10.0	[ns]

DISC (drive)

GENERATOR: PULSE AND PATTERN

DISPLAY

LABEL

FIELD

Peripherals

Address:

```
      Disk
-----
Address : 7
Unit    : 020
```

0-7

Disc drive interface address:
A unique interface address is
required.

CLEAR ENTRY will clear address
conflicts by assigning the lowest
unused address.

At power-off, the address is saved
in RAM and is restored at power-on.
If the RAM data is invalid
at power-on, the address is set
to 0.

Unit:

```
      Disk
-----
Address : 7
Unit    : 020
```

[0], default [1]

Unit selects which drive is
selected in a disc drive.

If there is only one drive,
unit = 0.

A recommended disc drive is listed
in Appendix B.

Device command: none

DISPLAY

GENERATOR: PATTERN

DISPLAY

LABEL

FIELD

DATA ENTRY

Display:

[both Channels], default
[Channel 1]
[Channel 2]

If a frame size exceeds the data window (the amount of data displayed) the ROLL keys are used to move the non-displayed portions of the frame into the window.

Thus, word frames exceeding the window can be rolled right or left.

Bit and word frames can be rolled up and down.

Data [Entry]

Display [both Channels]

Base: [Bin]

Cursor on Word :

7

Words : 2048

Cursor on Digit:

2

Digits: 8

Word	Digit →	Channel 1	Channel 2
↓		↓	↓
0		00000000	00000000
1		00000000	00000000
2		00000000	00000000
3		00000000	00000000
4		00000000	00000000
5		00000000	00000000
6		00000000	00000000
7←		00000000	00000000

DOUBLE PULSE

GENERATOR: PULSE

DISPLAY

LABEL

FIELD

TIMING

[Double]:

18.0 ns <= Double Pulse <= 999 ms

Resolution = LSD/See Table 8-1.

Default value = 200 us

Double pulse is available only in the pulse generator.

Device command:

:PULS:TIM:DOUB <value>|MIN|MAX

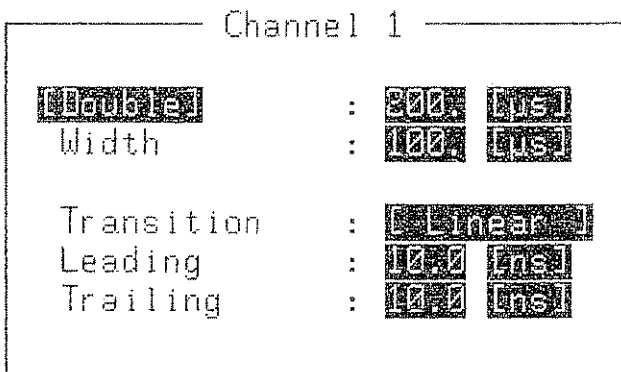

TIMING

[Double] Range:

Ranges: See Table 8-1/Figure 8-1

Default range: 20.0 ns to 99.9 ns

The minimum double pulse delay occurs at a control voltage of 2.0V.

If control mode 'delay/double' is active the [Double] Range label replaces the [Double] label and is used to specify the double pulse delay range.

Device command:

:INP:CONT:RANG <value>|MIN|MAX

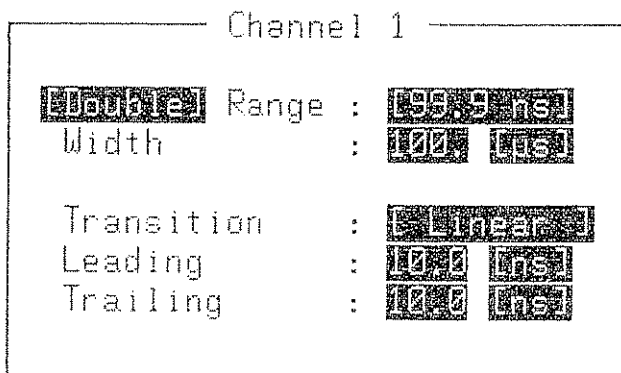

EXTERNAL CLOCK

GENERATOR: PATTERN

DISPLAY

LABEL

FIELD

CONTROL

State:

[Off], default state

The internal clock source is enabled.

```
External Clock
State      : [Off]
Clock Source is internal
```

[On]

The external clock source is enabled.

Maximum external clock frequency:

1. RZ = 50 MHz
2. NRZ = 100 MHz
3. DNRZ = 50 MHz

The input thresholds of the external clock and the trigger(external input) are coupled. See THRESHOLD.

Execution: The generator must be in the stopped state before the external clock state can be changed.

Conflict: The external clock and control mode 'period' are incompatible.

Device command:

:INP:CLOC:STAT ON|OFF

FORMAT (disc)

GENERATOR: PULSE AND PATTERN

DISPLAY

LABEL

FIELD

SAVE EXTERNAL

Operation:

[Format]

Formatting prepares a magnetic disc for data storage.

CAUTION: Formatting deletes all data.

The instrument must be a controller.

Execution: Press EXEC to activate the operation.

Device command: none

```
File _____  
Operation : [Format] the disc
```

FRAME (word mode)

GENERATOR: PATTERN

DISPLAY

LABEL

FIELD

DATA FORMAT

Mode:

[Word], default mode

A word pattern format is selected.
The mode is common to channels 1/2.

Word Length:

3 <= value 1 <= 256

Default: 8

Frame

Mode	:	Word
Word-Length	:	8 Bits
No. of Words	:	2048

Use the editor to change the word length to avoid introducing undefined data into a pattern.

Values 1(word mode) and 3(bit mode) are not coupled.

Execution: updating is required to change the hardware.

No. of Words:

1 <= value 2 <= 3640

Default: 2048

Frame

Mode	:	Word
Word-Length	:	8 Bits
No. of Words	:	2048

(Word Length)(No. of Words) <= 16834 bits

Number of bits/frame restrictions:

Word Length of 3 = 10920 bits

Word Length of 4 = 14560 bits

Execution: updating is required to change the hardware.

Device command:

:DATA:LENG <value 1>,<value 2>

FRAME (bit mode)

GENERATOR: PATTERN

DISPLAY

LABEL

FIELD

DATA FORMAT

Mode:
(Contd.)

[Bit]

A bit pattern format is selected.
The mode is common to channels 1/2.

No. of Bits

$3 \leq \text{value } 3 \leq 16384$
Default: 16384

Values 3(bit mode) and 1(word mode)
are not coupled.

Execution: updating is required
to change the hardware.

Device command:
:DATA:LENG <value 3>

	Break
Mode	: 1011
Break-Bit	: 111111

HIGH LEVEL

GENERATOR: PULSE AND PATTERN

DISPLAY

LABEL

FIELD

OUTPUT

[High Level]:
[Amplitude]

-8.12 V <= High Level <= 8.20 V
See AMPLITUDE.

Resolution = 0.01 V
Default level = 1.00 V

High Level = Offset + (Amplitude/2)

High level, low level, amplitude,
and offset are coupled.

The limits are given in the HELP
message.

```

Channel 1
State      : [OFF]
Polarity   : [Normal]
Addition   : [Off]

[High Level] : [+1] 1.00V
Low Level  : [+1] 2.00V
Limit      : [Off]

Data Format : [RZ]
    
```

```

Channel 1
State      : [OFF]
Polarity   : [Normal]
Addition   : [Off]

High Level : max. 8 Volt
Low Level  : [+1] 2.00V
Limit      : [Off]

Data Format : [RZ]
    
```

If control mode 'high level' is
active, the high level label
changes to
'High Level: Max. 8 Volt'
(Max. = maximum).

Device Command:
:PULS:LEV:HIGH <value>|MIN|MAX

HP-IB (interface)

GENERATOR: PULSE AND PATTERN

DISPLAY

LABEL

FIELD

PERIPHERALS

Address:

```
HP-IB
Address      : 18
HP 8118A is  [Controlled]
```

HP 8118A is

```
HP-IB
Address      : 18
HP 8118A is  [Controller]
```

0-30

Interface address: a unique interface address is required.

CLEAR ENTRY will clear address conflicts by assigning the lowest unused address.

At power-off, the address is saved in RAM and is restored at power-on. If the RAM data is invalid at power-on, the address is set to 18.

Device command: none.

[Controlled], default mode

As a device, the instrument can be controlled by a remote controller.

[Controller]

As a controller, the instrument can control a printer and a disc drive.

Address and mode changes are not allowed while the instrument is addressed or a service request is pending. First take the instrument to the listen idle state and/or serial poll the instrument.

Device Command: none

LEADING EDGE

GENERATOR: PULSE AND PATTERN

DISPLAY

LABEL

FIELD

TIMING

Leading:

05.5 ns <= Leading <= 99.9 ms

Resolution = LSD/See Table 8-2.
Default value = 10.0 ns
Fixed value = 5.5 ns (linear)

Channel 1	
Delay	: 75.0 [ns]
Width	: 100. [µs]
Transition	: [Linear]
Leading	: 10.0 [ns]
Trailing	: 10.0 [ns]

The leading and trailing edges must be programmed within a common range. See Table 8-2 and Figure 8-2 for edge information.

The pulse amplitude is reduced if the edge values are long (excessive) with respect to other timing values.

See VERNIER, Chapter 3, for a description of the vernier function, auto-ranging, and edges.

Device Command:

:PULS:EDGE:LEAD <value>|MIN|MAX

LIMIT

GENERATOR: PULSE AND PATTERN

DISPLAY

LABEL

FIELD

OUTPUT

Limit:

[Off], default

The limit function is disabled.

[On]

The limit function is enabled.

CAUTION: the limit function is not active if control mode 'high level' is enabled even though the state = Off.

NOTE: The levels, amplitude, and offset are coupled.

The high and low level limits are set as follows:

1. Disable the limit function if it is enabled.
2. Set the levels to the required limit value.
3. Enable the limit function.

The limit values are included in the limit and level HELP messages.

Device Command:

:PULS:LEV:LIM ON|OFF|1|0

Channel 1

State	:	[Off]
Polarity	:	[Normal]
Addition	:	[Off]
[High Level]	:	[1] [0.00V]
Low Level	:	[1] [0.00V]
Limit	:	[Off]
Data Format	:	[LRZ]

LOW LEVEL

GENERATOR: PULSE AND PATTERN

DISPLAY

LABEL

FIELDS

OUTPUT

Low Level:
Offset

-8.20 V <= Low Level <= 8.12 V
See OFFSET.

Resolution = 0.01 V
Default level = 0.00 V

Low Level = Offset - (Amplitude/2)

Low level, high level, amplitude,
and offset are coupled.

The limits are given in the HELP
message.

```
Channel 1
State      : [OFF]
Polarity   : [Normal]
Addition   : [OFF]

[High Level] : [+1] 1.20V
Low Level  : [+1] 0.00V
Limit      : [OFF]

Data Format : [RZ]
```

```
Channel 1
State      : [OFF]
Polarity   : [Normal]
Addition   : [OFF]

[Amplitude] : [1.20V]
Offset     : [+1] 0.500V
Limit      : [OFF]

Data Format : [RZ]
```

The low level label changes
to the offset label when
the amplitude function is
selected.

Device Command:
:PULS:LEV:LOW <value>|MIN|MAX

OFFSET

GENERATOR: PULSE AND PATTERN

DISPLAY

LABEL

FIELD

TIMING

Offset:
Low Level

-8.160 V <= value <= 8.160 V
See LOW LEVEL.

Resolution = 0.005 V
Default value = 0.500 V

Offset = High Level + Low Level / 2

Offset, amplitude, and the levels
are coupled.

When the amplitude function is
selected, the low level label
automatically changes to the offset
label.

The limits are given in the HELP
message.

Device Command:
:PULS:LEV:OFFS <value>|MIN|MAX

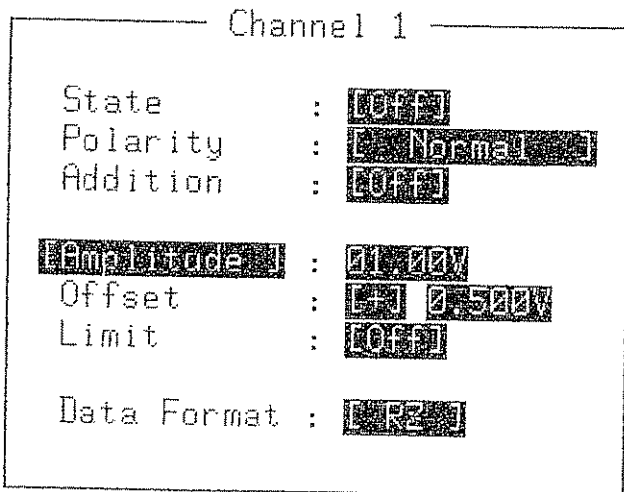

PERIOD

GENERATOR: PULSE AND PATTERN

DISPLAY

LABEL

FIELD

TIMING

Period:

Pulse: 18.0 ns <= Period <= 999 ms

Range: 20 ns <= Period <= 999 ms

Pattern: 9.0 ns <= Period <= 999 ms

Range RZ/DNRZ:

20.0 ns <= Period <= 999 ms

Range, NRZ:

10.0 ns <= Period <= 999 ms

Resolution = LSD/See Table 8-1.

Default = 1.00 ms

Period is common to channels 1/2/3.

Pattern generator: when the external clock is enabled, the period is controlled by the external clock. The period label is removed from the display.

Pulse generator: when trigger mode 'trigger' is enabled, the period is controlled by the external input trigger signal. The period label is removed from the display.

Pulse and patrn generator: when control mode 'period' is enabled, the period is controlled by an external voltage. The period label changes to period range (See the next page.)

Device Command:

:PULS:TIM:PER <value>|MIN|MAX

Timing (PULSE)-----

Period : 1.00 [ms]

Channel 1	
Delay	: 75.0 [ns]
Width	: 100. [ns]
Transition	: [Linear]
Leading	: 10.0 [ns]
Trailing	: 10.0 [ns]

PERIOD

GENERATOR: PULSE AND PATTERN

DISPLAY

LABEL

FIELD

TIMING

Period Range:

Ranges: See Table 8-1/Figure 8-1.

Timing (PULSE) -----

Period Range : 10.00 ns

Default range(Pulse, RZ, and DNRZ):
20.0 ns to 99.9 ns

The minimum pulse, RZ, or DNRZ
period (20.0 ns) occurs
at a control voltage of 2.0V
on Range 1.

Default range(NRZ):
10.0 ns to 99.9 ns

If control mode 'period' is active,
the period range label replaces
the period label and is used
to specify the period range.

Device Command:

:INP:CONT:RANG <value>|MIN|MAX

Channel 1

Default	:	20.0	ns
Width	:	10.0	ns
Transition	:	Linear	
Leading	:	12.0	ns
Trailing	:	12.0	ns

POLARITY

GENERATOR: PULSE AND PATTERN

DISPLAY

LABEL

FIELD

OUTPUT

Polarity:

[Normal], default polarity
Channels (outputs) 1/2 are output
as specified.

Channel 1

State	:	[OFF]
Polarity	:	[Normal]
Addition	:	[OFF]
[High Level]	:	[+] 1.20V
Low Level	:	[+] 0.20V
Limit	:	[OFF]
Data Format	:	[RZ]

[Complement]
Channels (outputs) 1/2 are
inverted.

Device Command:
:OUTP:PULS:POL NORM|COMP

PRINTER

GENERATOR: PULSE AND PATTERN

DISPLAY

LABEL

FIELD

PERIPHERALS

Address:

0-30

Printer interface address:
A unique address is required.

CLEAR ENTRY will clear address conflicts by assigning the lowest unused address.

At power-off, the address is saved in RAM and is restored at power-on. If the RAM data is invalid at power-on, the address is set to 5.

[None], default

A printer type is not declared.

[Graphics]

Display text appearing in inverse video is printed in an inverse format.

[Text]

The display text appearing in inverse video is printed in the normal manner and underlined.

Printing is described in Chapter 3

A recommended printer is listed in Appendix B.

Device Command: none

Printer

Address	:	01
Type	:	[Graphics]

Type:

Printer

Address	:	01
Type	:	[Graphics]

PURGE

GENERATOR: PULSE AND PATTERN

DISPLAY

LABEL

FIELD

SAVE EXTERNAL

Operation:

[Purge]

A specified file is deleted from a magnetic disc.

The instrument must be a controller.

Name:

File name

File names are built with the alpha-numeric keys and the display alphabet, for example, USER1 in the following figure. See Chapter 3, CURSOR keys.

Execution: Press EXEC to activate the operation.

Device Command: none

Operation :	[Purge]	File
Name :	[USER1]	
	[ABCDEFGHIJKLMN	OPQRSTUVWXYZ]

RECALL (external)

GENERATOR: PULSE AND PATTERN

DISPLAY

LABEL

FIELD

SAVE EXTERNAL

Operation:

[Recall], default operation

A setting stored on a magnetic disc is made the instrument setting.

The instrument must be a controller.

The hardware is automatically updated for all parameters that are part of the recalled setting.

Name:

File name

File names are built with the alpha-numeric keys and the display alphabet, for example, USER1 in the following figure. See Chapter 3, CURSOR keys.

Execution: Press EXEC to activate the operation.

Device Command: none

File

Operation : [Recall]

Name : USER1

BCDEFGHIJKLMNOPQRSTUVWXYZ

RECALL (internal)

GENERATOR: PULSE AND PATTERN

DISPLAY

LABEL

FIELD

SAVE INTERNAL

Operation:

[Recall], default

Location = 0-4

A setting stored in RAM is made the instrument setting.

The hardware is automatically updated for all parameters that are part of the recalled setting.

Execution: Press EXEC to activate the operation.

Common command: *RCL <location>

Related command: *SAV <location>

Operation : [Recall] from Location 04

RESET

GENERATOR: PULSE AND PATTERN

DISPLAY

LABEL

FIELD

SAVE INTERNAL

Operation:

[Reset]

A copy of the reset setting (standard setting) stored in ROM is made the instrument setting.

Updating is automatic for all parameters of the standard setting.

See Chapter 11, *RST, for a description of the standard setting.

Execution: Press EXEC to activate the operation.

Common Command: *RST

Operation : **[Reset]** to Standard Setting

SAVE (external)

GENERATOR: PULSE AND PATTERN

DISPLAY

LABEL

FIELD

SAVE EXTERNAL

Operation:

[Save]

The instrument setting is stored on a magnetic disc.
The instrument must be a controller.

Save before editing because a pattern cannot be retrieved from the hardware.

The scope of the generator's saved setting is identical to the scope of the standard setting (pattern commands do not apply to the pulse generator).

Name:
Description:

File name
Setting identification

File names and descriptions are built with the alpha-numeric keys and the display alphabet.
See Chapter 3, CURSOR keys.

Execution: Press EXEC to activate the operation.

Device command: none

File

Operation :	[SAVE]
Name :	USER
Description :	USER SETTING ABCDEFGHIJKLMN OPQRSTUVWXYZ

SAVE (internal)

GENERATOR: PULSE AND PATTERN

DISPLAY

LABEL

FIELD

SAVE INTERNAL

Operation:

[Save]

Location = 0-4

A copy of the instrument setting is stored in RAM.

Save before editing because a pattern cannot be retrieved from the hardware.

The scope of the generator's saved setting is identical to the scope of the standard setting (pattern commands do not apply to the pulse generator).

Description: Setting Identification

The description is built with the alpha-numeric keys and the display alphabet, for example, USER SETTING in the following figure. See Chapter 3, CURSOR keys.

Execution: Press EXEC to activate the operation.

Common command: *SAV <location>

Related command: *RCL <location>

Operation : [Save] into Location [0]
Description : [USER SETTING 5]

[ABCDEFGHIJKLMN OPQRSTUVWXYZ]

STATE (output)

GENERATOR: PULSE AND PATTERN

DISPLAY

LABEL

FIELD

OUTPUT

State:

[OFF], default state
Channels 1/2 are disabled.

Output (PATTERN) -----
OUTPUT 1

[On]
Channels 1/2 (Outputs 1/2) are
enabled.

Channel 1

State	:	[On]
Polarity	:	[Normal]
Addition	:	[OFF]
High Level	:	[+] 1.00V
Low Level	:	[+] 0.00V
Limit	:	[OFF]
Data Format	:	[RZ]

When enabled, the messages
'Output 1' and 'Output 2' appear
in the second message line.

Device Command:
:OUTP:PULS:STAT ON|OFF

STROBE TIMING

GENERATOR: PATTERN

DISPLAY

LABEL

FIELD

TIMING

Delay:

74.0 ns <= Delay <= 999 ms

Resolution = LSD/See Table 8-1.

Default value = 75.0 ns

Delay programming is not allowed with data format NRZ. The strobe delay label is deleted from the display if both channel 1 and 2 data formats = NRZ.

Device Command:

:PULS3:TIM:DEL <value>|MIN|MAX

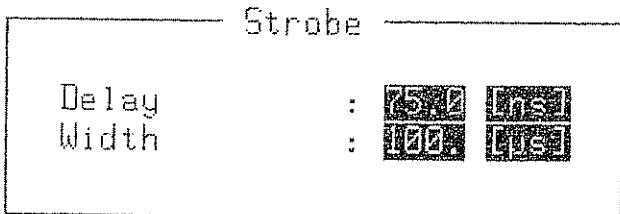

Width:

9.0 ns <= Width <= 999 ms

Resolution = LSD/See Table 8-1.

Default value = 100 us

Width programming is not allowed with data format NRZ. The strobe width label is deleted from the display if both channel 1 and 2 data formats = NRZ.

Device Command:

:PULS3:TIM:WIDT <value>|MIN|MAX

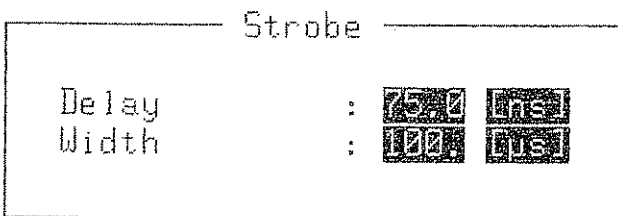

STROBE MODE

GENERATOR: PATTERN

DISPLAY

LABEL

FIELD

OUTPUT

Mode:

Strobe	
Mode	: [Bit]

[Bit], default mode

One strobe is output per bit.
Allowed in frame modes 'bit' and 'word'.

[Word]

One strobe is output per word
at the first bit of the word.
Allowed in frame mode 'word' only.

[Frame Start]

One strobe is output at the first
bit of the frame.
Allowed in frame modes 'bit' and
'word'.

[Frame End]

One strobe is output at the last
bit of the frame.
Allowed in frame modes 'bit' and
'word'.

Execution: updating is required
to change the hardware.

Device command:

:DATA:STR BIT|WORD|FST|FEND

THRESHOLD

GENERATOR: PULSE AND PATTERN

DISPLAY

LABEL

FIELD

CONTROL

Threshold:

-12.0 V <= threshold <= 12.0 V
Resolution = 0.1 V
Default threshold = 2.4 V

Pulse generator:
The trigger and gate thresholds are set.

```
Trigger
State      : OFF
Mode       : Trigger
Slope      :
Threshold  : 2.4 2.4V
```

```
Trigger
State      : OFF
Mode       : Trigger
Start on   : Edge
```

Pattern generator:
The threshold of the external clock and the trigger (external input) are coupled. Both are set to the value programmed by the threshold function.

Device Command:
:INP:TRIG:THR <value>|MIN|MAX

```
Threshold  : 2.4 2.4V
```

```
External Clock
State      : OFF
Clock Source is internal
```

TRAILING EDGE

GENERATOR: PULSE AND PATTERN

DISPLAY

LABEL

FIELD

TIMING

Trailing:

05.5 ns <= Trailing <= 99.9 ms

Resolution = LSD/See Table 8-2

Default value = 10.0 ns

Fixed value = 5.5 ns (linear)

Channel 1	
Delay	: 75.2 ns
Width	: 100.0 ns
Transition	: Linear
Leading	: 12.0 ns
Trailing	: 12.2 ns

The leading and trailing edges must be programmed within a common range. See Table 8-2 for the ranges.

The pulse amplitude is reduced if the edge values are long (excessive) with respect to other timing parameters.

See VERNIER, Chapter 3, for a description of the vernier function, auto-ranging, and edges.

Device Command:

:PULS:EDGE:TRA <value>|MIN|MAX

TRANSITION

GENERATOR: PULSE AND PATTERN

DISPLAY

LABEL

FIELD

OUTPUT

Transition:

[Linear], default transition

Linear edges: programmable.
See LEADING and TRAILING.

[Gaussian]

Cosinusoidal edges: programmable.
See LEADING and TRAILING.

[Fixed]

The leading and trailing edges
are fixed at 5.5 ns each (linear).

Device command:

:PULSE:EDGE:TRAN LIN|GAUS|FIX

Channel 1

[Delay]	:	[75.0]	[ns]
Width	:	[100.]	[ns]
Transition	:	[Linear]	
Leading	:	[10.0]	[ns]
Trailing	:	[10.0]	[ns]

Channel 1

[Delay]	:	[75.0]	[ns]
Width	:	[100.]	[ns]
Transition	:	[Fixed]	
Leading	:	5.5	ns
Trailing	:	5.5	ns

TRIGGER (external input)

GENERATOR: PULSE AND PATTERN

DISPLAY

LABEL

FIELD

CONTROL

State:

[Off], default state

The external input is disabled.

[On], trigger and gate only

The external input is enabled.

When a MANUAL function is executed, the trigger state changes to [OFF].

Device Command:

`:INP:TRIG:STAT ON|OFF|1|0`

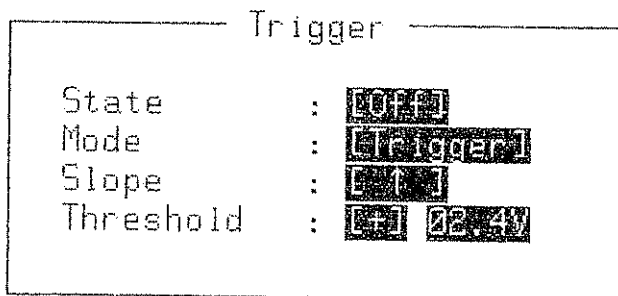

CONTROL

Mode:

[Auto], default mode

Pulse generator: A continuous pulse stream is generated.

Pattern generator: A START event is required before cycling begins.

1. START key
2. CONTINUE key
3. `:INP:TRIG:STAR IMM`
4. `:INP:TRIG:CONT`
5. *TRG

Device Command: `:INP:CONT:MODE AUTO`

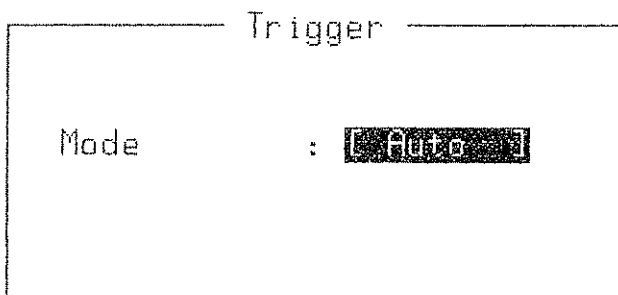

TRIGGER (external input)

GENERATOR: PULSE AND PATTERN

DISPLAY

LABEL

FIELDS

CONTROL

Mode:
(Contd.)

[Trigger]

Pulse generator: One pulse or double pulse is generated per trigger (external input) signal. The period label at the timing page is not displayed.

Conflict: The trigger mode 'trigger' and control mode 'period' are incompatible (pulse generator).

Pattern generator: A trigger (external input) signal is a START event. See CYCLING.

Device Command: :INP:TRIG:MODE TRIG

CONTROL

Mode:
(Contd.)

[Gate]

Pulse generator: pulses are generated for the duration of the gate. The last pulse is completed.

Pattern generator: the first gate edge is a START event and the second gate edge is a STOP event. See CYCLING.

Conflict: the GATE mode and slope/start on 'Both' are incompatible.

Device command: :INP:TRIG:MODE GATE

Trigger	
State	: [OFF]
Mode	: [Trigger]
Slope	: []
Threshold	: [] [2.4V]

Trigger	
State	: [OFF]
Mode	: [Gate]
Start on	[↑] and
Stop on	↓ Edge

TRIGGER (external input)

GENERATOR: PULSE AND PATTERN

DISPLAY

LABEL

FIELD

CONTROL

Slope

Pulse generator: trigger and gate

```
Trigger
State      : [Both]
Mode       : [Trigger]
Slope      : [↑]
Threshold  : [+] 02.4V
```

[positive slope], up arrow, default
[negative slope], down arrow
[Both], double headed arrow

Conflict: 'Both' and trigger mode
'gate' are incompatible.

Device Command:

:INP:TRIG:SLOP POS|NEG|BOTH

CONTROL

Start on

Pattern generator: trigger and gate

```
Trigger
State      : [OFF]
Mode       : [Gate]
Start on   : [↑] and
Stop on ↓ Edge
```

[positive slope], up arrow, default
[negative slope], down arrow
[Both], double headed arrow

Conflict: 'Both' and trigger mode
'gate' are incompatible.

Device Command:

:INP:TRIG:STAR POS|NEG|BOTH

CONTROL

Threshold

See THRESHOLD

WIDTH

GENERATOR: PULSE AND PATTERN

DISPLAY

LABEL

FIELD

TIMING

Width:

9.0 ns <= Width <= 999 ms

Resolution = LSD/See Table 8-1.

Default value = 100 us

Width programming and data formats NRZ and DNRZ are incompatible. The width label is not displayed.

Device Command:

:PULS:TIM:WIDT <value>|MIN|MAX

Channel 1	
Delay	: 75.0 [ns]
Width	: 100 [ns]
Transition	: [Linear]
Leading	: 10.0 [ns]
Trailing	: 10.0 [ns]

Width Range:

Ranges: See Table 8-1/Figure 8-1.

Default range: 10.0 ns to 99.9 ns

If control mode 'width' is enabled, the width range label replaces the width label and is used to specify the width range.

Device Command:

:INP:CONT:RANG <value>|MIN|MAX

Channel 1	
Delay	: 75.0 [ns]
Width Range	: 10.00 [ns]
Transition	: [Linear]
Leading	: 10.0 [ns]
Trailing	: 10.0 [ns]

TABLE 8-1. PERIOD, DELAY, DOUBLE and WIDTH RANGES

<u>RANGE NUMBER</u>	<u>RANGE</u>	<u>RESOLUTION</u>
1	*** - 99.9 ns	100 ps
2	100 ns - 999 ns	1 ns
3	1 us - 9.99 us	10 ns
4	10 us - 99.9 us	100 ns
5	100 us - 999 us	1 us
6	1 ms - 9.99 ms	10 us
7	10 ms - 99.9 ms	100 us
8	100 ms - 999 ms	1 ms

*** Delay: Pulse delay = 75 ns
 Double pulse delay = 20 ns
 Period: Pulse, RZ, and DNRZ = 20 ns
 NRZ = 10.0 ns.
 Width: 10.0 ns.

FIGURE 8-1. CONTROL INPUT

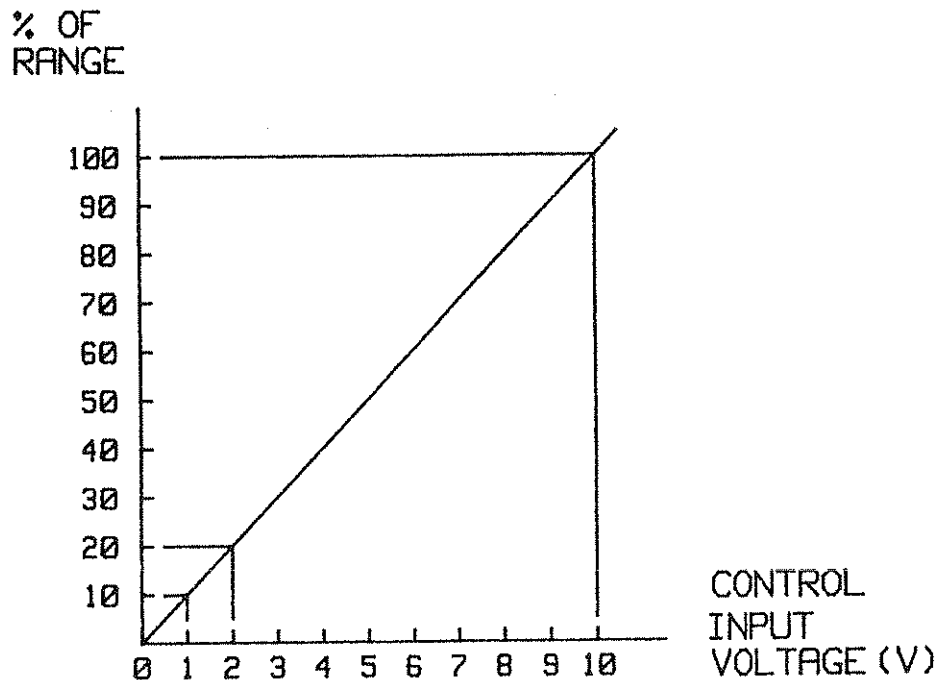

TABLE 8-2. EDGE RANGES

<u>NUMBER</u>	<u>RANGE</u>	<u>RESOLUTION</u>
1	5.5 ns - 99.9 ns	100 ps
2	50 ns - 999 ns	1 ns
3	0.50 us - 9.99 us	10 ns
4	5.0 us - 99.9 us	100 ns
5	50 us - 999 us	1 us
6	0.50 ms - 9.99 ms	10 us
7	5.0 ms - 99.9 ms	100 us

FIGURE 8-2. EDGE RANGES

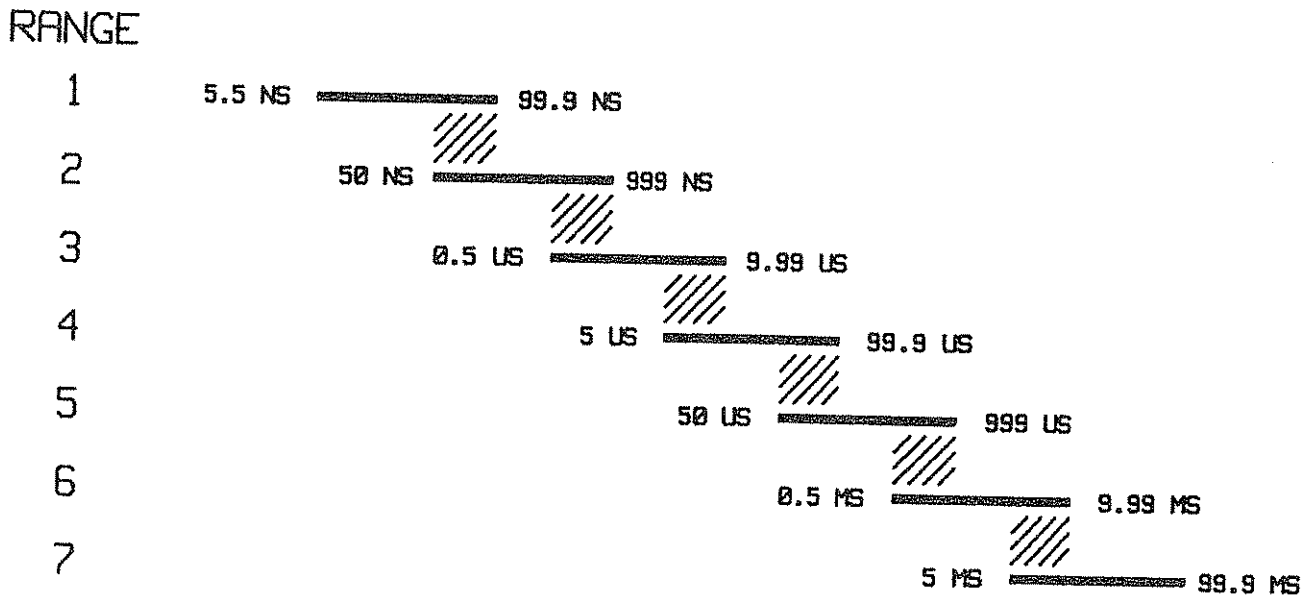

TABLE 8-3. DATA FORMAT and TIMING COMPATIBILITY

	<u>DATA FORMATS</u>		
	<u>RZ</u>	<u>NRZ</u>	<u>DNRZ</u>
TIMING			
Delay	YES	NO	YES
Width	YES	NO	NO
Strobe Width	YES	NO	YES
Strobe Delay	YES	NO	YES

TABLE 8-4. CONTROL MODE COMPATIBILITY

	<u>PERIOD</u>	<u>CONTROL MODES</u>		<u>HIGH LEVEL</u>
		<u>DELAY</u>	<u>WIDTH</u>	
TRIGGER				
Trigger	NO	YES	YES	YES
EX.CLOCK	NO	YES	YES	YES
OUTPUT-				
Addition	YES	YES	YES	NO
DATA				
RZ	YES	YES	YES	YES
NRZ	YES	NO	NO	YES
DNRZ	YES	YES	NO	YES

CHAPTER 9 EDITOR

WORD MODE

CONTENTS

ALPHA-LIST

Append Column
Clear
Copy Word
Delete Column
Delete Digit
Delete Word
Insert Column
Insert Digit
Insert Word
Modify
Move
Randomize
Set

KEY LIST

COPY

Copy Word

DELETE

Delete Column
Delete Digit
Delete Word

INSERT

Append Column
Insert Column
Insert Digit
Insert Word

MODIFY

Clear
Modify
Randomize
Set

MOVE

Move Word

APPEND COLUMN

DEFINITION

A specified number of columns consisting of 'zero' digits are appended at the least significant display column of both channels.

The word length is increased by the number of columns appended; however, the following relationship applies:

3 bits \leq (Word-Length)(No. of Words) \leq 16834 bits

3 \leq Word Length \leq 256 Bits

1 \leq Number of Words \leq 3640 Words

Number of bits/frame restrictions:

Word length of 3 = 10920 Bits

Word length of 4 = 14560 Bits

EXAMPLE

In the figure on the opposite page:

Channel:	1	2
Before append:	000001 000001 000001	000001 000001 000001
After append:	0000010 0000010 0000010	0000010 0000010 0000010

APPEND COLUMN

```

Data [Entry] -----
OUTPUT 1
Display [both Channels] Base: [Bin] Cursor on Word : [2]
Words : 3 Cursor on Digit: [0]
Digits: 6
----- Channel 1 ----- Channel 2 -----
Word Digit → 0 0
↓ ↓ ↓

```

```

0← [000001] [000001]
1 [000001] [000001]
2 [000001] [000001]

```

[APPEND Column] [1] times

EDITOR KEY

BLUE/INSERT

FIELDS

Number of columns
to be appended:
'_(1)_ times'

EXECUTION

EXEC key

CLEAR

DEFINITION

All bits within the block specified by the 'from' and 'through' fields are cleared to zero.

'from' word < 'through' word

EXAMPLE

In the figure on the opposite page:

Channel:	1	2
Before clear:	111111 111111 111111	111111 111111 111111
After clear:	111111 000000 000000	111111 111111 111111

If the clear function applies to one channel, no change occurs to the other channel as illustrated by channel 2 in the example above.

CLEAR

Data **[Enter]** -----

Display **[Both Channels]** Base: **[Bin]** Cursor on Word : **[2]**
 Words : 3 Cursor on Digit: **[2]**
 Digits: 6

----- Channel 1 ----- Channel 2 -----

Word Digit → 0 0
 1 1
 2+ 1 1

0	111111	111111
1	111111	111111
2+	[111111]	[111111]

[CLEAR] **[Channel 1]** from Word **[1]** through **[2]**

EDITOR KEY

BLUE/MODIFY

FIELDS

Channel selection:
 [Channel 1]
 [Channel 2]
 [both Channels]

'from':
 '_(1)_'

'through':
 '_(2)_'

EXECUTION

EXEC key

COPY WORD

DEFINITION

The words specified by the 'from' and 'through' fields are copied to the 'to' channel beginning at the word specified by the 'to' field.

'from' word < 'through' word

The copy function does not increase the number of words in the frame. Thus, the words copied must be copied to locations within the current frame. Copying writes over the old data. Thus, the old data is destroyed.

EXAMPLE

In the figure on the opposite page:

Channel:	1	2
Before copying:	000000	000000
	000000	000000
	111111	111111
	111111	111111
	111111	111111
	111111	111111
After copying:	000000	000000
	000000	000000
	111111	111111
	111111	111111
	000000	111111
	000000	111111

If the copy function applies to one channel, no change occurs in the other channel as illustrated by channel 2 in the example above.

COPY WORD

```

Data [Enter] -----
Display [Both Channels] Base: [Bin] Cursor on Word : [5]
Words : 6 Cursor on Digit: [0]
Digits: 6
      Channel 1      Channel 2
Word  Digit →      0      0
  ↓              ↓      ↓
0      000000      000000
1      000000      000000
2      111111      111111
3      111111      111111
4      111111      111111
5←     [111111]    [111111]
  
```

```

COPY Word from [Channel 1] [0] through [1]
           to  [Channel 2] [4]
  
```

EDITOR KEY

BLUE/COPY

FIELDS

Channel selection:
 [Channel 1]
 [Channel 2]

'from':
 '_(1)_ through_(2)_'

'to':
 '_(3)_'

EXECUTION

EXEC key

DELETE COLUMN

DEFINITION

The columns from the column pointed to by the 'Cursor on Digit' field to the 'through' field are deleted.

The following relationship applies:
'Cursor on Digit' < 'through' digit

The word length is decreased by the number of bits deleted.

The following relationship applies:
columns deleted \leq (number of columns)-3,
that is, $3 \leq$ 'Word-Length' \leq 256 Bits

EXAMPLE

In the figure on the opposite page:

'Cursor on Digit' = 0

Channel:	1	2
Before delete:	001111	111100
	001111	111100
	001111	111100
After delete:	1111	1111
	1111	1111
	1111	1111

If the delete function applies to only one channel, the same number of columns are deleted from the least significant digitS of the other channel as illustrated by channel 2 in the example above.

DELETE COLUMN

Data **[Entry 2]** -----

Display **[Both Channels]** Base: **[Bin]** Cursor on Word : **[]**
 Words : 3 Cursor on Digit: **[]**
 Digits: 6

----- Channel 1 ----- Channel 2 -----

Word Digit → 0 0
 ↓ ↓ ↓

0←	[001111]	[111100]
1	001111	111100
2	001111	111100

[DELETE Column] at **[Channel 1]** through **[1]**

EDITOR KEY

BLUE/DELETE

FIELDS

Channel selection:
 [Channel 1]
 [Channel 2]
 [both channels]

'through':
 '_(1)'

EXECUTION

EXEC key

DELETE DIGIT

DEFINITION

The digit pointed to by the 'Cursor on Digit' field is deleted. The word length is not changed.

The effect is:

1. A digit is deleted.
2. The digits to the right of the deleted digit are shifted left one place.
3. A 'zero' digit is inserted at the least significant digit position.

EXAMPLE

In the figure on the opposite page:

Cursor on Word = 1
Cursor on Digit = 2

Channel:	1	2
Before delete:	111111 110111 111111	111111 111111 111111
After delete:	111111 111110 111111	111111 111111 111111

DELETE DIGIT

Data **[Entry 1]** -----

Display **[both Channels]** Base: **[Bin]** Cursor on Word : **[1]**
 Words : 3 Cursor on Digit: **[2]**
 Digits: 6

----- Channel 1 ----- Channel 2 -----

Word Digit → 0 0
 ↓ ↓ ↓

0	111111	111111
1←	[111111]	[111111]
2	111111	111111

[DELETE Digit] at **[Channel 1]**

EDITOR KEY

BLUE/DELETE

FIELDS

Channel selection field:
 [Channel 1]
 [Channel 2]
 [both Channels]

EXECUTION

EXEC key

DELETE WORD

DEFINITION

The words from the word pointed to by the 'Cursor on Word' field to the 'through' field are deleted.

The following relationship applies:

'Cursor on Word' < 'through' word

The number of words in the frame is reduced by the number of words deleted. The following relationship applies:

words deleted \leq (No. of Words) - (1), or
 $1 \leq$ 'No. of Words' \leq 3640 Words

EXAMPLE

In the figure on the opposite page:

Cursor on Word = 1

Channel:	1	2
Before delete:	111111 000000 000000 111111	000000 000000 111111 111111
After delete:	111111 111111	000000 000000

If the delete function applies to only one channel, the same number of words are deleted from the end of the other channel as illustrated by channel 2 in the example above.

DELETE WORD

Data [Entry] -----

Display [both Channels] Base: [Bin] Cursor on Word : []
 Words : 4 Cursor on Digit: []
 Digits: 6

----- Channel 1 ----- Channel 2 -----

Word Digit → 0 0
 ↓ ↓ ↓

0	111111	000000
1←	000000	000000
2	000000	111111
3	111111	111111

[DELETE Word] at [Channel 1] through [2]

EDITOR KEY

BLUE/DELETE

FIELDS

Channel selection:
 [Channel 1]
 [Channel 2]
 [both Channels]

'through':
 '_(1)_'

EXECUTION

EXEC key

INSERT COLUMN

DEFINITION

A specified number of columns are inserted before the column identified by the 'Cursor on Digit' field.

The word length is increased by the number of columns inserted, however, the following relationship applies:

$3 \text{ bits} \leq (\text{Word-Length})(\text{No. of Words}) \leq 16384$ bits.

$3 \leq \text{Word Length} \leq 256$ Bits

$1 \leq \text{Number of Words} \leq 3640$ Words

Number of bits/frame restrictions:

Word length of 3 = 10920 Bits

Word length of 4 = 14560 Bits

EXAMPLE

In the figure on the opposite page:

Cursor on Digit = 3

Channel:	1	2
Before insert:	111111 111111 111111	111111 111111 111111
After insert:	1110111 1110111 1110111	1111110 1111110 1111110

If the insert function applies to one channel, the same number of columns, consisting of 'zeros', are appended to the other channel as illustrated by channel 2 in the example above.

INSERT COLUMN

Data [Entry.] -----

Display [both Channels] Base: [Bin] Cursor on Word : []
 Words : 3 Cursor on Digit: []
 Digits: 6

----- Channel 1 ----- Channel 2 -----

Word Digit → 0 0
 ↓ ↓ ↓

```

0← [ ] [ ]
1 111111 111111
2 111111 111111
  
```

[INSERT Column] at [Channel 1] [1] times

EDITOR KEY

BLUE/INSERT

FIELDS

Channel selection:
 [Channel 1]
 [Channel 2]
 [both Channels]

Number of columns
 to be inserted:
 '_(1)_ times'

EXECUTION

EXEC key

INSERT DIGIT

DEFINITION

A 'zero' digit is inserted before the digit pointed to by the 'Cursor on Digit' field. The length of the word is not changed by the insert digit function.

The effect is as if a digit is inserted, the digits rotated right one space, and the least significant digit removed.

EXAMPLE

In the figure on the opposite page:

Cursor on Digit = 0

Channel:	1	2
Before insert:	111110	111111
After insert:	011111	111111

INSERT DIGIT

Data **[Enter]** -----

Display **[both Channels]** Base: **[HEX]** Cursor on Word : **[]**
 Words : 1 Cursor on Digit: **[]**
 Digits: 6

----- Channel 1 ----- Channel 2 -----

Word Digit → 0 0
 ↓ ↓ ↓

0← **[HEX]** **[000000]**

[INSERT Digit] at **[Channel 1]**

EDITOR KEY

BLUE/INSERT

FIELDS

Channel selection:
 [Channel 1]
 [Channel 2]
 [both Channels]

EXECUTION

EXEC key

INSERT WORD

Data **[Enter]** -----

Display **[Both Channels]** Base: **[Hex]** Cursor on Word : **[1]**
 Words : 3 Cursor on Digit: **[4]**
 Digits: 6

----- Channel 1 ----- Channel 2 -----

Word Digit → 0 0
 ↓ ↓ ↓

0	111111	111111
1←	[111111]	[111111]
2	111111	111111

[INSERT Word] at **[Channel 1]** **[1]** times

EDITOR KEY

BLUE/INSERT

FIELDS

Channel selection:
 [Channel 1]
 [Channel 2]
 [both Channels]

Number of words
 to be inserted:
 '_(1)_ times'

EXECUTION

EXEC key

MODIFY

DEFINITION

The words specified in the 'from' and 'through' fields are modified to the patterns specified in the pattern modification fields.

'from' word < 'through' word

The pattern modification fields are initially filled with points which indicate that the corresponding digits will not be modified.

Thus, to create the required modifying pattern, it is only necessary to enter the required changes in the pattern modification fields and execute the function.

The modify function cannot increase the size of the frame. Thus, only words of the current frame can be modified.

EXAMPLE

In the figure on the opposite page:

Channel:	1	2
Pattern modification fields:	00 .. 00
Before modify:	111111 111111 111111	111111 111111 111111
After modify:	001100 001100 001100	111111 111111 111111

MODIFY

Data **[Error]** -----

Display **[Both Channels]** Base: **[Bin]** Cursor on Word : **[2]**
 Words : 3 Cursor on Digit: **[0]**
 Digits: 6

----- Channel 1 ----- Channel 2 -----

Word Digit → 0 0
 ↓ ↓ ↓

0←	[111111]	[111111]
1	111111	111111
2	111111	111111

[MODIFY] **[0,0]** **[]**

from Word **[0]** through **[2]**

EDITOR KEY

BLUE/MODIFY

FIELDS

Pattern modification:

'...(1)'
 '...(2)'/

'from':
 '_(3)_'

'through':
 '_(4)_'

EXECUTION

EXEC key

MOVE WORD

DEFINITION

The words specified by the 'from' and 'through' fields are transferred to a new location within the current frame. The location begins in front of the word specified by the 'to' field.

'from' word < 'through' word

The word specified by the 'to' field cannot be a word specified by the 'from' and 'through' fields; otherwise, a 'range overlap' error occurs.

EXAMPLE 1

A forward move is illustrated in the figure on the opposite page:

Base [HEX]
'to' field = 1

	WORD	CH.1	CH.2
Before moving:	0	A	A
	1	B	B
	2	C	C
	3	D	D
	4	E	E
	5	F	F
	6	A	A
After moving:	0	A	A
	1	E	B
	2	F	C
	3	B	D
	4	C	E
	5	D	F
	6	A	A

If the move function applies to one channel, no changes occur in the other channel as illustrated by channel 2 in the example above.

MOVE WORD

```

Data [Entry] -----
Display [Both Channels] Base: [Hex] Cursor on Word : [5]
Words : 7 Cursor on Digit: [4]
Digits: 1

----- Channel 1 ----- Channel 2 -----
Word Digit →      0      0
↓                ↓      ↓

0                A      A
1                B      B
2                C      C
3                D      D
4                E      E
5 ←             [F]     [F]
6                A      A
  
```

MOVE Word from [Channel 1] [4] through [5] to [1]

EDITOR KEY

BLUE/MOVE

FIELDS

Channel selection:
 [Channel 1]
 [Channel 2]
 [both Channels]

'from':

'_(1)_ through _(2)_'

'to':

'_(3)_'

EXECUTION

EXEC key

MOVE WORD

EXAMPLE 2

A backward move is illustrated in the figure on the opposite page.

Base [HEX]
'to' field = 6

	WORD	CH.1	CH.2
Before moving:	0	A	A
	1	B	B
	2	C	C
	3	D	D
	4	E	E
	5	F	F
	6	A	A
After moving:	0	A	A
	1	D	B
	2	E	C
	3	F	D
	4	B	E
	5	C	F
	6	A	A

If the move function applies to one channel, no changes occur in the other channel as illustrated by channel 2 in the example above.

MOVE WORD

Data [Entry] -----

Display [both Channels] Base: [Hex] Cursor on Word : [6]
 Words : 7 Cursor on Digit: [4]
 Digits: 1

Word	Digit →	Channel 1	Channel 2
0	↓	0	0
1		A	A
2		B	B
3		C	C
4		D	D
5		E	E
6←		F	F

MOVE Word from [Channel 1] [1] through [2]
 to [6]

EDITOR KEY

BLUE/MOVE

FIELDS

Channel selection:
 [Channel 1]
 [Channel 2]
 [Both Channels]

'from':
 '_(1)_ through _(2)_'

'to':
 '_(3)_'

EXECUTION

EXEC key

RANDOMIZE

DEFINITION

The bits within the block of words specified by the 'from' and 'through' fields are assigned values from sequences with lengths generated according to the following formula:

$$\text{Length} = ((2 \text{ exponent } n) - 1) \text{ bits.}$$

'from' word < 'through' word

A pseudo-random binary sequence, PRBS, is assigned when the bit length of the block equals $((2 \text{ exponent } n) - 1)$, where $2 \leq n \leq 14$.

The start value for the random generator is defined by the first n -bits of the block, where n is the exponent from the expression $((2 \text{ exponent } n) - 1)$. **The start value cannot equal zero.**

The value for n is the smallest value substituted into the expression that yields a result which is equal to or greater than the number of bits in the block.

EXAMPLE

In the figure on the opposite page:

block length =40 (bits 0-39)
 $n =6$, and $(2 \text{ exponent } n)-1 = 63 > 40$
Start value =111111

Channel:		1
Before randomizing:	1111111111	1111111111
	1111111111	1111111111
After randomizing:	111110101	0110011011
	1011010010	0111000101

If the randomize function applies to only one channel, no change occurs to the other channel.

Free Manuals Download Website

<http://myh66.com>

<http://usermanuals.us>

<http://www.somanuals.com>

<http://www.4manuals.cc>

<http://www.manual-lib.com>

<http://www.404manual.com>

<http://www.luxmanual.com>

<http://aubethermostatmanual.com>

Golf course search by state

<http://golfingnear.com>

Email search by domain

<http://emailbydomain.com>

Auto manuals search

<http://auto.somanuals.com>

TV manuals search

<http://tv.somanuals.com>