

# HSM®

## OPERATING INSTRUCTIONS PAPER SHREDDER



Combination with  
HSM KP 80

# HSM FA 500.2

english



*Keep this instruction for future use!*

1.655.999.112 – 0702

## Contents

1.	Proper use, warranty.....	3
2.	Safety instructions.....	3
3.	Overview .....	4
4.	Dimensions .....	5
5.	Transportation, installation .....	6
6.	Operating and display elements on the keypad.....	7
7.	Start-up and inspecting the safety devices .....	8
8.	Malfunctions.....	10
9.	Maintenance and care .....	10
10.	Technical data.....	13
11.	Electric wiring diagrams for Solo- and Combination-version .....	14

# HSM®

## HSM GmbH + Co. KG

Bahnhofstrasse 115  
D-88682 Salem / Germany

Tel.: +49 (0) 75 53 / 822-0  
Fax.: +49 (0) 75 53 / 822-160  
E-Mail: [info@hsm-online.de](mailto:info@hsm-online.de)  
[www.hsm-online.de](http://www.hsm-online.de)

## HSM (UK) Ltd.

14, Attwood Road / Zone 1  
Burntwood Business Park  
Burntwood  
Staffordshire  
WS7 3GJ  
United Kingdom

Phone: +44 (0) 1543 272 480  
Fax: +44 (0) 1543 272 080  
E-mail: [info@hsmuk.co.uk](mailto:info@hsmuk.co.uk)  
[www.hsmuk.co.uk](http://www.hsmuk.co.uk)

## HSM of America LLC

1075 Andrew Drive  
Suite C  
West Chester, PA 19380  
USA

Phone: 001 610 918 4894  
Fax: 001 610 918 4899  
E-mail: [email@hsmofamerica.com](mailto:email@hsmofamerica.com)  
[www.hsmofamerica.com](http://www.hsmofamerica.com)

## 1. Proper use, warranty

The document shredder is designed for destroying paper and cardboard, as well as store cards, credit cards, CD-ROMs and floppy discs. Its sturdy drive mechanism is not damaged by paper clips and staples and is even suitable for shredding whole files and folders.

Our general business conditions are applicable. We provide a one year warranty for the document shredder. The warranty period is 6 months when used in multiple shifts. This warranty excludes wear, damage due to improper handling, natural depreciation, and actions taken by third parties.

## 2. Safety instructions



### Caution:

It is prohibited to operate one only machine of a combination-version machine. Only the combination of document shredder and HSM baling press fulfils the requirements of EN 294 (Safety clearances).

- Read the operating manual before starting up the shredder.
- Do not remove or modify safety devices which guarantee the safe operation of the machine.
- Observe all safety instructions attached to the machine.
- The shredder may not be operated by anyone under 16 years of age.
- Carry out inspection and maintenance regularly.
- Switch off the shredder, disconnect the power plug and call customer service in the following circumstances:
  - power cables or plugs are damaged
  - liquid has entered the shredder
  - the shredder has been exposed to rain
  - the machine does not work properly despite the operating manual having been observed
  - the shredder has been damaged
- No platforms or other raised surfaces may be placed near the shredder if they encroach on the specified safety clearances.



### **Danger of injury**

Do not reach into the paper feed opening.

### **Splinters can cause injury**

Wear protective goggles when destroying diskettes, CDs and hard credit cards.

### **Danger of injury during intake**

Do not go near the paper feed opening with long hair, loose clothing, ties, scarves, necklaces, bracelets etc. Do not destroy any material which might become tangled, such as tapes, binder ties or foil.

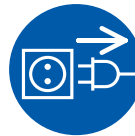

**Switch off the shredder and pull out the power plug** before moving or cleaning the shredder, or any other task outside its normal scope of use.



Maintenance and service tasks may only be performed by HSM customer service and service engineers of our dealers.

## Operating controls for your safety

### Emergency stop button

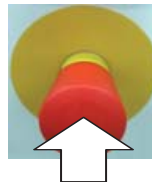

In the event of danger, press the emergency stop button immediately. This switches off the shredder, and stops the cutting block and feed belt.

### Main switch (only Solo-version)



In the event of danger, turn the main switch to "0". You can secure the main switch in this position with a padlock to prevent restarting.

### 3. Overview

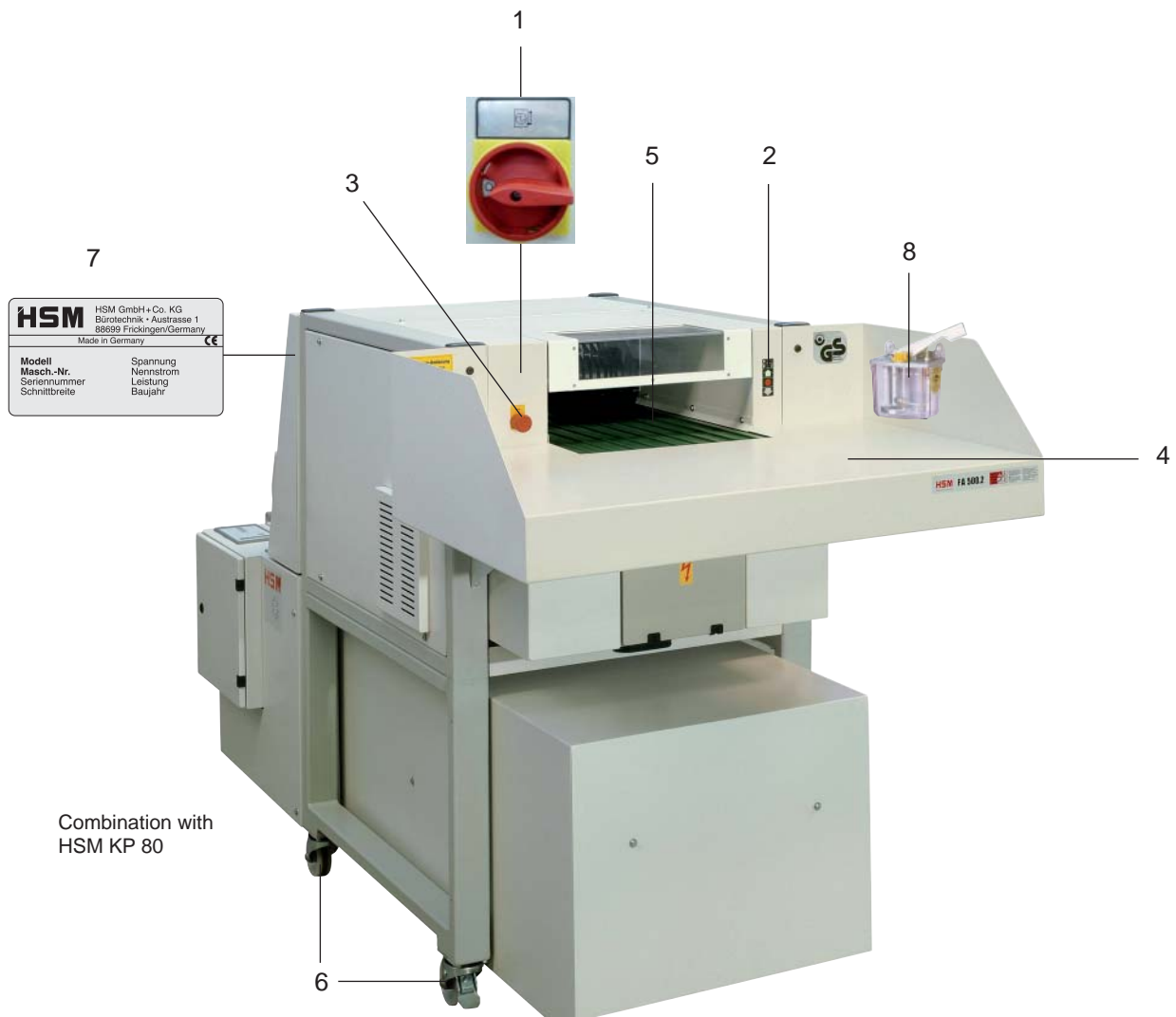

- 1 Main switch (only solo-version)
- 2 Keypad
- 3 Emergency stop button
- 4 Loading tray
- 5 Intake conveyor,  
paper feed opening
- 6 Braking swivel castors
- 7 Nameplate
- 8 Oiler

### 4. Dimensions

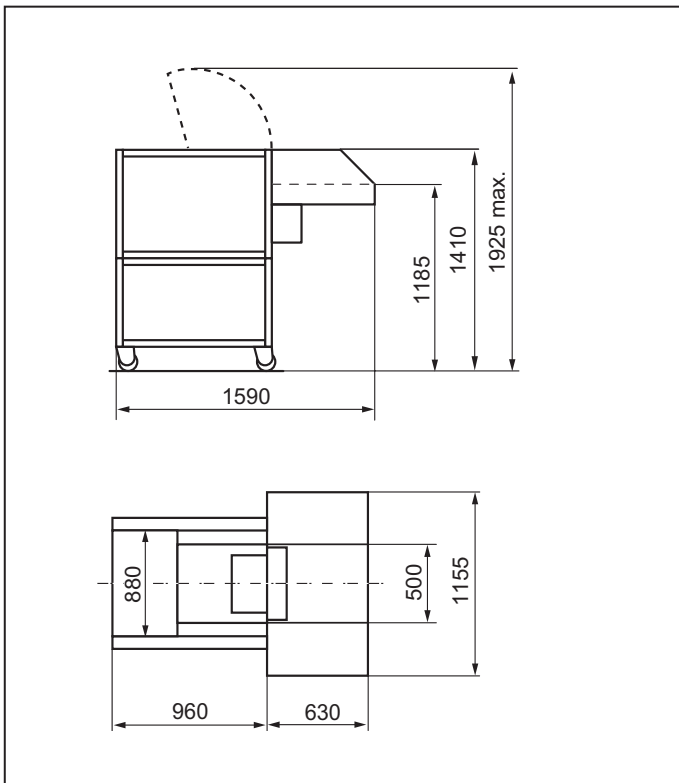

**HSM FA 500.2 Combination-version**

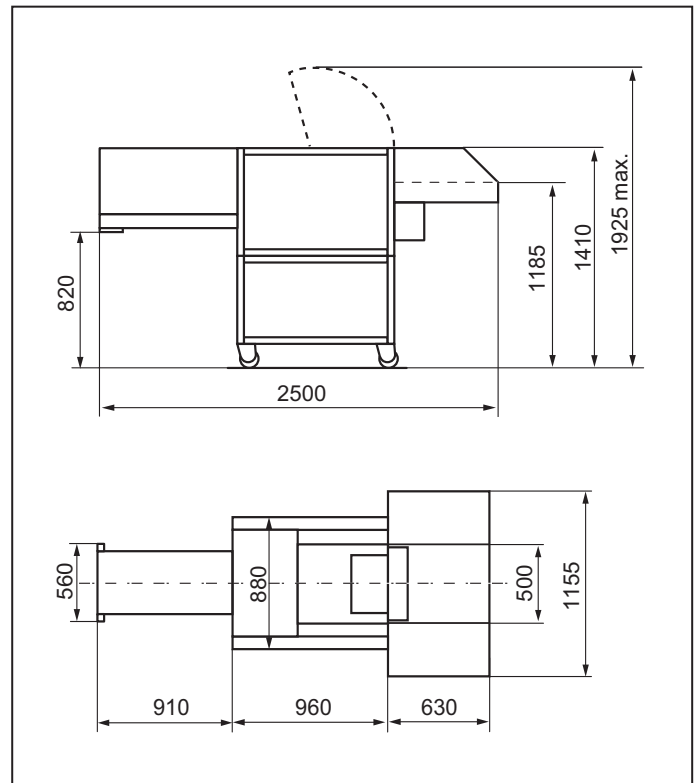

**HSM FA 500.2 Stand alone-version**

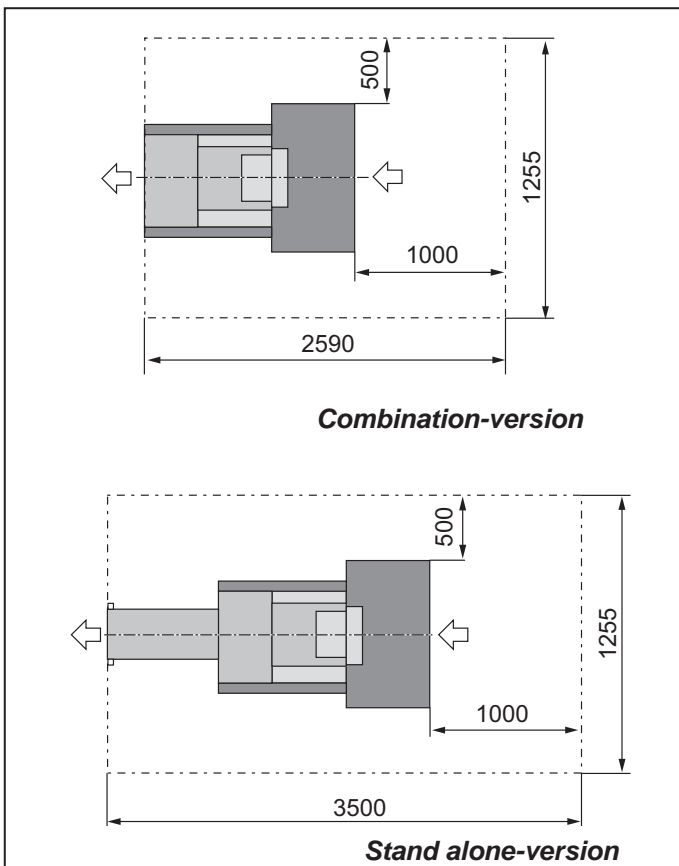

**Space requirements for operation and maintenance**

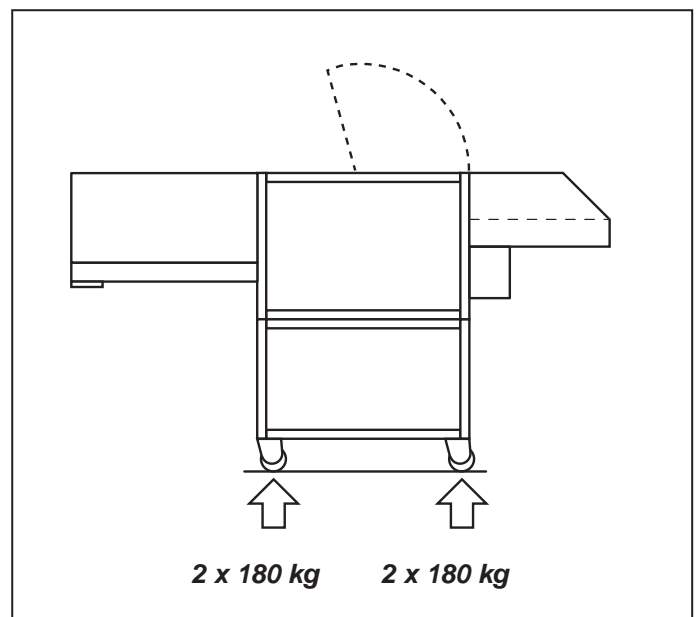

**Load on rollers**

## 5. Transportation, installation

- During transport, observe the high centre of gravity of the paper shredder!
- Place the pallet with the shredder in its packaging on a smooth, level surface.
- Observe the instructions for unpacking.
- If you need to move the shredder through narrow doors, you can wait until it is at its final location before fitting the loading tray. Without the tray, the machine is only 880 mm wide.
- The shredder may only be placed in dry rooms on a hard, level floor – not on carpets. The floor load on each roller is approximately 180 kg.
- The machine must be connected to a power source which meets the specifications on the nameplate. Make sure the power cable is unobstructed and that nobody can tread on it

### Mount the loading table onto the unit:

- Remove screws (1) and (2) from the frame.

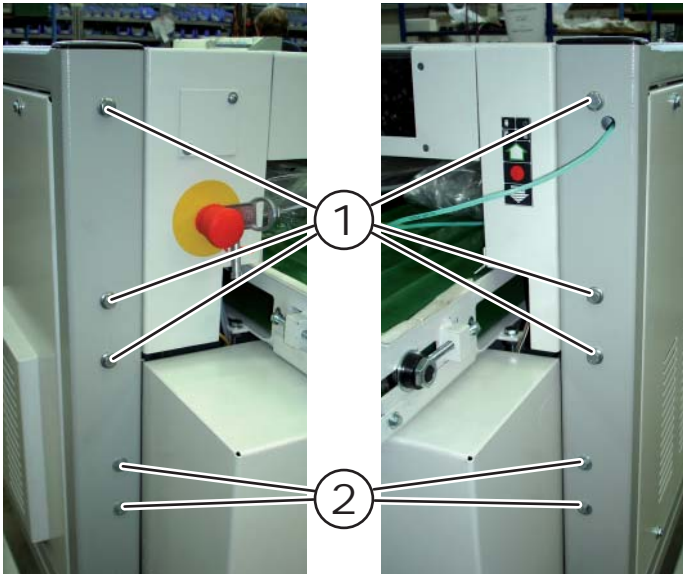

- Fasten the supports to the frame with the screws (2).



- Place the table on the supports. Make sure the oil hose is not bent. Fasten the table above (1) to the frame.

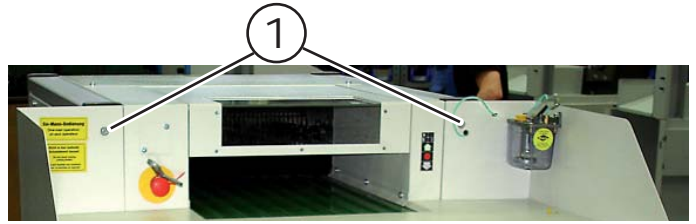

- Screw the table on with the hexagon bolts (1) also at the bottom of the frame and fasten to the supports with the bolts (3) and nuts (4).

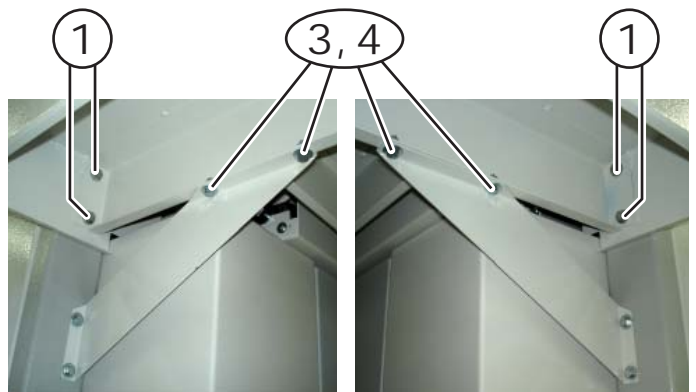

### Mount the oil hose onto the unit:

- Guide the hose through the recesses in the table to the oiler and shorten the hose.

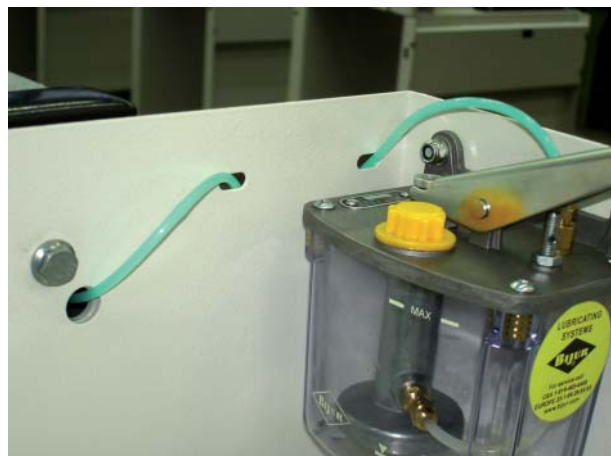

- Insert the connecting screw (5) and the clamp (6) on the end of the hose and secure the unit on the oiler.

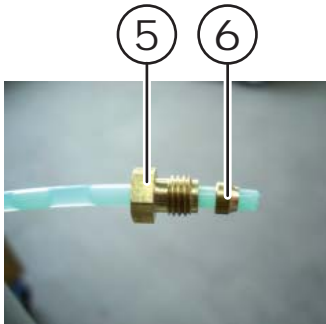

- **Solo machine:**  
Lock the front castors by pressing down the brake lever.
- **Combination version:**  
The assembly of the shredder with the baling press is described in the operator's manual of the Shredder press combination.

- Pour the oil into the oiler container from the two bottles supplied.

## 6. Operating and display elements on the keypad

**Paper jam or overload**  
Red LED

**Safety circuit interrupted**  
Red LED

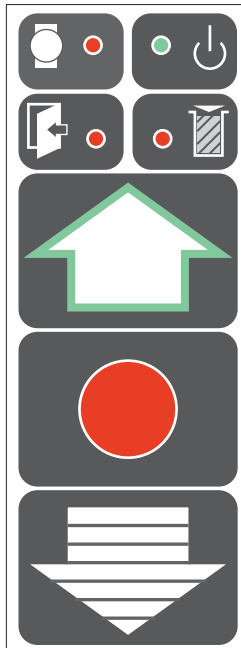

**Ready for operation**  
Green LED

Light has no function.

### Start button

The shredder switches on. The feed belt moves in the intake direction.

### Stop button

The cutting block and feed belt stop. The shredder is in standby mode.

### Reverse button

The cutting block and feed belt run in reverse.

## 7. Start-up and inspecting the safety devices



Check that the safety devices are working properly:

- At the start of each shift
- After any maintenance or repair work

Do not start the machine until you have checked the safety devices and found them to be in perfect working order. If any defect arises during operation stop the machine immediately and make sure it is corrected.

### Switching on the paper shredder

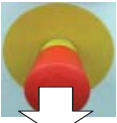

- Pull out the emergency stop button.



- Solo-version: Turn the main switch to the I position.  
Combination-version: Turn the main switch on the baling press to the I position.  
▶ The green „Ready for operation“ LED lights up.



- Press the green start button.  
▶ The cutting block and feed belt start up.



#### **Caution!**

*The feed belt can run in reverse if the phase wires in the power plug are incorrectly connected.*

*Turn off the main switch immediately and pull out the power plug! Have an electrician change two of the three phase wires.*

### Checking the emergency stop button

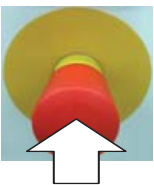

Press the emergency stop button while the machine is running. The shredder must switch off immediately. The cutting block and the feed belt must stop. The machine will only start again once you have pulled out the emergency stop button again.

### Safety flap on the feed belt

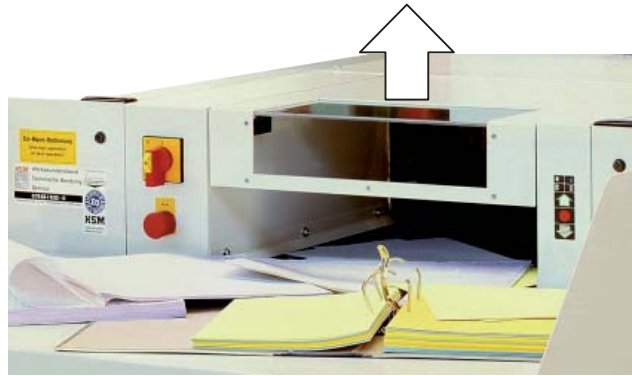

Open the safety flap.

The shredder must switch off immediately and the "Safety circuit interrupted" LED must light up.

The machine will only start again once you have closed the safety flap.

### Safety switch on the dust tray

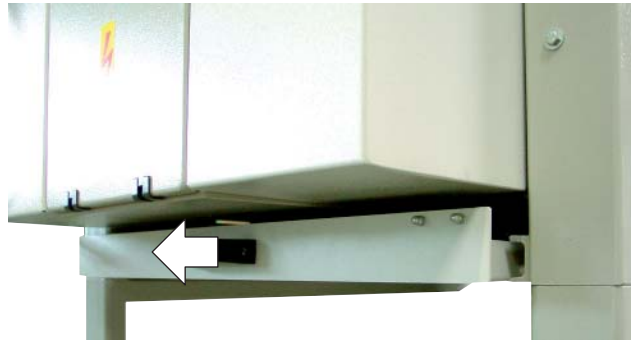

Pull out the dust tray.

The shredder must switch off immediately and the "Safety circuit interrupted" LED must light up.

The machine will only start again once you have pushed in the dust tray completely.



### Safety switch on the inspection door (only stand alone-version)



Open the inspection door.  
The shredder must switch off immediately and the "Safety circuit interrupted" LED must light up.

The machine will only start again once you have closed the inspection door.

### Safety switch on the protective flap (only stand alone-version)

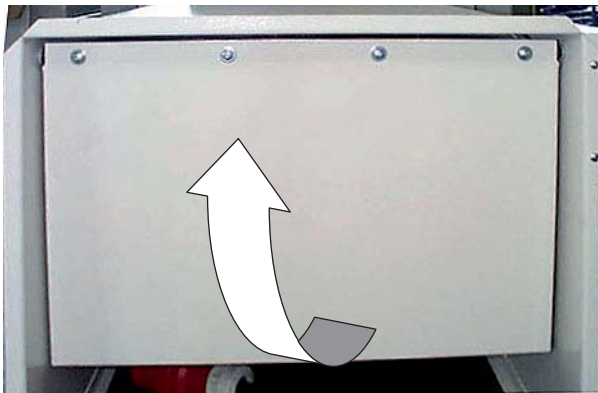

Open the protective flap.  
The shredder must switch off immediately and the "Safety circuit interrupted" LED must light up.

The machine will only start again once the protective flap is in its basic (vertical) position.

### Shredding material

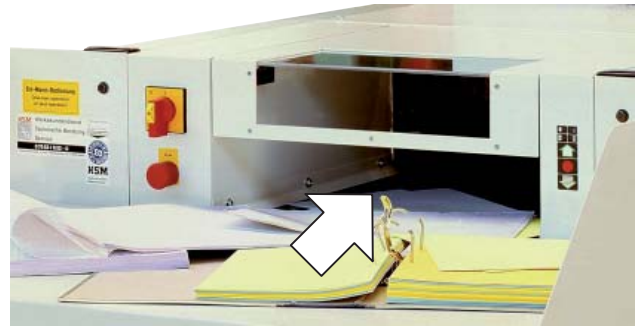

- Press the green start button.
  - ▶ The cutting block and feed belt start up.
- Place the material to be shredded on the loading tray and then place batches on the feed belt.

If material that is not supposed to be shredded is mistakenly placed onto the belt, never attempt to pull it out



- Press the stop button.
  - ▶ The drive stops.



- Press the reverse button.
  - ▶ The cutting block and feed belt run in reverse.



- You can now remove the material from the belt and start the shredder again by pressing the start button.

### Stopping the shredder



- Press the stop button.
  - ▶ The cutting block and feed belt stop.
  - ▶ The shredder switches to standby mode.

### Switching off the shredder



- Turn the main switch on the paper shredder or the baling press to 0.  
You can secure the main switch in this position using a padlock.

## 8. Malfunctions

Check the following before calling customer service:

- Is the power plug connected?
- Is the shredder switched on?
- Is there a paper jam in the shredder?
- Has the motor been overloaded?

### Paper jam

You have fed in too much paper.



- ▶ The red LED on the keypad blinks.
- ▶ The cutting block automatically runs in reverse for several seconds.



#### Caution!

The blade rollers can still cause injuries even while they are not running. Do not reach into the cutting apparatus! Wear safety gloves!

- Take out the pile of paper.



- Press the green start button and put less paper on the feed belt.

### Electric motor overheated



- ▶ The red LED on the keypad lights up.
- ▶ The shredder switches off automatically.
- Let the motor cool down for 20 - 30 minutes



- Press the green start button.

### Safety circuit interrupted



- ▶ The red LED on the keypad lights up.
- ▶ The shredder switches off automatically.
- Check
  - Safety flap on the feed belt is closed.
  - The dust tray is pushed in completely. (only stand alone-version)
  - The inspection door is closed. (only stand alone-version)
  - The protective flap is in vertical position.



- Press the green start button.

## 9. Maintenance and care

### Cleaning the cutting unit if the cutting quality deteriorates or the machine becomes noisy



- Let the shredder run without feeding in any paper.
- Push the lever of the oiler down several times.
- Make sure the oil level in the container is between the MIN and MAX markings. Order no. 1.235.997.500 for 5 litre container

### Emptying the dust tray

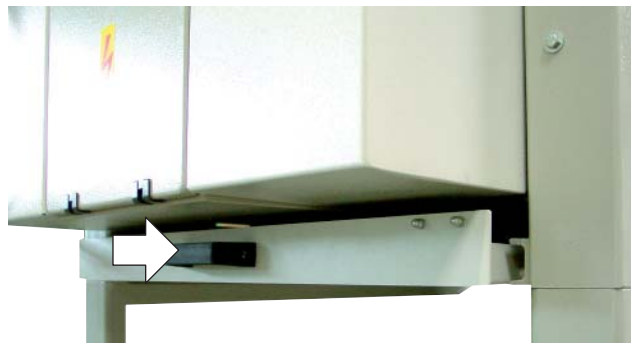

Paper dust and particles accumulate in the paper shredder during operation. To facilitate cleaning, the ground plate of the paper shredder was designed as a tray. This tray must be emptied **every week**.



#### Note:

The paper shredder cannot be switched on unless the dust tray is fully pushed in.

## Checking the chain tension (twice yearly)



- Switch off the shredder.

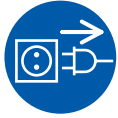

- Pull out the power plug.
- Remove the left side cover.

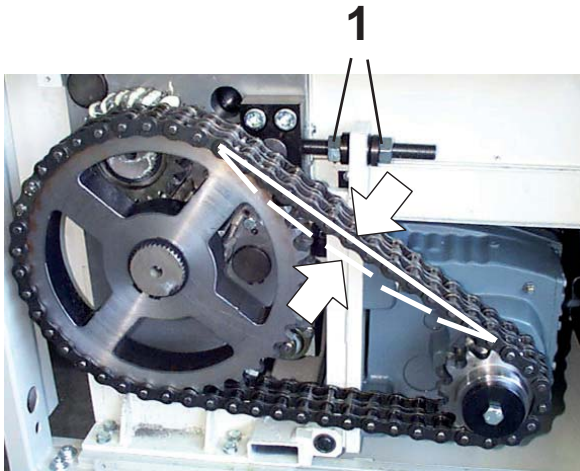

The sagging of the chain should be 9 to 14 mm.

### If you need to tighten the chain:

- Loosen the clamping nuts (1).
- Lower the motor until the sagging is 9 to 14 mm.
- Tighten the clamping nuts again.
- Reinstall the cover.



#### Note:

*Do not tighten the chain too much, as this will cause premature wear on the chain and bearings.*

## Greasing the drive chains and cogs (twice yearly)



- Switch off the shredder.

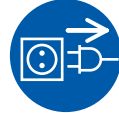

- Pull out the power plug.
- Remove the left and right side covers.
- Grease the cogs and the drive chains from the motor to the cutting apparatus, the cutting block to the feed belt and the cutting block to the regulating roller.  
Recommended lubricating grease: K2K in accordance with DIN 51502/DIN 51825
- Reinstall the covers.

## Maintenance work on the inlet conveyor belt

### Checking the stripping device

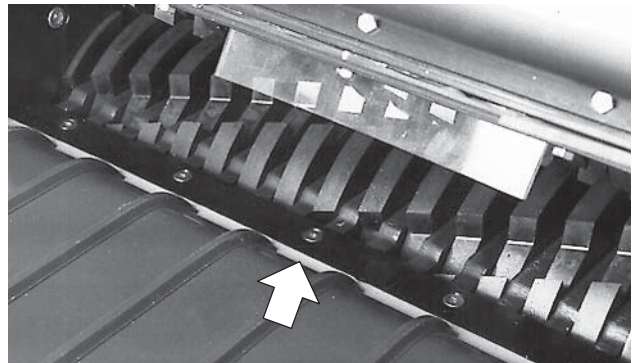

- Lift the safety flap. You can now see the stripping device.



**Caution** cutter rolls! Cutting injuries are possible even when the paper shredder is idle. Always wear protective gloves!

Check whether the stripping device is flush with the conveyor belt. Otherwise it must be readjusted:

- Loosen the countersunk screws of the clamping strip - this allows to move the stripping device.
- Align the stripping device and retighten the countersunk screws.

If the stripping bar is worn, it must be replaced. The area below the stripping device should be cleaned at the same time.

## Tightening the feed belt

The feed belt should not slip when loaded with material.



- Switch off the shredder.
- Remove the feeding table and the left and right side covers.



- Loosen the hexagon nuts (1) of the tension roll on the left and right side.
- Loosen the lock nuts (2) of the tensioning bolts (3).
- Tighten the feed belt **evenly** using the tensioning bolts.



**Note:**

*Only tighten the feed belt until it stops slipping. The feed belt bearing may be damaged if it is tightened too much.*

- Tighten the hex nuts on the snub roller and the lock nuts on the tensioning bolts again. Reinstall the covers and the table.



**You must check that the feed belt runs straight:**

- Switch on the shredder and let it run for 10 minutes. During this time, the feed belt must run in the middle of the snub roller. If it slips to the left or right edge, you must alter the setting of the snub roller.

## Checking the feed belt for wear

The surface of the feed belt can become worn after long periods of use. If you can see the fabric inlay in the belt, it must be replaced. Please notify our customer service.

## Cleaning the shredder:

- Switch off the shredder and disconnect the mains plug.
- When cleaning, only use a soft cloth and a mild soap-water solution. Never use scouring agents, cleaning fluid, petroleum or thinners.

## Cleaning the tensioning station (monthly)

- Remove the feeding table and the front panel of the tensioning station.
- Remove particles and dirt.

## Cleaning the conveyor-belt area (monthly)

- Remove the covers on both sides. The cleaning openings in the conveyor-belt covers are now accessible.
- Blow out the conveyor-belt area with compressed air or use a vacuum cleaner to remove the dirt particles.

## Checking the stripping brush (monthly)

- Remove the covers on both sides. The stripping brush below the conveyor belt is now accessible. If the stripping brush is not flush with the conveyor belt, you must re-adjust the stripping brush:
  - Loosen the brush supports on the left and on the right.
  - Re-adjust the brush support with the brush upwards.
  - Screw the brush support back on.

## 11. Technical Data

Cutting type	Cross cut		
Cut size (mm)	10.5 x 40 - 76	7.5 x 40 - 80	6 x 40 - 53
Safety level DIN 32757 – 1	2	2	3
Cutting capacity (sheets), DIN A4, 70 g/m <sup>2</sup> 80 g/m <sup>2</sup>	600 - 650 510 - 550	500 - 550 425 - 470	400 - 450 340 - 350
Cutting speed	210 mm/s		
Effective width	500 mm		
Weight	approx. 725 kg		
Voltage	3 x 400 V, 50 Hz		
Rated power	9.2 kW		
Rated current	18.1 A		
Fuse rate	32 A		
Plug	CEE 32A		
Sound level (idling / under load)	63 dB(A) / 80 dB(A)		

## Declaration of Conformity

Machinery directive 98 / 37 / EG

EMC directive 89 / 336 / EWG

Low voltage directive 73 / 23 / EWG

The manufacturer **HSM GmbH + Co. KG**, Bahnhofstrasse 115, D-88682 Salem declares herewith, that the paper shredder (**Solo machine**) **HSM FA 500.2** corresponds with the above mentioned EC Machine Directive including all relevant modifications.

Applied standards and technical specifications:

- EN 60204-1:1997-12
- EN ISO 12100-2:2003-11
- EN 55014-1:200-10 + A1:2001-10 + A2:2002-10
- EN 61000-3-2:2000-12
- EN ISO 12100-1:2003-11
- EN 294:1992-06
- EN 55014-2:1997-02 + A1:2001-12
- EN 61000-3-3:1995-01 + A1:2001-06



### Caution:

It is prohibited to operate only one machine of a combination-version machine. Only the combination of document shredder and HSM baling press fulfils the requirements of EN 294.

Salem, 01.12.2004



Rolf Gasteier - Technical Director

Machine type inspection for compliance with the requirements of the EC Machine Directive was carried out by the „Administration“/ Inspection Authority Committee of Experts, Subject Area „Office Machines and Devices“, on the premises of the Verwaltungs-Berufsgenossenschaft, Deelbögenkamp 4, D-22297 Hamburg. This inspection authority is the authority responsible in accordance with Annex V of the EC Machine Directive.

# 12. Electric wiring diagrams

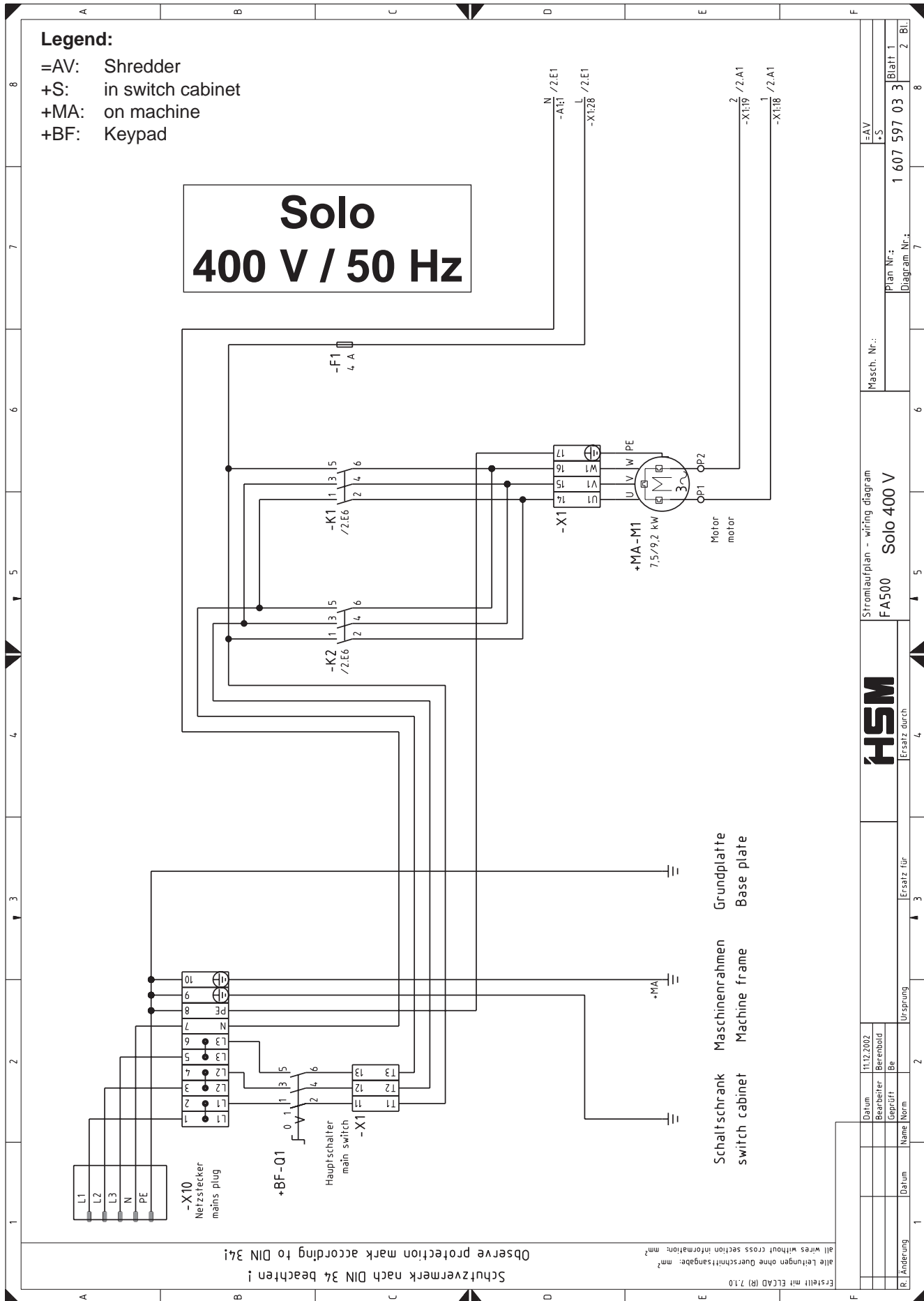

Date		11.12.2002	Date		11.12.2002
Prepared		Berenbold	Date		11.12.2002
Checked		Be	Date		11.12.2002
Name		Norm	Date		11.12.2002
Origin		2	Date		11.12.2002
Replacement for		3	Date		11.12.2002
Replacement by		4	Date		11.12.2002
Machine No.		FA 500 Solo 400 V		Machine No.	
Plan No.		1 607 597 03 3		Plan No.	
Diagram No.		Blatt 1		Diagram No.	
		8			

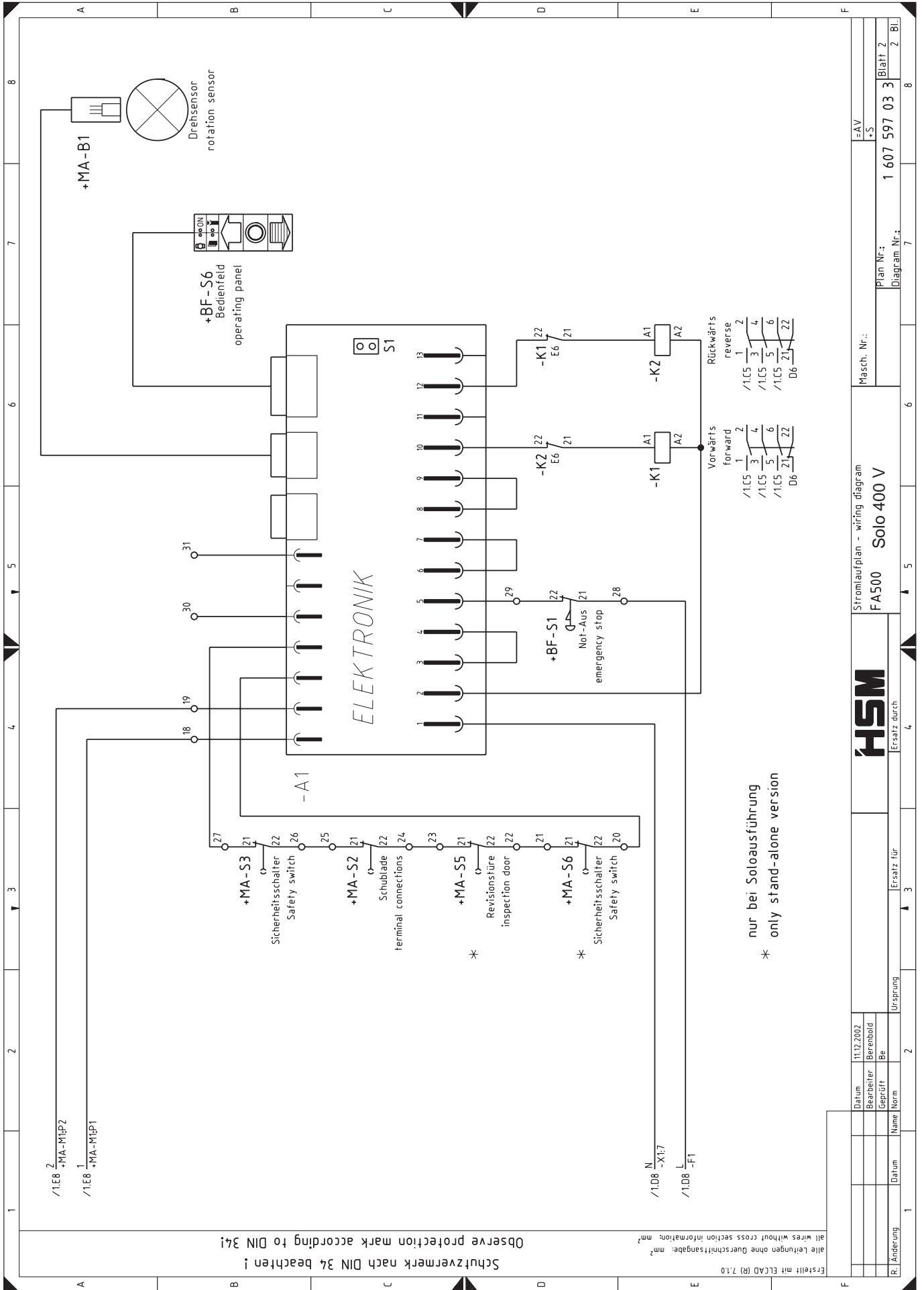

Erstellt mit ELCAD (R) 7.1.0

**Schutzvermerk nach DIN 34 beachten !**  
Observe protection mark according to DIN 34!

Kabelbezeichnung cable designation		Zielchen extern target char:external		Zielchen intern target char:internal		frei	
Datum	Bearbeiter	Datum	Name	Datum	Geprüft	Datum	Norm
11.12.2002							
Gerätekommentar		Gerätekommentar					
Anschlussleiste terminal board							
Leiste : -X1 Klemmenanzahl : 31							
Netzstecker mains plug							
X10	L1	L1	L1	L1	L1		
X10	L2	L2	L2	L2	L2		
X10	L3	L3	L3	L3	L3		
BF-01	5	6					
X10	L3	L3	L3	L3	L3		
BF-01	3	4					
X10	L2	L2	L2	L2	L2		
BF-01	2	11					
X10	L2	L2	L2	L2	L2		
BF-01	4	12					
X10	L2	L2	L2	L2	L2		
BF-01	6	13					
X10	L2	L2	L2	L2	L2		
BF-01	1	14					
X10	L2	L2	L2	L2	L2		
BF-01	15	15					
X10	L2	L2	L2	L2	L2		
BF-01	16	16					
X10	L2	L2	L2	L2	L2		
BF-01	17	17					
X10	L2	L2	L2	L2	L2		
BF-01	18	18					
X10	L2	L2	L2	L2	L2		
BF-01	19	19					
X10	L2	L2	L2	L2	L2		
BF-01	20	20					
X10	L2	L2	L2	L2	L2		
BF-01	21	21					
X10	L2	L2	L2	L2	L2		
BF-01	22	22					
X10	L2	L2	L2	L2	L2		
BF-01	23	23					
X10	L2	L2	L2	L2	L2		
BF-01	24	24					
X10	L2	L2	L2	L2	L2		
BF-01	25	25					
X10	L2	L2	L2	L2	L2		
BF-01	26	26					
X10	L2	L2	L2	L2	L2		
BF-01	27	27					
X10	L2	L2	L2	L2	L2		
BF-01	28	28					
X10	L2	L2	L2	L2	L2		
BF-01	29	29					
X10	L2	L2	L2	L2	L2		
BF-01	30	30					
X10	L2	L2	L2	L2	L2		
BF-01	31	31					

Plan Nr.: 1 607 598 03 3 Blatt 1

Diagramm Nr.: 1 Bl.

Klemmenplan - terminal connections  
Solo 400 V

FA500  
=AV+S-X1

HSM  
Ersatz durch

Ursprung

Ersatz für

AV  
+S



# Combination 400 V / 50 Hz

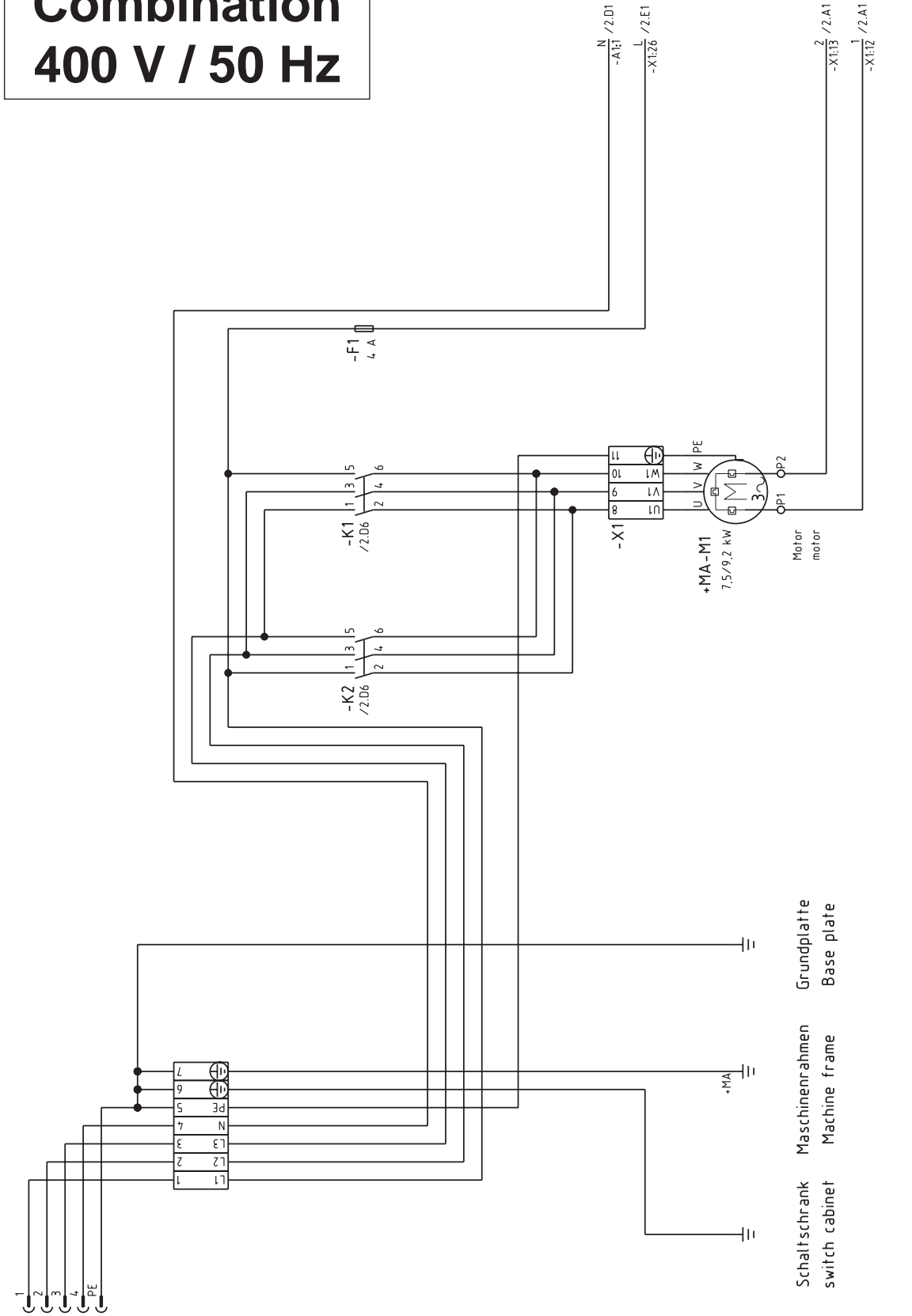

Schaltschrank    Maschinenrahmen    Grundplatte  
switch cabinet    Machine frame    Base plate

Erstellt mit ELCAD (R) 7.10  
 alle Leitungen ohne Querschnittsangaben: mm²  
 alle Leitungen ohne Querschnittsangaben: mm²  
 Schutzvermerk nach DIN 34 beachten!  
 Observe protection mark according to DIN 34!

Datum		11.12.2002		Masch. Nr.:		=AV	
Bearbeiter		Berenbold		Plan Nr.:		+S	
Geprüft		Be		Diagramm Nr.:		Blatt 1	
Name		Norm		1 607 597 03 5		2. Bl.	
Datum		Ersatz durch		Ersatz durch		Ersatz durch	
Ursprung		Ersatz durch		Ersatz durch		Ersatz durch	



Stromlaufplan - wiring diagram  
**FA500.x**  
**Kombi 400 V**

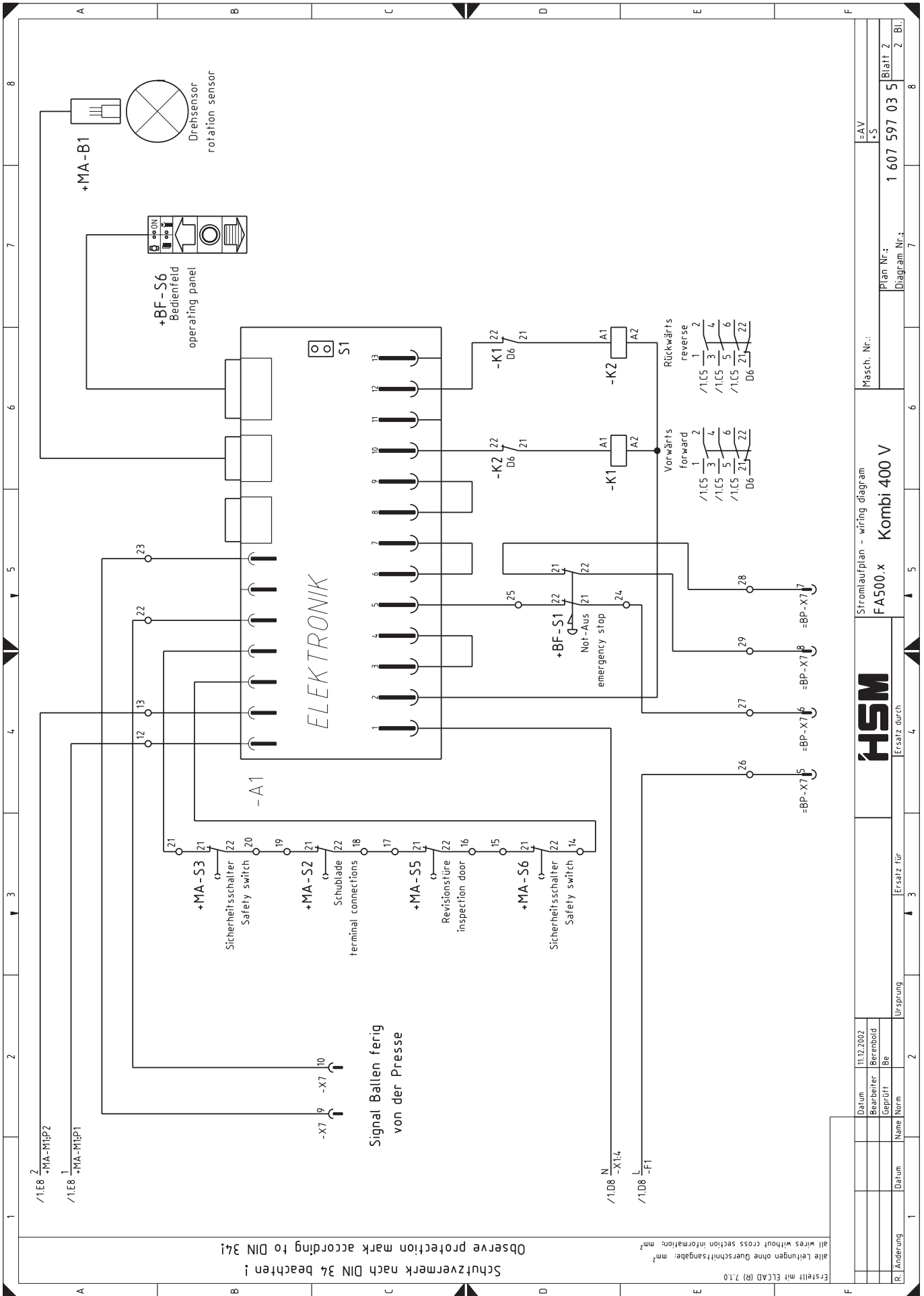

Schutzvermerk nach DIN 34 beachten!  
 Observe protection mark according to DIN 34!

Erstellt mit ELCAD (R) 7.10  
 alle Leitungen ohne Querschnittsangaben: mm<sup>2</sup>  
 all wires without cross section information: mm<sup>2</sup>

Datum		11.12.2002		Masch. Nr.:		=AV	
Bearbeiter		Berenbold		Plan Nr.:		+S	
Geprüft		Be		Diagramm Nr.:		1 607 597 03 5	
Name		Norm		Blatt 2		2	
Datum		Ersatz durch		Blatt 2		2	
Ursprung		Ersatz durch		Blatt 2		2	
Ursprung		Ersatz durch		Blatt 2		2	



Stromlaufplan - wiring diagram  
**FA500.x**  
**Kombi 400 V**





## Free Manuals Download Website

<http://myh66.com>

<http://usermanuals.us>

<http://www.somanuals.com>

<http://www.4manuals.cc>

<http://www.manual-lib.com>

<http://www.404manual.com>

<http://www.luxmanual.com>

<http://aubethermostatmanual.com>

Golf course search by state

<http://golfingnear.com>

Email search by domain

<http://emailbydomain.com>

Auto manuals search

<http://auto.somanuals.com>

TV manuals search

<http://tv.somanuals.com>