

zenAmp

DYNAMIC SECTOR MODELING™ GUITAR AMP



ENGLISH

MANUAL

Hughes & Kettner[®]
TECHNOLOGY OF TONE

zenAmp

DYNAMIC SECTOR MODELING™ GUITAR AMP

This operating manual is also available as a computer file. To download it, go to www.hughes-and-kettner.com, then to "Manuals".

Hughes & Kettner, zenAmp, DSM, Dynamic Sector Modeling, Z-Board, FS-5, the Hughes & Kettner logo, the zenAmp logo, the DSM Logo, Montana, WARP 7, and ATS 112 are trademarks or registered trademarks of Hughes & Kettner. All other product names are the property of their respective owners.

TABLE OF CONTENTS

1.0 QUICK START	6
2.0 AMP MODELS	7
3.0 STANDARD SETUP/CABLE CONNECTIONS	8
4.0 JACKS AND CONTROL FEATURES	8
4.1 OVERVIEW	8
4.2 GOOD-TO-KNOW STUFF: THE TWO MODES!	8
4.3 JACKS AND CONTROL FEATURES IN DETAIL	9
4.4 THE ZENAMP AND THE Z-BOARD	11
5.0 MAINTENANCE AND CARE	12
6.0 TROUBLESHOOTING	12
7.0 TECHNICAL SPECIFICATIONS	12
8.0 APPENDIX	45
8.1 MIDI IMPLEMENTATION CHART	45
8.2 AC POWER AND THE GLOBAL CURRENT ADAPTER	48

BEFORE POWERING UP

- Check and make sure that the local current and the amp's AC power rating are identical before you plug the **zenAmp's** mains cord into an AC outlet.
- Ensure that air can circulate freely around your amp's ventilation ducts.
- Place the amp on a stable platform where it is not exposed to mechanical shocks and will not endanger the safety of anyone nearby. Avoid temperature extremes and excessive humidity, both of which can damage the amp and may cause an electrical shock.
- The manufacturer is not liable for any damage to the amp due to improper use.
- Please also read and heed the section "NOTES ON SAFETY" on pages 2 to 4 of this manual.

CONGRATULATIONS AND THANK YOU FOR CHOOSING THE ZENAMP!

The findings of 20 years of research at Hughes & Kettner flowed into the **zenAmp**. On the one hand, it is the product of tube amp know-how. The experience gained in designing the sophisticated tube circuitry of advanced amps like the TriAmp and Custom Tube Series helped us analyze and understand down to the last detail the complex response of tube amps. On the other, the knowledge acquired in developing digital designs such as the AS 64 and the Access Preamp allowed us to apply our insights and translate what we know about the behavior of analog amps into digital models.

We call the upshot of all these efforts Dynamic Sector Modeling. This unique approach calls for both the individual components (sectors) of the original amp and the dynamic interaction between these sectors to be modeled. And that was the decisive breakthrough in modeling. Like the zenTera – the state of the art in digital amp modeling - the **zenAmp** is DSM™-powered. Courtesy of a shared gene pool, the **zenAmp** delivers the same mind-boggling authenticity of tone, acres of dynamic range, genuine feedback, and hair-trigger response to guitar volume knob tweaks that the zenTera is known for.

To be sure, tone and dynamic response are crucial. But so is ease of use. Sometimes less truly is more, and in the case of the **zenAmp**, we followed that axiom with missionary zeal. In consequence, this amp is as easy to operate as any analog amp. The amp's effects section also handles remarkably intuitively. And that makes it the ideal sonic tool for guitarists who want to dial in very different and very compelling sounds for varying applications in a hurry - no muss, no fuss. The amp ships with five programmable and 25 non-programmable presets. With the optional Z Board, you can program and call up 100 user presets in addition to the 25 factory presets.

The 2x 60 watt stereo power amp packs a mighty wallop, providing the punch needed to drive two 12" loudspeakers and cut through on stage. And, when the going gets tough, this amp really gets going: It delivers that 10% extra headroom you need to get your musical message across under extremely demanding conditions. As a very special feature, the **zenAmp** is loaded with a Celestion® Vintage 30 and a Celestion® RockDriver Junior speaker. The differences in frequency range and response make for a perfect symbiosis, adding to the amp's sonic spectrum and delivering tone that is greater than the sum of its parts.

Leading-edge modeling technology, ultra-easy handling, power galore - the **zenAmp** is the ideal workhorse for the gigging guitarist.

HERE'S KNOWING THAT YOU GET AS BIG A KICK OUT OF THE ZENAMP'S TONE AS WE DID DEVELOPING THE TECHNOLOGY BEHIND IT!

1.0 QUICK START

1. Plug the AC power cable into the mains socket on the rear panel, then plug it into a wall socket.
2. Turn the MASTER knob down and plug your guitar into the jack labeled INPUT.

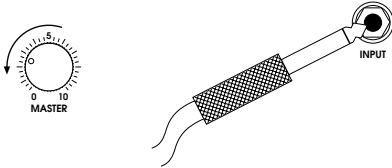

3. Switch the **zenAmp** on by flipping the POWER switch and adjust it to the desired volume using the MASTER knob. Preset number 1 is always activated when you first power up the amp.

4. You can call up the first five user presets by pressing buttons 1 to 5.

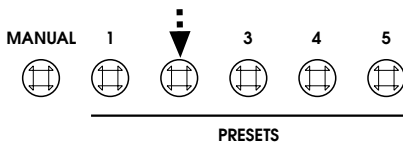

5. To call up the 25 factory presets, please proceed as follows:

- 5.1 Press and hold the MANUAL button until it begins flashing.

ca. 2 sec.

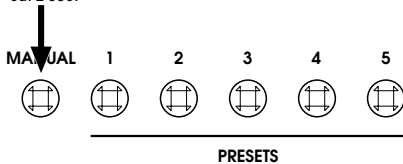

- 5.2 You can now activate individual factory sound banks 1 to 5 by pressing one of the preset buttons 1 to 5.

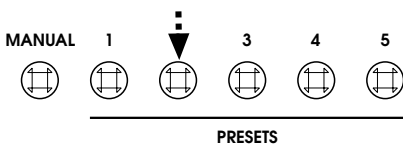

- 5.3 Individual presets in the respective bank are activated by pressing preset buttons 1 to 5 again.

6. To create a preset of your own, please proceed as follows:

- 6.1 Rotate the AMP TYPE knob to select the desired amp model.

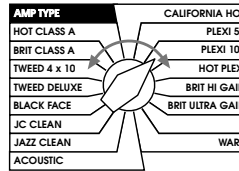

- 6.2 Adjust GAIN, BASS, MID, TREBLE and PRESENCE to taste and adjust the volume using the PRESET VOLUME knob.

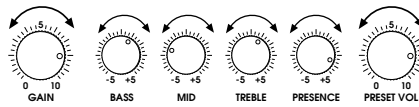

- 6.3 Select the desired effects via FX TYPE and/or DELAY TYPE and adjust FX PARAMETER, REVERB VOL, and/or DELAY VOL to taste.

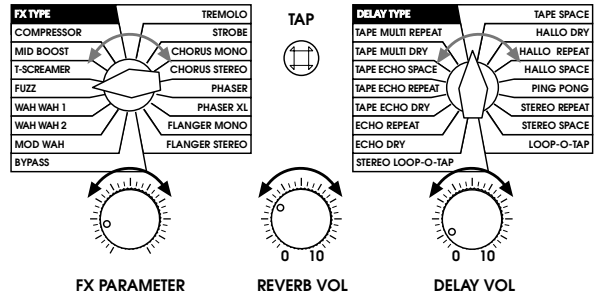

- 6.4 Press STORE, then one of the channel buttons, and then STORE again in order to store the sound that you have devised.

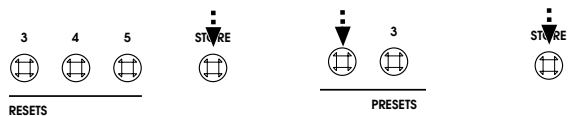

7. Press the MANUAL button in order to defeat the stored setting. MANUAL always enables the front panel knob settings (see chapter 4.2).



2.0 AMP MODELS

Note that Fender, Marshall, Vox, Mesa Boogie, Roland and other names of amp models and effects are the trademarks of their respective owners, and that they are in no way connected to or affiliated with Hughes & Kettner. Any mention of these brand names and trademarks serve merely purposes of explanation to describe sounds generated by Hughes & Kettner's proprietary Dynamic Sector Modeling technology.

You can select from among 16 different models of amps - herein called amp types - by rotating the zenAmp's AMP TYPE knob. Every amp type has a distinctive sonic personality. In addition to vintage milestones that literally made amp history, the zenAmp also offers emulations of some contemporary amps. In the following, we'll take a quick look at each amp type.

BLACK FACE (based on a Fender Twin)

This American beauty is the definitive amp for classic clean tone. Although you'd be hard-pressed to drive it into the distortion zone, its big sound and enormous punch left an indelible mark on several of styles of music - it even helped shape certain playing techniques. This piece of gear has won friends and influenced people far and wide, from funk rhythm kings to jazz masters, from blues howlers to country pickers.

Note that the BRIGHT function found on the original is integrated into the zenAmp's GAIN knob. GAIN settings of up to 5.0 (12 o'clock position) elicit that characteristic treble boost of the original's BRIGHT switch. The top end is not boosted at higher settings.

TWEED DELUXE (based on a Fender Deluxe)

The kid brother of the big tweed amp, its raw, throaty textures are held in high esteem by connoisseurs of vintage grit. A purist's dream come true, its simple yet brilliant circuitry delivers earthy, fat tweed tone unrivalled by any other amp. The original was equipped with just one tone knob, so we elected to assign a sound-shaping functionality to the 3-band EQ and the PRESENCE knob for this emulation. This gives you a lot more musically meaningful tweaking options without sacrificing the tone that makes this amp type so special.

TWEED 4x 10 (based on a Fender Bassman)

The ultimate vintage blues amp revered by almost all historic greats of the genre, it still spells bliss for many a modern-day blues blaster. The breadth and depth of its dynamic range and its fat, expressive lead tone are what made it famous. From squeaky clean to a throaty growl and all points in between, this amp puts meaning into the phrase "living on blues power."

BRIT CLASS A (based on a VOX AC 30)

The amp for classic guitar-driven pop and rock. Judging by the many stellar songwriters who appear on its reference list, this amp would undoubtedly be the hands-down winner in a poll of song-smiths. Unarguably, its EL84-loaded, Class A power amp delivers the sweetest harmonic distortion of all tube amps. And its flexible tone controls with the legendary Cut and Top Boost circuits elicit chiming, sparkling sounds as well as fat lead tone. Cranked wide open, it also delivers gritty, roots rock-approved goods.

Note that the zenAmp's PRESENCE knob takes over the CUT function. The Top Boost circuit is integrated into the MID knob, which is handy because this lets you dial smoothly rather than switch hard from Normal to Top Boost mode.

HOT CLASS A (based on a VOX AC 30)

This is specially tuned version of the above amp. In the past, only a handful of hot-rod specialists who are very handy with a screwdriver have been able to conjure up something similar to this sound. Our nickname for this sound is Black + More. Does that ring any bells? 'Nuff said.

CALIFORNIA HOT (a zenAmp special)

Using only the finest ingredients from the tube amp cookbook, our sonic sous-chefs whipped up a very special soup du jour: fat, creamy lead tone with a Californian nouvelle cuisine flavor unrivalled by any other series-made amp. Best of all, it takes just a twist of a knob to dial in this tasty sonic treat on the zenAmp and savor the rewards of modeling technology.

PLEXI 50 (based on a Marshall PLEXI, 50 Watt)

This British EL34-powered classic made music history. Many a genre-defining steel-string slinger wielded its considerable sonic clout to leave an indelible mark on the face of modern music. With its hair-trigger response, the PLEXI will do exactly what the position of your guitar's volume knob tells it to. Turn the volume down low, and you get fat, clean tone with shimmering top end. As you crank the knob, you can hear that vintage rock roar unfold.

PLEXI 100 (based on a Marshall PLEXI, 100 Watt)

The PLEXI on steroids, this 100-watt sensation literally rocked the late '60s and continued to dominate the heavy rock scene throughout the '70s and well into the '80s. A staple of innumerable rock productions, this amp's dynamic response made it the tool of choice for many an audio alchemist. Indeed, it can be said with some authority that this beast's big, cutting sound defined what great rock tone is all about. It will also make you the object of fear and loathing in your neighborhood, because you won't feel the full fury of its sonic assault until you crank it to the hilt.

HOT PLEXI (based on a Marshall PLEXI, 100 Watt)

The name says it all: This is what you get when a genuine guitar gear guru hot-rods a PLEXI 100: the ideal sound for those who like it hard & heavy, late 80s style.

BRIT HI GAIN (based on a Marshall JCM 2000)

A logical outgrowth of the razor-edged sound of British steel, this amp delivers gear-grinding overdrive and meltdown lead sounds with truckloads of sustain and in-your-face punch. The tone controls are tweaked to deliver the response of a modern-day boutique amp, adding many shades and hues to your sonic palette. Less subtly, its scooped mids elicit a merciless metal edge, while its over-the-top high end has been removed to peel paint at a hundred paces.

BRIT ULTRA GAIN (based on a Marshall JCM 2000)

What do you get when you unleash a horde of engineers brandishing screwdrivers - wild-eyed men who have spent far too much time in the lab - on an unsuspecting British amp? A snarling beast with a sound hot enough to roast weenies on. And, frankly, the result is awe-inspiring - the fattest and most creamy lead sound imaginable.

RECTIFIED (based on a Mesa Boogie Triple Rectifier)

This amp's peerless tone is the product of three rectifier tubes. A real firecracker, it throws red-hot sparks of distortion for a fresh, dynamic tone. With its fat, bad and downright angry overdrive, this amp can take on many guises. Playing a key role in the rise of grunge in the '90s, it has since become the tool of choice for New Metal merchants. And with good reason, for few other amps can match its intensity and depth of musical expression, particularly for soloing.

WARP (based on a Hughes & Kettner WARP 7)

Welcome to the seventh circle of sonic hell. If the descriptive adjective of choice for the RECTIFIED model is "bad", then the WARP is downright evil. This amp was designed specifically to do the sound, vibe and feel of detuned guitars justice. If you like your tone best when it comes wrapped in a hard and heavy package sound with enamel-blistering bottom end, this model is just what the doctor ordered. On the grounds of its ability to deliver everything from an intimidating rumble to a malicious roar, there is plenty of justification for calling the WARP 7 the prince of darkness among amps.

ACOUSTIC AMP (based on a Hughes & Kettner Montana)

This is the DSM version of the Montana, Hughes & Kettner's proprietary acoustic amp.

JAZZ CLEAN (based on a Hughes & Kettner ATS 112)

With the debut of the ATS series back in the '80s, Hughes & Kettner ushered in the great era of hybrid amps. Wedding the advantages of tube technology to low-cost solid state engineering, the ATS 112 - particularly its clean channel - soon became the darling of many jazz guitarists. As a unique feature, it sported a volume knob with an integrated compressor (!) that made for a very warm sound replete with oodles of sustain.

JC CLEAN (based on a Roland Jazz Chorus)

The forebear of this model was esteemed for its crystal-clear sound. Note that when you crank the treble knob, in addition to a generous helping of top-end shimmer, you are adding the kind of punch known to part hair to 50 paces. Conversely, when you back off the treble knob, you get a very soft and round jazz tone.

3.0 STANDARD SETUP/CABLE CONNECTIONS

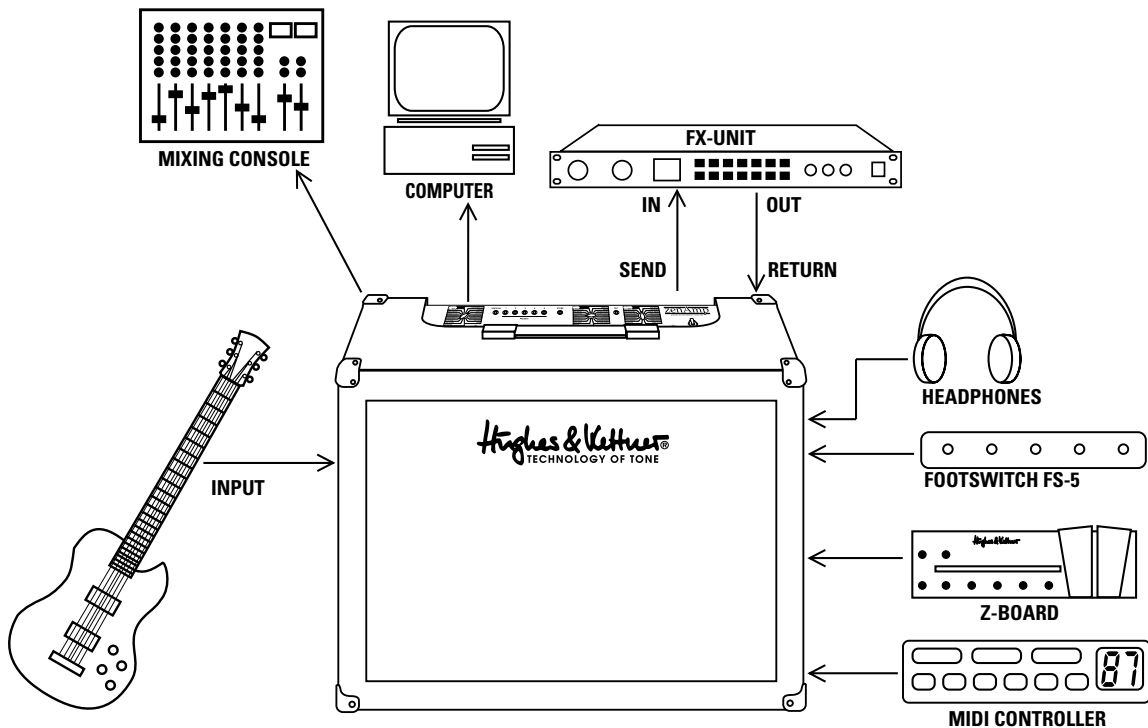

4.0 JACKS AND CONTROL FEATURES

4.1 OVERVIEW

The zenAmp's user panel is essentially divided into two segments, the amp section and the effects section.

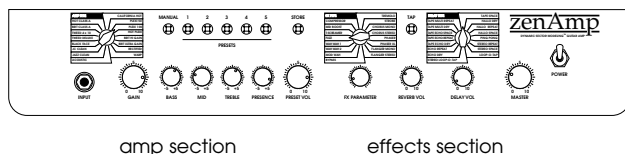

amp section

effects section

The amp section features a classic, tried-and-true layout. The GAIN, BASS, MID, TREBLE, PRESENCE and PRESET VOL VOLUME knobs work like the control features of an analog amp. The knobs of the selected amp type respond just like those on the original model, which means that in this respect the zenAmp handles exactly like its analog forebears. In some cases, it gives you additional tweaking options beyond those of the original. You'll find that in each case, the extra sound-shaping options make a great deal of musical sense.

The AMP TYPE selector calls up a total of 16 models.

In the amp section, you'll also find the PRESET buttons 1 to 5 for calling up stored presets. For the record, a preset is comprised of all amp and effect settings that shape a stored sound.

The effects section puts eight modulation effects as well as emulations of some classic stomp boxes at your disposal. These are accessible via the FX TYPE selector. In addition, it offers 16 delay effects as well as one spring reverb. You'll find it easy to dial in satisfactory sounds without a great deal of editing.

Use the 16-way selector to activate modulation and delay effects. REVERB VOL and DELAY VOL control the amount of reverb and delay in the signal. FX PARAMETER lets you adjust effects dialed in via FX TYPE.

4.2 GOOD-TO-KNOW STUFF: THE TWO MODES!

After you power the zenAmp up, it is automatically in Preset mode. This means that the amp's current knob positions do not influence its sound. Instead, what you hear is determined by the stored amp and effect settings of the given preset. Say, for example, the preset's stored BASS knob setting is 5, while the physical BASS knob setting on the zenAmp is 0. The sound you will hear is shaped by the stored rather than the physical setting.

As soon as you change a parameter on the amp (say by tweaking the BASS knob) while the amp is in Preset mode, you'll hear this parameter "jump" from its stored setting to the new setting.

Note: Be advised that when you select another amp type while the amp is in Preset mode, the current preset's tone control settings are overwritten by new settings that make sense in the context of the newly selected amp type.

In Manual mode, the amp handles quite differently. When you activate this mode by pressing the MANUAL button, the current knob positions on the zenAmp's front panel are enabled and they shape your tone. This is the mode to use for creating your own presets. You can return to Preset mode by pressing the MANUAL button again.

4.3 JACKS AND CONTROL FEATURES IN DETAIL

FRONT PANEL

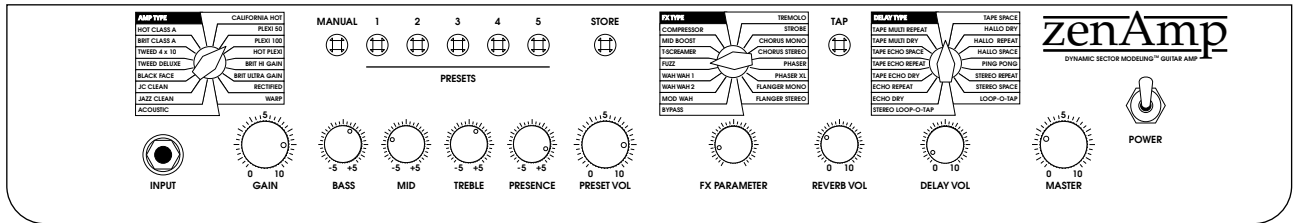

INPUT: Connect your electric guitar or pick-up-equipped acoustic guitar to this input (it accepts all input levels).

GAIN: This knob serves different purposes depending on the selected amp type:
Some of the original models (BLACK FACE, TWEED DELUXE) don't come with a master volume. For this breed of amp, GAIN responds just like a regular volume knob.
For models that are equipped with both gain and master knob, the GAIN knob serves the same purpose as the gain knob on the original.

AMP TYPE: Rotate this knob to select from among the 16 amp types.

tone Controls: BASS, MID, TREBLE and PRESENCE knobs. These knobs work like those on the original amp and their response depends on the amp type that you have selected. Because some of the original amps don't have a presence knob or a 3-band EQ, the zenAmp's knobs are assigned special functions to replicate all of the originals' tweaking options (for an in-depth explanation of this, see 2.0 AMP MODELS).

PRESET VOL: Controls preset volume. Unlike the setting of the power amp MASTER knob located on the far right, you can store this parameter. This handy feature lets you dial in the desired balance of the relative levels for all presets.

MANUAL: Press this button to activate Manual mode (see also section 4.2 above). The current settings of all knobs are enabled – what you see is what you hear.

Heads up, though! The MANUAL button also lets you switch between the sound banks of the zenAmp manually when you press and hold it down for a bit. To learn more about this, please read the next section entitled PRESETS.

PRESETS 1 to 5: These knobs perform two functions:
For one, they are used to call up stored user presets and factory presets. To this end, proceed as follows:

- 1) Activate the five presets of a sound bank by pressing the Preset buttons.
- 2) To switch sound banks, press and hold the MANUAL button until it starts flashing.
- 3) Select the sound bank by pressing one of the PRESET buttons
- 4) Activate the presets 1 to 5 of this bank by pressing the PRESET buttons again.

For the other, these buttons serve to store new presets. To learn more about this, read the following section entitled STORE.

Note: On the zenAmp, you can call up 30 presets - including five user presets - manually. The optionally available Z-Board increases the number of manually accessible presets to 125, 100 of which are user presets.

Note also: To go from the sound banks holding the factory presets back to the five user presets, briefly press the MANUAL button. This switches the zenAmp to Manual mode (see section 4.2 above). Briefly press the MANUAL button again to switch to Preset mode, which lets you access the user presets. The optional Z-Board is of course a far more convenient option for switching modes and presets.

STORE: It saves preset settings.
Here's how this works: Press the STORE button. It lights up red. Select the desired memory slot by pressing one of the PRESET buttons 1 to 5.
The preset is stored when you press STORE again. This overwrites the preset that was previously stored in the selected memory slot.

Note: You can cancel the storage process at any time by pressing the MANUAL button.

Note also: You can of course also navigate to the desired memory slot via the optional Z-Board.

FX TYPE: This selector puts eight modulation effects, seven pre effects (meaning effects that plug into the front end of the amp) such as wah-wah, and a bypass at your fingertips. Simply turn the rotary selector to select effects.

FX PARAMETER: Controls the parameters of the effect that you select using the FX TYPE knob. Since most of the effects offer at least two parameters, this knob actually gives you musically meaningful combinations of these parameters.
Case in point: Say you select the chorus effect. When the FX PARAMETER knob is set to a low value, the chorus' rate is low, but its intensity or amount is high. As you turn the knob up, the rate increases while intensity decreases.

REVERB VOL: It determines the amount of reverb that is added to the signal.

TAP: This button lets you enter in delay time manually. Simply tap in the desired tempo. The zenAmp gauges the time between taps and synchronizes the delay accordingly. TAP will of course only work when a delay effect is active.

DELAY TYPE: Turn this rotary selector to choose from among the 16 different delay effects. This effects section can also be bypassed (see DELAY VOL).

DELAY VOL: It controls the volume of the delay effect selected via DELAY TYPE. The delay effect is bypassed when the knob is set to the far left position.

MASTER: It controls the overall volume level of the power amp. This knob is global, meaning that it affects all presets. Its setting cannot be stored.

REAR PANEL

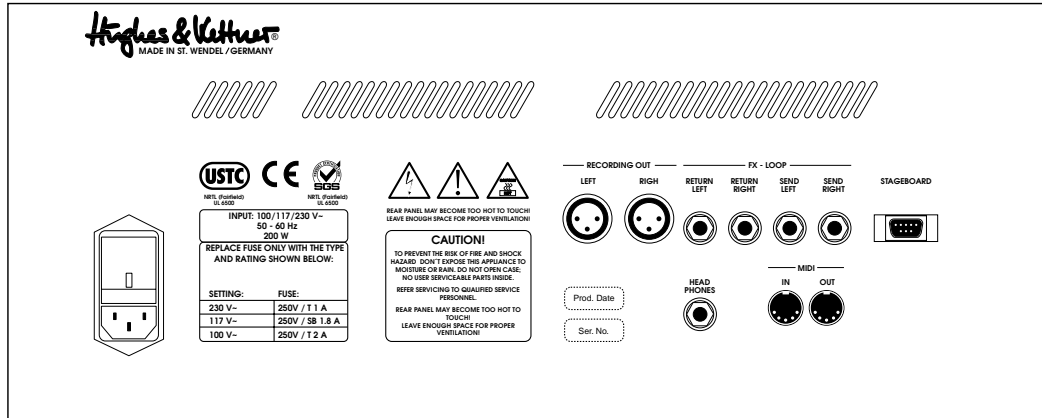

MAINS IN: Connect the factory-included mains cord to this socket. Ensure the amp's voltage rating matches your local AC voltage rating before you plug the cord into the wall socket. The mains fuse bracket is located next to this socket (see also Section 8.2). When replacing blown fuses, make sure you use specified replacement fuses only (see 7.0 TECHNICAL SPECIFICATIONS).

RECORDING OUT: Analog stereo output for connecting the zenAmp to a mixing console for recording and live applications. The RECORDING OUT circuit sends a signal that has been processed using the amp's integrated speaker simulation.

Note: The EFFECTS LOOP is located pre or in front of the RECORDING OUT bus. This means that if you have plugged an external effect device into the zenAmp, this device will affect the RECORDING OUT signal.

EFFECTS LOOP: Serial stereo/stereo insert for connecting external effect devices. In the signal chain, the EFFECTS LOOP is located pre or in front of the MASTER knob and RECORDING OUT.

Note: Bear in mind that the overall sound quality depends to a considerable extent on the quality of the external effect device because in a serial loop such as this, the entire signal is routed through the outboard device.

SEND: Connect this output to the input of your effect device. Unlike the RECORDING OUT bus, SEND jacks patch out signals without speaker simulation. This means that they may also be used as a line out for routing signals to external power amps.

Note: If you use an effect device that is equipped with merely a mono input, the entire stereo signal will be carried in mono. For this reason, we recommend that you use an external effect device sporting stereo inputs.

RETURN: Connect the outputs of your effects device to these jack. You can also use the RETURN jacks to connect an external signal source such as an audio playback device. However, keep in mind that in this case, the zenAmp's signal is muted. This means that if you patch in an external signal here, you can't play along with it over the zenAmp.

HEADPHONES: Connect headphones to this jack. Like the RECORDING OUT bus, this circuit features speaker simulation.

Note that the internal loudspeakers are automatically disabled when you plug in headphones. Use the MASTER knob to adjust headphones volume.

STAGE BOARD: 9-pin port designed to take the optional Hughes & Kettner Z-Board or the optional FS-5, a 5-way foot switch.

Note: This is not an interface for connecting a PC.

MIDI IN/OUT: Connect a standard MIDI board here. It also serves as the interface for loading software updates and creating backups for your presets.

Pin function

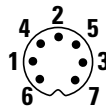

- 1: n.c.
- 2: shield
- 3: n.c.
- 4: current source
- 5: current sink

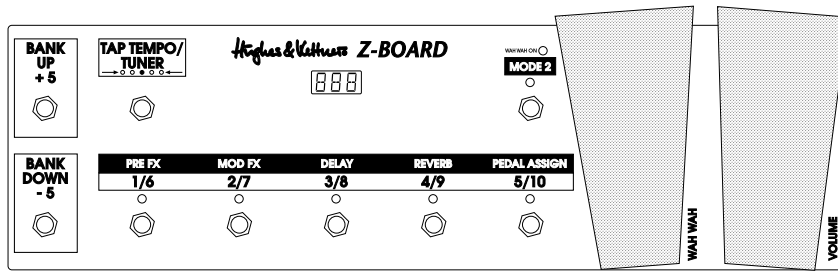

4.4 THE ZENAMP AND THE Z-BOARD

The Z-Board gives you remote control over of the essential functions of your **zenAmp** in gig situations.

PLUGGING IN

Do not switch your amp on. Plug the 9-pin connector into the corresponding port on your amp. Ensure that the VOLUME pedal is floored. This will spare you unnecessary troubleshooting a little later. Switch your amp on.

HANDLING

BASICS

The range of functions that the Z-Board puts at your disposal depends on the given model and software version of your Hughes & Kettner amp. Not all models and versions support all functions described in this owner's manual.

THE 2 MODES

The Z-Board works in 2 different modes, Preset mode and MODE 2 (effect mode). You can switch between these two modes using the MODE 2 button.

In Preset mode, you can activate presets that have been programmed on the amp. BANK UP/DOWN accesses the next higher or lower sound bank (for the record, a bank consists of a group of five presets). Once you have selected the desired bank, the 1/6 to 5/10 buttons let you call up the presets of that bank.

In MODE 2, you can activate and deactivate effects. The PEDAL ASSIGN button lets you assign individual parameters of your amp to the WAH WAH pedal. This lets you control the given parameter in real time.

CONTROL FEATURES

VOLUME

You can control the master volume level and the pre-effect section channel volume, using the VOLUME pedal.

WAH WAH

The WAH WAH pedal can perform two functions:

- 1) It controls the wah-wah effect. Push the pedal all the way down. The WAH WAH ON LED lights up to tell you the wah-wah effect is activate.
- 2) In MODE 2, the pedal can also control an amp parameter that has been assigned to it, for example, gain, bass, mid, treble, preset volume as well as effect parameters. (for more info, see the section below entitled PEDAL ASSIGN).

BANK UP

In Preset mode, it switches to the next higher sound bank (= group of five presets), in MODE 2, to the next higher preset.

BANK DOWN

in Preset mode, it switches to the next lower sound bank, in MODE 2 to the next lower preset.

1/6 – 5/10 and PRE FX, MOD FX, DELAY, REVERB, PEDAL ASSIGN

These buttons carry out two functions:

In Preset mode, buttons 1/6 - 5/10 serve to select a preset, that is to say, to switch the desired preset of the activated sound bank on. The red LEDs indicate the selected preset.

In MODE 2, the PRE FX, MOD FX, DELAY, and REVERB buttons serve to switch effects off and on. The red LEDs indicate the selected effects.

The PEDAL ASSIGN button performs a special function in MODE 2. When it is activate (the red LED lights up), you can assign various amp parameters such as gain, bass, mid, treble, etc. or effect, parameters such as delay time, chorus rate, reverb volume, etc. to the WAH WAH pedal.

All it takes to select a parameter is a slight twist of the corresponding knob on the amp. Assign it to the pedal by pressing the PEDAL ASSIGN button again.

MODE 2

Switches back and forth between Preset mode and MODE 2 (effect mode).

DISPLAY

It shows the currently selected Preset or, when the Tuner function is activated, the pitch of the plucked string. The following table provides an overview of the notes that appear in the display when you are tuning.

International scale	German scale	Display
C	C	c
D flat	Des	db
D	D	d
E flat	Es	Eb
E	E	E
F	F	F
G flat	Ges	Gb
G	G	G
A flat	As	Ab
A	A	A
B flat	B	bb
B	H	b

TAP TEMPO/TUNER

This button lets you determine delay time. Simply tap in the desired delay time with your foot. The red LED will flash at the tempo you determine.

Note: This of course will only work if you have activated a delay effect.

To activate the TUNER function, press and hold the button for a bit longer.

The note of the plucked string is indicated in the display.

The actual pitch for tuning is indicated by the LEDs above the 1/6 - 5/10 buttons. When the 3/8 button's red LED lights up, the string is tuned to the proper pitch.

5.0 MAINTENANCE AND CARE

The **zenAmp** does not require service of any type. There are however a few basic rules that will extend the service life of your amp enormously:

- Make sure all peripheral devices, cords and cables are in a state of good repair! Poor-quality cables will cause hum and undesirable noise.
- Ensure plenty of air can circulate around your amp's ventilation ducts at all times.
- Definitely avoid exposure to mechanical shocks and extreme heat, dust and particularly moisture.
- Be picky about the kind of peripheral devices you connect to your amp and always check out their specs before you plug them in. Under no circumstances should you connect devices with high output signal levels (e.g. power amps) to your amp's input.
- Be sure the AC power source delivers the current that your amp is designed to handle before you plug it in. When in doubt about the local rating, ask the venue's sound technician or a stage hand.
- Refrain from DIY repairs! To be on the safe side, you should also have a qualified technician replace internal fuses.

6.0 TROUBLESHOOTING

E1) The zenAmp won't power up when you switch it on:

- It's not getting AC power. Check the mains cable to see if it is connected properly!
- The mains fuse is defective. Replace the fuse with another identical fuse. If this fuse also blows, be sure to talk to your local Hughes & Kettner dealer.

E2) The zenAmp is cabled up and connected properly, but no sound is audible.

- One or more of the volume or master knobs is/are turned all the way down. Dial in higher settings.
- The volume pedal of the connected Z-Board is set to the minimum position. Floor the pedal.

E3) The zenAmp will not respond to the Z-Board or footswitch.

- The connector of the Z-Board or footswitch is not plugged in correctly or at all. Plug it into the **zenAmp**, ensuring that it is seated firmly.

E4) The sound is totally distorted when you activate a connected effects device.

- The input of the effect device is being overdriven. If it is equipped with a level meter or other level indicator, check the signal level and back off the signal processor's input sensitivity (via a knob labeled "Input" or "Gain").

E5) The signal level drops considerably when you connect an external effects device,

- The effect device is sending the signal back at too low a level. Turn up the signal processor's output level.

7.0 TECHNICAL SPECIFICATIONS

PREAMP SECTION

INPUT	-10 dBV / 1 M ohms
FX RETURN L/R	0 dBV / 10 K ohms
FX SEND L/R	0 dBV / 220 ohms
RECORDING OUT L/R	0 dBV / 220 ohms

POWER AMP SECTION

Output power	2 x 60 watts into 8 ohms
Frequency response	20 Hz - 20 kHz
Loudspeaker	1x 12" Celestion® Vintage 30, 8 ohms 1x 12" Celestion® RockDriver Junior, 8 ohms
Headphones out	500 mW into 4 - 600 ohms

GENERAL

Mains voltage	230 volts AC (European version) 117 volts AC (North American version) 100 volts AC (Japanese version)
Max. power consump.	200 VA
Mains fuse	T 1 A (230 V model) T 1.8 A (117 V model) T 2 A (100 V model)
Internal fuses	1x 500 mA Polyswitch (Stageboard) 2x T 2 A (Analog section) 1x T 630 mA (DSP section)
Dimensions (W x H x D)	650 x 500 x 270 mm
Weight	21 Kg

8.0 APPENDIX

8.1 MIDI IMPLEMENTATION CHART

MIDI Implementation Chart v. 2.0 (page 1 of 3)			
Manufacturer: Hughes & Kettner		Model: ZenAmp	Version: 1.00 Date: 29.03.01/AP
	Transmitted	Recognized	Remarks
1. Basic Information			
MIDI channels	1	1	
Note Numbers	-	-	
Program Change	Yes	Yes	
Bank Select Response? (Yes / No) If yes, list banks utilized in remarks column			
Modes supported: Mode 1:Omni-On, Poly (Yes/No) Mode 2:Omni-On, Mono (Yes/No) Mode 3:Omni-Off, Poly (Yes/No) Mode 4:Omni-Off, Mono (Yes/No) Multi Mode (Yes/No)			Mode 3 / 4: Omni Off
Note-On Velocity (Yes/No)	No	No	
Note-Off Velocity (Yes/No)	No	No	
Channel Aftertouch (Yes/No)	No	No	
Poly (Key) Aftertouch (Yes/No)	No	No	
Pitch Bend (Yes/No)	No	No	
Active Sensing (Yes / No)	No	No	
System Reset (Yes / No)	No	No	
Tune Request (Yes / No)	No	No	
System Exclusive: Sample Dump Standard (Yes/No) Device Inquiry (Yes/No) File Dump (Yes/No) MIDI Tuning (Yes/No) Master Volume (Yes/No) Notation Information (Yes/No) Turn GM1 System On (Yes/No) Turn GM2 System On (Yes/No) Turn GM System On (Yes/No) Other (note in Remarks column)	No No No No No No No No No No Yes	No No No No No No No No No No Yes	Data Dumps for Firmware Update Preset Transfers See Appendix
NRPNs (Yes/No)	No	No	
RPN 00 (Pitch Bend Sensitivity) (Yes / No)	No	No	
RPN 01 (Channel Fine Tune) (Yes/No)	No	No	
RPN 02 (Channel Coarse Tune) (Yes/No)	No	No	
RPN 03 (Tuning Program Select) (Yes/No)	No	No	
RPN 04 (Tuning Bank Select) (Yes/No)	No	No	
RPN 05 (Modulation Depth Range) (Yes/No)	No	No	
2. MIDI Timing and Synchronisation			
MIDI Clock (Yes/No)	No	No	
Song Position Pointer (Yes/No)	No	No	
Song Select (Yes/No)	No	No	
Start (Yes/No)	No	No	
Continue (Yes/No)	No	No	
Stop (Yes/No)	No	No	
MIDI Time Code (Yes/No)	No	No	
MIDI Machine Control (Yes/No)	No	No	
MIDI Show Control (Level/No)	No	No	
3. Extensions Compatibility			
General MIDI compatible? (Level(s)/No) Is GM default power-up mode? (Level/No)		No	
DLS compatible (Level(s)/No) Import DLS Files? (Type(s)/No) Export DLS Files? (Type(s)/No)		No	
Import Standard MIDI Files (Type(s)/No) Export Standard MIDI Files (Type(s)/No)		No	
NOTES			

MIDI Implementation Chart v. 2.0 (page 2 of 3)

Manufacturer: Hughes & Kettner

Model: ZenAmp

Version: 1.00

Date: 29.03.01/AP

Controller #	Function	Transmitted (Y/N)	Recognized (Y/N)	Remarks
0	Bank Select (MSB)	No	No	
1	Modulation Wheel (MSB)	No	No	
2	Breath Controller (MSB)	No	No	
3				
4	Foot Controller (MSB)	No	No	
5	Portamento Time (MSB)	No	No	
6	Data Entry (MSB)	No	No	
7	Channel Volume (MSB)	No	No	
8	Balance (MSB)	No	No	
9				
10	Pan (MSB)	No	No	
11	Expression (MSB)	No	No	
12	Effect Control 1 (MSB)	No	No	
13	Effect Control 2 (MSB)	No	No	
14				
15				
16	General Purpose Controller 1 (MSB)	No	No	
17	General Purpose Controller 2 (MSB)	No	No	
18	General Purpose Controller 3 (MSB)	No	No	
19	General Purpose Controller 4 (MSB)	No	No	
20				
21				
22				
23				
24				
25				
26				
27				
28				
29				
30				
31				
32	Bank Select (LSB)	No	No	
33	Modulation Wheel (LSB)	No	No	
34	Breath Controller (LSB)	No	No	
35				
36	Foot Controller (LSB)	No	No	
37	Portamento Time (LSB)	No	No	
38	Data Entry (LSB)	No	No	
39	Channel Volume (LSB)	No	No	
40	Balance (LSB)	No	No	
41				
42	Pan (LSB)	No	No	
43	Expression (LSB)	No	No	
44	Effect Control 1 (LSB)	No	No	
45	Effect Control 2 (LSB)	No	No	
46				
47				
48	General Purpose Controller 1 (LSB)	No	No	
49	General Purpose Controller 2 (LSB)	No	No	
50	General Purpose Controller 3 (LSB)	No	No	
51	General Purpose Controller 4 (LSB)	No	No	
52				
53				
54				
55				
56				
57				
58				
59				
60				
61				
62				
63				

MIDI Implementation Chart v. 2.0 (page 3 of 3)

Manufacturer: Hughes & Kettner

Model: ZenAmp

Version: 1.00

Date: 29.03.01/AP

Controller #	Function	Transmitted (Y/N)	Recognized (Y/N)	Remarks
64	Sustain Pedal	No	No	
65	Portamento On/Off	No	No	
66	Sostenuto	No	No	
67	Soft Pedal	No	No	
68	Legato Footswitch	No	No	
69	Hold 2	No	No	
70	Sound Controller 1 Sound Variation	No	No	
71	Sound Controller 2 Timbre	No	No	
72	Sound Controller 3 Release Time	No	No	
73	Sound Controller 4 Attack Time	No	No	
74	Sound Controller 5 Brightness	No	No	
75	Sound Controller 6 Decay Time	No	No	
76	Sound Controller 7 Vibrato Rate	No	No	
77	Sound Controller 8 Vibrato Depth	No	No	
78	Sound Controller 9 Vibrato Delay	No	No	
79	Sound Controller 10	No	No	
80	General Purpose Controller 5	No	No	
81	General Purpose Controller 6	No	No	
82	General Purpose Controller 7)	No	No	
83	General Purpose Controller 8	No	No	
84	Portamento Control	No	No	
85				
86				
87				
88				
89				
90				
91	Effects 1 Depth Reverb Send Level	No	No	
92	Effects 2 Depth	No	No	
93	Effects 3 Depth Chorus Send Level	No	No	
94	Effects 4 Depth	No	No	
95	Effects 5 Depth	No	No	
96	Data Increment	No	No	
97	Data Decrement	No	No	
98	Non-Registered Parameter N. (LSB)	No	No	
99	Non-Registered Parameter N. (MSB)	No	No	
100	Registered Parameter Number (LSB)	No	No	
101	Registered Parameter Number (MSB)	No	No	
102				
103				
104				
105				
106				
107				
108				
109				
110				
111				
112				
113				
114				
115				
116				
117				
118				
119				
Channel Mode Messages				
120	All Sound Off	No	No	
121	Reset All Controllers	No	No	
122	Local Control On/Off	No	No	
123	All Notes Off	No	No	
124	Omni Mode Off	No	No	
125	Omni Mode On	No	No	
126	Poly Mode Off	No	No	
127	Poly Mode On	No	No	

8.2 AC POWER AND THE GLOBAL CURRENT ADAPTER

NOTE: Before plugging into the wall socket, make certain the amp is set to the proper voltage for your locale. You can read the amp's voltage setting in the Voltage Selector window found on the back of the unit. Also check the fuse specifications printed above the amp's power cord socket, and ensure that the fuses you are using have the correct value for your local current.

zenAmp can operate at AC currents of 230 volts, 117 volts or 100 volts. Use the VOLTAGE SELECTOR to adjust the voltage accordingly (see Diagram 1):

- Press the fuse's safety latch (1) towards the window (3) with a small screwdriver and remove it with the two fuses.
- Pull the cartridge (4) out of its socket.
- Rotate the cartridge (4) and plug it back into the socket so the desired voltage is legible.
- Replace the previously mounted fuses (5). Make certain the values of your fuses are identical to those required for your local voltage. The values are specified above the amp's power cord socket.
- Reinsert the fuse cartridge (2) with the new fuses (5).
- Before you plug into the wall socket, check again to ensure the correct voltage rating is legible in the VOLTAGE SELECTOR window (3)

8.2 NETZANSCHLUSS UND WELTSPANNUNGSADAPTION

HINWEIS: Stellen Sie bitte vor dem Anschluss des zenAmp sicher, daß die vorhandene Netzspannung mit dem im Sichtfenster des VOLTAGE SELECTORS angegebenen Spannungswert übereinstimmt. Überprüfen Sie auch die Sicherungswerte entsprechend dem Aufdruck nahe der Anschlußbuchse.

Der zenAmp kann an den Netzspannungen 230 V, 117 V und 100 V betrieben werden. Die Anpassung erfolgt mittels des in die Netzbuchse integrierten VOLTAGE SELECTORS. Dazu wird wie folgt vorgegangen (siehe Abb.1):

- Mittels eines kleinen Schraubendrehers die Sperre (1) des Sicherungshalters in Richtung Sichtfenster (3) drücken und diesen zusammen mit den beiden Sicherungen herausziehen.
- Den Steckensatz (4) herausziehen.
- Der Steckensatz (4) wird so gedreht und wieder eingesteckt, daß der Aufdruck der gewünschten Netzspannung nach außen zeigt.
- Die vorher montierten Sicherungen (5) werden ersetzt. Verwende nur den nahe der Anschlußbuchse aufgedruckten Sicherungswert, der für die neue Netzspannung vorgesehen ist!
- Den Sicherungshalter (2) zusammen mit den neuen Sicherungen (5) einsetzen.
- Vor dem Netzanschluß nochmals prüfen, ob der richtige Spannungswert im Sichtfenster (3) des VOLTAGE SELECTORS erkennbar ist.

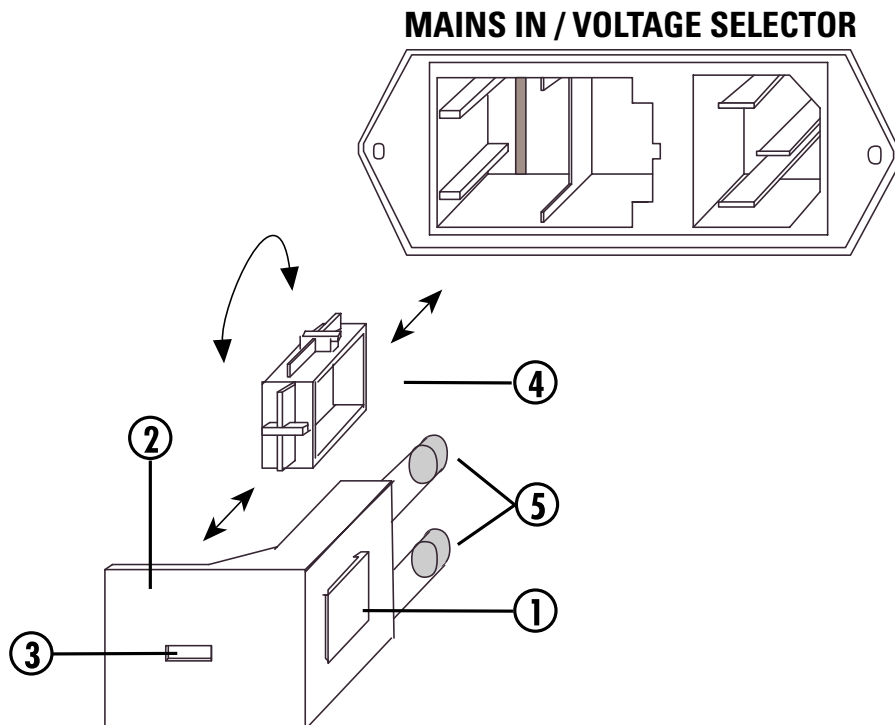

Free Manuals Download Website

<http://myh66.com>

<http://usermanuals.us>

<http://www.somanuals.com>

<http://www.4manuals.cc>

<http://www.manual-lib.com>

<http://www.404manual.com>

<http://www.luxmanual.com>

<http://aubethermostatmanual.com>

Golf course search by state

<http://golfingnear.com>

Email search by domain

<http://emailbydomain.com>

Auto manuals search

<http://auto.somanuals.com>

TV manuals search

<http://tv.somanuals.com>