

DiRECWAY[®]

Installation Manual for .74 m Ku-band Antenna Model AN4-074-DF

For Consumer Installations

1035567-0001
Revision A
October 31, 2005

Copyright © 2004, 2005 Hughes Network Systems, LLC

All rights reserved. This publication and its contents are proprietary to Hughes Network Systems, LLC. No part of this publication may be reproduced in any form or by any means without the written permission of Hughes Network Systems, LLC, 11717 Exploration Lane, Germantown, Maryland 20876.

Hughes Network Systems, LLC has made every effort to ensure the correctness and completeness of the material in this document. Hughes Network Systems, LLC shall not be liable for errors contained herein. The information in this document is subject to change without notice. Hughes Network Systems, LLC makes no warranty of any kind with regard to this material, including, but not limited to, the implied warranties of merchantability and fitness for a particular purpose.

Trademarks

HUGHES, HUGHES NETWORK SYSTEMS, and DIRECWAY are trademarks of Hughes Network Systems, LLC. All other trademarks are the property of their respective owners.

Important safety information

For your safety and protection, read this entire installation manual before you attempt to install the satellite antenna. In particular, read this safety section carefully. Keep this safety information where you can refer to it if necessary.

Types of warnings used in this manual

This section introduces the various types of warnings used in this manual to alert you to possible safety hazards.

DANGER



Indicates an imminently hazardous situation, which, if not avoided, will result in death or serious injury.

WARNING



Indicates a potentially hazardous situation, which, if not avoided, could result in death or serious injury.

CAUTION



Indicates a potentially hazardous situation, which, if not avoided, may result in minor or moderate injury.

CAUTION

Indicates a situation or practice that might result in property damage.

Product warning labels

The following safety alert label is affixed to each side of the satellite antenna feed arm:

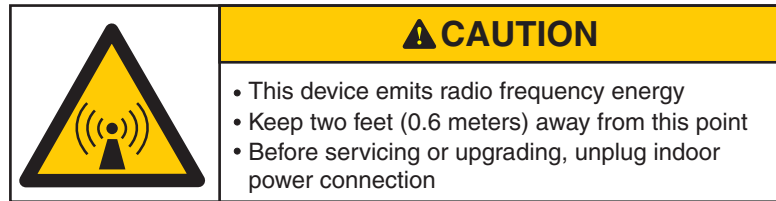

T0145005

This label advises that the antenna emits radio frequency (RF) energy. Because of this potential safety hazard, observe all cautions in the following section (*Antenna installation safety*) concerning RF radiation.

Antenna installation safety

Observe the following precautions when installing the satellite antenna. This manual also includes additional safety alerts where appropriate concerning specific installation procedures.

⚠ WARNING



Only HNS-certified installers may install or service DIRECWAY earth stations and components. All HNS-certified installers must expressly acknowledge the HNS requirements for DIRECWAY installations.

⚠ DANGER

If you work on a roof, tower, or other high structure or use a ladder or scaffold to access the work site, follow these precautions to prevent personal injury or death:



- Walk only on sound roof structures.
- Make sure the antenna assembly and installation surface are structurally sound so they can support all loads (equipment weight, ice, and wind).
- Use appropriate safety equipment (for example, a lifeline), depending on the work location.
- Follow all safety precautions from the manufacturers of all safety equipment and other equipment used.
- Perform as many procedures as possible on the ground.

 **DANGER**

- To avoid electric shock, stay at least 20 ft from power lines.
- If any part of the antenna or mount assembly comes in contact with a power line, call your local power company to remove it. *Do not try to remove it yourself.*

Failure to heed these warnings could result in serious injury or death.

 **WARNING**

- Do not work in high wind or rain or if a storm, lightning, or other adverse weather conditions are present or approaching.
 - Do not attempt to assemble, move, or mount the antenna on a windy day. Even a slight wind can create strong, unexpected forces on the antenna surface.
-

CAUTION

Observe these precautions to avoid exposure to RF radiation, a potential safety hazard:

- The antenna must be installed in a location or manner not readily accessible to children and in a manner that prevents human exposure to potentially harmful levels of radiation.
- Antennas mounted in Puerto Rico, the continental United States, or at any site with greater than a 30° elevation angle must be installed such that the lower lip of the antenna reflector is at least 5 ft above any surface upon which a person might be expected to stand, and 3 ft 3 in. from any opening (such as a door or window) in a building or adjacent structure.
- Antennas mounted in Canada, Alaska, Hawaii, or any site with less than a 30° elevation must be installed such that the lower lip of the antenna reflector is at least 5 ft 9 in. above any surface upon which a person might be expected to stand, and 3 ft 3 in. from any opening (such as a door or window) in a building or adjacent structure.
- The antenna must be mounted such that no object which could reasonably be expected to support a person is within 6 ft 7 in. of the edges of a cylindrical space extending from the antenna reflector.
- If the above distance requirements cannot be met, the antenna must be mounted in a controlled area inaccessible to the general public, such as a fenced enclosure or a roof.
- The antenna must be mounted such that there is no object outside the controlled area which could reasonably be expected to support a person within 6 ft 7 in. of the edges of a cylindrical space extending from the antenna reflector.
- A fenced installation must have a locked entry, and the fenced area must be large enough to protect the general public from exposure to potentially harmful levels of radiation.



Failure to observe these cautions could result in injury to eyes or other personal injury.

 **CAUTION**



- All installations of any type or size must carry an industry standard and government approved *Radiation Hazard Caution* label on the feed arm.
- A fenced or roof installation in a commercial, industrial, or institutional environment must carry a *Radiation Hazard Caution* sign on the access door, gate, or permanently mounted access ladder that is within plain sight of anyone approaching the antenna from the front or sides of the reflector.

Failure to observe these cautions could result in injury to eyes or other personal injury.

Some installations may require additional precautions. See also the *Antenna Site Preparation and Mount Installation Guide* (HNS 1035678-0001).

Contents

Important safety information	iii
Types of warnings used in this manual	iii
Product warning labels	iv
Antenna installation safety	iv
About this document	xv
Scope and audience	xv
Organization	xv
Revision record	xvi
Chapter 1	
Overview	1
Broadband satellite system components	1
Antenna installation overview	3
Tasks related to antenna installation	4
Selecting the installation site	4
Installing the antenna mount	4
Grounding	4
Cables and cabling	4
Chapter 2	
Antenna parts and required tools	5
Antenna kit components	5
Az/El cap and collar	6
Antenna reflector	6
Feed arm and radio	7
Trimast (or other antenna mount)	8
Optional shroud	8
Small hardware list	9
Tools	10
Chapter 3	
Installing the radio and antenna assemblies	11
Determining the pointing values	12
Assembling the Az/El cap	13
Installing the Az/El cap onto the antenna	15
Adjusting elevation	16
Adjusting polarization	18
Installing the fine elevation pointing tool	20

Installing a shim for vertical transmit polarization	21
Installing the radio assembly on the feed arm	25
Connecting the feed arm to the antenna reflector.	26
Installing the antenna assembly onto the mast.	28
Attaching the optional shroud	29

Chapter 4

Cabling and connections31

Routing the cables at the ODU.	32
Connecting the transmit and receive cables	33
Transmit cable	33
Receive cable	34
Ground connection	35

Chapter 5

Pointing the antenna37

Antenna pointing overview	38
Using the installation software.	38
Peaking the signal.	38
Personnel requirements	39
Pointing parameters	39
Outdoor pointing interface	39
OPI block	40
Prerequisites for antenna pointing	41
Adjusting the antenna.	42
Pointing adjustments on Az/El cap.	43
Checking the azimuth, elevation, and polarization settings	44
Receive pointing.	45
Adjusting azimuth	45
Peaking the signal.	46
Adjusting elevation.	47
Adjusting polarization	49
Isolating the transmit signal	50
Final steps.	52
Removing the fine elevation pointing tool.	52

Acronyms and abbreviations53

Index55

Figures

Chapter 1

- 1. Installed .74 m antenna2

Chapter 2

- 2. Az/el cap6
- 3. Antenna reflector (rear view)6
- 4. Feed arm (unattached)7
- 5. Radio assembly7
- 6. Trimast in various configurations8
- 7. Optional shroud for feed assembly8

Chapter 3

- 8. Revolving plate13
- 9. Aligning the revolving plate13
- 10. Aligning the Az/el cap bolts14
- 11. Antenna adjustments for elevation and polarization15
- 12. Locating the polarization scale15
- 13. Adjusting elevation16
- 14. Locating the elevation reference edge17
- 15. Reading the elevation reference edge17
- 16. Adjusting polarization18
- 17. Placing the Az/El cap on the antenna reflector19
- 18. The fine elevation pointing tool20
- 19. Shim location next to TRIA21
- 20. Horizontal shim and vertical shim for transmit polarization22
- 21. Direction of TRIA rotation for vertical polarization23
- 22. TRIA position for horizontal and vertical transmit polarization24
- 23. Securing the O-ring25
- 24. Radio assembly installed on the feed arm26
- 25. Inserting the wedge nut bolt27
- 26. Installing the antenna assembly onto the mast28
- 27. Feed horn groove29
- 28. Shroud screws30
- 29. Feed assembly with shroud30

Chapter 4

30. Transmit and receive cable configurations	32
31. Connecting the transmit cable	33
32. Connecting the receive cable to the LNB	34
33. Ground screw on the transmitter	35

Chapter 5

34. OPI (optional tool)	39
35. OPI	40
36. OPI block	40
37. Adjusting azimuth, elevation, and polarization	42
38. Pointing features on the Az/el cap	43
39. Antenna adjustment locations	43
40. Locating and lining up the azimuth bearing	44
41. Adjusting azimuth	45
42. Adjusting elevation	47
43. Elevation nuts	47
44. Adjusting elevation	49

Tables

Chapter 2

1. Parts list	9
2. Tools required to install and point the antenna.	10

About this document

Scope and audience

This manual explains how to assemble, install, and point the DIRECWAY® model AN4-076-DF .74 m antenna. It is written for qualified installers who are familiar with satellite antenna installation practices and are capable of properly applying the information presented. The installer may be required to:

- Use a power drill to drill holes into a building.
- Locate studs, rafters, or trusses and drill holes in the exact center of them.
- Determine whether there are water pipes, electrical wiring, or gas lines hidden in the walls near where you will be drilling.
- Route coaxial cable through the foundation wall, under floors, and through interior walls.
- Ground the satellite antenna and coaxial cable as recommended in the National Electrical Code (published by the National Fire Protection Association, Batterymarch Park, Quincy, MA 02269).

Organization

This manual is divided into the following chapters:

- Chapter 1 – *Overview* includes a summary of the installation steps and tells you where to find information about tasks related to antenna installation.
- Chapter 2 – *Antenna parts and required tools* describes the components and parts provided in the antenna kit.
- Chapter 3 – *Installing the radio and antenna assemblies* provides instructions for installing the antenna.
- Chapter 4 – *Cabling and connections* provides information about making connections to the radio assembly.
- Chapter 5 – *Pointing the antenna* explains how to point the antenna at the satellite, connect the transmitter, and acquire the satellite signal.

Revision record

This section describes the revision history of this manual.

Revision	Date of issue	Scope
1	April 7, 2004	Initial release
A	October 31, 2005	Production release

Chapter 1

Overview

The DIRECWAY model AN4-074-DF .74 m antenna is used for Ku-band consumer installations.

This chapter presents an overview of the DIRECWAY broadband satellite system, a summary of the antenna installation steps, and information about tasks related to antenna installation. These topics are included in the following sections:

- *Broadband satellite system components* on page 1
- *Antenna installation overview* on page 3
- *Tasks related to antenna installation* on page 4

Broadband satellite system components

The .74 m antenna is a part of the DIRECWAY broadband satellite system, which consists of the following major components:

- Indoor unit (IDU)
- Antenna and radio assembly (outdoor unit, ODU)
- Cables for connecting the IDU to the antenna (radio) and the computer
- Installation software, including antenna pointing functions

Figure 1 shows the .74 m antenna installed on a pole mount.

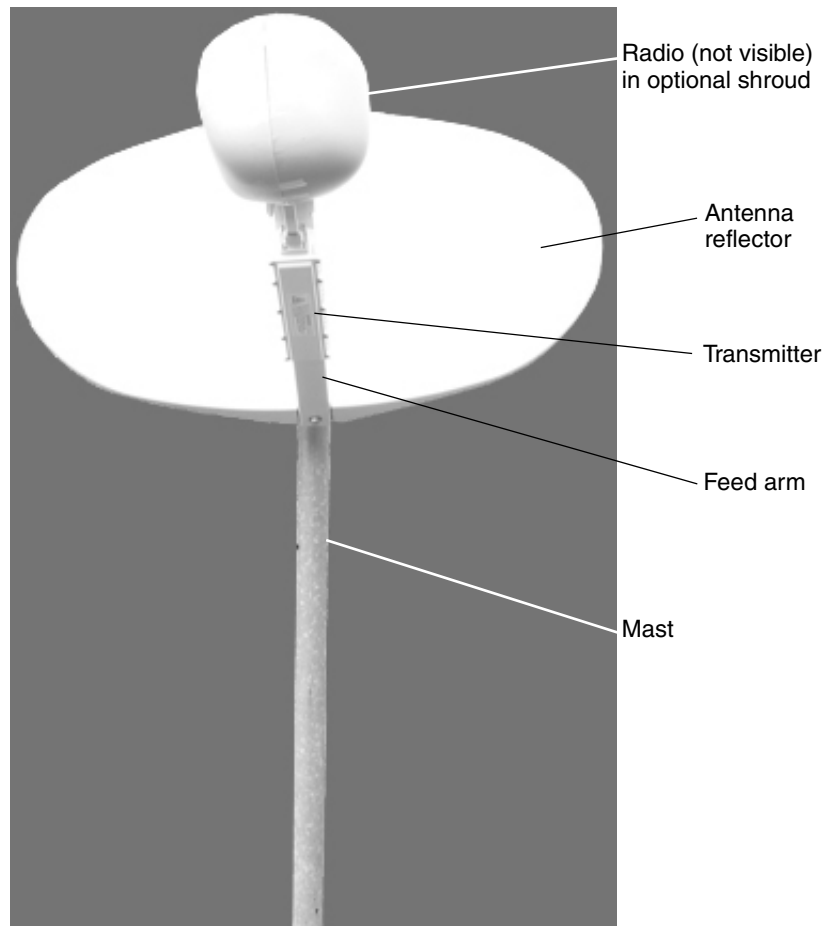

Figure 1: Installed .74 m antenna

Antenna installation overview

The antenna installation steps and related tasks are summarized below. **The steps in bold type are documented in this manual.**

1. Choose an installation site.
2. Select a method for mounting the antenna.
3. Install the antenna mount.
4. Install the IDU.



Note: Install the IDU before installing the antenna so you can run the installation software to determine the pointing values (azimuth, elevation, and polarization).

- 5. Use the installation software to determine the pointing values (azimuth, elevation, and polarization).**
(Chapter 3 – *Installing the radio and antenna assemblies*)
- 6. Assemble and install the Az/EI cap.**
(Chapter 3 – *Installing the radio and antenna assemblies*)
- 7. Install the radio on the feed arm.**
(Chapter 3 – *Installing the radio and antenna assemblies*)
- 8. Attach the feed arm to the antenna reflector.**
(Chapter 3 – *Installing the radio and antenna assemblies*)
- 9. Assemble the antenna.**
(Chapter 3 – *Installing the radio and antenna assemblies*)
- 10. Install the antenna on the mount.**
(Chapter 3 – *Installing the radio and antenna assemblies*)
11. Run cable to connect the radio to the IDU.
- 12. Connect the cables to the ODU.**
(Chapter 4 – *Cabling and connections*)
13. Ground the antenna assembly.
- 14. Point the antenna.**
(Chapter 5 – *Pointing the antenna*)

For the steps not shown in bold type, see the following section, *Tasks related to antenna installation*.

Tasks related to antenna installation

This section explains where you can find information on tasks related to antenna installation.

Selecting the installation site

Factors you should consider in selecting an installation site are discussed in the *DIRECWAY Antenna Site Preparation and Mount Installation Guide* (HNS 1035678-0001).

Installing the antenna mount

A suitable antenna mount must be installed before the antenna can be installed. For pole mounts that require a concrete base, you must allow at least 24 hr for the concrete to cure before you can install the antenna. Plan accordingly.

For complete information concerning antenna mount installation, including various mounting methods, refer to the *DIRECWAY Antenna Site Preparation and Mount Installation Guide*. Use only the antenna mount installation methods documented in the *DIRECWAY Antenna Site Preparation and Mount Installation Guide*.

Grounding

The entire antenna assembly must be grounded. For grounding information, refer to your training, best grounding practices, and applicable parts of the National Electrical Code (NEC).

Cables and cabling

For cable specifications, see the IDU manual. How the cable is run depends on the specific installation site. Route and connect the cable according to your training and best practices.

Antenna parts and required tools

This chapter describes the components and parts provided with the model AN4-074-DF antenna kit. It includes the following sections:

- *Antenna kit components* on page 5
- *Small hardware list* on page 9
- *Tools* on page 10

Antenna kit components

This section identifies and describes the key components of the .74 m antenna kit. For an illustration of an installed .74 m antenna, see Figure 1 on page 2.

The key components are:

- Azimuth/elevation (Az/El) cap
- Antenna reflector
- Feed arm and radio assembly

Related components:

- Trimast or other mount
- Optional shroud

Az/EI cap and collar The Az/EI cap (Figure 2) is used to point the antenna at the satellite. The Az/EI cap is shipped unassembled; it can be assembled in about 2 to 5 min.

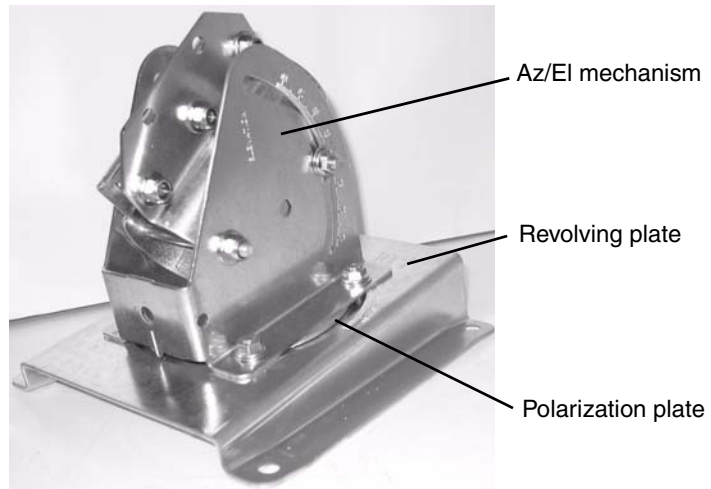

Figure 2: Az/el cap

The Az/EI cap is shipped in a bag containing:

- Az/EI mechanism
- Revolving plate
- Polarization plate
- Four 7/16-in. bolts, nuts, and washers

Antenna reflector The antenna reflector is shown in Figure 3.

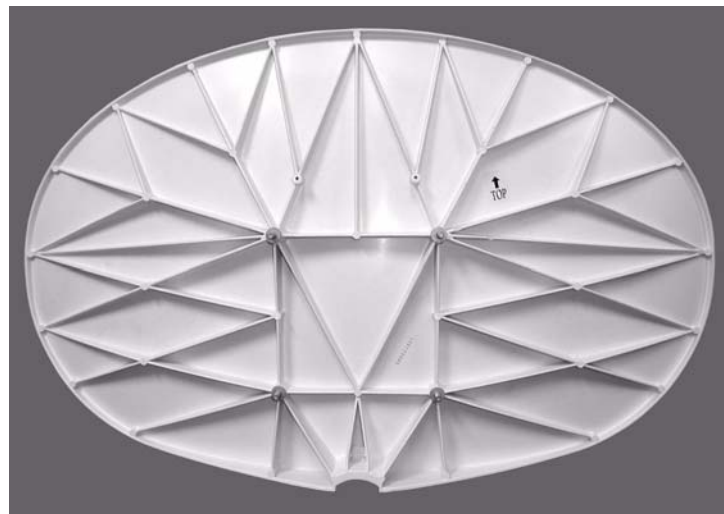

Figure 3: Antenna reflector (rear view)

Feed arm and radio Figure 4 shows the feed arm, and Figure 5 shows the radio assembly.



Figure 4: Feed arm (unattached)

The *radio assembly* (Figure 5) consists of the transmitter, low noise block converter (LNB), and transmit/receive isolation assembly (TRIA).

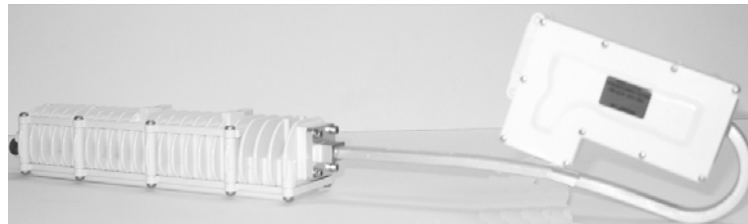

Figure 5: Radio assembly

Trimast (or other antenna mount)

The trimast is not part of the antenna kit. It is shown here because it is the most commonly used mounting option for the .74 m antenna. As shown in Figure 6, the trimast can be configured and manipulated in several ways to adapt it for mounting onto surfaces of various angles. For other suitable mounting options, see the *DIRECWAY Antenna Site Preparation and Mount Installation Guide* (HNS 1035678-0001).

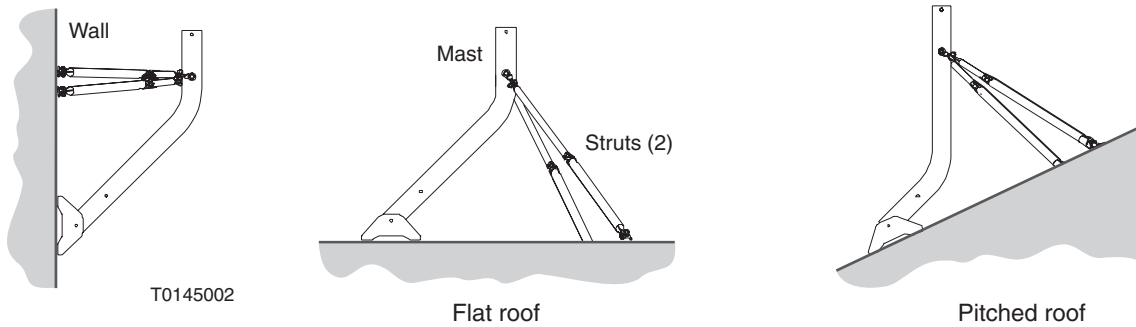

Figure 6: Trimast in various configurations

Optional shroud

The shroud shown in Figure 4 is optional. It attaches to the feed assembly to protect the feed assembly and improve its appearance, but it is not required.



Figure 7: Optional shroud for feed assembly

Small hardware list

Table 1 lists the small hardware parts that are included in the antenna kit. You may have hardware left over after you have completed installation.

Table 1: Parts list

Item	Details	Quantity
Parts used for antenna assembly and installation		
Bolts	5/16-18	2
Flat washers	5/16 in.	6
Lock washers	5/16 in.	2
Lock washers	M4	4
Bolts (with Az/EI cap)	7/16 in.	4
Nuts (with Az/EI cap)	7/16 in.	4
Washers (with Az/EI cap)	7/16 in.	4
Allen screws	M4	4
Self-tapping screws	5/16 in.	4
Wedge nut	5/16-18	1
Hex-head bolt for wedge nut	5/16-18 x 2 in.	1
O-ring	Rubber	1
Parts used for grounding		
Grounding bolt	1/4-20 x 1/2 in.	1
Star washer	Toothed, 1/4 in.	1
Hex-head ground nut	1/4-20	1



Note: Items needed to connect the antenna to the IDU are shipped with the IDU.

If you use the optional shroud, three Phillips head screws are included in a bag taped to the shroud.

Tools

Table 2 lists the tools required to assemble, install, and point the antenna.

Table 2: Tools required to install and point the antenna

Tool	Details
Open-end wrench	1/2 in.
Open-end or socket wrench	7/16 in.
Socket wrench or adjustable wrench	5/16 in.
Socket wrench	1/2 in.
Torque wrench	With 1/2-in. socket capable of torquing to 12 ft-lbf
Allen wrench	3 mm
Phillips-head screwdriver	No. 2; needed if the optional shroud is installed
Compass	Hand-held
Pencil	Carpenter's pencil
Fine elevation pointing tool	Reusable

Chapter 3

Installing the radio and antenna assemblies

This chapter explains how to install the antenna, radio, and associated hardware. Topics include:

- *Determining the pointing values* on page 12
- *Assembling the Az/El cap* on page 13
- *Installing the Az/El cap onto the antenna* on page 15
- *Installing the fine elevation pointing tool* on page 20
- *Connecting the feed arm to the antenna reflector* on page 26
- *Installing a shim for vertical transmit polarization* on page 21
- *Installing the radio assembly on the feed arm* on page 25
- *Connecting the feed arm to the antenna reflector* on page 26
- *Installing the antenna assembly onto the mast* on page 28
- *Attaching the optional shroud* on page 29

The mast must be installed before you can install the antenna. For information on antenna mounting methods, see the **DIRECWAY Antenna Site Preparation and Mount Installation Guide** (HNS 1035678-0001).

CAUTION



Before you install the antenna, read all safety information in the section titled *Important safety information* on page iii.

Determining the pointing values

Before proceeding, use the installation software to determine the initial values to use for setting azimuth, elevation, and polarization. Record these values and keep them handy for reference as you install and point the antenna. In this manual, *installation software* refers to:

- Satellite-based commissioning (SBC) – This is the preferred and most automated method for pointing the antenna. You connect to a Web-based auto-commissioning system (WebACS) and follow the on-screen instructions.

or

- WebSetup – You log onto a DIRECWAY Web site and use the WebSetup installation software.

You may use installation software from either of these sources. In each case, the software configures the IDU, calculates your exact location, and uses the location and other information to help you point the antenna. The installation software calculates the values you use to set azimuth, elevation, and polarization.

Follow the instructions in the IDU installation manual for accessing and using SBC or WebSetup.

Assembling the Az/EI cap

The Az/EI cap is shipped un-assembled. Follow the directions in this section to assemble it. You should be able to assemble it in about 2-5 min.

To assemble the Az/EI cap:

1. Place the revolving plate on a flat surface. See Figure 8.



Figure 8: Revolving plate

2. Place the polarization plate over the revolving plate.
3. Use one hand to hold the two plates together. Align the revolving plate so its four bolt holes are visible, as shown in Figure 9.

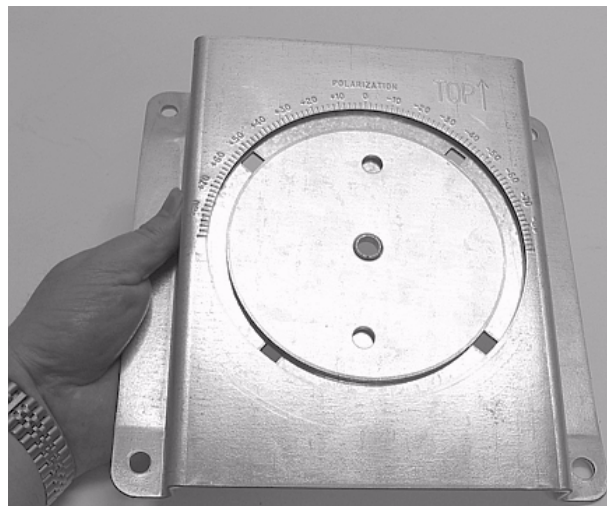

Figure 9: Aligning the revolving plate

4. Place the Az/EI mechanism over the revolving plate so the bolt holes align.
5. Install a bolt from underneath the revolving plate. While holding it with one hand, install the 7/16-in. flat washer and nut. See Figure 10.
6. Repeat until all four bolts are installed.

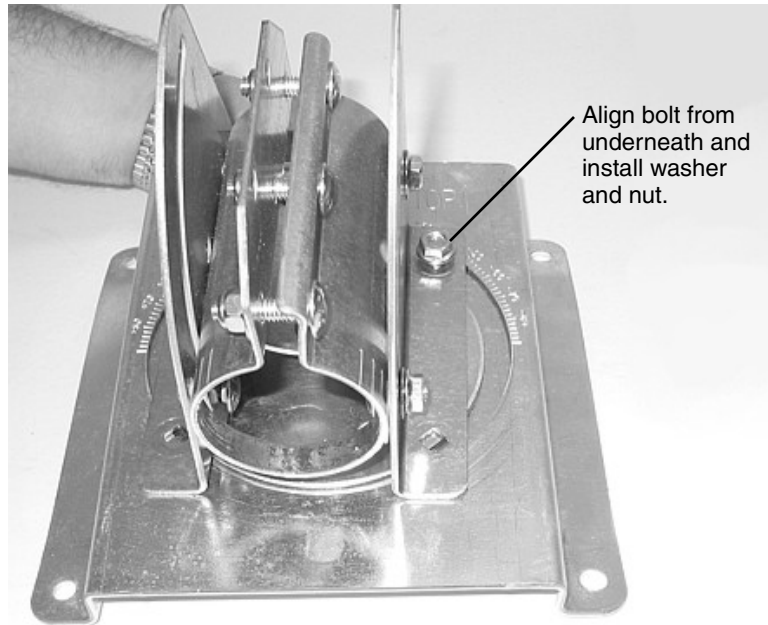

Figure 10: Aligning the Az/el cap bolts

Installing the Az/EI cap onto the antenna

Before you attach the Az/EI cap to the antenna, you must set the antenna elevation and polarization. As you set the elevation and polarization, refer to Figure 11.

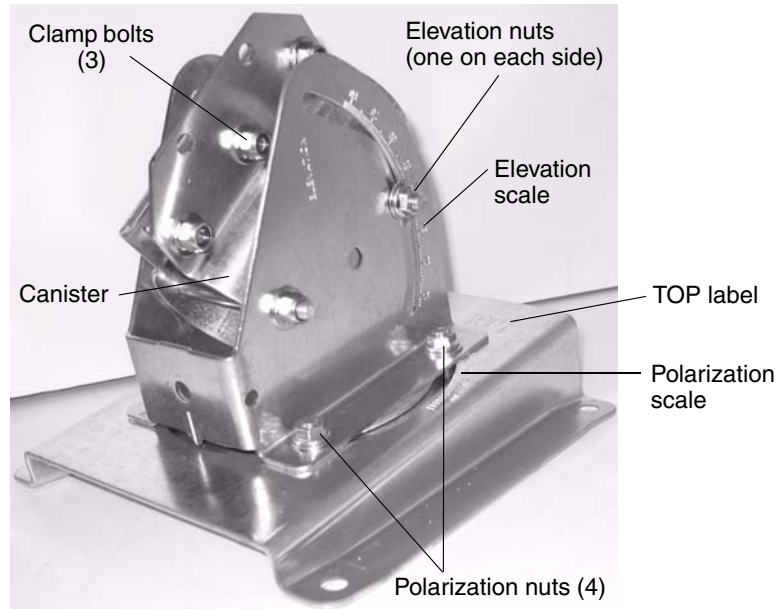

Figure 11: Antenna adjustments for elevation and polarization

The cap has an arrow, labeled *TOP*, to show you how to orient the cap vertically. (See Figure 12.)



Figure 12: Locating the polarization scale

Adjusting elevation This section describes how to adjust the antenna elevation to the value determined by the installation software. *Later, when you point the antenna, you fine-tune the elevation adjustment.*

Figure 13 illustrates how you adjust the elevation by moving the antenna up and down.

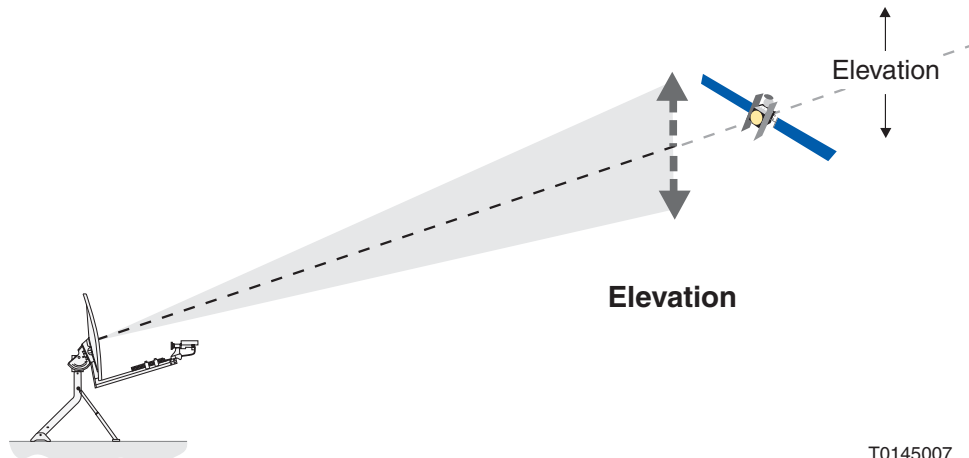

T0145007

Figure 13: Adjusting elevation

To adjust the elevation:

1. Make sure you know the elevation value calculated by the installation software.
2. Orient the Az/El cap so the *TOP* label is at the upper right.

3. Use a 1/2-in. socket wrench or open-end wrench to loosen the two elevation nuts. See Figure 14.
4. Locate the elevation reference edge on the elevation scale on the right side of the cap assembly. See Figures 14 and 15.

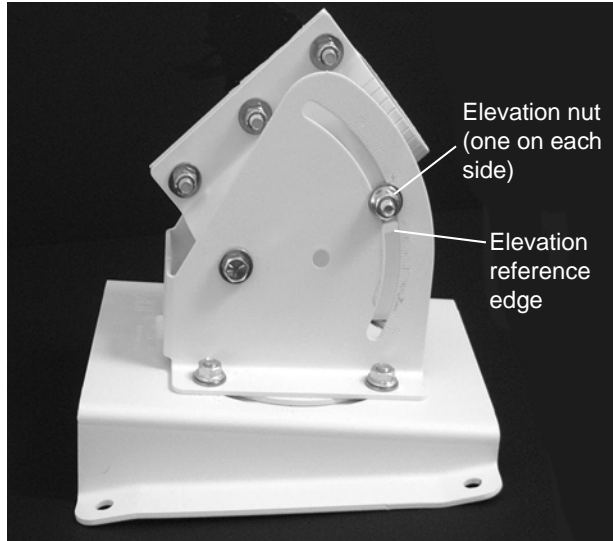

Figure 14: Locating the elevation reference edge

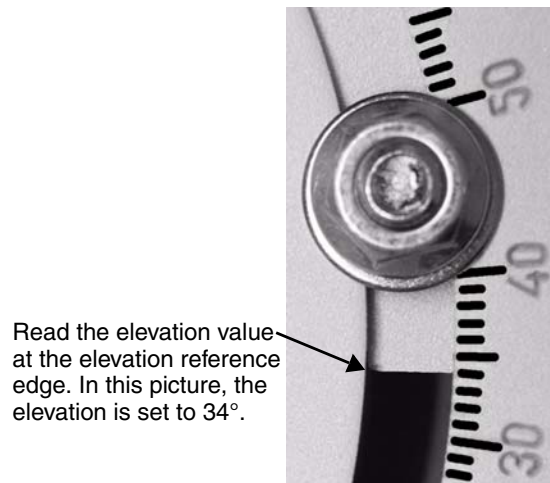

Figure 15: Reading the elevation reference edge

5. Move the canister until the elevation reference edge is at the correct value.
Later, when you point the antenna, you fine-tune the elevation adjustment.
6. When the edge is at the correct elevation value, tighten the two elevation nuts.

Adjusting polarization This section describes how to adjust the antenna's polarization to the value determined by the installation software. *Later, when you point the antenna, you fine-tune the polarization adjustment.*

Figure 16 illustrates how you adjust polarization by rotating the antenna.

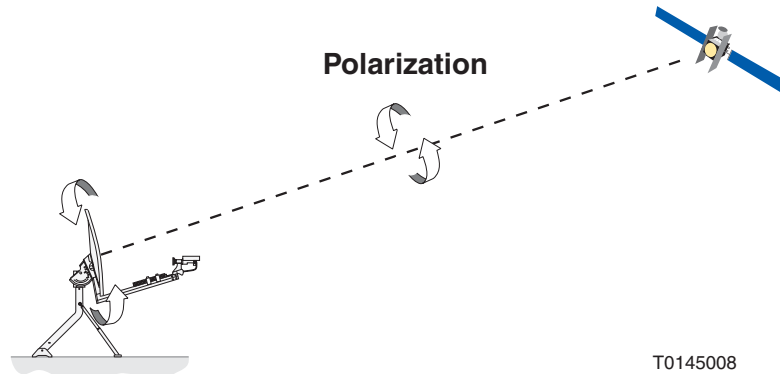

Figure 16: Adjusting polarization

Adjust polarization as follows:

1. Make sure you know the polarization value calculated by the installation software.
2. Locate the polarization scale (see Figure 12 on page 15). The 0 value is at the top of the Az/EI cap.
3. Turn the Az/EI cap to the correct polarization value. Align the mark on the top of the Az/EI cap with the correct value on the polarization scale. Figure 12 on page 15 shows a setting of positive 3° . Each tick mark represents 2° .
4. When the polarization is at the correct value, tighten the four polarization nuts. As you tighten, make sure the polarization remains at the correct value.

Later, when you point the antenna, you fine-tune the polarization adjustment.

5. Place the Az/EI cap over the screw holes in the back of the antenna reflector (see Figure 17).



Figure 17: Placing the Az/EI cap on the antenna reflector

Make sure the Az/EI cap mount screw holes are properly aligned with the holes in the antenna reflector. The arrow on the Az/EI labeled *TOP* should point to the top of the antenna reflector. Make sure the reflector is oriented so the section with a hole in its rim is on the bottom.

6. Use a 7/16-in. socket or open-end wrench to install the four 5/16-in. self-tapping screws and flat washers in the holes. Turn each screw clockwise until contact is made with the mount surface. Then use a torque wrench with 1/2-in. socket to tighten them to 10 ft-lbf. *Do not overtighten.*

Installing the fine elevation pointing tool

The fine elevation pointing tool (Figure 18) consists of a long elevation adjustment bolt with a clamp on one end and a flange on the other end. The clamp and flange attach to the Az/EI cap as shown in Figure 18.

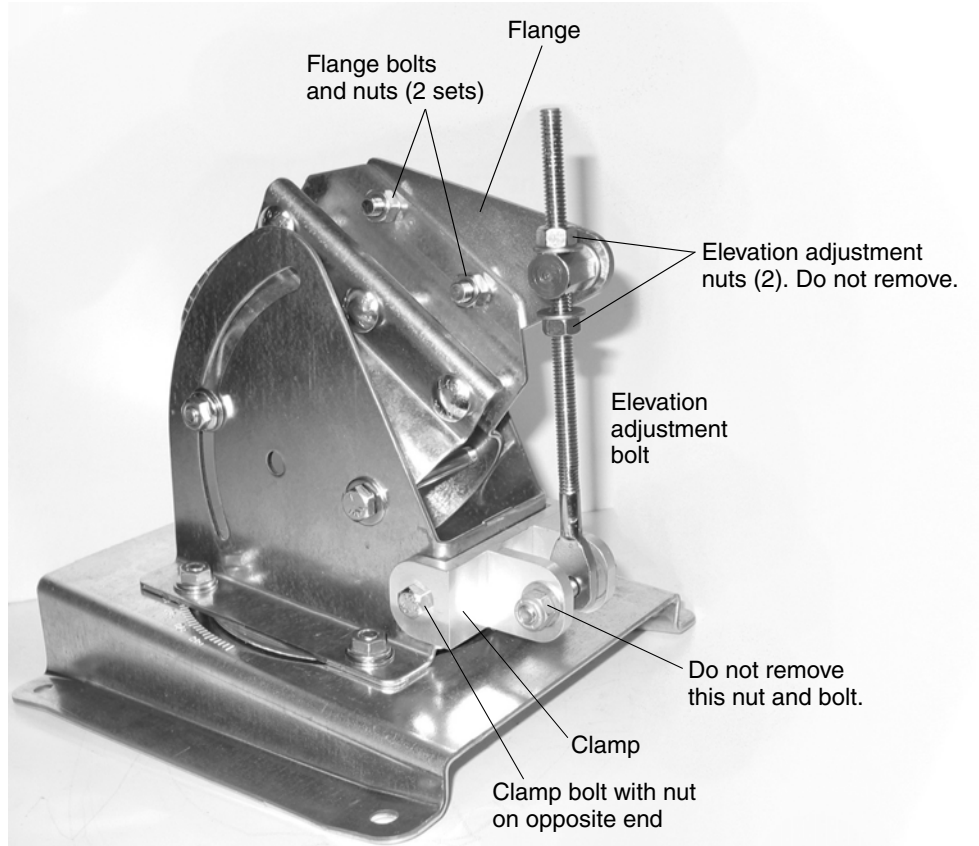

Figure 18: The fine elevation pointing tool

Install the fine elevation pointing tool as follows:

1. Align the two clamp bolt holes with the holes at the base of the elevation cap.
2. Use a 1/2-in. wrench to install the elevation clamp bolt and nut.
3. Swing the flange so the two bolts on its wide side align with the installation holes on the Az/EI cap.
4. Insert the flange bolts in the holes and use a 1/2-in. wrench to secure them using the flange bolt nuts.

Installing a shim for vertical transmit polarization

Follow the instructions in this section only if installation specifications or a service order states that vertical transmit polarization is required.

If vertical transmit polarization is not required, go to *Installing the radio assembly on the feed arm* on page 25.

The radio assembly is shipped with a horizontal transmit polarization shim installed. If vertical transmit polarization is required, you must remove the horizontal shim and replace it with a vertical transmit polarization shim.



Note: If you need to change from horizontal to vertical transmit polarization on an antenna that has the radio assembly already installed on the feed arm, you will have to remove the radio assembly from the feed arm before you can follow the instructions in this section.

Figure 19 shows where the shim is located and shows three of the four Allen screws that hold the shim in place.

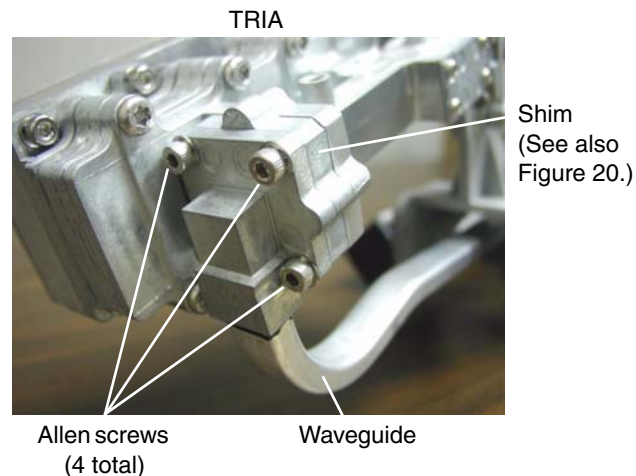
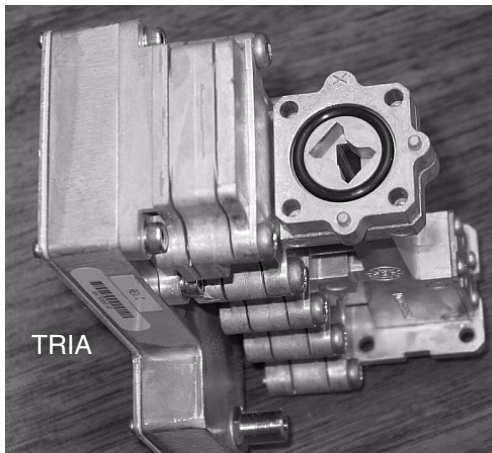

Figure 19: Shim location next to TRIA

To replace the horizontal shim with a vertical shim, follow these steps:

1. Obtain a vertical transmit polarization shim kit (HNS model VTX-SHIM-KIT, P/N 1033809-0001).
Figure 20 on page 22 shows what a vertical shim looks like.
2. Loosen and remove the four Allen screws that hold the shim in place. See Figure 19.
3. Separate the end of the waveguide from the shim.

Figure 20 illustrates the difference between the horizontal shim and vertical shim. Note the positions of the alignment pins.



Horizontal shim in place



Vertical shim in place
(In this photograph, the TRIA
has not yet been rotated.)

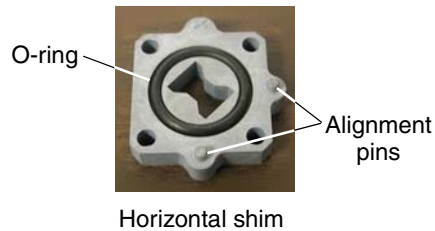

Horizontal shim

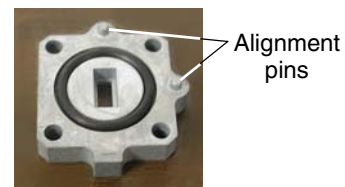

Vertical shim

Figure 20: Horizontal shim and vertical shim for transmit polarization

4. Remove the horizontal shim and O-ring.
5. Install the vertical shim and O-ring in the same location. Because of its shape and alignment pins on the transmit/receive isolation assembly (TRIA), the vertical shim can only be installed in the position shown in Figure 20 (upper right photo). Note the position of the alignment pins. Likewise, the horizontal shim can only be installed in one position.

Because of the shim's alignment pins, you must rotate the TRIA 90° from its horizontal polarization position. You must rotate the TRIA *before* you re-attach the waveguide end so you can insert the shim alignment pins into the waveguide end plate. See Figures 21 and 22.

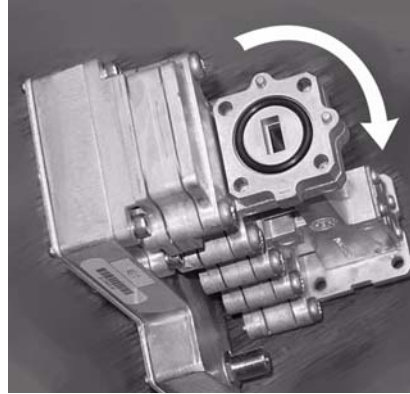

Figure 21: Direction of TRIA rotation for vertical polarization

Figure 22 shows how the TRIA is positioned for horizontal transmit polarization compared to how it is positioned for vertical transmit polarization.



Horizontal polarization



TRIA rotated for vertical polarization

Figure 22: TRIA position for horizontal and vertical transmit polarization

6. Make sure the O-ring shown in Figure 21 on page 23 is in place in the shim.
7. With the TRIA correctly positioned (rotated), place the waveguide end plate against the shim.
8. Insert and tighten the four Allen screws.

Now you are ready to install the radio assembly on the feed arm.

Installing the radio assembly on the feed arm

If the radio assembly is already attached to the feed arm, skip this section and go to *Connecting the feed arm to the antenna reflector* on page 26.

Follow these steps to install the radio assembly on the feed arm:

1. Place the O-ring in the circular depression in the square end of the feed arm. See see Figure 23.

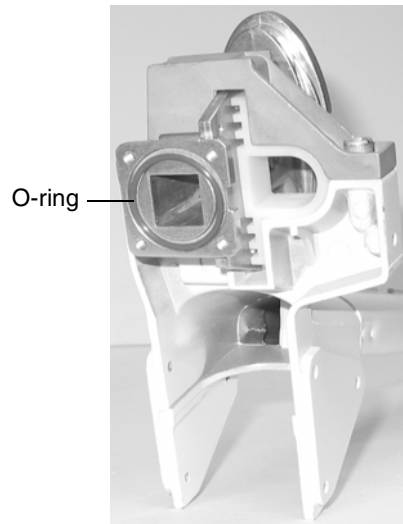

Figure 23: Securing the O-ring

2. Align the square end of the radio assembly with the square end of the feed arm so you can install the four M4 screws. Install the lock washers on the screws. Use the Allen wrench to install the M4 Allen screws, but do not fully tighten them.
3. Align the bolt holes on the top of the transmitter with the bolt holes on the bottom of the feed arm.
4. Install the 5/16-18 bolts in the aligned holes. Finger tighten them; do not tighten them further at this time.
5. Use the Allen wrench to tighten the Allen screws.

6. Use a 5/16-in. socket wrench or open-end wrench to tighten the bolts attaching the transmitter to the feed arm.
7. Make sure the transmitter and feed arm are oriented correctly, as shown in Figure 24.

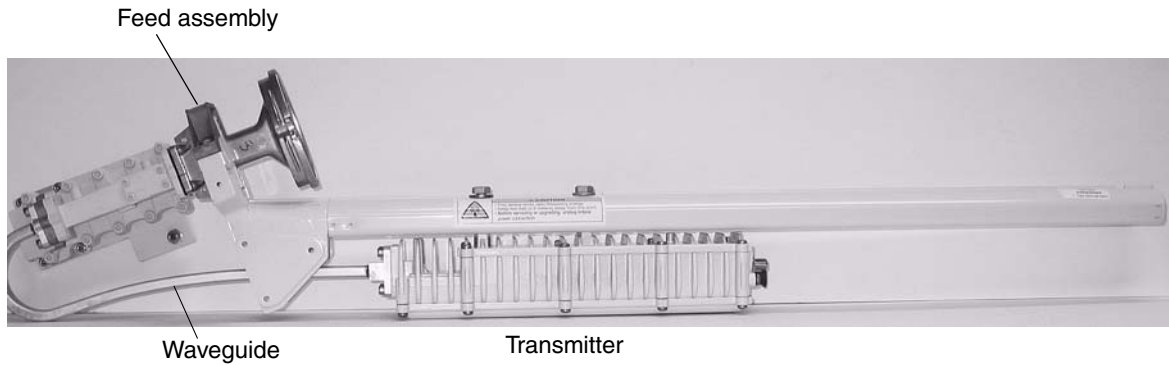

Figure 24: Radio assembly installed on the feed arm

8. Attach the transmitter to the bottom of the feed arm.
When you are done, the assembly looks like Figure 24.

Connecting the feed arm to the antenna reflector

This section describes how to connect the feed arm to the antenna reflector.



Note: If you are installing the antenna assembly on a metal pole mount, it may be easier to attach the feed arm after you have installed the antenna on the Az/EI cap. See *Installing the antenna assembly onto the mast* on page 28. However, if you are using a ladder, it may be easier to attach the feed arm to the antenna before installing it on the Az/EI cap.



Note: Make sure the feed arm is oriented as shown in Figure 24.

To connect the feed arm to the antenna reflector:

1. Insert the 5/16-18 wedge nut, thinner end first, into the slot provided on the back of the reflector, as shown in Figure 25. The wedge nut is keyed so that it will fit properly only one way into its slot in the reflector.

Make sure the hole in the wedge nut is aligned with the hole in the reflector so you can insert the bolt. See Figure 25.

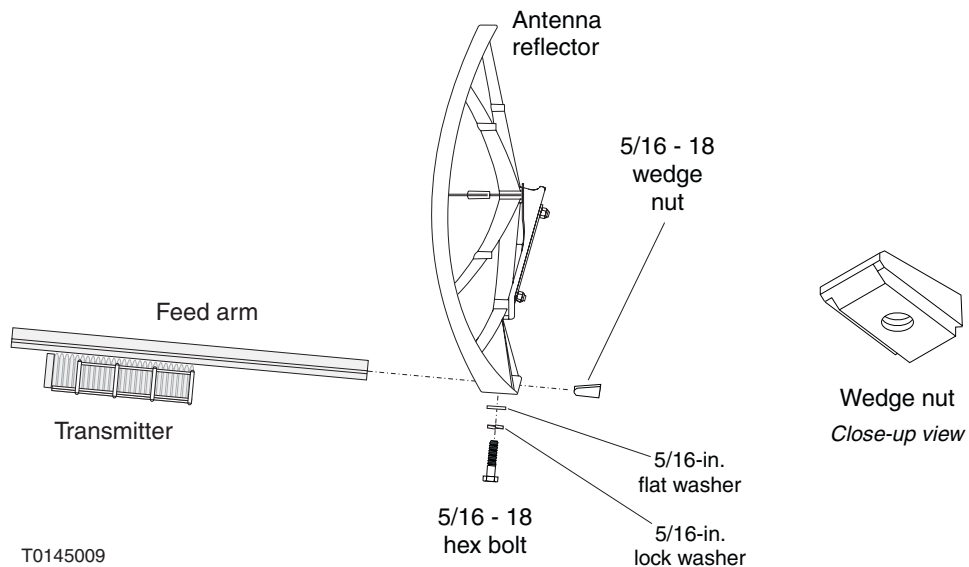

Figure 25: Inserting the wedge nut bolt

2. Install the feed arm into the feed support socket on the underside of the antenna reflector.
If you have the reflector turned upside down to insert the feed arm, the orientation is the opposite of that shown in Figure 25.
3. Use a 1/2-in. wrench to secure the feed arm with a 5/16-in. flat washer, 5/16-in. lock washer, and 5/16-18 hex bolt. Use a torque wrench to tighten the hex bolt from 8 ft-lbf to 10 ft-lbf.

Installing the antenna assembly onto the mast

This section describes how to install the antenna assembly (including the Az/EI cap) onto the mast.

To install the antenna assembly onto the mast:

1. Lightly grease the area at the end of the mast or metal pole that will be covered by the Az/EI cap canister. This makes it easy to rotate the antenna to adjust the azimuth. Any grease will do; you can use automotive grease or household grease such as Vaseline.
2. Use a 1/2-in. open-end wrench to loosen the three clamp nuts and the elevation pivot bolt nut so the collar can slide over the mast or metal pole.
3. Lift the antenna assembly and slide the Az/EI cap onto the mast or metal pole (see Figure 26).
The antenna should face toward the satellite.
4. Tighten the clamp nuts all the way, then loosen them just enough to move the antenna reflector from side to side and adjust the azimuth. The clamp bolts should be as snug as possible, but still allow the antenna reflector to be moved from side to side.

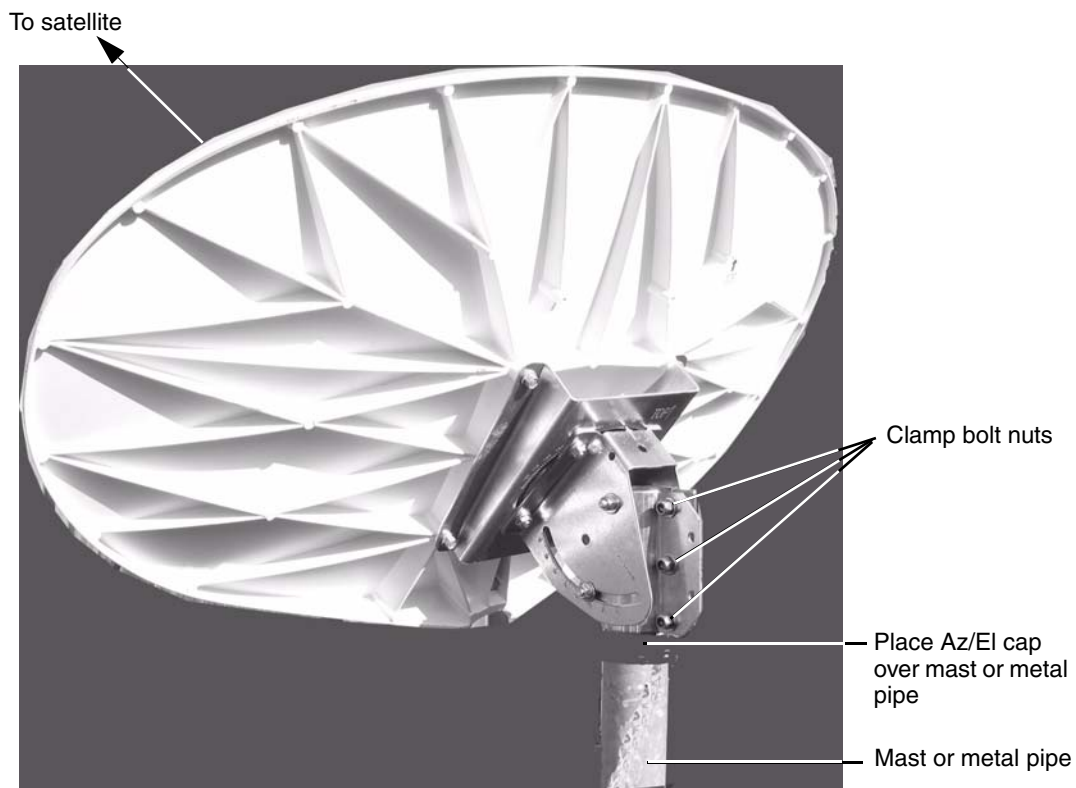

Figure 26: Installing the antenna assembly onto the mast

Attaching the optional shroud

This section explains how to attach the optional shroud to the feed assembly. The shroud helps protect the feed assembly and improves its appearance, but it is not required.

One side of the shroud is wider than the other. You place the wider side on the right side of the feed assembly, as you face the antenna.

The shroud screws are in a bag taped inside the shroud. The two side screws are optional, but installing them does provide a tighter fit and plug the screw holes.

Before placing the shroud over the feed assembly, be sure the cables are positioned so that when the shroud is placed it does not interfere with or cause sharp bends in the cables, especially at the connectors.

To attach the shroud:

1. Facing the antenna reflector, place the shroud over the feed assembly so that the broad side is on the right. Align the side screw holes. The sides of the oval hole fit either behind, or in the feed horn groove, which is shown in Figure 27.

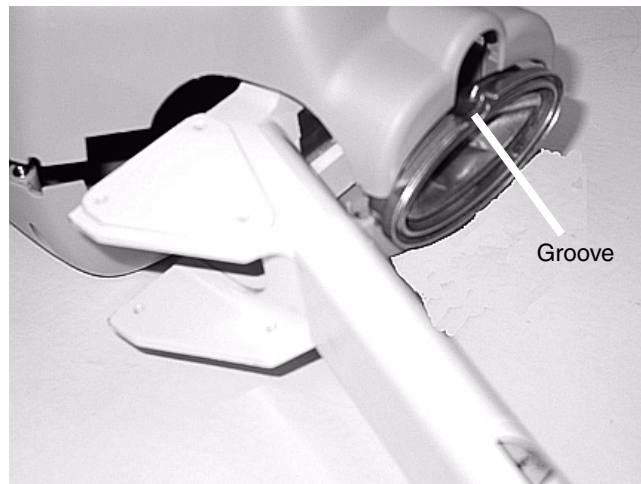

Figure 27: Feed horn groove

2. Use a No. 2 Phillips-head screwdriver to install the bottom screw. See Figure 28.

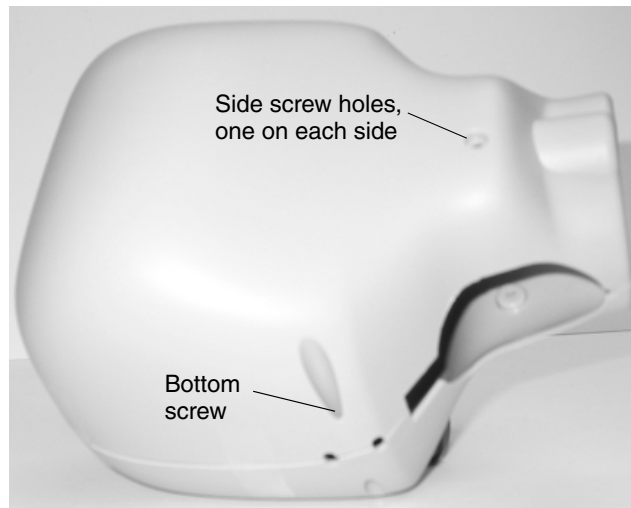

Figure 28: Shroud screws

3. *Optional:* Install the two side screws. The final assembly will look like Figure 29.

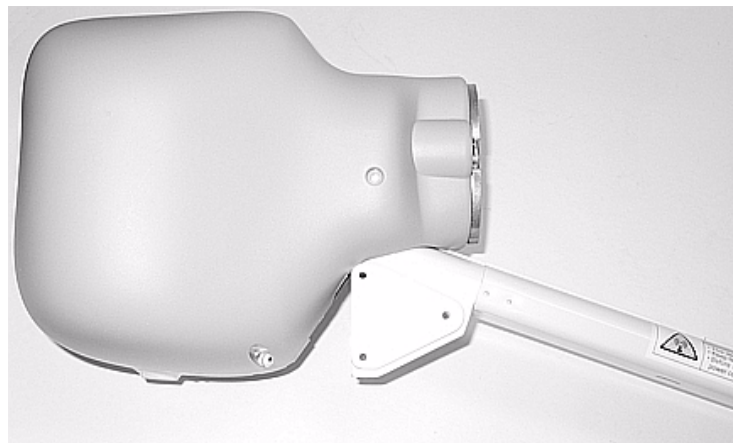

Figure 29: Feed assembly with shroud

Chapter 4

Cabling and connections

This chapter illustrates where the ODU transmit, receive, and ground connectors are located; shows how to route the transmit and receive cables at the ODU, and explains how to connect the transmit and receive cables to the radio assembly. You must connect the transmit, receive, and ground cables before you can point the antenna (*Pointing the antenna* on page 37).

The chapter includes these sections:

- *Routing the cables at the ODU* on page 32
- *Connecting the transmit and receive cables* on page 33
- *Ground connection* on page 35

Before you perform the steps explained in this chapter, you must route and terminate the transmit and receive cables from the IDU to the ODU. For cable specifications and cabling between the IDU and ODU, see the IDU instruction manual. How the cables are run depends on the specific installation site. Route and connect the cables according to your training and best practices.

CAUTION

Coaxial cable can corrode if exposed to moisture. Use weatherproof connectors. Do not use push-on connectors.

Routing the cables at the ODU

Route the coaxial transmit and receive cables at the ODU as follows:

1. Route the transmit cable (marked with blue electrical tape) to the back of the transmitter in a configuration similar to that shown in Figure 30.

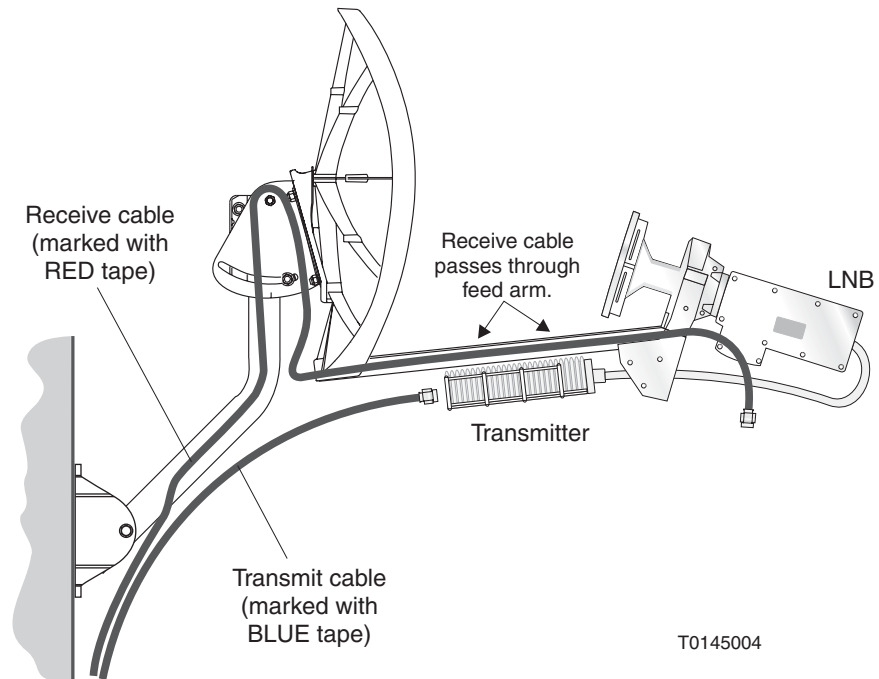

Figure 30: Transmit and receive cable configurations

2. Route the receive cable (marked with red electrical tape) up the mast, behind the reflector, and through the feed arm to the LNB to achieve a configuration similar to that shown in Figure 30.

Connecting the transmit and receive cables

This section explains how to connect the transmit and receive cables to the radio assembly.

Transmit cable Connect the transmit cable to the transmitter as follows:

1. From inside the building, disconnect the IDU power supply.
2. Go outside and connect the transmit cable (marked with blue electrical tape) to the transmitter connector marked *IFL*, as shown in Figure 31.

Use a weatherproof connector.

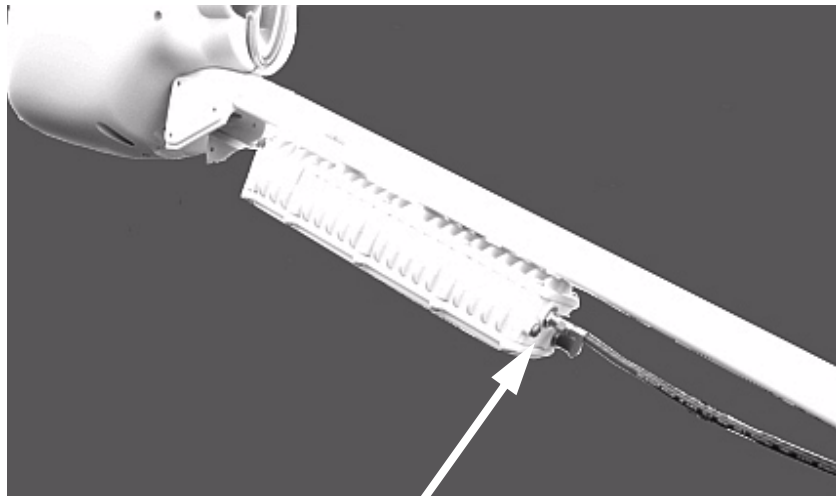

Transmitter cable
connector

Figure 31: Connecting the transmit cable

3. Tighten the connection with a 7/16-in. wrench.
4. Secure drip loops and other points on the cable with cable ties.
5. Back inside the building, reconnect the IDU power supply.

Receive cable Connect the receive cable to the LNB as follows:

1. Connect the receive cable (marked with red tape) to the LNB connector as illustrated in Figure 32.

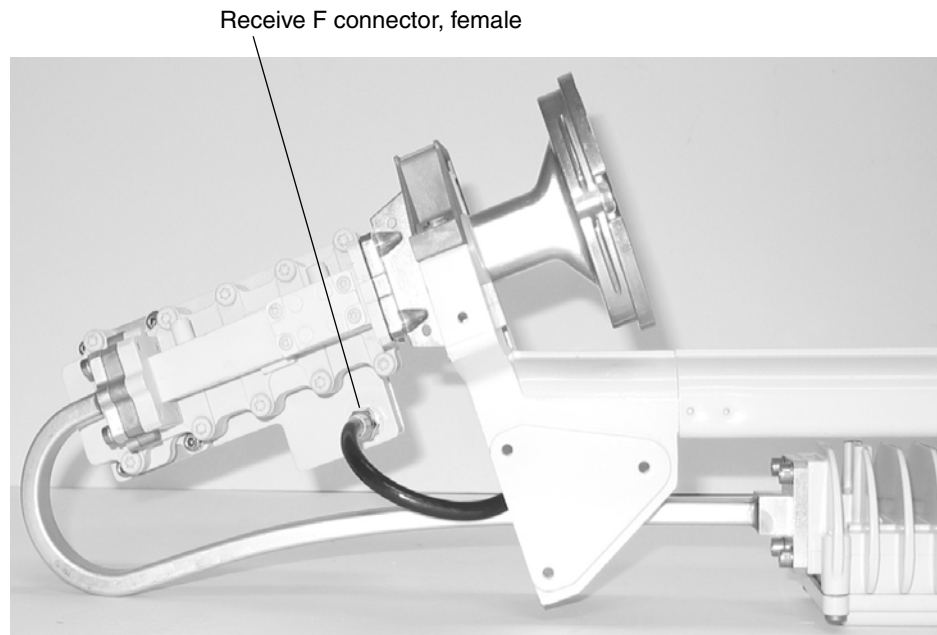

Figure 32: Connecting the receive cable to the LNB

2. Tighten the cable connector with a 7/16-in. wrench.
3. Apply dielectric silicone grease to the connection.
4. Secure the cable with cable ties.

Ground connection

Figure 33 shows the location of the ground screw on the transmitter. Ground the transmitter and mast. For grounding procedures, refer to your training, best grounding practices, and applicable parts of the NEC.

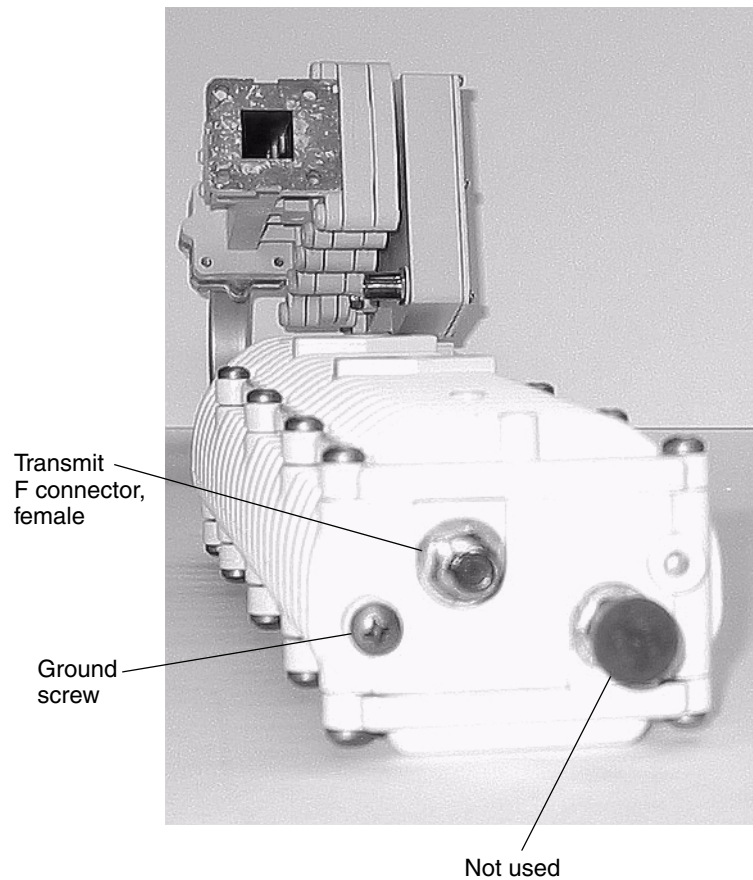

Figure 33: Ground screw on the transmitter

Chapter 5

Pointing the antenna

This chapter explains how to point the antenna and connect the transmitter. Topics include:

- *Antenna pointing overview* on page 38
- *Prerequisites for antenna pointing* on page 41
- *Adjusting the antenna* on page 42
- *Checking the azimuth, elevation, and polarization settings* on page 44
- *Receive pointing* on page 45
- *Isolating the transmit signal* on page 50
- *Final steps* on page 52

As you perform these procedures, observe the following safety precautions:

CAUTION



- **This device emits radio frequency energy when in transmit mode. To avoid injury, do not place head or other body parts between feed horn and antenna when system is operational. Keep at least 2 ft away from the area between the feed horn and the reflector when the system is operational.**
 - **Disconnect power from the IDU before performing maintenance or adding upgrades to any antenna components.**
-

Antenna pointing overview

This chapter describes a general procedure for pointing the antenna. The objectives for antenna pointing are to:

- Locate and detect the satellite signal
- Peak the signal to achieve the greatest possible signal strength

Using the installation software

The exact pointing procedure depends on the installation software used, SBC or WebSetup. (For a description of SBC and WebSetup, see *Determining the pointing values* on page 12.)

The installation software guides you through a step-by-step process for installing the IDU and pointing the antenna. It calculates your exact location and the values you use to set polarization, elevation, and azimuth.

Use the information in this chapter as a guide for the overall pointing process and for instructions on how to make mechanical adjustments to the antenna. For specific steps, follow the instructions in the IDU manual and on the installation software screens.

In general you will alternate between these two activities:

- Following the software prompts and instructions
- Adjusting the antenna (azimuth, elevation, and polarization) as necessary to acquire and then peak the satellite signal. The required adjustments are different for each installation location.

Peaking the signal

Correct antenna alignment is critical to the operation of the system. When the antenna is pointed directly at the satellite, it receives a strong signal. If it is not pointed properly, the signal may be weak, and errors may result during data transfers.

Antenna pointing is accomplished by first *receive pointing* the antenna and then *isolating the transmit signal*. Receive pointing adjusts the antenna to obtain the best receive signal. Isolating the transmit signal fine tunes the antenna alignment for the strongest possible signal received by the DIRECWAY Network Operations Center (NOC). Both processes are explained later in this chapter.

To point the antenna, you go through cycles of making small adjustments to the antenna until you are satisfied you cannot get a stronger satellite signal. When you have achieved the strongest possible signal, you have *peaked* the signal.

You may achieve the strongest signal strength after just a few adjustments, or you may find that several adjustments are needed.

By obtaining the strongest possible signal you ensure that the terminal can use all the system's capacity.

Personnel requirements One person can point the antenna if an OPI is used. Otherwise, pointing is usually a two-person task. One person aims and adjusts the antenna while the other watches the signal strength display on the computer and relays the readings to the person at the antenna. A portable telephone or walkie-talkie is helpful for this.

Pointing parameters Prior to antenna pointing, you use the installation software to enter parameters such as longitude, latitude, and polarization angle. Or you can enter the local ZIP code and let the software calculate these values.

Outdoor pointing interface The OPI, shown in Figure 34, is an optional tool that eliminates the need for a laptop computer on the roof. It is a portable repeater that displays the same values as are shown on the computer running the installation software.

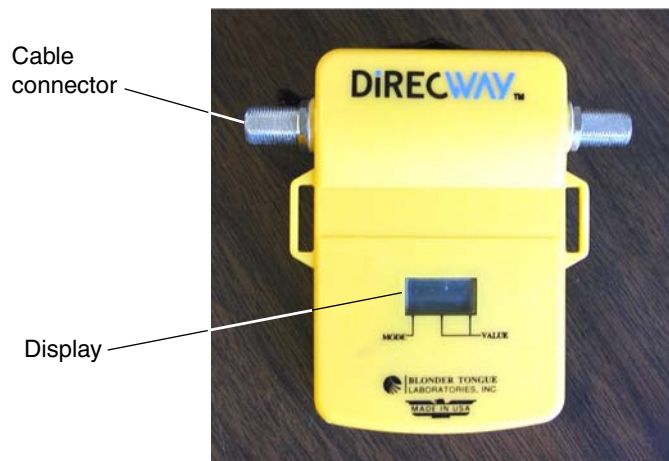

Figure 34: OPI (optional tool)

The OPI attaches to the receive cable from the LNB, as shown in Figure 35. Note that the OPI will not work unless it is enabled on the appropriate screen on the installation software. (Check the box labeled Enable OPI Display.) For further details, see *Outdoor Pointing Interface Operating Instructions* (HNS 1031832-0001).

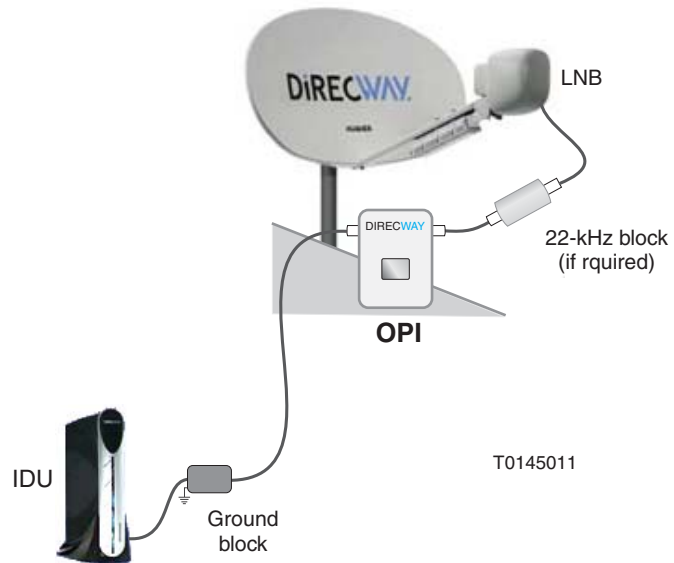

Figure 35: OPI

OPI block If you use an OPI with a model RA6-074 radio assembly, you must use a 22-kHz block (filter). This block, illustrated in Figure 36, is included in the OPI kit. Its model number is OPI-Block 22 KHZ-BLOCK.

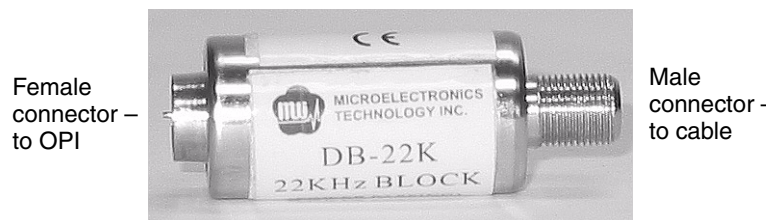

Figure 36: OPI block

Install the block between the OPI and the radio as illustrated in Figure 35. Some variations of this block may have female F connectors at both ends. If the block you use has two F connectors, you will have to make a jumper cable to connect to the OPI.

Prerequisites for antenna pointing

The following are required for antenna pointing:

- The antenna must be installed.
- The IDU must be installed.
- The transmit and receive cables must be connected to the IDU and ODU.
- The outdoor pointing interface (OPI) must be installed.
- The ODU and IDU must be grounded.
- You must have access to the installation software. (See *Using the installation software* on page 38.)

Adjusting the antenna

To point the antenna you make three adjustments:

- Azimuth – Side-to-side adjustment
- Elevation – Adjustment up and down
- Polarization – Rotational adjustment

These adjustments are illustrated in Figure 37. The corresponding mechanical adjustments on the antenna are explained in the sections that follow.

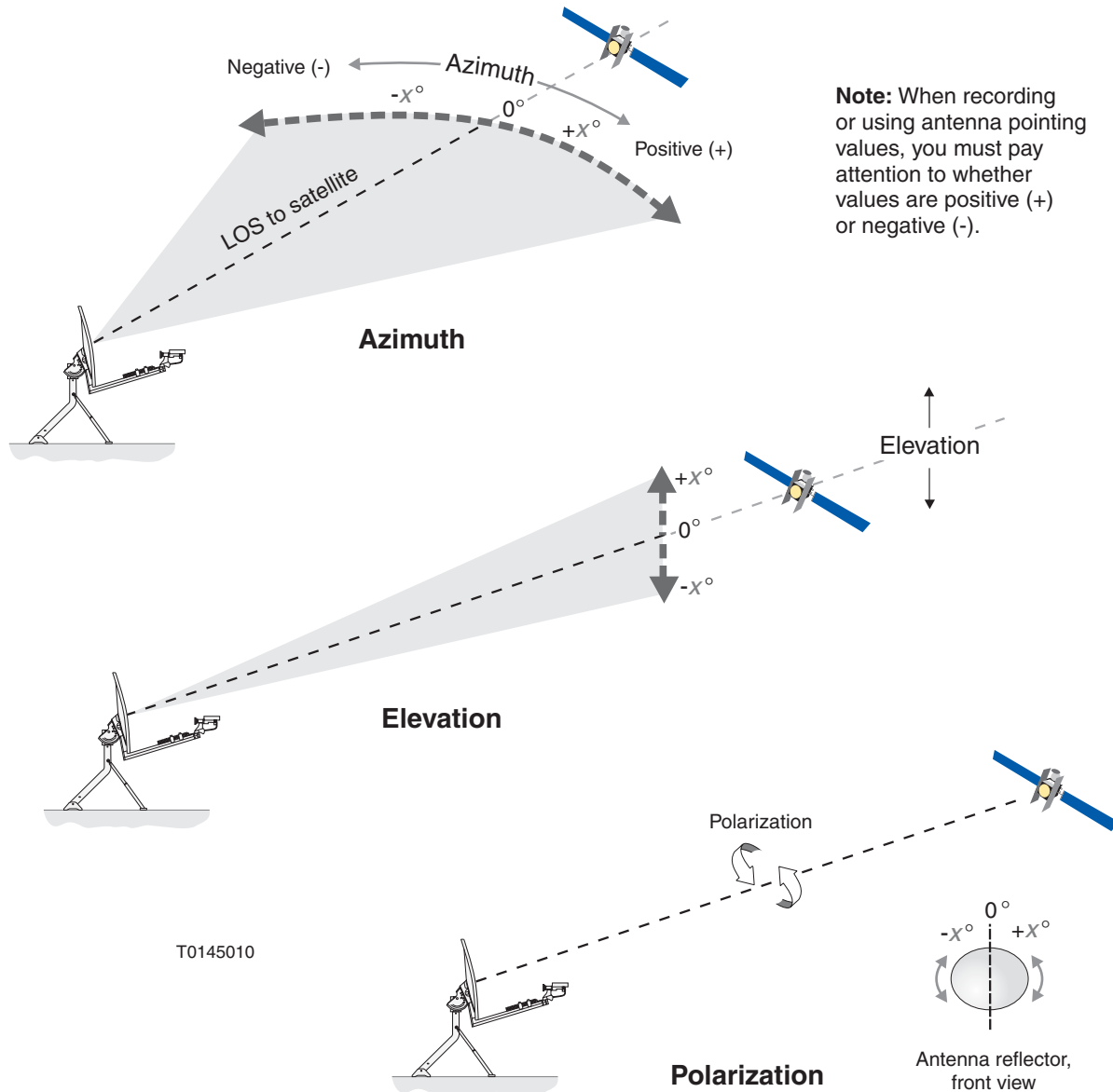

Figure 37: Adjusting azimuth, elevation, and polarization

Pointing adjustments on Az/El cap

Figures 38 and 39 show the antenna parts that are used to adjust antenna azimuth, elevation, and polarization.

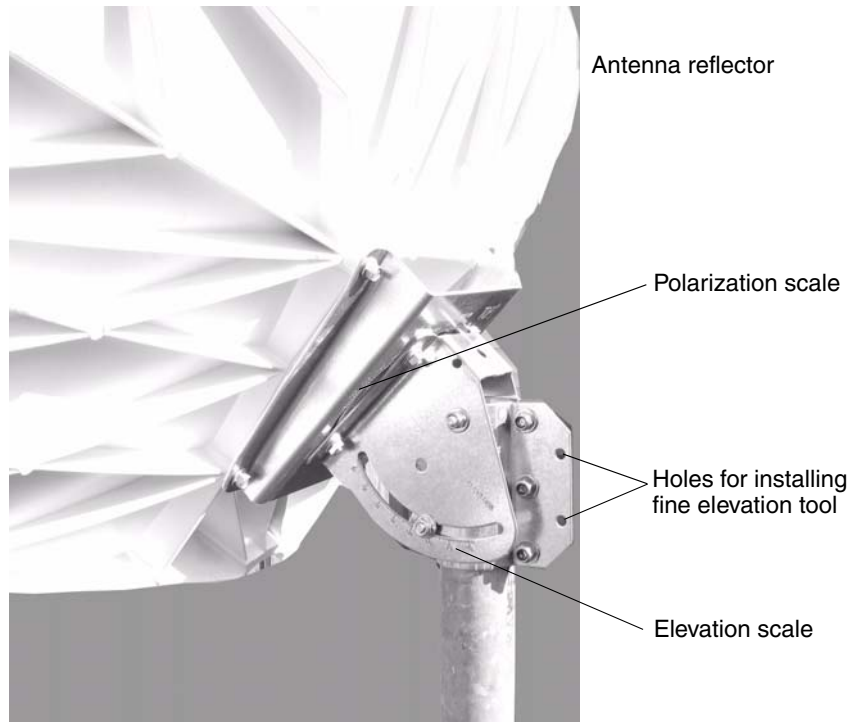

Figure 38: Pointing features on the Az/el cap

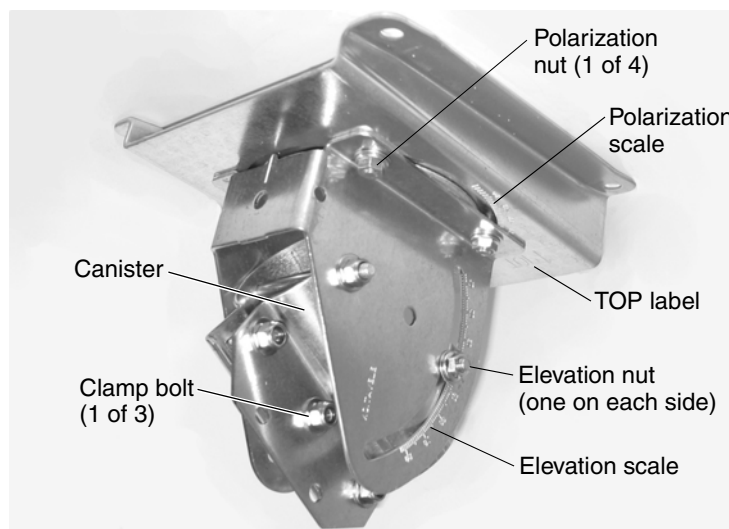

Figure 39: Antenna adjustment locations

Checking the azimuth, elevation, and polarization settings

1. Check to see if the elevation reference and polarization settings are still at their previously set values (the values calculated by the installation software). If they are not, see *Installing the Az/El cap onto the antenna* on page 15 and follow the instructions to align the antenna to the correct values.
2. If you have not already done so, tighten the clamp nuts all the way; then loosen them just enough to move the antenna reflector from side to side to adjust the azimuth. The clamp bolts should be as snug as possible, while still allowing the antenna reflector to be moved from side to side. See Figure 39.
3. Use a compass to determine the azimuth bearing specified by the installation software as follows:
 - a. Rotate the antenna reflector in azimuth (sideways) until the reflector is pointed at the magnetic bearing. Use a pencil to mark the location on the mast, and label this mark *1*.
 - b. Mark the location on the Az/El cap above mark 1. This is the *azimuth alignment mark*. (See Figure 40.)

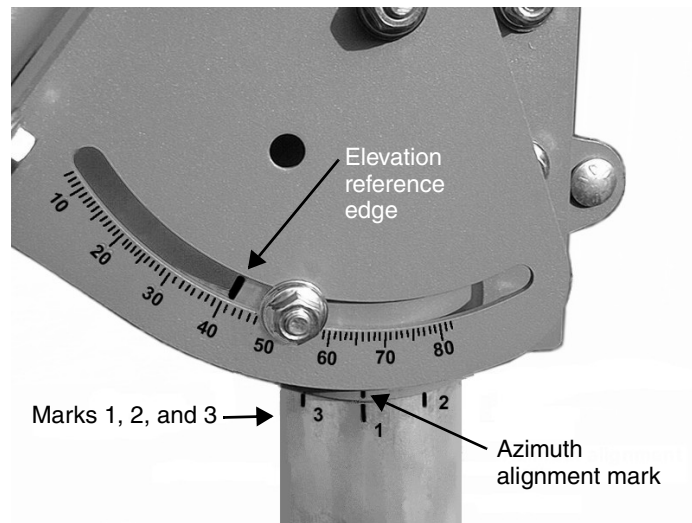

Figure 40: Locating and lining up the azimuth bearing

- c. Make another mark on the mast $\frac{3}{4}$ -in. to the *right* of mark 1 and label it 2. Make another mark on the mast $\frac{3}{4}$ -in. to the *left* of mark 1 and label it 3.
4. Stand behind the antenna and point the front of the reflector to the left of the estimated bearing to the satellite so the azimuth alignment mark lines up with mark 2.

Receive pointing

Receive pointing peaks the receive signal. You must peak the signal even if the antenna is locked to it.

Use the installation software to check the signal strength. Then adjust the antenna to peak the signal. The installation software shows numerical and graphic indications of signal strength.

Adjusting azimuth Figure 41 illustrates how you adjust antenna azimuth by moving the antenna from side to side.

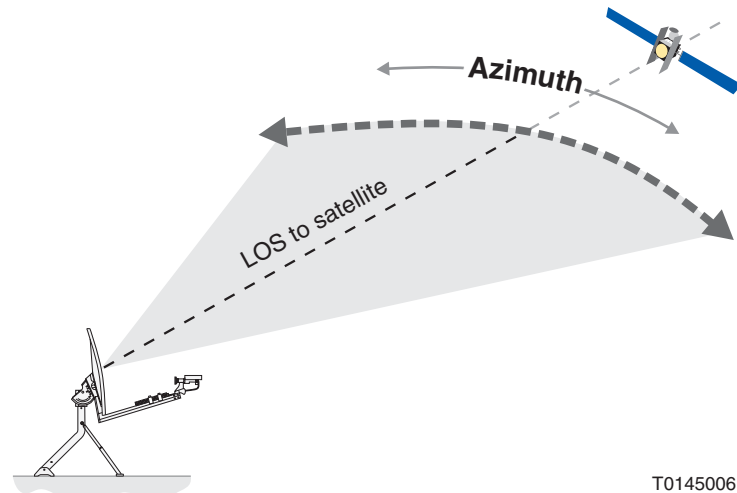

T0145006

Figure 41: Adjusting azimuth

To adjust the azimuth, follow these steps:

1. *Stand behind the antenna*, grasp the outer edges of the reflector and, while looking at the azimuth alignment mark, adjust the azimuth 1/8-in. toward the center pencil mark, mark 1.
2. Let go of the antenna and count slowly to 5 while reading the signal strength value from the OPI.

Allow the IDU enough time to track and register the signal strength.



Note: Make small adjustments (never more than 1/8 in. of azimuth as measured at the mast). Wait 5 sec between adjustments to give the IDU enough time to lock onto the satellite signal.

3. *If you are receiving a signal* and the signal strength has changed, go to *Peaking the signal* on page 38, step 1.

If no signal is present and the azimuth alignment mark has

not yet moved to mark 3 on the mast, return to step 1 (in *Adjusting azimuth*) and adjust it again. Keep moving the reflector a little at a time until you get a signal.

4. Keep moving the antenna reflector a little at a time until you detect a signal or until you reach the limit to the right.
5. If there is no signal after the antenna reflector has been moved from mark 2 to mark 3 (1-1/2 in.), there may be an error. *If there is no signal*, perform the following quick checks.
 - Check the coaxial cable connections at the LNB, IDU, and all the connections in between.
 - Make sure there are no obstructions such as trees blocking the signal.
 - Make sure you recorded and properly set the azimuth, elevation, and polarization values.
 - Verify the azimuth setting by moving 15 ft in front of or behind the antenna and taking another compass reading. Metal near the compass, such as a car or even a belt buckle, can give a false reading.
 - Point the front of the antenna reflector to the left of the estimated bearing to the satellite so the alignment mark on the Az/EI cap lines up with the right-most pencil mark you made on the mast.
 - Repeat the steps beginning with step 1 (in *Adjusting azimuth* on page 45).

Peaking the signal After the satellite is detected, peak the signal as follows:

1. Mark the mast with a pencil so you can find the azimuth bearing again.
2. After detecting the satellite, continue turning the antenna reflector a small amount in the same direction you were turning it when you began receiving the satellite signal. Pause for 5 sec after each time you move the reflector.
3. Turn the reflector in this fashion until the signal strength values displayed by the installation software begin to decrease.
4. When the numbers begin to decrease, slowly turn the reflector in the opposite direction until you regain the highest number that was previously achieved. Achieving this maximum signal strength is called *peaking the signal*.
5. When you have peaked the azimuth, tighten the three clamp nuts on the canister completely.

Adjusting elevation Figure 42 illustrates how you adjust the elevation by moving the antenna up and down.

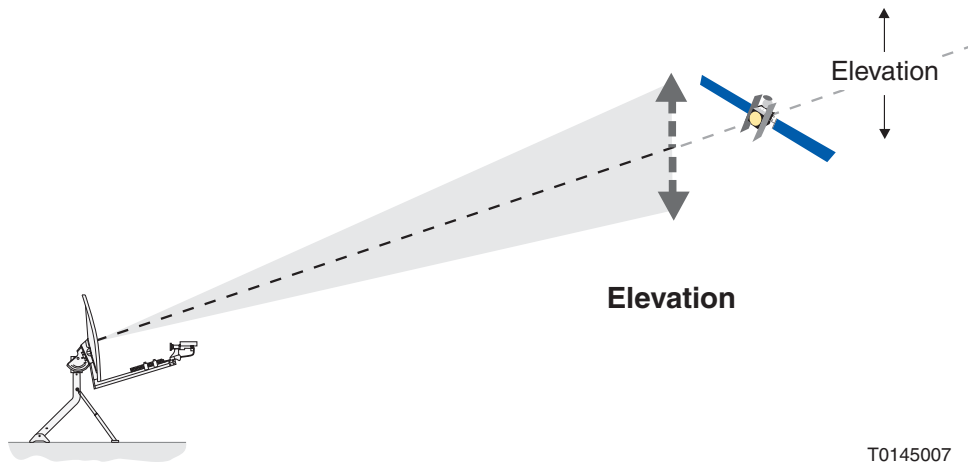

T0145007

Figure 42: Adjusting elevation

Fine-tune the antenna elevation as follows:

1. Loosen the two elevation nuts. See Figure 43.
The elevation nuts are located on the curved slots on each side of the canister. Do not confuse the elevation nuts with the *elevation adjustment nuts* (also shown in Figure 43).

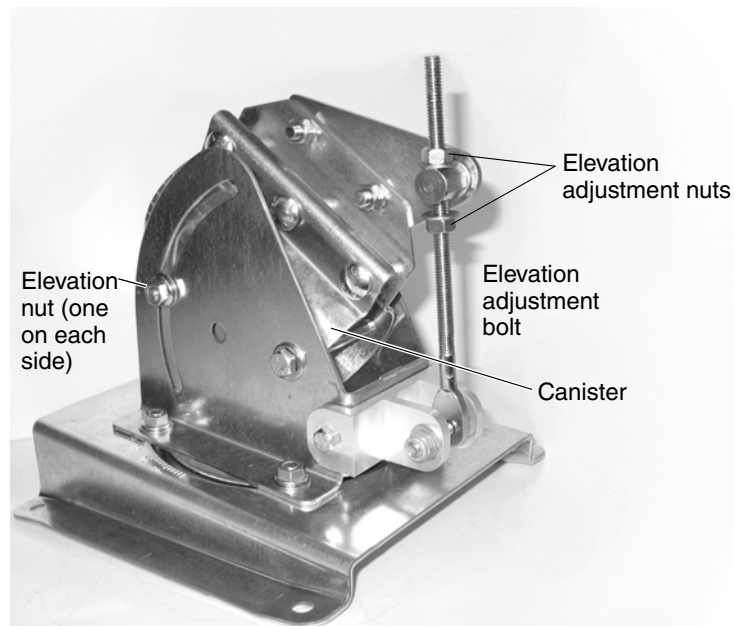

Figure 43: Elevation nuts

2. While watching the signal strength display, adjust the elevation adjustment nuts by turning them a few turns clockwise and counterclockwise until you peak the signal again.



Note: You may have to pull back on the top of the antenna to take pressure off the elevation adjustment bolt when making adjustments.

3. When the signal is peaked, tighten the two elevation nuts. (See Figure 43 on page 47.)
4. To be sure you have acquired the strongest possible signal, repeat the sequence beginning at step 2 in the section, *Peaking the signal* on page 38.
5. Adjust azimuth, then elevation, then azimuth again and continue until there is no improvement in signal strength.
6. To complete the alignment process, you must tighten the three mast clamp bolts, but tightening them can cause loss of signal strength. Monitor the signal strength while tightening the clamp bolts in the following sequence:
 - a. Tighten the top nut until the signal strength begins to degrade, then back off until you have regained the peak signal.
 - b. Tighten the bottom nut until the signal strength begins to degrade, then back off until you have regained the peak signal.
 - c. Repeat steps a and b if necessary to peak the signal.
 - d. *If you can fully tighten the top and bottom nuts without loss of signal*, then also tighten the middle nut and go to step 7. (Skip step e.)
 - e. *If you cannot fully tighten the top and bottom nuts without loss of signal*, further elevation adjustment is necessary. Go back to step 1 and begin the sequence again.

7. While watching the signal strength number to ensure that it stays at maximum, tighten the elevation nuts in the following sequence:
 - a. Snug the left nut but do not completely tighten it.
 - b. Snug the right nut but do not completely tighten it.
 - c. Fully tighten the left nut (torque to 12 ft-lbf).
 - d. Fully tighten the right nut (torque to 12 ft-lbf).

Adjusting polarization *Polarization* refers to rotation of the antenna (as shown in Figure 44) and is measured in degrees from zero (no rotation), positive or negative. Polarization is positive east of the satellite longitude and negative west of the satellite longitude.

Figure 44 illustrates how you adjust the antenna's polarization by rotating the antenna.

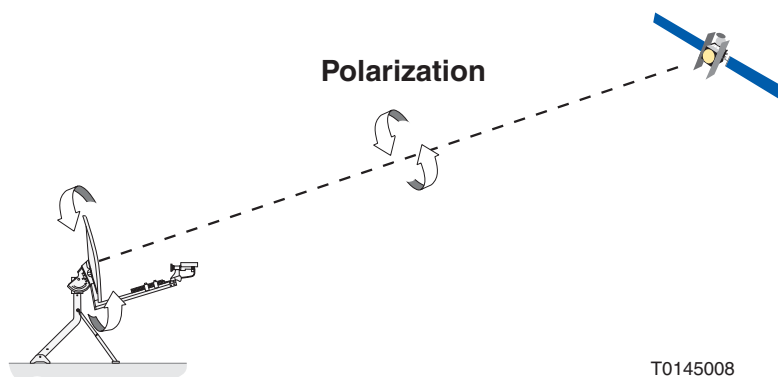

Figure 44: Adjusting elevation

To adjust polarization, follow these steps:

1. Fine-tune the polarization setting by loosening the polarization nuts just enough to enable you to rotate the antenna reflector a few degrees in each direction. If the signal strength does not change, set the polarization to the value calculated by the installation software. Otherwise, set the polarization at the setting where you peaked the signal.
2. While monitoring the signal strength number to ensure that it stays at maximum, tighten the polarization nuts.

Isolating the transmit signal

To prevent signal cross talk, you use a procedure known as Automated Cross Polarization (ACP) to isolate the transmit signal from the receive signal. ACP is included in the installation software.

The ACP software operates in two different modes—manual or automatic fine pointing. The automatic mode takes a snapshot of the cross polarization isolation measurement, while the manual mode gives real-time feedback of cross polarization isolation measurement while adjusting the antenna. Passing the automatic test enables the transmitter. Once the transmitter is enabled, the site is ready to be registered.

The ACP method consists of using the manual and/or automatic fine pointing tests and adjusting the antenna by small increments (if necessary) until it passes the automatic ACP test.

Follow the general instructions below for the ACP tests. Use the installation software screens to initiate tests and see the test results.

First run an automatic ACP test:

1. Before running ACP tests, lock down all antenna adjustment nuts and bolts.
2. Initiate an automatic ACP test.
If the antenna passes this test, it is pointed and ready to be registered.

The following test is necessary only if the antenna fails the automatic ACP test:

1. Loosen the four polarization nuts one-quarter of a turn—just enough so you can adjust the polarization.
2. Using the software screen, initiate a manual ACP test.
3. When the test starts, make small, 1° or less changes in polarization while observing the transmitter isolation.
4. Peak the polarization to the highest possible transmitter isolation.
5. Tighten the four polarization nuts.



Note: When you adjust any one of the axes (polarization, elevation, or azimuth) you may also have to adjust one or both of the other axes.

6. If the antenna passes the manual test, stop the test and run the automatic ACP test again.
If the antenna passes the automatic test, it is pointed and ready to be registered.

The following steps are necessary only if the antenna does not pass the manual ACP test:

1. Loosen the two elevation nuts.

In the following steps you make very small adjustments in azimuth and elevation. If you make too great a change, you lose the receive signal and the test cannot continue because you are out of contact with the NOC. You then have to go back to the receive pointing instructions (*Receive pointing* on page 45) and perform that procedure again.

2. Peak the elevation setting by making small adjustments to the elevation adjustment nuts on the fine elevation adjustment tool. *Do not turn the nuts more than one-quarter of a turn at a time.*
3. Tighten the two elevation nuts.
4. If the antenna passes the manual test, stop the test and run the automatic ACP test again.
If the antenna passes the automatic test, it is pointed and ready to be registered.

The following steps are necessary only if the antenna does not pass the manual ACP test after you adjust the elevation:

1. Loosen the three clamp bolts just enough so you can change the azimuth.
2. Stand behind the antenna. Observe the signal strength while you make very small adjustments—1/16-in. or less of Az/EI cap movement on the mast.
3. Peak the azimuth to the highest possible signal strength value.
4. Tighten the three clamp bolts.
5. Run the automatic ACP test again.

If the antenna passes, it is pointed and ready to be registered.

If the antenna did not pass the automatic ACP test, repeat the very small polarization, azimuth, and elevation adjustments and ACP tests as many times as necessary until you have peaked the signal and the antenna passes the automatic ACP test.

Final steps

After pointing, make sure the required safety labels and/or signs are present:

- Make sure a *Radiation Hazard Caution* label is present, legible, and visible on the feed arm.
- If the antenna is enclosed by a fence, make sure a *Radiation Hazard Caution* sign is present, legible, and visible on the entrance gate.
- If the antenna is installed on a roof with a permanently mounted access ladder, make sure a *Radiation Hazard Caution* sign is present, legible, and visible on or near the ladder.

Removing the fine elevation pointing tool

Be sure to remove the fine elevation pointing tool so you can use it for subsequent installations.

1. Remove the pointing tool's upper and lower brackets from the elevation bracket and canister.
2. Replace the nuts and bolts in the pointing tool's tool brackets so they will not get lost.

The antenna is now installed and pointed, ready for operation.

Refer to the IDU installation manual for information on how to register and configure the site.

Acronyms and abbreviations

F

ft-lbf – Foot-pound force

I

IDU – Indoor unit

in. – Inch

L

LNB – Low noise block converter

M

m – Meter

min – Minute

mm – Millimeter

N

NEC – National Electrical Code

NOC – Network Operations Center

O

ODU – Outdoor unit

OPI – Outdoor pointing interface

R

RF – Radio frequency

S

sec – Second

T

TRIA – Transmit/receive isolation assembly

A

- Antenna
 - adjustment locations 43
 - installing onto the mast 28
 - mount 4
 - pointing 38
 - isolating the transmit signal 50
 - receive pointing 45
 - reflector 6
- Az/EI cap 6
 - assembling 13
 - installing 15
- Azimuth, adjusting 44

C

- Cables 4
 - connecting 32
- Components 5
- Connectors 31

E

- Elevation
 - adjusting 47
 - fine elevation pointing tool 20
 - initial setting 16
 - scale 17

F

- Feed arm 7
 - installing 26
- Fine elevation pointing tool
 - installing 20

G

- Grounding 4
 - ground screw location 35

H

- Hardware parts list 9

I

- Installation summary of steps 3
- Isolating the transmit signal 50

M

- Mount for antenna 4

O

- OPI ground block 40

P

- Parts list 9
- Pointing 38
 - fine elevation pointing tool 20
 - isolating the transmit signal 50
 - receive pointing 45
- Polarization
 - adjusting 49
 - initial setting 18
 - shim for vertical or horizontal transmit polarization 21

R

- Radio assembly
 - installing on feed arm 25
 - shroud, installing 29
- Receive pointing 38
- Reflector 6

S

- Shim for transmit polarization 21
- Shroud for feed assembly 8
 - installing 29

Signal strength, maximizing 46
Summary of installation steps 3
System components 1

T

Tasks 3
 related to antenna installation 4
Tool list 10
Transmit cable
 connecting 33
 routing 32
Transmit polarization shim 21
Transmit signal, isolating 50
Transmitter, connecting 33
Trimast 8

Free Manuals Download Website

<http://myh66.com>

<http://usermanuals.us>

<http://www.somanuals.com>

<http://www.4manuals.cc>

<http://www.manual-lib.com>

<http://www.404manual.com>

<http://www.luxmanual.com>

<http://aubethermostatmanual.com>

Golf course search by state

<http://golfingnear.com>

Email search by domain

<http://emailbydomain.com>

Auto manuals search

<http://auto.somanuals.com>

TV manuals search

<http://tv.somanuals.com>