

Legend 3000 series

Operations Manual



Operational instructions for Humminbird Legend 3000 Series
including the Legend -3000, 3005, 3000 Deep and 3005 Deep

THANK YOU

Thank you for choosing Humminbird®, America's #1 name in fishfinders. Humminbird has built its reputation by designing and manufacturing top-quality, thoroughly reliable marine equipment. Your Humminbird is designed for trouble-free use in even the harshest marine environment. In the unlikely event that your Humminbird does require repairs, we offer an exclusive Service Policy - free of charge during the first year after purchase, and available at a reasonable rate after the one-year period. For complete details, see the warranty included in with your unit. We encourage you to read this operation manual carefully in order to get full benefit from all the features and applications of your Humminbird product. Contact our Customer Resource Center at either 334-687-0503 or www.humminbird.com.

WARNING! This device should not be used as a navigational aid to prevent collision, grounding, boat damage, or personal injury. When the boat is moving, water depth may change too quickly to allow time for you to react. Always operate the boat at very slow speeds if you suspect shallow water or submerged objects.

Legend™, Humminbird®, WhiteLine®, RTS®, Fish ID+™, Structure ID®, TrueArch™, are trademarked by or registered trademarks of Techsonic Industries, Inc.

© 2003. All rights reserved.

WARNING: Disassembly and repair of this electronic unit should only be performed by authorized service personnel. Any modification of the serial number or attempt to repair the original equipment or accessories by unauthorized individuals will void the warranty. Handling and/or opening this unit may result in exposure to lead, in the form of solder.

WARNING: This product contains lead, a chemical known to the State of California to cause cancer and birth defects and other reproductive harm.

TABLE OF CONTENTS

Section 1: USING THE LEGEND 3000 SERIES	2
Performance	2
Deep Models Additional Performance	2
Powering Up the Unit.	2
Simulator and Feature Memory	2
User Interface	3
Knobs.	3
LCD Display	3
Real Time Sonar Window	3
Chart Window.	4
Control Panels.	6
Mode	6
Automatic Mode	7
Bottom Lock Zoom Mode	8
Manual Mode.	8
Chart Speed	9
Sonar View	9
Light	9
Contrast	9
RTS Window	9
Surface Clutter	10
White Line	10
Filter	10
Depth Alarm	10
Temp Alarm	11
Fish Alarm	11
Fish Sensitivity	11
Fish ID	11
Simulator	11
Units	11
Language.	11
Section 2: MAINTENANCE AND WARRANTY.	12
Maintenance	12
Troubleshooting	13
Warranty	14
Service Policy	15
Customer Support	15
Section 3: SPECIFICATIONS	
Legend 3000/3005 Specifications	16
Legend 3000 Deep /3005 Deep Specifications	16

USING THE LEGEND 3000 SERIES

PERFORMANCE / SIMULATOR / POWERING UP THE UNIT

		Legend Models		
		North American	International*	
1000 Series 160 x 160 pixels 8 levels grayscale		1000 2000	1005 2005	Single Beam 2' to 600'
2000 Series 240 x 240 pixels 16 levels grayscale	3000 Series	3000	3005	Dual Beam 2' to 600'
3000 Series 240h x 320v pixels 16 levels grayscale		1000 Deep 2000 Deep 3000 Deep	1005 Deep 2005 Deep 3005 Deep	Dual Beam 2' to 2000'

Note: International models include multiple languages and measurements in metres, feet or fathoms. Temperature includes jC.

USING THE LEGEND 3000 SERIES

Performance

The **LEGEND 3000 SERIES** represents a new way of thinking about fishing electronics. It combines state-of-the-art electronics with the detail of a traditional sonar paper chart recorder to create the fishfinder of the future. Minimal, easy-to-understand knob controls provide access to the most important features. The **LEGEND 3000 SERIES** eliminates confusion created by too many buttons and menus. High technology, high performance, with "back to basics" operation makes the **LEGEND 3000 SERIES** the ideal choice of the serious angler.

The **LEGEND 3000 SERIES** uses sonar to locate and define underwater objects. Sonar technology is based on sound waves sent into the water in a controlled "beam" from the transducer. Objects within this beam reflect the sonar signal back. The **LEGEND 3000 SERIES** very accurately measures the distance to these objects based on the time it takes for the sonar to return. Each object (bottom, fish or structure) reflects the sonar uniquely, providing information about its makeup. The **LEGEND 3000 SERIES** draws this returned information on the display.

The **LEGEND 3000 SERIES** operates in a wide variety of water conditions, from 2' to 600' (2000' for the Legend 3000 Deep and 3005 Deep Models). Actual depth capability depends on many factors such as bottom hardness, water conditions, and transducer installation. All sonar units typically read to deeper depths in fresh water than in salt water.

Deep Models Additional Performance

If you purchased a Legend 3000 Deep or a Legend 3005 Deep Model, your Legend product is equipped with a 50kHz/200kHz dual beam transducer capable of performing to a depth of 2000 feet. In addition, your unit contains several extra features that will enhance its sonar performance in deep water. **SONAR VIEW** allows you to display the sonar information from either beam or both beams simultaneously. **FILTER** control allows the filtering algorithms to be turned off to show the greatest amount of sonar information. **FISH ALARM**, **FISH SENSITIVITY**, and **FISH ID** provide advanced signal processing to identify fish and show their depth and relative size from either beam.

Powering Up the Unit

After installation, turn the **LEGEND 3000 SERIES** on by momentarily pressing the **GAIN** knob. An audible chirp sounds as the unit turns on. If the unit detects that the transducer is connected and is in water, the **LEGEND 3000 SERIES** begins to show sonar information on the display. If the transducer is not detected, the unit starts up in **SIMULATOR** mode.

To power the unit off at any time, press and hold the **GAIN** knob for several seconds until the unit turns off.

Simulator and Feature Memory

The **LEGEND 3000 SERIES** contains a **SIMULATOR** that allows you to use the unit as though you are on the water.

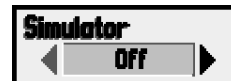

The **SIMULATOR** is an invaluable aid to learning the features and functions of the **LEGEND 3000 SERIES**. All controls are operational and settings can be changed to experiment with various features. An indicator appears at the bottom left of the display when operating in **SIMULATOR** mode.

There are two ways to start the **SIMULATOR**. The method to use depends on whether a transducer is connected.

Power On with No Transducer

If the **LEGEND 3000 SERIES** is powered on with no transducer connected, it starts up in **SIMULATOR** mode. No other steps are needed. In this mode, the **LEGEND 3000 SERIES** does not remember any setting changes after power off, but defaults to the factory settings.



Power On with Transducer Connected

If the **LEGEND 3000 SERIES** is powered on with the transducer connected, the **SIMULATOR** must be turned on manually. To turn on the **SIMULATOR** manually:

1. Press the Control Panel knob to display the list of options.
2. Rotate the Control Panel knob to scroll through the list until Simulator is visible and is highlighted on the display.
3. Turn the Range knob to turn Simulator from Off to On.
4. Press the Control Panel knob to clear the screen.

When operating with the Simulator on and the transducer connected, changes made to the following Control Panel choices are permanently remembered: Chart Speed, RTS Window, Surface Clutter, Contrast, White Line, Units, and in International Models, Language.

USER INTERFACE

The **LEGEND 3000** User Interface is made up of the following components: knobs and the LCD Display, which in turn is made up of the RTS and the Chart Windows.

Knobs

Four knobs on the **LEGEND 3000 SERIES** control all user settings: **MODE**, **GAIN**, **CONTROL PANEL** and **RANGE**.

Mode Knob

The **MODE** knob selects how the **LEGEND 3000 SERIES** locates the bottom and graphs the information on the display. Turn the knob until the pointer aligns with the desired mode of operation. See Modes of Operation for more information.

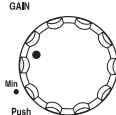
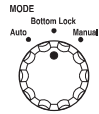

Gain Knob

The **GAIN** knob controls the gain (sometimes called sensitivity) of the sonar receiver. Gain also powers the unit on or off. When the **LEGEND 3000 SERIES** is off, press Gain to turn the unit on. Press and hold Gain to turn the unit off. Turn the Gain knob clockwise to increase the gain; turn counterclockwise to decrease the gain. As you turn the knob, only new sonar information being graphed shows the effect of the gain change. Increasing the gain shows faint sonar returns from small bait fish and suspended debris in the water, but the display may become too cluttered in some water conditions. Increased gain is also beneficial at deeper depths to maintain a good bottom image and show adequate sonar returns from deep objects. Decreasing the gain eliminates the clutter from the display; however, if adjusted too low, the display may not show many faint sonar returns that could be fish.

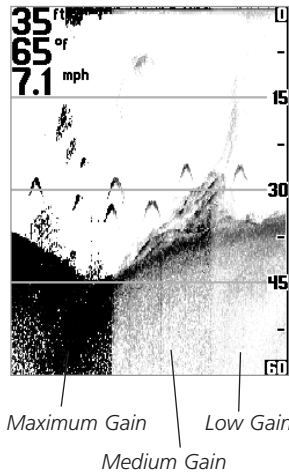

Control Panel Knob

The **CONTROL PANEL** knob accesses features used to adjust some **LEGEND 3000 SERIES** settings. Push the knob to display the **CONTROL PANEL** list, then rotate the knob to select a feature for adjustment. A light colored background indicates the selected feature. Turn the **RANGE** knob to adjust the selected feature. Remove the **CONTROL PANEL** list from the display by pushing the **CONTROL PANEL** knob again. If no adjustments are made after a few seconds, the **CONTROL PANEL** list is removed automatically.

Range Knob

The **RANGE** knob adjusts the depth ranges used on the display. The **RANGE** knob has slightly different capabilities in each mode of operation. See Modes of Operation for specific information. In all modes, turning the knob clockwise increases the range, while turning it counterclockwise decreases the range. Turning the knob slowly increases the adjustment in

small increments, while turning it quickly makes large changes to the adjustment.

The LCD Display

The **LEGEND 3000 SERIES** uses a high-resolution LCD display to show sonar information, digital depth, temperature, speed and other readouts.

A digital depth readout is always displayed in the upper left corner of the LCD. When the speed/temp accessory is connected, additional digital readouts (such as MPH) are shown below the depth. A voltage readout appears in the bottom left when the input voltage to the **LEGEND 3000 SERIES** is less than 11 volts or greater than 15 volts.

A depth range scale appears close to the right side of the LCD display. This scale indicates the distance from the surface of the water to a depth range sufficient to show the bottom. For example, in 18 feet of water, a 20 foot depth range is selected. The depth range scale can be controlled automatically or manually depending on the mode of operation. In **AUTOMATIC** and **Bottom Lock** modes, the **LEGEND 3000 SERIES** selects the depth range. In **MANUAL** mode, the depth range is selected by the user.

The sonar returns received by the **LEGEND 3000 SERIES** are displayed along the depth range scale in a **REAL TIME SONAR (RTS) WINDOW** and **CHART WINDOW**. The **RTS WINDOW** displays new sonar information within the transducer cone in an expanded, easy-to-see format; the **CHART WINDOW** logs old **RTS WINDOW** information to show a contour view of the bottom and structure.

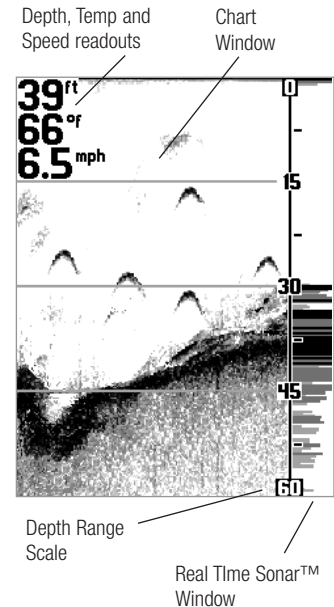

Turn CONTROL To Select	
Chart Speed	5
Light Off	8
Contrast	8
RTS Window	2
Surface Clutter	4
White Line	2
Depth Alarm	Off
▼ more	

Turn RANGE To Adjust

USING THE LEGEND 3000 SERIES

REAL TIME SONAR™ / CHART WINDOW

The sonar returns received by the LEGEND 3000 SERIES are displayed along the depth range scale in a REAL TIME SONAR™ (RTS) WINDOW and CHART WINDOW. The RTS WINDOW displays new sonar information within the transducer cone in an expanded, easy-to-see format; the CHART WINDOW logs old RTS WINDOW information to show a contour view of the bottom and structure.

Real Time Sonar™ (RTS) Window

Real Time Sonar (RTS) Window

The REAL TIME SONAR (RTS) WINDOW shows instantaneous sonar returns from the bottom, structure and fish that are within the transducer beam. The RTS WINDOW updates with new sonar information up to 30 times per second in shallow water (deeper water will slow the refresh rates).

The RTS WINDOW responds to quickly-changing depths in a way similar to a flasher type sonar display. Interpreting the RTS information requires some skill; comparing the RTS data with the data in the CHART WINDOW, however, makes the RTS information easy to understand.

The width of the RTS WINDOW can be adjusted to your preference. Selecting a wider RTS WINDOW shows greater differences between the strength of the sonar returns, although doing this will reduce the amount of history on the display. See CONTROL PANELS for details on adjusting the RTS WINDOW.

When the RTS WINDOW is wide enough, it plots the depth and intensity (amplitude) of a sonar return using horizontal black lines, where line length indicates return strength, and the vertical placement of the lines next to the depth range scale indicates the depth.

When the RTS WINDOW is narrow enough, it plots the depth and intensity of a sonar return using grayscale lines, where the intensity of the sonar return is divided into 16 levels of grayscale, with the most intense returns shown in black, and less intense sonar returns shown as progressively lighter shades of gray. When the view is narrow enough, the combination of the grouping of the lines and the grayscale level helps to identify the bottom composition and structure. The bottom displays as the largest grouping of black horizontal lines, and typically has gray lines underneath. A harder bottom shows less gray below; a soft bottom shows more gray below. Structure appears above the bottom as a cluster of lines with varying lengths and gray shades.

In any view, fish appear as smaller groupings of sonar returns between the bottom and surface. Often, large fish within a structure will show as a strong return within a grouping of smaller returns. When the boat is stationary or

drifting very slowly, the RTS WINDOW can show the movement of the fish through the transducer beam. Moving fish appear as smaller groups of lines that become progressively larger lines, or vice versa. A grouping of lines moving vertically indicates a fish changing depth.

The Chart Window

The CHART WINDOW creates a historical log of sonar returns from stored RTS information. As the boat moves, variations in the depth and sonar return changes are charted to form an image of the bottom contour. The most recent sonar returns are charted on the right side of the window; as new information is received, the older information is moved across the display.

The CHART WINDOW also indicates the composition of the bottom. A hard bottom, such as compacted sediment or flat rock, appears as a dark, thin line across the display. A soft bottom, such as mud or sand, appears as a thicker line that contains a transition from darker to lighter grays. Bottoms made up of many rocks have a broken, random appearance.

Sloped Bottoms

Bottoms having a large degree of slope also present a unique picture. These generally have a thicker black band representing the bottom directly under the boat. Equal areas of gray above and below the black band represent sonar returns from around the boat.

Second Sonar Returns

A second sonar return may be visible if the appropriate depth range is selected. This appears as a depth contour below the main bottom contour, at twice the depth. The second return occurs when the sonar signal bounces between the bottom and the surface of the water, then back again. Some anglers use the appearance of the second return to determine bottom hardness. With a lower gain setting the second return will be more faint, except in areas with a hard bottom. The LEGEND 3000 SERIES has a unique depth range feature which permits the second return to be visible in any depth range up to one-half the maximum depth of the unit. See MODES OF OPERATION for details.

Structure

The LEGEND 3000 SERIES displays structure, such as submerged grass, brush, trees and wrecks on the bottom. Structure can be distinguished by comparing the area just above and below the main bottom return. Usually structure shows as areas of dark to light gray on top of a dark bottom contour. The appearance of structure is greatly affected by boat speed and direction; to repeat the same image it is often necessary to travel the same speed and direction over the location where the structure was originally located.

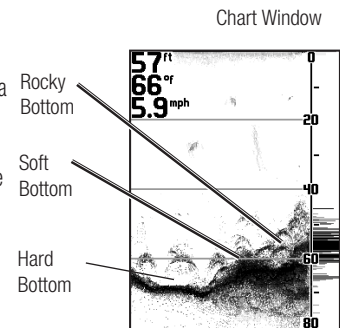
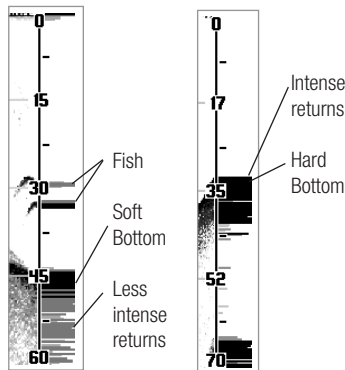
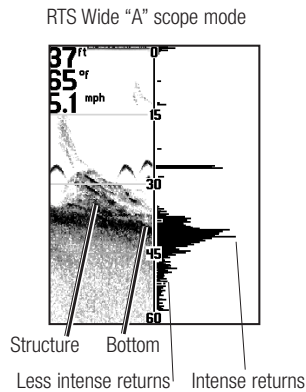

USING THE LEGEND 3000 SERIES

CHART WINDOW / BOTTOMS / FISH APPEARANCE

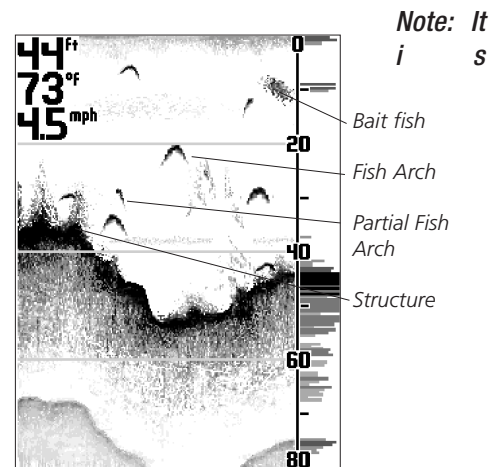
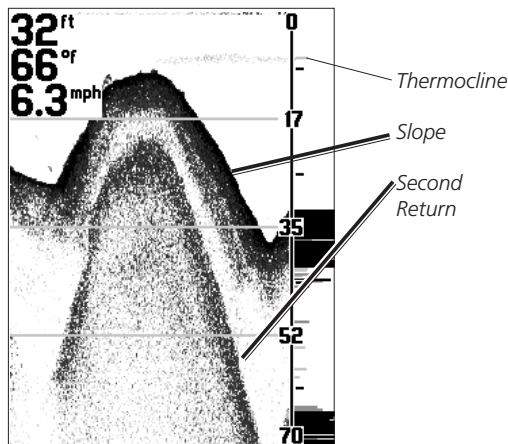

Note: It
i
s

Thermoclines

The LEGEND 3000 SERIES is also capable of showing layers of water having different temperatures. These temperature differences, called thermoclines, appear at different depths, depending on current conditions. A thermocline typically appears as a continuous band of many gray levels moving across the display at the same depth. Thermoclines always appear above the bottom.

Fish Appearance

Schools of bait fish as well as individual fish are clearly visible on the LEGEND 3000 SERIES display. Bait fish appear as "clouds" having different shapes and sizes depending on the number of fish and boat speed. Individual fish appear as smaller black and gray lines, often appearing as a "fish arch." A fish arch may form as the fish moves through the sonar beam. Due to the transducer beam angle, the distance to the fish decreases as the fish moves into the beam, and then increases as it moves out again. When the CHART WINDOW graphs this distance change, an arch appears. Boat speed, the CHART SPEED setting and movement of the fish greatly affect the shape of the arch. When the boat and the fish are moving slowly relative to each other, the fish creates an elongated arch. When the boat and the fish are moving quickly relative to each other, the fish creates a shorter arch. A partial arch forms when the fish does not move through the entire cone angle.

important to remember that sonar cannot distinguish between a fish and some other object suspended in the water. Regardless of the object the sonar detects, it has the possibility of being drawn as an arch.

Sonar Views (Deep Models Only)

The dual beam (50/200kHz) sonar information can be displayed in several different views in the CHART WINDOW. In the 200kHz view, only the sonar returns and FISH ID from the 200kHz beam are displayed. Typically, the 200kHz information provides greater bottom detail up to 800' and works well while the boat is in motion. The 50kHz view only shows the sonar returns and FISH ID from the 50kHz beam. The 50kHz information provides depth accuracy up to 2000' and shows more targets in its wider beam. The Split Screen view shows the 50kHz and 200kHz sonar information in side-by-side windows on the display. The 200kHz/50kHz view is a composite of the 200kHz sonar information and the target information from the 50kHz sonar. See CONTROL PANELS for details on selecting the sonar views.

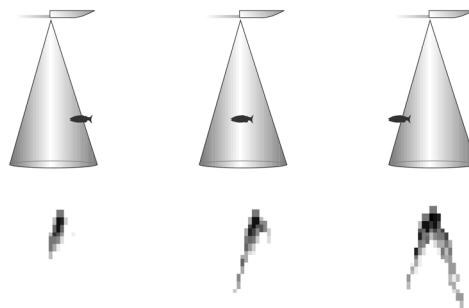

Fish Arch Diagram

USING THE LEGEND 3000 SERIES

SONAR VIEWS / CONTROL PANELS

CONTROL PANELS

Control Panels provide access to important, but infrequently-adjusted features, such as CHART SPEED, MODE, SONAR VIEW, LIGHT, CONTRAST, RTS WINDOW, SURFACE CLUTTER, WHITE LINE, FILTER, DEPTH ALARM, TEMP ALARM, FISH ALARM, FISH SENSITIVITY, FISH ID, SIMULATOR, UNITS, and, in International Models only, LANGUAGE. Control Panels allow you to set the mode of operation as well as additional features. Use the MODE to change the bottom tracking and depth range method of display, then use the other Control Panels to add features to your selected mode of operation.

Note: Only the International Models (3005 and 3005 Deep) contain a Language choice in the Control Panel, and only the International Models support multiple units of measure, such as fathoms and metres.

Note: The Sonar View, Fish ID, Fish Alarm, Fish Sensitivity, and Filter choices only appear on the Deep Model Control Panels.

CONTROL PANELS are displayed by using the CONTROL PANEL knob and adjusted by using the RANGE knob. The active CONTROL PANEL consists of three parts: the CONTROL PANEL NAME, SETTING INDICATOR, and SETTING READOUT.

The CONTROL PANEL NAME indicates the feature, the SETTING INDICATOR shows the current setting within the complete range of adjustment, and the SETTING READOUT shows the status when CONTROL PANEL is not selected.

To select a CONTROL PANEL feature for adjustment, follow these steps:

1. Press the CONTROL PANEL knob. A list of options appears on the display. The option currently selected for adjustment is indicated by a white background color.
2. Rotate the CONTROL PANEL knob to select the desired option for adjustment. Clockwise rotation selects options higher in the list; counterclockwise rotation selects options lower in the list.

Note: Not all options in the list can be viewed on the display at

one time. When the selected option is at the bottom of the list, continue turning the knob to display other options.

3. Once the desired option is selected, turn the RANGE knob to adjust. Adjustments are made immediately and are shown by an indicator on the selected CONTROL PANEL.
4. Remove the CONTROL PANELS by pushing the CONTROL PANEL knob. Alternately, after a few seconds with no knob press/turn activity, the CONTROL PANELS are removed from the display automatically.

Mode

The first Control Panel to set is Mode. Three modes of operation control the method used by the Legend 3000 Series to track the bottom, select depth ranges and graph the information on the LCD display. The Mode is selected by changing the Control Panel setting to Auto, Manual, or BTM Lock (Bottom Lock).



Automatic Mode

AUTOMATIC MODE follows the bottom contour, changing depth ranges as needed to keep the most recent sonar returns visible on the display. AUTOMATIC MODE keeps the acquired bottom visible at all times, showing sonar returns from the surface to the bottom and just beyond. This is useful when traveling across the water in areas where the depth constantly changes, requiring frequent range changes.

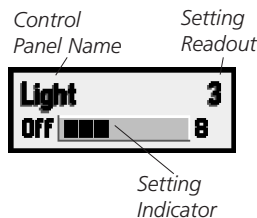
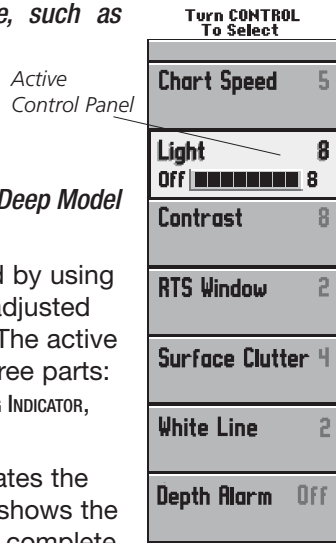

USING THE LEGEND 3000 SERIES

MODES OF OPERATION / OPTIMIZING THE DISPLAY

In AUTOMATIC mode, the LEGEND 3000 SERIES selects the depth range best suited to keep recent sonar returns visible; however, the depth range can be adjusted to optimize the display for viewing the second return. The display can also be optimized for maximum display resolution, making it possible to distinguish fish very close together or close to the bottom.

Optimizing the Depth Range for Sonar Targets

When the image of the bottom does not appear close to the bottom of the LCD display, the Legend 3000 Series is not fully

optimizing the display to show sonar targets, such as fish, that are very close together. To enhance the ability of the unit to separate sonar targets and to optimize the display for maximum resolution, follow these steps:

1. Make sure the Legend 3000 Series is operating in Automatic Mode.
2. Push the RANGE knob. An adjustment indicator appears at the lower right corner of the CHART WINDOW.
3. Turn the RANGE knob counterclockwise until the image of bottom is close to the bottom of the LCD display but still shows the area of interest.

Automatic Mode

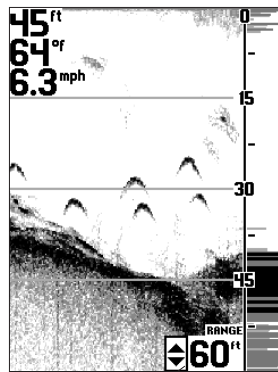

Adjustment Indicator

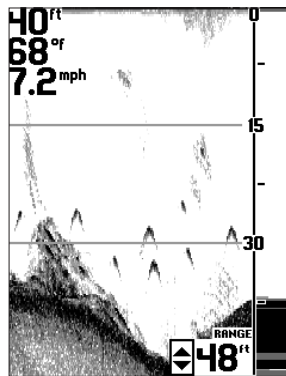

Optimized Display

Note: As the depth of the water increases, the LEGEND 3000 SERIES changes the depth range to keep the bottom on-screen. The LEGEND 3000 SERIES uses a depth range to keep the bottom contour close to the bottom of the display.

To return the depth range to normal viewing, turn the unit off and back on again using the GAIN knob. This is the only way to reset the depth range to normal viewing.

Optimizing the Depth Range for Second Return

To optimize the depth range for viewing the second return, follow these steps.

1. Make sure the LEGEND 3000 SERIES is operating in Automatic.
2. Push the RANGE knob. An adjustment indicator appears at the lower right corner of the CHART WINDOW.
3. Turn the RANGE knob clockwise until the second return is visible on the display.
4. To return the depth range to normal viewing, rotate the RANGE knob counterclockwise until the depth range stops updating.

Optimized Display showing second return

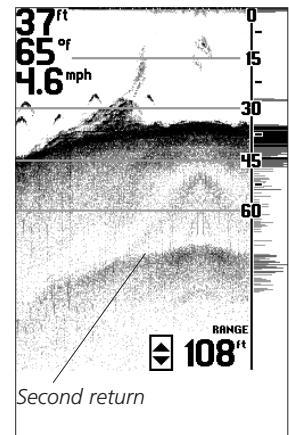

Note: The second return does not appear at many of the deeper depth ranges. The appearance of the second return depends on depth of the water, water conditions, bottom hardness and the gain setting.

The LEGEND 3000 SERIES operates with this offset depth range until it is returned to the original settings, or the unit is turned off, after which the unit defaults to factory settings.

USING THE LEGEND 3000 SERIES

BOTTOM LOCK ZOOM MODE / MANUAL MODE

Bottom Lock Zoom Mode

BTM LOCK (Bottom Lock) mode tracks the bottom similarly to Automatic mode; however, the display shows a full range view on right and a zoomed window on the left. The zoomed window provides added display resolution for separating sonar returns that are very close together, such as those caused by fish suspended close to the bottom.

As the depth changes, the LEGEND 3000 SERIES automatically keeps the bottom visible in the zoomed window and the full range view. In the full range view, horizontal zoom preview bars define the area of bottom being enlarged. The default setting varies based on the depth range; however, this setting can be changed to show more area around the bottom, or to show the bottom in greater detail.

To change the area of the bottom being zoomed, follow these steps:

1. Make sure the LEGEND 3000 SERIES is operating in BTM LOCK (Bottom Lock) mode.
2. Push the RANGE knob. An adjustment indicator appears by the lower zoom preview bar, indicating this is the selected depth limit for adjustment.

Note: Pushing the RANGE knob toggles between the upper and lower zoom preview bar adjustment. If the lower zoom preview bar is to be adjusted, push the RANGE knob until it is selected.

3. Rotate the RANGE knob to adjust the zoom preview bar. Moving the zoom preview bars closer together increases the display resolution in the zoomed window; moving them further apart decreases display resolution, but allows more area around the bottom to be viewed.

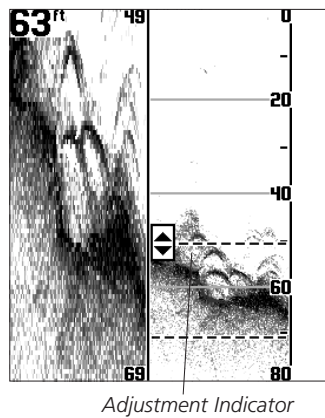
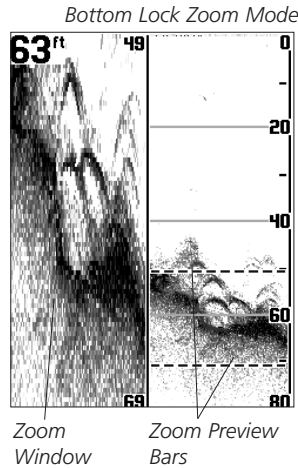
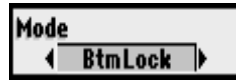

The indicators disappear after several seconds with no adjustment. The LEGEND 3000 SERIES continues to follow the bottom using the new range. Any change made to the zoom preview bars is remembered until the LEGEND 3000 SERIES is powered off, when the unit defaults to factory settings.

Manual Mode

MANUAL mode turns off automatic bottom tracking, leaving control of the depth range to the user. Both the upper and lower depth ranges can be adjusted to show the bottom, or any other desired depth, in greater detail. When first switched to MANUAL mode, the LEGEND 3000 SERIES defaults to the current automatic depth range; however, after the manual depth ranges have been set, the LEGEND 3000 SERIES uses the new settings until it is powered off, when it defaults to factory settings.

MANUAL mode works best in areas of relatively flat bottom or if you are trolling slowly. It is also ideal for displaying a small area of the overall depth range in great detail if you are looking for fish at a specific depth.

To adjust the depth ranges manually, follow these steps:

1. Make sure the Legend 3000 Series is operating in Manual mode.
2. Push the Range knob. An adjustment indicator appears at the location of the Lower Depth Range, indicating that it is ready for adjustment.

Note: Pushing the Range knob toggles between the upper and lower depth range selection. If the Upper Depth Range is to be adjusted, push the Range knob until it is highlighted.

3. Rotate the RANGE knob to adjust the Depth Range. Clockwise rotation increases the depth; counterclockwise rotation decreases the depth. The display updates as the changes are made.

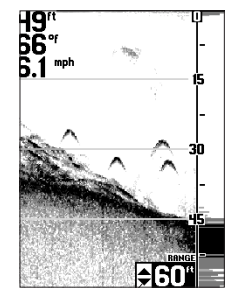
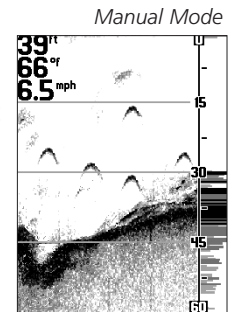

Lower Depth Range Adjustment Indicator

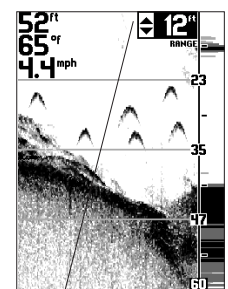

Upper Depth Range Adjustment Indicator

USING THE LEGEND 3000 SERIES

CHART SPEED / SONAR VIEW / LIGHT / CONTRAST / RTS WINDOW

After several seconds without pressing or turning the knob, the DEPTH RANGE adjustment indicator will disappear from the screen automatically. The LEGEND 3000 SERIES does not make adjustments to keep the bottom information on-screen. If the depth is deeper or shallower than the ranges on the display, the bottom contour will not be visible.

The manual range settings made to the LEGEND 3000 SERIES default to factory settings after the unit is turned off.

Chart Speed

CHART SPEED selects the speed at which the bottom information moves across the display. Options available range from 1 (very slow) to 8 (very fast). Selecting a faster rate shows more information in the CHART WINDOW, but it moves across the display very quickly. Selecting a slower rate keeps the information on the display longer, but the chart information becomes compressed and may be more difficult to interpret. Setting CHART SPEED in relation to boat speed is often preferred.

The CHART SPEED setting is retained in memory after the LEGEND 3000 SERIES is turned off. The factory setting is 6.



Sonar View

SONAR VIEW (Deep Models only) selects the source of the sonar information being displayed. 200kHz displays sonar information and FISH ID from the 200kHz beam only. 50kHz displays sonar information and FISH ID from the 50kHz beam only. SPLIT SCREEN presents the sonar information from the 200kHz and 50kHz beams simultaneously in side-by-side windows. 200kHz/50kHz displays the sonar information from the 200kHz beam and target information from the 50kHz beam.

The SONAR VIEW setting is retained in memory after the unit is turned off. The factory setting is 200kHz.

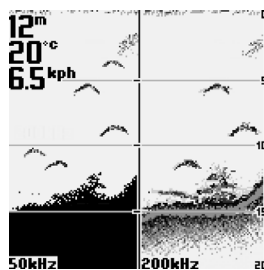

Split window 50kHz/200kHz, shown with metric depth, °C and kph digital readouts available on international models.

Light

LIGHT activates the display backlight and selects the brightness level. The backlight is manually-controlled except when the unit first powers up. During initial power up, the backlight turns on at full brightness so the display will be visible at night. The backlight will then begin to decrease in intensity automatically until it is off in order to save energy. Selecting the CONTROL PANEL LIGHT choice stops the automatic off process, keeping the backlight on at the intensity level selected.

The Light setting defaults to factory settings after the Legend 3000 Series is turned off. The factory setting is On full at power up and automatic decrease to Off.

Contrast

CONTRAST enhances the viewability of the LCD by making it darker or lighter. Selecting a higher number darkens the display; selecting a lower number lightens the display. The LEGEND 3000 SERIES uses sophisticated electronics to adjust the contrast level automatically; however, at times of extreme heat or cold, manually adjusting the contrast for best display may be needed.

The CONTRAST setting is retained in memory after the unit is turned off as long as it is set between 6 and 10. The factory setting is 8.



RTS Window

RTS WINDOW selects the width of the window dedicated to REAL TIME SONAR™. Selecting NARROW decreases the width of the RTS WINDOW leaving more space for the CHART WINDOW, but some sonar returns will not be visible. Selecting WIDE makes the RTS WINDOW wider and shows more of the sonar intensity information, but less space on the LCD is available for sonar history. Selecting OFF turns off the RTS WINDOW and the entire LCD shows sonar history.

Note: When the RTS Window is adjusted to Wide, no grayscale information is shown.

The RTS WINDOW setting is retained in memory after the LEGEND 3000 SERIES is turned off. The factory setting is NARROW.



USING THE LEGEND 3000 SERIES

SURFACE CLUTTER / WHITE LINE / FILTER / DEPTH ALARM / TEMP ALARM

Surface Clutter

SURFACE CLUTTER eliminates most sonar returns near the water surface caused by trapped air, boat wakes and temperature inversions. Most surface clutter appears on the display because the strongest sonar returns come from the shallowest objects. The **LEGEND 3000 SERIES** uses a sophisticated feature called TVG (Time Variable Gain) to overcome surface clutter and counteract the effect of depth on sonar return strength. The level 1 setting is optimal for making sonar information from all depths appear uniformly. Many users, however, prefer to see more surface clutter than this setting shows. Selecting a higher number shows more surface clutter, but sonar returns nearest the surface will appear more intense than they actually are.

The **SURFACE CLUTTER** setting is retained in memory after the **LEGEND 3000 SERIES** is turned off. The factory setting is 4.



along the bottom contour, structure and fish. Selecting a larger numeric setting increases the width of the band and makes fainter sonar returns more noticeable, but the **LEGEND 3000's** ability to show subtle differences in bottom composition and structure is reduced. Selecting a smaller numeric setting narrows the band and shows greater variation in bottom composition. Selecting **OFF** turns the **WHITE LINE** feature off.

The **WHITE LINE** setting is retained in memory after the **LEGEND 3000 SERIES** is turned off. The factory setting is **OFF**.

Filter

FILTER (**DEEP** Models only) turns the filtering algorithms on and off.



Select **On** to filter excess sonar noise. Select **Off** to show the greatest amount of sonar information.

The **FILTER** setting is retained in memory after the **3000 Deep/3005 Deep** is turned off. The factory setting is **On**.

50kHz Gain Offset (Deep Models Only)

The **GAIN** knob applies the same gain increase/decrease to the 200kHz and 50kHz signal performance. This menu allows for the gain applied to the 50kHz beam to be adjusted higher or lower than the **GAIN** knob setting to optimize it. An offset value of 5 applies the same gain to the 50kHz signal as the 200kHz gain set by the **GAIN** knob. Values higher than 5 apply more gain to the 50kHz, values lower than 5 apply less gain.

The **50kHz GAIN OFFSET** setting is retained in memory after the **Legend 3000/3005 Deep** is turned off. The factory setting is 5.



Depth Alarm

DEPTH ALARM activates a shallow water depth alarm. The alarm will sound when the digital depth becomes equal to or less than the setting. The tone sounds at a rapid rate for several seconds and then sounds intermittently until the boat moves to deeper water. The **DEPTH ALARM** can be muted by pressing the **CONTROL PANEL** knob; once muted, the alarm will not sound again until the boat moves to water deeper than the **DEPTH ALARM** setting. International models have **Depth Alarm** settings in full metres from 1 m to 99m.



Note: Remember that depth is measured from the transducer, not from the surface of the water.

The **DEPTH ALARM** setting returns to factory default after the **LEGEND 3000 SERIES** is turned off. The factory setting is **Off**.

White Line

WHITE LINE activates and adjusts a feature which changes how the **LEGEND 3000 SERIES** draws the bottom contour and structure, and also shows fainter sonar returns more clearly. When a **WHITE LINE** setting of 1 to 8 is selected, a light gray band highlights the strongest sonar returns within the sonar image and makes a distinctive outline

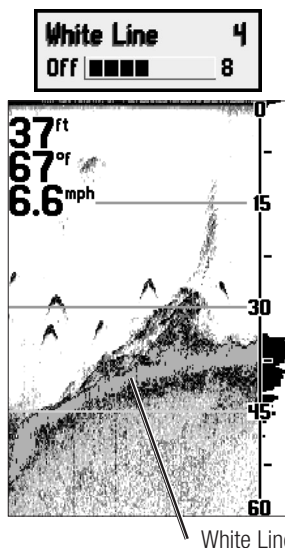

USING THE LEGEND 3000 SERIES

UPPER TEMP / LOWER TEMP / FISH ALARM / FISH SENSITIVITY / FISH ID

Temp Alarm

Temp Alarm activates an alarm that sounds when the surface water temperature changes to fall within or outside selected ranges. These temperature boundaries help define bodies of water that are comfortable for and or are feeding zones for fish. Upper and lower temperatures are set depending on the species of fish being sought. Two basic actions can be selected to trigger an alarm, either entering inside a temperature range or exiting – moving outside a temperature range. Both combines Inside and Outside settings, alarming when crossing a temperature boundary. The Temp Alarm can be muted by pressing the Control Panel knob; once muted, the alarm will not sound again until triggered by a new boundary crossing.

The TEMP ALARM setting returns to factory default after the LEGEND 3000 SERIES is turned off. The factory setting is OFF.

Note: You must select a Temp Alarm mode (INSIDE, OUTSIDE, or BOTH), then set the UPPER TEMP and the LOWER TEMP in order for this feature to work.

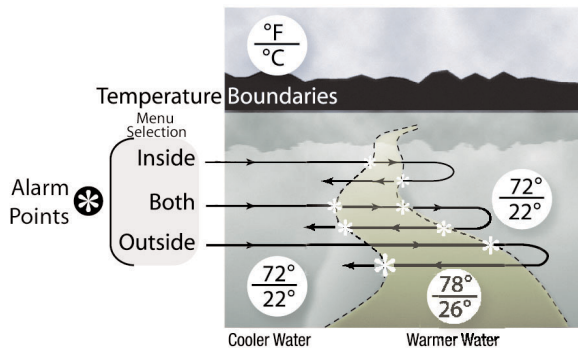

UPPER TEMP is the upper temperature boundary for the temperature alarm. The inside temp alarm will sound when the water temperature was initially above the upper temp boundary and then falls below it. The outside temp alarm will sound when the water temperature was initially below the temp boundary and then rises above it.

The UPPER TEMP setting is retained in memory after the LEGEND 3000 SERIES is turned off. The factory setting is 78° F / 26° C.



LOWER TEMP is the lower temperature boundary for the temperature alarm. The inside temp alarm will sound when the water temperature was initially below the lower temp boundary and then rises above it. The outside temp alarm will sound when the water temperature was initially above the temp boundary and then falls below it.

The LOWER TEMP setting is retained in memory after the Legend 3000 Series is turned off. The factory setting is 72° F / 22° C.



Fish Alarm

FISH ALARM (Deep Models only) will sound when a fish (or other target not connected to the bottom) that meets the selected size criteria is detected by the sonar. The FISH ALARM has four different settings, OFF plus the three different fish symbols shown onscreen (see FISH ID). The 3000 Deep/3005 Deep can be set to alarm only large fish, (displayed as a large fish symbol), only large and medium fish (displayed as one large and one medium fish symbol), or all sizes of fish (displayed as one large, one medium, and one small fish symbol).

The FISH ALARM setting is retained in memory after the 3000 Deep/3005 Deep is turned off. The factory setting is OFF.

Fish Sensitivity

FISH SENSITIVITY (Deep Models only) adjusts the sensitivity of the fish detection algorithms separately from the sonar gain control knob. Selecting a positive offset makes the fish detection more sensitive (+5 = greatest sensitivity). Selecting a negative offset makes the fish detection less sensitive (-5 = least sensitivity).

The FISH SENSITIVITY setting is retained in memory after the 3000 Deep/3005 Deep is turned off. The factory setting is 0.

Fish ID

FISH ID (Deep Models only) uses advanced signal processing to evaluate further any sonar return between the surface and the bottom. If the return meets certain additional criteria, a fish symbol will be assigned. There are three different fish symbols to indicate the intensity of the sonar return. While signal intensity is a good indicator of fish size,



MAINTENANCE AND WARRANTY

CONTROL PANELS / MAINTENANCE/TROUBLESHOOTING

different species of fish have different sonar characteristics, so it is not always possible to distinguish fish size amongst varying species. Selecting **FRESHWATER** will adjust the algorithms toward freshwater species of fish, while selecting **SALTWATER** will adjust the algorithms towards saltwater species.

Note: The signal intensity is “normalized” for depth so that a small fish close to the boat will not appear as a large fish symbol. The digital depth of the designated fish is also shown to help locate the fish vertically. This is especially helpful in setting bait depths or for downrigger operation.

The **FISH ID** setting is retained in memory after the **3000 DEEP/3005 DEEP** is turned off. The factory setting is **Off**.

Simulator

SIMULATOR allows the **LEGEND 3000 SERIES** to operate in simulated sonar mode. This is useful for learning the features and functionality of the **LEGEND 3000 SERIES** when not on the water. Settings to Control Panels that are retained in normal operation will be retained in Simulator Mode if a transducer is connected. When operating with the Simulator on and without a transducer connected, the Legend 3000 Series does not remember any changes to settings.

The Simulator setting defaults to factory settings after the Legend 3000 Series is turned off.



Units

UNITS selects the units of measure for boat speed. Selecting **KTS** displays the speed in nautical miles per hours; **MPH** displays the speed in miles per hour. **UNITS** selects the units of measure for boat speed and depth in one of two combinations supported by every **LEGEND 3000 SERIES**:

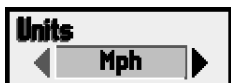

- **FEET/MPH** displays depth in feet and speed in miles per hour.
- **FEET/KTS** displays depth in feet and speed in nautical miles per hour.

UNITS also selects the units of measure for boat speed and depth in one of four additional combinations supported by the International Models only:

- **METRES/KPH** displays depth in metres/speed in kilometres per hour.
- **METRES/KTS** displays depth in metres/speed in nautical miles per hour.
- **FATHOMS/KTS** displays depth in fathoms/speed in

nautical miles per hour.

- **FATHOMS/KPH** displays depth in fathoms/speed in kilometres per hour.

The **UNITS** settings are retained in memory after the unit is turned off.

Language

LANGUAGE (International Models only) selects the language for text used in the **CONTROL PANELS** and for messages. See the



LEGEND 3005/3005 DEEP Specifications for included languages.

LANGUAGE setting is retained in memory after the **LEGEND 3005 /3005 DEEP** is turned off. The factory setting is **ENGLISH**.

MAINTENANCE

Your **LEGEND 3000 SERIES** is designed to provide years of trouble-free operation with virtually no maintenance. Follow these simple procedures to ensure your **LEGEND 3000 SERIES** continues to deliver top performance.

Cleaning

If the unit comes into contact with salt spray, simply wipe the affected surfaces with a cloth dampened in fresh water. Do not use a chemical glass cleaner on the lens, as chemicals in the solution may crack the lens.

When cleaning the LCD protective lens, use a chamois and non-abrasive, mild cleaner. Do not wipe while dirt or grease is on the lens. Be careful to avoid scratching the lens.

If your boat remains in the water for long periods of time, algae and other marine growth can reduce the effectiveness of the transducer. Periodically clean the face of the transducer with liquid detergent. Pivoting the transducer up in the bracket may allow better access for inspection or cleaning.

Wetting the Transducer

If your boat remains out of the water for a long period of time, it may take some time to wet the transducer when returned to the water. Small air bubbles can cling to the surface of the transducer and interfere with proper operation. These bubbles dissipate with time, or you can wipe the face of the transducer with your fingers after the transducer is in the water.

Heat Damage

Never leave the **LEGEND 3000 SERIES** in a closed car or trunk—the extremely high temperatures generated in hot weather can damage the electronics.

TROUBLESHOOTING

Repairs

Do not attempt to repair the **LEGEND 3000 SERIES** yourself. There are no user-serviceable parts inside, and special tools and techniques are required for reassembly to ensure the waterproof integrity of the housing. Repairs should be performed only by authorized Techsonic technicians.

Before You Call Customer Support

Many requests for repair received by Techsonic involve units that do not actually need repair. These units are returned “no problem found.” If you have a problem with your **LEGEND 3000 SERIES**, use the following troubleshooting guide before calling Customer Support or sending your unit in for repair. The **LEGEND 3000 SERIES** contains several tools that can aid in determining if there is a problem, as well as how to isolate and repair a problem in many cases.

1. Nothing happens when I turn the unit on.

Check the power cable connection at both ends. Be sure the cable is connected correctly to a reliable power source—red lead to positive, black lead to negative or ground. Ensure the power available at the mount is between 10 and 20 VDC. If the unit is wired through a fuse panel, ensure the panel is powered; accessory fuse panels often are controlled by a separate switch or by the boat’s ignition switch. A fuse also can appear to be good when in fact it is not. Check the fuse with a tester or replace it with a fuse known to be good.

Check the power connection to the **LEGEND 3000 SERIES**. It is possible to force the power cable connector into the collector plug incorrectly. If the connector is reversed, the unit will not work. Examine the contacts on the back of the unit to ensure there is no corrosion.

Ensure the cables are properly installed into the collector plug and the collector plug is properly seated into the **LEGEND 3000 SERIES**.

2. The unit starts up in Simulator mode.

The **LEGEND 3000 SERIES** has the ability to detect that a transducer is connected. If, at power up, a transducer is not connected, the unit starts up in **SIMULATOR** mode.

Ensure that an appropriate transducer connector is used and the connector is positioned correctly in the collector plug. Also, be sure that the collector plug is fully-seated into the unit. Next, inspect the transducer cable from end to end for breaks, kinks, or cuts in the outer casing of the cable, and repair after

disconnecting the cable from both the unit and the transducer. Also, make sure that the transducer is fully submerged in water. If the transducer is connected to the unit through a switch, temporarily connect it directly to the unit and try again. If none of these items identifies an obvious problem, the transducer itself may be at fault. Be sure to include the transducer if returning the unit for repair.

To override the **SIMULATOR** manually, select the **SIMULATOR CONTROL PANEL** and turn to **OFF**. See Control Panels for more information.

3. There is no bottom reading visible on the display.

There are several possible causes for this condition. If the loss of bottom information occurs only at high boat speeds, the transducer needs to be adjusted. If the digital depth readout is working but there is no bottom visible on-screen, it is possible that the depth range has been adjusted manually to a range lower than that needed to display the bottom. Also, in very deep water, it may be necessary to increase the **GAIN** setting manually in order to maintain a graphic depiction of the bottom.

If you are using a transducer switch to connect two transducers to the **LEGEND 3000 SERIES**, make sure that the switch is in the correct position to connect a transducer, and that the transducer is submerged in water. (If a trolling motor transducer is selected and the trolling motor is out of the water, no sonar information will appear.)

If none of the above solves the problem, inspect the transducer cable from end to end for breaks, kinks, or cuts in the outer casing of the cable, and repair after disconnecting the cable from both the unit and the transducer. If the transducer is connected to the unit through a switch, temporarily connect it directly to the unit and try again. If none of these items identifies an obvious problem, the transducer itself may be at fault. Be sure to include the transducer if returning the unit for repair.

4. When in very shallow water, I get gaps in the bottom reading and inconsistent digital depth indications.

The **LEGEND 3000 SERIES** will work reliably in water 2' (.6m) or deeper. Remember that the depth is measured from the transducer, not necessarily from the surface of the water.

MAINTENANCE AND WARRANTY

TROUBLESHOOTING / WARRANTY / SERVICE POLICY

5. The unit comes on before I press POWER, and won't turn off.

Check the transducer cable—if the outer jacket of the cable has been cut and the cable is in contact with bare metal, you need to disconnect the cable from the unit, then repair the cut with electrical tape. If there is no problem with the cable, disconnect the transducer from the unit and see if the problem is corrected, to isolate the source of the problem.

6. I get gaps in the reading at high speeds.

Your transducer needs to be adjusted. If the transducer is transom-mounted, there are two adjustments available to you: height and running angle. Make small adjustments and run the boat at high speeds to determine the effect. It may take several tries to optimize high speed operation. This can also be a result of air or turbulence in the transducer location caused by rivets, ribs, etc.

7. My unit loses power at high speeds.

Your **LEGEND 3000 SERIES** has over-voltage protection that turns the unit off when input voltage exceeds 20 VDC. Some outboard motors do not regulate the power output of the engine's alternator effectively and can produce voltage in excess of 20 volts when running at high RPMs. The **LEGEND 3000 SERIES** displays input voltage in the lower left corner of the display when it exceeds 15 VDC. Use this readout to determine if the voltage exceeds 20 VDC.

8. The screen begins to fade out. Images are not as sharp as normal.

Check the input voltage. The **LEGEND 3000 SERIES** will display the current voltage on-screen if it is greater than 16 or less than 10 VDC. The voltage readout will appear in the bottom left corner of the screen.

9. The display shows many black dots at high speeds and high sensitivity settings.

You are seeing noise or interference caused by one of several sources. Noise can be caused by other electronic devices. Turn off any nearby electronics and see if the problem goes away. Noise can also be caused by the engine. If engine noise is causing the interference, the problem will intensify at higher RPMs. Increase the engine speed with the boat stationary to isolate this cause. Propeller cavitation can appear as noise on-screen. If the transducer is mounted too close to the propeller, the turbulence generated can interfere with the sonar signal. Ensure that the transducer is mounted at least 15" (38cm) from the prop.

10. The screen does not display a full fish arch.

Check the running angle of the transducer. If the running angle is too great, a full fish arch may not appear. Reduce the running angle of the transducer. Several incremental adjustments may be necessary.

TECHSONIC INDUSTRIES, INC. ONE YEAR LIMITED WARRANTY

We warrant the original retail purchaser that products made by Techsonic Industries have been manufactured free from defects in materials and workmanship. This warranty is effective for one year from the date of original retail purchase. Techsonic Industries products found to be defective and covered by this warranty will be replaced or repaired free of charge at Techsonic Industries' option and returned to the customer freight prepaid. Techsonic Industries' sole responsibility under this warranty is limited to the repair or replacement of a product that has been deemed defective by Techsonic Industries. Techsonic Industries is not responsible for charges connected with the removal of such product or reinstallation of replaced or repaired parts.

This warranty does not apply to a product that has been:

- Improperly installed;
- Used in an installation other than that recommended in the product installation and operation instructions;
- Damaged or has failed because of an accident or abnormal operation;
- Repaired or modified by entities other than Techsonic Industries.

Please retain your original receipt as a proof of the purchase date. This will be required for in-warranty service.

THIS WARRANTY IS EXPRESSLY IN LIEU OF ANY OTHER WARRANTIES, OBLIGATIONS OR LIABILITIES ON THE PART OF TECHSONIC INDUSTRIES AND WILL BE THE CUSTOMER'S EXCLUSIVE REMEDY, EXCEPT FOR ANY APPLICABLE IMPLIED WARRANTIES UNDER STATE LAW WHICH ARE HEREBY LIMITED IN DURATION TO ONE YEAR FROM THE DATE OF ORIGINAL PURCHASE. IN NO EVENT WILL TECHSONIC INDUSTRIES BE LIABLE FOR ANY INCIDENTAL OR CONSEQUENTIAL DAMAGES FOR BREACH OF ANY EXPRESS OR IMPLIED WARRANTY RELATING TO THE PRODUCTS.

Some states do not allow limitations on an implied warranty, or the exclusion of incidental or consequential damages, so the above exclusions may not apply to you. You may also have other rights, which vary from state to state.

A separate Warranty is provided by international distributors for the international models. This warranty is included by your local distributor and this distributor maintains local service for your unit.

CUSTOMER RESOURCE CENTER

SERVICE POLICY / SERVICE PROCEDURES

Techsonic Industries Service Policy

Even though you'll probably never need to take advantage of our incredible service policy, it's good to know that we back our products this confidently. We do it because you deserve the best. We will make every effort to repair your unit within three business days from the receipt of your unit at our factory. This does not include shipping time to and from our factory. Units received on Friday are typically shipped by the following Wednesday, units received Monday are typically shipped by Thursday, etc.

All repair work is performed by factory-trained technicians to meet exacting factory specifications.

Factory-serviced units go through the same rigorous testing and quality control inspections as new production units.

After the original warranty period, a standard flat rate service charge will be assessed for each repair (physical damage and missing parts are not included). Any repairs made after the original warranty will be warranted for an additional 90 days after service has been performed by our factory technicians. You can contact our Customer Resource Center or visit our website to verify the flat rate repair fee for your product (visit the Product Support section):

<http://www.humminbird.com>

We reserve the right to deem any product unserviceable when replacement parts are no longer available or impossible to obtain. This Service Policy is valid in the United States only. This applies only to Humminbird products returned to our factory in Eufaula, Alabama. This Service Policy is subject to change without notice.

Returning Your Unit for Service

Before sending your unit in for repair, please contact the factory, either by phone or by email, to obtain a Repair Authorization Number for your unit. Please have your product model name and serial number available before calling the factory. If you contact the factory by e-mail, please include your product model name and serial number in the e-mail, and use Request for Repair Authorization Number for your e-mail subject header. You should include your Repair Authorization Number in all subsequent communications about your unit.

For IN-WARRANTY service, complete the following steps:

- Obtain a Repair Authorization Number from Techsonic Industries Customer Resource Center.
- Tag product with your customer name, street address, phone number and your assigned Repair
- Authorization Number.
- Include a brief written description of the problem.
- Include a copy of your receipt (to show proof and date of purchase).
- Return product freight prepaid to Techsonic Industries, Inc., using an insured carrier with delivery confirmation.

For OUT-OF-WARRANTY service, complete the following steps:

- Obtain a Repair Authorization Number from Techsonic Industries Customer Resource Center.
- Included payment in the form of credit card number and expiration date, money order or personal check. Please do not send cash.
- Tag product with your customer name, street address, phone number and your assigned Repair Authorization Number.
- Include a brief written description of the problem.
- Return product freight prepaid to Techsonic Industries, Inc., using an insured carrier with delivery confirmation.

Contacting Humminbird

Contact the Humminbird Customer Resource Center in any of the following ways:

By Telephone

(Monday - Friday 8:00 a.m. to 4:30 p.m. Central Standard Time):

334-687-0503

By e-mail

(typically we respond to your e-mail within three business days):

custserv@techsonic.com

For direct shipping, our address is:

Techsonic Industries, Inc.

Service Department

108 Maple Lane

Eufaula, AL 36027 USA

SPECIFICATIONS

3000/3005 SPECIFICATIONS

Operating Frequency	200 kHz
Power Output	4000 Watts (Peak to Peak) 500 Watts (RMS)
Area of Coverage	24° at -3 dB
Power Requirement	10 - 20 VDC
Display	8 level FSTN Grayscale LCD
LCD Matrix	160 H x 160 V
Viewing Area	3 ³ / ₅ " H x 3 ³ / ₅ " V
Mounting	.In-dash or Gimbal
Unit Size	4 ¹³ / ₁₆ " V x 6 ³ / ₁₆ " W x 2 ³ / ₄ " D
Transducer	Single beam
Transducer Cable Length	20' (6 metres)

3000 DEEP/3005 DEEP SPECIFICATIONS

Operating Frequencies	50/200 kHz
Power Output	4000 Watts (Peak to Peak) 500 Watts (RMS)
Area of Coverage	20° and 74° at -10 dB
Power Requirement	10 - 20 VDC
Display	8 level FSTN Grayscale LCD
LCD Matrix	160 H x 160 V
Viewing Area	3 ³ / ₅ " H x 3 ³ / ₅ " V
Mounting	.In-dash or Gimbal
Unit Size	4 ¹³ / ₁₆ " V x 6 ³ / ₁₆ " W x 2 ³ / ₄ " D
Transducer	Dual beam
Transducer Cable Length	20' (6 metres)

3005/3005 DEEP SPECIFICATIONS (INTERNATIONAL MODELS)

Languages Supported Include: English, Dansk, Deutsch, Español, Finnish/Svomi, Français, Italiano, Nederlands, Norsk, Português, Svenska, Magvar and Polski.

Additional units of measurement: Metres, Fathoms and °C.

Free Manuals Download Website

<http://myh66.com>

<http://usermanuals.us>

<http://www.somanuals.com>

<http://www.4manuals.cc>

<http://www.manual-lib.com>

<http://www.404manual.com>

<http://www.luxmanual.com>

<http://aubethermostatmanual.com>

Golf course search by state

<http://golfingnear.com>

Email search by domain

<http://emailbydomain.com>

Auto manuals search

<http://auto.somanuals.com>

TV manuals search

<http://tv.somanuals.com>