

700 Series™ Operations Manual

531524-1



700 series™

Thank You!

Thank you for choosing Humminbird®, America's #1 name in fishfinders. Humminbird® has built its reputation by designing and manufacturing top-quality, thoroughly reliable marine equipment. Your Humminbird® is designed for trouble-free use in even the harshest marine environment. In the unlikely event that your Humminbird® does require repairs, we offer an exclusive Service Policy - free of charge during the first year after purchase, and available at a reasonable rate after the one-year period. For complete details, see the separate warranty card included with your unit. We encourage you to read this operations manual carefully in order to get full benefit from all the features and applications of your Humminbird® product.

Contact our Customer Resource Center at either **1-800-633-1468** or visit our website at **www.humminbird.com**.

WARNING! *This device should not be used as a navigational aid to prevent collision, grounding, boat damage, or personal injury. When the boat is moving, water depth may change too quickly to allow time for you to react. Always operate the boat at very slow speeds if you suspect shallow water or submerged objects.*

WARNING! *Disassembly and repair of this electronic unit should only be performed by authorized service personnel. Any modification of the serial number or attempt to repair the original equipment or accessories by unauthorized individuals will void the warranty. Handling and/or opening this unit may result in exposure to lead, in the form of solder.*

WARNING! *This product contains lead, a chemical known to the state of California to cause cancer, birth defects and other reproductive harm.*

NOTE: *Some features discussed in this manual require a separate purchase, and some features are only available on international models. Every effort has been made to clearly identify those features. Please read the manual carefully in order to understand the full capabilities of your model.*

Humminbird®, DualBeam PLUS™, SmartCast®, Selective Fish ID+™, WhiteLine®, QuadraBeam PLUS™, RTS®, X-Press™ Menu, Fish ID+™, WideSide®, Structure ID®, TrueArch™, UltraBlack™, Angler Profile Presets™, and WeatherSense® are trademarked by or registered trademarks of Humminbird®.

© 2006 Humminbird®, Eufaula AL, USA. All rights reserved.

Table of Contents

How Sonar Works	1
DualBeam PLUS™ Sonar	3
QuadraBeam PLUS™ Sonar (<i>with optional-purchase QuadraBeam PLUS™ transducer</i>)	4
WideSide® Sonar (<i>with optional-purchase WideSide® transducer</i>)	5
Universal Sonar 2	6
What's On the Display	7
Views	9
Sonar View	10
Understanding Sonar History	11
Real Time Sonar (RTS®) Window	12
Freeze Frame and Cursor	12
Bottom Presentation	13
Sonar Zoom View	16
200/83 kHz Split Sonar View	17
Big Digits View	18
Circular Flasher View	19
Side Beam View (<i>with optional-purchase QuadraBeam PLUS™ transducer</i>)	20
WideSide® View (<i>with optional-purchase WideSide® transducer</i>)	23
Key Functions	24
POWER/LIGHT Key	24
VIEW Key	24
MENU Key	25
4-WAY Cursor Control Key	25
EXIT Key	26
Accessory Bus	27
Powering Up the Unit	28
The Menu System	29
Start-Up Options Menu	31
Normal Operation	31
Simulator	32
System Status	33
Self Test	33
Accessory Test	34
PC Connect (<i>with PC Connect Cable Only</i>)	34

Table of Contents

Sonar X-Press™ Menu	35
Side (<i>WideSide® transducer: WideSide® view only</i>)	36
Sensitivity	37
Upper Range (<i>Advanced: Sonar, Split Sonar, Big Digits and Circular Flasher Views only</i>)	38
Lower Range	39
Side Beam Range (<i>WideSide® transducer: WideSide® view only</i>)	40
Chart Speed	41
Bottom View	41
Quad Layout (<i>with optional-purchase QuadraBeam PLUS™ transducer, Side Beam View only</i>)	42
Zoom Level (<i>Sonar Zoom view only</i>)	43
Bottom Lock	43
Bottom Range (<i>Sonar Zoom View only, when Bottom Lock is On</i>)	44
Sonar Menu Tab	45
Beam Select	46
Fish ID+™	47
Fish ID Sensitivity	48
Real Time Sonar (RTS®) Window	48
Zoom Width	49
83 kHz Sensitivity (<i>Advanced</i>)	49
455 kHz Sensitivity (<i>Advanced, with QuadraBeam PLUS™ transducer</i>)	50
WideSide® Sensitivity (<i>Advanced, with WideSide® transducer</i>)	51
Depth Lines (<i>Advanced</i>)	52
Surface Clutter (<i>Advanced</i>)	53
Noise Filter (<i>Advanced</i>)	54
Max Depth (<i>Advanced</i>)	54
Water Type (<i>Advanced</i>)	55
Transducer Select	56
Alarms Menu Tab	57
Depth Alarm	58
Fish ID Alarm	58
Low Battery Alarm	59
Aux. Temp. Alarm (<i>with optional-purchase temp. probe or Temp/Speed only</i>)	59
Temp Alarm	60
Alarm Tone	60
Setup Menu Tab	61
Units - Depth	62
Units - Temp (<i>International only</i>)	62

Table of Contents

Units - Distance <i>(with Temp/Speed or GPS receiver)</i>	62
Units - Speed <i>(with Temp/Speed or GPS receiver)</i>	63
User Mode	63
Language <i>(International only)</i>	63
Triplot Reset <i>(with Temp/Speed or GPS receiver)</i>	64
Restore Defaults	64
Select Readouts <i>(Advanced, Sonar view only)</i>	65
Depth Offset <i>(Advanced)</i>	67
Aux. Temp. Offset <i>(Advanced; with optional-purchase temp. probe or Temp/Speed only)</i>	67
Temp Offset <i>(Advanced)</i>	68
Speed Calibration <i>(Advanced, with Temp/Speed only)</i>	68
Digits Format <i>(Advanced)</i>	69
NMEA Output <i>(Advanced)</i>	70
Views Menu Tab	71
Accessories Menu Tab	72
Troubleshooting	73
700 Series™ Doesn't Power Up	73
700 Series™ Defaults to Simulator with a Transducer Attached	73
Display Problems	74
Finding the Cause of Noise	75
700 Series™ Fishing System Accessories	76
Specifications	78
Glossary	81
Contact Humminbird®	91

NOTE: Entries in this Table of Contents which list *(International only)* are only available on products sold outside of the US by our authorized International Distributors. To obtain a list of authorized International Distributors, please visit our website at www.humminbird.com or contact our Customer Resource Center at **1-800-633-1468** to locate the distributor nearest you.

NOTE: Entries in this Table of Contents which list *(with Temp/Speed or GPS Receiver)*, or *(with PC Connect Cable Only)* require the purchase of separate accessories. You can visit our website at www.humminbird.com to order these accessories online or contact our Customer Resource Center at **1-800-633-1468**.

How Sonar Works

Sonar technology is based on sound waves. The 700 Series™ Fishing System uses sonar to locate and define structure, bottom contour and composition, as well as depth directly below the transducer.

Your 700 Series™ Fishing System sends a sound wave signal and determines distance by measuring the time between the transmission of the sound wave and when the sound wave is reflected off of an object; it then uses the reflected signal to interpret location, size, and composition of an object.

Sonar is very fast. A sound wave can travel from the surface to a depth of 240 ft (70 m) and back again in less than 1/4 of a second. It is unlikely that your boat can "outrun" this sonar signal.

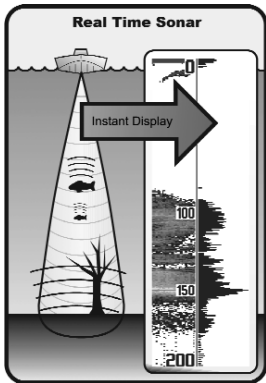

SONAR is an acronym for SOund and NAVigation Ranging. Sonar utilizes precision sound pulses or "pings" which are emitted into the water in a teardrop-shaped beam.

The sound pulses "echo" back from objects in the water such as the bottom, fish and other submerged objects. The returned echoes are displayed on the LCD screen. Each time a new echo is received, the old echoes are moved across the LCD, creating a scrolling effect.

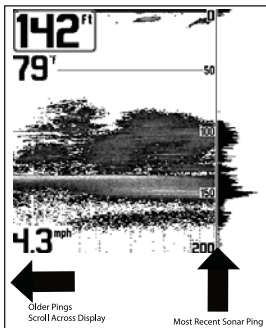

When all the echoes are viewed side by side, an easy to interpret "graph" of the bottom, fish and structure appears.

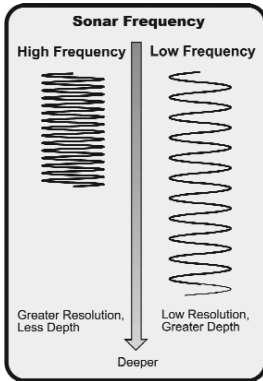

The sound pulses are transmitted at various frequencies depending on the application. Very high frequencies (455 kHz) are used for greatest definition but the operating depth is limited. High frequencies (200 kHz) are commonly used on consumer sonar and provide a good balance between depth performance and resolution. Low frequencies (83 kHz) are typically used to achieve greater depth capability.

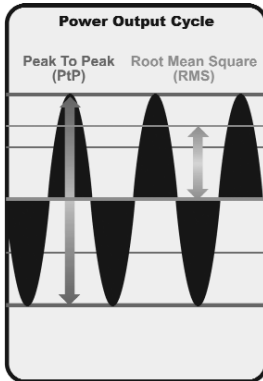

The power output is the amount of energy generated by the sonar transmitter. It is commonly measured using two methods:

- **Root Mean Square (RMS)** measures power output over the entire transmit cycle.
- **Peak to Peak** measures power output at the highest points.

The benefits of increased power output are the ability to detect smaller targets at greater distances, ability to overcome noise, better high speed performance and enhanced depth capability.

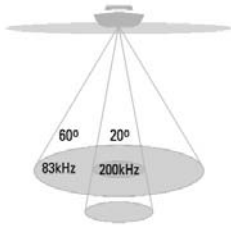

❖ 60 Degree Total Coverage

❖ Bottom Coverage = 1 x Depth



DualBeam PLUS™ Sonar

Your 700 Series™ Fishing System uses a 200/83 kHz DualBeam PLUS™ sonar system with a wide (60°) area of coverage. DualBeam PLUS™ sonar has a narrowly focused 20° center beam, surrounded by a second beam of 60°, expanding your coverage to an area equal to your depth. In 20 feet of water, the wider beam covers an area 20 feet wide. The 20° center beam is focused on the bottom, to show you structure, weeds and cover. The 60° wide beam is hunting for fish in the wide coverage area. DualBeam PLUS™ sonar returns can be blended together, viewed separately or compared side-by-side. DualBeam PLUS™ is ideal for a wide range of conditions - from shallow to very deep water in both fresh and salt water. Depth capability is affected by such factors as boat speed, wave action, bottom hardness, water conditions and transducer installation.

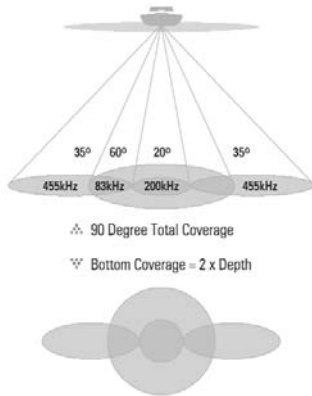

QuadraBeam PLUS™ Sonar

(with optional-purchase QuadraBeam PLUS™ transducer)

Your 700 Series™ Fishing System also supports QuadraBeam PLUS™ sonar with the purchase of an additional QuadraBeam PLUS™ transducer. QuadraBeam PLUS™ sonar provides an extremely wide 90° area of coverage. QuadraBeam PLUS™ starts with two fan-shaped 35° 455 kHz Side Structure locating sonar beams to spot fish, bait and structure to the left and right of the boat over an area of the bottom that's always equal to twice your depth. For a detailed view below the boat, QuadraBeam PLUS™ uses DualBeam PLUS™ technology, with precision 20° and wide 60° beams. QuadraBeam PLUS™ finds more fish faster, and can even tell you where to put your bait by showing if fish are to the left, right or directly beneath your boat.

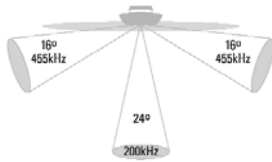

❖ 150 Degree Coverage

❖ Bottom Coverage = $1/3 \times \text{Depth}$



WideSide® Sonar

(with optional-purchase WideSide® transducer)

Your 700 Series™ Fishing System also supports WideSide® sonar with the purchase of an additional WideSide® transducer. The WideSide® transducer is a specialized "side-looking" transducer that is extremely useful for bank fishing or looking for bait fish in open water. The WideSide® transducer uses three different sonar elements that transmit signals to the left, right and straight down from your boat. The downward beam is 200 kHz with a 24° area of coverage. This beam maintains a continuous digital depth readout from the bottom directly beneath your boat. The side beams are 455 kHz with a 16° area of coverage. The side-looking elements can be used independently, or together to locate targets near the surface of the water on either side of your boat.

Universal Sonar 2

Your 700 Series™ Fishing System supports Universal Sonar 2, a state-of-the-art, integrated and protected transducer that is built into the lower unit of Minnkota trolling motors. With Universal Sonar 2, all wiring is concealed inside the indestructible composite shaft—out of sight and out of harm's way, with no clamps, ties, or exposed wires. Universal Sonar 2 features new temperature sensing and the performance of DualBeam PLUS™ technology (available with all Humminbird® DualBeam PLUS™ models). An expanded view and greater bottom detail gives you a totally new perspective of the water below, along with optimal sonar performance to help you find fish.

What's On the Display

The 700 Series™ Fishing System can display a variety of useful information

about the

Depth - water depth; can be set to alarm when the water becomes too shallow.

Cursor - available in Freeze Frame and to provide depth of a sonar return and

can be p...
bottom de...

Speed - if a Temp/Speed accessory or GPS Receiver is attached, the 700 Series™ can display the speed of the boat, and can keep a Triplog of nautical or statute miles traveled.

Temperature - water surface temperature.

Timer - elapsed time with Temp/Speed Accessory or GPS Receiver.

Distance - distance traveled with Temp/Speed Accessory or GPS Receiver.

Average Speed - average speed reading with Temp/Speed Accessory or GPS Receiver.

Bait Ball

Hard Bottom

Rocky Bottom

Second Sonar Return - when the sonar signal bounces between the bottom and the surface of the water and back again. Use the appearance of the second return to determine bottom hardness. Hard bottoms will show a strong second return, while soft bottoms will show a very weak one or none at all.

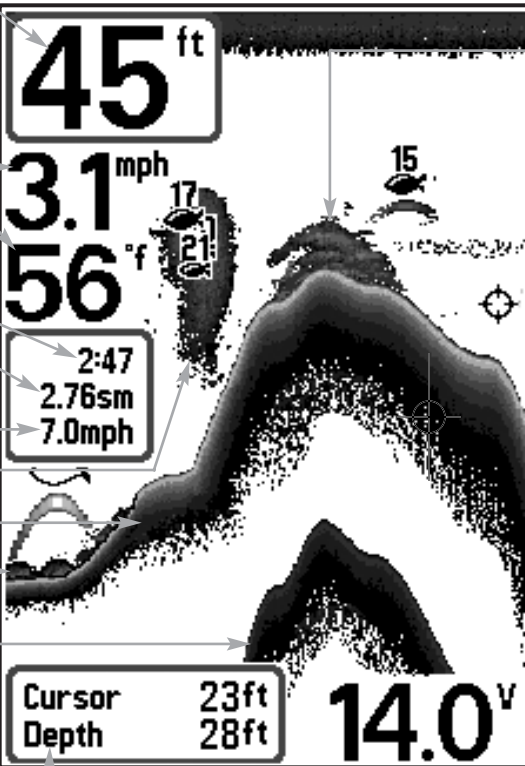

Cursor Dialog Box - indicates cursor of the bottom directly below the cursor.

depth on

NOTE: Entries in this view that list (with Temp/Speed or GPS Receiver) are available if either information from the GPS receiver will be displayed on the view.

device is o

Information about the area under and adjacent to your boat, including the following items:

Frame and return can be positioned in the Sonar View bottom depth below the cursor.

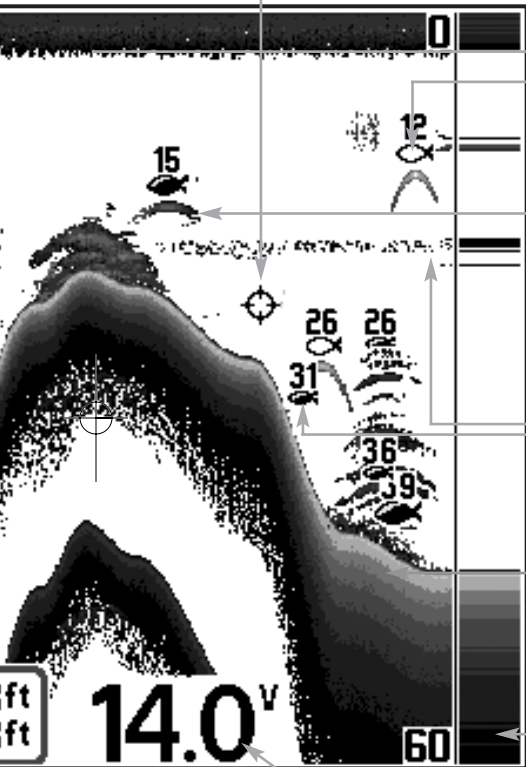

ates cursor depth on the display and the depth w the cursor.

83 kHz, Wide Beam Hollow Fish Symbol

Structure - where fish may be hiding.

Fish - fish are displayed as arches and/or fish icons, and the unit can be set to alarm when a fish of a certain size is detected. When a target is detected and Fish ID+ is on, a Fish ID+™ symbol with depth is displayed. The size of the symbol shows the intensity of the sonar return. The unit will clearly show schools of Bait Fish as "clouds" of different shapes and sizes, depending on the number of fish and boat speed.

200 kHz, Narrow Beam Shaded Fish Symbol

Thermoclines - layers of water with different temperatures that appear at different depths and different times of the year. A thermocline typically appears as a continuous band of many gray levels moving across the display at the same depth.

Soft Bottom

RTS® (Real Time Sonar) Window

Battery Voltage - the voltage of the boat's battery; can be set to alarm if the voltage falls below a certain point.

device is connected to the Fishing System. If both devices are connected, then only the

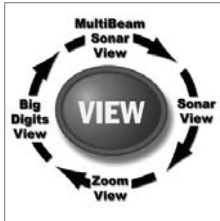

Views

The views available on your Fishing System are:

- Sonar View
- Zoom View
- 200/83 kHz Split Sonar View
- Big Digits View
- Circular Flasher View
- Side Beam View
- WideSide® View.

Sonar View is the default view. When the VIEW key is pressed, the display cycles through the available views. When the EXIT key is pressed, the display cycles through the available views in reverse order. Any view can be hidden or displayed as part of the view rotation using the Views Menu tab.

***NOTE:** When you change any menu settings that affect the sonar, the view will update immediately (i.e. you don't have to exit the menu to apply the change to the screen). For instance, by switching between "Inverse" and "Structure IDSM" from the X-Press™ Menu it is possible to quickly alternate between the two viewing methods.*

***NOTE:** Side Beam View and WideSide® View require the purchase of the QuadraBeam PLUS™ transducer for the Side Beam View and the WideSide® transducer for the WideSide® View. You can visit our website at www.humminbird.com to order these accessories online or contact our Customer Resource Center at 1-800-633-1468.*

Sonar View

Sonar View presents a historical log of sonar returns. Depth is always displayed. Readouts for temperature and speed are automatically displayed if the appropriate accessory is connected. The most recent sonar returns are charted on the right side of the window; as new information is received, the older information is moved across the display to the left. A Digital Depth Readout is displayed in the upper left corner. A scale with Upper and Lower Depth Range readouts appears along the right edge of the Sonar View. The scale indicates the distance from the surface of the water to a depth range sufficient to show the bottom. Depth Range is automatically selected to keep the bottom visible on the display, although you can adjust it manually as well (see *Sonar X-Press™ Menu*). Six Digital Readouts display information from optional-purchase accessories.

These information boxes can be customized to show only the information desired (see *Setup Menu Tab, Select Readouts*).

NOTE: If the Depth number is flashing, it means that the unit is having trouble locating the bottom. This usually happens if the water is too deep, the transducer is out of the water, the boat is moving too fast, or for any other reason that the unit can't accurately receive continuous data.

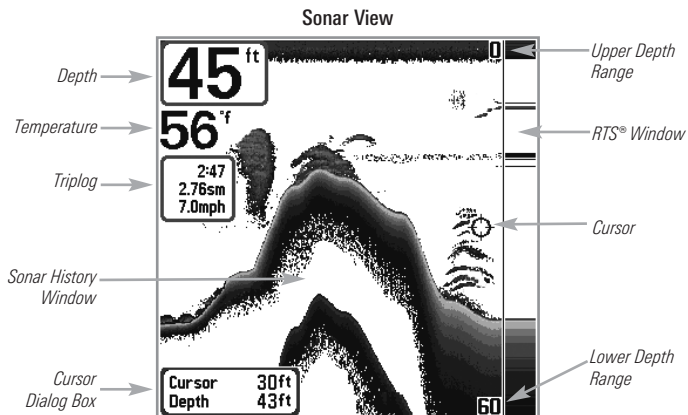

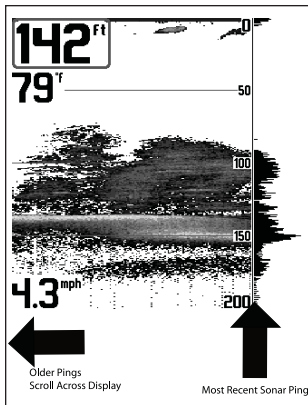

Understanding Sonar History

It is important to understand the significance of the display. The display does NOT show a literal 3-dimensional representation of what is under the water. Each vertical band of data received by the control head and plotted on the display represents something that was detected by a sonar return at a particular time. As both the boat and the targets (fish) may be moving, the returns are only showing a particular segment of time when objects were detected, not exactly where those objects are in relation to other objects shown on the display.

Real Time Sonar (RTS®) Window

A **Real Time Sonar (RTS®)** Window appears on the right side of the display in the Sonar View only. The RTS® Window always updates at the fastest rate possible for depth conditions and shows only the returns from the bottom, structure and fish that are within the transducer beam. The RTS® Window plots the depth and intensity of a sonar return (see *Sonar Menu - RTS® Window*).

The **Narrow RTS® Window** indicates the sonar intensity through the use of grayscale. The grayscale used matches the bottom view grayscale setting used in the sonar history window (i.e. Inverse, Structure ID®, WhiteLine®, Bottom Black). The depth of the sonar return is indicated by the vertical placement of the return on the display depth scale.

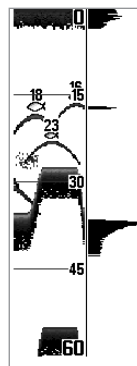
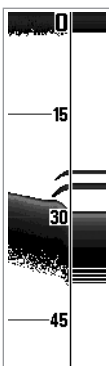

The **Wide RTS® Window** indicates the sonar intensity through the use of a bar graph. The length of the plotted return provides an indication of whether the return is weak or strong. The depth of the sonar return is indicated by the vertical placement of the return on the display depth scale. The Wide RTS® Window does not make use of grayscale.

Freeze Frame and Cursor

Freeze Frame - Pressing any arrow on the 4-WAY Cursor Control key will freeze the screen and a cursor will be displayed on the screen. The cursor can be positioned on the display using the 4-WAY Cursor Control key to determine the depth of any sonar return. The RTS® Window continues to update in Freeze Frame. In addition, see the effects of menu setting changes with Instant Image Update. Pressing EXIT will exit Freeze Frame and the display will start to scroll. Freeze Frame is available in Sonar, Sonar Zoom and 200/83 kHz Split Sonar Views.

Bottom Presentation

As the boat moves, the unit charts the changes in depth on the display to create a profile of the **Bottom Contour**. The type of bottom can be determined from the return charted on the display. A **Hard Bottom** such as compacted sediment or flat rock appears as a thinner line across the display. A **Soft Bottom** such as mud or sand appears as a thicker line across the display. **Rocky Bottoms** have a broken, random appearance.

Bottom Contour Profile with RTS® Window.
Temp/Speed Accessory is optional.

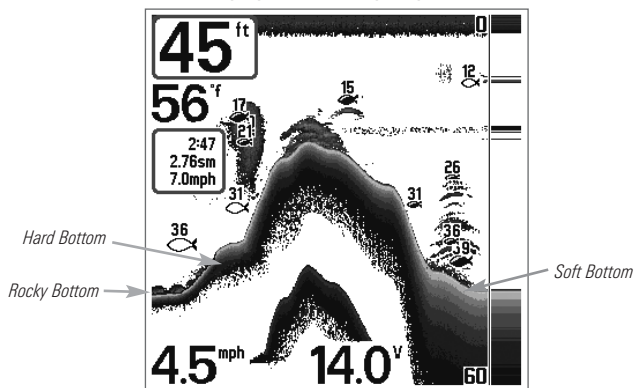

The sonar returns from the bottom, structure and fish can be represented as either **Inverse** (default), **WhiteLine®**, **Structure ID®**, or **Bottom Black**. See *Sonar X-Press™ Menu: Bottom View* for details on how to set the bottom view.

Inverse is a method where weak returns are shown with dark pixels and strong returns with lighter pixels. This has the benefit of ensuring that weak signals will be clearly visible on the display.

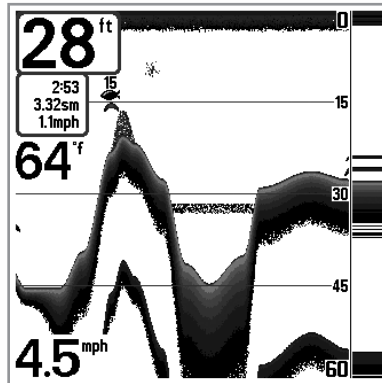

Structure ID® represents weak returns as light pixels and strong returns as dark pixels. This has the benefit of ensuring that strong returns will be clearly visible on the display.

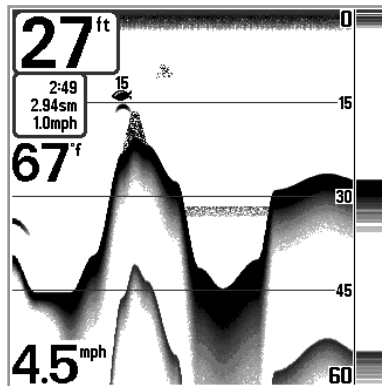

WhiteLine® highlights the strongest sonar returns in white, resulting in a distinctive outline. This has the benefit of clearly defining the bottom on the display.

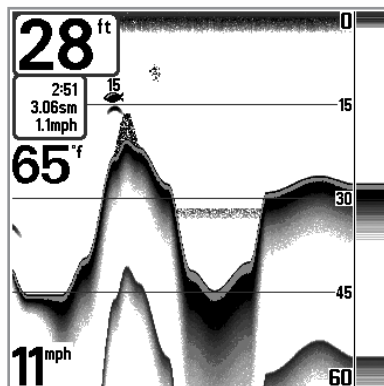

Bottom Black displays all pixels below the bottom contour as black, regardless of signal strength. This has the benefit of providing a high contrast between the bottom and other sonar returns on the display. Any targets such as fish, structure and thermoclines will be shown using the Structure ID® method.

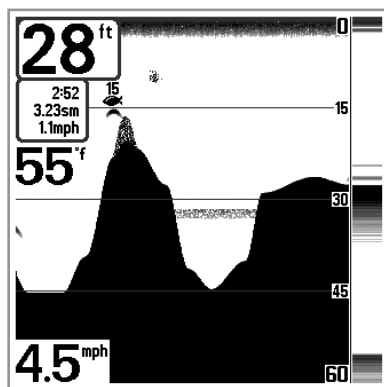

Sonar Zoom View

Sonar Zoom View increases the displayed resolution to separate sonar returns that are very close together, such as those caused by fish suspended close to the bottom or within structure. In Zoom View, the display is split to show a narrow slice of the full range view on the right and the zoomed view on the left. The full range view on the right also contains the Zoom Preview Box that shows what part of the full range view is shown in zoom view on the left; the Zoom Preview Box tracks the bottom in the full range view.

As the depth changes, the zoomed view updates automatically to display a magnified image of the bottom. The Zoom Preview Box shows where the zoomed view is in relation to the full range view. The Zoom Level, or magnification, is displayed in the lower left corner and can be changed to suit conditions (see *Sonar X-Press™ Menu: Zoom Level*). Upper and Lower Zoom Depth Range numbers indicate the depth of the water which is being viewed.

Digital depth is displayed in the upper left hand corner. The digital readouts in the Sonar Zoom View cannot be customized; therefore, information such as water temperature and voltage are unavailable in the Sonar Zoom View.

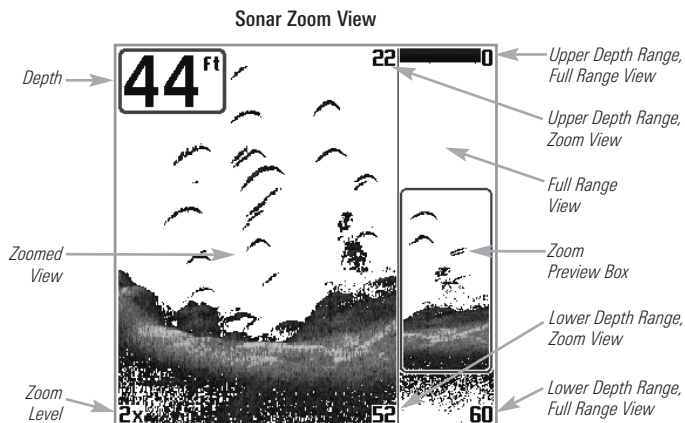

200/83 kHz Split Sonar View

Split Sonar View displays sonar returns from the 83 kHz wide beam on the left side of the screen and displays sonar returns from the 200 kHz narrow beam on the right side of the screen. Depth is always displayed in the upper left hand corner. You can use the Split Sonar View to make side by side comparisons between the sonar returns from the 83 kHz wide beam and the 200 kHz narrow beam.

The digital readouts in the Split Sonar View cannot be customized; therefore, information such as water temperature and voltage are unavailable in the Split Sonar View.

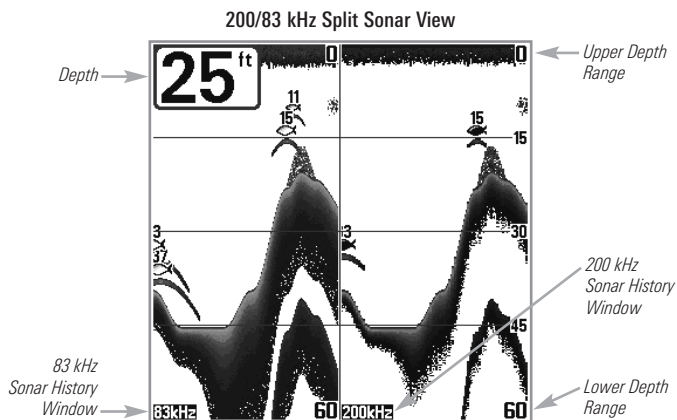

Big Digits View

Big Digits View provides digital data in a large, easy-to-see format. Depth is always displayed. Readouts for temperature, speed and Triplog information are displayed automatically if the appropriate accessory is connected to the system. The Triplog shows distance traveled, average speed, and time elapsed since the Triplog was last reset. The digital readouts in the Big Digits View cannot be customized.

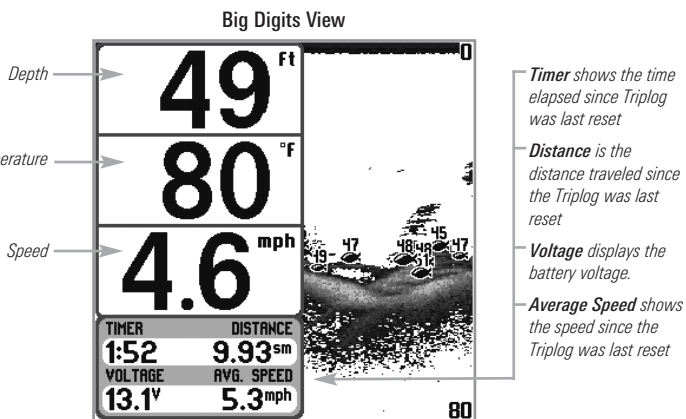

Circular Flasher View

Circular Flasher View displays Real Time Sonar (RTS®) data in the traditional flasher format. Depth and temperature are always displayed. The digital readouts in the Circular Flasher View cannot be customized.



Side Beam View

(with optional-purchase QuadraBeam PLUS™ transducer)

Side Beam View is only available if you have connected an optional-purchase QuadraBeam PLUS™ transducer accessory and when Transducer Select is set to QuadraBeam (see *Sonar Menu Tab: Transducer Select*). The QuadraBeam PLUS™ transducer requires a separate purchase. This view shows sonar information from both the left and right 455 kHz beams and the 200 kHz down-looking beam in one view. You can customize the way the sonar data is displayed in the Side Beam View to suit your personal preferences. Depending on the layout selected from the Quad Layout Sonar X-Press™ menu (only available on the Sonar X-Press™ menu when in Side Beam View), the display will represent the same sonar data in one of the following three layouts: Default, Classic, and Slanted.

Default layout: The top portion of the display presents a historical log of sonar returns from the 200 kHz down-looking sonar beam. New information in the down beam panel scrolls from right to left. The bottom portion of the display presents a historical log of sonar returns from the 455 kHz right- and left-looking sonar beams. New information in the side beam panels scrolls from the center out.

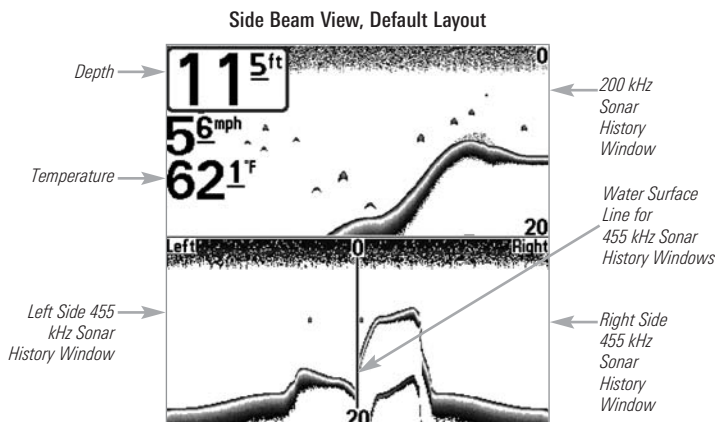

Classic layout: The top portion of the display presents a historical log of sonar returns from the 200 kHz down-looking sonar beam. New information in the down beam panel scrolls from right to left. The bottom portion of the display presents a historical log of sonar returns from the 455 kHz right- and left-looking sonar beams. New information appears at the top, and scrolls down the display.

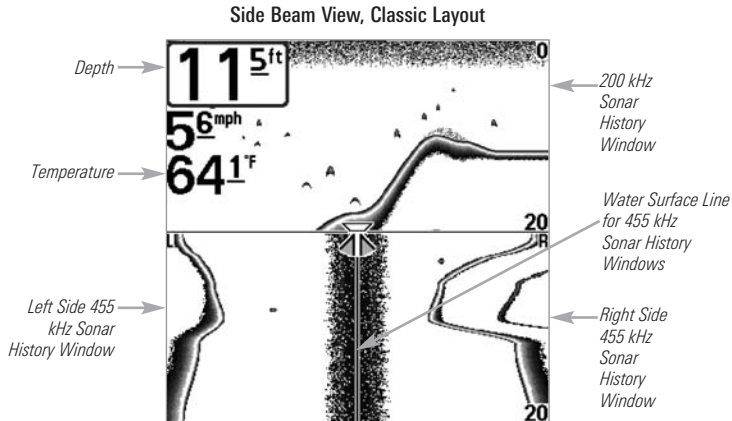

Slanted layout: This layout presents the two 455 kHz side sonar beams and the 200 kHz down-looking sonar beam as three panels of historical data. This layout is presented as three slanted panels. New information appears on the right, and scrolls to the left.

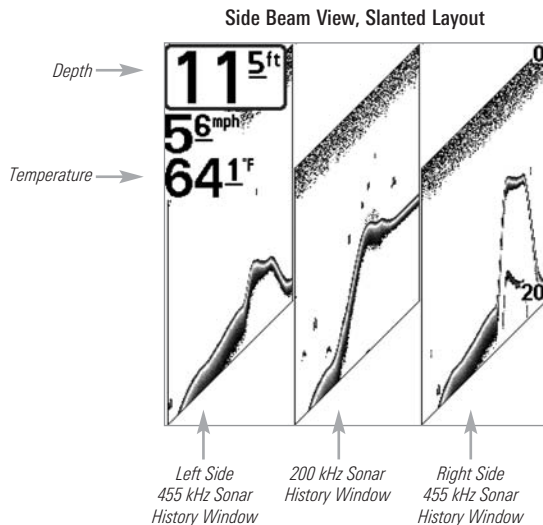

In all of these layouts, the sonar information from the side-looking beams reveals bottom contour, structure and fish similar to the down-looking beam, but the area covered is to the left and right of the area shown in the down-looking portion, so you actually see more of the bottom. The distance covered by the right and left beams is based on the depth setting for the down-looking beam, up to a maximum of 160 feet.

WideSide® View

(with optional-purchase WideSide® transducer)

WideSide® View is only available if you have connected a WideSide® transducer accessory and when Transducer Select is set to WideSide® (see *Sonar Menu Tab: Transducer Select*). The WideSide® transducer requires a separate purchase. The WideSide® View displays information from the 455 kHz WideSide® transducer. Three views are available: Left, Right and Both. The default view is Both. Information from both the left and right beams are displayed simultaneously. The depth of the water beneath the boat is always displayed. A bottom contour may be present while bank fishing or fishing river channels. When fishing in the open water, a bottom contour will not be present, and only sonar returns from either debris or fish will be displayed.

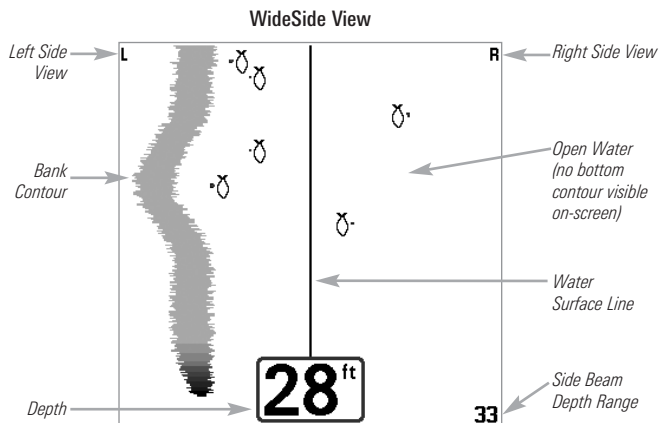

Key Functions

Your Fishing System user interface consists of a set of easy-to-use keys that work with various on-screen views and menus to give you flexibility and control over your fishing experience.



POWER/LIGHT Key

The POWER/LIGHT key is used to turn the Fishing System on and off, and also to adjust the backlight and contrast of the display.

Press the POWER/LIGHT key to turn the unit on. The Title screen is then displayed until the Fishing System begins sonar operation.

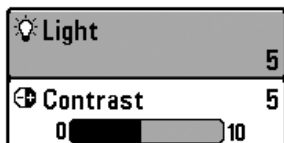

Your Fishing System will start up with the backlight on and will automatically turn it off to conserve power. To turn the backlight on for night fishing, or to adjust the display contrast, press the POWER/LIGHT key to access the Light and

Contrast menu. Use the 4-WAY Cursor key to select Light or Contrast and then use the LEFT or RIGHT Cursor key to change the settings. Press EXIT to exit the Light and Contrast menu.

Press and hold the POWER/LIGHT key for 3 seconds to turn the unit off. A message will appear telling you how many seconds there are until shutdown occurs. Your Fishing System should always be turned off using the POWER/LIGHT key. This will ensure that shutdown occurs properly and any menu settings will be saved.



VIEW Key

The VIEW key is used to cycle through all available views. Press the VIEW key to advance to the next view. Repeatedly pressing VIEW cycles through all views available. Views can be hidden to optimize the system to your fishing requirements (see *Views Menu Tab*).



MENU Key

The MENU key is used to access the menu system.

Start-Up Options Menu - Press the MENU key during the power up sequence to view the Start-Up Options menu.

X-Press™ Menu - Press the MENU key once for the Sonar X-Press™ Menu. The X-Press™ Menu allows you to access frequently-used settings without having to navigate through the whole menu system. When the X-Press™ Menu is displayed, you can use the UP or DOWN Cursor keys to move to a particular menu choice. As soon as you alter a parameter (using the RIGHT or LEFT Cursor keys) the X-Press™ Menu will collapse temporarily, and the screen will update if it is affected by your menu setting change, allowing you to see the effects of your action immediately. Reactivate the X-Press™ Menu by using the UP or DOWN Cursor keys.

Main Menu - Press the MENU key twice for the tabbed Main Menu System. The Main Menu System is organized under tabbed headings to help you find a specific menu item quickly: Alarms, Sonar, Setup, Views and Accessories tabs are part of your tabbed Main Menu System. Use the LEFT or RIGHT 4-WAY Cursor Control key to select a tab; then use the DOWN or UP key to select the menu item, and the LEFT or RIGHT key to alter a menu setting.



4-WAY Cursor Control Key

The 4-Way Cursor Control Key has multiple functions, depending on the situation:

- Use the DOWN or UP arrow keys to select a menu choice from the menu list, then use the LEFT or RIGHT arrow keys to change a menu setting.

NOTE: Menu choices are implemented and saved immediately - no further action is required.

- In all Sonar views but the Big Digits view, pressing any 4-WAY Cursor Control key will activate Freeze Frame and will then allow you to position the cursor on the display.



EXIT Key

The EXIT key has multiple functions, depending on the situation:

- If an alarm is sounding, pressing EXIT will cancel the alarm.
- If a menu tab is selected, pressing EXIT will exit the menu mode and return to the view.
- If a menu is active, pressing EXIT will return to the previous level in the menu system.
- Pressing EXIT will cycle through the available views in reverse order.
- If Freeze Frame is active, pressing EXIT will return to a scrolling display.

Accessory Bus

Use the Accessory Bus to expand the functionality of the Fishing System. Accessories plug directly into the Fishing System, enabling Advanced features such as WeatherSense®, GPS Functionality and the SmartCast® Wireless Sonar Link. Additional menu tabs and menu choices will be added to the menu system automatically when an accessory is plugged into the unit. In addition, multiple accessories can be attached simultaneously. See *Accessories Menu Tab* and *700 Series™ Fishing System Accessories* in this manual, as well as your accessory's Operations Manual for additional details.

NOTE: Accessories to enable WeatherSense®, GPS Functionality and the SmartCast® Wireless Sonar Link require separate purchases. You can visit our website at www.humminbird.com or contact our Customer Resource Center at 1-800-633-1468 for additional details.

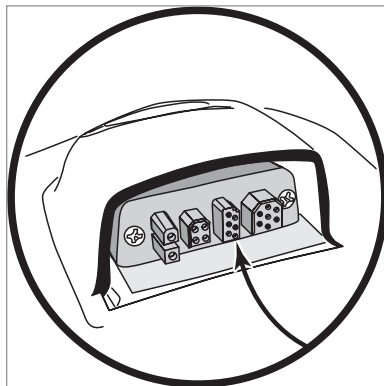

Powering Up the Unit

Turn on your Fishing System by pressing the POWER/LIGHT key. The Title screen is displayed until the Fishing System begins operation. Your Fishing System will begin Normal or Simulator operation, depending on the presence or absence of a transducer.

727 Title Screen

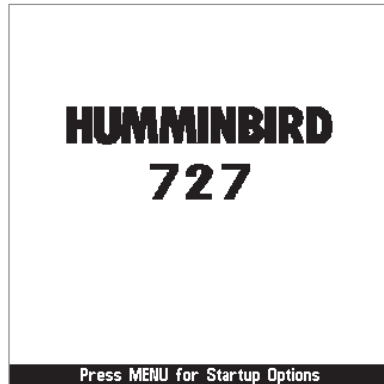

The Menu System

The menu system is divided into easy-to-use menu modules. The main components of the menu system are:

Start-Up Options Menu - Press the MENU key during the power up sequence to view the Start-Up Options menu.

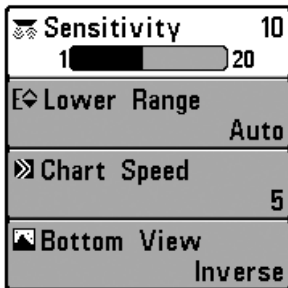

X-Press™ Menu

X-Press™ Menu - The X-Press™ Menu allows you to access the settings that are changed frequently without having to navigate through the whole menu system. Press the MENU key once to display the X-Press™ Menu. When you select a menu item from the X-Press™ Menu, the menu will collapse, leaving only the menu choice on the screen. Use the UP or DOWN Cursor keys to reactivate the X-Press™ Menu.

NOTE: The X-Press™ Menu choices will vary depending on which view is active when you press the MENU key, as well as whether you are in Normal or Advanced User Mode.

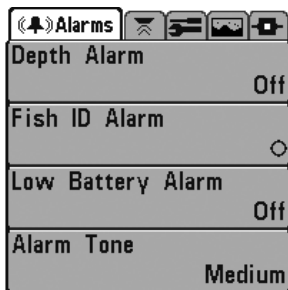

Main Menu System
Normal User Mode

Main Menu Tabs - Less frequently-adjusted menus are grouped into the Main Menu System. The Main Menu system is organized under the following tab headings to help you find a specific menu item quickly: Alarms, Sonar, Setup, Views, and Accessories.

Press the MENU key twice for the Main Menu, then use the 4-WAY Cursor LEFT or RIGHT key to select a tab, and use the DOWN or UP key to select a specific menu item under that tab, then use the LEFT or RIGHT keys again to change a menu setting. Press the EXIT key to move quickly to the top of the tab. A down arrow at the bottom of a menu means that you can scroll to additional menu choices using the DOWN Cursor key. A right or left arrow on a menu choice means that you can use the RIGHT or LEFT Cursor keys to make changes or to see more information.

NOTE: The Main Menu choices will vary depending on whether you are in Normal or Advanced User Mode.

User Mode (Normal or Advanced) - An Advanced Mode is provided for users who desire the highest level of control over the Fishing System and Normal Mode for users who desire greater simplicity and fewer menu choices. Additional Advanced menu choices will be displayed throughout the menu system when you navigate to specific menus while in Advanced Mode. Any changes made while in Advanced Mode will remain in effect after you switch back to Normal Mode. See *Setup Menu Tab: User Mode* for specific instructions on changing to Advanced User Mode.

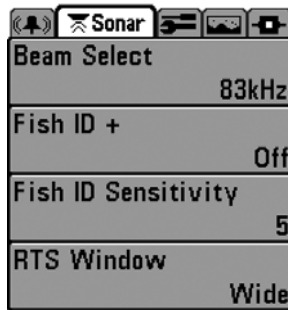

Sonar Tab,
Normal Mode

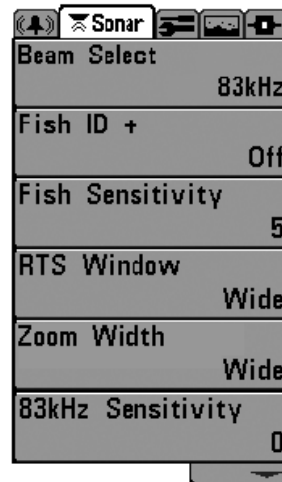

Sonar Tab,
Advanced Mode

Total Screen Update - when you change any menu settings that affect the Sonar View, the view will update immediately (i.e. you don't have to exit the menu to apply the change to the screen). For instance, by switching between "Inverse" and "Structure ID®" from the X-Press™ Menu it is possible to alternate quickly between the two viewing methods.

Start-Up Options Menu

Press the MENU key when the Title screen is displayed to access the **Start-Up Options menu**.

Use the UP or DOWN 4-WAY Cursor keys to position the cursor, then the RIGHT Cursor key to select one of the following choices. If you wait too long, the system will default to whichever menu mode happens to be highlighted:

- Normal
- Simulator
- System Status
- PC Connect (use with PC Connect Cable).

See the following paragraphs for more information about each of these choices.

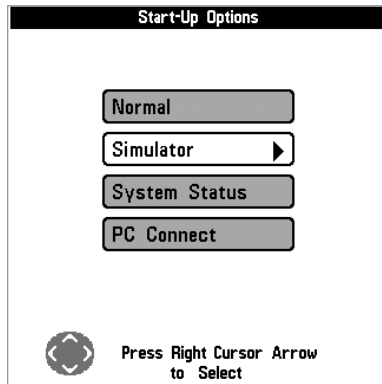

Normal Operation

Use Normal operation for on the water operation with a transducer connected. In addition, your Fishing System uses advanced transducer detection methods to determine if a transducer is connected. If a functioning transducer is connected, Normal operation will be selected automatically at power up and your Fishing System can be used on the water.

Exit Normal operation by powering your Fishing System off.

Simulator

Use the **Simulator** to learn how to use your Fishing System before taking your boat on the water. The Simulator is a very powerful tool that simulates on the water operation, providing a randomly-updated display. We recommend going through this manual while using the Simulator, since all of the menus function and affect the display the way they actually do when in Normal operation.

Simulator (shown with optional-purchase
Weathersense® attached)

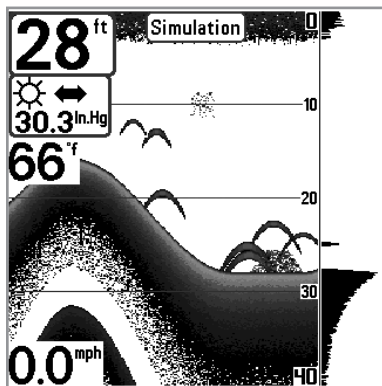

NOTE: To get the full benefit of the Simulator, it is important to select Simulator manually from the Start-Up Options menu as opposed to letting the Fishing System enter Simulator automatically (as it will if a transducer is not connected and you do nothing during power up). Manually selecting Simulator from the Start-Up Options menu allows you to pre-configure your Fishing System for on the water operation. Any menu changes you make will be saved for later use.

A message will appear on the display periodically to remind you that you are using the Simulator.

Exit the Simulator by powering your Fishing System off.

System Status

Use **System Status** to view system connections and to conduct a unit self-test.

The following screens are displayed in turn when you press the **VIEW** button when using System Status:

- Self Test
- Accessory Test.

Self Test

Self Test displays results from the internal diagnostic self test, including unit serial number, Printed Circuit Board (PCB) serial number, software revision, total hours of operation and the input voltage.

Self Test Screen

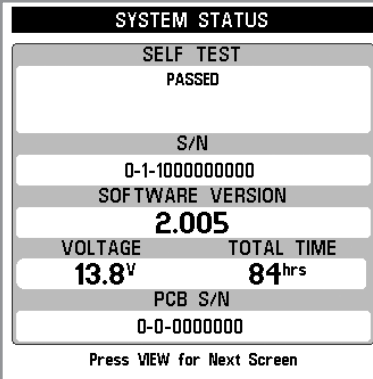

The image shows a rectangular screen with a black header bar at the top containing the text "SYSTEM STATUS" in white. Below the header, the screen is divided into several sections with alternating light and dark gray backgrounds. The first section is labeled "SELF TEST" and shows "PASSED". The second section is labeled "S/N" and shows "0-1-1000000000". The third section is labeled "SOFTWARE VERSION" and shows "2.005". The fourth section is split into two columns: "VOLTAGE" showing "13.8^v" and "TOTAL TIME" showing "84^{hrs}". The fifth section is labeled "PCB S/N" and shows "0-0-0000000". At the bottom of the screen, there is a line of text that says "Press VIEW for Next Screen".

SYSTEM STATUS	
SELF TEST	
PASSED	
S/N	
0-1-1000000000	
SOFTWARE VERSION	
2.005	
VOLTAGE	TOTAL TIME
13.8 ^v	84 ^{hrs}
PCB S/N	
0-0-0000000	
Press VIEW for Next Screen	

Accessory Test

Accessory Test lists the accessories connected to the system.

System Status Accessory Test Screen

SYSTEM STATUS	
ACCESSORY TEST	
GPS	UNCONNECTED
SmartCast WSL	UNCONNECTED
Speed	CONNECTED
Temperature	CONNECTED
WeatherSense	UNCONNECTED
Exit SYSTEM STATUS by powering the unit off	

NOTE: The speed accessory will be detected only if the paddlewheel has moved since your Fishing System was powered up.

Exit System Status by powering your Fishing System off.

PC Connect

(with PC Connect Cable only)

Use PC Connect to update the control head software. This feature requires the use of the PC Connect Cable. Complete instructions are included with the PC Connect Cable accessory.

NOTE: The PC Connect Cable requires a separate purchase. For more information visit our website at www.humminbird.com or contact our Customer Resource Center at 1-800-633-1468.

Exit PC Connect mode by powering the Fishing System off.

↔ Side	Both
📡 Sensitivity	16
↕ Upper Range	0ft
↕ Lower Range	48ft
↕ Side Beam Range	33ft
📊 Chart Speed	7
🖼️ Bottom View	Inverse
🗪 Quad Layout	Default
🔍 Zoom Level	2x
↕ Bottom Range	33ft
🔒 Bottom Lock	Off

Sonar X-Press™ Menu

Sonar X-Press™ Menu

The **Sonar X-Press™** Menu provides access to the settings most frequently-used. Press the MENU key once while in any of the Sonar Views to access the Sonar X-Press™ Menu.

NOTE: Upper Range only appears in Advanced User Mode when in Sonar, Split Sonar, Big Digits and Circular Flasher Views.

NOTE: Zoom Level only appears in Sonar Zoom View.

NOTE: Quad Layout only appears in Side Beam View with optional-purchase QuadraBeam PLUS™ transducer.

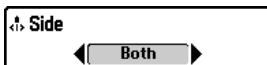

Side

(WideSide® transducer: WideSide® view only)

Side sets which transducer beam from the WideSide® Transducer is shown in the WideSide® View. A WideSide® transducer must be connected to the Fishing System. The Side menu choice is available when Transducer Select is set to WideSide® (see ***Sonar Menu Tab: Transducer Select***) and can only be accessed from the Sonar X-Press™ menu when you are in WideSide® view.

***NOTE:** Side requires the purchase of the WideSide® transducer. You can visit our website at www.humminbird.com to order this accessory online or contact our Customer Resource Center at 1-800-633-1468.*

To adjust the Side:

1. Make sure you are in WideSide® Transducer Mode and that a WideSide® transducer is connected, then highlight Side on the Sonar X-Press™ menu.
2. Use the LEFT or RIGHT 4-WAY Cursor Control keys to change the Side setting. (L [Left], Both, R [Right], Default = Both).

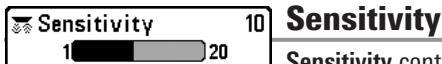

Sensitivity

Sensitivity controls how much detail is shown on the display and will adjust the sensitivity of all sonar frequencies. Increasing the sensitivity shows more sonar returns from small baitfish and suspended debris in the water; however, the display may become too cluttered. When operating in very clear water or greater depths, increased sensitivity shows weaker returns that may be of interest. Decreasing the sensitivity eliminates the clutter from the display that is sometimes present in murky or muddy water. If Sensitivity is adjusted too low, the display may not show many sonar returns that could be fish.

NOTE: The Sensitivity setting is a global setting and will adjust the sensitivity of all sonar frequencies, as compared to specific sensitivity adjustments (such as 83 kHz Sensitivity, 455 kHz Balance or Wideside Sensitivity) which allow you to adjust the level of sensitivity for one specific beam at a time.

Sensitivity at Low

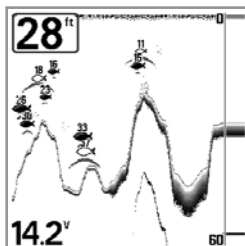

Sensitivity at Medium

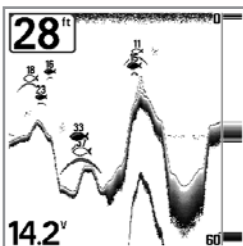

Sensitivity at High

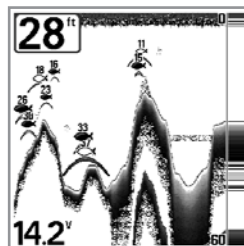

To adjust the Sensitivity:

1. Highlight Sensitivity on the Sonar X-Press™ Menu.
2. Use the LEFT or RIGHT 4-WAY Cursor Control keys to increase or decrease the Sensitivity setting. (Low = 1, High = 20, Default = 10)



Upper Range

(Advanced: Sonar, Split Sonar, Big Digits and Circular Flasher Views only)

Upper Range sets the shallowest depth range that will be displayed on the Sonar, Split Sonar, Big Digits and Circular Flasher views. The Upper Range menu choice is available when User Mode is set to Advanced (see *Setup Menu Tab: User Mode*) and can only be accessed from the Sonar, Split Sonar, Big Digits and Circular Flasher views. Upper Range is often used with Lower Range.

For example, if you are only interested in the area between 20 and 50 feet deep, you should set the Upper Depth Range to 20 and the Lower Depth Range to 50. The Sonar View will then show the 30 foot area between 20 and 50, and will not show the surface or the bottom (assuming the bottom is deeper than 50 feet), and will show greater detail for that area between 20 and 50 feet.

NOTE: A minimum distance of 10 feet will be maintained between the Upper and Lower Range regardless of the manual settings entered.

To adjust the Upper Range:

1. Make sure you are in Advanced Mode, then highlight Upper Range on the Sonar X-Press™ Menu.
2. Use the LEFT or RIGHT 4-WAY Cursor Control keys to increase or decrease the Upper Range setting. (0 to 990 feet for 717 models, 0 to 1490 feet for 727 models, or 0 to 327 meters for 717 models or 0 to 497 meters for 727 models *[International models only]*, Default = 0)



Lower Range

Lower Range sets the deepest depth range that will be displayed. Automatic is the default setting. When in automatic mode, the lower range will be adjusted by the unit to follow the bottom. Selecting a specific setting locks the depth range into Manual mode. Use both Upper and Lower Range together to view a specific depth range manually when looking for fish or bottom structure. **M** will be displayed in the lower right corner of the screen when you start manually adjusting the Lower Range to indicate that you are in Manual mode.

For example, if you are fishing in 60 feet of water but are only interested in the first 30 feet (surface to a depth of 30 feet) you should set the Lower Depth Range limit to 30. The display will show the 0 to 30 foot range, allowing you to see a more detailed view than you would see if the display went all the way to the bottom.

***NOTE:** A minimum distance of 10 feet will be maintained between the Upper and Lower Range regardless of the manual settings entered.*

To adjust the Lower Range:

1. Highlight Lower Range on the Sonar X-Press™ Menu.
2. Use the LEFT or RIGHT 4-WAY Cursor Control keys to increase or decrease the Lower Range setting. (AUTO, 10 to 1000 feet for 717 models, 10 to 1500 feet for 727 models, or 3 to 330 meters for 717 models or 3 to 500 meters for 727 models *[International models only]*, Default = AUTO)



Side Beam Range

(WideSide® transducer: WideSide® view only)

Side Beam Range sets the deepest range that will be displayed in the WideSide® View. The range must be set manually to keep the bottom visible on the display. If the Side Beam Range is set too deep for current depth conditions the sonar information will become compressed on the display and valuable detail will be lost. A WideSide® transducer must be connected to the Fishing System. Side Beam Range menu choice is available when Transducer Select is set to WideSide® (see *Sonar Menu Tab: Transducer Select*) and can only be accessed from the WideSide® view.

NOTE: *The Side Beam Range requires the purchase of the WideSide® transducer. You can visit our website at www.humminbird.com to order this accessory online or contact our Customer Resource Center at 1-800-633-1468.*

To adjust the Side Beam Range:

1. Make sure you are in WideSide® Transducer Mode and that a WideSide® transducer is connected, then highlight Side Beam Range on the Sonar X-Press™ menu.
2. Use the LEFT or RIGHT 4-WAY Cursor Control keys to increase or decrease the Side Beam Range setting. (6 - 160 feet [2 - 50 meters] *[International Models only]*, Default = 160 feet [50 meters])



Chart Speed

Chart Speed determines the speed at which the sonar information moves across the display, and consequently the amount of detail shown. A faster speed shows more information and is preferred by most anglers; however, the sonar information moves across the display quickly. A slower speed keeps the information on the display longer, but the bottom and fish details become compressed and may be difficult to interpret. Regardless of the Chart Speed setting, the RTS® Window will update at the maximum rate possible for the depth conditions. Adjust Chart Speed to your personal preference.

To adjust the Chart Speed:

1. Highlight Chart Speed on the Sonar X-Press™ Menu.
2. Use the LEFT or RIGHT 4-Way Cursor Control keys to increase or decrease the Chart Speed setting. (1-9, Ultra, where 1 = Slow, 9 = Fast, Ultra = Fastest, Default = 5)



Bottom View

Bottom View selects the method used to represent bottom and structure on the display.

Inverse represents weak returns as dark pixels and strong returns as lighter pixels. This has the benefit of ensuring that weak signals will be clearly visible on the display.

Structure ID® represents weak returns as light pixels and strong returns as dark pixels. This has the benefit of ensuring that strong returns will be clearly visible on the display.

WhiteLine® highlights the strongest sonar returns in white resulting in a distinctive outline. This has the benefit of clearly defining the bottom on the display.

Bottom Black displays all pixels below the bottom contour as black, regardless of signal strength. This has the benefit of providing a high contrast between the bottom and other sonar returns on the display. Any targets such as fish, structure and thermoclines will be shown using the Structure ID® method.

See *Bottom Presentation* for more information.

To adjust the Bottom View:

1. Highlight Bottom View on the Sonar X-Press™ Menu.
2. Use the LEFT or RIGHT 4-WAY Cursor Control keys to change the Bottom View setting. (Inverse, Structure ID®, WhiteLine®, Bottom Black, Default = Inverse)



Quad Layout

*(with Optional-Purchase QuadraBeam PLUS™
Transducer, Side Beam View only)*

Quad Layout selects the method used to represent the sonar information from the two side-looking beams plus the down-looking beam to be presented on the Side Beam View, and is only available when an optional-purchase QuadraBeam PLUS™ transducer is attached and the Side Beam View is active. Use Quad Layout to change the way the Side Beam View is displayed. See *Side Beam View* for more information.

To adjust the Quad Layout:

1. Highlight Quad Layout on the Sonar X-Press™ menu.
2. Use the LEFT or RIGHT 4-Way Cursor Control keys to change the Quad Layout setting for the Side Beam View. (Default, Classic, Slanted, Default = Default)

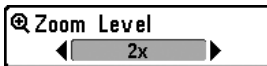

Zoom Level

(Sonar Zoom View only)

Quad Layout selects the method used to represent the sonar information from the two side-looking beams plus the down-looking beam to be presented on the Side Beam View, and is only available when an optional-purchase QuadraBeam PLUS™ transducer is attached and the Side Beam View is active and Bottom Lock is off. Use Quad Layout to change the way the Side Beam View is displayed. See *Side Beam View* for more information.

To adjust the Quad Layout:

1. Highlight Quad Layout on the Sonar X-Press™ menu.
2. Use the LEFT or RIGHT 4-Way Cursor Control keys to change the Quad Layout setting for the Side Beam View. (Standard, Classic, Slanted, Default = Standard)



Bottom Lock

(Sonar Zoom View only)

Bottom Lock changes the mode of the Zoomed view in the Sonar Zoom View. Bottom Lock continuously graphs the bottom at a constant point on the display regardless of changes in depth. This "flattens" out the bottom contour, but is effective at showing fish on or near the bottom.

To turn on Bottom Lock:

1. In the Sonar Zoom View, highlight Bottom Lock on the Sonar X-Press™ Menu.
2. Use the LEFT or RIGHT 4-WAY Cursor Control keys to change the Bottom Lock setting to on. (Off, On, Default = Off)



Bottom Range

(Sonar Zoom View only, when Bottom Lock is On)

Bottom Range allows you to control how much of the water column, measured up from the bottom, is shown in the Sonar Zoom View, and is only available in the Sonar X-Press™ menu when the Sonar Zoom View is active and Bottom Lock is on. Choose a small value to see low-lying bottom structure or details of the bottom return. Choose a larger value to see large structure in deeper water. It is possible to set the Bottom Range to be greater than the depth. In this case, you may see surface clutter in a wavy band that mirrors changes in the depth.

To adjust the Bottom Range:

1. In the Sonar Zoom View, highlight Bottom Lock on the Sonar X-Press™ Menu.
2. Use the LEFT or RIGHT 4-WAY Cursor Control keys to change the Bottom Lock setting to on.
3. Once you turn on Bottom Lock, the Bottom Range X-Press™ menu choice will be displayed. (10 - 60 feet, 2-10 fathoms, or 3-20 meters *[International Models only]*, Default = 15 feet)

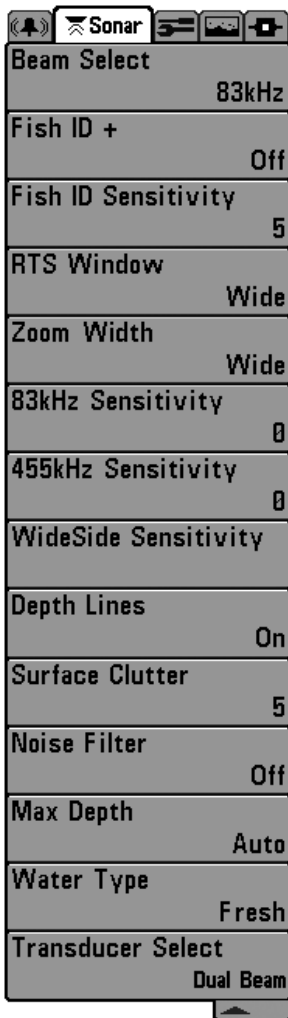

Sonar Menu

Sonar Menu Tab

Press the MENU key twice to access the Main Menu System and then press the RIGHT Cursor key to select the Sonar tab.

NOTE: Menu choices will vary depending on system settings such as whether the unit is set for Advanced User mode or what transducer is currently selected.



Beam Select

Beam Select sets which sonar returns from the transducer will be displayed on the screen.

When set to **200/83 kHz**, the returns from both beams are blended by starting with the 83 kHz wide beam return, dimming it, and then overlaying it with the 200 kHz narrow beam return. The darker 200 kHz narrow beam sonar returns will stand out from the paler 83 kHz wide beam sonar returns. The Split Sonar View continues to display the sonar returns from each beam in their respective windows. The blended information is shown in the Sonar View, Sonar Zoom View and the Big Digits View. The RTS® Window in the Sonar View and the Circular Flasher View will only show the returns from the 200 kHz narrow beam.

When set to **200 kHz**, only the returns from the 200 kHz narrow beam will be displayed in the Sonar View, the Sonar Zoom View, the Big Digits View and the Circular Flasher View. The Split Sonar View will continue to display returns from both beams in their respective windows. The RTS® Window in the Sonar View will display the returns from the 200 kHz narrow beam.

When set to **83 kHz**, the returns from the 83 kHz wide beam will be displayed in the Sonar View, the Sonar Zoom View, the Big Digits View and the Circular Flasher View. The Split Sonar View will continue to display returns from both beams in their respective windows. The RTS® Window will display the returns from the 83 kHz wide beam.

To use Beam Select:

1. Highlight Beam Select on the Sonar main menu.
2. Use the LEFT or RIGHT 4-WAY Cursor Control keys to select either the 200 kHz beam, the 83 kHz beam or the 200/83 kHz beams. (200/83 kHz, 200 kHz, 83 kHz, Default = 200 kHz)

Fish ID+

◀ On ▶

Fish ID+™

Fish ID+™ uses advanced signal processing to interpret sonar returns, and will display a Fish Symbol when very selective requirements are met. When a fish is detected, a fish icon and its depth are displayed above the return that has been classified as being a fish. Three different fish size icons represent the intensity of the sonar return, and provide an indicator of relative fish size.

Targets detected in the 200 kHz narrow beam are represented as Shaded Fish Symbols, and targets detected in the 83 kHz wide beam are represented as Hollow Fish Symbols.

200 kHz, Narrow Beam
Shaded Fish Symbols



83 kHz, Wide Beam
Hollow Fish Symbols



When Fish ID+™ is turned off, the Fishing System shows only the raw sonar returns on the display. These returns will often result in "arches" forming on the display, indicating potential targets. Due to the transducer beam angle, the distance to a fish decreases as the fish moves into the beam, and then increases as it moves out again, creating a Fish Arch when this distance change is shown on the display. Boat speed, chart speed, and the position of the fish within the sonar beam greatly affect the shape of the arch.

Transducer Cone and Fish Arches

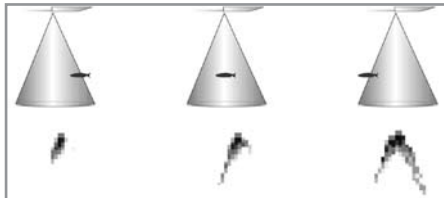
**To turn Fish ID+ on or off:**

1. Highlight Fish ID+ on the Sonar main menu.
2. Use the LEFT or RIGHT 4-WAY Cursor Control keys to turn the Fish ID+™ setting On or Off. (Off, On, Default = Off)



Fish ID Sensitivity

Fish ID Sensitivity adjusts the threshold of the Fish ID+™ detection algorithms. Selecting a higher setting allows weaker returns to be displayed as fish. This is useful for identifying smaller fish species or baitfish. Selecting a lower setting displays fewer fish from weak sonar returns. This is helpful when seeking larger species of fish. Fish ID Sensitivity is used in conjunction with Fish ID+™. Fish ID+™ must be On for Fish ID Sensitivity to affect the ability of the Fishing System to identify sonar returns as fish.

To change the Fish ID Sensitivity setting:

1. Highlight Fish ID Sensitivity on the Sonar main menu.
2. Use the LEFT or RIGHT 4-WAY Cursor Control keys to change the Fish ID Sensitivity setting. (Low = 1, High = 10, Default = 5)



Real Time Sonar (RTS®) Window

RTS® Window sets the RTS® Window to either Wide or Narrow, or turns it off in the Sonar View. The RTS® Window always updates at the fastest rate possible and only displays returns that are within the transducer beam. (See *Real Time Sonar (RTS®) Window* for additional detail).

RTS® Window (Wide)

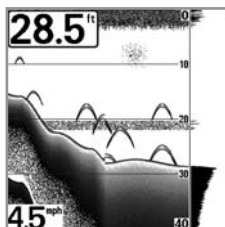

RTS® Window (Narrow)

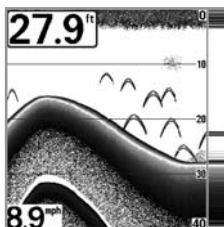

RTS® Window (Off)

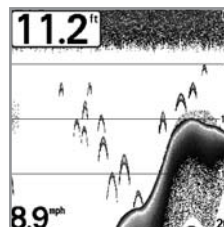

To change the RTS® Window setting:

1. Highlight RTS Window on the Sonar main menu.
2. Use the LEFT or RIGHT 4-WAY Cursor Control keys to change the RTS® Window setting. (Wide, Narrow, Off, Default = Wide)

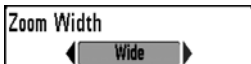

Zoom Width

Zoom Width adjusts the width of the Zoom window on the Sonar Zoom View.

To change the Zoom Width Setting:

1. Highlight Zoom Width on the Sonar main menu.
2. Use the LEFT or RIGHT 4-WAY Cursor Control keys to change the Zoom Width setting. (Narrow, Medium, Wide, Default = Wide)



83 kHz Sensitivity

(Advanced)

83 kHz Sensitivity changes the sensitivity of the 83 kHz beam. Increasing the 83 kHz Sensitivity will display additional weak returns and decreasing the 83 kHz Sensitivity will display fewer weak returns. The 83 kHz Sensitivity menu choice is only available when User Mode is set to Advanced (see *Setup Menu Tab: User Mode*).

NOTE: 83 kHz Sensitivity is particularly useful for adjusting the sensitivity of the 83 kHz sonar returns in the 200/83 kHz Split Sonar View. The 83 kHz sensitivity can be adjusted without affecting the sensitivity of the 200 kHz returns shown in the 200 kHz sonar window.

To set the 83 kHz Sensitivity:

1. Make sure you are in Advanced User Mode, then highlight 83 kHz Sensitivity on the Sonar main menu.
2. Use the LEFT or RIGHT 4-WAY Cursor Control keys to set the 83 kHz Sensitivity. (-10 to +10, Default = 0)



455 kHz Sensitivity

(Advanced: with QuadraBeam PLUS™ transducer)

455 kHz Sensitivity adjusts the sensitivity of the 455 kHz beam. Increasing the sensitivity will display additional weak returns and decreasing the sensitivity will display fewer weak returns. A QuadraBeam PLUS™ transducer must be attached to the Fishing System. The 455 kHz Sensitivity menu choice is available when Transducer Select is set to QuadraBeam (see *Sonar Menu Tab: Transducer Select*) and User Mode is set to Advanced (see *Setup Menu Tab: User Mode*).

NOTE: The 455kHz Sensitivity requires the purchase of the QuadraBeam PLUS™ transducer. You can visit our website at www.humminbird.com to order this accessory online or contact our Customer Resource Center at 1-800-633-1468.

NOTE: 455 kHz Sensitivity is particularly useful for adjusting the sensitivity of the 455 kHz sonar returns in the Side Beam View. The 455 kHz sensitivity can be adjusted without affecting the sensitivity of the 200 kHz returns shown in the 200 kHz sonar window.

To change the 455 kHz Sensitivity setting:

1. Make sure you have selected QuadraBeam PLUS™ Transducer and Advanced Mode and that the QuadraBeam PLUS™ transducer is connected, then highlight 455 kHz Sensitivity on the Sonar Main Menu.
2. Use the LEFT or RIGHT 4-WAY Cursor Control keys to change the 455 kHz Sensitivity. (-10 to +10, Default = 0)



WideSide® Sensitivity

(Advanced: with WideSide® transducer)

WideSide® Sensitivity adjusts the sensitivity of the WideSide® beam. Increasing the sensitivity will display additional weak returns and decreasing the sensitivity will display fewer weak returns. A WideSide® transducer must be attached to the Fishing System. The WideSide® Sensitivity menu choice is available when Transducer Select is set to WideSide® (see *Sonar Menu Tab: Transducer Select*) and User Mode is set to Advanced (see *Setup Menu Tab: User Mode*).

NOTE: *The WideSide® Sensitivity requires the purchase of the WideSide® transducer. You can visit our website at www.humminbird.com to order this accessory online or contact our Customer Resource Center at 1-800-633-1468.*

NOTE: *WideSide® Sensitivity is particularly useful for adjusting the sensitivity of the 455 kHz sonar returns in the WideSide® View. The 455 kHz sensitivity can be adjusted without affecting the sensitivity of the other sonar frequencies.*

To change the WideSide® Sensitivity setting:

1. Make sure you have selected WideSide® Transducer and Advanced Mode and that the WideSide® transducer is connected, then highlight WideSide® Sensitivity on the Sonar Main Menu.
2. Use the LEFT or RIGHT 4-WAY Cursor Control keys to change the WideSide® Sensitivity. (-10 to +10, Default = 0)

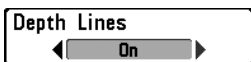

Depth Lines

(Advanced)

Depth Lines divide the display into four equal sections which are separated by three horizontal depth lines. The depth of each line is displayed along the depth scale. You can either turn Depth Lines On or Off. The Depth Lines menu choice is available when User Mode is set to Advanced (see *Setup Menu Tab: User Mode*).

Depth Lines

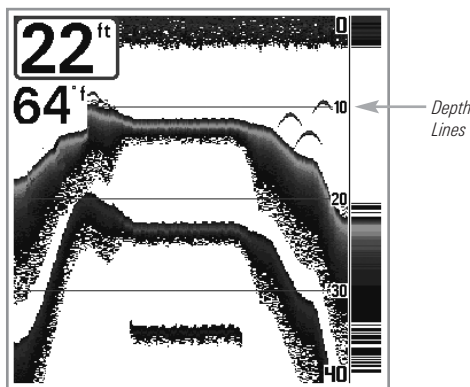

To change the Depth Lines setting:

1. Make sure you are in Advanced User Mode, then highlight Depth Lines on the Sonar main menu.
2. Use the LEFT or RIGHT 4-WAY Cursor Control keys to turn the Depth Lines setting On or Off. (Off, On, Default = On)



Surface Clutter

(Advanced)

Surface Clutter adjusts the filter that removes surface clutter noise caused by algae and aeration. The lower the setting, the less surface clutter will be displayed. The Surface Clutter menu choice is available when User Mode is set to Advanced (see *Setup Menu Tab: User Mode*).

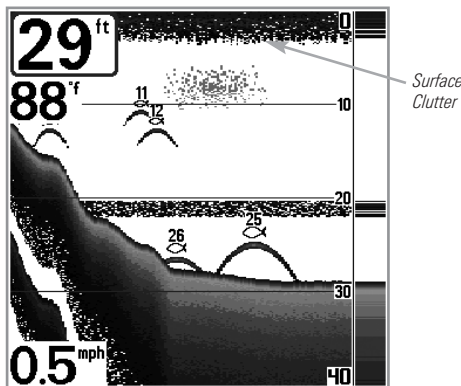

To change the Surface Clutter setting:

1. Make sure you are in Advanced User Mode, then highlight Surface Clutter on the Sonar main menu.
2. Use the LEFT or RIGHT 4-WAY Cursor Control keys to change the Surface Clutter setting. (Low = 1 to High = 10, Default = 5)



Noise Filter

(Advanced)

Noise Filter adjusts the sonar Noise Filter to limit interference on the display from sources such as your boat engine, turbulence, or other sonar devices. The Noise Filter menu choice is available when User Mode is set to Advanced (see *Setup Menu Tab: User Mode*).

NOTE: The Off setting removes all filtering; Low, Medium and High1, High2, High3 settings add progressive filtering of the sonar returns. High1, High2 and High3 are useful when there is excessive trolling motor noise, but in some deep water situations, the High settings may actually hinder your unit's ability to find the bottom.

To change the Noise Filter setting:

1. Make sure you are in Advanced User Mode, then highlight Noise Filter on the Sonar main menu.
2. Use the LEFT or RIGHT 4-WAY Cursor Control keys to change the Noise Filter setting. (Off, Low, Medium, High1, High2, High3, Default = Low)

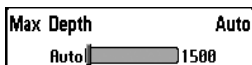

Max Depth

(Advanced)

Max Depth adjusts the maximum depth of operation. The performance of your Fishing System can be tuned to the maximum depth you will be fishing in by setting the Max Depth. When a maximum depth is set, your Fishing System will not attempt to acquire sonar data below that depth, thus increasing overall performance. When Max Depth is set to Auto, the Fishing System will acquire bottom readings as needed (within the capacity of the unit). If the bottom is deeper than the Max Depth setting, the digital depth readout will flash, indicating that the Fishing System cannot locate the bottom. The Max Depth menu choice is available when User Mode is set to Advanced (see *Setup Menu Tab: User Mode*).

To change the Max Depth setting:

1. Make sure you are in Advanced User Mode, then highlight Max Depth on the Sonar main menu.
2. Use the LEFT or RIGHT 4-WAY Cursor Control keys to change the Max Depth setting. (AUTO, 10 to 1000 feet for 717 models, 10 to 1500 feet for 727 models, or 3 to 330 meters for 717 models or 3 to 500 meters for 727 models [*International models only*], Default = AUTO)

**Water Type***(Advanced)*

Water Type configures your unit for operation in fresh or salt water. The Water Type menu choice is available when User Mode is set to Advanced (see *Setup Menu Tab: User Mode*).

NOTE: *In salt water, what would be considered a large fish might be 2 to 10 times bigger than a large fish in fresh water (depending on the type of fish you are seeking). The salt water setting allows for a greater range in fish size adjustment to account for this. Also, make sure that the Water Type is set accurately, especially in salt water, as this affects the accuracy of deep water depth readings.*

To change the Water Type setting:

1. Make sure you are in Advanced User Mode, then highlight Water Type on the Sonar main menu.
2. Use the LEFT or RIGHT 4-WAY Cursor Control keys to change the Water Type setting. (Fresh, Salt, Default = Fresh)

Transducer Select

◀ Dual Beam ▶

Transducer Select

Transducer Select allows you to select which transducer you want to use (the Fishing System comes with a DualBeam PLUS™ transducer, and also supports the optional-purchase QuadraBeam PLUS™ and WideSide® transducers.)

To change the selected Transducer:

1. Highlight Transducer Select on the Sonar Main menu.
2. Use the LEFT or RIGHT 4-WAY Cursor Control keys to change the transducer selected. (DualBeam, QuadBeam, WideSide, Universal Sonar 2, Default = DualBeam)

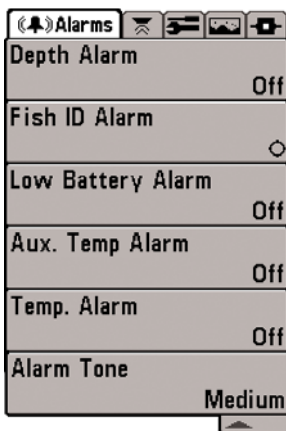

Alarms Menu

Alarms Menu Tab

From any view, press the MENU key twice to access the Main Menu System. The Alarms tab will be the default selection.

NOTE: When an alarm is triggered, you can silence it by pressing any key. The alarm will be silenced, and will not be triggered again until a new instance of the alarm condition is detected.

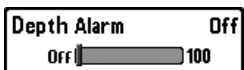

Depth Alarm

Depth Alarm sounds when the depth becomes equal to or less than the menu setting.

To change the Depth Alarm setting:

1. Highlight Depth Alarm on the Alarms main menu.
2. Use the LEFT or RIGHT 4-WAY Cursor Control keys to change the Depth Alarm setting. (OFF, 1 to 100 feet, or 0.5 to 30 meters [*International Models only*], Default = OFF)

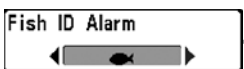

Fish ID Alarm

Fish ID Alarm sounds when the Fishing System detects fish that correspond to the alarm setting. Fish ID Alarm will only sound if Fish ID+™ is on.

For example, if you've set the Fish ID Alarm to sound for Large fish only, the Fish ID alarm will sound when a large-sized fish is detected.

To change the Fish ID Alarm setting:

1. Highlight Fish ID Alarm on the Alarms main menu.
2. Use the LEFT or RIGHT 4-WAY Cursor Control keys to change the Fish ID Alarm setting. (Off, All, Large/Medium, Large, Default = Off)

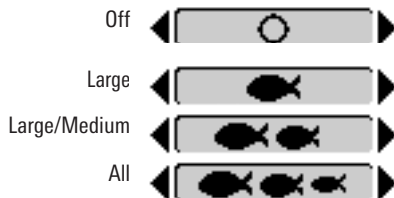

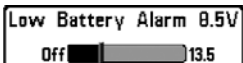

Low Battery Alarm

Low Battery Alarm sounds when the input battery voltage is equal to or less than the menu setting. The battery alarm will only sound for the battery that is connected to the Fishing System. The Low Battery Alarm should be set to warn you when the battery voltage drops below the safety margin that you have determined. For instance, if you are running a trolling motor (battery operated), you would want to set the Low Battery Alarm to sound before the battery voltage drops too low for it to be used to start your main, gasoline-powered engine.

To change the Low Battery Alarm setting:

1. Highlight Low Battery Alarm on the Alarms main menu.
2. Use the LEFT or RIGHT 4-WAY Cursor Control keys to change the Low Battery Alarm setting. (Off, 8.5V - 13.5V, Default = Off)



Aux. Temp. Alarm

(with optional-purchase temp. probe or Temp/Speed only)

Aux. Temp. Alarm sounds when the water temperature (from an optional-purchase temperature probe or Temp/Speed accessory) detected by the Fishing System reaches the Aux. Temp. Alarm setting, which is either set in degrees Fahrenheit or Celsius [International Models only]. For example, if the Aux. Temp. Alarm is set to 58 degrees Fahrenheit, and the water temperature falls from 60 degrees to 58 degrees, the Aux. Temp. Alarm will sound. Similarly, if the water temperature rises from 56 degrees to 58 degrees, the Aux. Temp. Alarm will also sound.

To change the Aux. Temp. Alarm setting:

1. Highlight Aux. Temp. Alarm on the Alarms main menu.
2. Use the LEFT or RIGHT 4-Way Cursor Control keys to change the Aux. Temp. Alarm setting. (Off, 33-120 [Fahrenheit], 0-50 [Celsius], Default = Off)

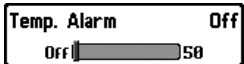

Temp Alarm

Temp Alarm sounds when the water temperature (from the temperature probe that is built into the transducer) detected by the Fishing System reaches the Temp Alarm setting, which is either set in degrees Fahrenheit or Celsius [*International Models only*]. For example, if the Temp Alarm is set to 58 degrees Fahrenheit, and the water temperature falls from 60 degrees to 58 degrees, the Temp Alarm will sound. Similarly, if the water temperature rises from 56 degrees to 58 degrees, the Temp Alarm will also sound.

To change the Temp Alarm setting:

1. Highlight Temp Alarm on the Alarms main menu.
2. Use the LEFT or RIGHT 4-Way Cursor Control keys to change the Temp Alarm setting. (Off, 33-120 [Fahrenheit], 0-50 [Celsius], Default = Off)

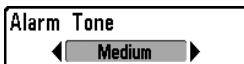

Alarm Tone

Alarm Tone selects the pitch of the alarm sound. A brief tone will be produced as you adjust the Alarm Tone so that you can select the tone that you can hear best.

To change the Alarm Tone setting:

1. Highlight Alarm Tone on the Alarms main menu.
2. Use the LEFT or RIGHT 4-WAY Cursor Control keys to change the Alarm Tone setting. (High, Medium, Low, Default = Medium)

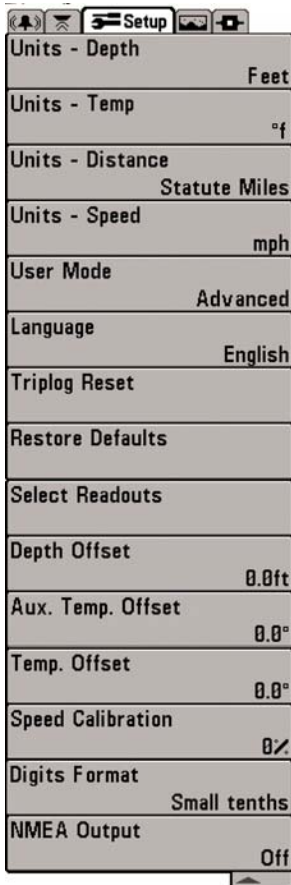

Setup Menu Tab

From any view, press the MENU key twice to access the tabbed Main Menu System, then press the RIGHT cursor key until the Setup tab is selected.

NOTE: Menu choices will vary depending on system settings such as whether the unit is set for Advanced User mode, whether it is an International model, or whether a Temp/Speed or GPS Receiver is currently connected.

Setup Menu

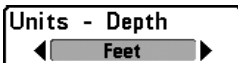

Units - Depth

Units - Depth selects the units of measure for all depth-related readouts.

To change the Units - Depth setting:

1. Highlight Units - Depth on the Setup menu.
2. Use the LEFT or RIGHT 4-WAY Cursor Control keys to change the Units - Depth setting. (Meters [*International Models only*], Feet, Fathoms; Default is Meters for International models, and Feet for Domestic models)

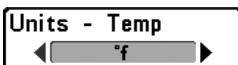

Units - Temp

(International only)

Units - Temp selects the units of measure for all temperature-related readouts. *International Models only.*

To change the Units - Temp setting:

1. Highlight Units - Temp on the Setup menu.
2. Use the LEFT or RIGHT 4-WAY Cursor Control keys to change the Units - Temp setting. (Celsius, Fahrenheit; Default = Celsius)

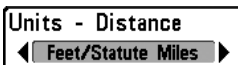

Units - Distance

(with Temp/Speed or GPS receiver)

Units - Distance selects the units of measure for all distance-related readouts, and will appear in the menu if a Temp/Speed Accessory is connected and the paddlewheel has moved at least once, or if a GPS Receiver is connected.

To change the Units - Distance setting:

1. Highlight Units - Distance on the Setup menu.
2. Use the LEFT or RIGHT 4-WAY Cursor Control keys to change the Units - Distance setting. (Domestic Models: Statute Miles, Nautical Miles; Default = Statute Miles; International Models: Meters/Kilometers, Meters/Nautical Miles, Feet/Statute Miles, Feet/Nautical Miles; Default = Meters/Kilometers)

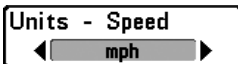

Units - Speed

(with Temp/Speed or GPS receiver)

Units - Speed selects the units of measure for speed-related readouts, and will appear in the menu if a Temp/Speed Accessory is connected and the paddlewheel has moved at least once, or if a GPS Receiver is connected.

To change the Units - Speed setting:

1. Highlight Units - Speed on the Setup menu.
2. Use the LEFT or RIGHT 4-WAY Cursor Control keys to change the Units - Speed setting. (kph [*International Models only*], mph, kts, Default = kph for International models and mph for Domestic models)

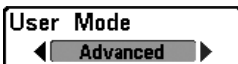

User Mode

User Mode sets the menu system to either Normal or Advanced. When set to Normal (default setting), only the basic menu options are shown. When set to Advanced, additional menu choices are available.

To change the User Mode setting:

1. Highlight User Mode on the Setup menu.
2. Use the LEFT or RIGHT 4-WAY Cursor Control keys to change the User Mode setting. (Normal, Advanced, Default = Normal)



Language

(*International only*)

Language selects the display language for menus. *International Models only.*

To change the Language setting:

1. Highlight Language on the Setup menu.
2. Use the LEFT or RIGHT 4-WAY Cursor Control keys to change the Language setting. (Default = English)

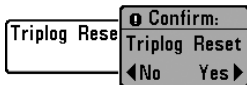

Triplog Reset

(with Temp/Speed or GPS receiver)

Triplog Reset resets the Triplog to zero, and will appear in the menu if a Temp/Speed Accessory is connected and the paddlewheel has moved at least once, or if a GPS Receiver is connected. The Triplog provides the following information: timer for elapsed time, distance traveled since last reset, and average speed.

NOTE: See Setup Menu Tab: Select Readouts (Advanced) to find out how to display Triplog information on the screen.

To Reset Triplog:

1. Highlight Reset Triplog on the Setup menu.
2. Use the RIGHT 4-WAY Cursor Control key to initiate Triplog Reset.
3. The Confirm dialog box will appear. To reset the Triplog, press the RIGHT Cursor key once more. To cancel Reset Triplog, press the LEFT Cursor key.

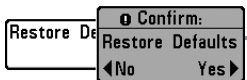

Restore Defaults

Restore Defaults resets ALL menu settings to their factory defaults. Use this menu choice with caution!

To Restore Defaults:

1. Highlight Restore Defaults on the Setup menu.
2. Use the RIGHT 4-WAY Cursor Control key to initiate restoring defaults.
3. The Confirm dialog box will appear. To reset the defaults, press the RIGHT Cursor key once more. To cancel Restore Defaults, press the LEFT Cursor key.

Select Readouts**Select Readouts***(Advanced, Sonar view only)*

Select Readouts sets individual digital readouts on the Sonar View. This Advanced feature allows you to select what data will be displayed in each of 6 fixed-position data windows arranged around the left and bottom edges of the Sonar View screen, or whether a particular window will be turned off, displaying nothing in that area; you can access this menu choice only when in Advanced User Mode (see *Setup Menu Tab: User Mode.*)

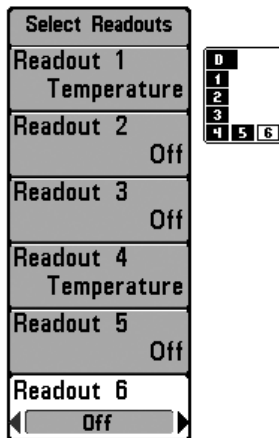

Select Readouts

Data windows can display readouts from supported accessories such as Temp/Speed. Each data window can either be empty or contain one of the following:

- **Speed** (will be displayed if a Temp/Speed Accessory is attached and the paddlewheel has moved at least once, or if a GPS Receiver is connected)
- **Temperature** (will display temperature from the temperature probe that is built in to the transducer)
- **Triplog** (will be displayed if a Temp/Speed Accessory is attached and the paddlewheel has moved at least once, or if a GPS Receiver is connected)
- **Voltage**
- **Aux Temp** (will display temperature from an optional-purchase temperature probe or Temp/Speed accessory)
- **Water Speed** (will only be displayed if a Temp/Speed Accessory is attached and the paddlewheel has moved at least once). Water Speed is not available with a GPS receiver.

Default Sonar View

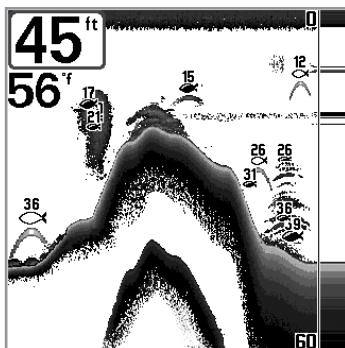

Customized Sonar View

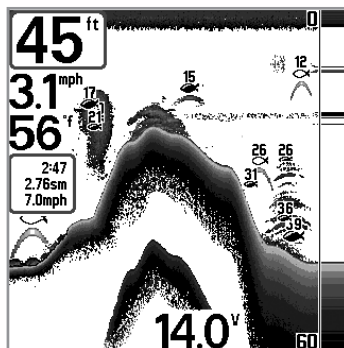

To Select Readouts:

1. Make sure you are in Advanced User Mode, then highlight Select Readouts on the Setup main menu.
2. Use the RIGHT 4-WAY Cursor Control key to initiate this procedure.
3. The Select Readouts submenu will appear, showing a list of all Readouts. Use the UP or DOWN Cursor keys to select a particular Readout position, then use the RIGHT or LEFT Cursor keys to change what will be displayed at that position. (Speed, Temperature, Triplog, Voltage, Aux Temp, Water Speed)

Depth Offset	0.0ft
-10.0	10.0

Depth Offset

(Advanced)

Depth Offset will adjust the digital depth readout to indicate depth from the waterline or boat's keel. Enter a positive vertical measurement from the transducer to the waterline to read the depth from the waterline. Enter a negative vertical measurement from the transducer to keel to read the depth from the keel. This menu choice is available only when in Advanced User Mode (see *Setup Menu Tab: User Mode*.)

To change the Depth Offset setting:

1. Make sure you are in Advanced User Mode, then highlight Depth Offset on the Setup menu.
2. Use the LEFT or RIGHT 4-WAY Cursor Control keys to change the Depth Offset setting. (-10.0 to +10.0 feet or -3 to 3 meters *[International Models only]*, Default = 0)

Aux. Temp. Offset	0.0°
-10.0	10.0

Aux. Temp. Offset

(Advanced; with optional-purchase temp. probe or Temp/Speed only)

Aux. Temp. Offset will adjust the temperature readout from the optional-purchase temp. probe or Temp/Speed accessory by the amount entered. This menu choice is available only when in Advanced User Mode (see Setup Menu Tab: User Mode) with an optional-purchase temp. probe or Temp/Speed accessory.

To change the Aux. Temp. Offset setting:

1. Make sure you are in Advanced User Mode, then highlight Aux. Temp. Offset on the Setup menu.
2. Use the LEFT or RIGHT 4-WAY Cursor Control keys to change the Aux. Temp. Offset setting. (-10.0 to +10.0 degrees, Default = 0)



Temp Offset

(Advanced)

Temp Offset will adjust the temperature readout by the amount entered. This menu choice is available only when in Advanced User Mode (see *Setup Menu Tab: User Mode*.)

To change the Temp Offset setting:

1. Make sure you are in Advanced User Mode, then highlight Temp Offset on the Setup menu.
2. Use the LEFT or RIGHT 4-WAY Cursor Control keys to change the Temp Offset setting. (-10.0 to +10.0 degrees, Default = 0)

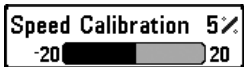

Speed Calibration

(Advanced, with Temp/Speed only)

Speed Calibration will adjust the speed readout by the percentage entered, and will appear in the menu if a Temp/Speed Accessory is connected and the paddlewheel has moved at least once, when the unit is in Advanced User Mode (see *Setup Menu Tab: User Mode*.)

To change the Speed Calibration setting:

1. Make sure you are in Advanced User Mode, then highlight Speed Calibration on the Setup menu.
2. Use the LEFT or RIGHT 4-WAY Cursor Control keys to change the Speed Calibration setting. (-20% to +20%, Default = 0%)

Digits Format

◀ Small tenths ▶

Digits Format*(Advanced)*

Digits Format allows you to add a tenth decimal place to readouts such as Temperature and Depth. The format can be changed to small format, large format or no format. This menu choice is available only when in Advanced User Mode (see *Setup Menu Tab: User Mode*.)

To change the Digits Format setting:

1. Make sure you are in Advanced User Mode, then highlight Digits Format on the Setup menu.
2. Use the LEFT or RIGHT 4-WAY Cursor Control keys to change the Digits Format setting. (Small tenths, Large tenths, No tenths, Default = Small tenths)

NOTE: *Choosing No tenths will cause the display to present numbers rounded to whole digits only.*

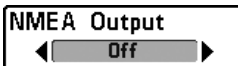

NMEA Output

(Advanced)

NMEA Output turns the NMEA* output on or off. This menu choice is available only when in Advanced User Mode (see *Setup Menu Tab: User Mode.*) NMEA Output should be turned On if you connect the NMEA Output wires of the GPS Receiver cable to another NMEA-compatible device, such as an autopilot.

**NMEA 0183 is a National Marine Electronics Association standard for data communication.*

The following NMEA sentences are output when NMEA Output is turned On:

DPT- Depth

MTW - Water Temperature

GLL - Lat/Lon Position

GGA - GPS Fix Data

RMC - Recommended Minimum Specific GNSS Data

VTG - Course Over Ground and Ground Speed

ZDA - Time and Date

When navigating, the following NMEA sentences are also output when NMEA Output is turned On:

APB - Autopilot Sentence B

BWR - Bearing and Distance to Waypoint

RMB - Recommended Minimum Navigation Info

To turn NMEA Output on or off:

1. Make sure you are in Advanced User Mode, then highlight NMEA Output on the Setup menu.
2. Use the LEFT or RIGHT 4-WAY Cursor Control keys to change the NMEA Output to On or Off (On, Off, Default = Off).

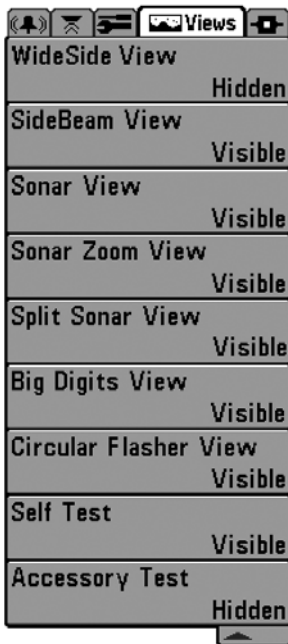

Views Menu

Views Menu Tab

From any view, press the MENU key twice to access the tabbed Main Menu System, then press the RIGHT 4-WAY Cursor Control key until the Views tab is selected. This menu tab allows you to set the available views to either hidden or visible in the view rotation. The view will be removed from the view rotation if it is set to Hidden and will be displayed in the view rotation if it is set to Visible. The following views are available:

- WideSide® View
(with optional-purchase WideSide® transducer)
- SideBeam
(with optional-purchase QuadraBeam PLUS® transducer)
- Sonar
- Sonar Zoom
- Split Sonar
- Big Digits
- Circular Flasher
- Self Test
- Accessory Test.

To change the view status of any view:

1. Highlight the View main menu tab.
2. Use the UP or DOWN 4-WAY Cursor Control keys to select a View.
3. Use the LEFT or RIGHT 4-WAY Cursor Control keys to change the status of the view from Hidden to Visible.

Accessories Menu Tab

From any view, press the MENU key twice to access the tabbed Main Menu System, then press the RIGHT cursor key until the Accessories tab is selected.

If no accessories are attached to the Accessory Bus, no menu choices will appear under the Accessories tab. If an accessory is attached, however, additional menu choices that support the accessory will be added automatically. See the Operations Manual that comes with your accessory for detailed information.



Accessories Menu Tab
(no accessories attached)

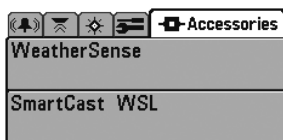

Accessories Menu Tab
(with accessories attached)

NOTE: Accessories to enable WeatherSense®, GPS Functionality and the SmartCast® Wireless Sonar Link require separate purchases. You can visit our website at www.humminbird.com or contact our Customer Resource Center at **1-800-633-1468** for additional details.

Troubleshooting

Before contacting the Humminbird® Customer Resource Center, please read the following section. Taking the time to review these troubleshooting guidelines may allow you to solve a performance problem yourself, and therefore avoid sending your unit back for repair.

700 Series™ Doesn't Power Up

If your 700 Series™ doesn't power up, use the Installation Guide that also comes with it for specific confirmation details, making sure that:

- The power cable is properly connected to the 700 Series™ control head.
- The power cable is wired correctly, with red to positive battery terminal and black to negative terminal or ground.
- The fuse is operational.
- The battery voltage of the power connector is at least 10 Volts.

Correct any known problems, including removing corrosion from the battery terminals or wiring, or actually replacing the battery if necessary.

700 Series™ Defaults to Simulator with a Transducer Attached

A connected and functioning transducer will cause the newly-started Fishing System to go into Normal operating mode automatically. If, when you power up the Fishing System, it goes into Simulator mode automatically, even though a transducer is already connected, this means that the control head is not detecting the transducer. Perform the following troubleshooting tasks:

- Using the Installation Guide that also comes with your Fishing System, check to make sure that the transducer cable is securely connected to the Fishing System. Reconnect if necessary, and power up the Fishing System again to see if this fixes the problem.
- Replace the non-functioning transducer with a known good transducer if available and power up the control head again.
- Check the transducer cable. Replace the transducer if the cable is damaged or corroded.

Display Problems

There are several main conditions or sources of possible interference that may cause problems with the quality of the information displayed on the control head. Look in the following table for some symptoms of display problems and possible solutions:

Problem	Possible Cause
The control head loses power at high speeds.	If the power output of your boat's engine is unregulated, the control head may be protecting itself using its over-voltage protection feature. Make sure the input voltage does not exceed 20 Volts.
When the boat moves at higher speeds, the bottom disappears or suddenly weakens, or the display contains gaps.	The transducer position may need to be adjusted. A mix of air and water flowing around the transducer (cavitation) may be interfering with the interpretation of sonar data. See your Installation Guide for suggestions on adjusting the transducer position.
There are no fish detected, even when you know they are in the water under the boat, or sonar readings seem weak or faulty.	Electrical noise from the boat's engine may be interfering with sonar reception. See <i>Finding the Cause of Noise</i> for more information.
	Sonar readings may be affected if the transducer is not positioned correctly (i.e. mounted at an angle, not straight down), or there is some kind of mechanical interference, either because it is mounted inside a hull that is too thick for proper sonar transmission, the bond between the transducer and the hull is not airtight, or because the transducer is dirty. Check with your Installation Guide for guidance on re-positioning the transducer, and make sure the transducer is clean.
	Low battery voltage may be affecting the power of signal transmission.
	Electrical noise from the boat's engine may be interfering with sonar reception. See <i>Finding the Cause of Noise</i> for more information.

Finding the Cause of Noise

Electrical noise usually affects the display with many black dots at high speeds, and high sensitivity readings. One or more of the following sources can cause noise or interference:

Possible Source of Noise	Isolation
--------------------------	-----------

Other electronic devices	Turn off any nearby electronic devices to see if the problem goes away, then turn them on one at a time to see if the noise re-appears.
---------------------------------	---

The boat's engine	To determine whether the boat's engine is the source of the noise, increase the RPMs while the boat is in neutral and stationary to see if the noise increases proportionately; if noise appears when you rev the engine, the problem could be the spark plugs, alternator, or tachometer wiring. Replace the spark plugs with resistor plugs, install an alternator filter, or route the control head power and transducer cables away from the engine wiring.
--------------------------	---

Cavitation from the boat's propeller	Turbulence created by the propeller can cause noise; make sure the transducer is mounted at least 15" (38 cm) from the propeller, and that the water flows smoothly over the face of the transducer at all times.
---	---

700 Series™ Fishing System Accessories

Accessories customize the 700 Series™ Fishing System to your needs and enable you to stay on the edge of new technology. When an accessory is connected to the 700 Series™ Fishing System, additional menus and readouts are added automatically to the Main Menu System. Accessories available today that are supported by your Fishing System include:

WideSide® transducer: purchase and connect the WideSide® transducer to your 700 Series™ Fishing System to access specialized "side looking" functions that are extremely useful for bank fishing or looking for bait fish in open water.

QuadraBeam PLUS™ transducer: purchase and connect the QuadraBeam PLUS™ transducer to your 700 Series™ Fishing System to access specialized QuadraBeam PLUS™ functions such as fan-shaped 35° 455 kHz Side Structure locating sonar beams to spot fish, bait and structure to the left and right of the boat over an area of the bottom that's always equal to twice your depth, for a continuous 90° of uninterrupted side to side coverage to 160 feet.

Temperature/Speed: purchase and plug in the Temperature/Speed accessory to your 700 Series™ control head to get real time speed and temperature readouts, as well as a valuable Triplog function.

NOTE: If an external Temperature/Speed (TS-W) or Temperature (TG-W) accessory is connected AND a transducer with temperature built in is connected at the same time, the TS-W or TG-W accessory will override the temperature which is built in to the transducer.

WeatherSense® Fishing Condition Monitor: purchase and plug in the WeatherSense® accessory to your 700 Series™ Fishing System to obtain barometric pressure readouts and trend data in real time.

GR4 GPS Receivers: purchase and connect the GR4 GPS Receiver to your 700 Series™ Fishing System to access advanced FishingGPS™, trackplotter and navigation capabilities built-in to your Fishing System.

GPS Connection Cable: purchase the GPS Connection Cable in order to connect a handheld or other NMEA* GPS-compatible device that you may already own to your 700 Series™ Fishing System.

**NMEA 0183 is a National Marine Electronics Association standard for data communication.*

Wireless Sonar Link (WSL) purchase the Wireless Sonar Link (WSL) accessory to receive remote sonar signals from a SmartCast® Remote Sonar Sensor (RSS). Radio signals from the RSS are received by the WSL and transmitted over the Accessory Bus to the 700 Series™ Fishing System.

PC Connect Cable: Purchase the PC Connect Cable to connect the 700 Series™ Fishing System to a PC in order to upload product software updates and new features obtained from www.humminbird.com. This accessory requires the MSWindows-compatible HumminbirdPC™ software downloaded from our website to your PC in order to communicate with the 700 Series™ Fishing System.

Universal Sonar 2: Your 700 Series™ Fishing System supports Universal Sonar 2, a state-of-the-art, integrated and protected transducer that is built into the lower unit of Minnkota trolling motors. With Universal Sonar 2, all wiring is concealed inside the indestructible composite shaft—out of sight and out of harm's way, with no clamps, ties, or exposed wires. Universal Sonar 2 features new temperature sensing and the performance of DualBeam PLUS™ technology (available with all Humminbird® DualBeam PLUS™ models). An expanded view and greater bottom detail gives you a totally new perspective of the water below, along with optimal sonar performance to help you find fish.

Downriggers are the key to catching fish you otherwise couldn't even touch. And now Humminbird's **CannonLink™** Downrigger Controller makes operation of up to six Cannon™ Mag 20 DT or Mag 20 DT/HS downriggers incredibly easy. Using the controls on your Fishing System, deploy or retrieve downriggers, hold a specific distance off the bottom, cycle downriggers between two depths, and adjust the Positive Ion Control. Even see temperature and water clarity at depth and speed at the ball right on-screen when using the Cannon™ Speed-n-Temp. You'll never be shorthanded again, just make adjustments from the helm, while your mate rigs the lines and brings in the fish!

With the new **InterLink™** Network Connection, you can now share GPS position, waypoints, routes and your current track between two Humminbird Fishing Systems in real time. Mark a waypoint at the console, and it's instantly

available on the second unit. No matter where you're at on the boat, you'll have access to your critical fishing and navigation information. Plus, daisy chain InterLink with other System Modules and you'll have a network that lets you share digital data around the boat. It's a simply, clearly, better networking solution!

Be sure to check out our website **www.humminbird.com** for additional new and exciting accessories to grow your 700 Series™ Fishing System!

***NOTE:** Each accessory requires a separate purchase. You can visit our website at **www.humminbird.com** or contact our Customer Resource Center at **1-800-633-1468** for additional details.*

Specifications

Depth Capability 1000 ft (330 m) (717)
1500 ft (450 m) (727)

Power Output .. 300 Watts (RMS), 2400 Watts (Peak to Peak) (717)
Watts (RMS), 4000 Watts (Peak to Peak) (727)

Operating Frequency 200 kHz and 83 kHz DualBeam PLUS™

Area of Coverage 60° @ -10 dB in 83 kHz
20° @ -10 dB in 200 kHz

Target Separation 2 ½ Inches (63.5 mm)

Power Requirement 10-20 VDC

LCD Matrix 320V x 320H (717)
640 V x 320 H (727)

Transducer XHS 9 20 T or XNT 9 20 T

Transducer Cable Length 20 ft (6 m)

Current Draw 250 mA (717)
350 mA (727)

***NOTE:** Humminbird® verifies maximum stated depth in saltwater conditions, but actual depth performance may vary due to transducer installation, water type, thermal layers, bottom composition and slope.*

***NOTE:** Product specifications and features are subject to change without notice.*

POLICY ON ENVIRONMENTAL COMPLIANCE: *It is the intention of Humminbird® to be a good corporate citizen and comply and meet all known and applicable environmental regulations in the areas and countries where our products are sold. We will promote and implement environmentally sound processes in support of national and international regulations.*

ROHS STATEMENT: *Product designed and intended as a fixed installation or part of a system in a vessel may be considered beyond the scope of Directive 2002/95/EC of the European Parliament and of the Council of 27 January 2003 on the restriction of the use of certain hazardous substances in electrical and electronic equipment.*

WEEE STATEMENT: *Product designed and intended as a fixed installation or part of a system in a vessel may be considered beyond the scope of Directive 2002/96/EC of the European Parliament and of the Council of 27 January 2003 on waste electrical and electronic equipment (WEEE).*

CALIFORNIA PROPOSITION 65 STATEMENT: *Lead in cable jackets and boots is restricted to 300 parts per million or less as determined by ICP-AES test methods.*

Glossary

Sonar Terms:

Alarm, Depth: Depth Alarm is a user-controllable, audible alert that sounds when depth is less than or equal to the setting.

Alarm, Temperature: Temperature Alarm is a user-controllable, audible alert that sounds when the water surface temperature equals the setting.

Backlight: Backlight is a user-controllable illumination for the LCD for night and low light use.

Beam (Sonar Beam): A sonar beam is the wide, cone-shaped projection of sound waves formed as sound travels underwater. See *Cone Angle*.

Big Digits View: Big Digits View is a Humminbird® feature that displays the sonar graph and enlarged digital readouts for easy reading from a distance. This is a great tool when monitoring the digital depth is important - such as with higher boat speeds, or when viewing the unit from a distance. When speed input is available, the Big Digits View also shows the TripLog. See *TripLog*.

Bottom Black: Bottom Black is a Humminbird® feature that "fills in" the area of the display below the bottom contour. Bottom Black is preferred by some anglers because of its high contrast and easy readability, even though it can obscure bottom hardness information.

Bottom Contour: Bottom Contour is the profile of the bottom graphed to the display as the depth changes.

Bottom Hardness: Bottom Hardness is the density (or composition) of the bottom, which can often be determined by interpreting the main sonar return. Varying levels of hardness can be determined by interpreting the "thickness" of the sonar return. Hard returns appear thin and black, softer returns appear thicker and less black. It is important to note that a sonar return from a sloping bottom can have the appearance of a softer bottom.

Cavitation: Cavitation is the effect of air bubbles created as the propeller rotates and the boat moves through the water.

Chart Speed: Chart Speed is a user-controllable feature that sets the speed at which sonar information moves across the display. A faster setting displays sonar information from more pings and shows more detail, but the information moves quickly across the display; a slower setting permits viewing of more sonar history, but does not display as much detail. The best setting is often the user's personal choice.

Cone Angle: The cone angle is the angular measurement of the sonar beam at a specific dB down point (i.e. -10 dB). See *dB Down Point*.

Customizable Digital Readouts: Customizable Digital Readouts is a Humminbird® feature that permits the user to select the specific digital information that appears in the main Sonar view (i.e. Speed, Temperature, Barometric Pressure, TripLog, etc.)

Dead Zone: The dead zone is the area of the sonar beam that receives the sonar signal after the main bottom return. Fish and other objects close to the bottom that fall within the dead zone will probably not be visible in the sonar beam. Precision sonar beams, such as the Humminbird® 20° beam, have a smaller dead zone than wider sonar beams.

Decibel: A Decibel is the measurement for sound pressure level, or "intensity" of the sonar return. See *dB Down Point*.

dB Down Point: The dB Down Point is the standard decibel level at which the sonar cone angle is measured, and is written as "@ -10 dB" or "@ -3 dB". Measurements at smaller down points (bigger negative numbers) indicate that the less intensive sonar signals are being used for the measurement.

Display, FSTN: FSTN is an acronym for Film Super-Twist Nematic. FSTN is a monochrome display technology characterized by black, high-contrast pixels. All monochrome fixed mount Humminbird® products use FSTN technology.

DualBeam PLUS™: DualBeam PLUS™ is a Humminbird® sonar configuration that uses two sonar beams simultaneously, and combines the information from both beams into one view by overlapping the data on-screen, or shows each beam individually side by side, or permits each beam to be viewed individually full screen.

Feature Memory: Feature Memory is a Humminbird® feature that retains the user's menu settings in permanent memory. Settings are retained even when the unit is powered off indefinitely.

Fish Arch: A Fish Arch is the apparent "arch" that appears on the display when any object moves through the sonar cone. The arch results from a gradual decrease in distance to an object as it moves into the sonar cone. The distance to an object changes due to the conical shape of the sonar beam, which causes the distance to be greater at the edges of the beam than at the center of the beam. When this distance change is graphed on the display, an arch appears.

Fish ID+™: Fish ID+™ is a Humminbird® feature that uses advanced sonar processing algorithms to determine if a detected object is likely to be a fish. When the sonar signal from an object meets strict parameters, the unit draws a Fish Symbol (or icon) and the digital depth of the target. On DualBeam and DualBeam PLUS™ units, fish detected in the narrow center beam are shown as shaded symbols, and fish detected in the wider beam are shown as hollow symbols.

Fish Symbol: A Fish Symbol is the graphic that is displayed on the screen when Fish ID+™ determines that a sonar return is likely to be a fish. See *Fish ID+™*.

Freeze Frame: Freeze Frame is a Humminbird® feature that pauses the sonar scrolling so that the image on screen can be studied with greater detail. See *Instant Image Update*.

Frequency: Frequency is a measure of the number of sound wave cycles per second of a sound impulse transmitted underwater. A typical frequency for fishfinders is 200 kHz, which offers a good balance of performance under many conditions. Lower frequencies, such as 50 kHz, are capable of penetrating to greater depths, but with less resolution. Higher frequencies, such as 455 kHz, offer greater resolution, but are limited in depth performance. Humminbird® uses a variety of frequencies that are optimized for specific applications.

Grayscale: Grayscale is the use of varying shades of gray to represent the strength of the sonar signal on the display, and is a very intuitive method of presenting information. Traditionally, the strongest sonar signals are represented in black, and progressively weaker signals are represented in progressively lighter shades of gray.

Grayscale, Inverse: Inverse Grayscale is a Humminbird® feature that reverses the correlation of sonar signal strength and the shade of gray typically used to represent it. The strongest sonar signals are represented by "white", and progressively weaker signals are represented in progressively darker shades of gray. While somewhat counter-intuitive, this method makes the sonar images crisper, and has the benefit of enhancing the apparent sensitivity because the weaker signals appear bolder. Inverse grayscale works well in very clear water. Debris-laden water often appears as a lot of clutter on the screen.

Instant Image Update: Instant Image Update is a Humminbird® feature that updates all the sonar information on the display when Sensitivity and a variety of sonar settings (Bottom View, Range, etc.) are modified. This differs from the traditional functionality that only updates the new sonar information collected after the setting change. Instant Image Update permits more accurate fine-tuning of the display because the user can see the results on the complete sonar graph. When combined with the Freeze Frame feature, the user can adjust and understand the effects of many different sonar settings quickly and easily.

Maximum Depth Menu: The Maximum Depth Menu is a Humminbird® feature that optimizes performance based on the maximum operational depth set by the user. Many Humminbird® units can operate across a very broad depth range (up to 2500 feet) which causes the unit to "look" up to that full depth under some circumstances. Due to the speed of sound in water, this can result in less responsiveness because the unit has to wait for a longer period of time to receive the sonar signal. When the Maximum Depth menu is set to a lower value, the unit only looks up to the setting, which increases the responsiveness of the unit. This is an important feature for anyone operating in shallower depths!

Noise: Noise is unintentional, external sound waves that interfere with the optimal operation of sonar. Noise appears as random "dots" on the display, and is caused by a variety of sources. Electrical noise (from trolling motors, bilge pumps, VHF radios) typically manifests as a consistent dot pattern. Electrical noise can be isolated by selectively turning on and off other electrical devices to determine the source. Often re-routing the power cable, or connecting to an alternative power supply (second battery) can help overcome electrical noise. Hydrodynamic noise (from propeller and/or hull cavitation) has a more random appearance and is generally related to boat speed, so that faster operation results in more noise.

Hydrodynamic noise can be overcome by proper transducer installation. Many Humminbird® products have a Noise Filter menu setting that allows the user to clear the screen of noise that is difficult to eliminate.

Pixels: Pixels are the "picture elements", or small square blocks, that make up the image on the LCD. Measured as a vertical by horizontal number (i.e. 640V x 320H), this key specification typically indicates the quality of resolution. In fishfinders, the total resolution (vertical multiplied by horizontal) is often less important than the "Vertical Pixel" resolution. See *Pixels, Vertical*.

Pixels, Vertical: Vertical Pixels are a number of vertical picture elements in a single column on an LCD display. A greater number of vertical pixels provide finer resolution of targets detected by sonar. Essentially, a vertical distance (the depth), when divided by a larger number, breaks that distance into smaller samples, each representing a smaller area and thus providing more detail. In fishfinders, vertical pixels are more critical than horizontal pixels because the horizontal axis of the display represents time, or history. Sonar information on the horizontal axis can vary greatly, depending on boat speed and the Chart Speed setting. A greater number of horizontal pixels show more sonar history that the boat has passed through. On many models, Humminbird® provides the most vertical pixels to provide a better display resolution. See *Chart Speed* and *Pixels*.

Power Output: Power output is the amount of sound energy emitted into the water by the sonar transmitter. Power output is measured using either RMS (Root Mean Square) or P-T-P (Peak-to-Peak) measurement systems. Either method is acceptable, but it is important, when comparing power outputs, to make sure that the same measurement system is being used for both outputs, because P-T-P numbers are 8 times higher than RMS numbers. Greater power output allows the sonar signal to penetrate through weeds and thermoclines, reach deeper depths and operate more effectively in noisy environments, such as when the boat is running at high speed.

Pulse Width (Pulse Length): Pulse Width is the length of time that a sonar sound burst is transmitted into the water. Shorter pulse widths provide better target separation, but cannot travel to great depths. Longer pulse widths provide better depth penetration, but result in poorer target separation. Humminbird® varies pulse width based on depth to optimize both target separation and depth performance. See *Target Separation*.

QuadraBeam PLUS™: QuadraBeam PLUS™ is a Humminbird® sonar configuration that uses four sonar beams for a more detailed bottom image. QuadraBeam PLUS™ uses the DualBeam PLUS™ configuration for downlooking, and also adds two additional beams to look to the left and right. The sonar beams pointing to the left and right provide the ability to spot fish and structure over a wide 90° area, and to identify on which side of the boat they are located. See *DualBeam PLUS™*.

Quick Disconnect Mount: The Quick Disconnect Mounting system is an exclusive Humminbird® feature that permits the unit to be easily removed from the mounting base by pressing a release button, and re-installed by simply snapping it back into place. All cable connections are made when installing, so that no separate wiring connections are required. Additionally, the mount offers 90° tilt and 360° swivel capability to adjust the viewing angle of the unit as you move about the boat.

Real Time Sonar: Real Time Sonar is a Humminbird® technology that delivers ultra-fast sonar transmitter/receiver operation and results in a more detailed instantaneous view of what is under the boat. The Real Time Sonar window is a vertical band at the right side of the display that shows the instantaneous sonar return from the transducer at a particular instant. The RTS® Window menu option permits the user to adjust the window to show the full sonar signal return, or just a narrower band that indicates intensity using grayscale. Real Time Sonar relies on very fast Sonar Update Rate (Ping Speed). See *Sonar Update Rate*.

Receiver: See *Transmitter*.

Second Return: The Second Return is a term that describes the appearance of a second sonar return below the primary sonar return (bottom contour) at exactly twice the true depth. The second return is caused by the same sonar energy bouncing off the bottom once, rebounding to the water surface and then traveling back down to the bottom to be reflected again. Second returns are more common in shallow water and over hard bottoms; it is actually possible to see a third sonar return under some circumstances. The second return provides useful information to help determine bottom hardness, as areas with harder bottoms will generally create a second return. The second return can be used as a guide to set Sensitivity when in shallower water.

Sensitivity: Sensitivity is a user feature that adjusts the sensitivity of the sonar system to show more or less detail in the water. Higher sensitivities are often preferred, however, when the water contains debris (silt, storm debris, etc.) and it can be difficult to pick out targets. Conversely, if sensitivity is set too low, relevant targets may be missed.

SONAR: SONAR is the acronym for SOund and NAvigation Ranging. Sonar technology uses precision sound bursts transmitted underwater to determine the distance and other attributes of objects in the water. Distance can be determined because the speed of sound in water is constant, and the time for the signal to return is measured. Sound also travels very quickly underwater, making sonar a responsive, cost-effective tool. Sonar is the basic technology behind all recreational and commercial fishfinding and depthfinding devices.

Sonar Echo Enhancement: Sonar Echo Enhancement is a Humminbird® feature that describes the high degree of sonar sensitivity achieved through a combination of transmitter/receiver and software algorithms. The result of Sonar Echo Enhancement is to display virtually everything in the water that is of interest to the angler, including bait fish, game fish, thermoclines, weed beds, subtle structure, and more.

Sonar Update Rate: Sonar Update Rate is the number of times per second that the transmitter/receiver sends and receives sonar signals. A very fast sonar update rate collects more information and provides a more detailed image of the bottom, fish and structure. Many Humminbird® units operate at up to 40 times per second when in single frequency operation. Due to the limitation of the speed of sound in water, the update rate begins to slow as depth increases to deeper than 50 feet. In very shallow water (less than 10 feet), however, update rates as much as 60 times per second can be achieved.

Speed: Speed is the rate at which the boat moves through the water. Boat speed can be measured as Speed Over Ground or Speed Through Water. Speed Over Ground is provided by GPS, and is the measurement of the boats progress across a given distance. Speed Through Water is provided by a speed paddlewheel, and is the measurement of the flow past the boat, which may vary depending on current speed and direction. Speed Through Water is most critical for anglers using downriggers, as it impacts the running depth of the down riggers. Speed Over Ground is optimal for navigation, as accurate destination times can be derived from this measurement. Humminbird® products allow for input and display of both sources.

Structure: Structure is a general term for objects on the bottom that present a discontinuity and are a likely attractor for fish. This includes bottom contour features (drop-offs, humps, and holes), standing structure (stumps, timbers, brush piles) and a wide range of other potential objects (sunken boats, reefs). Humminbird® units excel at showing structure with great detail over a wider area due to unique sonar configurations developed for the angler.

Structure ID®: Structure ID® is a Humminbird® feature that describes the traditional grayscale method of presenting sonar information. See *Grayscale*.

Surface Clutter: Surface Clutter is a phenomenon where sonar returns are reflected off of tiny objects near the surface of the water, including algae and even air bubbles. Typically, saltwater environments have significantly greater surface clutter than freshwater due to continuous wind and wave action that causes aeration at the surface. The Surface Clutter menu provides manual control to bias the default settings under extreme conditions.

Target Separation: Target Separation is the measurement of minimum distance that a fishfinder needs to be able to recognize two very close objects as two distinct targets (i.e. two fish hanging very close, or a fish hanging very close to structure). Humminbird® fishfinders provide a very good 2 1/2 inches of target separation in shallower than 100 feet of depth. Target separation decreases as depth increases due to the need for longer Pulse Width to achieve greater depth. See *Pulse Width*.

Thermoclines: Thermoclines are water layer(s) of distinctly different temperatures that create a sonar reflection due to the density of the differing water temperatures. Typically a thermocline will appear as a continuous band across the display at some distance above the bottom contour. Thermoclines are of interest to anglers because fish will suspend above or below the thermocline as they seek the optimum temperature and oxygen levels.

Time Variable Gain: Time Variable Gain is a processing step applied to the sonar return to "normalize" the data so that objects of equal size (i.e. fish) appear to be the same size, even if they are separated by a good distance. Time Variable Gain is a fundamental attribute of good sonar, but is often promoted as a feature.

Total Screen Update®: A Humminbird® feature that refreshes and updates all the sonar information on the display when a range change occurs. Without Total Screen Update®, only the most recent sonar information would be drawn to the

new range, and the old sonar information would continue to scroll off the screen at the old range.

Transducer: The transducer is part of the sonar system, which mounts on the boat and is in contact with the water, that converts the electrical energy from the transmitter into sound energy, and that forms the sonar beam in turn. Internally, the transducer consists of one or more piezo electric disks that expand by very minute amounts to create the sound wave. This element also works in reverse, converting the returned sound energy back into an electrical signal that the receiver interprets. Transducers are available for many specific mounting applications for the boat, such as a transom mount, trolling motor mount, etc. Humminbird® offers many sophisticated transducers, often with multiple piezo electric elements designed to form specifically-shaped sonar beams, providing the angler with superior tools for finding and catching fish. See *Transmitter* and *SONAR*.

Transmitter: The transmitter and receiver are matched parts of the sonar system that send (transmit) and listen to (receive) the sonar signals, and work in conjunction with the transducer. Humminbird® transmitters have an extremely fast cycling design that can send signals up to 60 times per second, as well as produce the varying levels of power output needed for different depths and conditions. Additionally, the transmitter has the capability to create very precise sonar pulses needed for a high degree of target separation. Humminbird® receivers are extremely sensitive, but within a narrow "bandwidth" to discriminate against noise from external sources. Additionally, the receiver offers a wide "dynamic range" which provides the ability to receive very strong signals alternating with very weak signals, without the strong signal overwhelming the weak signal. See *Transducer* and *Noise*.

TripLog: TripLog is a Humminbird® feature that provides an on-screen counter for Elapsed Time, Average Speed and Total Distance traveled, and requires a speed input to activate the feature. TripLog appears on the Big Digits View, and can be reset to zero through the TripLog menu.

TrueArch®: TrueArch® is a Humminbird® feature that provides true fish arches, not artificial arches or symbols. Humminbird® units are capable of producing fish arches due to the wide 60° sonar beam of DualBeam PLUS™, an extremely sensitive sonar receiver. See *Fish Arch*.

Viewing Angle: Viewing Angle is an attribute of an LCD that characterizes visibility of the display when viewing from off the central axis, such as when standing to the side of the fishfinder. Wider viewing angles are better because the information remains visible even when viewing from the side.

WhiteLine®: WhiteLine® is a Humminbird® feature that highlights the strongest sonar return on the display using a very light gray band. This is preferred by some anglers who have grown accustomed to the feature on paper graph chart recorders.

WideSide®: WideSide® is a Humminbird® sonar configuration used in an optional transducer. WideSide® uses three sonar beams pointing to the left, right and down. Beams pointing to the left and right are effective for spotting fish and structure near the surface or on the bank. The downlooking beam provides depth information directly below the boat.

X-Press™ Menu: X-Press™ Menus are a Humminbird® feature that make the most commonly-used menu selections available with one press of the MENU key. Items that appear on the X-Press™ Menu are related to the current view, and present the most logical choices for that view. Sonar View X-Press™ menus will differ from Chart View X-Press™ menus, etc. X-Press™ menus are one of the principal reasons that Humminbird® products are easier to use.

Zoom: Zoom is a feature that focuses in on a smaller area of the bottom to provide enhanced resolution. With enhanced resolution, the angler can more easily see fish hanging in structure or multiple fish hanging close together. Split screen zoom divides the display into the full range view on the right, and the zoomed view on the left. Humminbird® offers One-Touch® Zoom which allows the zoom feature to be easily accessed from the regular sonar view with just one key press, eliminating the need to use menus to access the feature.

Zoom, Bottom Lock: Bottom Lock Zoom is a feature that focuses on a smaller area just above the bottom to provide enhanced resolution. Unlike regular zoom, it continuously graphs the bottom at a constant point on the display regardless of changes in depth. This "flattens" out the bottom contour, but is effective at showing fish on or near the bottom, and is preferred by many saltwater anglers.

Contact Humminbird®

Contact the Humminbird® Customer Resource Center
in any of the following ways:

By Telephone:

(Monday - Friday 8:00 a.m. to 4:30 p.m. Central Standard Time):

1-800-633-1468

By e-mail:

(typically we respond to your e-mail within three business days):

custserv@johnsonoutdoors.com

For direct shipping, our address is:

Humminbird

Service Department
678 Humminbird Lane
Eufaula, AL 36027 USA



Free Manuals Download Website

<http://myh66.com>

<http://usermanuals.us>

<http://www.somanuals.com>

<http://www.4manuals.cc>

<http://www.manual-lib.com>

<http://www.404manual.com>

<http://www.luxmanual.com>

<http://aubethermostatmanual.com>

Golf course search by state

<http://golfingnear.com>

Email search by domain

<http://emailbydomain.com>

Auto manuals search

<http://auto.somanuals.com>

TV manuals search

<http://tv.somanuals.com>