

*Jimmy Houston*  
**PROFLASHER**  
OPERATIONS MANUAL



**HUMMINBIRD**

# INSTALLATION PREPARATION

## *PARTS SUPPLIED*

### ***PARTS SUPPLIED***

Before installing your new Humminbird fishfinder, please ensure the following parts are included in the box:

- Fishfinder
- Transducer with 20' (6m) of cable and mounting hardware kit
- Mounting system and mounting hardware kit
- 6' (2m) power cable
- Publications kit

If any of these items is missing, call our Customer Support Hotline.

### ***ACCESSORIES***

Humminbird offers a wide assortment of accessories that complement and expand the capability of your new fishfinder. These accessories are designed with the same high standards and are backed by the same one-year warranty. The Humminbird Accessory catalog included with your unit contains descriptions of the many accessories available and ordering information. All Humminbird accessories are available through your full-service Humminbird dealer or factory direct through our number listed in the Customer Support section.

### ***INSTALLATION OVERVIEW***

Your Humminbird fishfinder consists of two primary components to install: the control head and the transducer.

The control head contains the sonar transmit and receive circuitry, as well as the user controls and display. It should be installed in a location that provides access to the controls and visibility while in use. The control head mounts on a quick disconnect mounting system that swivels and tilts providing flexibility for viewing from almost anywhere on the boat.

The transducer converts electrical energy from the transmitter into mechanical pulses or sound waves. The transducer also receives the reflected sound waves and converts them back into electrical signals for display on the control head. It should be installed in contact with the surface of the water in an area that has smooth waterflow- usually on the transom of the boat. There are several mounting options for the transducer. Review the following section to determine the method that works for you and your boat.

# INSTALLATION PREPARATION

## INSTALLATION OVERVIEW

### ***Determining How to Mount the Transducer***

Your Humminbird fishfinder includes a standard transducer. This transducer can be mounted on the transom of the boat or bonded to the inside of a fiberglass hull boat.

The transom installation, which is the most widely used, places the transducer on the outside of the boat hull. This technique produces the least signal loss, and provides a way to adjust the transducer after installation. The mounting hardware included is designed to protect both the boat and the transducer should the boat strike debris in the water or when trailering.

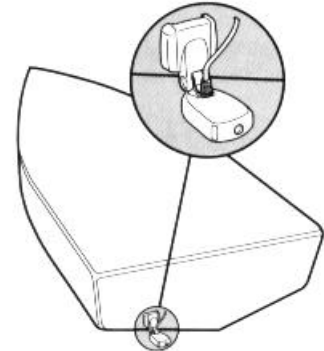

*Transom Mounted Transducer*

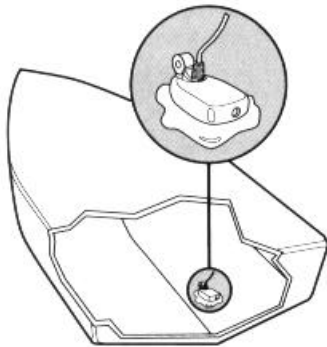

*Inside the Hull Mounted Transducer*

As an alternative to transom mounting, it is possible on many fiberglass-hulled boats to glue the transducer on the inside of the boat hull. Since fiberglass has similar sonar characteristics as water, the sonar signal can pass through the boat hull with minimal loss. The hull of the boat must be single layer construction (not double-hulled) Also, any air trapped in the lamination of the fiberglass would prevent the sonar signal from passing through.

Inside the hull installations require no holes be drilled into the boat and through experimentation, high-speed operation comparable to transom mounting can be achieved. Two-part slow cure epoxy (not included) is required to glue the transducer in place.

# INSTALLATION PREPARATION

## ALTERNATE MOUNTING METHODS

### **ALTERNATE TRANSDUCERS AND MOUNTING METHODS**

Your Humminbird fishfinder comes with everything necessary for installation and operation on most boats. However, there are several situations which may require a different type of transducer. Inboard boats, wood or metal hulls, and sail boats create unique transducer mounting needs. Alternate transducers and mounting methods are detailed below.

#### ***Portable Mounting***

The standard transducer can be adapted for portable installations with a portable mounting kit available from Humminbird. This accessory adapts your transducer to a suction cup mount for temporary installation on the boat hull or other surface.



#### ***Trolling Motor Mounting***

The standard transducer can also be adapted to mount on most trolling motors using a different accessory kit. This accessory includes a bracket and hose clamp that allows mounting the transducer to the body of most trolling motors.



#### ***Thru-Hull Mounting***

Thru-hull transducers install through a hole drilled in the hull of the boat. Larger boats or boats with inboard motors create turbulence that make transom mounting ineffective. Also, hulls that are very thick or are double layered, or made from materials such as wood or metal, (which do not conduct sonar signals) make inside the hull mounting inadvisable.

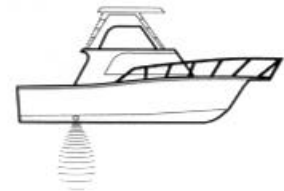

Thru-hull mounting may require the use of a fairing block to level the transducer with the waterline. Also, since special tools and knowledge may be required to perform this type of installation, it is best to refer to a qualified marine technician.

# INSTALLATION PREPARATION

## TRANSDUCER EXCHANGE

### **TRANSDUCER EXCHANGE**

Other transducers are available as replacements for the standard transducer. You may exchange your new and unassembled transducer for another type by returning it to the address listed in Customer Support. Some transducers may have additional cost. Refer to the Accessory catalog or call Customer Support for information.

### **BEGINNING INSTALLATION**

Now that you have determined the transducer mounting method you can begin installation of your new Humminbird fishfinder. The installation guide included on the next few pages provides detailed step by step instructions for installation of the control head and transducer. For transom mount transducer installations you will need the mounting template included with your manual.

In addition to the parts included you need the following for installation and operation:

- A powered hand drill and various drill bits
- Philips and flat-head screwdrivers
- A ruler or measuring tape
- Pen or pencil
- 12 volt power source (your boat's battery)
- A 1-amp fuse
- A fuse holder (if you are wiring directly to the boat's battery)
- Silicone sealant (for sealing drilled holes)
- 2-part, slow-cure epoxy (for inside the hull transducer installations)

# INSTALLATION

## TRANSOM INSTALLATION

**Do not begin this transducer installation until you read the Installation Preparation in the Operation Guide. This chapter contains information critical to the correct installation of your transducer.**

**Due to the wide variety of boat hulls, only general instructions are presented in the installation guide. Each boat hull represents a unique set of requirements that should be evaluated prior to installation.**

### TRANSOM INSTALLATION

#### Step One - Determine Where to Mount the Transducer

Begin the transducer installation by determining where on the transom to install the transducer. Consider the following to find the best location:

- It is very important to locate the transducer in an area which is relatively free of turbulent water. As a boat moves through the water, turbulence is generated by the weight of the boat, and the thrust of the propeller(s). This turbulent water is normally confined to areas immediately aft of ribs, strakes or rows of rivets on the bottom of the boat, and in the immediate area of the propeller(s) (Figure 1). On outboard or inboard/outboard boats it is best to stay at least 15" (40cm) to the side of the propeller(s).
- If possible, viewing the transom of the boat while the boat is moving will provide the best means of locating turbulence free water. If maximum high-speed operation is a high priority, this is the recommended method. If this is not possible, select a location on the transom where the hull forward of this location is smooth, flat, and free of protrusions or ribs.
- The transducer when mounted should point straight down. The design of the transducer will accommodate a wide range of deadrises and remain ported straight down (Figure 2).
- On boats with stepped hulls, it may be possible to mount the transducer on the step. Never mount the transducer on the transom behind a step, as this area of the transom will not be in contact with the water at high speed (Figure 3).

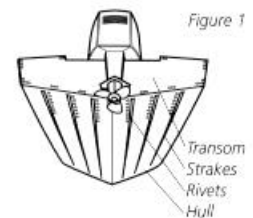

Transom Mounting Location

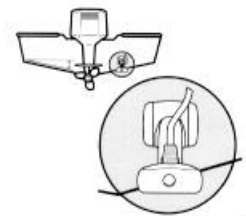

Figure 2

Stepped Hull



Figure 3

# INSTALLATION

## TRANSOM INSTALLATION

- If the propeller(s) is (are) forward of the transom, it may be impossible to find an area clear from turbulence, and a different mounting technique or transducer type should be considered.

### Step Two - Drill the Mounting Holes

1. Remove the mounting template from the front of the Operations Manual.
2. Hold the template on the transom of the boat in the location where the transducer will be installed (Figure 4). Align the template vertically, ensuring the lower edge of the transom meets with the bottom corner of the template.
3. Using a pencil or punch, mark the two mounting holes shown on the template onto the transom. Do not mark or drill any other holes at this time.
4. Using a 5/32" (4mm) bit drill the two holes to a depth of approximately 1" (3cm). On fiberglass hulls, it is best to start with a smaller bit and use progressively larger drill bits to reduce the chance of chipping or flaking the outer coating.

Template alignment

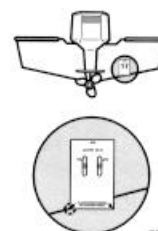

Figure 4

Transducer Assembly

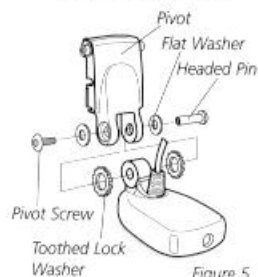

Figure 5

### Step Three - Assemble the Transducer

1. Attach the Pivot to the transducer body as shown in Figure 5, using the #8 – 3/8" (9mm) long allen headed pivot screw, the headed pin, the two flat washers, and the two toothed lock washers.

**Note: The toothed lock washers must be positioned between the transducer and the pivot ears. The flat washers must be positioned to the outside at the pivot ears.**

2. Using the Allen wrenches provided, loosely tighten the pivot screw (Figure 6). Do not completely tighten the assembly at this time, so the pivot angle can be adjusted later.
3. Insert the pivot/transducer assembly into the mounting bracket as shown in Figure 7. Do not snap the assembly closed.



Figure 6

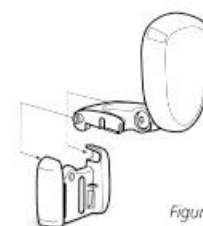

Figure 7





# INSTALLATION

## TRANSOM INSTALLATION

### **Step Four - Mount the Transducer to the Transom**

1. Apply silicone sealant to the mounting holes drilled into the transom.
2. Align the transducer assembly with the drilled holes in the transom (Figure 8).
3. Use either a flat head screwdriver, a 5/16" (8mm) hex driver, or a 5/16" (8mm) socket to mount the assembly. Using the two #10 – 1" (25mm) long slotted hex head screws, mount the transducer assembly to the transom as shown. Do not fully tighten the mounting screws in order to vertically adjust the transducer. Snap the pivot down into place.

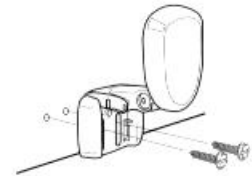

Figure 8

### **Step Five - Adjust the Running Position of the Transducer**

The bracket allows height and tilt adjustment, the pivot screws allow angular adjustment. Initially, adjust the transducer as described in the following paragraphs. Further adjustment may be necessary to refine the installation after high speed testing.

1. First adjust the pivot angle of the transducer body so its length is parallel with the length of hull of the boat. Then pivot the transducer down so the rear is about 1/4 inch (6mm) lower than the front (Figure 9).
2. Fully tighten the two pivot screws using the Allen wrenches. It may be necessary to retighten the pivot screws after the initial use as the plastics may still be seating to the lock washers.
3. Adjust the height of the assembly so the face of the transducer is 3/16" (4.5mm) beneath the lower edge of the transom (Figure 10). Mark the position of the mounting bracket on the transom with a pencil.
4. Force the pivot to the up position to gain access to the mounting screws. Assure the transducer location has not changed, then fully tighten the two mounting screws (Figure 11). Snap the pivot back down.

Running Position Adjustment



Figure 9

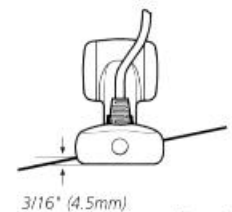

Figure 10

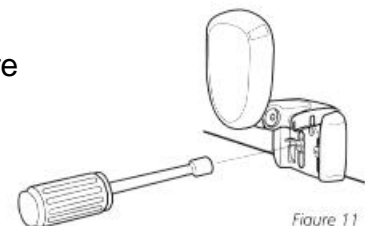

Figure 11

**Confirm the pivot angle has not changed.**

**Note: A third screw location is provided for the**

***mounting bracket. Drill this hole and install the screw after final testing and adjustments have been completed.***

# INSTALLATION

## TRANSOM INSTALLATION

### **Step Six - Route the Cable**

There are several ways to route the transducer cable to the area where the control head will be installed. The most common procedure routes the cable through the transom into the boat.

Inside the boat there is often a channel or conduit used for other wiring that the cable can be routed along. Do not cut or shorten the transducer cable and try not to damage the cable insulation. Route the cable as far as practical from the VHF radio antenna cables or tachometer cable to reduce the possibility of interference.

If the cable is too short, extension cables are available to extend the transducer cable up to a total of 50' (15 m). Call Humminbird Customer Support for more information.

Follow these steps to route the cable through the transom:

1. Drill a 5/8" (16mm) hole above the water line. Route the cable through the hole.
2. Fill the hole with silicone sealant.
3. Place the escutcheon plate over the hole and attach with the two #8 x 5/8" (16mm) screws.
4. Secure the cable by attaching the cable clamp to the transom using a #8 x 5/8" (16mm) screw.

**Note: The transducer will pivot up to 90 degrees in the bracket. Allow enough slack in the cable for this movement. It is best to route the cable to the side of the transducer so the cable will not be damaged by the transducer during movement.**

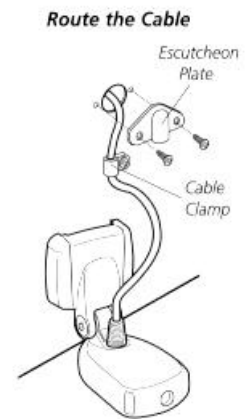

Figure 12

# INSTALLATION

## INSIDE THE HULL INSTALLATION

### INSIDE THE HULL INSTALLATION

Inside the hull installation requires the mount system and control head be installed and operational. See Installing the Control Head for instruction on installing the unit.

Inside the hull mounting generally produces good results in single thickness fiberglass-hulled boats. Humminbird cannot guarantee depth performance when transmitting and receiving through the hull of the boat since some signal loss occurs. The amount of loss depends on hull construction and thickness, and the installation.

This installation requires slow-cure two-part epoxy. Do not use silicone or any other soft adhesive to install the transducer, as this material reduces the sensitivity of the unit. Five minute epoxy has a tendency to cure before all the air bubbles can be purged.

#### Step One - Determine the Mounting Location

Begin the transducer installation by determining where inside the hull to install the transducer. Consider the following to find the best location:

- Observe the outside of the boat hull to find the areas that are mostly free from turbulent water. Avoid ribs, strakes, and other protrusions as these create turbulence (Figure 14).
- As a general rule, the faster the boat can travel the further aft and closer to the centerline of the hull the transducer has to be located to remain in contact with the water at high speeds.

#### Step Two - Test the Mounting Location

There is no opportunity for adjustment after the transducer glued in place. Therefore, it is best to perform a trial installation on inside the hull transducers first, and run the boat at high speeds to determine the best mounting area.

1. At the identified mounting location, lay the transducer body face down with the pointed end towards the bow.
2. Fill the hull with enough water to submerge the transducer body. Use a sand filled bag or other heavy object to hold the transducer in position.

Transducer Mounted Inside the Hull

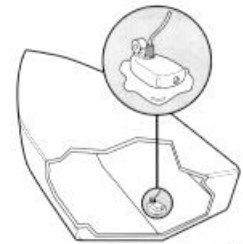

Figure 13

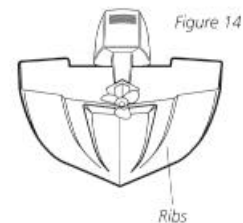

Figure 14

Preferred Mounting Area



Figure 15

The transducer cannot transmit through air. The water purges any air from between the transducer and the hull and fills any voids in the coarse fiberglass surface.

# INSTALLATION

## INSIDE THE HULL INSTALLATION

3. Power up the Control Head.
4. Run the boat at various speeds and water depths while observing the screen on the Control Head. If the unit functions well at low speeds but begins to skip or miss the bottom at higher speeds, the transducer needs to be moved. If depth performance is required, test the fishfinder in water at the desired depth. Test different locations in the hull until the optimum performance is achieved.

### **Step Three - Permanently Mount the Transducer**

1. Once the mounting location is determined, mark the position of the transducer.
2. Remove the water from inside the hull and thoroughly dry the mounting surface. If the surface is excessively rough, it may be necessary to sand the area to provide a smooth mounting surface.

Ensure the mounting area is clear and dry.

3. Mix an ample quantity of two-part slow-cure epoxy slowly and thoroughly. Avoid trapping air bubbles.
4. Coat the face of the transducer and the inside of the hull (Figure 16).
5. Press the transducer into place with a slight twisting motion to purge any trapped air from underneath, keeping the pointed end of the transducer body pointed forward (Figure 17).

**Note: Proper operation requires the pointed end of the transducer body to face towards the bow.**

6. Weight the transducer so it does not move while the epoxy is curing.

When the epoxy cures, no water is necessary inside the hull. Neither water, spilled gasoline, or oil will affect the performance of the transducer.

Figure 16

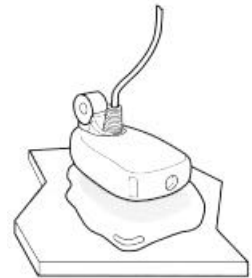
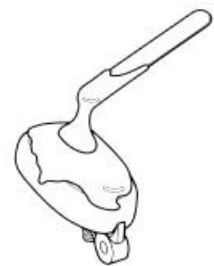

Figure 17

# INSTALLATION

## CONTROL HEAD INSTALLATION

### CONTROL HEAD INSTALLATION

#### Step One - Determine Where to Mount

Begin the installation by determining where to mount the control head. Consider the following to determine best location:

- The cables for power, transducer and temp/speed accessories (if applicable) should be installed first and must reach the mounting location. Extension cables are available.
- There are two ways to route the cables to the unit: through a hole in the mounting surface underneath the mounting bracket or from a hole outside the mounting bracket. Routing the cables down under the mount provides maximum weather protection; however this is not always feasible if the area under the fishfinder is inaccessible. In this case, route the cables through a hole at another location and cover with the supplied hole cover.
- The mounting surface should be adequately supported to protect the fishfinder from excessive wave shock and vibration, and provide visibility while in operation.
- The mounting area should allow sufficient room for the unit to pivot and swivel freely, and for easy removal and installation (Figures 18-19).

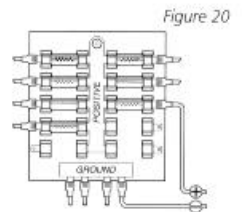
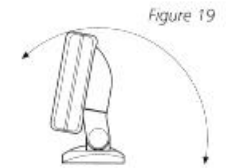
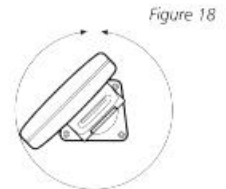

#### Step Two - Connect the Power Cable to the Boat

A 6' (2m) long power cable is included to supply power to the fishfinder. You may shorten or lengthen the cable using 18 gauge multi-stranded copper wire.

**CAUTION: Some boats have 24 or 36 volt electric systems. Be sure your unit is connected to a 12 VDC power supply.**

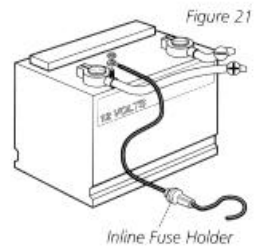

The Power can be connected to the boat's electrical system at two places: a fuse panel, usually located near the console, or directly to the battery.

If a fuse terminal is available, use crimp-on type electrical connectors (not included) that match the terminal on the fuse panel. Attach the black wire to ground, and the red wire to 12 VDC power (Figure 20). Be sure to use a one amp

fuse in the connection. If you must wire the control head directly to a battery, be sure to install an inline fuse holder



# INSTALLATION

## CONTROL HEAD INSTALLATION

and one amp fuse (not included) for the protection of the unit (Figure 21). Humminbird is not responsible for over voltage or over current failures.

In order to minimize the potential for interference with other marine electronics a separate power source (such as a second battery) may be necessary.

### Step Three - Drill the Mounting Holes

1. Set the mounting bracket in place on the mounting surface. Mark the four mounting screw locations with a pencil or punch.
2. Set the mounting bracket aside, and drill the four mounting screw holes using a 9/64" (3.6mm) bit.

### Step Four - Run the Cables

1. If the cables must pass through a hole underneath the mounting surface, mark and drill a 1" (25mm) hole centered between the four mounting holes (Figure 22).

**Note: if the cables must pass through the mounting surface at a different location, drill the 1" (25mm) hole at that location and pass the cables through from underneath. Also, you must break out the tabs on the rear of the mounting base using needle nose pliers (Figures 24-25).**

2. Insert all cables through the 1" (25mm) hole from beneath the mounting surface.
3. Pass the cables through the grommet (if the cable hole is underneath the mounting bracket) then press the grommet in place around the cables and into the 1" (25mm) hole.
4. Pass the cables through the mounting base, out the top of the mounting bracket.
5. Place the mounting bracket on the mounting surface aligned with the drilled holes. Insert the four flathead wood screws into the mounting holes and tighten fully (Figure 23).

Figure 22  
1" (25mm) Hole Location

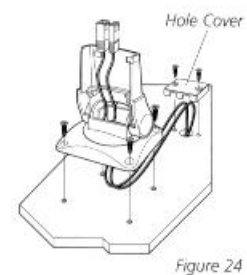
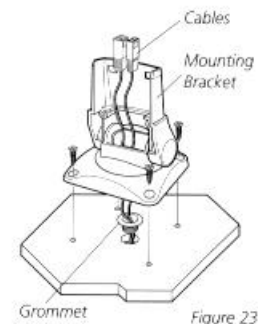
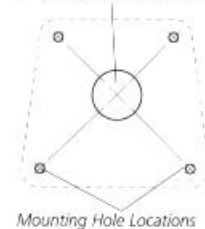

***Optional: If the cables pass outside the mounting bracket, install the hole cover over the hole and fasten in place using the two #8 x 7/8" (22mm) wood screws (Figure 24).***

# INSTALLATION

## CONTROL HEAD INSTALLATION

### Step Five - Assembling the Connector Holder

1. Insert the cable connectors into the connector holder. The cable connectors are labeled, and there are corresponding labels on the connector holder (Figure 26). The slots for the connectors are keyed to prevent reverse installation, so do not force the connector into the holder.
2. Carefully pull the excess cable from beneath the - mounting surface so the connector holder aligns with the mounting holes on the front of the mounting bracket (Figure 27).
3. Snap the support plate to the rear of the connector holder (Figure 28).
4. Insert the connector holder into place and use the two #6-32 x  $\frac{3}{4}$ " (9mm) screws to fasten it to the mounting bracket (Figure 28).
5. Install the control head by sliding it onto the mounting bracket until it is fully seated. To remove the unit simply depress the latch on the rear of the unit and lift (Figure 29).

**Your Humminbird is now ready for operation.**

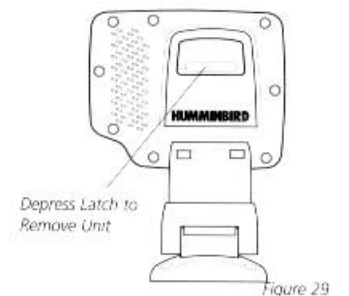
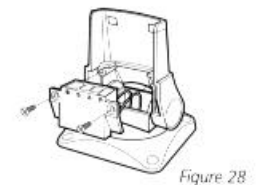
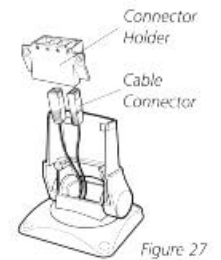
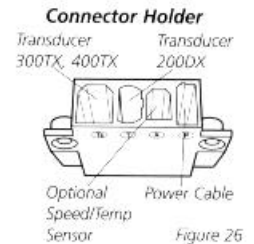

# INSTALLATION

## TEST THE INSTALLATION

### **TEST THE INSTALLATION**

Testing should be performed with the boat in the water, however you can initially confirm basic operation with the boat trailered.

Press POWER once to turn the unit on. There will be an audible chirp when any button is pressed to confirm the button press. If the unit does not power-up, ensure the unit is fully seated on the mount and that power is available.

The first screen provides four options: Start-up, Options, Simulator, and Diagnostic. A message at the bottom of the screen indicates the transducer connection. If no transducer is detected (or one is not connected), the message will indicate this and the unit will go into simulator after the initial screen times out.

***Note: the transducer must be submerged in water for reliable transducer detection.***

If a transducer is detected, the unit will enter "Start Up" or normal operation unless you choose another option. If you do not press any button before the timer reaches "0", the normal operation screen is displayed. If the boat is in water, sonar data appears.

If the bottom is visible on screen with a digital depth readout, the unit is working properly. Ensure the boat is in water greater than 2' but less than the depth capability of the unit and the transducer is fully submerged. Remember the sonar signal cannot pass through air.

If the unit is working properly gradually increase the boat speed to test high-speed performance. If the unit-functions well at low speeds but begins to skip or miss the bottom at higher speeds, the transducer requires adjustment. Refer to the appropriate transducer installation section for more detail.

***Note: it is often necessary to make several incremental transducer adjustments before optimum high-speed performance is achieved.***

Important: For Transom Mount transducer installations, install the third mounting screw after the final transducer adjustments.



Humminbird • 3 Humminbird Lane • Eufaula, Alabama 36027

## TESTING THE INSTALLATION

After installing your Pro Flasher and transducer, you are ready to test the installation. Testing should be performed on the water, since that is the best way to confirm your transducer's performance.

With your boat in the water, turn the Sensitivity / OnOff control clockwise. You should hear the disk start to spin and see an area of light at the "0" line on the dial, and another at the number corresponding to the depth of the water. Turning the Sensitivity control further clockwise increases the sensitivity of the unit so smaller returns will be displayed.

Increase your boat speed to ensure that the transducer remains in contact with turbulence-free water at higher boat speeds. All Humminbird depthsounders are designed to work at speeds of 70 MPH or more, however use caution when operating any boat at high speed. High-speed testing does not apply to portable or trolling motor mounted transducers.

If the Pro Flasher fails to display a bottom return at high speed, first ensure that the depth of the water is not in excess of the unit's capability. Also, ensure that the unit is fully seated on the mount, and the cable connectors are correct. (The label on the cable connector matches the label on the connector holder).

If no light appears when the Power/ Sensitivity control is turned on, the power cable or fuse terminal may be the problem. If the unit obviously powers up but no bottom information is seen on the display, the transducer is most likely the problem.

If the Pro Flasher operates well at idle or slow speeds, but loses the bottom at higher speeds, the transducer is losing intimate contact with the water at higher speeds. If your transducer is transom mounted, adjusting the running angle or depth of the transducer may solve the problem. Several test runs and transducer adjustments may be necessary to optimize transducer performance.

Warning: Due to the "manual" control operation of the Pro Flasher, interference with sonar products using 200 KHz Frequency is likely.

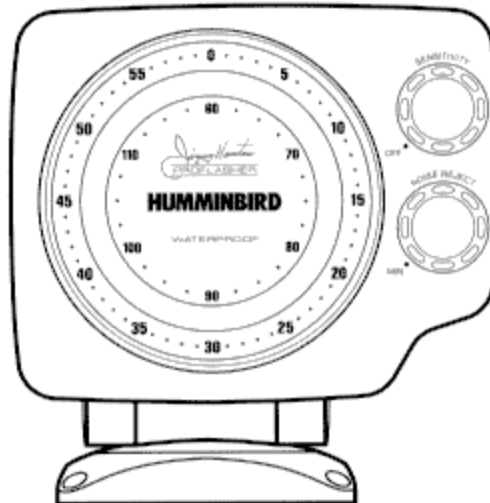

## USING THE PRO FLASHER

The Pro Flasher differs from LCD depthsounders in two important ways: Operation of the unit is completely manual. Adjustment of the sensitivity and noise reject controls, and interpretation of the information displayed is entirely up to the user. Also, there is no history retained on-screen. Information displayed is in the form of instantaneous flashes of light on the dial - targets beneath your boat will appear on-screen for only as long as they are reflecting the sonar signal.

As with any sonar product, the best way to learn to use the Pro Flasher is to operate in a familiar area and study the information presented on the display. As you gain experience with the unit you will be able to quickly analyze the underwater situation, and understand the conditions that lead to more productive fishing.

The Pro Flasher uses a super-bright LED light source to indicate sonar returns. Since the display is naturally "light emitting", it is ideal for use at night or in low-light situations. The rubber lens hood prevents washout in even the brightest sunlight.

As with all Humminbird products, all moving parts are ruggedized for tough shock and vibration endurance, and special components allow the Pro Flasher to operate at temperatures more extreme than you are likely to encounter.

Your Pro Flasher may be used on an existing Wide Eye, Wide View or Wide Vision mounting base. Once mounted it will automatically sense and use the 200 KHz 16° element of the dual beam transducer. The Pro Flasher mounting base can only be used with the Pro Flasher unit.

## CONTROLS

The Pro Flasher uses two simple controls to vary the display of sonar information: Sensitivity/On-Off, and Noise Reject.

The Sensitivity/On-Off control serves as both the power switch for the unit as well as the variable sensitivity control. This is very similar to the volume control on a radio. Increasing the sensitivity is similar to turning up the volume.

Adjustment of the Sensitivity control is largely a matter of personal taste and experience. Lower sensitivity settings will present a clean display with only large returns such as the bottom visible on-screen. Higher sensitivity settings will display progressively smaller signal returns, at the expense of cluttering the display with information.

The depth of the water will affect the sensitivity setting you choose. Shallow water requires a lower setting, while deeper water requires a higher setting since some of the sonar signal will be absorbed or deflected.

Also, the water condition- clear, murky, salt, fresh, etc. will affect the amount of sensitivity required.

The other control is the Noise Reject. Adjustment of this control is not normally necessary in the operation of your Pro Flasher. The variable noise reject feature allows you to filter out electrical interference caused by the boat motor and other electronic devices on your boat.

Noise is normally seen in the form of concentric light patterns that slowly revolve around the dial. If noise is present, you can reduce its effect on the Pro Flasher by turning the Noise

Reject control slowly clockwise until it is filtered out. If no noise is detected, the control should be left in the "MIN" position.

#### WHAT YOU SEE ON THE DISPLAY

A "Zero" line is always present on the dial. This indicates that the unit is transmitting a signal. Any additional light displayed indicates a reflected sonar signal. This could be the bottom or any object between the surface and the bottom. The depth of the water is determined by comparing the leading edge of the bottom return to the number on the appropriate scale (inside or outside ring). The width of the bottom return and any surrounding flashes of light can give the user insight into texture, hardness, ground cover, etc.

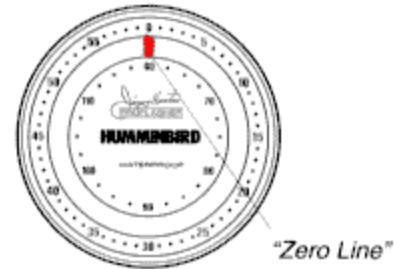

Generally, a wider bottom return indicates a soft bottom. Soft sand and mud tend to allow the sonar signal to penetrate until there is sufficient density to reflect the signal. The result is a wider return signal display. Part of the signal bounces back immediately from the surface of the bottom, part of the signal penetrates slightly.

A hard bottom is generally displayed as a narrow return. All of the signal is reflected off the surface of the bottom simultaneously, so the returned signal arrives intact.

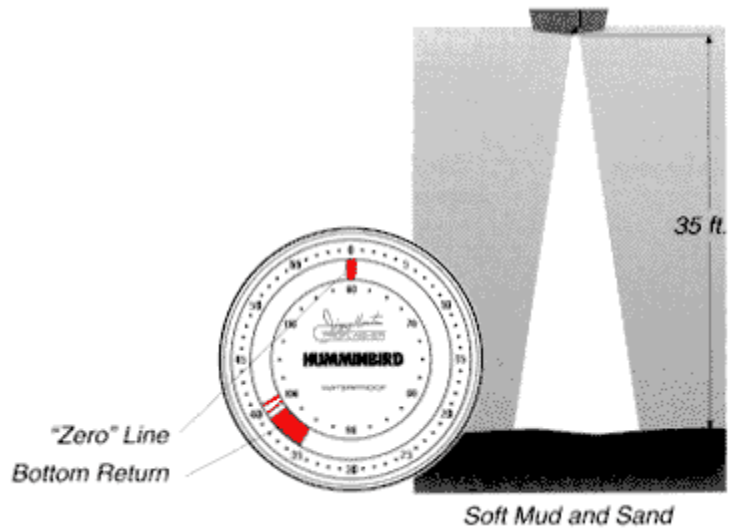

Terrain variation within the area of coverage will spread out the bottom representation. It may be difficult to differentiate a hard sloping bottom from a flat soft bottom.

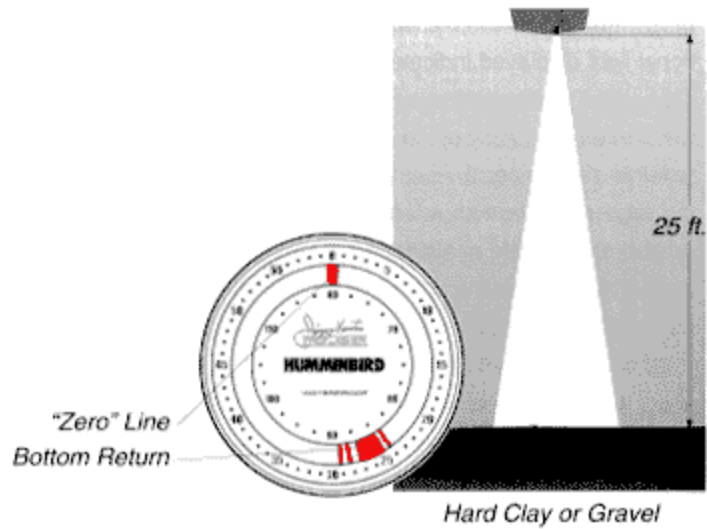

Broken but continuously displayed signals near the bottom return indicate vegetation or ground cover.

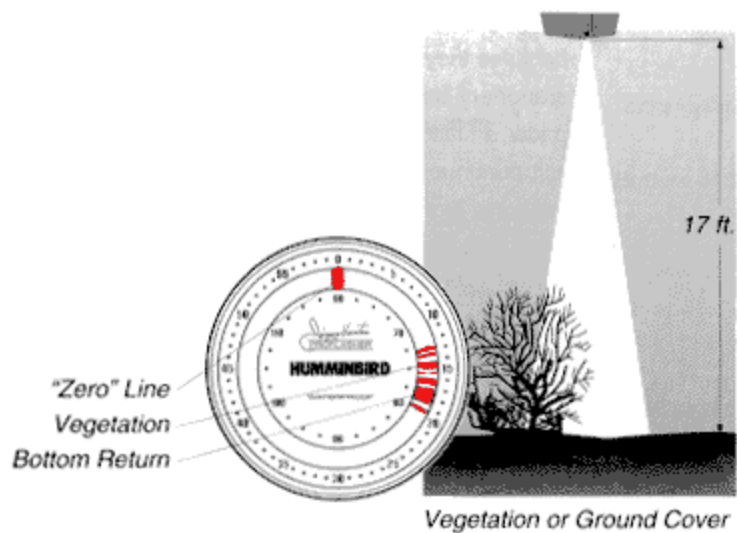

It is often possible to see a "second return" from the bottom. This is usually seen in shallower water when the sensitivity is adjusted higher than normal. The sonar signal is transmitted downward from the boat and is reflected from the bottom back up. As the Pro Flasher senses this returned signal, it is displayed on-screen. The returned signal however is again reflected off the surface of the water and then the bottom giving a faint "second return" from the bottom. A second return is always exactly twice the depth and much weaker than that of the original return, so it is easy to spot on the dial.

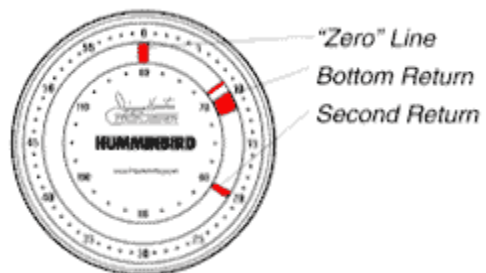

Fish are easy to differentiate on the Pro Flasher because they are usually only displayed briefly. Only a stationary fish directly under a stationary boat will continue to reflect the sonar signal.



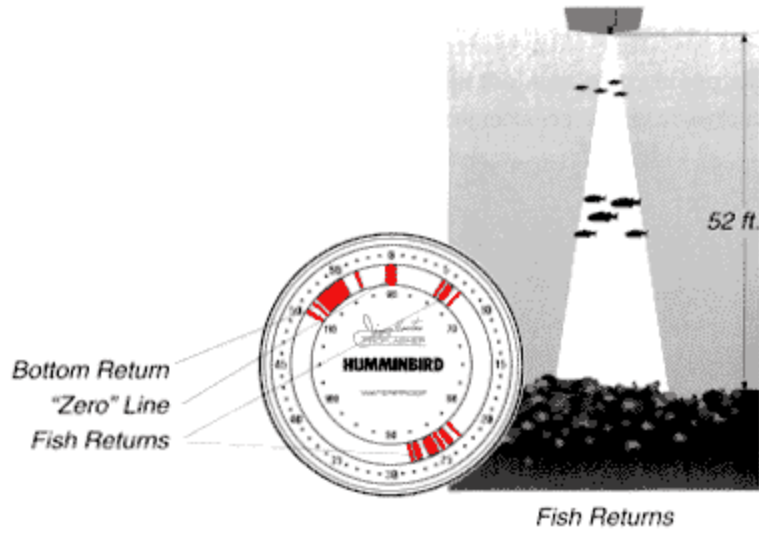

A thermocline is the horizontal boundary where significant water temperature differences exist. When a thermocline exists, it will often tend to reflect sonar signals and is therefore visible on the display. The thermocline is identifiable because it usually exists over a broad area, and as a result will appear more continuous than returns from fish.



When operating the Pro Flasher in depths over 60', the bottom return will continue to rotate beyond the "zero" line on the dial. When the depth is over 60', the returned signal will relate to the numbers printed on the inside of the dial. You may notice that increased sensitivity is necessary due to the signal loss in deeper water. The Pro Flasher will easily track the bottom to depths up to 120'.

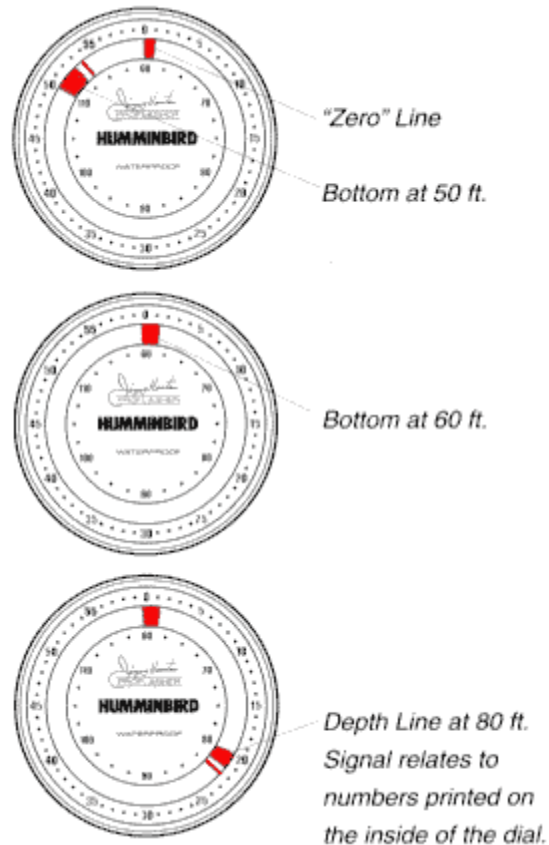

## MAINTAINENCE

Your Humminbird Pro Flasher depthsounder is designed to provide you with years of trouble-free operation with virtually no maintenance. Follow the simple procedures below to ensure that your Pro Flasher continues to deliver top performance.

If the unit comes into contact with salt spray, simply wipe the affected surfaces with a cloth dampened in fresh water.

When cleaning the protective lens, use a chamois and non-abrasive cleaner. Do not wipe while dirt or grease is on the lens. Be careful to avoid scratching the lens.

If your boat remains in the water for long periods of time, algae and other marine growth can reduce the effectiveness of the transducer. Periodically clean the face of the transducer with liquid detergent. Pivoting the transducer up in the bracket may allow better access for inspection or cleaning.

If your boat remains out of the water for a long period of time, it may take some time to wet the transducer when returned to the water. Small air bubbles can cling to the surface of the transducer and interfere with proper operation. These bubbles will dissipate with time, or you may wipe the face of the transducer with your fingers after the transducer is in the water.

Never leave your Pro Flasher unit in a closed car or trunk - the extremely high temperatures generated in hot weather can damage the electronics.

Do not attempt to repair the Pro Flasher yourself. There are no user serviceable parts inside, and special tools and techniques are required for reassembly to ensure the waterproof integrity of the housing. Repairs should be performed only by authorized Humminbird technicians. Many requests for repair received by Humminbird involve units that do not actually need repair. If you have trouble with your Pro Flasher, consult the following troubleshooting guide before contacting Humminbird.

1. Nothing happens when I turn the unit on.

Check the power cable connection and fuse. Be sure the power cable is properly connected - red lead to 12 VDC positive, black lead to negative. Often a fuse can appear to be good when in fact it is not. Check the fuse with a tester, or replace it if in doubt.

Ensure that the Pro Flasher unit is fully seated on the mount, and the latch is engaged. The electrical connections to the unit are not made until the unit is securely seated.

2. There multiple flashes at regular intervals.

Check the Sensitivity control, if the control is on maximum sensitivity turn the control counterclockwise until you get an accurate reading.

3. Unusual or no readings are occurring.

The signal that is reflected back to the transducer from the bottom, or fish, must be strong enough to produce a good clear flash on the dial. Weak flashes or no flashes indicates one of the following:

-The Sensitivity control is turned too far counter clockwise.

-You are positioned above deep decayed vegetation such trees or kelp.

-You are in water over 120 feet deep.

To Correct this problem adjust the Sensitivity control, moving it clockwise toward the maximum setting.

4. I get gaps in the reading at high speeds.

Your transducer requires adjustment. If the transducer is transom mounted, there are two adjustments available to you - height, and running angle. Make small adjustments and run the boat at high speed to determine the effect. It may take several tries to optimize high speed operation.

5. The bottom reading disappears during a hard turn.

This is normal as the transducer comes out of the water, and will correct itself when the turn is complete.

6. My unit loses power at high speeds.

Your Humminbird Wide unit has an over-voltage protection which turns the unit off when input voltage exceeds 17 volts DC. Some outboard motors do not effectively regulate output voltage

and can produce electrical output in excess of 17 volts at higher engine speeds. Installation of an external voltage limiting device will prevent this from occurring.

## Free Manuals Download Website

<http://myh66.com>

<http://usermanuals.us>

<http://www.somanuals.com>

<http://www.4manuals.cc>

<http://www.manual-lib.com>

<http://www.404manual.com>

<http://www.luxmanual.com>

<http://aubethermostatmanual.com>

Golf course search by state

<http://golfingnear.com>

Email search by domain

<http://emailbydomain.com>

Auto manuals search

<http://auto.somanuals.com>

TV manuals search

<http://tv.somanuals.com>