

WIDE 3D VISION

OPERATIONS MANUAL



fish wide open!

INSTALLATION PREPARATION

PARTS SUPPLIED

PARTS SUPPLIED

Before installing your new Humminbird fishfinder, please ensure the following parts are included in the box:

- Fishfinder
- Transducer with 20' (6m) of cable and mounting hardware kit
- Mounting system and mounting hardware kit
- 6' (2m) power cable
- Publications kit

If any of these items is missing, call our Customer Support Hotline.

ACCESSORIES

Humminbird offers a wide assortment of accessories that complement and expand the capability of your new fishfinder. These accessories are designed with the same high standards and are backed by the same one-year warranty. The Humminbird Accessory catalog included with your unit contains descriptions of the many accessories available and ordering information. All Humminbird accessories are available through your full-service Humminbird dealer or factory direct through our number listed in the Customer Support section.

INSTALLATION OVERVIEW

Your Humminbird fishfinder consists of two primary components to install: the control head and the transducer.

The control head contains the sonar transmit and receive circuitry, as well as the user controls and display. It should be installed in a location that provides access to the controls and visibility while in use. The control head mounts on a quick disconnect mounting system that swivels and tilts providing flexibility for viewing from almost anywhere on the boat.

The transducer converts electrical energy from the transmitter into mechanical pulses or sound waves. The transducer also receives the reflected sound waves and converts them back into electrical signals for display on the control head. It should be installed in contact with the surface of the water in an area that has smooth waterflow- usually on the transom of the boat. There are several mounting options for the transducer. Review the following section to determine the method that works for you and your boat.

INSTALLATION PREPARATION

INSTALLATION OVERVIEW

Determining How to Mount the Transducer

Your Humminbird fishfinder includes a standard transducer. This transducer can be mounted on the transom of the boat or bonded to the inside of a fiberglass hull boat.

The transom installation, which is the most widely used, places the transducer on the outside of the boat hull. This technique produces the least signal loss, and provides a way to adjust the transducer after installation. The mounting hardware included is designed to protect both the boat and the transducer should the boat strike debris in the water or when trailering.

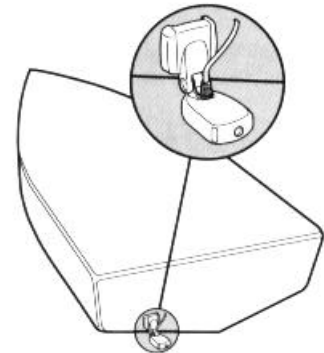

Transom Mounted Transducer

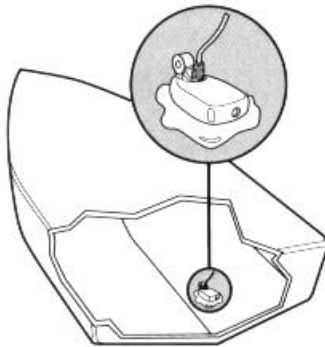

Inside the Hull Mounted Transducer

As an alternative to transom mounting, it is possible on many fiberglass-hulled boats to glue the transducer on the inside of the boat hull. Since fiberglass has similar sonar characteristics as water, the sonar signal can pass through the boat hull with minimal loss. The hull of the boat must be single layer construction (not double-hulled) Also, any air trapped in the lamination of the fiberglass would prevent the sonar signal from passing through.

Inside the hull installations require no holes be drilled into the boat and through experimentation, high-speed operation comparable to transom mounting can be achieved. Two-part slow cure epoxy (not included) is required to glue the transducer in place.

INSTALLATION PREPARATION

ALTERNATE MOUNTING METHODS

ALTERNATE TRANSDUCERS AND MOUNTING METHODS

Your Humminbird fishfinder comes with everything necessary for installation and operation on most boats. However, there are several situations which may require a different type of transducer. Inboard boats, wood or metal hulls, and sail boats create unique transducer mounting needs. Alternate transducers and mounting methods are detailed below.

Portable Mounting

The standard transducer can be adapted for portable installations with a portable mounting kit available from Humminbird. This accessory adapts your transducer to a suction cup mount for temporary installation on the boat hull or other surface.

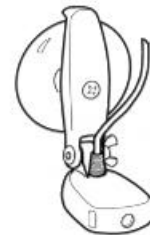

Trolling Motor Mounting

The standard transducer can also be adapted to mount on most trolling motors using a different accessory kit. This accessory includes a bracket and hose clamp that allows mounting the transducer to the body of most trolling motors.



Thru-Hull Mounting

Thru-hull transducers install through a hole drilled in the hull of the boat. Larger boats or boats with inboard motors create turbulence that make transom mounting ineffective. Also, hulls that are very thick or are double layered, or made from materials such as wood or metal, (which do not conduct sonar signals) make inside the hull mounting inadvisable.

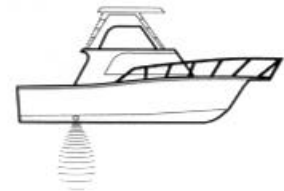

Thru-hull mounting may require the use of a fairing block to level the transducer with the waterline. Also, since special tools and knowledge may be required to perform this type of installation, it is best to refer to a qualified marine technician.

INSTALLATION PREPARATION

TRANSDUCER EXCHANGE

TRANSDUCER EXCHANGE

Other transducers are available as replacements for the standard transducer. You may exchange your new and unassembled transducer for another type by returning it to the address listed in Customer Support. Some transducers may have additional cost. Refer to the Accessory catalog or call Customer Support for information.

BEGINNING INSTALLATION

Now that you have determined the transducer mounting method you can begin installation of your new Humminbird fishfinder. The installation guide included on the next few pages provides detailed step by step instructions for installation of the control head and transducer. For transom mount transducer installations you will need the mounting template included with your manual.

In addition to the parts included you need the following for installation and operation:

- A powered hand drill and various drill bits
- Philips and flat-head screwdrivers
- A ruler or measuring tape
- Pen or pencil
- 12 volt power source (your boat's battery)
- A 1-amp fuse
- A fuse holder (if you are wiring directly to the boat's battery)
- Silicone sealant (for sealing drilled holes)
- 2-part, slow-cure epoxy (for inside the hull transducer installations)

INSTALLATION

TRANSOM INSTALLATION

Do not begin this transducer installation until you read the Installation Preparation in the Operation Guide. This chapter contains information critical to the correct installation of your transducer.

Due to the wide variety of boat hulls, only general instructions are presented in the installation guide. Each boat hull represents a unique set of requirements that should be evaluated prior to installation.

TRANSOM INSTALLATION

Step One - Determine Where to Mount the Transducer

Begin the transducer installation by determining where on the transom to install the transducer. Consider the following to find the best location:

- It is very important to locate the transducer in an area which is relatively free of turbulent water. As a boat moves through the water, turbulence is generated by the weight of the boat, and the thrust of the propeller(s). This turbulent water is normally confined to areas immediately aft of ribs, strakes or rows of rivets on the bottom of the boat, and in the immediate area of the propeller(s) (Figure 1). On outboard or inboard/outboard boats it is best to stay at least 15" (40cm) to the side of the propeller(s).
- If possible, viewing the transom of the boat while the boat is moving will provide the best means of locating turbulence free water. If maximum high-speed operation is a high priority, this is the recommended method. If this is not possible, select a location on the transom where the hull forward of this location is smooth, flat, and free of protrusions or ribs.
- The transducer when mounted should point straight down. The design of the transducer will accommodate a wide range of deadrises and remain ported straight down (Figure 2).
- On boats with stepped hulls, it may be possible to mount the transducer on the step. Never mount the transducer on the transom behind a step, as this area of the transom will not be in contact with the water at high speed (Figure 3).

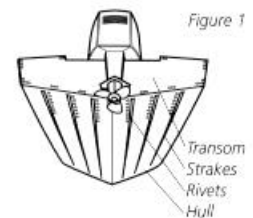

Figure 1

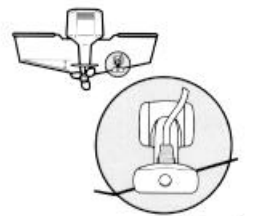

Figure 2



Figure 3

INSTALLATION

TRANSOM INSTALLATION

- If the propeller(s) is (are) forward of the transom, it may be impossible to find an area clear from turbulence, and a different mounting technique or transducer type should be considered.

Step Two - Drill the Mounting Holes

1. Remove the mounting template from the front of the Operations Manual.
2. Hold the template on the transom of the boat in the location where the transducer will be installed (Figure 4). Align the template vertically, ensuring the lower edge of the transom meets with the bottom corner of the template.
3. Using a pencil or punch, mark the two mounting holes shown on the template onto the transom. Do not mark or drill any other holes at this time.
4. Using a 5/32" (4mm) bit drill the two holes to a depth of approximately 1" (3cm). On fiberglass hulls, it is best to start with a smaller bit and use progressively larger drill bits to reduce the chance of chipping or flaking the outer coating.

Template alignment

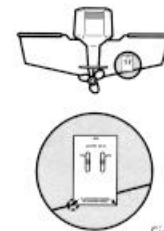

Figure 4

Transducer Assembly

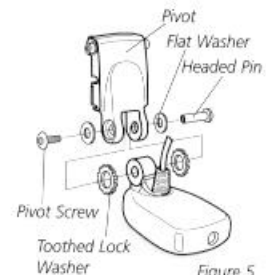

Figure 5

Step Three - Assemble the Transducer

1. Attach the Pivot to the transducer body as shown in Figure 5, using the #8 – 3/8" (9mm) long allen headed pivot screw, the headed pin, the two flat washers, and the two toothed lock washers.

Note: The toothed lock washers must be positioned between the transducer and the pivot ears. The flat washers must be positioned to the outside at the pivot ears.

2. Using the Allen wrenches provided, loosely tighten the pivot screw (Figure 6). Do not completely tighten the assembly at this time, so the pivot angle can be adjusted later.
3. Insert the pivot/transducer assembly into the mounting bracket as shown in Figure 7. Do not snap the assembly closed.



Figure 6

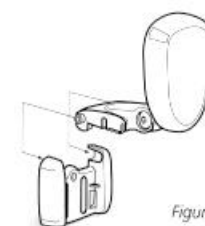

Figure 7

INSTALLATION

TRANSOM INSTALLATION

Step Four - Mount the Transducer to the Transom

1. Apply silicone sealant to the mounting holes drilled into the transom.
2. Align the transducer assembly with the drilled holes in the transom (Figure 8).
3. Use either a flat head screwdriver, a 5/16" (8mm) hex driver, or a 5/16" (8mm) socket to mount the assembly. Using the two #10 – 1" (25mm) long slotted hex head screws, mount the transducer assembly to the transom as shown. Do not fully tighten the mounting screws in order to vertically adjust the transducer. Snap the pivot down into place.

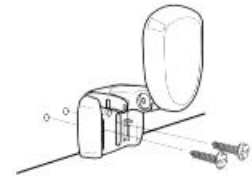

Figure 8

Step Five - Adjust the Running Position of the Transducer

The bracket allows height and tilt adjustment, the pivot screws allow angular adjustment. Initially, adjust the transducer as described in the following paragraphs. Further adjustment may be necessary to refine the installation after high speed testing.

1. First adjust the pivot angle of the transducer body so its length is parallel with the length of hull of the boat. Then pivot the transducer down so the rear is about 1/4 inch (6mm) lower than the front (Figure 9).
2. Fully tighten the two pivot screws using the Allen wrenches. It may be necessary to retighten the pivot screws after the initial use as the plastics may still be seating to the lock washers.
3. Adjust the height of the assembly so the face of the transducer is 3/16" (4.5mm) beneath the lower edge of the transom (Figure 10). Mark the position of the mounting bracket on the transom with a pencil.
4. Force the pivot to the up position to gain access to the mounting screws. Assure the transducer location has not changed, then fully tighten the two mounting screws (Figure 11). Snap the pivot back down.

Running Position Adjustment



Figure 9

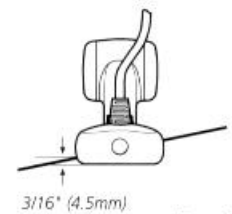

Figure 10

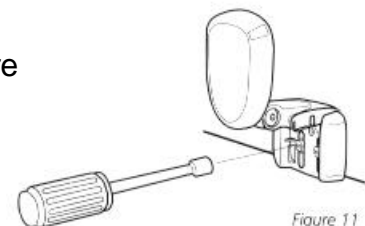

Figure 11

Confirm the pivot angle has not changed.

Note: A third screw location is provided for the

mounting bracket. Drill this hole and install the screw after final testing and adjustments have been completed.

INSTALLATION

TRANSOM INSTALLATION

Step Six - Route the Cable

There are several ways to route the transducer cable to the area where the control head will be installed. The most common procedure routes the cable through the transom into the boat.

Inside the boat there is often a channel or conduit used for other wiring that the cable can be routed along. Do not cut or shorten the transducer cable and try not to damage the cable insulation. Route the cable as far as practical from the VHF radio antenna cables or tachometer cable to reduce the possibility of interference.

If the cable is too short, extension cables are available to extend the transducer cable up to a total of 50' (15 m). Call Humminbird Customer Support for more information.

Follow these steps to route the cable through the transom:

1. Drill a 5/8" (16mm) hole above the water line. Route the cable through the hole.
2. Fill the hole with silicone sealant.
3. Place the escutcheon plate over the hole and attach with the two #8 x 5/8" (16mm) screws.
4. Secure the cable by attaching the cable clamp to the transom using a #8 x 5/8" (16mm) screw.

Note: The transducer will pivot up to 90 degrees in the bracket. Allow enough slack in the cable for this movement. It is best to route the cable to the side of the transducer so the cable will not be damaged by the transducer during movement.

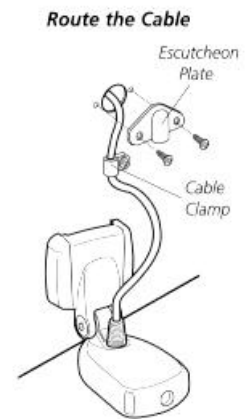

Figure 12

INSTALLATION

INSIDE THE HULL INSTALLATION

INSIDE THE HULL INSTALLATION

Inside the hull installation requires the mount system and control head be installed and operational. See Installing the Control Head for instruction on installing the unit.

Inside the hull mounting generally produces good results in single thickness fiberglass-hulled boats. Humminbird cannot guarantee depth performance when transmitting and receiving through the hull of the boat since some signal loss occurs. The amount of loss depends on hull construction and thickness, and the installation.

This installation requires slow-cure two-part epoxy. Do not use silicone or any other soft adhesive to install the transducer, as this material reduces the sensitivity of the unit. Five minute epoxy has a tendency to cure before all the air bubbles can be purged.

Step One - Determine the Mounting Location

Begin the transducer installation by determining where inside the hull to install the transducer. Consider the following to find the best location:

- Observe the outside of the boat hull to find the areas that are mostly free from turbulent water. Avoid ribs, strakes, and other protrusions as these create turbulence (Figure 14).
- As a general rule, the faster the boat can travel the further aft and closer to the centerline of the hull the transducer has to be located to remain in contact with the water at high speeds.

Step Two - Test the Mounting Location

There is no opportunity for adjustment after the transducer glued in place. Therefore, it is best to perform a trial installation on inside the hull transducers first, and run the boat at high speeds to determine the best mounting area.

1. At the identified mounting location, lay the transducer body face down with the pointed end towards the bow.
2. Fill the hull with enough water to submerge the transducer body. Use a sand filled bag or other heavy object to hold the transducer in position.

Transducer Mounted
Inside the Hull



Figure 13

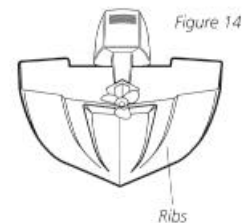

Figure 14

Preferred Mounting Area



Figure 15

The transducer cannot transmit through air. The water purges any air from between the transducer and the hull and fills any voids in the coarse fiberglass surface.

INSTALLATION

INSIDE THE HULL INSTALLATION

3. Power up the Control Head.
4. Run the boat at various speeds and water depths while observing the screen on the Control Head. If the unit functions well at low speeds but begins to skip or miss the bottom at higher speeds, the transducer needs to be moved. If depth performance is required, test the fishfinder in water at the desired depth. Test different locations in the hull until the optimum performance is achieved.

Step Three - Permanently Mount the Transducer

1. Once the mounting location is determined, mark the position of the transducer.
2. Remove the water from inside the hull and thoroughly dry the mounting surface. If the surface is excessively rough, it may be necessary to sand the area to provide a smooth mounting surface.

Ensure the mounting area is clear and dry.

3. Mix an ample quantity of two-part slow-cure epoxy slowly and thoroughly. Avoid trapping air bubbles.
4. Coat the face of the transducer and the inside of the hull (Figure 16).
5. Press the transducer into place with a slight twisting motion to purge any trapped air from underneath, keeping the pointed end of the transducer body pointed forward (Figure 17).

Note: Proper operation requires the pointed end of the transducer body to face towards the bow.

6. Weight the transducer so it does not move while the epoxy is curing.

When the epoxy cures, no water is necessary inside the hull. Neither water, spilled gasoline, or oil will affect the performance of the transducer.

Figure 16

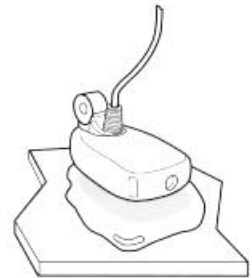

Figure 17

INSTALLATION

CONTROL HEAD INSTALLATION

CONTROL HEAD INSTALLATION

Step One - Determine Where to Mount

Begin the installation by determining where to mount the control head. Consider the following to determine best location:

- The cables for power, transducer and temp/speed accessories (if applicable) should be installed first and must reach the mounting location. Extension cables are available.
- There are two ways to route the cables to the unit: through a hole in the mounting surface underneath the mounting bracket or from a hole outside the mounting bracket. Routing the cables down under the mount provides maximum weather protection; however this is not always feasible if the area under the fishfinder is inaccessible. In this case, route the cables through a hole at another location and cover with the supplied hole cover.
- The mounting surface should be adequately supported to protect the fishfinder from excessive wave shock and vibration, and provide visibility while in operation.
- The mounting area should allow sufficient room for the unit to pivot and swivel freely, and for easy removal and installation (Figures 18-19).

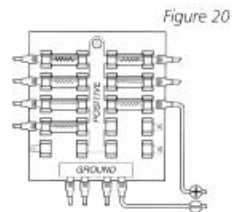
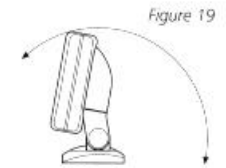
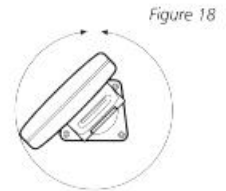

Step Two - Connect the Power Cable to the Boat

A 6' (2m) long power cable is included to supply power to the fishfinder. You may shorten or lengthen the cable using 18 gauge multi-stranded copper wire.

CAUTION: Some boats have 24 or 36 volt electric systems. Be sure your unit is connected to a 12 VDC power supply.

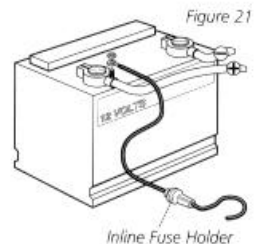

The Power can be connected to the boat's electrical system at two places: a fuse panel, usually located near the console, or directly to the battery.

If a fuse terminal is available, use crimp-on type electrical connectors (not included) that match the terminal on the fuse panel. Attach the black wire to ground, and the red wire to 12 VDC power (Figure 20). Be sure to use a one amp

fuse in the connection. If you must wire the control head directly to a battery, be sure to install an inline fuse holder

INSTALLATION

CONTROL HEAD INSTALLATION

and one amp fuse (not included) for the protection of the unit (Figure 21). Humminbird is not responsible for over voltage or over current failures.

In order to minimize the potential for interference with other marine electronics a separate power source (such as a second battery) may be necessary.

Step Three - Drill the Mounting Holes

1. Set the mounting bracket in place on the mounting surface. Mark the four mounting screw locations with a pencil or punch.
2. Set the mounting bracket aside, and drill the four mounting screw holes using a 9/64" (3.6mm) bit.

Step Four - Run the Cables

1. If the cables must pass through a hole underneath the mounting surface, mark and drill a 1" (25mm) hole centered between the four mounting holes (Figure 22).

Note: if the cables must pass through the mounting surface at a different location, drill the 1" (25mm) hole at that location and pass the cables through from underneath. Also, you must break out the tabs on the rear of the mounting base using needle nose pliers (Figures 24-25).

2. Insert all cables through the 1" (25mm) hole from beneath the mounting surface.
3. Pass the cables through the grommet (if the cable hole is underneath the mounting bracket) then press the grommet in place around the cables and into the 1" (25mm) hole.
4. Pass the cables through the mounting base, out the top of the mounting bracket.
5. Place the mounting bracket on the mounting surface aligned with the drilled holes. Insert the four flathead wood screws into the mounting holes and tighten fully (Figure 23).

Figure 22
1" (25mm) Hole Location

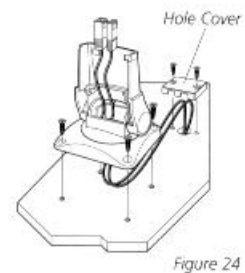
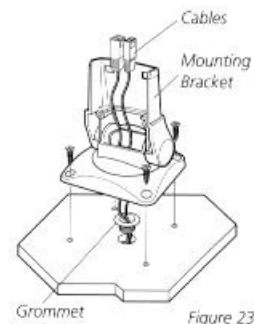
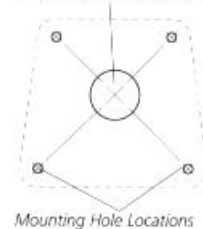

Optional: If the cables pass outside the mounting bracket, install the hole cover over the hole and fasten in place using the two #8 x 7/8" (22mm) wood screws (Figure 24).

INSTALLATION

CONTROL HEAD INSTALLATION

Step Five - Assembling the Connector Holder

1. Insert the cable connectors into the connector holder. The cable connectors are labeled, and there are corresponding labels on the connector holder (Figure 26). The slots for the connectors are keyed to prevent reverse installation, so do not force the connector into the holder.
2. Carefully pull the excess cable from beneath the - mounting surface so the connector holder aligns with the mounting holes on the front of the mounting bracket (Figure 27).
3. Snap the support plate to the rear of the connector holder (Figure 28).
4. Insert the connector holder into place and use the two #6-32 x $\frac{3}{4}$ " (9mm) screws to fasten it to the mounting bracket (Figure 28).
5. Install the control head by sliding it onto the mounting bracket until it is fully seated. To remove the unit simply depress the latch on the rear of the unit and lift (Figure 29).

Your Humminbird is now ready for operation.

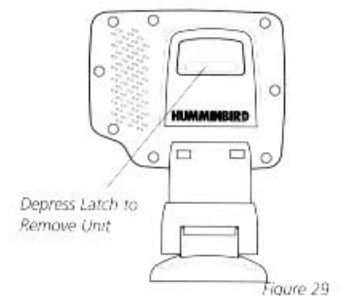
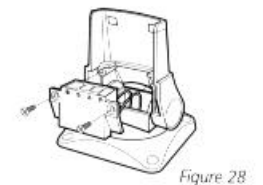
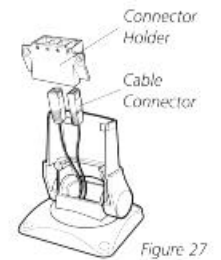
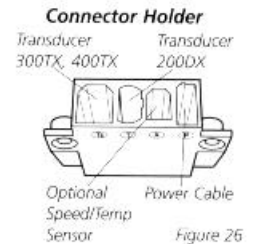

INSTALLATION

TEST THE INSTALLATION

TEST THE INSTALLATION

Testing should be performed with the boat in the water, however you can initially confirm basic operation with the boat trailered.

Press POWER once to turn the unit on. There will be an audible chirp when any button is pressed to confirm the button press. If the unit does not power-up, ensure the unit is fully seated on the mount and that power is available.

The first screen provides four options: Start-up, Options, Simulator, and Diagnostic. A message at the bottom of the screen indicates the transducer connection. If no transducer is detected (or one is not connected), the message will indicate this and the unit will go into simulator after the initial screen times out.

Note: the transducer must be submerged in water for reliable transducer detection.

If a transducer is detected, the unit will enter "Start Up" or normal operation unless you choose another option. If you do not press any button before the timer reaches "0", the normal operation screen is displayed. If the boat is in water, sonar data appears.

If the bottom is visible on screen with a digital depth readout, the unit is working properly. Ensure the boat is in water greater than 2' but less than the depth capability of the unit and the transducer is fully submerged. Remember the sonar signal cannot pass through air.

If the unit is working properly gradually increase the boat speed to test high-speed performance. If the unit-functions well at low speeds but begins to skip or miss the bottom at higher speeds, the transducer requires adjustment. Refer to the appropriate transducer installation section for more detail.

Note: it is often necessary to make several incremental transducer adjustments before optimum high-speed performance is achieved.

Important: For Transom Mount transducer installations, install the third mounting screw after the final transducer adjustments.



Humminbird • 3 Humminbird Lane • Eufaula, Alabama 36027

WHAT YOU SEE ON SCREEN

The first thing you may notice about the Wide 3D Vision unit is the high-resolution, wide screen LCD display. The LCD display uses super-twist technology for maximum viewability and is ruggedized for tough shock and vibration endurance. The display is also backlit for nighttime operation, and uses special components so it can operate at temperatures more extreme than you are likely to encounter.

The Wide 3D Vision gives you three basic ways to view the bottom terrain: 3D view, 2D view, and the Combo view. Simply pressing the VIEW button will toggle these options. The default view, which is selected when you first power the unit, is the 3D view shown in Figure a. The sonar returns from each of the six elements are combined to create a wire-frame type 3D representation of target location and bottom terrain.

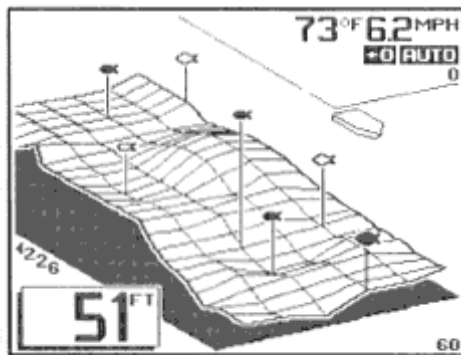

Figure A

Current information, or the terrain directly beneath your boat, is displayed on the lower right, and advances to the left as new information is received. The view created is an accurate depiction of the terrain which you have just covered.

In some situations, the selected point of view may prevent the display of some information due to the slope of the terrain. If you are traveling in a direction which will present this situation for an extended period of time, an option is available to reverse the view-point to the opposite side of your boat, which enables you to see information that would otherwise be masked by the terrain. The normal or default point of view is called "right perspective" since the view point is to the right of the boat.

Reversing this view point is called "left perspective" (Figure B). This option is available in the System Options screen which will be discussed in more detail later in this manual.

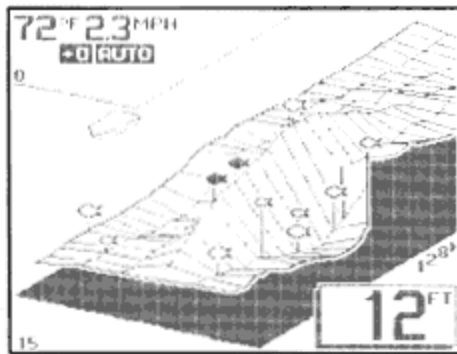

Figure B

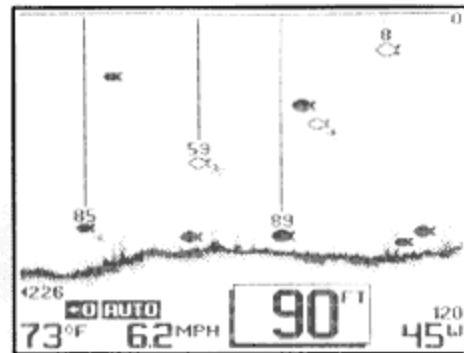

Figure C

The 2D view shown in Figure C, will be familiar to previous sonar users. All the information collected by the six individual beams is compressed into a 2-dimensional presentation. The most current information is displayed on the right side of the screen and moves to the left as new information is received.

The Combo view combines a 3D and 2D representation of the same information. This view is shown in Figure D and is especially useful in learning to use the 3D presentation.

A valuable accessory available for use with all Wide 3D products is Wide Side. Your unit has the capability of displaying information from a special "side-locking" transducer as shown in Figure E. See the "Advanced Feature" section for more information.

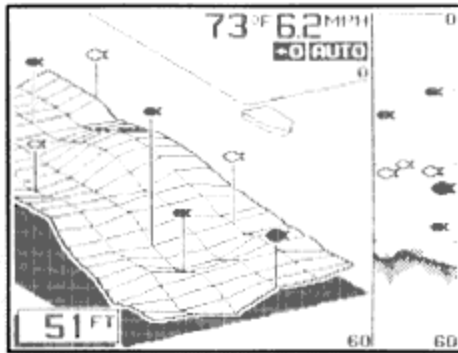

Figure D

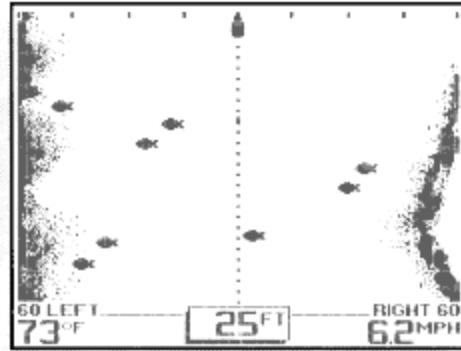
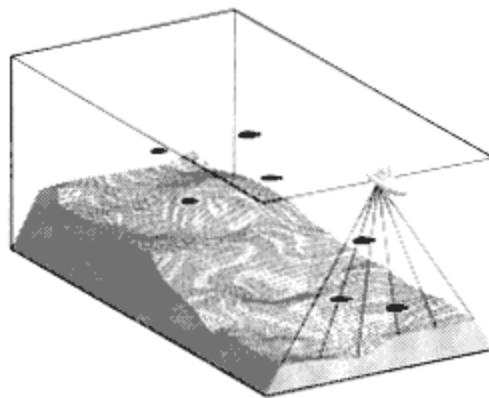

Figure E

Using the View button to toggle between the three main views gives you the maximum benefit of each type of view: The 3D view gives you an excellent representation of bottom terrain and target location, The 2D view is best for determining bottom hardness and texture and locating structure or bottom detail. The combo view combines both 3D and 2D views to provide the best of both views.

USING THE 3D VIEW

At power-up, the Wide 3D Vision locates the bottom and adjusts the depth range to a setting most appropriate for that depth. The bottom will usually be displayed about 2/3 of the way down the display. Each of the six sonar beams transmits a signal at a rate of about four times per second. The returned signals from each transmit are compared and evaluated before the information is displayed, so each display update contains information gathered from several transit and receive cycles.



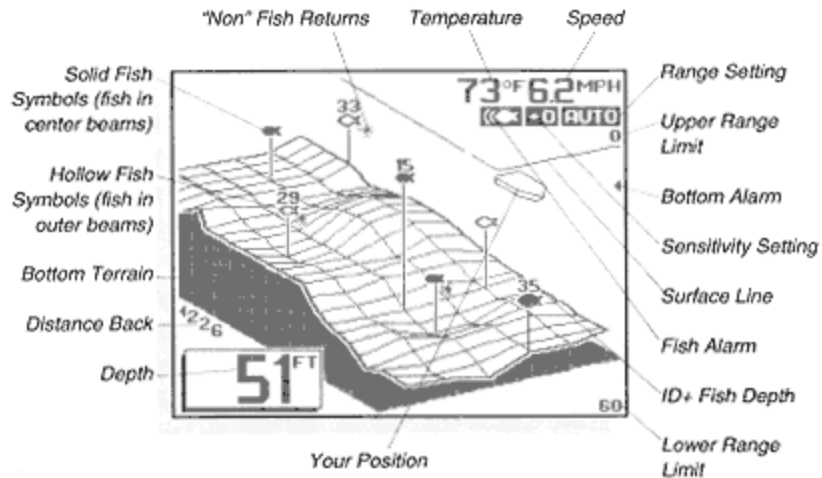

The digital depth shown on-screen is the depth of the water directly beneath your boat. As new information is received, the most recent information is displayed at the lower right, directly underneath the boat symbol. Previous information advances to the left. Boat speed and water surface temperature are displayed at the upper right. If you have not connected this accessory, the screen layout will be slightly different. The distance back number represents the linear distance of the sonar information being displayed. The faster your boat is moving, the greater the amount of distance will be seen on the screen.

As the depth of the water changes, the Wide 3D Vision will automatically adjust the depth range and sensitivity as necessary to view the bottom on-screen. The 3D view of the Wide 3D Vision is capable of tracking the bottom to a depth of 240 feet. Beyond 240 feet, you must select the 2D view for bottom tracking to 1000 feet. When operating at depths near 240 feet in the 3D or Combo views, A message will appear warning you of the depth limitations of the 3D view. Also, the 2D view has a depth capability much greater than the 3D view. The 200 kHz transducer will provide reliable target and bottom tracking to a depth of 1000 feet.

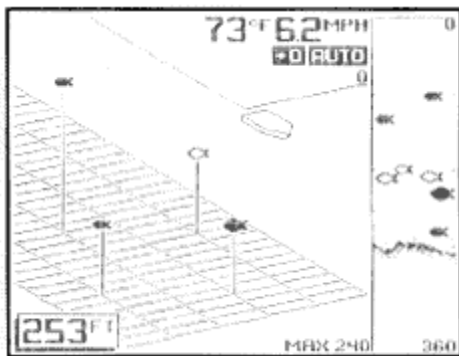

If a target is detected between the surface and the bottom and it meets the fish identification criteria, it is displayed as a fish symbol. Sonar returns that do not meet this criteria are displayed as "raw" information. Depending on the strength of the signal reflected from the target, and other factors, one of three different size fish symbols used. These reflected signals are "normalized" for depth, so that a small fish does not appear to be a large fish if it is close to the boat.

Since some species of fish tend to be better reflectors of sonar than others, the strength of return is not always an accurate indicator of fish size, however, typically, the larger the fish, the larger the signal return.

Additionally, since the Wide3D Vision uses a six element transducer, the position of the target relative to the boat is known. To help differentiate targets seen directly under the boat from those seen in the outer beams, these fish symbols are indicated differently. Targets seen in the two center beams are located directly under your boat, and are displayed as solid fish symbols. Targets seen in the outer four beams are located in the outer portion of the sonar coverage area and are displayed as hollow fish symbols. This is true for all views.

USING THE 2D VIEW

When operating in 2D view, the Wide 3D Vision operates as most normal depth sounders with several exceptions. The six beam 53 degree transducer allows you to search for fish with a much wider area of coverage than ordinary depth sounders. The hollow and solid fish symbols give you directional information, and you can quickly switch back to the 3D view for a better idea of where the target is located.

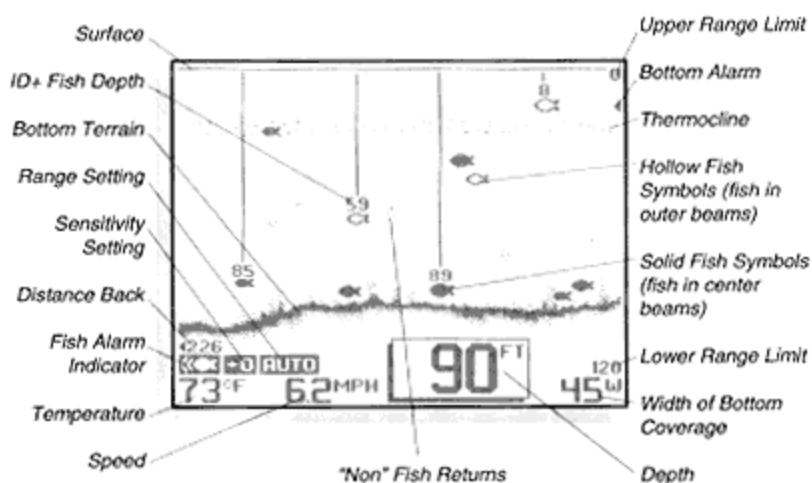

The 2D view provides more information about bottom hardness and texture using Structure ID. Only information collected from the center two beams is used to draw the bottom depiction. Terrain outside the coverage area of the center two beams will not be seen in the 2D view. Using a narrower beam provides much more detailed information as to the composition of the bottom.

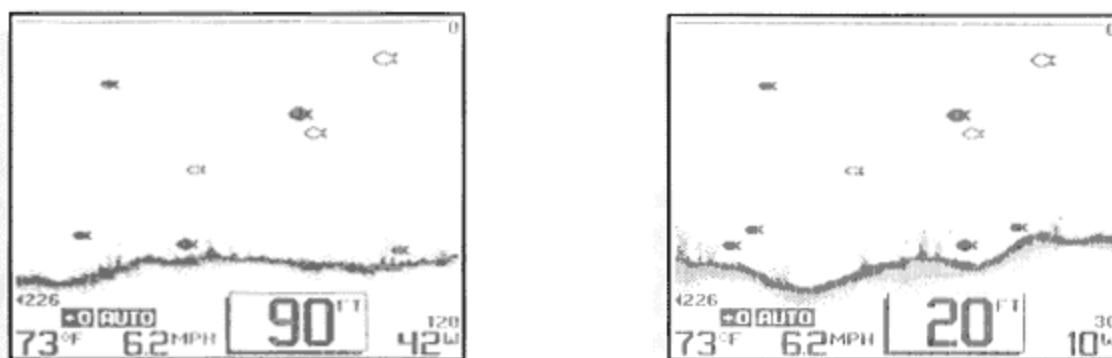

If the bottom is hard and smooth, the bottom depiction will be narrow and dense. If the bottom is mud or soft sand, the bottom depiction will be thick and less dense. This indicates that much of the solar signal is absorbed by the soft bottom. If the bottom is rugged and varying, such as a rocky bottom, the depiction will be textured and vary in density. Structure such as submerged trees or brush, or other objects are clearly displayed above the solid bottom in varying densities of pixelization. This bottom depiction is useful in locating structure, by comparing relative density as well as depth.

The transmitted sonar signal travels downward, and is reflected back toward the surface by the bottom or other objects for display on-screen.

The signal does not stop there- it is reflected downward again by the surface of the water, and a weak “second return” is usually visible if the depth range is sufficient to see it. The second return may be used as an indicator for setting the sensitivity bias.

USING THE COMBO VIEW

The Combo view combines a 3D view with a 2D view on the same screen. This is an ideal view for 2D users learning to interpret 3D information. Also, you can view a wide area of coverage on the 3D portion of the screen, but retain the bottom detail of the 2D view.

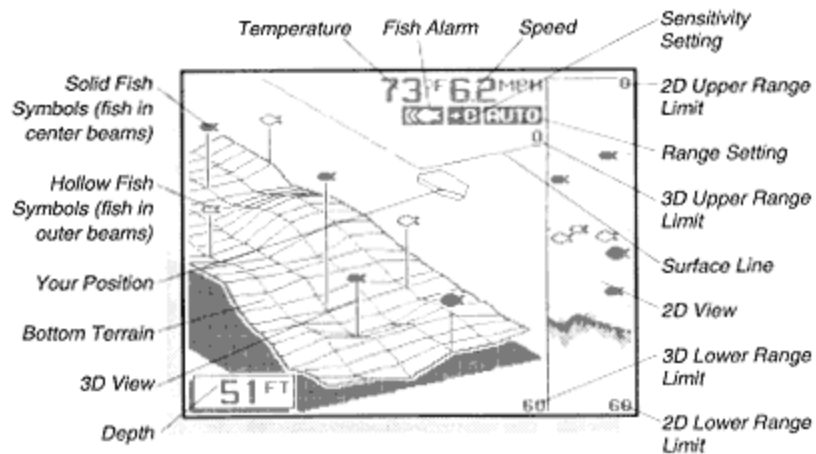

CONTROL FUNCTIONS

The Wide 3D Vision unit uses only eight buttons to control all functions. The controls are divided into two groups: POWER, STOP, VIEW, and LIGHT are one group., and the Menu System controls are the other group. When any button is pressed, an audible “chirp” will verify the control input.

POWER, as previously discussed, powers the Wide 3D Vision for normal operation. Also if the unit is powered off, press and hold POWER until you hear a continuous “chirp” to enable simulator operation as discussed in “Simulator Operation”. Pressing POWER when the unit is in normal or simulator operation will power the unit off.

STOP freezes the display to allow closer study. Pressing STOP again will resume normal operation. Also, if a menu is on-screen, STOP will retain the menu on-screen until STOP is pressed again. The digital bottom depth will continue to update, as usual, even if the display is stopped.

VIEW toggles between the three main views; 3D view, 2D VIEW, AND Combo view when using the standard transducer. If you are using the optional Wide Side transducer, VIEW toggles between the left, right, both, and down views.

LIGHT enables a two-level display backlight and backlit keypad. Pressing once will turn the light on low, pressing a second time will increase the backlight to the high setting, and pressing a third time will turn the backlight off.

The four remaining buttons work together to control the Menu System - an array of menu controlled functions.



MENU brings a menu on-screen for adjustment, or if a menu is already present, the next menu in sequence will appear. Menus will go off-screen and normal operation will resume after a short period of time. If you wish to keep the menu on-screen for an extended period of time, press STOP.

UP arrow selects the next larger or next sequential adjustment within the menu. Holding an Arrow button down will cause the unit to continue to make the adjustment, until a limit is reached, and the limit alarm sounds.

DOWN arrow selects the next smaller adjustment within the menu.

ENTER is used to toggle other menu options on and off.

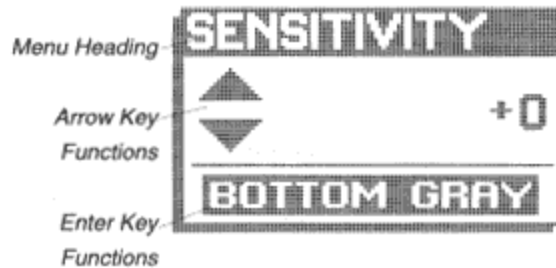

All menus use the same general layout as shown in the sample menu. The heading of the menu is at the top. The area in the center is controlled by the UP and DOWN arrows, and the area under the horizontal line is controlled by the ENTER button. Not all menus are affected by all controls, but the layout is the same regardless. Pressing MENU repeatedly will sequentially display all available menus.

MENU FUNCTIONS

The following section explains each menu in detail, and how these adjustments can be used to extract the maximum information from the sonar returns. With several exceptions, once a setting has been changed, the Wide 3D Vision will remember that setting until it is again changed, even if power is disconnected.

SENSITIVITY

As the Wide 3D Vision receives returned signals, the sensitivity of the receiver is adjusted automatically based on a number of factors such as the depth of the water, and the signal clarity. In murky water, full of debris, the Wide 3D Vision will select a lower sensitivity setting. In clear water, where there is little debris to deflect the sonar signal, the sensitivity is set higher.

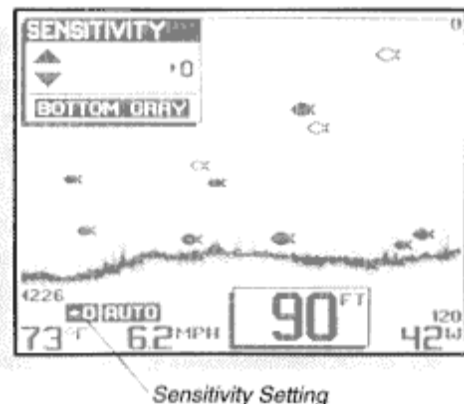

The sensitivity menu allows you to "bias" this automatic setting up or down based on personal preference.

You can select a bias of +5 to -5, for 11 different bias settings. A bias setting of "0" has no effect on the automatic function. A +3 setting selects a sensitivity setting three steps higher than the unit would normally select, so even the smallest returns are displayed on-screen.

A setting of -2 sets the sensitivity two steps below what the unit would normally select, so only the largest targets of other returns are displayed.

Another use of the Sensitivity menu is to select the bottom representation. In the 2D view the Wide 3D Vision normally displays a variable Structure ID bottom, which can allow experienced users to determine the texture or relative hardness of the bottom. For simplicity, you can select a black bottom using the ENTER button. This blackens in the display below the bottom for easiest recognition of the bottom location, even from a great distance.

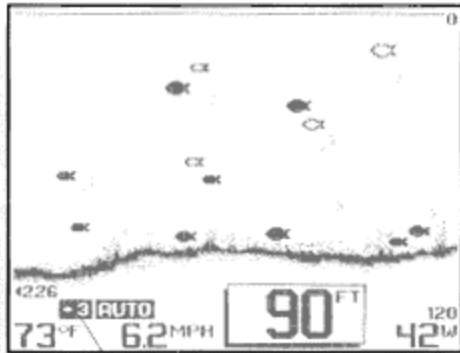

Sensitivity Bias of +3

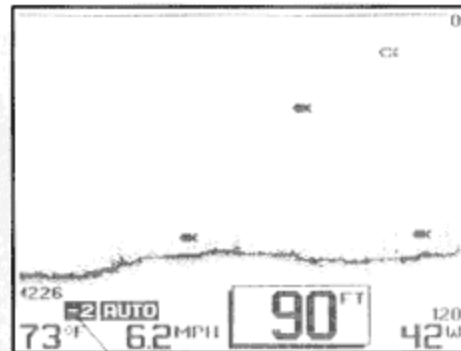

Sensitivity Bias of -2

RANGE

The Wide 3D Vision adjusts the depth range automatically, so the bottom return is displayed at the bottom 1/3 of the display. This leaves the top 2/3 to display anything between the surface and the bottom. As your boat moves over deeper or shallower water, the unit adjusts the depth range of the display to keep the bottom return in the same general area on the screen.

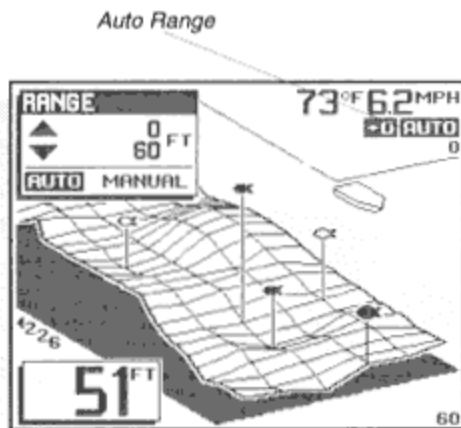

However, you may choose to control this range adjustment manually. By pressing ENTER, you can select manual operation, meaning the unit will no longer adjust the depth range automatically. The depth range selected is controlled by the UP and DOWN arrow buttons. 3D depth ranges of 0-15 feet, 30 feet, 60 feet, 120 feet, 180 feet, & 240 feet can be selected. In the 2D view depth ranges will be extended and include 360 feet, 480 feet, 600 feet, & 1000 feet. An on-screen icon indicates whether the unit is in "AUTO" (automatic) or MNL (manual) range control.

If you alter the depth range, the unit will switch to manual operation. This feature is valuable if you are only interested in targets near the surface. The Wide 3D Vision will always display the digital depth of the water in the manual mode. If the bottom is not visible in the depth range selected, a 3D grid will be shown for reference.

The 3D grid is shown for referencing fish location and does not show bottom terrain information.

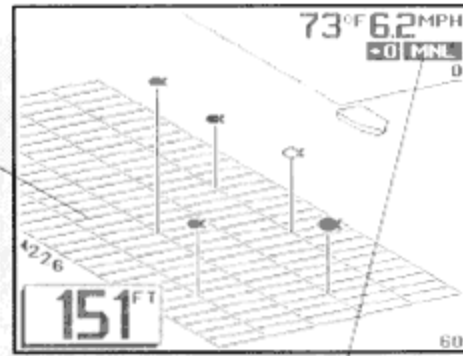

Manual Range

ZOOM

Another form of range control is Zoom. Zoom allows selection of various ranges for full screen viewing, while maintaining a view of the full range. By using the display to view a smaller area, the effective display resolution is increased, and the unit's ability to separate targets close together is enhanced.

The zoom range is determined by the depth range in use when Zoom is enabled. In shallow water, when the 15 foot or 30 foot depth range is used, the zoom range will be 7 ½ feet. If the 60 foot or 120 foot depth range is in use, the zoom range will be 15 feet. And if the 180 foot or 240 foot depth range is in use the zoom range will be 30 feet. For depths greater than 240 feet the display will only update a 2D view. If the depth range is 480 feet the zoom range will be 30 feet and if the depth range is 600 feet or 1000 feet the zoom range will be 60 feet.

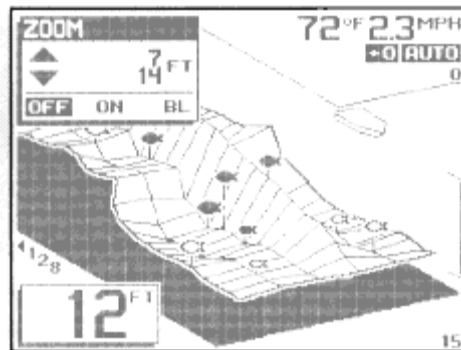

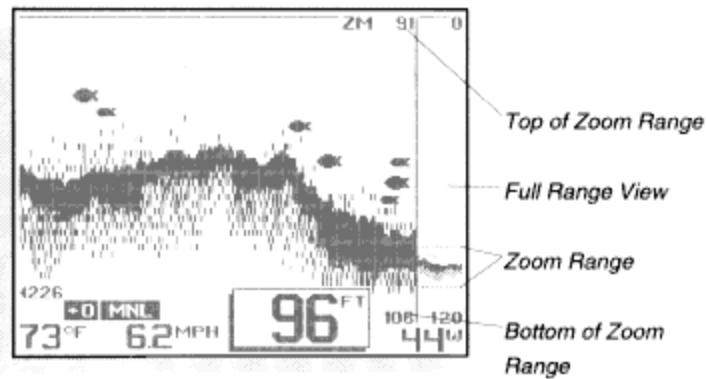
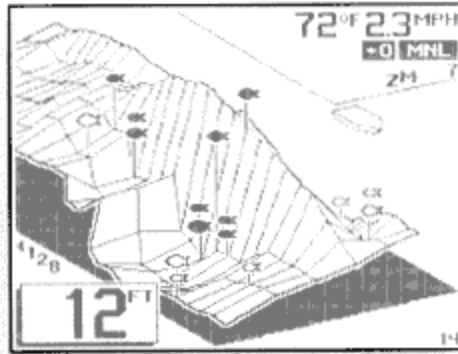

To enable Zoom, adjust the horizontal lines to the depth of the zoom range using the UP and DOWN arrow buttons, then enable Zoom using the ENTER button.

Pressing the VIEW button while in zoom will toggle your display from three zoom views; 3D, 2D, and a combo view. When you are in zoom in the 2D view, refer to the preview area and adjust the depth of the zoom range by using the UP and DOWN arrow buttons. The combo view also allows you to preview a 2D view, but displays a zoomed 3D view. The Zoom menu will not appear when an adjustment is made unless MENU is pressed. The digital depth readout will continue to track the bottom even when Zoom is enabled.

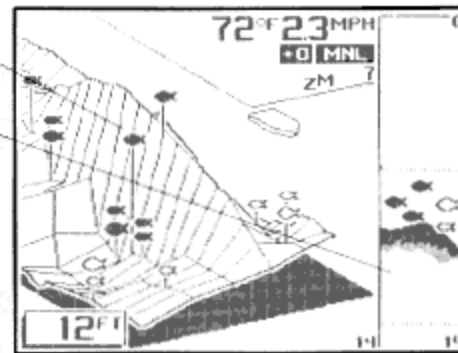

Bottom Lock is a function of zoom, except the depth adjustment is controlled automatically to view the area immediately above the bottom. This is especially useful if you are looking for structure or minor variations in terrain in areas of relatively flat bottom terrain. To enable Bottom Lock, press ENTER until the "BL" is highlighted. The zoom range will be controlled by the current depth range, as in Zoom, and will be indicated on the Zoom menu.

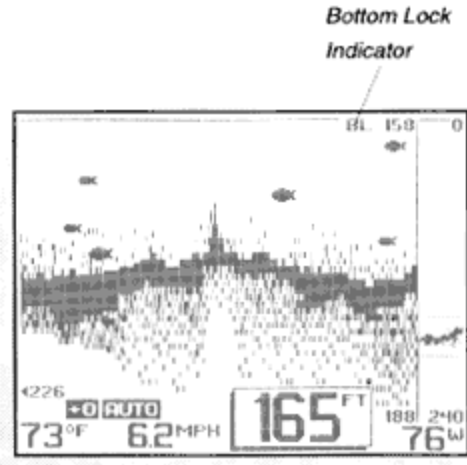

BOTTOM ALARM

The Wide 3D Vision contains an audible alarm to warn you of shallow water depths. This alarm is adjustable from 2' to 99' of depth. To enable the alarm, simply adjust the alarm depth using the UP and DOWN arrow buttons, and press ENTER. When the depth of the water beneath your boat is equal to or less than the selected alarm depth, a continuous alarm will sound.

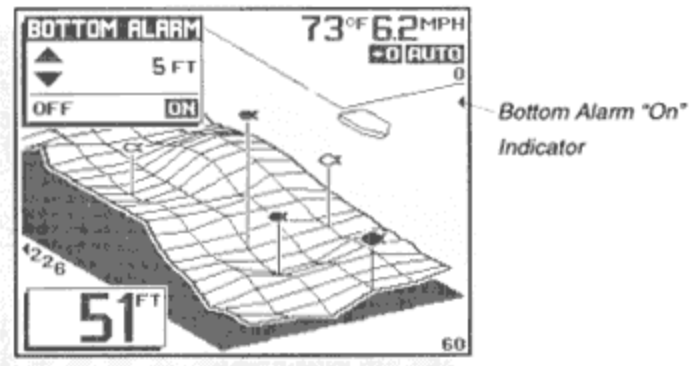

To disable the alarm, either move to deeper water, or select the Bottom Alarm menu, and press ENTER to turn the alarm off.

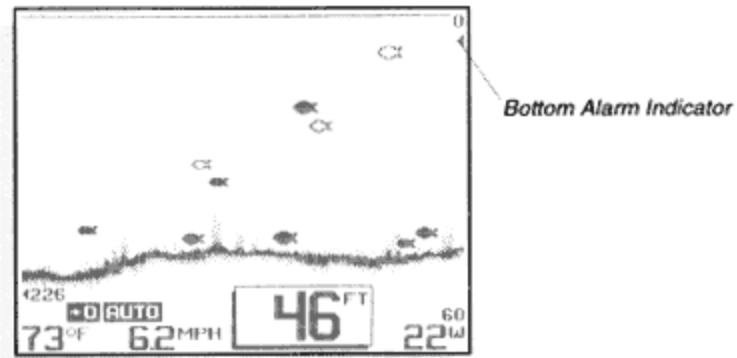

The Fish Alarm alerts you to the presence of fish, or other targets not attached to the bottom, in the water beneath your boat. The Fish Alarm has 3 different settings which correspond to the 3 different size fish targets shown on-screen.

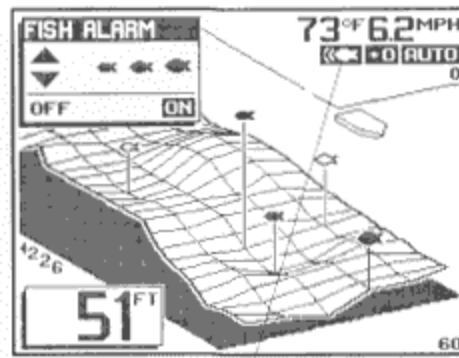

Fish Alarm "On" Indicator

To enable Fish Alarm, use the UP and DOWN arrow buttons to adjust the size return you want to be alerted to: large fish only, large and medium size fish, or all fish. Then press ENTER to enable the alarm.

Remember that it is impossible for Fish Alarm sonar to determine if a signal return is a fish or some other type of object or suspended debris. Any object not connected to the bottom is normally a fish and is portrayed as a fish symbol. The strength of the reflected sonar signal from a target is a good indicator of the size of the target, and the fish symbol displayed represents the strength of the signal reflected from it.

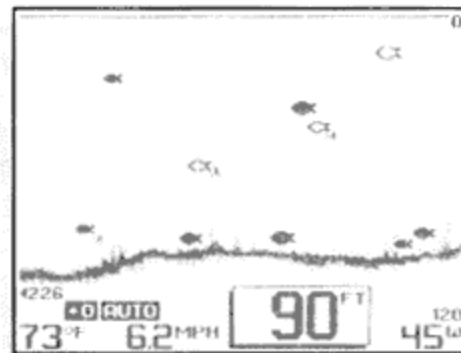
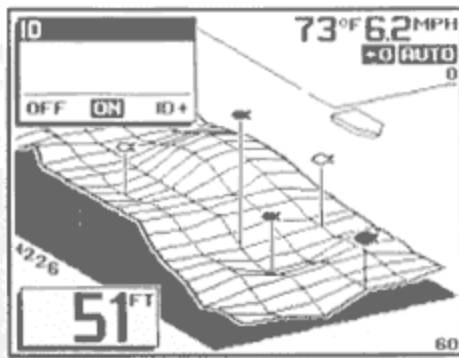

ID is the automatic identification of target returns based on the strength of the returned signal and other factors. Three options are available: ID "On" displays targets as one of three different size fish symbols.

The fish symbols may be hollow, indicating that the target is detected in the wide beam only, or solid, indicating that the target is detected in the narrow beam, and is located directly under the boat.

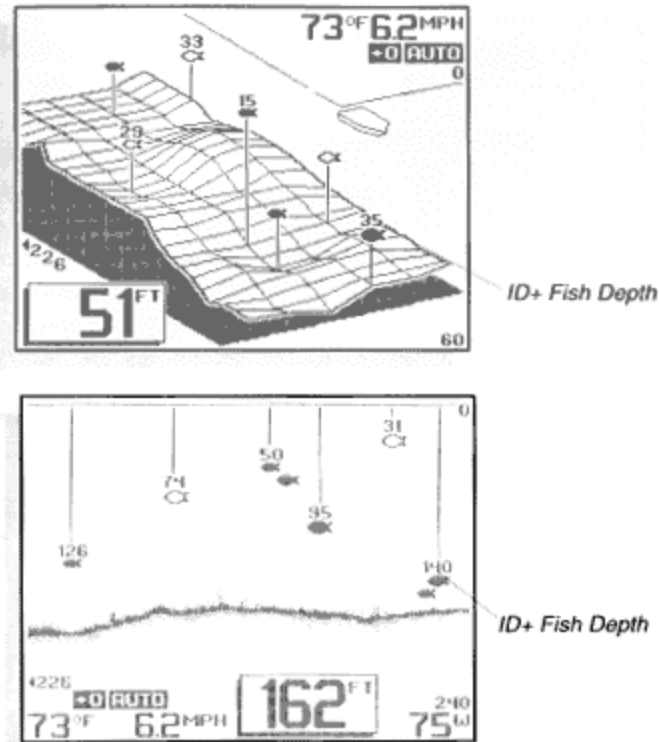

"ID+", the default setting, provides more information about the location of the target by attaching depth "strings" showing the digital depth of the target. When there are numerous targets on-screen, not every target depth is shown, to avoid excessive clutter on-screen.

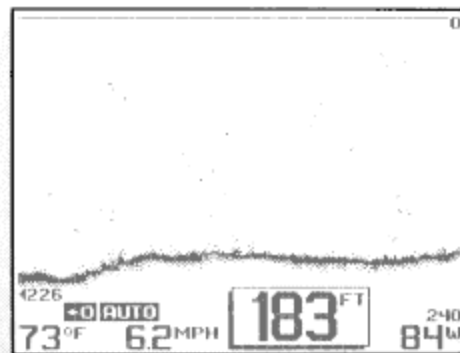

ID "Off" disables the units interpretation of targets, and displays the "raw" sonar information as it is received. Advanced users may prefer this type of presentation, so they can make their own interpretation from the information displayed.

TRIPLOG

TripLog provides a time/distance calculation, based on input from the speed accessory. The timer is started when the unit is first powered, and distance information is collected to provide elapsed distance since power up, and the average speed. To enable the TripLog display, press ENTER. Viewing Triplog while in a 2D view allows current sonar information to be displayed.

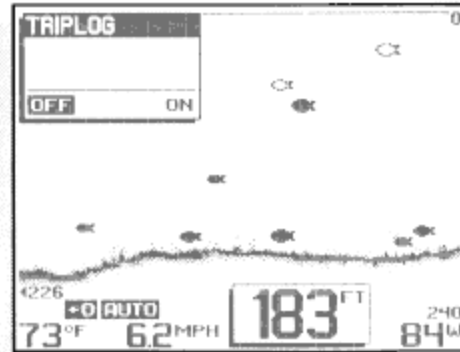

The TripLog can be reset at any time by pressing STOP. Press ENTER to return to the normal screen.

Note: The Speed & Temperature accessory must be connected for TripLog to work.

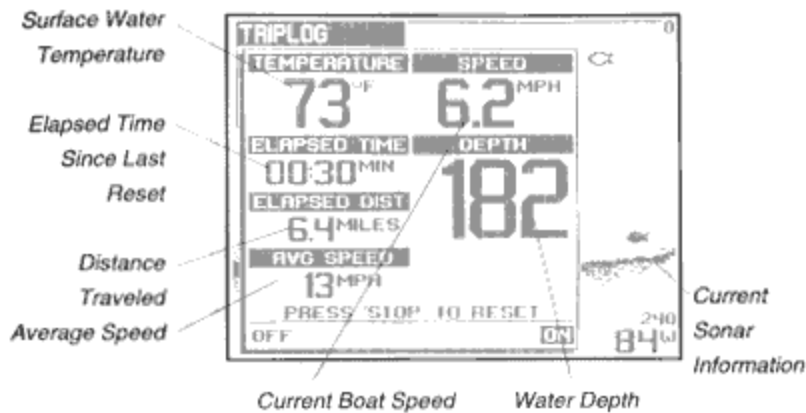

SYSTEM OPTIONS

The System Options menu allows the adjustment of several additional features. These adjustments are usually made initially, and rarely thereafter. To make these adjustments, first enter the System Options full screen menu with the ENTER button. Then press MENU to choose the category for adjustment, the UP and DOWN arrow buttons to adjust the setting, and the ENTER button to return to the normal screen when you have finished.

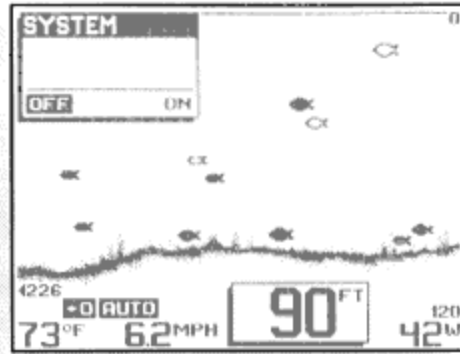

Scroll Rate controls the rate of update of the display. There are five rate settings available. The default setting is rate 4 - you may speed up or slow down the update rate to match your personal preference. To present the most accurate representation of the terrain beneath your boat, the scroll rate of the display should be approximately synchronized to the speed of the boat. If your boat is stationary or moving slowly, select a slower scroll rate, and if you typically operate the boat at high speeds, use a faster scroll rate.

Contrast adjusts the display screen for easier viewing under given light conditions. There are 9 contrast settings available.

Sonar mode controls three different modes of operation. The default position is "down", where the Wide 3D Vision uses the six-beam down-looking transducer to produce the three primary views discussed earlier. Selecting "side" will configure the unit to work with the Wide Side, side-looking transducer which will be discussed in the "Wide Side Operation" section. The third option is "diagnostic" which is used to evaluate the performance of your installation, or to help find a suitable inside the hull mounting point for the transducer. Diagnostic is discussed in detail in the "Advanced Feature" section.



User Level is used to select Normal or Advanced operation. Advanced mode performs several functions which will benefit the experienced user. Icons are not shown and numerical data is smaller to allow more of the display to be used for the picture of the bottom. Several other changes in operation occur which are designed to increase the speed of adjustments, and maximize the graphic use of the display. Refer to "Advanced Operation" for more detailed information.

Perspective selects the point of view for the 3D view. Right perspective is the default setting, and the viewpoint is from the right side of the boat. Left perspective changes the point of view to the opposite side of the boat. Perspective can be changed to view terrain normally hidden from a

particular viewpoint, or just for personal preference. This setting is remembered even after the unit is turned off.

Units-Speed allows a selection between displaying speed in MPH or KTS. MPH displays your boat's speed in statute miles per hour and KTS displays your boat's speed in knots or nautical miles per hour.

Note: Boat speed and water temperature features require the use of the temp/speed accessory.

ADVANCED OPERATION

The Wide 3D Vision contains the unique ability to be adaptable in operation to match the experience level of the user. Users inexperienced in the operation of the Wide 3D Vision should use the factory "Normal" setting. As your experience increases, you will benefit from many of the changes that occur when "Advanced" operating mode is selected. The selection is made in the System Menu and affects the following:

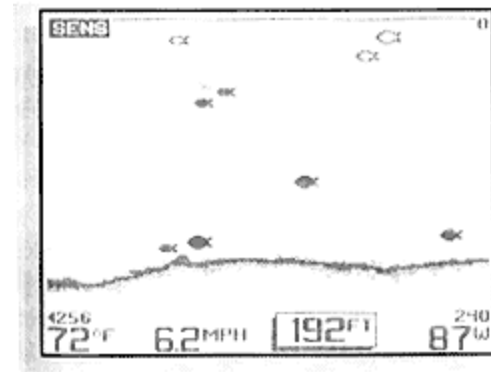
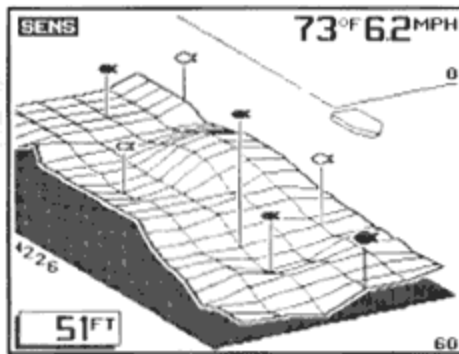

The base screen layout is modified to maximize the display for terrain and target presentation. To accomplish this, symbols such as Sensitivity setting, and Fish Alarm indicators, are removed. When a menu adjustment is made, the menu goes off-screen in approximately half the normal time. Menus are abbreviated and after an adjustment is made only a small indicator remains at the top of the screen so that you can make quick adjustments. This lets the experienced user make adjustments, then quickly return to full-screen viewing.

These changes are designed to make the maximum use of the available screen resolution, and speed up operations that restrict the view of the bottom.

DIAGNOSTIC

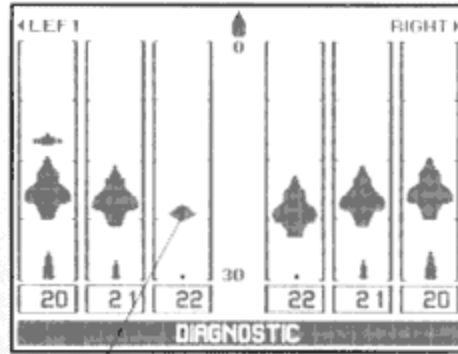

*Weak Beam
Return*

"Diagnostic" is selected with the sonar mode option of the System menu. It is a special screen that displays the raw sonar information being received by each of the six sonar beams. Viewing the information in this manner is helpful when selecting a mounting location for the transducer, or when troubleshooting potential problems.

If you are selecting a location inside the hull of your boat to mount the Wide 3D Vision transducer, the diagnostic view lets you compare the individual beam returns while you position the transducer.

Your boat should be in the water over a flat, level area of bottom. If there are no obstructions or inconsistencies in the hull at the mounting location, all six beams should be very similar in appearance. The top of the screen is the surface of the water, and the signal reflected from the bottom is displayed at the appropriate depth. A weak or irregular signal will be easy to spot, and moving the transducer slightly may correct the problem.

The Wide 3D Vision transducer is very sensitive to hull irregularities, and care should be taken to find a location that gives identical returns from each of the six beams.

WIDE SIDE OPERATION

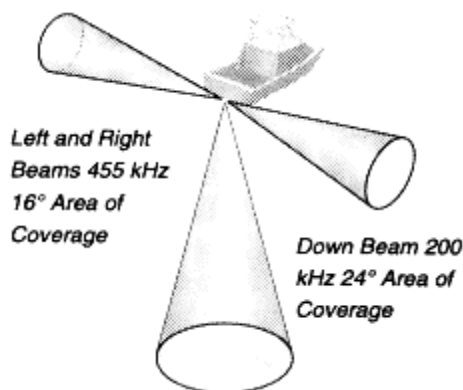

Wide Side is an accessory transducer that gives your Wide 3D Vision the capability of collecting sonar information from either side of your boat. Side-looking sonar is extremely valuable for bank fishing, or looking for bait fish in open water.

The Wide Side transducer contains 3 different elements which transmit signals to the left, right, and straight down from your boat. The downward beam is 200 kHz with a 24 degree area of coverage. This beam maintains a continuous digital depth readout from the bottom directly beneath your boat. The side beams are 455 kHz with a 16 degree area of

coverage. These side-looking elements can be used independently, or together to locate targets near the surface of the water on either side of your boat.

The Wide Side transducer is available as a trolling motor mount, a transom mount, or a portable mount.

Wide Side can be connected directly to your Wide 3D Vision unit in place of the standard transducers, or used in conjunction with a transducer switch so that all of the transducers can be connected to the Wide 3D Vision. See "Installing the Wide 3D Vision" for additional information.

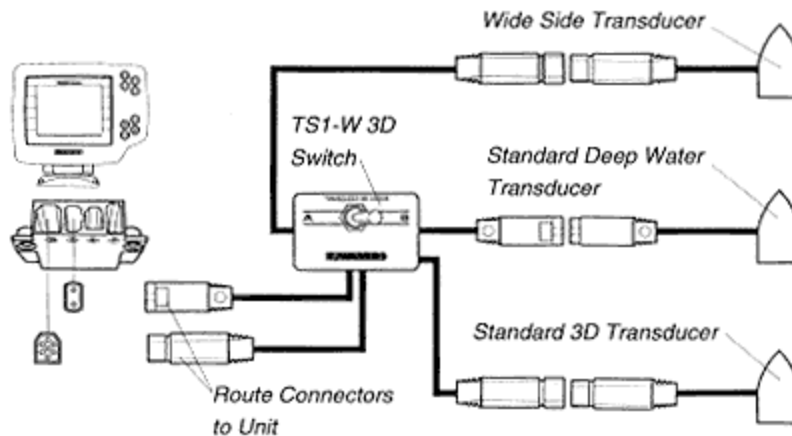
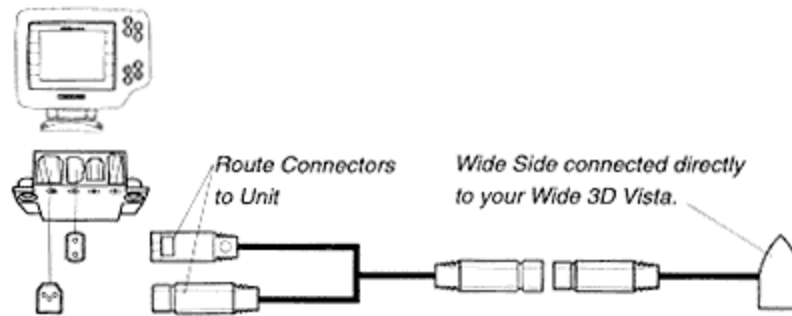

When the Wide Side transducer is connected directly to your unit, or selected using a transducer switch, the unit setup must be changed to correspond with the type of transducer being used. This adjustment is made through the "System Options" menu. Use the MENU button to select the "System Options" menu and press ENTER. Press MENU until the "sonar mode" option is highlighted. Press UP or DOWN until "side" is displayed. Press ENTER when the selection is correct.

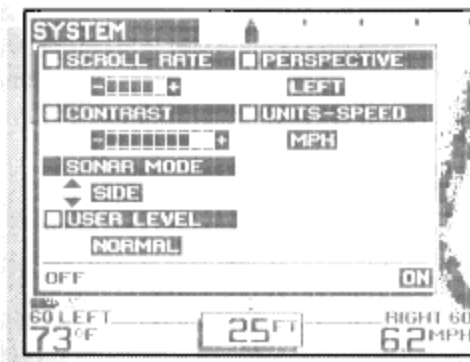

Your Wide 3D Vision is now configured for Wide Side operation.

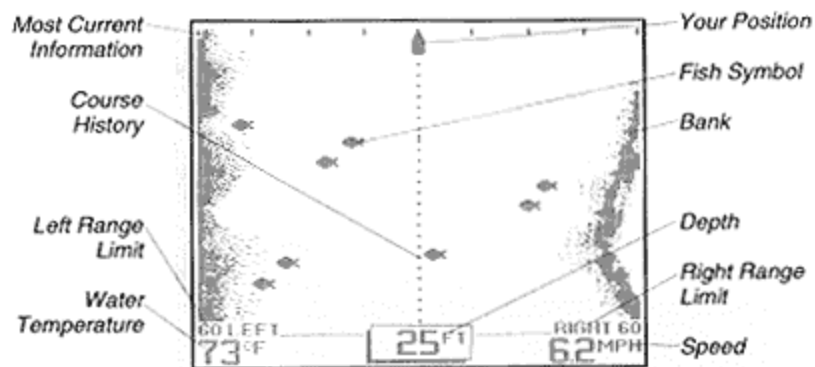

When you exit the "System Options" menu, the view you will see on-screen is shown above. Viewing both left and right sides simultaneously gives you an excellent tool when searching for bait fish or following a creek bed, however greater display resolution can be achieved by viewing only one side.

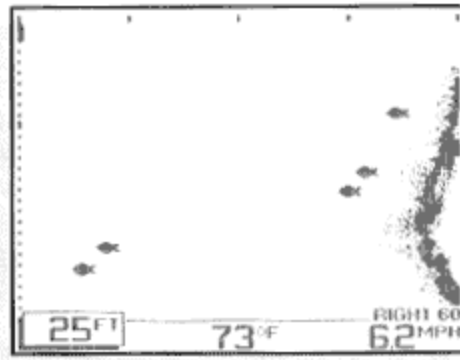

Experiment with the Wide Side transducer while operating it in a familiar area and learn how to make maximum use of the information displayed. Remember, if you are using a trolling motor mount, the information displayed is controlled by the direction the trolling motor is pointing, not necessarily the direction the boat is travelling.

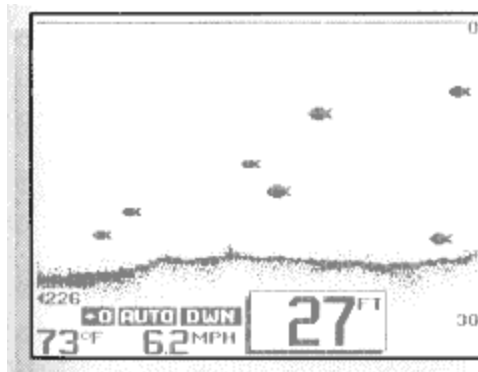

The information collected is controlled by pressing the VIEW button. Pressing VIEW toggles the options "both", "right", "left", or "dwn" (down). When the "dwn" mode is selected, the single 24 degree down-looking element of the Wide Side transducer is used to collect this information. This transducer does not have "wide", "narrow", or "dual" beam options and hollow fish symbols cannot be displayed.

The "Range" menu (below) in Wide Side must be used to control the range manually, as the bottom is not always visible on-screen. Ranges of 15, 30, 60, and 120 feet are available.

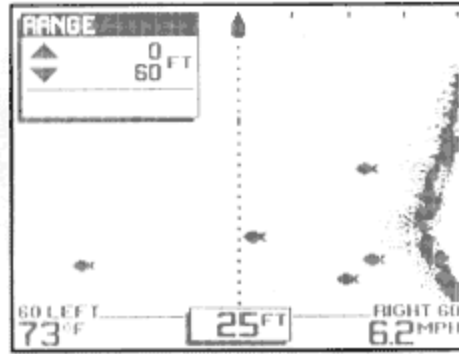

"Zoom" has no function in Wide Side mode and the menu will not be present.

ID menu functions are slightly different in "wide side" and "down" modes. In the "wide side" mode ID+ is not an option, and all fish are displayed as medium, sized fish symbols. In the "down" mode ID+ is available, and fish are displayed in three sizes.

Most other menu functions work the same in Wide Side mode as with the standard dual beam transducer. "Bottom Alarm", "Fish Alarm", and "Sensitivity" have the same effect. "Triplog" is available, if the speed and temperature accessory is connected.

To return to the normal "down" operation using the standard 3D transducer, you must reconnect the 3D transducer (by replacing the Wide Side connectors) or use the switch to select the 3D transducer. Next, configure the unit by selecting the "down" mode under the "System Options" menu.

Note: The "sonar mode" must always be configured to match the type of transducer being used.

Free Manuals Download Website

<http://myh66.com>

<http://usermanuals.us>

<http://www.somanuals.com>

<http://www.4manuals.cc>

<http://www.manual-lib.com>

<http://www.404manual.com>

<http://www.luxmanual.com>

<http://aubethermostatmanual.com>

Golf course search by state

<http://golfingnear.com>

Email search by domain

<http://emailbydomain.com>

Auto manuals search

<http://auto.somanuals.com>

TV manuals search

<http://tv.somanuals.com>