

WIDE *Portrait*

Operations Manual



fish wide open!

INSTALLATION PREPARATION

PARTS SUPPLIED

PARTS SUPPLIED

Before installing your new Humminbird fishfinder, please ensure the following parts are included in the box:

- Fishfinder
- Transducer with 20' (6m) of cable and mounting hardware kit
- Mounting system and mounting hardware kit
- 6' (2m) power cable
- Publications kit

If any of these items is missing, call our Customer Support Hotline.

ACCESSORIES

Humminbird offers a wide assortment of accessories that complement and expand the capability of your new fishfinder. These accessories are designed with the same high standards and are backed by the same one-year warranty. The Humminbird Accessory catalog included with your unit contains descriptions of the many accessories available and ordering information. All Humminbird accessories are available through your full-service Humminbird dealer or factory direct through our number listed in the Customer Support section.

INSTALLATION OVERVIEW

Your Humminbird fishfinder consists of two primary components to install: the control head and the transducer.

The control head contains the sonar transmit and receive circuitry, as well as the user controls and display. It should be installed in a location that provides access to the controls and visibility while in use. The control head mounts on a quick disconnect mounting system that swivels and tilts providing flexibility for viewing from almost anywhere on the boat.

The transducer converts electrical energy from the transmitter into mechanical pulses or sound waves. The transducer also receives the reflected sound waves and converts them back into electrical signals for display on the control head. It should be installed in contact with the surface of the water in an area that has smooth waterflow- usually on the transom of the boat. There are several mounting options for the transducer. Review the following section to determine the method that works for you and your boat.

INSTALLATION PREPARATION

INSTALLATION OVERVIEW

Determining How to Mount the Transducer

Your Humminbird fishfinder includes a standard transducer. This transducer can be mounted on the transom of the boat or bonded to the inside of a fiberglass hull boat.

The transom installation, which is the most widely used, places the transducer on the outside of the boat hull. This technique produces the least signal loss, and provides a way to adjust the transducer after installation. The mounting hardware included is designed to protect both the boat and the transducer should the boat strike debris in the water or when trailering.

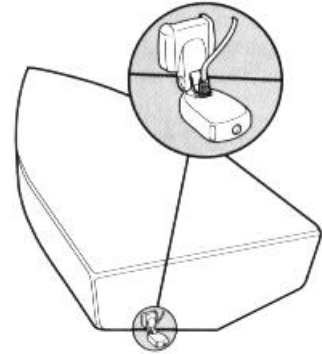

Transom Mounted Transducer

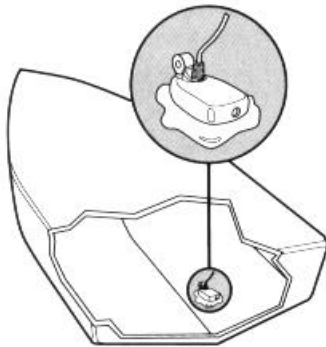

Inside the Hull Mounted Transducer

As an alternative to transom mounting, it is possible on many fiberglass-hulled boats to glue the transducer on the inside of the boat hull. Since fiberglass has similar sonar characteristics as water, the sonar signal can pass through the boat hull with minimal loss. The hull of the boat must be single layer construction (not double-hulled) Also, any air trapped in the lamination of the fiberglass would prevent the sonar signal from passing through.

Inside the hull installations require no holes be drilled into the boat and through experimentation, high-speed operation comparable to transom mounting can be achieved. Two-part slow cure epoxy (not included) is required to glue the transducer in place.

INSTALLATION PREPARATION

ALTERNATE MOUNTING METHODS

ALTERNATE TRANSDUCERS AND MOUNTING METHODS

Your Humminbird fishfinder comes with everything necessary for installation and operation on most boats. However, there are several situations which may require a different type of transducer. Inboard boats, wood or metal hulls, and sail boats create unique transducer mounting needs. Alternate transducers and mounting methods are detailed below.

Portable Mounting

The standard transducer can be adapted for portable installations with a portable mounting kit available from Humminbird. This accessory adapts your transducer to a suction cup mount for temporary installation on the boat hull or other surface.

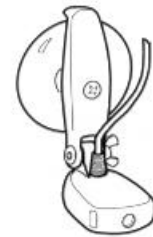

Trolling Motor Mounting

The standard transducer can also be adapted to mount on most trolling motors using a different accessory kit. This accessory includes a bracket and hose clamp that allows mounting the transducer to the body of most trolling motors.



Thru-Hull Mounting

Thru-hull transducers install through a hole drilled in the hull of the boat. Larger boats or boats with inboard motors create turbulence that make transom mounting ineffective. Also, hulls that are very thick or are double layered, or made from materials such as wood or metal, (which do not conduct sonar signals) make inside the hull mounting inadvisable.

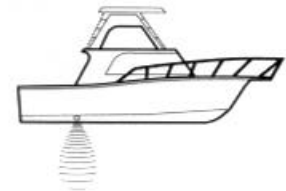

Thru-hull mounting may require the use of a fairing block to level the transducer with the waterline. Also, since special tools and knowledge may be required to perform this type of installation, it is best to refer to a qualified marine technician.

INSTALLATION PREPARATION

TRANSDUCER EXCHANGE

TRANSDUCER EXCHANGE

Other transducers are available as replacements for the standard transducer. You may exchange your new and unassembled transducer for another type by returning it to the address listed in Customer Support. Some transducers may have additional cost. Refer to the Accessory catalog or call Customer Support for information.

BEGINNING INSTALLATION

Now that you have determined the transducer mounting method you can begin installation of your new Humminbird fishfinder. The installation guide included on the next few pages provides detailed step-by-step instructions for installation of the control head and transducer. For transom mount transducer installations you will need the mounting template included with your manual.

In addition to the parts included you need the following for installation and operation:

- A powered hand drill and various drill bits
- Philips and flat-head screwdrivers
- A ruler or measuring tape
- Pen or pencil
- 12 volt power source (your boat's battery)
- A 1-amp fuse
- A fuse holder (if you are wiring directly to the boat's battery)
- Silicone sealant (for sealing drilled holes)
- 2-part, slow-cure epoxy (for inside the hull transducer installations)

INSTALLATION

TRANSOM INSTALLATION

Do not begin this transducer installation until you read the Installation Preparation in the Operation Guide. This chapter contains information critical to the correct installation of your transducer.

Due to the wide variety of boat hulls, only general instructions are presented in the installation guide. Each boat hull represents a unique set of requirements that should be evaluated prior to installation.

TRANSOM INSTALLATION

Step One - Determine Where to Mount the Transducer

Begin the transducer installation by determining where on the transom to install the transducer. Consider the following to find the best location:

- It is very important to locate the transducer in an area which is relatively free of turbulent water. As a boat moves through the water, turbulence is generated by the weight of the boat, and the thrust of the propeller(s). This turbulent water is normally confined to areas immediately aft of ribs, strakes or rows of rivets on the bottom of the boat, and in the immediate area of the propeller(s) (Figure 1). On outboard or inboard/outboard boats it is best to stay at least 15" (40cm) to the side of the propeller(s).
- If possible, viewing the transom of the boat while the boat is moving will provide the best means of locating turbulence free water. If maximum high-speed operation is a high priority, this is the recommended method. If this is not possible, select a location on the transom where the hull forward of this location is smooth, flat, and free of protrusions or ribs.
- The transducer when mounted should point straight down. The design of the transducer will accommodate a wide range of deadrises and remain ported straight down (Figure 2).
- On boats with stepped hulls, it may be possible to mount the transducer on the step. Never mount the transducer on the transom behind a step, as this area of the transom will not be in contact with the water at high speed (Figure 3).

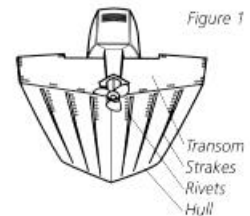

Transom Mounting Location

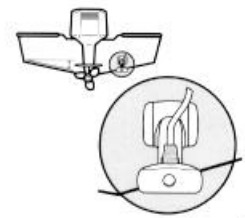

Figure 2

Stepped Hull

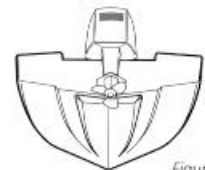

Figure 3

INSTALLATION

TRANSOM INSTALLATION

- If the propeller(s) is (are) forward of the transom, it may be impossible to find an area clear from turbulence, and a different mounting technique or transducer type should be considered.

Step Two - Drill the Mounting Holes

1. Remove the mounting template from the front of the Operations Manual.
2. Hold the template on the transom of the boat in the location where the transducer will be installed (Figure 4). Align the template vertically, ensuring the lower edge of the transom meets with the bottom corner of the template.
3. Using a pencil or punch, mark the two mounting holes shown on the template onto the transom. Do not mark or drill any other holes at this time.
4. Using a 5/32" (4mm) bit drill the two holes to a depth of approximately 1" (3cm). On fiberglass hulls, it is best to start with a smaller bit and use progressively larger drill bits to reduce the chance of chipping or flaking the outer coating.

Template alignment

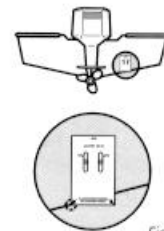

Figure 4

Transducer Assembly

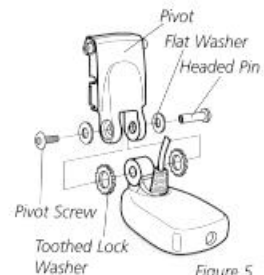

Figure 5

Step Three - Assemble the Transducer

1. Attach the Pivot to the transducer body as shown in Figure 5, using the #8 – 3/8" (9mm) long allen headed pivot screw, the headed pin, the two flat washers, and the two toothed lock washers.

Note: The toothed lock washers must be positioned between the transducer and the pivot ears. The flat washers must be positioned to the outside at the pivot ears.

2. Using the Allen wrenches provided, loosely tighten the pivot screw (Figure 6). Do not completely tighten the assembly at this time, so the pivot angle can be adjusted later.
3. Insert the pivot/transducer assembly into the mounting bracket as shown in Figure 7. Do not snap the assembly closed.



Figure 6

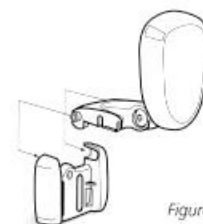

Figure 7

INSTALLATION

TRANSOM INSTALLATION

Step Four - Mount the Transducer to the Transom

1. Apply silicone sealant to the mounting holes drilled into the transom.
2. Align the transducer assembly with the drilled holes in the transom (Figure 8).
3. Use either a flat head screwdriver, a 5/16" (8mm) hex driver, or a 5/16" (8mm) socket to mount the assembly. Using the two #10 – 1" (25mm) long slotted hex head screws, mount the transducer assembly to the transom as shown. Do not fully tighten the mounting screws in order to vertically adjust the transducer. Snap the pivot down into place.

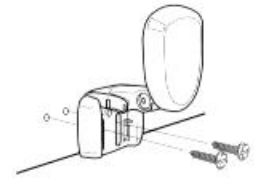

Figure 8

Step Five - Adjust the Running Position of the Transducer

The bracket allows height and tilt adjustment, the pivot screws allow angular adjustment. Initially, adjust the transducer as described in the following paragraphs. Further adjustment may be necessary to refine the installation after high speed testing.

1. First adjust the pivot angle of the transducer body so its length is parallel with the length of hull of the boat. Then pivot the transducer down so the rear is about 1/4 inch (6mm) lower than the front (Figure 9).
2. Fully tighten the two pivot screws using the Allen wrenches. It may be necessary to retighten the pivot screws after the initial use as the plastics may still be seating to the lock washers.
3. Adjust the height of the assembly so the face of the transducer is 3/16" (4.5mm) beneath the lower edge of the transom (Figure 10). Mark the position of the mounting bracket on the transom with a pencil.
4. Force the pivot to the up position to gain access to the mounting screws. Assure the transducer location has not changed, then fully tighten the two mounting screws (Figure 11). Snap the pivot back down.

Running Position Adjustment



Figure 9

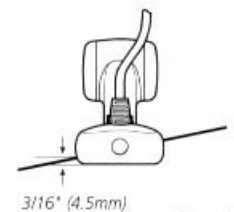

Figure 10

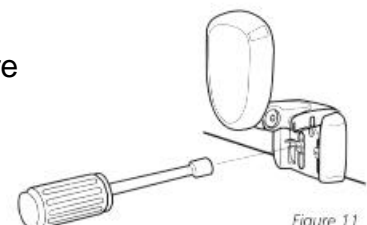

Figure 11

Confirm the pivot angle has not changed.

Note: A third screw location is provided for the

mounting bracket. Drill this hole and install the screw after final testing and adjustments have been completed.

INSTALLATION

TRANSOM INSTALLATION

Step Six - Route the Cable

There are several ways to route the transducer cable to the area where the control head will be installed. The most common procedure routes the cable through the transom into the boat.

Inside the boat there is often a channel or conduit used for other wiring that the cable can be routed along. Do not cut or shorten the transducer cable and try not to damage the cable insulation. Route the cable as far as practical from the VHF radio antenna cables or tachometer cable to reduce the possibility of interference.

If the cable is too short, extension cables are available to extend the transducer cable up to a total of 50' (15 m). Call Humminbird Customer Support for more information.

Follow these steps to route the cable through the transom:

1. Drill a 5/8" (16mm) hole above the water line. Route the cable through the hole.
2. Fill the hole with silicone sealant.
3. Place the escutcheon plate over the hole and attach with the two #8 x 5/8" (16mm) screws.
4. Secure the cable by attaching the cable camp to the transom using a #8 x 5/8" (16mm) screw.

Note: The transducer will pivot up to 90 degrees in the bracket. Allow enough slack in the cable for this movement. It is best to route the cable to the side of the transducer so the cable will not be damaged by the transducer during movement.

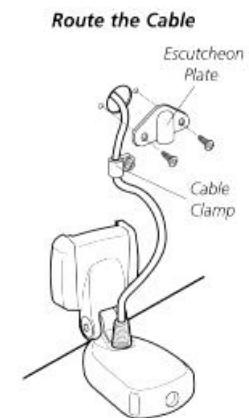

Figure 12

INSTALLATION

INSIDE THE HULL INSTALLATION

INSIDE THE HULL INSTALLATION

Inside the hull installation requires the mount system and control head be installed and operational. See *Installing the Control Head* for instruction on installing the unit.

Inside the hull mounting generally produces good results in single thickness fiberglass-hulled boats. Humminbird cannot guarantee depth performance when transmitting and receiving through the hull of the boat since some signal loss occurs. The amount of loss depends on hull construction and thickness, and the installation.

This installation requires slow-cure two-part epoxy. Do not use silicone or any other soft adhesive to install the transducer, as this material reduces the sensitivity of the unit. Five minute epoxy has a tendency to cure before all the air bubbles can be purged.

Step One - Determine the Mounting Location

Begin the transducer installation by determining where inside the hull to install the transducer. Consider the following to find the best location:

- Observe the outside of the boat hull to find the areas that are mostly free from turbulent water. Avoid ribs, strakes, and other protrusions as these create turbulence (Figure 14).
- As a general rule, the faster the boat can travel the further aft and closer to the centerline of the hull the transducer has to be located to remain in contact with the water at high speeds.

Step Two - Test the Mounting Location

There is no opportunity for adjustment after the transducer glued in place. Therefore, it is best to perform a trial installation on inside the hull transducers first, and run the boat at high speeds to determine the best mounting area.

1. At the identified mounting location, lay the transducer body face down with the pointed end towards the bow.
2. Fill the hull with enough water to submerge the transducer body. Use a sand filled bag or other heavy object to hold the transducer in position.

Transducer Mounted Inside the Hull



Figure 13

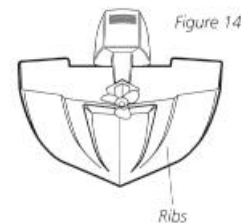

Figure 14

Preferred Mounting Area



Figure 15

The transducer cannot transmit through air. The water purges any air from between the transducer and the hull and fills any voids in the coarse fiberglass surface.

INSTALLATION

INSIDE THE HULL INSTALLATION

3. Power up the Control Head.
4. Run the boat at various speeds and water depths while observing the screen on the Control Head. If the unit functions well at low speeds but begins to skip or miss the bottom at higher speeds, the transducer needs to be moved. If depth performance is required, test the fishfinder in water at the desired depth. Test different locations in the hull until the optimum performance is achieved.

Step Three - Permanently Mount the Transducer

1. Once the mounting location is determined, mark the position of the transducer.
2. Remove the water from inside the hull and thoroughly dry the mounting surface. If the surface is excessively rough, it may be necessary to sand the area to provide a smooth mounting surface.

Ensure the mounting area is clear and dry.

3. Mix an ample quantity of two-part slow-cure epoxy slowly and thoroughly. Avoid trapping air bubbles.
4. Coat the face of the transducer and the inside of the hull (Figure 16).
5. Press the transducer into place with a slight twisting motion to purge any trapped air from underneath, keeping the pointed end of the transducer body pointed forward (Figure 17).

Note: Proper operation requires the pointed end of the transducer body to face towards the bow.

6. Weight the transducer so it does not move while the epoxy is curing.

When the epoxy cures, no water is necessary inside the hull. Neither water, spilled gasoline, or oil will affect the performance of the transducer.

Figure 16

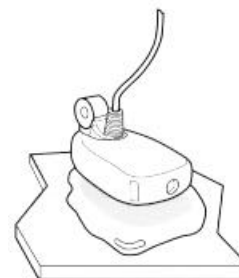
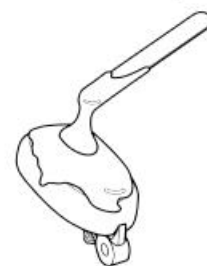

Figure 17

INSTALLATION

CONTROL HEAD INSTALLATION

CONTROL HEAD INSTALLATION

Step One - Determine Where to Mount

Begin the installation by determining where to mount the control head. Consider the following to determine best location:

- The cables for power, transducer and temp/speed accessories (if applicable) should be installed first and must reach the mounting location. Extension cables are available.
- There are two ways to route the cables to the unit: through a hole in the mounting surface underneath the mounting bracket or from a hole outside the mounting bracket. Routing the cables down under the mount provides maximum weather protection; however this is not always feasible if the area under the fishfinder is inaccessible. In this case, route the cables through a hole at another location and cover with the supplied hole cover.
- The mounting surface should be adequately supported to protect the fishfinder from excessive wave shock and vibration, and provide visibility while in operation.
- The mounting area should allow sufficient room for the unit to pivot and swivel freely, and for easy removal and installation (Figures 18-19).

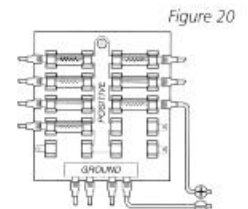
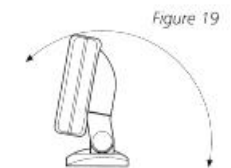
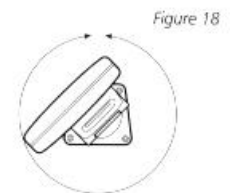

Step Two - Connect the Power Cable to the Boat

A 6' (2m) long power cable is included to supply power to the fishfinder. You may shorten or lengthen the cable using 18 gauge multi-stranded copper wire.

CAUTION: Some boats have 24 or 36 volt electric systems. Be sure your unit is connected to a 12 VDC power supply.

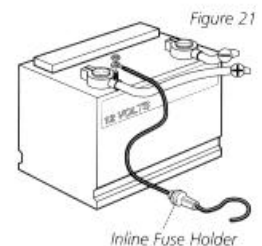

The Power can be connected to the boat's electrical system at two places: a fuse panel, usually located near the console, or directly to the battery.

If a fuse terminal is available, use crimp-on type electrical connectors (not included) that match the terminal on the fuse panel. Attach the black wire to ground, and the red wire to 12 VDC power (Figure 20). Be sure to use a one amp

fuse in the connection. If you must wire the control head directly to a battery, be sure to install an inline fuse holder

INSTALLATION

CONTROL HEAD INSTALLATION

and one amp fuse (not included) for the protection of the unit (Figure 21). Humminbird is not responsible for over voltage or over current failures.

In order to minimize the potential for interference with other marine electronics a separate power source (such as a second battery) may be necessary.

Step Three - Drill the Mounting Holes

1. Set the mounting bracket in place on the mounting surface. Mark the four mounting screw locations with a pencil or punch.
2. Set the mounting bracket aside, and drill the four mounting screw holes using a 9/64" (3.6mm) bit.

Step Four - Run the Cables

1. If the cables must pass through a hole underneath the mounting surface, mark and drill a 1" (25mm) hole centered between the four mounting holes (Figure 22).

Note: if the cables must pass through the mounting surface at a different location, drill the 1" (25mm) hole at that location and pass the cables through from underneath. Also, you must break out the tabs on the rear of the mounting base using needle nose pliers (Figures 24-25).

2. Insert all cables through the 1" (25mm) hole from beneath the mounting surface.
3. Pass the cables through the grommet (if the cable hole is underneath the mounting bracket) then press the grommet in place around the cables and into the 1" (25mm) hole.
4. Pass the cables through the mounting base, out the top of the mounting bracket.
5. Place the mounting bracket on the mounting surface aligned with the drilled holes. Insert the four flathead wood screws into the mounting holes and tighten fully (Figure 23).

Figure 22
1" (25mm) Hole Location

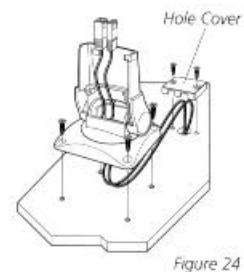
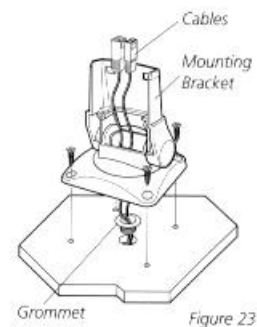
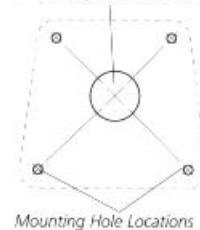

Optional: If the cables pass outside the mounting bracket, install the hole cover over the hole and fasten in place using the two #8 x 7/8" (22mm) wood screws (Figure 24).

INSTALLATION

CONTROL HEAD INSTALLATION

Step Five - Assembling the Connector Holder

1. Insert the cable connectors into the connector holder. The cable connectors are labeled, and there are corresponding labels on the connector holder (Figure 26). The slots for the connectors are keyed to prevent reverse installation, so do not force the connector into the holder.
2. Carefully pull the excess cable from beneath the - mounting surface so the connector holder aligns with the mounting holes on the front of the mounting bracket (Figure 27).
3. Snap the support plate to the rear of the connector holder (Figure 28).
4. Insert the connector holder into place and use the two #6-32 x $\frac{3}{4}$ " (9mm) screws to fasten it to the mounting bracket (Figure 28).
5. Install the control head by sliding it onto the mounting bracket until it is fully seated. To remove the unit simply depress the latch on the rear of the unit and lift (Figure 29).

Your Humminbird is now ready for operation.

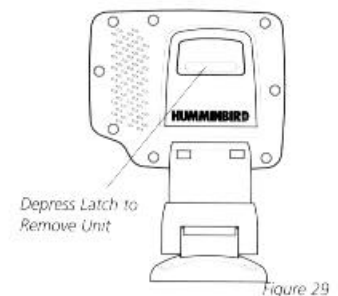
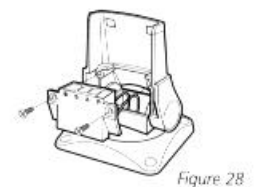
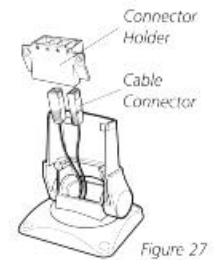
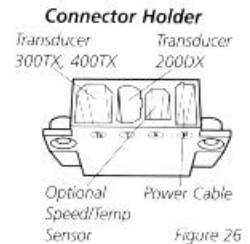

INSTALLATION

TEST THE INSTALLATION

TEST THE INSTALLATION

Testing should be performed with the boat in the water, however you can initially confirm basic operation with the boat trailered.

Press POWER once to turn the unit on. There will be an audible chirp when any button is pressed to confirm the button press. If the unit does not power-up, ensure the unit is fully seated on the mount and that power is available.

The first screen provides four options: Start-up, Options, Simulator, and Diagnostic. A message at the bottom of the screen indicates the transducer connection. If no transducer is detected (or one is not connected), the message will indicate this and the unit will go into simulator after the initial screen times out.

Note: the transducer must be submerged in water for reliable transducer detection.

If a transducer is detected, the unit will enter "Start Up" or normal operation unless you choose another option. If you do not press any button before the timer reaches "0", the normal operation screen is displayed. If the boat is in water, sonar data appears.

If the bottom is visible on screen with a digital depth readout, the unit is working properly. Ensure the boat is in water greater than 2' but less than the depth capability of the unit and the transducer is fully submerged. Remember the sonar signal cannot pass through air.

If the unit is working properly gradually increase the boat speed to test high-speed performance. If the unit-functions well at low speeds but begins to skip or miss the bottom at higher speeds, the transducer requires adjustment. Refer to the appropriate transducer installation section for more detail.

Note: it is often necessary to make several incremental transducer adjustments before optimum high-speed performance is achieved.

Important: For Transom Mount transducer installations, install the third mounting screw after the final transducer adjustments.



Humminbird • 3 Humminbird Lane • Eufaula, Alabama 36027

TESTING THE INSTALLATION

After installation is complete and all connections are made, you are ready to test the installation prior to actual use. Thorough testing should be performed with the boat in the water; however, you can initially confirm basic operation with the boat trailered.

Press POWER once to turn the unit on. There will be an audible chirp when any button is pressed that confirms the button press. If the unit does not power-up, ensure that the unit is fully seated on the mount and that power is available.



The first screen provides four options; Start-up, Options, Simulator, and Diagnostic. The time remaining before the screen “times out” is shown at the bottom of the screen. If you do not press any button before the timer reaches 0, the normal operation screen will be displayed. If the boat is on water, sonar data will begin to appear. If no transducer is connected or detected, the Portrait will go into simulator mode after the initial menu screen times out.

Note: The transducer must be submerged in water for reliable transducer detection.

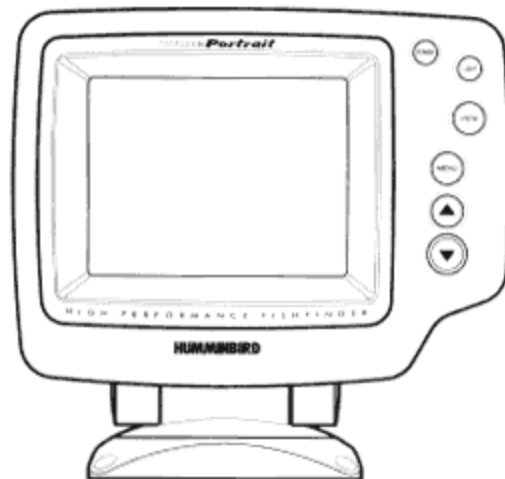

If the bottom is visible on-screen with a digital depth readout, the unit is working properly. If the unit powers-up but fails to display bottom information, the transducer is not properly connected. Ensure that the boat is in water greater than 2 feet but less than 600 feet deep, and that the transducer is fully submerged. Remember that the sonar signal cannot pass through air. Refer to the troubleshooting section of this manual. If the unit is working properly, gradually increase the boat speed to test high-speed performance. If the unit functions well at low speeds but begins to skip or miss the bottom at higher speeds, the transducer installation requires adjustment. Refer to the appropriate transducer installation section for more detail.

Note: It is often necessary to make several incremental transducer adjustments before optimum high-speed performance is achieved.

USING THE WIDE PORTRAIT

SIMULATOR OPERATION

The Wide Portrait is completely automatic and easy to use. Simply press the POWER button and the unit will locate and track the bottom from 2 feet to 600 feet changing ranges as necessary, display any structure or suspended fish and work at speeds from 0 to over 70 mph.



If POWER is the only button you use, you will benefit from the advanced automatic bottom tracking of the Wide Portrait. However, if you choose to experiment with the many features and controls the Wide Portrait offers, you can customize the presentation of information to suit your particular needs.

The Wide Portrait contains a simulator, which allows you to use the unit as if you are on the water. The Simulator is invaluable for learning how to operate the many features of the Wide Portrait. There are two ways to enable the Simulator: if the unit is powered off, press and hold the POWER button for approximately 3 seconds until a continuous chirp is heard. The Simulator can also be enabled by selecting the Simulator option on the start-up screen after you normally power-up the unit. When this screen is shown, simply press the DOWN ARROW until "Simulator" is highlighted. When the screen times-out, the unit will be in Simulator mode.

If the Wide Portrait is powered up with no transducer connected, the unit will automatically default to the Simulator mode, as normal operation is not possible.

Once the Simulator mode is selected, the next screen will allow you to select either "down" simulator or "side" simulator (the "down" selection simulates normal operation of the unit with the Tri-beam transducer connected). "Down" simulator is the default setting, so if no adjustment is made, the down simulator will be selected. The "side" simulator simulates operation with a Wide Side transducer connected; this is an excellent way to see if you like the way the unit works using the optional Wide Side transducer.



When in simulator operation, the Wide Portrait responds to control inputs as if it is in actual operation, so feel free to experiment with the many features and functions to customize the Wide Portrait for your particular operation. The unit will also simulate the Temp/Speed accessory by showing water temperature and boat speed-readings. To exit Simulator mode, power the unit off.

FEATURE MEMORY

If your Wide Portrait is installed with a transducer connected, any changes you make to the set-up or User Options (see Control Functions) while in Simulator are retained in the unit's memory. This allows you to use the simulator to experiment with the various set-up options, and retain your selected settings for normal operation.

If you are using the Wide Portrait in Simulator when no transducer is connected, any selected options are lost when the unit is powered off. The Wide Portrait will return to Factory Settings, or options selected when last used with a transducer, if no transducer is connected.

IMPORTANT: A transducer must be connected to the Wide Portrait in order to retain user settings selected when in simulator mode. If no transducer is detected, the unit defaults to pre-selected options when powered off.

Your Wide Portrait uses a 128 x 128 matrix Super- Twist LCD display. This type of display provides outstanding viewability in all light conditions over a wide range of temperatures.

The presentation of information on-screen may take one of several forms depending on the type of transducer being used, whether or not the Temp/Speed sensor is connected, and the current setting of various user options. See Advanced Operation for information on custom screen options.

NOTE: When in simulator mode, the word "simulator" occasionally appears on the display indicating that the information onscreen is not real sonar data.

The initial screen layout takes one of two basic forms depending on whether the Temp/ Speed accessory is installed. Figure A shows the default view when the Temp/ Speed accessory is not installed. The digital depth number shows the depth of water directly beneath the transducer location.

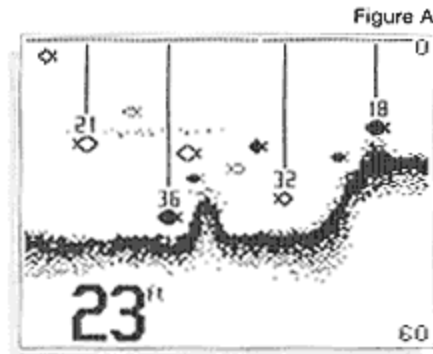

The range of the graphic display is shown to the right of the graphic information. The upper number is 0 indicating the surface of the water, the lower number is one of the 9 ranges available which best matches the depth of the water. As the depth of the water changes, the range changes as necessary in order to retain a bottom representation on-screen.

When in Auto mode, the horizontal line at the top of the graphics area is the 0 line which represents the surface of the water. Occasionally there will be a gap in this line. This gap indicates that the unit is updating the display even if the bottom is not visible on-screen, or if the bottom information is not changing.

The graphic representation of the bottom may vary considerably depending on the composition and regularity of the bottom surface (see interpreting the On-screen Information). Any sonar return which is determined to be not a part of the bottom is shown between the surface and the bottom. If this return is determined to be a fish, one of several fish shapes is drawn which indicates the size, depth, and location of the fish (see Interpreting the On-screen information).

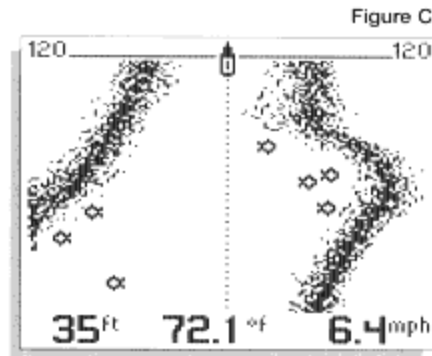

Figure B shows the default view when the Temp/ Speed sensor is connected. Water surface temperature and boat speed are displayed at the bottom of the screen. If the Wide Portrait determines that a Wide Side transducer is connected, the default view is shown in Figure C. Sonar information from both the left and right beams is shown.

As you learn the many capabilities and user preference functions of the Wide Portrait, additional screen configurations are possible.

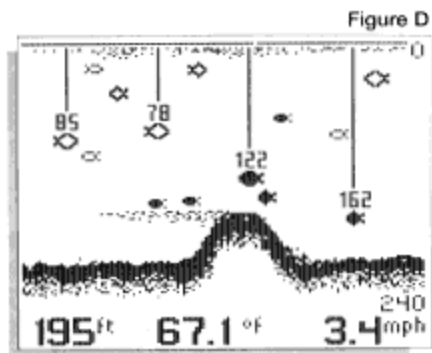
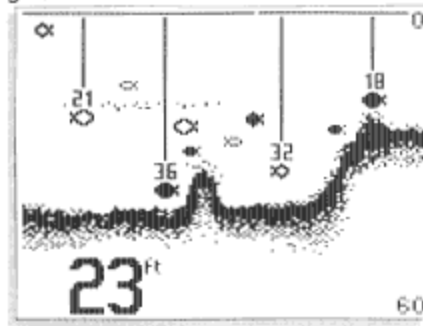

Figure D shows a view with “Small Digits” selected in the User Options menu. By selecting smaller digits for the depth, speed and temp information, more of the screen is available for the graphic representation of the sonar information. This effectively increases the display resolution of the Wide Portrait, allowing targets which are very close together to be displayed as separate symbols.

INTERPRETING THE ON-SCREEN INFORMATION

Figure E shows a typical view you can expect to see on-water. New sonar information appears on the right side of the graphic area of the display and moves to the left as new information is displayed. The Wide Portrait automatically selects the appropriate depth range to show the depth of water beneath the transducer. This range is selected so that the bottom representation is typically shown about 2/3 down the display.

Figure E



The graphic depiction of the bottom provides the user with an effective tool for understanding the composition of the bottom. If the bottom is hard and smooth, the bottom depiction is narrow and dense. If the bottom is soft mud or sand, the depiction will be thick and less dense. This indicates that much of the signal is absorbed by the soft bottom. If the bottom is rocky or rugged in composition, the depiction is of varying density and textured in appearance.

Wave action also affects the bottom depiction. Remember that the information drawn is a distance measurement, so if the boat is moving up and down over flat bottom, the bottom depiction often appears in regular variations which match wave timing.

Structure is defined as any object physically attached to the bottom. The sonar configuration of the Wide Portrait is optimized to give the most accurate depiction of bottom structure possible. Grass, trees, stumps, wrecks or other debris are accurately displayed, however the depiction of these objects varies with boat speed and direction. The best way to learn to interpret structure is to operate the Wide Portrait over a variety of known conditions and experiment with user functions to best represent those conditions on-screen.

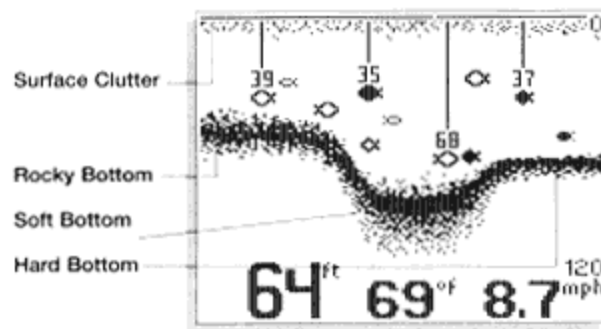

Sonar targets which are not physically attached to the bottom may take one of many shapes. Surface clutter is the layer of water near the surface which is rich in algae and other growth, and often is aerated by wind or wave action. This area interferes with sonar transmission and often appears on-screen as regular clusters of individual dots near the "O" line.

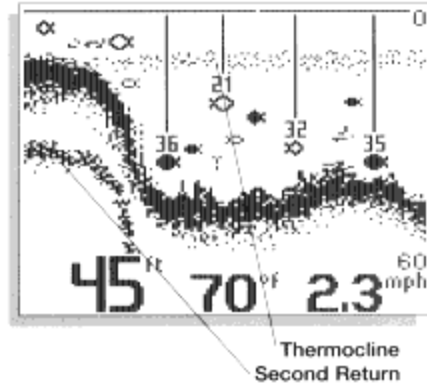

Thermoclines are sharp differences in water temperature. These are easily identified by the continuous nature of the return. When a sonar signal is reflected off the bottom back to the transducer, there is often enough energy left in the signal to be reflected off the surface of the water back to the bottom a second time. Second returns appear as a slightly weaker bottom representation exactly twice the depth of the primary bottom return. The second return is most likely to occur in shallow water and in areas of relatively hard bottom.

The Wide Portrait uses advanced signal processing to further evaluate any sonar return between the surface and the bottom. For instance, a small school of bait fish usually appears as a dense cluster of individual dots. If the return meets certain additional criteria, a fish symbol will be assigned. There are three different size fish symbols used to indicate the intensity of the sonar return. While signal intensity is a good indicator of relative fish size, different species of fish have different sonar characteristics, so it is not always possible to distinguish fish size between varying species.

The signal intensity is “normalized” for depth so that a small fish close to the boat does not appear as a large fish symbol. A further method of differentiation of fish symbols indicates which of the three sonar beams the fish is detected in. This gives you a reliable indicator of side to side location relative to boat movement. Fish symbols which are hollow are detected in the outside two beams. Hollow fish symbols facing to the right are detected in the right beam and therefore are to the right side of the boat (as viewed from the driver seat facing forward). Hollow fish symbols facing to the left are detected in the left beam, and thus the fish is to the left side of the boat. Solid fish symbols represent fish which are detected in the single center beam, and these fish are directly under the boat.

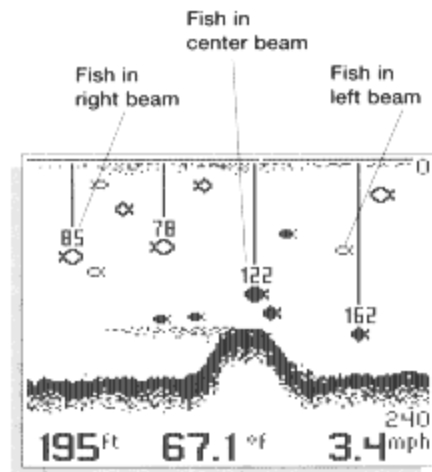

ID+ adds an additional piece of information to help the user locate fish. On selected fish symbols, the digital depth of the designated fish is drawn to help locate the fish vertically. This is especially helpful in setting bait depths or for downrigger operation.

CONTROL FUNCTIONS

The Wide Portrait uses a simple 6-button keypad for all user input. When any button is pressed, an audible “chirp” confirms the control input. In the event that a particular button has no function or is inappropriate for the situation, an audible “error”, or multiple chirps will be heard.

POWER, powers the Wide Portrait up for normal operation. When the unit is on, POWER turns the unit off. POWER can also be used to go directly into the Simulator mode. With the unit powered off, press and hold POWER for several seconds until a continuous chirp is heard.



LIGHT controls the unit's 4-position display back light. With the unit powered on, pressing LIGHT once will turn the back light on “low”. Pressing LIGHT a second time will turn the back light on “high”. Press LIGHT again to turn the back light off. The backlight is very effective for low- light and nighttime operation. When the backlight is on, the Wide Portrait will consume more power than with the backlight off. This is important when using the Wide Portrait in a portable configuration powered by a separate battery, or when powering the unit from a trolling motor battery.

NOTE: When powering the unit from a battery such as in portable applications, avoiding use of the backlight prolongs battery life.

The VIEW button selects one of several screen configurations or “views” possible depending on the transducer in use. When using the standard (Tri-beam) transducer, the view button toggles the display between the full- screen 2D view, and “Monster Digits” view. Monster Digits increases the size of key digital information so that it can be viewed from a great distance. Pressing VIEW again will toggle the display back to the 2D view.



If a Wide Side transducer is being used (see Using Alternative Transducers), the VIEW button is used to select one of four views available: Both, Left, Right, and Down.

The three lower buttons, MENU, UP, ARROW, and DOWN ARROW work together to control the Wide Portrait menu-controlled user functions.

MENU brings a menu on-screen for adjustment. In normal operation, pressing MENU repeatedly will cycle through all available menu headings. A menu remains on-screen for several seconds allowing user adjustment by means of the ARROW keys.

If no adjustment is made in the allotted time, the menu disappears. If you need the menu to remain on-screen longer to study the adjustment options, press and hold MENU- the menu will remain on-screen indefinitely. Once you release the menu button, the menu will time out. Once a menu times out, it is still considered the active menu. Pressing MENU will bring up the last used menu.

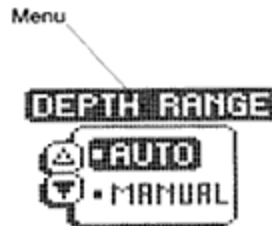

The UP ARROW and DOWN ARROW make adjustments to menu functions. On the left side of every menu there are UP ARROW and DOWN ARROW symbols. The symbols indicate which ARROW button has a function in a particular situation. Either one or both ARROW buttons can be used to adjust the menu function. A hollow ARROW symbol means that the corresponding ARROW button has no function. Pressing that button will result in no adjustment and the “error” audible will be heard. A solid ARROW symbol means that the corresponding ARROW button can be used to affect the menu adjustment.

The ARROW buttons often can be used when no menu is on screen. In these situations, pressing the ARROW button affects the function of the active (last-used) menu. This is a short-cut to menu operation. The menu appears on-screen while the adjustment is made and “times out”. A frequently used menu can be adjusted very quickly using this technique. After an adjustment is made to a menu function, the menu “times out” after several seconds and the unit will return to normal operation. The sequence in which the menus appear is adjusted by the order that the menus are used. The last menu adjusted will always appear first. The second most recently used menu will appear second, etc. This “automatic sequencing” ensures that the most recently used menus will always appear first, and menus which have not recently been adjusted will appear later in the sequence.

All menus use the same basic layout as shown in figure F. The heading at the top describes the menu function (see Menu Functions for more details on individual functions). The UP ARROW and DOWN ARROW symbols to the left of the menu indicate which buttons are available for adjustment. In menus which have numerous possible settings such as Depth Range, a range of adjustment indicator shows the total range available and the current setting. Within the menu are the options available. The selected option or current setting is highlighted in the black box.

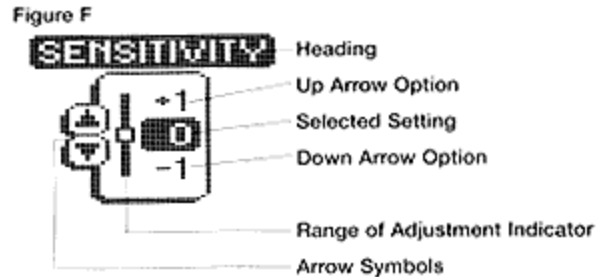

If no adjustment is made, this will be the selected setting. Pressing one of the ARROW buttons while the menu is on-screen selects another option.

Several of the menus are multi-step. In some situations if an adjustment is made, additional options become available for further adjustment. Examples of these multi-step menus are Depth Range, Depth Alarm and Zoom. See the detailed description of each function for further explanation.

The one menu option which functions differently than the previously described is the Options menu. User Options is a group of functions which are used initially to select user preferences. The options are not normally needed during operation of the unit. Options differ from the other menu functions in that once selected for viewing, the menu will not 'time out'. All the user options must be sequenced through before returning to normal operation.

SENSITIVITY

The Sensitivity function controls the sensitivity of the sonar receiver. The Wide Portrait automatically adjusts the level of receiver sensitivity based on a number of factors including the depth of the water and the level of noise present. Noise can be caused by other electronic devices, engines, trolling motors, propeller cavitation and hydrodynamic flow among others.



The user has the option of biasing this Sensitivity adjustment either higher or lower based on personal preference. You can select one of 11 sensitivity bias settings from -5 to +5. A bias setting of 0 (Factory Setting) has no effect on the automatic sensitivity control.

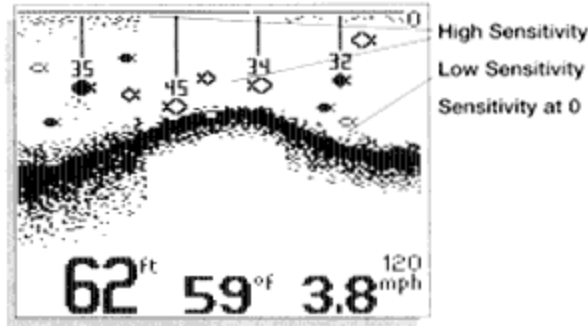

Increasing the bias (+1 through +5) causes the unit to display the information from progressively smaller sonar returns. By decreasing the sensitivity bias (-1 through -5), the unit effectively filters small sonar returns.

In murky or muddy water, it is often advantageous to reduce the sensitivity bias. This prevents the display from being cluttered with sonar returns from debris or suspended particles. In very clear or very deep water, it may be desirable to increase the sensitivity bias since even the smallest sonar return may be of interest to the user.

To adjust Sensitivity, press MENU repeatedly until the Sensitivity heading is displayed. When the Sensitivity menu appears, use the UP ARROW to increase the sensitivity bias, or the DOWN ARROW to reduce sensitivity bias. By holding either ARROW button depressed, the unit will sequence through the available settings until you release the button or the end of the adjustment range is reached. If additional time is needed to study a menu, press and hold the MENU button and the menu will remain on-screen indefinitely.

If a setting limit is reached, the ARROW symbol attached to the menu appears to be hollow which indicates that the related button has no further function. Also, the audible "error" consisting of multiple chirps will be heard.

After an adjustment is made, the menu disappears and the new sensitivity setting begins to affect new sonar information as it flows on-screen. If additional adjustment is needed, the UP ARROW or DOWN ARROW can be pressed without having to first press MENU.

The sensitivity setting is remembered in memory after the unit is powered off.

DEPTH RANGE

The Depth Range function controls the vertical distance displayed on the graphic area of the display. There are 9 different depth ranges available. The top of the range is always 0, or the surface of the water. Ranges of 0-15 feet, 0-30 feet, 0-60 feet, 0-120 feet, 0-180 feet, 0-240 feet, 0-360 feet, 0-480 feet, and 0-600 feet are available. The range which positions the bottom depiction closest to the bottom of the graphic area of the display will best utilize the available display resolution.



The Wide Portrait automatically adjusts the depth range depending on the depth of the water. The unit tries to maintain the bottom depiction about 2/3 down the total range (for example, in 20 feet of water, the 0-30 foot range would be selected). This provides the best display resolution and therefore the best target separation possible.

The Depth Range can be adjusted manually. Press MENU repeatedly until the Depth Range menu is visible. The two options available are "Auto" (Factory Setting) and "Manual". Pressing the DOWN ARROW enables "Manual" depth range control and an additional menu will appear which allows the user to adjust the current depth range setting. If no further button is pressed, the current depth range is selected as the desired range and the unit returns to normal operation.

Using "Manual" Depth Range control, the user can view sonar information from the area near the surface in great detail. If a depth range other than the current range is desired, pressing the DOWN ARROW to highlight "Adjust" will allow selection of one of the 9 available ranges. Simply press and hold the UP or DOWN ARROW button to scan through the available options. If a setting limit is reached, the audible "error" or multiple chirps will be heard and no further adjustment is allowed.

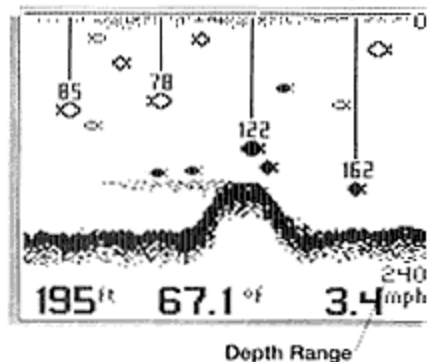

When "Manual" range is used, the unit no longer adjusts the Depth Range to the most appropriate range for bottom display. Often, the bottom may not be visible on-screen. The digital depth readout always determines the depth of the bottom, even if it is not visible on-screen.

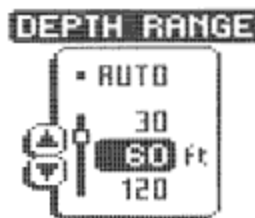

When a Depth Range is selected manually and the Depth Range menu is still active (most recently used), further adjustment of the depth range can be achieved by simply pressing the appropriate UP or button. The ARROW button. The button press will bring the Depth Range menu on-screen and allows immediate adjustment of the range.

To return to "Automatic" Depth Range control, press the MENU button until Depth Range menu appears on-screen and use the UP ARROW to select AUTO. The Wide Portrait returns to automatic operation.

Note: Depth Range is not remembered when the unit is powered off. At power up, the unit is always in automatic depth range.

Zoom

Zoom is similar to Depth Range in that it controls the range of information displayed in the graphics area of the display. Zoom, however, allows selection of ranges beneath the surface so any area of water between the surface and the bottom can be enlarged to provide more detailed information. By using the full display to show a small area of coverage, the effective display resolution is increased, and the unit's ability to separate targets which are very close together is enhanced.

There are four different Zoom ranges available; 7 ½ feet, 15 feet, 30 feet, and 60 feet. These ranges are not directly user controlled but are instead dependent on the current depth range. In shallow water, when the 15 foot or 30 foot range is in use, the Zoom range is 7 ½ feet. If the 60 foot or 120 foot range is in use, the Zoom range is 15 feet. If a 180 foot-480 foot depth range is in use, the Zoom range is 30 feet, and if the 600 foot range is in use, the Zoom range is 60 feet.

It is not possible to use Zoom in conjunction with the Monster Digits view. While the Monster Digits view is always available, Zoom information is only displayed on the 2D view.

The Wide Portrait shows Zoom range in conjunction with the full depth range. The Zoom range is shown on the left side of the screen and full range information is shown on the right side of the display. Zoom can either operate automatically, in which the Zoom range is constantly adjusted to show the bottom, or manually, in which the user controls the location of the Zoom Range.



"Automatic" Zoom is especially helpful when looking for structure or bottom detail. The "Automatic" Zoom keeps the bottom in view even in quickly changing terrain. "Manual" Zoom provides detailed information of any area from the surface to the bottom. In "Manual" Zoom, the Zoom range does not move as the terrain changes.

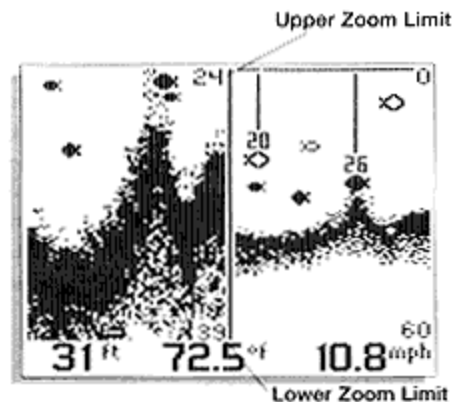

To operate Zoom, press MENU repeatedly until the Zoom menu is on-screen. Three options are available: "Off(Factory Setting)", "Auto" (Automatic bottom tracking Zoom), and "Manual" (User controlled Zoom range). Press the DOWN ARROW once to highlight Auto.



When the menu disappears, the graphics area of the screen will be divided in half. Full range information is on the right, Zoom information on the left. The digital depth readout is unaffected by Zoom.

Pressing the DOWN ARROW again to highlight "Manual" activates Manual Zoom. The menu further expands to show the current Zoom range, and allows user adjustment of this range.

When the range is shown in the menu, the upper number represents the top of the current Zoom range. The lower number represents the bottom of the Zoom range. The UP and DOWN ARROW buttons can be used to move this range. The upper number can never be less than 0 (the surface of the water), and the lower number can never be greater than the active depth range.

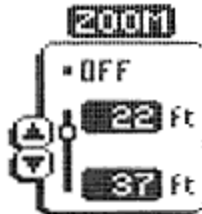

Once "Manual" Zoom is selected, the display will appear the same as in "Auto" Zoom, but the zoom range does not change automatically. If further adjustment of the Zoom is necessary, pressing either ARROW button while Zoom is active will move the Zoom range up or down. The menu returns briefly to show the numeric values as the adjustment is made.

To disable Zoom. Press the Menu button until the Zo0m menu is on-screen. Use the UP ARROW to highlight Off, and let the menu time out.

When the unit is powered off, the Zoom menu returns to Zoom Off.

Depth Alarm

The Wide Portrait contains an audible alarm to warn you of shallow water depths. The alarm is adjustable from 2 feet to 99 feet of depth. When the alarm is enabled, an audible alarm is sounded if the water beneath the boat is equal to or less than the selected alarm depth. Upon activation, the alarm sounds continuously for about 5 seconds, and then intermittently to remind you that you are still in shallow water.



To enable Depth Alarm, press MENU repeatedly until the Depth Alarm menu is on-screen. The Factory Setting is "Off". Use the DOWN ARROW to highlight On. The menu will expand to show the current Depth Alarm setting. Use the UP or DOWN ARROW to set the desired depth for alarm activation.

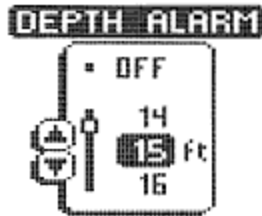

Once the menu times out, the Depth Alarm is enabled. To further adjust the setting, simply press the UP or DOWN ARROW. The menu appears briefly to indicate the setting. If the alarm is sounding and you want to disable it, use the MENU button to bring the Depth Alarm menu on-screen, and the UP ARROW to highlight "Off".

The most recent Depth Alarm setting is remembered after the unit has been powered off.

Fish Alarm

The Fish Alarm alerts you to the presence of fish, or other targets not connected to the bottom. The Fish Alarm has 3 different settings which correspond to the 3 different size fish symbols shown on-screen.



To enable Fish Alarm, Press the MENU button repeatedly until the Fish Alarm menu appears on-screen. The menu shows two options, "Off (Factory Setting) and "On". Use the DOWN ARROW to highlight "On" and the menu further expands to show the 3 alarm options. The selected setting will be "Large fish only". With this setting, the Wide Portrait alarms on only those targets which are represented by the large fish symbols (see Interpreting the On-Screen Information). Pressing the DOWN ARROW again highlights "large and medium fish" and pressing a third time highlights 'LARGE, MEDIUM, AND SMALL FISH". With this setting, any fish symbol appearing on screen activates the Fish Alarm.



Once the Fish Alarm is enabled, the Wide Portrait emits an audible beep when the selected size fish symbol appears on screen. The sound is slightly different for each of the three fish symbol sizes, so with practice, it is possible to distinguish the size of the detected fish without looking at the unit.

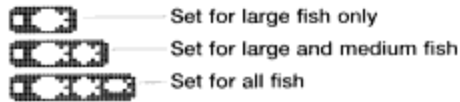

To disable the Fish Alarm, press MENU until the Fish Alarm menu appears on-screen. Use the UP ARROW to highlight “Off”, and let the menu time out.

Fish Alarm settings are remembered when the unit is powered off.

Triplog

Triplog provides a running log of information based on input from the Temp/Speed sensor. Since Triplog requires information from the Temp/Speed sensor to operate, if this sensor is not detected by the Wide Portrait, the Triplog menu will not appear as an option.



To enable Triplog, press MENU repeatedly until the Triplog menu is on-screen. The Factory Setting is “Hide” which is selected. Use the DOWN ARROW to select “Show” and the Triplog box will appear at the upper left corner of the screen.

Triplog provides four pieces of information; the distance traveled since the Wide Portrait was powered-up or reset, the average speed, the total time elapsed since power-up or reset, and the input voltage from your boat’s electrical system.

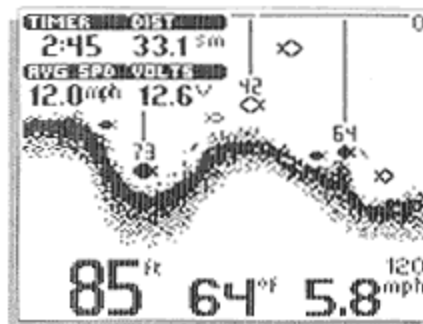

The time, speed, and distance calculations are useful for tracking your progress on a trip. The input voltage is useful for determining the condition of the charging system of the boat.

When used in a portable application or whenever the Wide Portrait is operated from a battery source, the voltage number can be used to determine battery life. The Wide Portrait will operate at voltages from 10 to 16 VDC. Voltages in excess of 16 or less than 10 VDC will cause the unit to power off.



Once Triplog is enabled, pressing MENU to bring the Triplog menu on-screen now shows an additional option. "Reset". By selecting Reset, the timer and distance log resets to 0 and the Triplog will begin to calculate elapsed time, distance traveled, and average speed from the time of reset.

Triplog can be used with any view, even Wide Side. When Triplog is enabled in Monster Digits view, the Triplog information will displace the water temperature readout.

To disable Triplog, press the MENU button until the Triplog menu is on screen. Use the UP ARROW to select Hide and let the menu time out. The Triplog continues to operate and log time and distance even when it is not visible on-screen. The Triplog resets at power-off.

Options

The Options Menu is actually a series of linked menu functions which are used initially to select user preferences. Once user preferences are selected, it is unlikely that these functions need to be accessed during the normal operation of the product.



The options menu works differently than other menu functions in that all of the options must be cycled through in order to return to normal operation. There are seven Option menus: Contrast, Units, Fish ID, Numerical size, Transducer, Display speed, and Reset.

Press MENU until the Options menu is on-screen. There are two choices, Hide (Factory Setting) and Show. Use the DOWN ARROW to highlight Show and the first Options menu appears.

Contrast

The Contrast function allows the user to control the level of contrast of the LCD display. The Wide Portrait will automatically adjust the display contrast to compensate for changing ambient temperatures; however some situations may occur where manual adjustment will provide a higher level of contrast.



Eleven contrast settings, +5 to -5 are possible. The display contrast will change as the adjustment is made so the optimum level of contrast can easily be adjusted. Use the ARROW buttons to highlight the desired selection. The Wide Portrait will reset to the factory setting when the unit is powered off.

Units

The Unit's function allows the user to select the units of measurement for the speed readout. Both MPH or statute miles per hour are available. Use the ARROW buttons to highlight the desired selection. The Wide Portrait remembers this selection even when the unit is powered off. Press MENU to go to the next menu.



Fish ID

The next Option menu is Fish ID. There are three selections available; Off, ID on, and ID+ On. The factory setting is ID+ On. With Fish ID Off, sonar returns are displayed as "raw" information. There is no interpretation made by the unit. Selecting ID Off will also disable the fish alarm.



ID ON enables the Wide Portrait to interpret the raw sonar data and, using a variety of techniques, depict appropriate target returns as one of three different size fish symbols. Further identification shows whether the fish is in the left, center, or right beam.

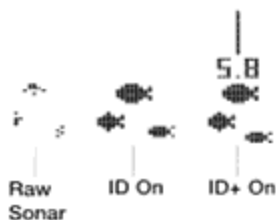

ID+ ON adds an additional piece of information to the location of the fish. The depth beneath the surface for selected fish symbols is attached to the fish symbol.

Use the ARROW buttons to highlight the desired setting, and press MENU to advance to the next menu.

The unit remembers Fish ID setting when powered off.

Numeral Size

Numeral Size is the next Option menu. Two options are available: "Big" and "Small". The factory setting is Big. With this setting, the digital depth and speed and temp numerals are drawn large enough to be readable from across the boat. The big numerals occupy space on the display which could be used for the graphics area. Hence, the small numerals option. With small numerals selected, a greater amount of the display area is available for the graphic view. This effectively increases the display resolution of the unit. Sonar targets which are very close together can often be displayed as separate targets, through the distance from which the numerals are readable is somewhat less.



Use the UP and DOWN ARROW buttons to highlight the desired selection, then press MENU to advance to the next menu.

Numeral Size settings are remembered when powered off.

Transducer

The transducer option controls how the Wide Portrait determines which transducer is connected to the unit.

The Wide Portrait can identify and operate with several different transducers. At power up, the Wide Portrait will first identify if a transducer is connected. If none is detected, the unit will default to simulator mode. If the standard Tribeam Transducer is detected, the unit will begin normal "down" operation. If a transducer other than a Tribeam is detected. The Wide Portrait will assume this is a Wide Side transducer (see Using Alternative Transducers) and begin operation in Wide Side mode.

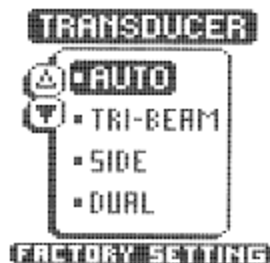

The Transducer Option menu has four settings: Auto, Tri-Beam, Side< and Dual. The factory setting is Auto, in which case the Wide Portrait uses the transducer detection capability to choose the transducer, as described. To override this capability, select the setting that corresponds to the transducer that is physically attached to the unit. Using this option to choose a transducer manually forces the Wide Portrait to use the screen display appropriate to the specified transducer, regardless of what kind of transducer it detects.

The Wide Portrait will also work with older Dual beam transducers. If you are using a Dual beam transducer, you must manually select "Dual" from the transducer menu as the Dual Beam transducer cannot be identified automatically. If "Dual" is manually selected, dual beam operation will be selected any time a non-standard transducer is detected. This allows the Wide Portrait to be used in conjunction with a transducer switch, so more than one type of transducer can be used with a single unit. A common installation is to use one transducer for high-speed operation, and a second transducer mounted on a trolling motor. The second transducer can be another Tri-beam, a Wide Side, or a Dual Beam.

Note: Unless you are using a non-standard transducer, or suspect a problem with the transducer recognition, always leave this option set to Auto. If you are using a Dual Beam transducer, you must manually select "Dual" for the Wide Portrait to work properly using this transducer.

The Wide Portrait cannot differentiate between a Wide Side and Dual beam transducer. If you are using these two transducers through a switch, the transducer selection must be manually changed every time the switch position is changed.

The Transducer setting is remembered when the unit is powered off. If it is not set to Auto, a message will appear at startup to indicate that the transducer has been manually selected.

Once the transducer selection is made, use the MENU button to advance to the next Option.

Display Speed

Display Speed controls the rate which the graphic information moves across the display. There are 5 possible speeds, the fastest rate (5) is the factory setting. If your boat is stationary or moving very slowly for extended periods, it may be desirable to update the display at a slower rate. The closer the update rate matches boat speed, the more accurate is the graphic depiction of the terrain beneath your boat. Use the UP and DOWN ARROWS to select the desired rate. (1) is the slowest, (5) is the fastest. Use the MENU button to advance to the next menu.



Display Speed setting is remembered when the unit is powered off.

Reset

The final Option is Reset. With many User Options available to customize the Wide Portrait, it is easy to configure the unit in such a way that is detrimental to a particular use. By using the Reset function, all variable or user-controlled features of the Wide Portrait are returned to the factory settings.



The Reset function is an important first step in trouble-shooting problems to ensure that a user-selected setting is not the cause for the perceived problem.

CUSTOMIZING SET-UP FUNCTIONS

The Wide Portrait allows the user to customize many features to work best for a particular type of use. These user selections are remembered by the unit after power is disconnected. Control of these features is accomplished through the menu system. Primary menu functions include Sensitivity, Depth Range, Zoom, Depth Alarm, Fish Alarm, Triplog (if the Temp/Speed sensor is connected) and Options.

The Options menu is a grouping of user preferences which are normally set initially but not typically needed in the normal operation of the product. Options are accessed in one of two ways. At power-up, direct access to the Options menus is given on the start-up screen. This is a quick way to adjust user options before beginning normal operation.



Also, as mentioned, the Options menus are part of the normal menu system and are accessible any time.

Options allows the user to select the units of measurement for speed, the method of depicting fish targets, the basic screen layout and size of numeric information, type of transducer, the speed of update of the display, and to reset all variables to Factory Settings.

IMPORTANT: A transducer must be connected to the Wide Portrait in order to retain user settings selected when in simulator mode. If no transducer is detected, the unit will default to factory options when powered off.

Refer to Menu Functions for detailed information of User Options.

USING DIAGNOSTIC

The Wide Portrait contains a powerful diagnostic tool which can aid in determining the cause of a problem. To enable Diagnostic, power the unit on and use the DOWN ARROW button to highlight the Diagnostic option on the initial screen. Diagnostic can only be accessed at power-up.



After the menu times out, the diagnostic screen will appear. Upon enabling diagnostic, the Wide Portrait will perform a self-test. This test confirms the operation of all internal circuitry. At the conclusion of the test, one of two messages will appear on the left side of the screen; “passed” indicates that the internal test discovered no failures. “Failed” indicates that a significant internal problem was discovered and the unit will require factory service. In conjunction with the failed indication will be a code which indicates to the repair personnel where the problem is.

Even if the self-test is passed, other messages may be present to indicate an abnormal situation. Examples of these are high-voltage and low-voltage shut down indications. The Wide Portrait will shut down to protect the inner circuitry if the input voltage exceeds 16 VDC or is less than 10 VDC. If either of these conditions cause the unit to shut down, a message will indicate this.

NOTE: Powering the unit off will reset these messages.

The right side of the Diagnostic screen evaluates external connections to the unit. The first category is Transducer input. If a transducer is detected, a message will indicate the type of transducer connected. This is an excellent way to confirm transducer connection. If a transducer is connected directly to the unit, the connection will be indicated here. If a switch is used, use Diagnostic to confirm the connections from each transducer. If a series of dashed lines is shown, then no transducer is connected or there is a problem with the transducer or cable.

The next categories indicate the connection of boat speed sensor and surface water temperature sensor. These accessory sensors can be purchased independently or together as a single sensor (see Available Accessories). If the sensors are connected and working properly, a “connected” message will appear.

Note: This feature only works when the boat is in motion, as the paddle wheel on the speed sensor must rotate to be detected.

The voltage input category is especially helpful in diagnosing input voltage problems. The current input voltage will be displayed. If voltage fluctuations or power supply in excess of 16 VDC or less than 10 VDC is suspected, use the diagnostic screen to confirm input voltage. Often, small outboard motors do not effectively regulate voltage when operated at high engine speeds. Use Diagnostic while running the boat at high speeds to show the voltage gain. Also, if you are using the Wide Portrait in portable configuration or from the trolling motor battery, Diagnostic can be used to evaluate the health of the battery by showing the current voltage.

The total time category indicates the total time the unit has been in use since shipped from the factory. Note: It is normal for some hours to be indicated in the total time when the unit is new due to factory testing.

While this is often of interest to the user, it is primarily a diagnostic tool for the repair technician should service be required.

Press MENU to exit Diagnostic.

USING ALTERNATIVE TRANSDUCERS

The Wide Portrait is designed to operate with the Tri-Beam transducer included standard with the product. The standard transducer can be mounted on the transom of the boat, or bonded to the inside of most fiberglass hulls. Tri-beam transducers are also available in trolling motor mounts, and bronze thru-hull type mounts.

The Wide Portrait also has the ability to work with two additional transducers: Dual Beam and Wide Side. See Available Accessories for selection of the transducer.

Wide Side Operation

The Wide Side transducer is a specialized “side-locking” transducer which is extremely useful for bank fishing or looking for bait fish in open water. The Wide Side transducer uses 3 different sonar elements which transmit signals to the left, right, and straight down from your boat. The downward beam is 200 kHz with a 24-degree area of coverage. This beam maintains continuous digital depth readout from the bottom directly beneath your boat.

The side beams are 455kHz with a 16-degree area of coverage. The side-locking elements can be used independently or together to locate targets near the surface of the water on either side of your boat.

The Wide Side transducer is available as a trolling motor mount, a transom mount, or a portable mount.

Note: The Wide Side transducer can be connected directly to the Wide Portrait or used in conjunction with the standard transducer through a transducer switch. When used with a switch in conjunction with the Tri-Beam transducer; the Wide Portrait recognizes which transducer is connected whenever the switch position is changed.

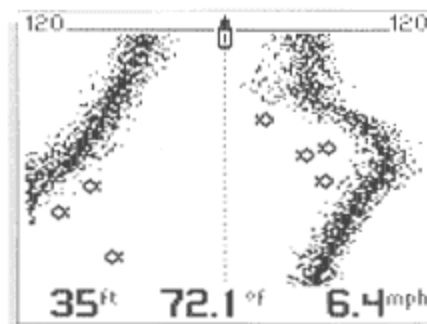

When a Wide Side transducer is connected, the screen display changes to display the information from the side-locking elements. There are four basic views available when the Wide Side transducer is in use; both, left, right, and down. These views are controlled by the VIEW button. The default view is both, in which information from both the left and right elements are displayed on-screen. The digital depth of the water beneath your boat is always present.

Viewing both left and right sides simultaneously gives you an excellent tool when searching for bait fish in open water, or when following a creek bed, however greater display resolution can be

achieved by viewing only one side. To change the view, simply press the VIEW button repeatedly until the desired view is on-screen. The Down view is similar to the traditional view when using the standard transducer, however there is no Tri-beam information available such as fish location.

When operating in Wide Side mode, the range must be adjusted manually, since the bottom is often not visible on-screen. Ranges of 15, 30, 60, and 120 feet are available. Also, Zoom is not possible in any side looking views, and the Zoom menu is not available.

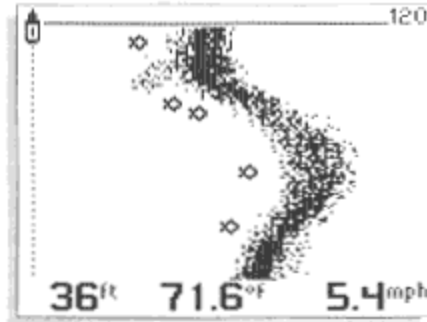

Experiment with the Wide Side transducer while operating it in a familiar area to learn how to maximize use of the information displayed. Remember that if you are using a trolling motor mount, the information displayed is controlled by the direction the trolling motor is pointing, not necessarily the direction the boat is traveling.

To return to normal “down” operation using the Tri-beam transducer, simply change the switch setting if you are using a transducer switch, or reconnect the Tri-beam transducer. The Wide Portrait will reconfigure the screen automatically.

SPECIFICATIONS

Operating Frequency.....	200/455 kHz
Power Output (200 kHz).....	300 Watts (RMS)
.....	2400 Watts (Peak to Peak)
Power Output (455 kHz).....	300 Watts (RMS)
.....	2499 Watts (Peak to Peak)
Area of Coverage.....	90 degrees at -10 db
Power Requirement.....	10 - 16 VDC
Display.....	Super Twist LCD
LCD Matrix.....	128 x 128
Viewing Area.....	4.00" H x 3.00 V
Mounting.....	Quick Disconnect Mount
Unit Size	7 3/4" H x 7 7/8" W x 4 1/4" D
Transducer (Standard).....	XT-6-TB-90
Transducer Cable Length.....	20 feet
Depth Ranges.....	15, 30, 60, 120, 180, 240, 360, 480,
	& 600 (feet)
Zoom Ranges.....	7 1/2, 15, 30, & 60 (feet)

Free Manuals Download Website

<http://myh66.com>

<http://usermanuals.us>

<http://www.somanuals.com>

<http://www.4manuals.cc>

<http://www.manual-lib.com>

<http://www.404manual.com>

<http://www.luxmanual.com>

<http://aubethermostatmanual.com>

Golf course search by state

<http://golfingnear.com>

Email search by domain

<http://emailbydomain.com>

Auto manuals search

<http://auto.somanuals.com>

TV manuals search

<http://tv.somanuals.com>