

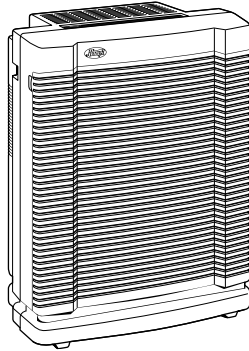

HEPAtech[™] Air Purification System



HEPAtech[™] 374 (Model 30374)

HEPAtech[™] 375 (Model 30375)

HEPAtech[™] 380 (Model 30380)

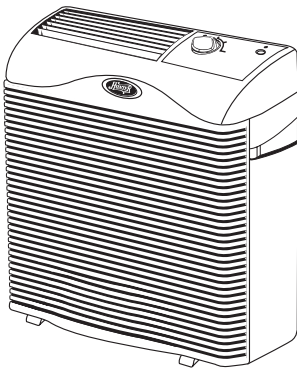

HEPAtech[™] 200 (Model 30200)

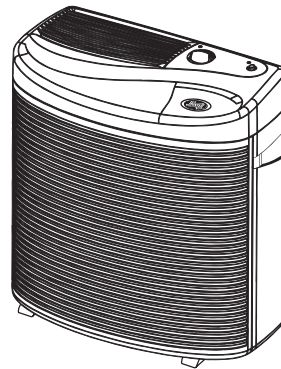

HEPAtech[™] 250 (Model 30250)

HEPAtech[™] 255 (Model 37255)

This air purifier uses Model 30930 replacement filters.

WWW.HUNTERFAN.COM

IMPORTANT SAFETY INSTRUCTIONS

READ ALL INSTRUCTIONS BEFORE USING THIS AIR PURIFIER AND SAVE THESE IMPORTANT INSTRUCTIONS

1. This Air Purifier is designed for use on a flat, level surface and may not work properly on an uneven surface. **ALWAYS** place this Air Purifier on a firm, level surface. **ALWAYS place the Air Purifier at least six (6) inches away from walls and heat sources such as stoves, radiators, or heaters.**
2. Place the Air Purifier in an area that is out of the reach of children.
3. Before using the Air Purifier, extend the cord and inspect for any signs of damage. **DO NOT** use the product if the cord has been damaged.
4. This product has a polarized plug (one blade is wider than the other) as a safety feature. This plug will fit into a polarized outlet only one way. If the plug does not fit fully into the outlet, reverse the plug. If it still does not fit, contact a qualified electrician. **DO NOT** attempt to defeat or override this safety feature.
5. **ALWAYS UNPLUG** the Air Purifier when it is not in operation, while the filter is being changed, and while it is being cleaned.
6. **DO NOT** tilt or move the Air Purifier while it is in operation. Shut off and unplug before moving.
7. **DO NOT** immerse the Air Purifier in water as permanent damage will occur. Refer to and follow the **CLEANING AND FILTER REPLACEMENT** instructions.

Introduction

Thank you for purchasing the *HEPAtech*[™] Air Purification System from Hunter Fan Company. You have purchased our latest development in portable Air Purification Systems. This system has been developed to improve the quality of the air you breathe.

Our *HEPAtech*[™] Air Purification System out performs other air purification systems by quickly and effectively removing dust, smoke, and pollen particles as small as .1 microns in size. Room air is pulled in through the front grill and cleaned across the *HEPAtech*[™] filter. Clean air is then released out the top grill in order to avoid stirring up settled particles.

Using the Ionizer

Using the ionizer improves the quality of air in the room. Negative ions are released into the air and positively charged dust, smoke, and pollen particles are attracted to the negative ions. These particles settle out of the air and can be vacuumed up during normal cleaning. These particles are also more easily captured by the *HEPAtech*[™] filter as they pass through the *HEPAtech*[™] Air Purification System. To ensure the best air circulation in the room, we recommend that you place your air purifier six inches away from any walls.

Air Purifier Features

Models 30374, 30375 and Model 30380 Electronic Key Pad Control

1. **On/Speed Control:** Press this button to turn the unit 'on'. When you press it once, the unit will be on low speed. Keep pressing the button to change speeds until you reach the speed you desire.
2. **Automatic Shut-off:** If you desire the air purifier to shut off automatically, you can set the timer. Press the timer button to choose the amount of time you would like the air purifier to run (1, 2, 4, or 8 hours). Press the button repeatedly to change the length of time.
3. **Ionizer:** Press this button to turn 'on' the ionizer. When the ionizer is 'on', the green light to the left of the button will be illuminated.
4. **Check Filter:** When the check filter light is illuminated, you should open the front grill and compare the filter to the check filter chart. If the filter is dark, you should replace the filter.
5. **Reset:** When you change the filter, press the reset button. Use the tip of a pen or pencil to press the reset button.

Models 30200, 30250 and 37255

1. **On/Speed Control:** Rotate this knob to turn the unit 'on'. The knob rotates through "Off", "Low", "Medium" and "High". Keep rotating the knob to change speeds until you reach the speed you desire. When the power is "on", the red light will be illuminated.
2. **Ionizer:** Press this button to turn 'on' the ionizer. When the ionizer is 'on', the green light near the button will be illuminated.

AIR PURIFIER PARTS

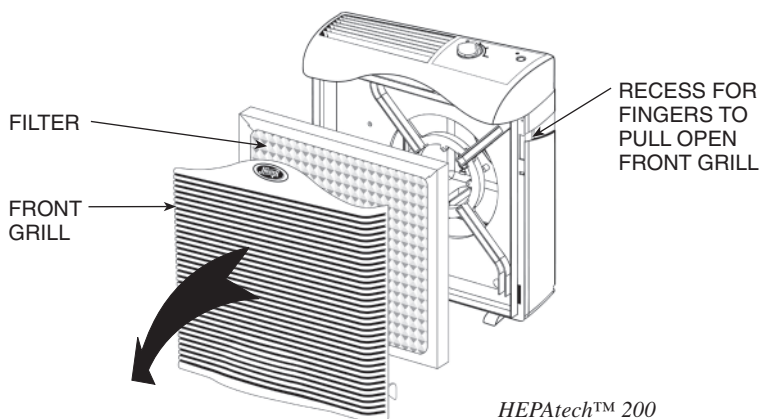

*HEPAtech™ 200
FIGURE 1A*

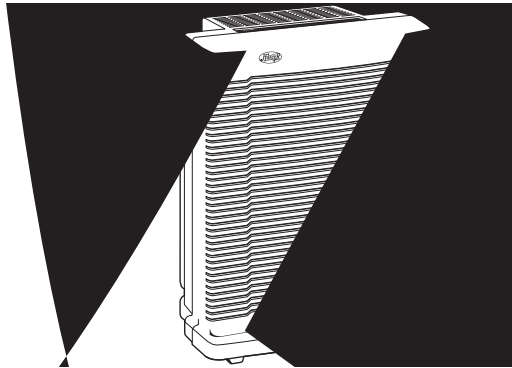
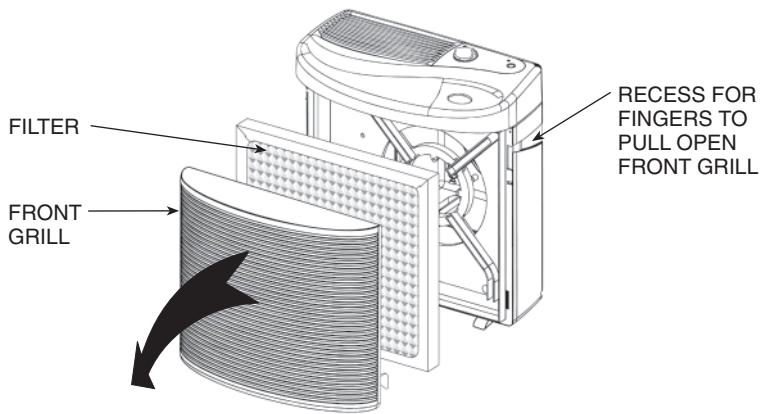

Cleaning And Filter Replacement

(Models 30380, 30374, 30375, 37255, 30250 and 30200 use Replacement Filter 30930.)

1. Clean the outside of the unit with a soft, damp cloth. The front grill can be removed and cleaned in soapy water.
2. When you remove the front grill to clean it, you should also remove the pre-filter from the front grill and gently wash it in soapy water. Washing the pre-filter can help extend the life of your *HEPAtech*[™] Filter. **Be sure that all parts are completely dry before you reassemble them to the Air Purifier.**
3. Every few weeks, you should open the front grill and view the condition of the *HEPAtech*[™] Filter. Compare the filter to the color coded chart that is on the inside of the housing. If the filter matches the dark color on the chart, you should remove the filter and replace it with a new filter. **Be sure to remove any plastic wrapping that may be on the new filter before you place it into the Air Purifier.**

Replacement Filters:

To obtain a replacement filter for your Air Purifier, call 1-800-4Hunter for your nearest retailer or Hunter Customer Service at 901-248-2222. Please be prepared to tell the operator the model number of your Air Purifier and the model number of the filter you need to replace. Models 30380, 30374, 30375, 37255, 30250 and 30200 use Model 30930 Replacement Filters.

How The *HEPAtech*™ System Works

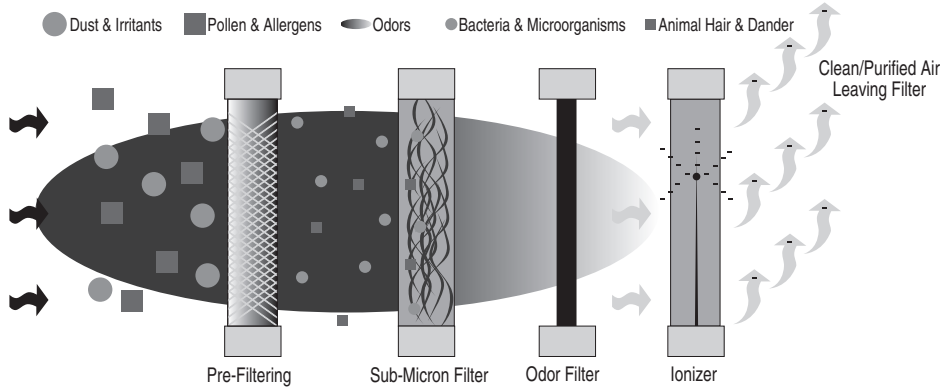

Filter. Clean/purified

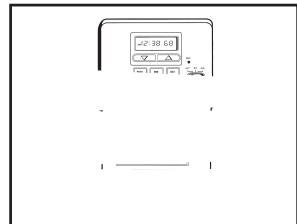
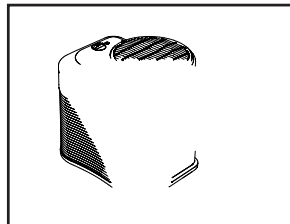
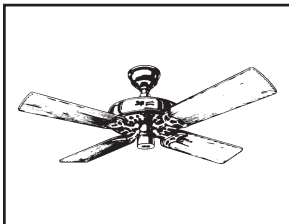

Hunter Fan Company

HEPAtech™ Air Purification System

5 YEAR LIMITED WARRANTY

The Hunter Fan Company makes the following limited warranty to the original residential user or consumer purchaser of the HEPAtch™ Air Purification System:

If any part of your HEPAtch™ Air Purification System (“Air Purifier”) motor fails during the first five (5) years from the date of installation to you due to a defect in material or workmanship, we will provide a replacement Air Purifier free of charge. Installation is deemed to occur at the date of purchase.

If the Air Purifier cord, ionizer, or front grill fails any time within one (1) year after installation due to a defect in material or workmanship, we will replace or, at our option, repair the unit free of charge at our nearest service centre or at our Service Department in Memphis, Tennessee. You will be responsible for all parts and labour costs after this one-year period.

USE OF A NON-HUNTER FILTER WILL INVALIDATE THIS WARRANTY. IF THE ORIGINAL RESIDENTIAL USER OR CONSUMER PURCHASER CEASES TO OWN THE AIR PURIFIER, THIS WARRANTY AND ANY IMPLIED WARRANTY WHICH THEN REMAINS IN EFFECT, INCLUDING BUT NOT LIMITED TO ANY IMPLIED WARRANTY OF MERCHANTABILITY OR FITNESS FOR A PARTICULAR PURPOSE, ARE VOIDED.

NO WARRANTY, EXPRESSED OR IMPLIED, INCLUDING ANY WARRANTY OF MERCHANTABILITY OR FITNESS FOR A PARTICULAR PURPOSE, IS MADE IN RESPECT TO THE FILTER MATERIAL OR CARBON FILTER.

THIS WARRANTY IS IN LIEU OF ALL OTHER EXPRESS WARRANTIES. THE DURATION OF ANY IMPLIED WARRANTY INCLUDING BUT NOT LIMITED TO ANY IMPLIED WARRANTY OF MERCHANTABILITY OR FITNESS FOR A PARTICULAR PURPOSE, IN RESPECT TO THE MOTOR IS EXPRESSLY LIMITED TO THE PERIOD OF THE EXPRESS WARRANTY SET FORTH ABOVE.

This warranty is voided if the air purifier is not purchased and used in the USA or Canada.

This warranty excludes and does not cover defects, malfunctions or failures of the Air Purifier which were caused by repairs by persons not authorized by us, use of parts or accessories not authorized by us, mishandling, modifications, or damage to the Air Purifier while in your possession, or unreasonable use, including failure to provide reasonable and necessary maintenance. This warranty does not cover Air Purifiers used in commercial applications. There are no express or implied warranties as to commercial purchasers or users.

To obtain service, contact the nearest Hunter authorized service centre or the Hunter Fan Company Service Department, 2500 Frisco Avenue, Memphis, Tennessee 38114, 901-248-2222. For the name of our nearest authorized Hunter Fan Company Service Centre, write to the Hunter Fan Company at the preceding address. You will be responsible for insurance and freight or other transportation to our factory service center. We will return the Air Purifier freight prepaid. The Air Purifier should be properly packaged to avoid damage in transit since we will not be responsible for any such damage. Proof of purchase is required when requesting warranty service. The purchaser must present sales receipt or other document that establishes proof of purchase.

IN NO EVENT SHALL HUNTER FAN COMPANY BE LIABLE FOR DIRECT, INDIRECT, SPECIAL CONSEQUENTIAL OR INCIDENTAL DAMAGES IN EXCESS OF THE PURCHASE PRICE OF THE AIR PURIFIER. YOUR SOLE REMEDY WILL BE REPAIR OR REPLACEMENT AS PROVIDED ABOVE.

SOME AMERICAN STATES AND CANADIAN PROVINCES DO NOT ALLOW:

- LIMITATIONS ON HOW LONG AN IMPLIED WARRANTY LASTS;
- THE EXCLUSION OR LIMITATION OF DIRECT, INDIRECT SPECIAL, INCIDENTAL OR CONSEQUENTIAL DAMAGES;

SO THE ABOVE LIMITATIONS MAY NOT APPLY TO YOU.

THIS WARRANTY GIVES YOU SPECIFIC LEGAL RIGHTS AND YOU MAY ALSO HAVE OTHER RIGHTS WHICH VARY FROM STATE TO STATE OR PROVINCE TO PROVINCE.



Free Manuals Download Website

<http://myh66.com>

<http://usermanuals.us>

<http://www.somanuals.com>

<http://www.4manuals.cc>

<http://www.manual-lib.com>

<http://www.404manual.com>

<http://www.luxmanual.com>

<http://aubethermostatmanual.com>

Golf course search by state

<http://golfingnear.com>

Email search by domain

<http://emailbydomain.com>

Auto manuals search

<http://auto.somanuals.com>

TV manuals search

<http://tv.somanuals.com>