

## Hardware

(Drawn to Scale)

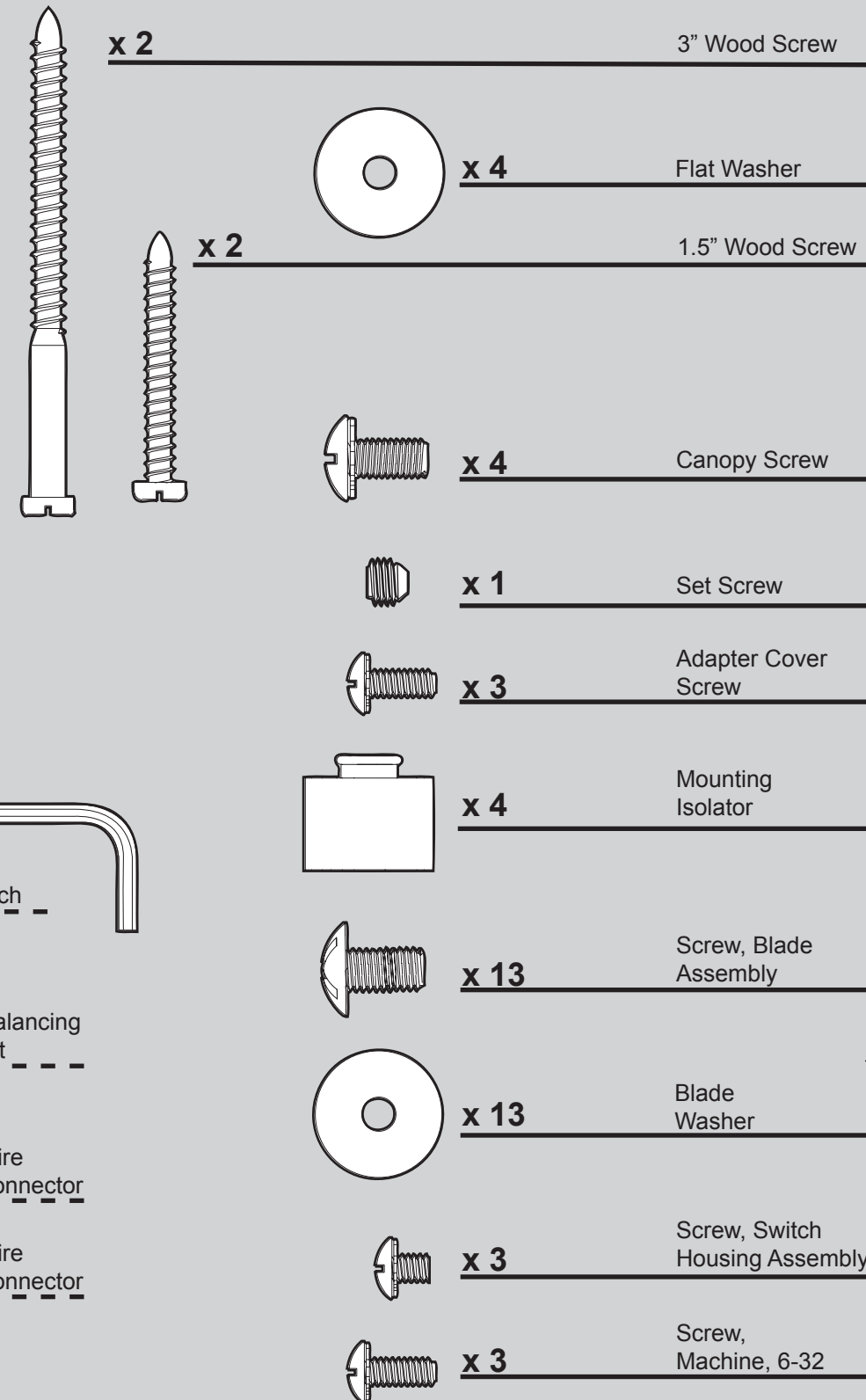

## Fan Parts

(Not Drawn to Scale)

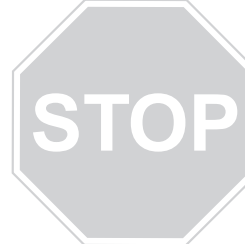
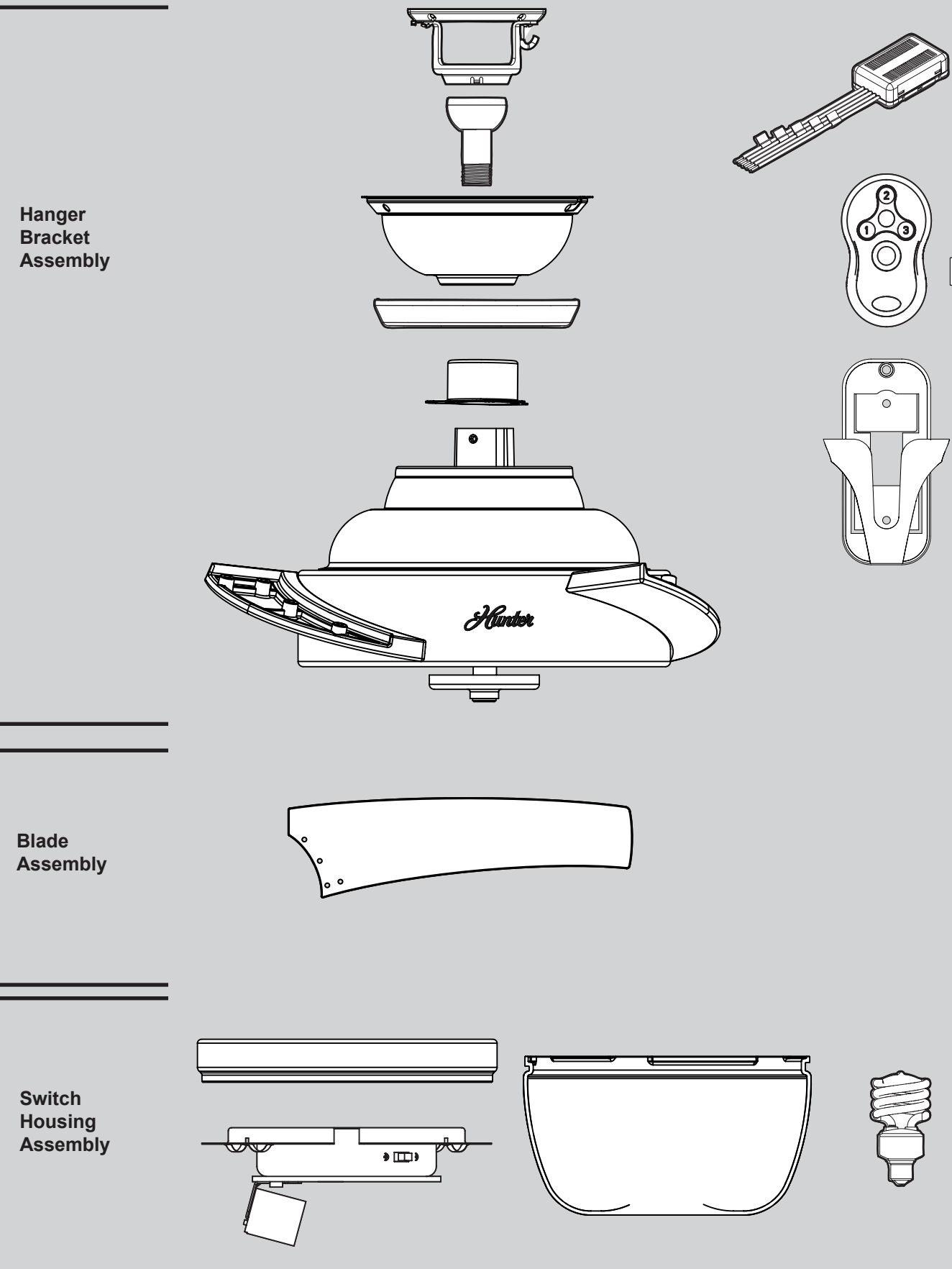

*Hunter*

Using this Parts Guide, make sure all parts are included in the box. If parts are missing, DO NOT RETURN

THIS ITEM TO THE STORE, call 888-830-1326 for assistance.

THIS PARTS GUIDE IS FOR REFERENCE ONLY. REFER TO THE INSTALLATION MANUAL FOR FULL ASSEMBLY INSTRUCTIONS.

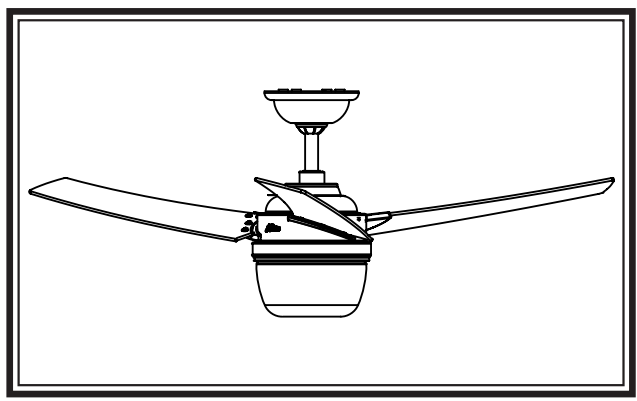

Parts List	Model #	21806	21807
	Asm. Dwg. #	99432-01	99432-02
	Finish	Brushed Nickel	Blackened Bronze
Item Name	Qty	Part #	Part #
* Hanging System Kit	1	99507-01	99507-02
Canopy			
Canopy Trim Ring			
Setscrew			
Canopy Screw			
Wood Screw 1.5"			
Wood Screw 3"			
Flat Washer			
Mounting Isolator			
Hanger Ball / Downrod Assembly	1	87942-07	87942-07
Switch Housing Assembly	1	98602-01	98602-02
Switch Housing Mounting Plate	1	88415-03	88415-03
Adapter Cover	1	76673-01	76673-01
Adapter Cover Grommet	1	74392-01	74392-01
Allen Wrench	1	64801-01	64801-01
Blade Iron Set	1	99433-03	99433-03
Blade Set	1	77325-47	77325-48
Washer, Blade Assembly	13	64977-01	64977-01
Blade Assembly Screw	13	74510-26	74510-26
Hardware Kit	1	99432-00-860	99432-00-861
Screw, Machine, 6-32			
Wire Connector			
Screw, Switch Housing Assembly			
Balancing Kit	1	65666-01	65666-01
Remote Control Receiver	1	89532-01	89532-01
Remote Control Transmitter	1	99600-01	99600-01
12 Volt Battery (23A)	1	64833-01	64833-01
Remote Control Cradle	1	G1293-01	G1293-01
Light bulb / Bulb	1	67001-01	67001-01
Globe/Shade	1	89143-01	89143-02

## Materiales

(no dibujados a escala)

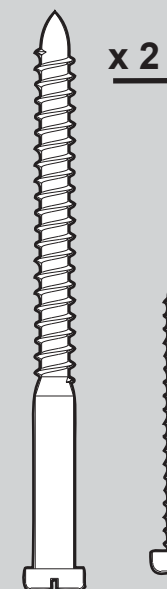

x 2

3" Tornillo, de madera

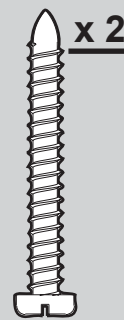

x 2

1.5" Tornillo, de madera



x 4

Arandela, plana

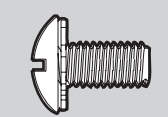

x 4

Tornillo, de campana



x 1

Tornillo prisionero

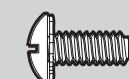

x 3

Tornillo, cubierta del adaptador

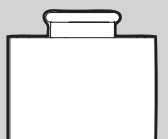

x 4

Aislador de montaje

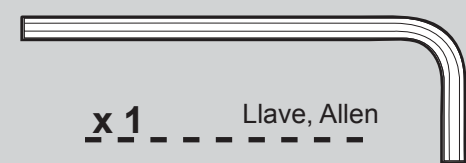

x 1

Llave, Allen



x 1

Kit de equilibrado



x 3

Empalme plástico



x 4

Empalme plástico



x 13

Arandela, paleta



x 3

Tornillo, del conjunto de la caja del interruptor

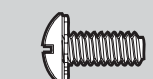

x 3

Tornillo, mecánico, 6-32

## Piezas del ventilador

(no dibujadas a escala)

Conjunto del soporte de suspensión

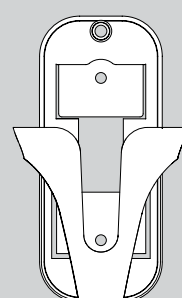
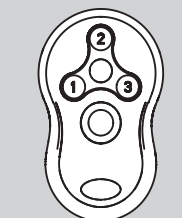
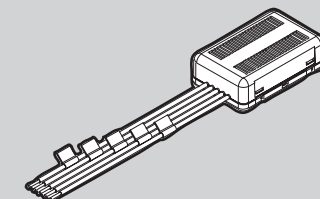
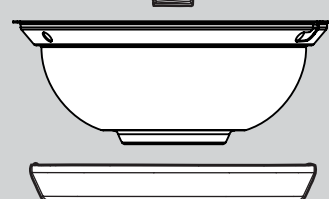
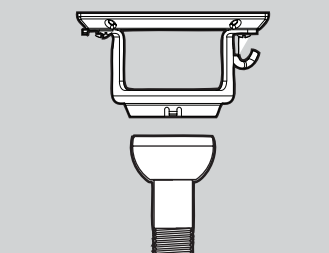

de conjunto de paleta

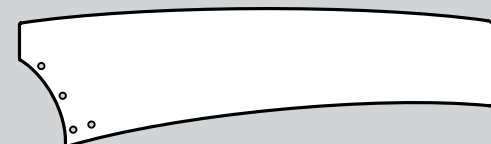

Conjunto del interruptor/ alojamiento

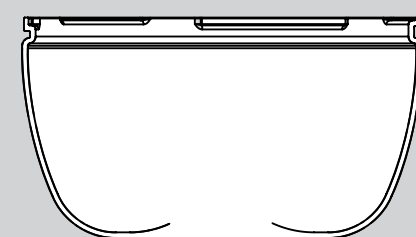
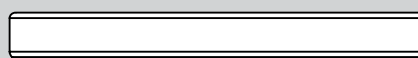

# GUÍA DE PIEZAS

## Hunter

ALTO

Consulte esta Guía de partes para asegurarse de que todas las partes estén incluidas en la caja.

Si falta alguna parte, NO DEVUELVA ESTE PRODUCTO A LA TIENDA. Solicite ayuda al 888-830-1326. ESTA GUÍA DE PARTES SOLAMENTE ES REFERENCIAL. CONSULTE LAS INSTRUCCIONES COMPLETAS DE ENSAMBLAJE EN EL MANUAL DE INSTALACIÓN

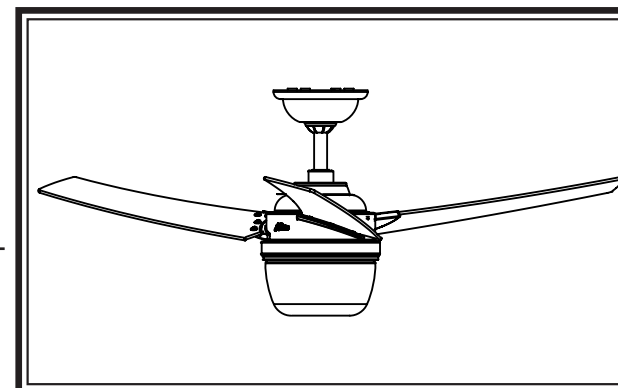

## Lista de piezas

Nombre del ítem	No. del modelo		
	21806	21807	
	No. del dibujo de ensamblaje		
	99432-01	99432-02	
	Acabado		
	Níquel Pulido	Bronce Nuevo	
	Cantidad	No. de la pieza	No. de la pieza
* Kit del sistema de suspensión	1	99507-01	99507-02
Campana			
Anillo de la moldura de campana			
Tornillo prisionero			
Tornillo, de campana			
Tornillo, de madera			
Tornillo, de madera			
Arandela, plana			
Aislador de montaje			
Bola de suspensión / Conjunto de varilla	1	87942-07	87942-07
Conjunto del interruptor	1	98602-01	98602-02
Placa de montaje de caja del interruptor	1	88415-03	88415-03
Cubierta del adaptador	1	76673-01	76673-01
Arandela de caucho de la cubierta del adaptador	1	74392-01	74392-01
Llave, Allen	1	64801-01	64801-01
Juego de soporte de paletas	1	99433-03	99433-03
Juego de paletas	1	77325-47	77325-48
Arandela, paleta	13	64977-01	64977-01
Tornillo, de conjunto de paleta	13	74510-26	74510-26
Kit de materiales	1	99432-00-860	99432-00-861
Tornillo, mecánico, 6-32			
Empalme plástico			
Tornillo, del conjunto de la caja del interruptor			
Kit de equilibrado	1	65666-01	65666-01
Receptor de control remoto	1	89532-01	89532-01
Transmisor de control remoto	1	99600-01	99600-01
Batería de 12 voltios, 23A	1	64833-01	64833-01
SopORTE de control remoto	1	G1293-01	G1293-01
Bombilla	1	67001-01	67001-01
Globo / Pantalla	1	89143-01	89143-02

## Free Manuals Download Website

<http://myh66.com>

<http://usermanuals.us>

<http://www.somanuals.com>

<http://www.4manuals.cc>

<http://www.manual-lib.com>

<http://www.404manual.com>

<http://www.luxmanual.com>

<http://aubethermostatmanual.com>

Golf course search by state

<http://golfingnear.com>

Email search by domain

<http://emailbydomain.com>

Auto manuals search

<http://auto.somanuals.com>

TV manuals search

<http://tv.somanuals.com>