

Hardware

(Drawn to Scale)

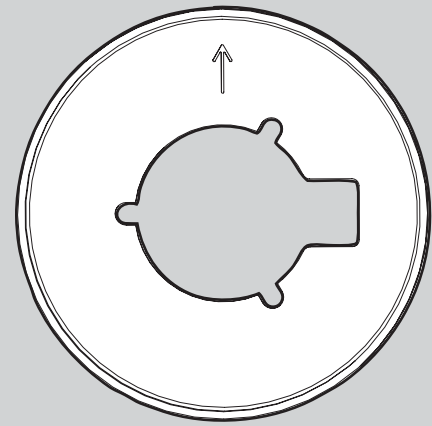

x 1

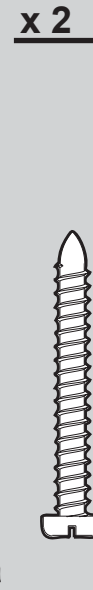

x 2

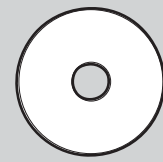

x 4

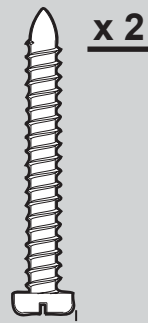

x 2

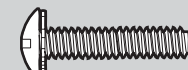

x 3

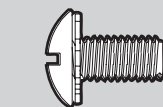

x 3

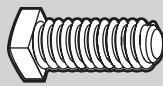

x 1

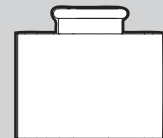

x 4



x 11

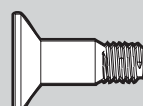

x 16

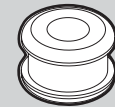

x 16



x 1



x 4

- Low Profile Washer
- 3" Wood Screw
- Flat Washer
- 1.5" Wood Screw
- Locking Screw
- Canopy Screw
- Set Screw
- Mounting Isolator
- Screw, Blade Iron Armature
- Screw, Blade Assembly
- Blade Grommet
- Screw, Switch Housing Assembly
- Screw, Machine, 6-32

Fan Parts

(Not Drawn to Scale)

Hanger Bracket Assembly

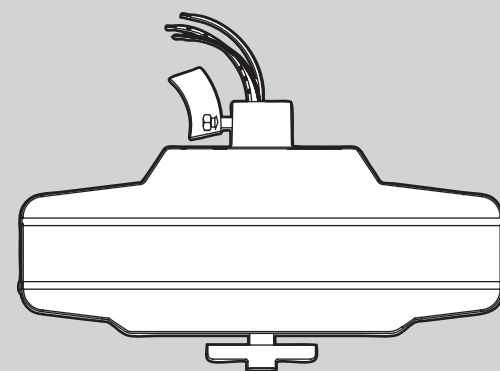
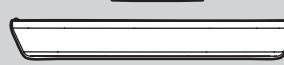
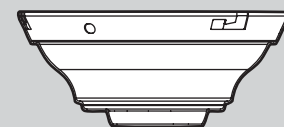

Blade Assembly

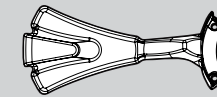

Switch Housing Assembly

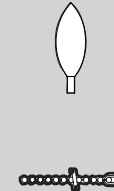
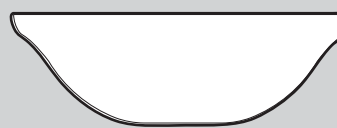
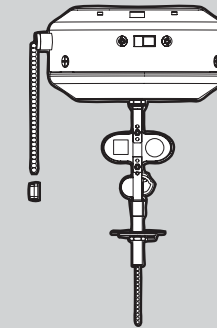

Hunter

Using this Parts Guide, make sure all parts are included in the box.
If parts are missing, DO NOT RETURN

THIS ITEM TO THE STORE, call 888-830-1326 for assistance.

THIS PARTS GUIDE IS FOR REFERENCE ONLY.

REFER TO THE INSTALLATION MANUAL FOR FULL ASSEMBLY INSTRUCTIONS.

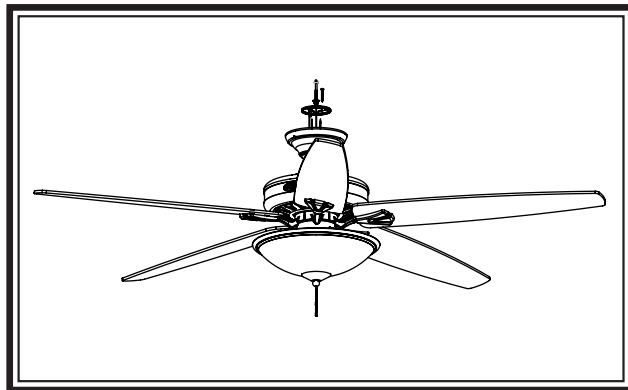

Parts List

Item Name	Qty	Part #
	Hanging System Kit	1
Ceiling Plate		
Canopy		
Canopy Trim Ring		
Hanger Ball / Downrod Assembly		
Setscrew		
Low Profile Washer		
Canopy Screw		
Wood Screw		
Flat Washer		
Mounting Isolator		
Screw, Low Profile		
Switch Housing Assembly	1	99001-30
Blade Iron Set	1	97276-05
Blade Set	1	76238-72
Hardware Kit	1	98295-00-860
Screw, Blade Iron Armature		
Blade Assembly Screw		
Screw, Machine, 6-32		
Wire Connector		
Screw, Switch Housing Assembly		
Balancing Kit	1	07570-01
Pull Chain	1	63756-15
Pull Chain	1	63756-16
Bottom Cap	1	73697-06
Finial	1	07613-02
Globe/Shade	1	84669-02
Light bulb / Bulb	2	77646-04
Dummy Terminal, Female	1	08200-01
Dummy Terminal, Male	1	08198-01

Materiales

(no dibujados a escala)

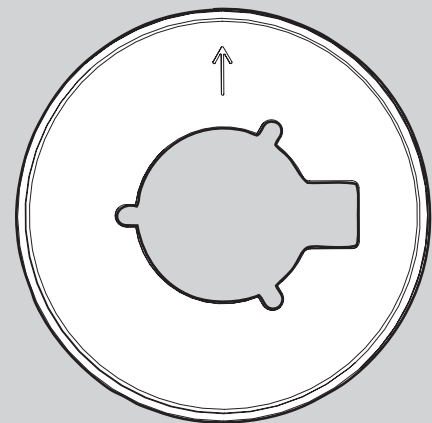

x 1

Roseta de perfil bajo

x 2



3" Tornillo, de madera

x 2

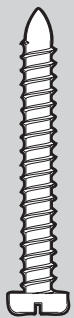

1.5" Tornillo, de madera

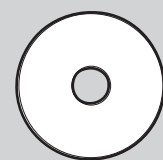

x 4

Arandela, plana



x 3

Tornillo de fijación

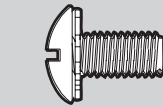

x 3

Tornillo, de campana

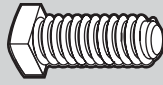

x 1

Tornillo prisionero

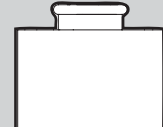

x 4

Aislador de montaje



x 11

Tornillo, de armadura de soporte de paleta

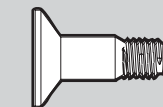

x 16

Tornillo, de conjunto de paleta



x 16

Arandela de caucho, de paleta



x 1

Kit de equilibrado



x 4

Empalme plástico

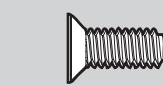

x 3

Tornillo, del conjunto de la caja del interruptor



x 3

Tornillo, mecánico, 6-32

Piezas del ventilador

(no dibujadas a escala)

Conjunto del soporte de suspensión

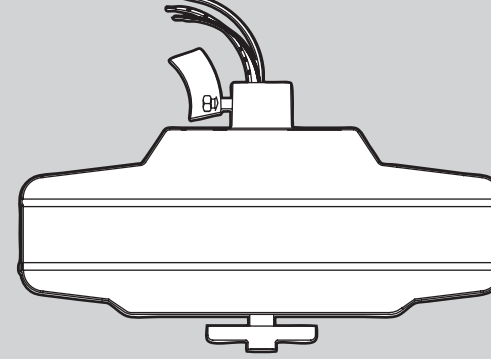
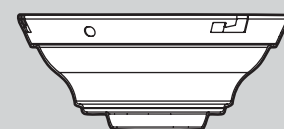
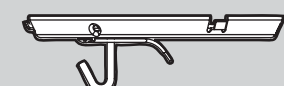

de conjunto de paleta

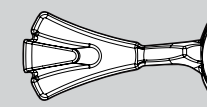

Conjunto del interruptor/ alojamiento

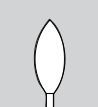
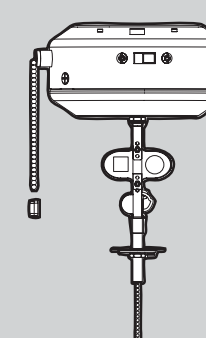

PARADA

Hunter

Consulte esta Guía de partes para asegurarse de que todas las partes estén incluidas en la caja.

Si falta alguna parte, NO DEVUELVA ESTE PRODUCTO A LA TIENDA. Solicite ayuda al 888-830-1326. ESTA GUÍA DE PARTES SOLAMENTE ES REFERENCIAL. CONSULTE LAS INSTRUCCIONES COMPLETAS DE ENSAMBLAJE EN EL MANUAL DE INSTALACIÓN

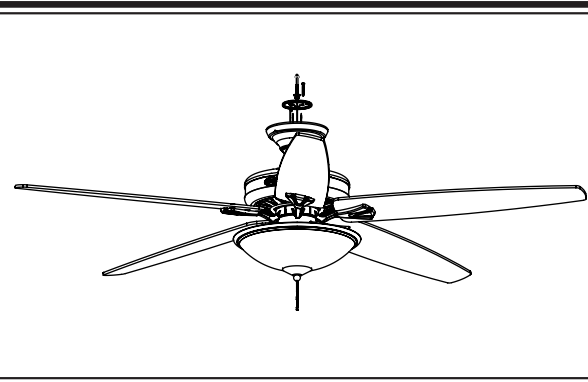

Lista de piezas

Nombre del ítem	No. del modelo 23963	
	No. del dibujo de ensamblaje	98295-01
	Acabado	Bronce nuevo
	Cantidad	No. de la pieza
Kit del sistema de suspensión	1	94945-30
Placa de techo		
Campana		
Anillo de la moldura de campana		
Bola de suspensión / Conjunto de varilla		
Tornillo prisionero		
Roseta de perfil bajo		
Tornillo, de campana		
Tornillo, de madera		
Arandela, plana		
Aislador de montaje		
Tornillo, de roseta de perfil bajo		
Conjunto del interruptor	1	99001-30
Juego de soporte de paletas	1	97276-05
Juego de paletas	1	76238-72
Kit de materiales	1	98295-00-860
Tornillo, de armadura de soporte de paleta		
Tornillo, de conjunto de paleta		
Tornillo, mecánico, 6-32		
Empalme plástico		
Tornillo, del conjunto de la caja del interruptor		
Kit de equilibrado	1	07570-01
Tirador de cadena	1	63756-15
Tirador de cadena	1	63756-16
Tope inferior	1	73697-06
Cubierta ornamental	1	07613-02
Globo / Pantalla	1	84669-02
Bombilla	2	77646-04
Terminal simulado, hembra	1	08200-01
Terminal simulado, macho	1	08198-01

Free Manuals Download Website

<http://myh66.com>

<http://usermanuals.us>

<http://www.somanuals.com>

<http://www.4manuals.cc>

<http://www.manual-lib.com>

<http://www.404manual.com>

<http://www.luxmanual.com>

<http://aubethermostatmanual.com>

Golf course search by state

<http://golfingnear.com>

Email search by domain

<http://emailbydomain.com>

Auto manuals search

<http://auto.somanuals.com>

TV manuals search

<http://tv.somanuals.com>