



## Table of Contents

---

Congratulations!

Welcome to the Hunter energy saving family of quality products.

Your Hunter Programmable Thermostat allows you to find your maximum comfort level using the least amount of fuel. Through smart programming, this thermostat should pay for itself during its first season of use.

Thank you for buying Hunter products!

Features	6
Installation	8
Setting Clock/Programming	14
Personal Program Schedule	25
Manual Override	27
Temperature Span	29
Energy Monitor	29
Energy Usage Chart	32
Trouble Shooting Guide	33
Wiring Diagrams	34

Hunter Customer Service Hotline  
901/745-9222

# Read This First Before Installing Thermostat

4-5

**1** Read the entire installation section (1) of this Owner's Manual thoroughly before you begin to install or operate your Hunter Thermostat.

**2** All installation is normally performed at your thermostat.

**3** You can practice programming before installing your thermostat by inserting and connecting the batteries as shown on page 13, and following the instructions on page 14 onward. This can be done while you relax in your favorite chair, and is a very good way to familiarize yourself with all the functions of your Hunter Thermostat

**4** Your Hunter Thermostat is designed to operate with most gas, oil, electric or forced hot water heating and air conditioning systems having 24-volt controls and relay currents

Such systems represent the great majority of residential central heating and air conditioning units in use in the United States.

Some other systems, which are not directly compatible with electronic set back thermostats, may be made to work with your Hunter Thermostat using the Hunter Isolation Relay Model

Use of the isolation relay will normally allow the Hunter Thermostat to control millivolt systems, computer controlled systems, and high voltage electric baseboard or strip heaters. For some of these systems you will also need an additional 24-volt transformer. Full instructions are included in the Isolation relay package. This Hunter Thermostat will not control multi-stage heating or cooling systems.

**5** A built-in timer prevents damage to your air conditioner compressor, caused by rapid cycling, by providing a delay of 4 minutes before it will restart.

**6** Your thermostat can be programmed between 40° and 90° F. However, it will display room temperatures from 32° F to 99° F.

**7** Whenever the main power is interrupted or fails; the battery power is used to retain the programs and current time.

**8** When the batteries are low, the entire display will flash. If this happens install new, fresh batteries (do not use old batteries) as soon as

possible. In order to retain your old program, replace batteries one by one. First, remove one of the old batteries from the thermostat and replace with the new one. Next, replace the other battery.

**If the batteries are not replaced, the display will get dim and your heating and cooling system will stop operating.**

If you have questions concerning the installation or programming of the Thermostat, call us at 901-745-9222 from 8 AM to 5 PM Central Time.

# Features

Manual switch for turning on heating and cooling system.

Simplified programming instructions are provided on inside of door cover for easy reference.

Reset button for resetting computer back to 12:00 A.M. and clearing all programs.

Manual switch for automatic or continuous fan operation.



Display indicates time, day, temperature, PM, program number, hold and usage indicator.

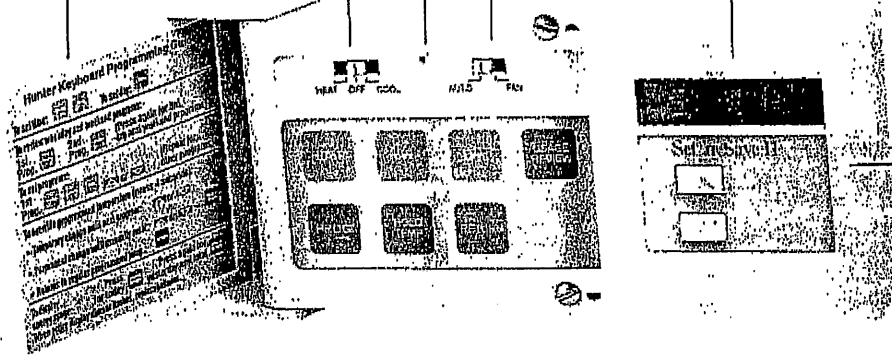

Individual pushbuttons for raising or lowering temperature settings.

For entering minute of day.

For entering hour of day.

For Reviewing or entering Weekday and Weekend program cycles.

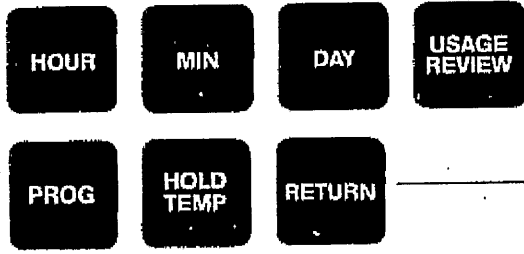

For entering day of week.

Energy Monitor key recalls energy usage today, yesterday and total. LCD shows energy usage in hours and minutes.



Returns display to current time and temperature. Also, if held for 4 seconds, clears manual override.

Provides permanent temperature setting by overriding stored programs, or converts to manual operation of thermostat.

■ Batteries retain programs during power failure.

■ Fingertip programming-easy touch keyboard for entering program and displaying time and temperature setting, and energy usages.



Your Hunter Thermostat comes with two #8 slotted screws and two wall anchors for mounting. To install your unit, you should have the following tools & materials.

- Slotted screwdriver
- Electric drill and  $\frac{1}{16}$ " bit
- Hammer
- Two 1.5V (AA size) Alkaline batteries

*Your Hunter Energy Monitor requires two 1.5 volt batteries to power the thermostat. It is essential that you replace the batteries whenever the entire display flashes or appears dim. If you do not, the thermostat will quit controlling your system.*

## Remove Old Thermostat

**CAUTION:** Do not remove any wiring from existing thermostat before reading the instructions carefully.

Wires must be labeled prior to removal.

- 1 Turn your existing thermostat to OFF position. Turn off the power to the furnace at the main power panel to avoid electrical shock.

**IGNORE THE COLOR OF THE WIRES** since these do not always comply with the standard. The number of wires in your system can be as few as two (for heat only systems), as many as eight, or any number in between. If you follow the labeling procedures correctly, you don't have to be concerned about how many wires there are. There is often no terminal marking on the existing

- 2 Remove existing thermostat cover and thermostat. Some thermostats will have screws or other locking devices that must first be removed. Once wall is exposed, look for wires.

If wires are not visible, they may be connected to the back of wallplate. Again, look for screws, tabs, etc. Some models have doors that open to expose wires and mounting screws (see Figure 1).

- 3 Each wire coming from the wall to the existing thermostat is connected to a terminal point on that thermostat. Each of these terminal points is usually marked with a code letter as shown in Table A. Before disconnecting any wires, apply the self adhesive labels provided to the wire as shown in Table A. (For example, attach the label marked W WHITE to the wire which goes to the W or H terminal on your existing thermostat.)

thermostat of two wire, heat only systems. Don't worry, just connect either of the wires to the "RED" terminal on your Thermostat then connect the other wire to the "WHITE" terminal on your Energy Monitor to complete the circuit.

- 4 After labeling wires, disconnect them from the existing thermostat terminals.

- 5 Remove existing wallplate. To make sure wires do not fall back into wall opening, you may want to tape them to the wall.

- 6 If hole in wall is larger than necessary for wires, seal this hole up, so that no hot or cold air can enter the back of the thermostat from the wall. This air could cause a false thermostat reading.

TYPICAL HOME THERMOSTATS

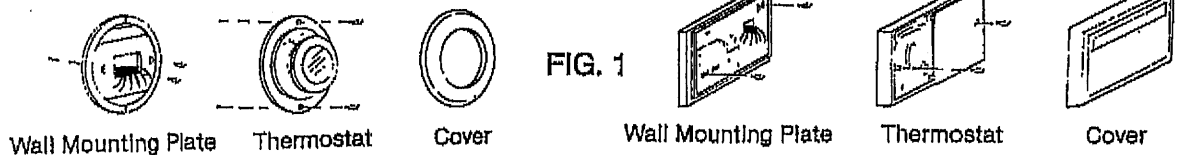



## Wire Labeling

This table will help you match the labels to the wires so you can attach them to your Hunter Thermostat

If the code letter on your existing thermostat is	then mark wire with label shown	and connect to thermostat Terminal shown
RH, RC, R, M, VR, VC or 4 24 Volt		RED
G or F Fan		GREEN
Y or C Air Conditioning		YELLOW
W or H Heating		WHITE

TABLE A

### NOTE: 5-Wire Systems

If your existing thermostat has separate wires going to terminals marked "R" and "RH," simply connect both these wires to terminal marked "RED" on your

Thermostat. Connect only the wires that were connected to your old thermostat to your new Thermostat.

## Mount Thermostat Wallplate

Detach the wallplate from your thermostat by removing the two screws located above and below the keyboard.

Reposition wallplate to wall, pulling wires through large opening, insert mounting screws provided into wall anchor and tighten.

Position wallplate on wall and pull existing wires through large opening. Then level for appearance. Mark holes for plastic anchors provided if existing holes do not line up with thermostat holes. (Figure 2)

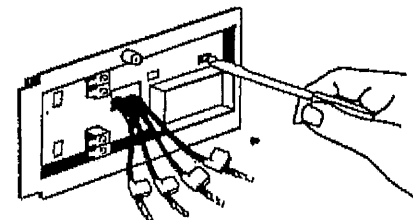

(Figure 2)

Drill holes with  $\frac{3}{16}$ " bit, and gently tap anchors into the holes until flush with wall.



## Heating System Selector

The heating system selector is the orange jumper wire on the Printed Circuit Board that is connected to the terminal marked "HG." Leave it in this position if you have a gas furnace or oil burner.

If you have an electric furnace, check to see if the heat comes on when called for, and that the blower fan will also come on. If either does not, then change the orange wire to the "HE" position. If the

heat and fan come on normally as expected, then leave the orange wire in the "HG" position. The system selector has no effect in the cooling mode.

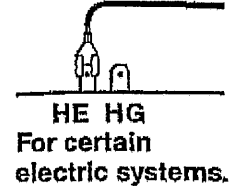
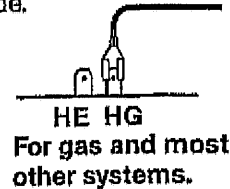

## Connect Wires and Mount Thermostat Cover

**1** Match and connect the labeled wires to the appropriate coded terminal screws on the mounting plate (Figure 4). Ignore any wires which may be present, but which were not connected to

thermostat wire onto the appropriate spade terminals on the mounting plate (Figure 3). Match letter codes to wire colors (Figure 4). Connect battery lead connectors (Figure 5).

your old thermostat. Do not connect these to your Thermostat

**2** Push excess wire back into hole to prevent interference with mounting of Thermostat cover.

**3** Insert both the batteries into your Energy Monitor as shown in Figure 5, observing the polarity marked on the unit.

**4** Make sure the HEAT-OFF-COOL switch is in OFF position and FAN-AUTO switch is in AUTO position. Push all the connectors at the end of each

**5** Line up the Thermostat cover with wallplate, insert faceplate screws and tighten.

**6** Switch on the main power. Press the reset button to reset and start the clock. Use a thin probe such as a straightened paper clip to gently push the reset button through the hole in the front panel (Figure 6). The LCD display should read 12:00 MO and indicate the current room temperature of your house. **If it shows random numbers, or partial digits, press the reset button once again.**

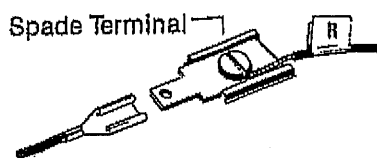

Figure 3

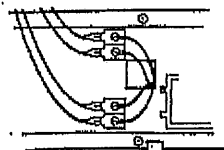

Figure 4

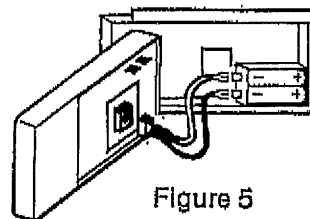

Figure 5

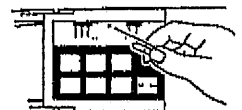

Figure 6

- 1 The PM indicator will appear between 12:00 noon and 11:59 p.m. There is no AM indicator.
- 2 When the heating or cooling system is actually operating, the temperature digits will flash.
- 3 If power is interrupted the batteries will retain all programs.
- 4 If the entire display flashes, replace the batteries.

## Setting the Time and Day of Week

When you first install the two AA size batteries, the thermostat automatically sets the day and time to Monday, 12:00 a.m., shows the current room temperature and is programmed for 68° in heat mode and 78° in cool mode.

The first data you should enter is the current time and day of week. As the keys are pressed, the display will show the data being entered.

**EXAMPLE:**  
If the unit is being installed at 9:15 p.m., Saturday, to set the thermostat, you would press the keys in the shown sequence:

		<ul style="list-style-type: none"> <li>■ Initial read-out after pressing reset button.</li> <li>■ Current room temperature is 72°.</li> <li>■ No indication of program number.</li> </ul>
<b>HOUR</b>		<ul style="list-style-type: none"> <li>■ Press once. Temperature digits disappear, indicating time set mode.</li> </ul>
<b>HOUR</b>		<ul style="list-style-type: none"> <li>■ Press and hold until 9:00 p.m. appears on display.</li> </ul>
<b>MIN</b>		<ul style="list-style-type: none"> <li>■ Press and hold until 15 minutes appears on display.</li> </ul>
<b>DAY</b>		<ul style="list-style-type: none"> <li>■ Press 5 times until Saturday appears on display.</li> </ul>
<b>RETURN</b>		<ul style="list-style-type: none"> <li>■ Returns to normal time and temperature.</li> <li>■ If return is not pressed it will return automatically in 10 seconds.</li> </ul>



## Typical Suggested Summer and Winter Programs

Studies conducted by the Department of Energy estimate that setting your thermostat back 10°F for two 8-hour periods during winter can reduce your fuel bill by as much as 35%. By setting your thermostat up 5° for two 8-hour periods during summer you can reduce your fuel bill up to 25%.

Your thermostat is capable of holding up to 4 programs for weekdays and 2 programs for weekends.

Suggested winter and summer weekday and weekend programs are shown at the right.

### Weekday Program (Mon.-Fri.)

		Summer	Winter
Weekday Program 1	6:00 AM	78° F	68° F
Weekday Program 2	8:30 AM	84° F	60° F
Weekday Program 3	3:00 PM	78° F	68° F
Weekday Program 4	11:00 PM	80° F	58° F

**NOTE:** The thermostat program will NOT take effect immediately after programming of your thermostat but at the next programmed time/ temperature change. The thermostat is pre-set to 68°F for heat and 78°F for air conditioning. So if you want a temperature other than 68°F or 78°F right away, use the manual override feature (described on page 27) to enter your desired temperature setting.

When your program becomes effective at the next time/temperature setting, the appropriate corresponding program number will appear on the display.

### Weekend Program (Sat.-Sun.)

		Summer	Winter
Weekend Program 1	7:00 AM	78° F	68° F
Weekend Program 2	11:00 PM	80° F	58° F

## Programming Your Thermostat

Familiarize yourself with programming. In this example your thermostat will be programmed for winter as per suggested program on pages 16 and 17.

NOTE: 1) The program time is set in increments of 15 minutes.  
 2) The program temperature is set in increments of 1°F.  
 3) When setting PM time, make sure the "PM" indicator appears on the display.

### Weekday Programs

		<ul style="list-style-type: none"> <li>Normal display of time, temperature, and day of week.</li> </ul>
<b>PROG</b>		<ul style="list-style-type: none"> <li>Program Indicator (1) is displayed.</li> <li>68°F is displayed.</li> <li>0:00 space for time is displayed.</li> <li>Mo-Fr is displayed.</li> </ul>
<b>HOUR</b>		<ul style="list-style-type: none"> <li>Press and hold until 6:00 is displayed.</li> <li>Weekday Program 1 is complete.</li> </ul>
<b>PROG</b>		<ul style="list-style-type: none"> <li>Program indicator (2) is displayed.</li> <li>Space for time of second program is displayed.</li> </ul>
<b>HOUR</b>		<ul style="list-style-type: none"> <li>Press and hold until 8:00 is displayed.</li> </ul>
<b>MIN</b>		<ul style="list-style-type: none"> <li>Clock advances in increments of 15 minutes.</li> </ul>
		<ul style="list-style-type: none"> <li>Pressing  each time decreases one degree</li> <li>When you reach 60°F, Program 2 is complete.</li> </ul>
<b>PROG</b>		<ul style="list-style-type: none"> <li>Program Indicator (3) is displayed.</li> </ul>
<b>HOUR</b>		<ul style="list-style-type: none"> <li>Press and hold until 3:00 p.m. is displayed.</li> <li>Weekday Program 3 is complete.</li> </ul>

## Programming Your Thermostat (Cont.)

<b>PROG</b>		■ Program indicator (4) is displayed.
<b>HOUR</b>		■ Press and hold until 11:00 p.m. is displayed.
		■ Pressing  each time decreases one degree. ■ When you reach 58°F, Program 4 is complete.
<b>PROG</b>		■ SA and SU displayed. ■ Program indicator (1) is displayed.
<b>HOUR</b>		■ Press and hold until 7:00 a.m. is displayed. ■ Weekend Program 1 is now complete.
<b>PROG</b>		■ Program indicator (2) is displayed.
<b>HOUR</b>		■ Press and hold until 11:00 p.m. is displayed.
		■ Pressing  each time decreases one degree. ■ When you reach 58°F, Weekend Program 2 is complete.
<b>RETURN</b>		■ Press to return to display current time, temperature and day of week. If it is not pressed, thermostat will automatically return to current time and temperature in 10 seconds.

Continue For Weekend Programs

Now slide "Heat/Off/Cool" switch to "Heat."

NOTE: If program time is left at 0:00, that particular program will not be effective; e.g., if Program #2 has time 0:00, the thermostat will jump from Program #1 to Program #3.

## Displaying Programs

You may want to review the programs to see that the settings are compatible with your lifestyle.

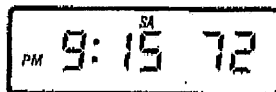

- Normal display of current time, temperature, day of week.

### Weekday Program



- 1st Weekday program is displayed.
- Program indicator (1) appears.
- Monday through Friday indication appears.



- 2nd Weekday program is displayed.
- Program indicator (2) appears.
- Monday through Friday remains.



- 3rd Weekday program is displayed.
- Program indicator (3) appears.
- Monday through Friday remains.



- 4th Weekday program is displayed.
- Program indicator (4) appears.
- Monday through Friday remains.

### Weekend Program



- 1st Weekend program is displayed.
- Program indicator (1) appears.
- Saturday and Sunday indications appear.



- 2nd Weekend program is displayed.
- Program indication (2) appears.

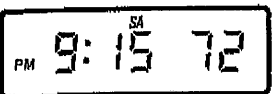

- Press to return to display current time, temperature, day of week. If it is not pressed, thermostat will automatically return to display of current time, temperature and day of week in about 10 seconds.

**NOTE:** The temperatures you have entered will NOT take effect immediately, but at the next program time change. The Energy Monitor is pre-set to 68°F in heat mode and 78°F in cool mode. If you want a temperature other than 68°F or 78°F right away,

you must use the manual override feature described on page 26 to enter the temperature you want.

When your entered program becomes effective, corresponding program number will appear on display.

After programming, confirm the new programs by pressing **PROG** **PROG** **RET**.

## Personal Program Schedule

Before programming or changing the program, use this thermostat Personal Program Schedule to determine which times and temperature settings

will best satisfy both your comfort and energy saving requirements. Use a pencil so you can revise your records each time you change your temperature settings.

Beginning Program Date			
WINTER PROGRAM			
WEEKDAYS	TIME	AM/PM	TEMP.
PROGRAM 1			
PROGRAM 2			
PROGRAM 3			
PROGRAM 4			
WEEKEND			
PROGRAM 1			
PROGRAM 2			

Beginning Program Date			
SUMMER PROGRAM			
WEEKDAYS	TIME	AM/PM	TEMP.
PROGRAM 1			
PROGRAM 2			
PROGRAM 3			
PROGRAM 4			
WEEKEND			
PROGRAM 1			
PROGRAM 2			

## To Review The Current Temperature Setting:

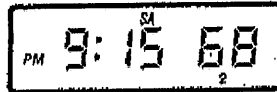

■ Current time and temperature.

Press for  
2 seconds  
or less:



- 70 indicates the current setting of the thermostat is 70°F, 68 shows the present room temperature as 68°F.
- If held for more than 2 seconds, you will manually override your present temperature to a new setting as explained below.

## Manual Override of Program

Press & hold  to raise temperature.

Press & hold  to lower temperature.

### Temporary Manual Override



In the following example, the present room temperature is 60°F and we want to raise the temperature to 70°F temporarily until the next program.

■ Press arrow to display current set and room temperatures.



■ Continue pressing arrow. After 2 seconds, the set temperature digits will blink and begin to increase until the button is released at the desired setting (in this case 70°F).

■ Program number disappears.

■ Press return or in 10 seconds it will return to showing current time and temperature.

■ To display a manual override setting, press either arrow for less than 2 seconds.

■ When arrow is released, the display will show current time and temperature.

■ Your thermostat is now in manual override mode to 70° until the next program change. Please note the program indicator number has disappeared until the next program time comes into effect.

## Permanent Manual Override



In the event you wish to hold your manual override for vacation or just an extended period of time, follow the temporary manual override instructions above, then **immediately** press HOLD TEMP . This will maintain override setting indefinitely. "HOLD" will appear on the display.

## To Return To Program\*

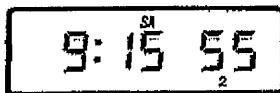

To return immediately to the current program, press and hold for 4 seconds. Program number will appear. "HOLD" will disappear if you were in permanent manual override.

(\*From temporary or permanent manual override state)

# Other Features

## Temperature Span

Your thermostat is pre-programmed at the factory to cycle when the temperature rises 2° above or 1°

below the temperature setting. It cannot be changed.

## The Energy Monitor

The Energy Monitor measures and stores the amount of time the heating and air-conditioning system operates. By pressing the key sequence shown, the usage can be displayed for the present

day, the previous day, and the total. By monitoring on a daily basis, you can gradually adjust winter or summer temperature settings and monitor the effect of your energy conserving efforts.

## Using The Energy Monitor



■ Normal display of current time and room temperature on Saturday.



■ Press USAGE REVIEW to display amount of time system has run today (Saturday 12:01 a.m. through present time).



■ Press again to display amount of time system ran yesterday (Friday 12:01 a.m. through midnight).

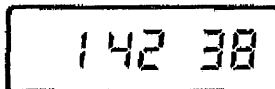

■ Press again to display total usage in hours and minutes since usage counter was set to zero. (See note below.)

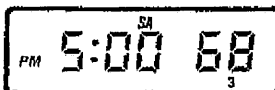

■ Returns to normal time and temperature.  
 ■ Auto return after 10 seconds if no key is pressed.

**NOTE:** After 999.99 hours of usage the Energy Monitor will restart from zero.

## Resetting Energy Monitor

To reset the usage Energy Monitor back to zero, simply press and hold the USAGE button for 4 seconds.



■ All usage monitors set to zero.

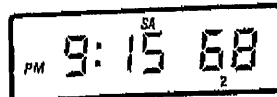

■ Return to normal time and temperature.



## Energy Usage Chart

The Hunter Thermostat Thermostat measures, stores and displays the amount of time your heating or air conditioning system has operated the present day, and the previous day.

This Energy Usage Chart will help you discover your most efficient energy saving comfort zone by recording your energy usage on a daily or weekly basis.

Simply enter the daily hours displayed when you press the orange Usage Review key. 

Date Begin: Month	Day						Year	TOTAL
	MON	TUES	WED	THURS	FRI	SAT		
WEEK 1								
WEEK 2								
WEEK 3								
WEEK 4								
WEEK 5								
WEEK 6								
WEEK 7								
WEEK 8								
WEEK 9								
WEEK 10								
WEEK 11								
WEEK 12								

### Problem

### Solution

No Display

1. Check battery connections and batteries.
2. Press reset button once with a small pin and hold in for two seconds.

Entire Display Dims or Flashes Rapidly On and Off

1. Replace batteries.

Program Does Not Change at Your Desired Setting

1. Check that time is set properly to "AM" or "PM".
2. Check that thermostat is not in "HOLD" mode.
3. Check for correct day setting.

Heating or Cooling Does Not Go On or Off

1. Check that function switch is in correct position ("HEAT" or "COOL").
2. There may be as much as 10 seconds delay in the thermostat turning the system on—wait and check.
3. Check your circuit breakers and switches to ensure that there is power to the system.
4. Replace batteries.

Erratic Display

1. Press the reset button once with a small pin and hold in for two seconds. Then reprogram.

If you experience any other problems, call 901-745-9222 from 8 a.m. to 5 p.m. Central time.

## Hunter Thermostat

Typical 4-wire system.

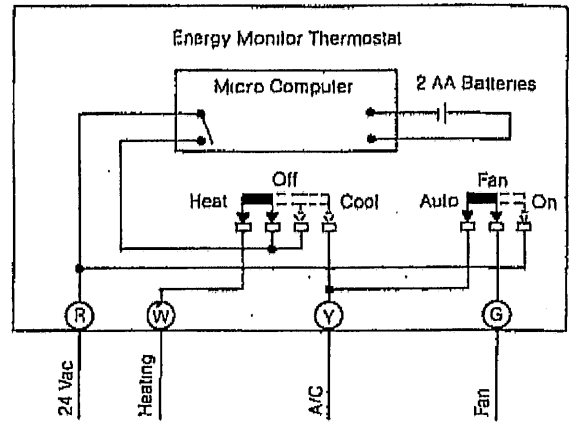

© 1994, Hunter Fan Company Form No. 40943A Rev.6/94



## Free Manuals Download Website

<http://myh66.com>

<http://usermanuals.us>

<http://www.somanuals.com>

<http://www.4manuals.cc>

<http://www.manual-lib.com>

<http://www.404manual.com>

<http://www.luxmanual.com>

<http://aubethermostatmanual.com>

Golf course search by state

<http://golfingnear.com>

Email search by domain

<http://emailbydomain.com>

Auto manuals search

<http://auto.somanuals.com>

TV manuals search

<http://tv.somanuals.com>