

# Compact AV System

---

Operating Instructions



## DAV-S500

# WARNING

**To prevent fire or shock hazard, do not expose the unit to rain or moisture.**

Do not install the appliance in a confined space, such as a bookcase or built-in cabinet.

To prevent fire, do not Cover the ventilation of the apparatus with news papers, table-cloths, curtains, etc. And don't place lighted candles on the apparatus.

To prevent fire or shock hazard, do not place objects filled with liquids, such as vases, on the apparatus.

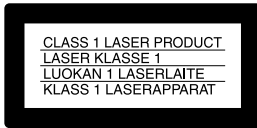

This appliance is classified as a CLASS 1 LASER product. The CLASS 1 LASER PRODUCT MARKING is located on the rear exterior.



This label is located on the Laser protective housing inside the enclosure.  
(Only for European and Russian models)



Don't throw a battery, dispose it as the injurious wastes.

## For the customers in the U.S.A

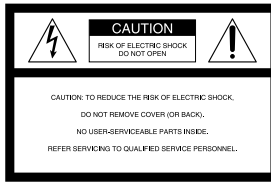

This symbol is intended to alert the user to the presence of uninsulated "dangerous voltage"

within the product's enclosure that may be of sufficient magnitude to constitute a risk of electric shock to persons.



This symbol is intended to alert the user to the presence of important operating and

maintenance (servicing) instructions in the literature accompanying the appliance.

### Owner's Record

The model and serial numbers are located at the rear of the unit.  
Record the serial number in the space provided below. Refer to them whenever you call upon your Sony dealer regarding this product.

Model No. DAV-S500  
Serial No. \_\_\_\_\_

### CAUTION

As the laser beam used in this CD/DVD player is harmful to eyes, do not attempt to disassemble the cabinet. Refer servicing to qualified personnel only.



This label is located on the Laser protective housing inside the enclosure.

## WARNING

This equipment has been tested and found to comply with the limits for a Class B digital device, pursuant to Part 15 of the FCC Rules. These limits are designed to provide reasonable protection against harmful interference in a residential installation. This equipment generates, uses, and can radiate radio frequency energy and, if not installed and used in accordance with the instructions, may cause harmful interference to radio communications. However, there is no guarantee that interference will not occur in a particular installation. If this equipment does cause harmful interference to radio or television reception, which can be determined by turning the equipment off and on, the user is encouraged to try to correct the interference by one or more of the following measures:

- Reorient or relocate the receiving antenna.
- Increase the separation between the equipment and receiver.
- Connect the equipment into an outlet on a circuit different from that to which the receiver is connected.
- Consult the dealer or an experienced radio/TV technician for help.

### CAUTION

You are cautioned that any changes or modifications not expressly approved in this manual could void your authority to operate this equipment.

### Note to CATV system installer:

This reminder is provided to call the CATV system installer's attention to Article 820-40 of the NEC that provides guidelines for proper grounding and, in particular, specifies that the cable ground shall be connected to the grounding system of the building, as close to the point of cable entry as practical.

## For the customers in North America

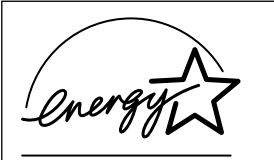

ENERGY STAR® is a U.S. registered mark. As an ENERGY STAR® partner, Sony Corporation has determined that this product meets the ENERGY STAR® guidelines for energy efficiency.

## Precautions

### Safety

- If anything falls into the cabinet, unplug the unit and have it checked by qualified personnel before operating it any further.
- The unit is not disconnected from the mains as long as it is connected to the mains outlet, even if the unit itself has been turned off.
- Unplug the unit from the wall outlet if you do not intend to use it for an extended period of time. To disconnect the cord, pull it out by the plug, never by the cord.

### Installing

- Do not install the appliance in a confined space, such as a bookcase or built-in cabinet.
- Allow adequate air circulation to prevent internal heat buildup.
- Do not place the unit on surfaces (rugs, blankets, etc.) or near materials (curtains, draperies) that may block the ventilation slots.
- Do not install the unit near heat sources such as radiators, or air ducts, or in a place subject to direct sunlight, excessive dust, mechanical vibration, or shock.
- Do not install the unit in an inclined position. It is designed to be operated in a horizontal position only.
- Keep the unit and discs away from equipment with strong magnets, such as microwave ovens, or large loudspeakers.
- Do not place heavy objects on the unit.
- If the unit is brought directly from a cold to a warm location, moisture may condense inside the Compact AV System and cause damage to the lenses. When you first install the unit, or when you move it from a cold to a warm location, wait for about 30 minutes before operating the unit.

Thank you for purchasing this Sony Compact AV System. Before operating this system, please read this manual thoroughly and retain it for future reference.

---

# Precautions

## On safety

- Caution – The use of optical instruments with this product will increase eye hazard.
- Should any solid object or liquid fall into the cabinet, unplug the system and have it checked by qualified personnel before operating it any further.

## On power sources

- The unit is not disconnected from the AC power source (mains) as long as it is connected to the wall outlet, even if the unit itself has been turned off.
- AC power cord must be changed only at the qualified service shop.

## On placement

- Place the system in a location with adequate ventilation to prevent heat build-up in the system.
- At high volume, over long periods of time, the cabinet becomes hot to the touch. This is not a malfunction. However, touching the cabinet should be avoided. Do not place the unit in a confined space where ventilation is poor as this may cause overheating.
- Do not block the ventilation slots by putting anything on the system. The system is equipped with a high power amplifier. If the ventilation slots on the top surface are blocked, the unit can overheat and malfunction.
- Do not place the system on a soft surface such as a rug that might block the ventilation holes on the bottom.
- Do not place the system in a location near heat sources, or in a place subject to direct sunlight, excessive dust, or mechanical shock.

## On operation

- If the system is brought directly from a cold to a warm location, or is placed in a very damp room, moisture may condense on the lenses inside the system. Should this occur, the system may not operate properly. In this case, remove the disc and leave the system turned on for about half an hour until the moisture evaporates.
- When you move the system, take out any discs. If you don't, the disc may be damaged.

- For power saving purposes, the system can be completely turned off by the POWER button on the main unit. Though the LED remains lit for a while, the system is completely off.

## On adjusting volume

Do not turn up the volume while listening to a section with very low level inputs or no audio signals. If you do, the speakers may be damaged when a peak level section is played.

## On cleaning

Clean the cabinet, panel, and controls with a soft cloth slightly moistened with a mild detergent solution. Do not use any type of abrasive pad, scouring powder or solvent such as alcohol or benzene.

If you have any questions or problems concerning your system, please consult your nearest Sony dealer.

## On cleaning discs

Do not use a commercially available CD/DVD cleaning disc. It may cause a malfunction.

## On your TV's colour

If the speakers should cause the TV screen to have colour irregularity, turn off the TV at once then turn it on after 15 to 30 minutes. If colour irregularity should persist, place the speakers further away from the set.

### IMPORTANT NOTICE

Caution: This system is capable of holding a still video image or on-screen display image on your television screen indefinitely. If you leave the still video image or on-screen display image displayed on your TV for an extended period of time you risk permanent damage to your television screen. Projection televisions are especially susceptible to this.





# Table of Contents

WARNING .....	2
Welcome! .....	3
Precautions .....	4
About this Manual .....	7
This system Can Play the Following Discs .....	7
Notes about the Discs .....	9
Index to Parts and Controls .....	10
Guide to the Control Menu Display (Magic Pad) .....	14
<hr/>	
<b>Getting Started .....</b>	<b>16</b>
Quick Overview .....	16
Unpacking .....	16
Inserting Batteries into the Remote .....	17
Step 1: Speaker System Hookup .....	17
Step 2: Antenna Hookups .....	20
Step 3: TV and Video Component Hookups .....	22
Speaker Setup .....	24
Presetting Radio Stations .....	29
<hr/>	
<b>Playing Discs .....</b>	<b>31</b>
Playing Discs .....	31
Resuming Playback from the Point Where You Stopped the Disc (Resume Play) .....	32
Using the DVD's Menu .....	33
Playing VIDEO CDs with PBC Functions (PBC Playback) .....	34
Creating Your Own Programme (Programme Play) .....	35
Playing in random order (Shuffle Play) .....	37
Playing repeatedly (Repeat Play) .....	38
<hr/>	
<b>Searching for a Scene .....</b>	<b>39</b>
Searching for a Particular Point on a Disc (Scan, Slow-motion Play) .....	39
Searching for a Title/Chapter/Track/Index/Scene .....	40
<hr/>	
<b>Viewing Information About the Disc .....</b>	<b>42</b>
Viewing the Playing Time and Remaining Time on the Front Panel Display ....	42
Checking the Playing Time and Remaining Time .....	43

<b>Sound Adjustments</b> .....	<b>45</b>
Changing the Sound .....	45
Selecting a Sound Field .....	47
Adjusting the level parameters .....	49
<hr/>	
<b>Enjoying Movies</b> .....	<b>50</b>
Changing the Angles .....	50
Displaying the Subtitles .....	51
Checking the Play Information (ADVANCED) .....	52
<hr/>	
<b>Using Various Additional Functions</b> .....	<b>53</b>
Locking Discs (CUSTOM PARENTAL CONTROL, PARENTAL CONTROL) ...	53
<hr/>	
<b>Other Operations</b> .....	<b>58</b>
Controlling the TV with the Supplied Remote .....	58
Watching the Video or other Unit .....	59
Listening to the Radio .....	60
Using the Radio Data System (RDS) (Only for the European models) .....	61
Naming Preset Stations .....	61
<hr/>	
<b>Settings and Adjustments</b> .....	<b>63</b>
Using the Setup Display .....	63
Setting the Display or Sound Track Language (LANGUAGE SETUP) .....	64
Settings for the Display (SCREEN SETUP) .....	65
Custom Settings (CUSTOM SETUP) .....	66
Settings for the Speakers (SPEAKER SETUP) .....	67
<hr/>	
<b>Additional Information</b> .....	<b>71</b>
Troubleshooting .....	71
Self-diagnosis Function (When letters/numbers appear in the display) .....	74
Glossary .....	74
Specifications .....	77
Language Code List .....	79
DVD Setup Menu List .....	80
Index .....	81

# About this Manual

- Instructions in this manual describe the controls on the remote. You can also use the controls on the system if they have the same or similar names as those on the remote.
- The icons used in this manual are explained below:

Icon	Meaning	Icon	Meaning
	Functions available in DVD video mode		Functions available in SACD (Super Audio CD) and Audio CD mode
	Functions available in VIDEO CD mode		More convenient features

- In this manual, the European model is used for illustration and OSD purposes.

# This system Can Play the Following Discs

Format of discs	
DVD VIDEO	
Super Audio CD	
VIDEO CD	
Music CD	

The "DVD VIDEO" logo is a trademark.

## Terms for discs

### • Title

The longest sections of a picture or a music piece on a DVD; a movie, etc., for a picture piece on a video software; or an album, etc., for a music piece on an audio software. Each title is assigned a title number enabling you to locate the title you want.

### • Chapter

Sections of a picture or a music piece that are smaller than titles. A title is composed of several chapters. Each chapter is assigned a chapter number enabling you to locate the chapter you want. Depending on the disc, no chapters may be recorded.

### • Track

Sections of a picture or a music piece on a VIDEO CD, SACD, or CD. Each track is assigned a track number enabling you to locate the track you want.

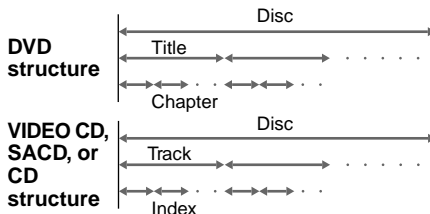

### • Index (SACD, CD) / Video Index (VIDEO CD)

A number that divides a track into sections to easily locate the point you want on a VIDEO CD, SACD, or CD. Depending on the disc, no indexes may be recorded.

### • Scene

On a VIDEO CD with PBC functions (page 34), the menu screens, moving pictures and still pictures are divided into sections called "scenes." Each scene is assigned a scene number enabling you to locate the scene you want.

continued

## Note on PBC (Playback Control) (VIDEO CDs)

This system conforms to Ver. 1.1 and Ver. 2.0 of VIDEO CD standards. You can enjoy two kinds of playback depending on the disc type.

Disc type	You can
VIDEO CDs without PBC functions (Ver. 1.1 discs)	Enjoy video playback (moving pictures) as well as music.
VIDEO CDs with PBC functions (Ver. 2.0 discs)	Play interactive software using menu screens displayed on the TV screen (PBC Playback), in addition to the video playback functions of Ver 1.1 discs. Moreover, you can play high-resolution still pictures, if they are included on the disc.

## Region code

Your system has a region code printed on the back of the unit and will only play DVDs labelled with the same region code.

DVDs labelled  will also play on this system.

If you try to play any other DVD, the message “Playback prohibited by area limitations.” will appear on the TV screen. Depending on the DVD, no region code indication may be labelled even though playing the DVD is prohibited by area restrictions.

## Examples of discs that the system cannot play

The system cannot play the following discs:

- CD-ROMs (PHOTO CDs included)
- All CD-Rs other than music and VCD format CD-Rs
- Data part of CD-Extras
- DVD-ROMs
- DVD Audio discs
- A DVD with a different region code (page 8, 75).
- A disc that has a non-standard shape (e.g., card, heart)
- A disc with paper or stickers on it.
- A disc that has the adhesive, cellophane tape, or a sticker still left on it.

### Note

Some CD-Rs or CD-RWs cannot be played on this system depending upon the recording quality or physical condition of the disc, or the characteristics of the recording device.

Furthermore, the disc will not play if it has not been correctly finalized. For more information, see the operating instructions for the recording device.

## Note on playback operations of DVDs and VIDEO CDs

Some playback operations of DVDs and VIDEO CDs may be intentionally set by software producers. Since this system plays DVDs and VIDEO CDs according to the disc contents the software producers designed, some playback features may not be available. Also, refer to the instructions supplied with the DVDs or VIDEO CDs.



## Copyrights

This product incorporates copyright protection technology that is protected by method claims of certain U.S. patents, other intellectual property rights owned by Macrovision Corporation, and other rights owners. Use of this copyright protection technology must be authorized by Macrovision Corporation, and is intended for home and other limited viewing uses only unless otherwise authorized by Macrovision Corporation. Reverse engineering or disassembly is prohibited.

## Notes about the Discs

### On handling discs

- To keep the disc clean, handle the disc by its edge. Do not touch the surface.



- Do not expose the disc to direct sunlight or heat sources such as hot air ducts, or leave it in a car parked in direct sunlight as the temperature may rise considerably inside the car.
- After playing, store the disc in its case.

### On cleaning

- Before playing, clean the disc with a cleaning cloth. Wipe the disc from the centre out.



- Do not use solvents such as benzene, thinner, commercially available cleaners, or anti-static spray intended for vinyl LPs.

This system incorporates Dolby\* Digital, Pro Logic Surround, and the DTS\*\* Digital Surround System.

\* Manufactured under license from Dolby Laboratories.  
“Dolby”, “Pro Logic”, and the double-D symbol are trademarks of Dolby Laboratories.  
Confidential unpublished works. © 1992-1997 Dolby Laboratories. All rights reserved.

\*\* Manufactured under license from Digital Theater Systems, Inc. US Pat. No. 5,451,942 and other worldwide patents issued and pending. “DTS” and “DTS Digital Surround” are trademarks of Digital Theater Systems, Inc. © 1996 Digital Theater Systems, Inc. All rights reserved.

# Index to Parts and Controls

For more information, refer to the pages indicated in parentheses.

## Front Panel

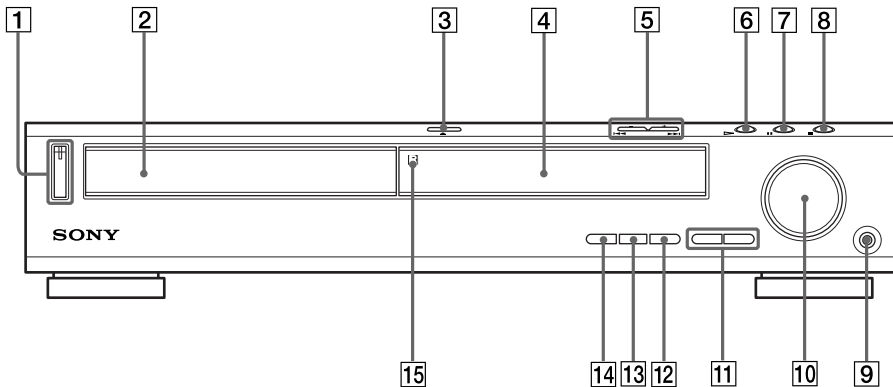

- |  |                                  |
|--|----------------------------------|
| <b>1</b> POWER switch/indicator (31)             | <b>8</b> ■ (stop) (31)           |
| <b>2</b> Disc tray (31)                          | <b>9</b> PHONES jack (31)        |
| <b>3</b> ≡ OPEN/CLOSE (31)                       | <b>10</b> VOLUME control (31)    |
| <b>4</b> Front panel display (11)                | <b>11</b> SOUND FIELD +/- (47)   |
| <b>5</b> ◀▶/▶▶ PREV/NEXT, PRESET +/-<br>(29, 32) | <b>12</b> DISPLAY (47, 60)       |
| <b>6</b> ▷ (play) (31)                           | <b>13</b> BAND (29)              |
| <b>7</b>    (pause) (32)                         | <b>14</b> FUNCTION (59)          |
|  | <b>15</b> □ (remote sensor) (17) |

## Front Panel Display

### When playing back a DVD

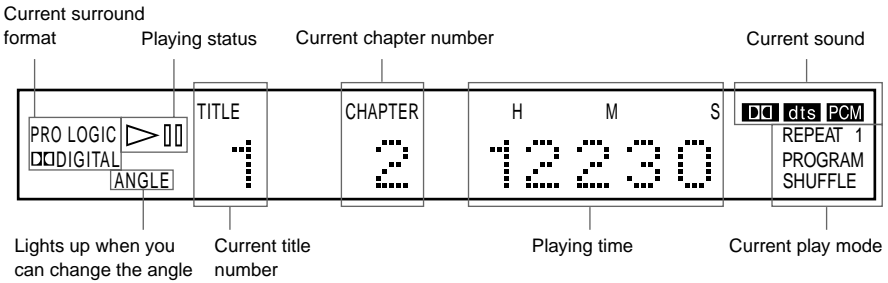

### When playing back a SACD, CD, or VIDEO CD

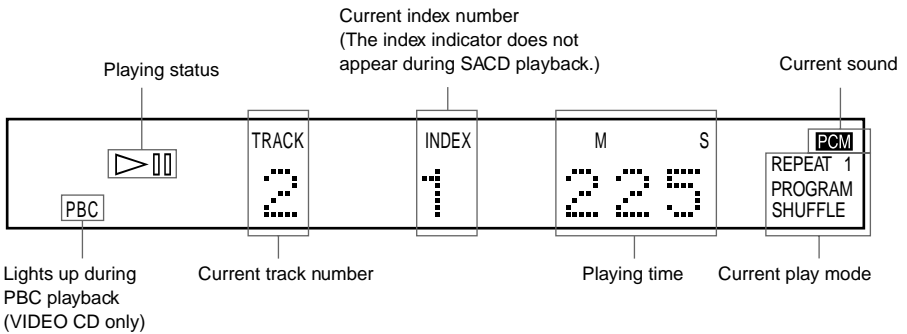

### When listening to the radio

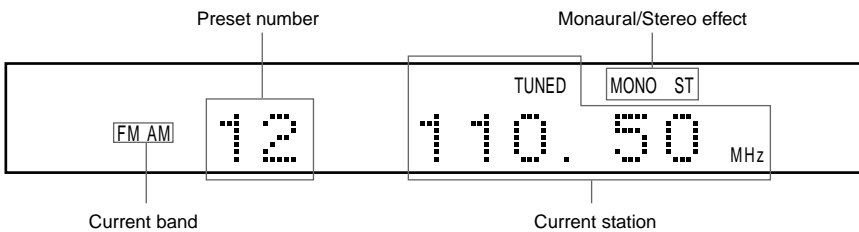

continued

## Rear Panel

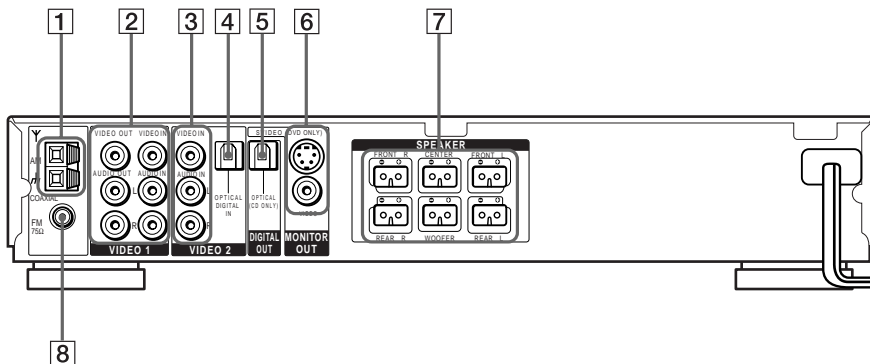

- 1** AM antenna (20)
- 2** VIDEO 1 jacks (22)
- 3** VIDEO 2 jacks (22)
- 4** DIGITAL IN (OPTICAL) jack (23)
- 5** DIGITAL OUT (OPTICAL) jack
- 6** MONITOR OUT (VIDEO/S VIDEO) jacks (22)
- 7** SPEAKER jacks (18)
- 8** FM 75Ω COAXIAL antenna jack (21)

## Remote

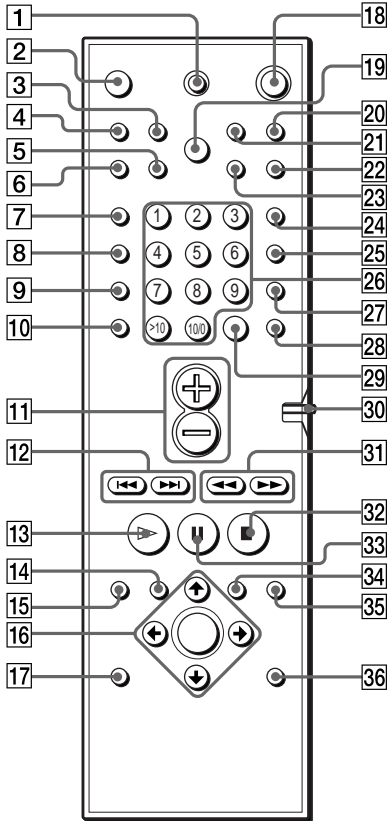

### Note

This remote control glows in the dark. However, before glowing, the remote must be exposed to light for awhile.

- 1 TV I/⏻ (on/standby) (58)
- 2 OPEN/CLOSE (31)
- 3 NAME (61)
- 4 STEREO/MONO (60)
- 5 MEMORY (29)
- 6 CLEAR (35)
- 7 PLAY MODE (35)
- 8 AUDIO (45)
- 9 ANGLE (50)
- 10 SUBTITLE (51)
- 11 VOL +/- (60)
- 12 ◀◀/▶▶ PREV/NEXT, TV/PRESET +/- (29, 32)
- 13 ▷ PLAY/SELECT (31)
- 14 TITLE (33)
- 15 DVD DISPLAY (38)
- 16 ◀/▶/⏮/⏭/ENTER (25)
- 17 DVD SETUP (54)
- 18 ⏻ (standby) (31)
- 19 DIMMER (28)
- 20 TV/VIDEO (58)
- 21 REPEAT (38)
- 22 MUTING (32)
- 23 TIME (42)
- 24 FUNCTION (59)
- 25 BAND (29)
- 26 Number buttons (33)
- 27 SOUND FIELD (47)
- 28 DISPLAY (47, 60)
- 29 ENTER (58)
- 30 CONTROL DVD/TV switch (58)
- 31 ◀◀/▶▶/◀◀/▶▶ SLOW, TUNING +/- (29, 39)
- 32 ■ STOP (31)
- 33 || PAUSE (32)
- 34 DVD MENU (34)
- 35 ↶ RETURN (34)
- 36 AMP MENU (25)







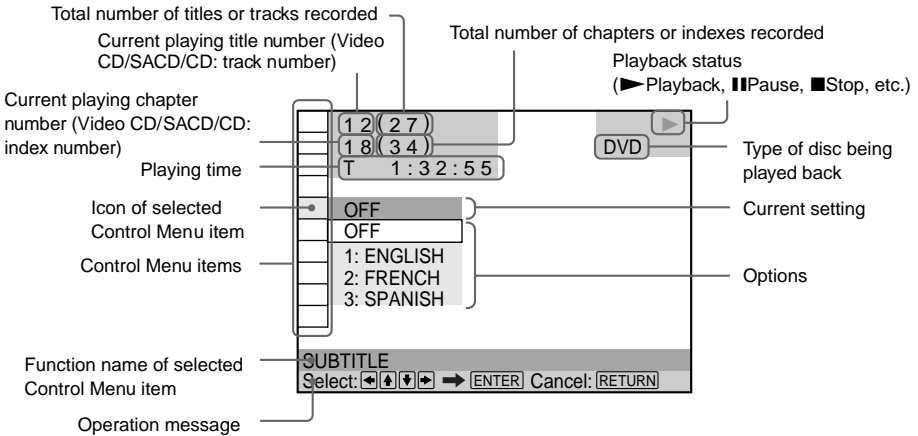

# Guide to the Control Menu Display (Magic Pad)





Use the Control Menu to select a function that you'd like to use. The Control Menu display appears when the DVD DISPLAY button is pressed. For details, refer to the page in parentheses.

## Control Menu



## List of Control Menu Items



 <b>TITLE (DVD only) (page 40)/ SCENE (only VIDEO CD in PBC playback) (page 40)/TRACK (VIDEO CD only) (page 40)</b>	Selects the title (DVD), the scene (VIDEO CD in PBC playback), or the track (VIDEO CD) to be played.
 <b>CHAPTER (DVD only) (page 40)/INDEX (VIDEO CD only) (page 40)</b>	Selects the chapter (DVD) or the index (VIDEO CD) to be played.
 <b>TRACK (SACD/CD only) (page 40)</b>	Selects the track (SACD/CD) to be played.
 <b>INDEX (SACD/CD only) (page 40)</b>	Selects the index (SACD/CD) to be played.
 <b>TIME/TEXT (page 40)</b>	Checks the elapsed time and the remaining playback time. Inputs the time code for picture and music searching. Displays the DVD or the SACD/CD text.
 <b>AUDIO (page 45)</b>	Changes the audio setting.
 <b>SUBTITLE (DVD only) (page 51)</b>	Displays the subtitles. Changes the subtitle language.
 <b>ANGLE (DVD only) (page 50)</b>	Changes the angle.

 <b>REPEAT (page 38)</b>	Plays the entire disc (all titles/all tracks) repeatedly, or one title/chapter/track repeatedly.
 <b>ADVANCED (DVD only) (page 52)</b>	Checks the information (bit rate or layer) on the disc while playing a DVD.
 <b>CUSTOM PARENTAL CONTROL (page 53)</b>	Sets the disc to prohibit playing.
 <b>SETUP (page 63)</b>	<p><b>CUSTOM Setup</b> By using the Setup Display, you can make various adjustments to items such as picture and sound. You can also set a language for the subtitles and the Setup Display, among other things.</p> <p><b>RESET</b> Returns the settings in "SETUP" to the default setting.</p>

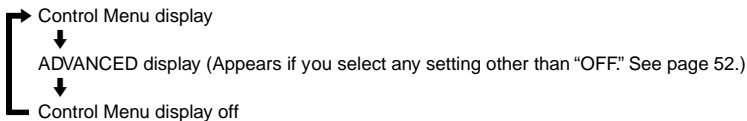
💡 Each time you press DVD DISPLAY, the Control Menu display changes as follows:



The Control Menu items are different depending on the disc.

💡 The Control Menu icon indicator lights up in green  →  when you select "REPEAT" except "OFF." The "ANGLE" indicator lights up in green only when the angles can be changed.

## Quick Overview

This chapter presents a quick overview so you can begin enjoying your new system right away. For selecting a language used in the on-screen display, refer to the page 64. For selecting the aspect ratio of the TV to be connected, refer to the page 65.

## Unpacking

Check that you have the following items:

- Speakers (5)
- Subwoofer (1)
- AM loop antenna (1)
- FM wire antenna (1)
- Speaker cords (5m × 4, 15m × 2) (16ft. × 4, 49ft. × 2)
- Video cord (1)
- Remote commander (remote) RM-SS800 (1)
- R6 (size AA) batteries (2)
- Foot pads (15)
- Speakers-connection and Installation (card) (1)
- Quick reference for Remote commander (card) (1)



## Inserting Batteries into the Remote

You can control the system using the supplied remote. Insert two R6 (size AA) batteries by matching the  $\oplus$  and  $\ominus$  ends on the batteries to the markings inside the compartment. When using the remote, point it at the remote sensor  on the system.

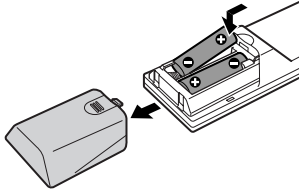

### Notes

- Do not leave the remote in an extremely hot or humid place.
- Do not use a new battery with an old one.
- Do not drop any foreign object into the remote casing, particularly when replacing the batteries.
- Do not expose the remote sensor to direct light from the sun or lighting apparatus. Doing so may cause a malfunction.
- If you do not use the remote for an extended period of time, remove the batteries to avoid possible damage from battery leakage and corrosion.

## Step 1: Speaker System Hookup

Connect the supplied speaker system using the supplied speaker cords by matching the colours of the terminals to those of the cords. Do not connect any speakers other than those supplied with this system.

To obtain the best possible surround sound, specify the speaker parameters (distance, level, etc.) on page 24.

### Required cords

#### Speaker cords

The connector and the colour tube of the speaker cords are the same colour as the label of the terminals to be connected.

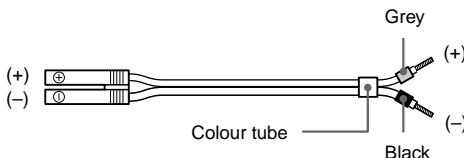

## Terminals for connecting the speakers

Connect the	To the
Front speakers	SPEAKER FRONT L (white) and R (red) terminals
Rear speakers	SPEAKER REAR L (blue) and R (grey) terminals
Centre speaker	SPEAKER CENTER (green) terminal
Subwoofer	SPEAKER WOOFER (purple) terminal

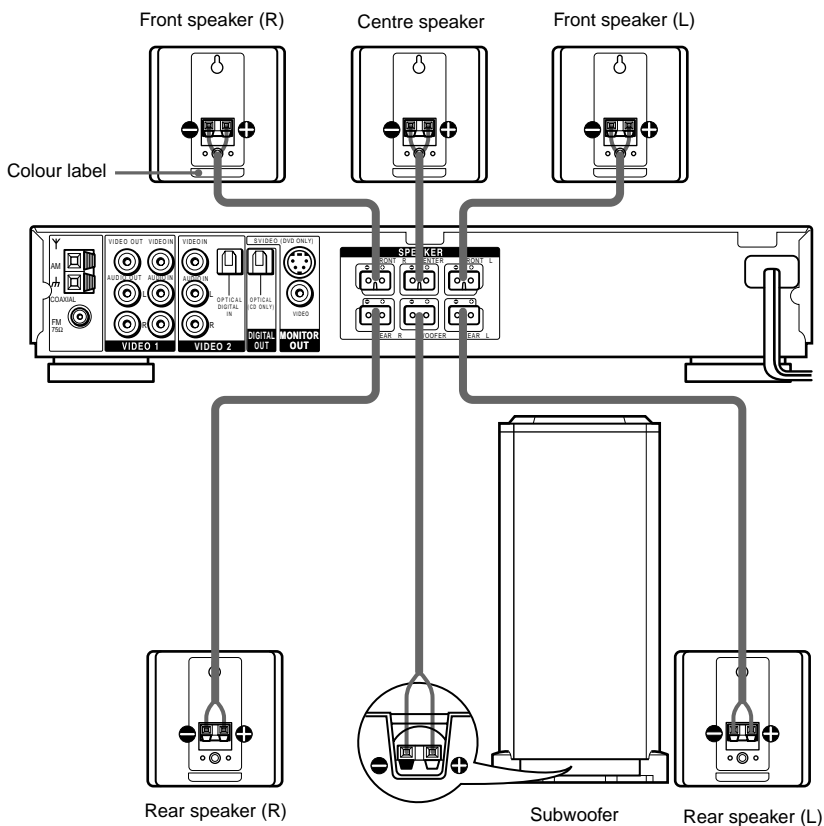

### Note on placing speakers

Use caution when placing the subwoofer or a speaker stand (not supplied) that is attached with the front/rear speakers on a specially treated (waxed, oiled, polished, etc.) floor, as staining or discoloration may result.

## To avoid short-circuiting the speakers

Short-circuiting of the speakers may damage the system. To prevent this, be sure to follow these precautions when connecting the speakers. Make sure the bare wire of each speaker cord does not touch another speaker terminal or the bare wire of another speaker cord.

### Examples of bad conditions of the speaker cord

Exposed end speaker cord is touching another speaker terminal.

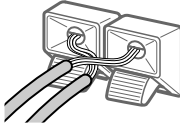

Exposed end cords are touching each other due to sloppy removal of insulation.

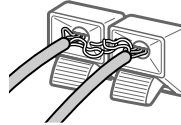

After connecting all the components, speakers, and AC power cord (mains lead), output a test tone to check that all the speakers are connected correctly. For details on outputting a test tone, see page 27.

If no sound is heard from a speaker while outputting a test tone, or a test tone is output from a speaker other than the one currently displayed on the front panel display, the speaker may be short-circuited. If this happens, check the speaker connection again.

### Notes

- Be sure to match the speaker cord to the appropriate terminal on the components:  $\oplus$  to  $\oplus$ , and  $\ominus$  to  $\ominus$ . If the cords are reversed, the sound will be distorted and will lack bass.
- If you use front speakers with low maximum input rating, adjust the volume carefully to avoid excessive output on the speakers.

## Step 2: Antenna Hookups

Connect the supplied AM/FM antennas for listening to the radio.

### Terminals for connecting the antennas

Connect the	To the
AM loop antenna	AM terminals
FM wire antenna	FM 75Ω COAXIAL terminal

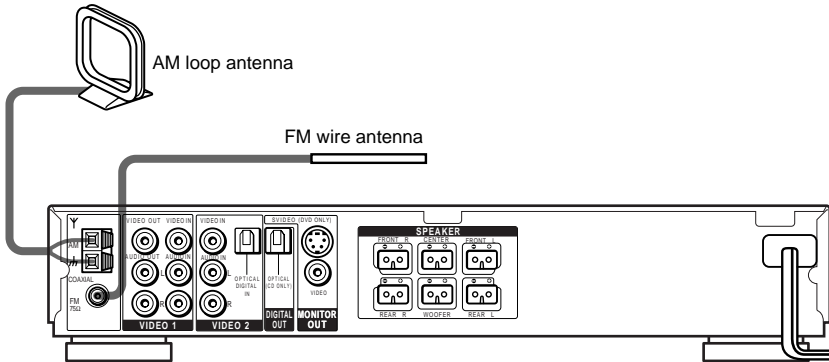

### Notes

- To prevent noise pickup, keep the AM loop antenna away from the system and other components.
- Be sure to fully extend the FM wire antenna.
- After connecting the FM wire antenna, keep it as horizontal as possible.
- When you connect the supplied AM loop antenna, connect the black cord (B) to the  $\hbar$  terminal, and the white cord (A) to the other terminal. (Only for the US models)

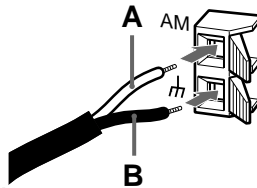

**💡 If you have poor FM reception**

Use a 75-ohm coaxial cable (not supplied) to connect the system to an outdoor FM antenna as shown below.

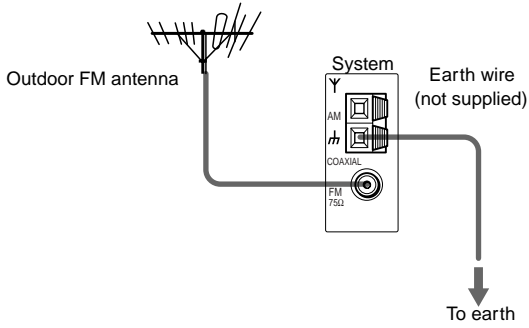

**Note**

If you connect the system to an outdoor antenna, ground it to protect against lightning. To prevent a gas explosion, do not connect the earth wire to a gas pipe.

## Step 3: TV and Video Component Hookups

### Required cords

#### Video cord for connecting a TV monitor



#### Audio/video cords (not supplied)

When connecting a cord, be sure to match the colour-coded pins to the appropriate jacks on the components.

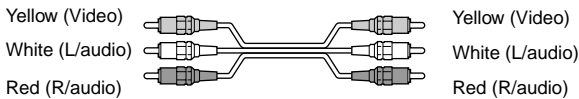

### Jacks for connecting video components

Connect a	To the
TV monitor	MONITOR OUT jack
VCR	VIDEO 1 jacks
Digital satellite receiver	VIDEO 2 jacks

#### When using the S-video jack instead of the video jacks

Your TV monitor must also be connected via an S-video jack. S-video signals are on a separate bus from the video signals and will not be output through the video jacks.

### Notes

- When you select VIDEO 1 using the FUNCTION button, the signal is output from the front L/R speakers, but not from the VIDEO 1 VIDEO OUT and AUDIO OUT L/R jacks.
- When you use the Video 1 line outputs, please set the unit to 2CH STEREO mode. If the unit is not in 2CH STEREO mode, the line outputs may not function properly.

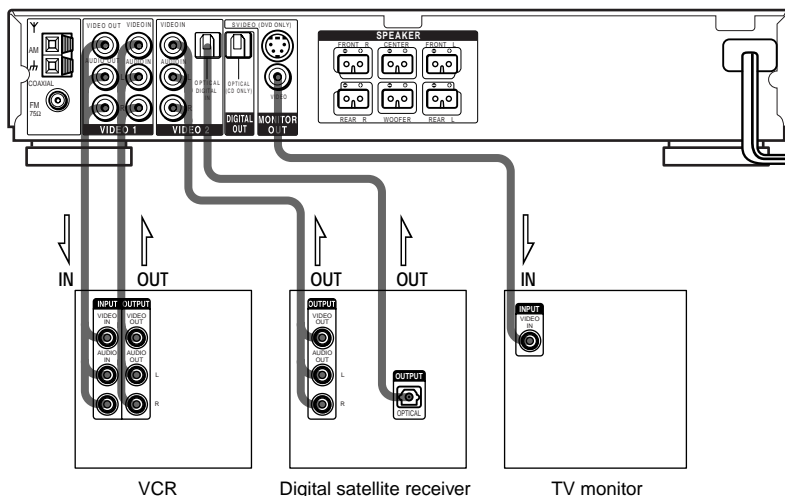

### If you connect a digital satellite receiver with the OPTICAL jack

The digital satellite receiver can be connected to the OPTICAL jack instead of the VIDEO IN and AUDIO IN L/R jacks of the system.

The system can accept both the digital and analog signals. Digital signals have priority over analog signals. If the digital signal ceases, the analog signal will be processed after 2 seconds.

### If you connect a digital satellite receiver without the OPTICAL jack

Connect the digital satellite receiver to the VIDEO IN and AUDIO IN L/R jacks only of the system.

## Setup for the system (for Asian and Australian models)

Setup is necessary for the system, depending on the TV monitor to be connected. The initial setting for Asian models is NTSC but Australian models is PAL.

### If the colour system of the TV is PAL\*

To set the system to PAL, turn on the system by pressing  $\text{⏻}$  (power) on the remote while pressing  $\text{⏸}$  (pause) button on the system. You need to hold the  $\text{⏸}$  button until DAV-S500 appears on the display. To reset to NTSC, turn off the system and then turn on again using the remote while pressing the  $\text{⏸}$  button on the system.

\* If the colour system of the TV is NTSC, do the same operation above to set the system to NTSC.

## Connecting the AC Power Cord (mains lead)

Before connecting the AC power cord (mains lead) of this system to a wall outlet (mains), connect the speakers to the system (see page 17). Connect the AC power cord (mains lead) of your TV/video components to a wall outlet (mains).

# Speaker Setup

For the best possible surround sound, all the speakers other than the subwoofer should be the same distance from the listening position (A).

However, if necessary, this system allows you to place the centre speaker up to 1.6 meters (5 feet) closer (B) and the rear speakers up to 4.6 meters (15 feet) closer (C) to the listening position.

The front speakers can be placed from 1.0 to 15.0 meters (3 to 50 feet) (A) from the listening position.

You can place the subwoofer in any position.

You can place the rear speakers either behind you or to the side, depending on the shape of your room, etc.

When the rear speakers are placed to the side

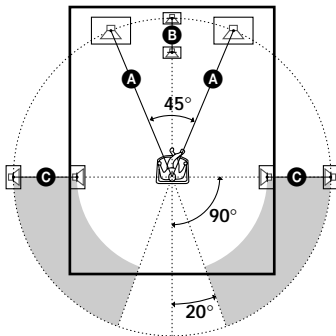

When the rear speakers are placed behind you

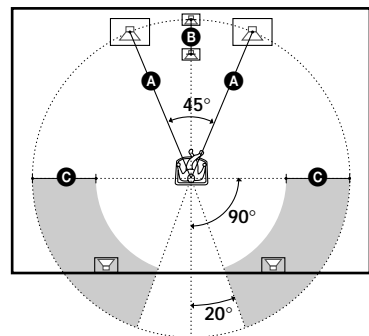

## Note

Do not place the centre and rear speakers farther away from the listening position than the front speakers.

## Specifying the speaker parameters

To obtain the best possible surround sound, first specify the distance of the speakers from your listening position, then set the balance and level. Use the test tone to adjust the speaker volumes to the same level.

You may adjust the speaker parameters using **SPEAKER SETUP** in the setup display (page 67).



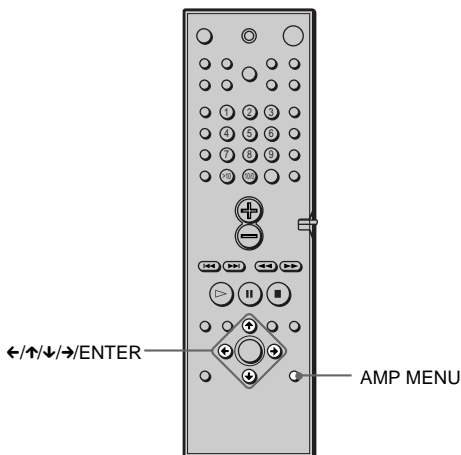

### To specify the size, distance, position and height of the speakers

- 1** Press AMP MENU repeatedly to display  $\downarrow$  SP. SETUP on the front panel display.
- 2** Sit in your listening position and select the item to be set using  $\uparrow/\downarrow$ .
  - Items set in  $\downarrow$  SP. SETUP
    - Size of the rear and centre speakers
    - Distance of the front, rear, and centre speakers
    - Position and height of the rear speakers
- 3** Set the parameter using  $\leftarrow/\rightarrow$ .  
The selected parameter will appear on the front panel display.
- 4** Repeat Steps 2 and 3 to set other parameters in  $\downarrow$  SP. SETUP.  
If you do not operate the remote for a few seconds, the parameter turns off and is stored in the system.

#### ■ SIZE

When you do not connect centre or rear speakers, or move the rear speakers, set the parameters for CENTER and REAR. Since the front speaker and subwoofer settings are fixed, you cannot change them. The default settings are underlined.

- CENTER (centre speaker)
  - YES: Normally select this.
  - NO: Select this if no centre speaker is used.
- REAR (rear speakers)
  - YES: Normally select this. Specify the position and height to implement the Digital Cinema Surround modes in the “Virtual” sound field (page 47) properly.
  - NO: Select this if no rear speaker is used.

continued

## ■DISTANCE

You can vary the distance of each speaker as follows. The default adjustments are in parentheses.

- F. D. 5 m (17 ft) (front speakers distance)  
Front speaker distance can be set in 0.2 m (1 foot) steps from 1.0 to 15.0 m (3 to 50 feet).
- C. D. 5 m (17 ft) (centre speaker distance)  
Centre speaker distance can be set in 0.2 m (1 foot) steps from the front speaker distance to 1.6 m (5 feet) closer to your listening position.
- R. D. 3.4 m (12 ft) (rear speakers distance)  
Rear speaker distance can be set in 0.2 m (1 foot) steps from a distance equal to the front speaker distance to a distance 4.6 m (15 feet) closer to your listening position.

## Notes

- If each of the front or rear speakers are not placed an equal distance from your listening position, set the distance of the closest speaker.
- In SPEAKER SETUP, the North American model's OSD displays both metric and imperial measurements. The other model's displays metric measurements only. The manual also shows both.

## Specifying the rear speaker position and height

If you select anything other than "NONE" in "REAR," specify the position and height of the rear speakers. The default settings are underlined.

Position diagram

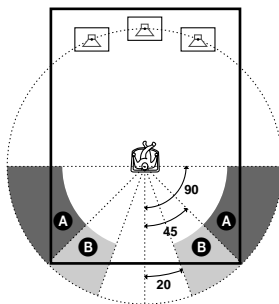

- R. P. BEHIND  
Select this if the rear speakers are located in the section **B**.
- R. P. SIDE  
Select this if the rear speakers are located in the section **A**.

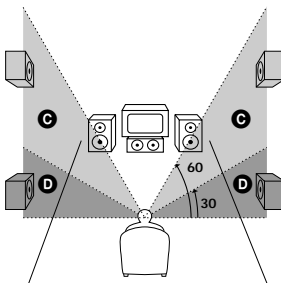

• R. H. LOW

Select this if the rear speakers are located in section **D**.

• R. H. HIGH

Select this if the rear speakers are located in section **C**.

These parameters are not available when “REAR“ is set to “NO”.

**To specify the balance and level of the speakers**

- 1** Press AMP MENU repeatedly to display  $\downarrow$  LEVEL on the front panel display.
- 2** Using  $\uparrow/\downarrow$  to select T.TONE and use  $\leftarrow/\rightarrow$  to set T.TONE to ON.  
You will hear the test tone from each speaker in sequence.
- 3** Sit in your listening position and select the item to be adjusted using  $\uparrow/\downarrow$ .
  - Items adjusted in  $\downarrow$  LEVEL
    - Balance of the front and rear speakers
    - Volume level of the centre and rear speakers and subwoofer
- 4** Adjust the volume level so that the volume of the test tone from each speaker sounds the same using  $\leftarrow/\rightarrow$ .  
The adjusted value will appear on the front panel display.
- 5** Repeat Steps 3 and 4 to adjust other parameters in  $\downarrow$  LEVEL.  
If you do not operate the remote for a few seconds, the value disappears from the display and is stored in the system.
- 6** Using  $\uparrow/\downarrow$  to select T.TONE and use  $\leftarrow/\rightarrow$  to set T.TONE to OFF.

**■BALANCE**

You can vary the balance of each speaker as follows. The default adjustments are in the parentheses.

- F    I    (centre) (front speakers)  
Adjust the balance between the front left and right speakers (You can adjust from centre, 6 steps left or right).
- R    I    (centre) (rear speakers)  
Adjust the balance between the rear left and right speakers (You can adjust from centre, 6 steps left or right).

## ■ LEVEL

You can vary the level of each speaker as follows. The default adjustments are in parentheses.

- C. LEVEL (0 dB) (centre speaker level)  
Adjust the level of the centre speaker (-6 dB to +6 dB, 1 dB steps).
- R. LEVEL (0 dB) (rear speakers level)  
Adjust the level of the rear speakers (-6 dB to +6 dB, 1 dB steps).
- S. W. LEV. (0 dB) (subwoofer level)  
Adjust the level of the subwoofer (-6 dB to +6 dB, 1 dB steps).

## Notes

- When you select an item, the sound cuts off for a moment.
- Depending on the settings of other speakers, the subwoofer may output excessive sound.

## To adjust the volume of all the speakers at one time

Use the VOLUME control.

## Other AMP MENU settings

You can control the brightness of the front panel display, clear the preset stations and the station names, and set the speaker parameters back to the default setting. Press AMP MENU repeatedly to display  $\downarrow$  CUSTOMIZE. Use  $\uparrow/\downarrow$  to select the following items.

## ■ DIMMER

You can change the brightness of the front panel display by two steps.

## ■ MEMO. CLR.

- N (No): Skip back to previous menu.
- Y (Yes): If you select Y by pressing ENTER, “Really? N” and “Really? Y” appears.  
If you select “Really? Y,” by pressing ENTER, “ALL CLEAR!” is displayed and all settings such as preset stations and station names will be cleared, and speaker parameters will be defaulted.

# Presetting Radio Stations

You can preset 20 stations for FM and 10 stations for AM.  
Before tuning, make sure to turn down the volume to minimum.

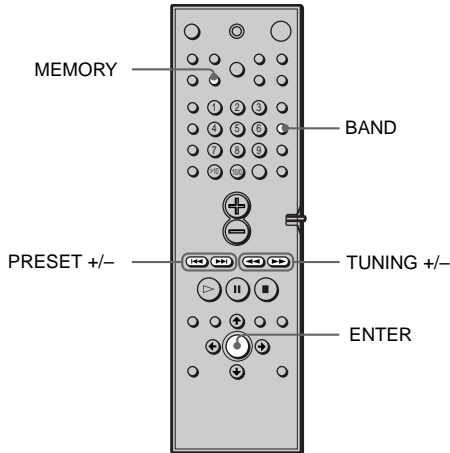

- 1 Press BAND repeatedly until the band you want appears on the front panel display.**  
Every time you press BAND, the band changes to AM or FM alternately.
- 2 Press and hold TUNING + or – until the frequency indication starts to change, then release.**  
Scanning stops when the system tunes in a station. “TUNED” and “ST” (for stereo programme) appear on the front panel display.



- 3 Press MEMORY.**  
A preset number appears on the front panel display.



- 4 Press PRESET + or – to select the preset number you want.**

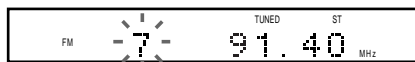

*continued*

**5** Press ENTER.

The station is stored.

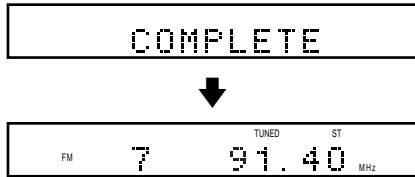

**6** Repeat **1** to **5** to store other stations.

**To tune in a station with a weak signal**



Press TUNING + or – repeatedly in **2** to tune in the station manually.

**To change the preset number**

Start over from **1**.

**To change the AM tuning interval (except for European, Middle Eastern, and Philippine models)**

The AM tuning interval is factory set to 9 kHz (10 kHz in some areas).

To change the AM tuning interval, tune in any AM station first, then turn off  on the remote. While holding down  (on the system), turn the power back on. When you change the interval, AM preset stations will be erased.

To reset the interval, repeat the same procedure.

# Playing Discs



Depending on the DVD or VIDEO CD, some operations may be different or restricted.

Refer to the operating instructions supplied with your disc.

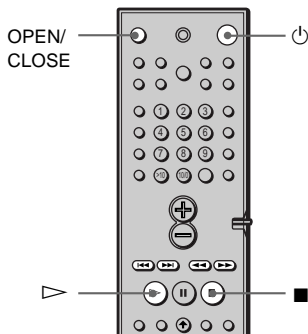
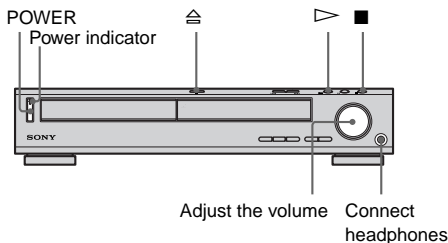

- 1** Turn on your TV.
- 2** Switch the input selector on the TV to this system.
- 3** Press **POWER** on the system. The system enters standby mode and the power indicator lights up in red.

- 4** Press **⏏** on the system or **OPEN/ CLOSE** on the remote, and place a disc on the disc tray.

The system automatically turns on and the power indicator turns off.

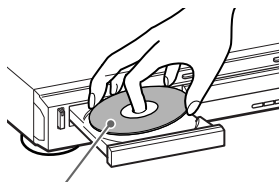

With the playback side facing down

- 5** Press **▶**. The disc tray closes, and the system starts playback (continuous play). Adjust the volume on the system.

### After following Step 5

Depending on the disc, a menu may appear on the TV screen. You can play the disc interactively by following the instructions on the menu. DVD (page 33), VIDEO CD (page 34).

### To turn on the system

Press **POWER** on the system. The system enters standby mode and the power indicator lights up in red. Press **⏏** on the remote. The system turns on and the power indicator turns off. In standby mode, the system also turns on by pressing **⏏** on the system or by pressing **▶**.

### To turn off the system

Press **⏏** on the remote. The system enters standby mode and the power indicator lights up in red. To turn off the system completely, press **POWER** on the system. While playing a disc, do not turn off the system by pressing **POWER**. Doing so may cancel the menu settings. When you turn off the system, first press **■** to stop playback and then press **⏏** on the remote.

## Additional operations

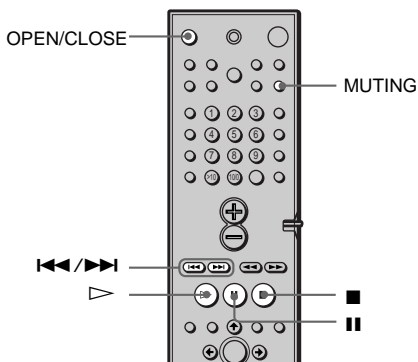

To	Operation
Stop	Press ■.
Pause	Press II.
Resume play after pause	Press II or ▶.
Go to the next chapter, track, or scene in continuous play mode	Press ▶▶.
Go back to the preceding chapter, track, or scene in continuous play mode	Press ◀◀.
Stop play and remove the disc	Press OPEN/CLOSE.
Mute the sound	Press MUTING. To cancel muting, press it again or turn up the volume.

### Note

Do not push the disc tray when closing it. Press OPEN/CLOSE to close the disc tray.

## Resuming Playback from the Point Where You Stopped the Disc (Resume Play)



When you stop the disc, the system remembers the point where you pressed ■ and “RESUME” appears on the front panel display. As long as you do not open the disc tray, Resume Play will work even if the system enters standby mode by pressing ⏻.

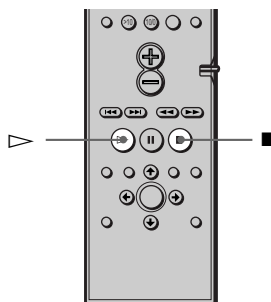

- 1** While playing a disc, press ■ to stop playback. “RESUME” appears on the front panel display, so you can restart the disc from the point where you stopped the disc. If “RESUME” does not appear, Resume Play is not available.

- 2** Press ▶. The system starts playback from the point where you stopped the disc in Step 1.

💡 To play from the beginning of the disc, press ■ twice, then press ▶.



**Notes**

- Depending on where you stopped the disc, the system may not resume playback from exactly the same point.
- The point where you stopped playing is cleared when:
  - you turn the power off by pressing **POWER** on the system.
  - you change the play mode.

## Using the DVD's Menu



Some discs have a “title menu” or a “DVD menu.” On some DVDs, this may simply be called a “menu” or “title.”

### Using the title menu

A DVD is divided into long sections of a picture or a music feature called “titles.” When you play a DVD which contains several titles, you can select the title you want using the title menu.

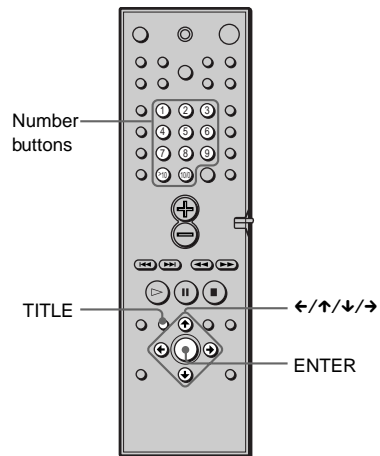

#### 1 Press **TITLE**.

The title menu appears on the TV screen.

The contents of the menu vary from disc to disc.

#### 2 Press **←/↑/↓/→** or the number buttons to select the title you want to play.

#### 3 Press **ENTER**.

The system starts playing the selected title.

## Using the DVD menu

Some DVDs allow you to select the disc contents using a menu. When you play these DVDs, you can select items such as the language for the subtitles and the language for the sound using the DVD menu.

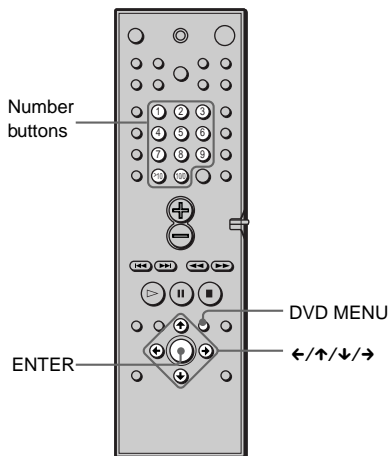

- 1 Press DVD MENU.**  
The DVD menu appears on the TV screen. The contents of the menu vary from disc to disc.
- 2 Press ←/↑/↓/→ or the number buttons to select the item you want to change.**
- 3 To change other items, repeat Step 2.**
- 4 Press ENTER.**

## Playing VIDEO CDs with PBC Functions (PBC Playback)



With PBC (Playback Control) functions, you can enjoy simple interactive operations, search functions, and other such operations. PBC playback allows you to play VIDEO CD interactively by following the menu on the TV screen.

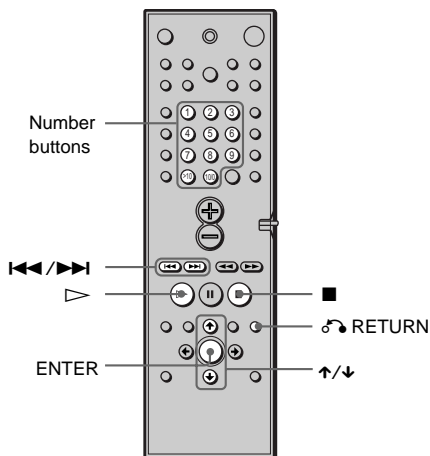

- 1 Start playing a VIDEO CD with PBC functions.**  
The menu for your selection appears.
- 2 Select the item number you want by pressing ↑/↓ or the number buttons.**
- 3 Press ENTER.**
- 4 Follow the instructions in the menu for interactive operations.**  
Refer to the instructions supplied with the disc, as the operating procedure may differ according to the VIDEO CD.

### To go back to the menu

Press RETURN.

To play without using PBC, press or the number buttons while the system is stopped to select a track, then press or ENTER. "Play without PBC" appears on the TV screen and the system starts continuous play. You cannot play still pictures such as a menu. To return to PBC playback, press twice then press .

### Note

Depending on the VIDEO CD, "Press ENTER" in Step 3 may appear as "Press SELECT" in the instructions supplied with the disc. In this case, press .

## Creating Your Own Programme (Programme Play)



You can play the contents of a disc in the order you want by arranging the order of the titles, chapters or tracks on the disc to create your own programme. You can programme up to 25 titles, chapters, and tracks.

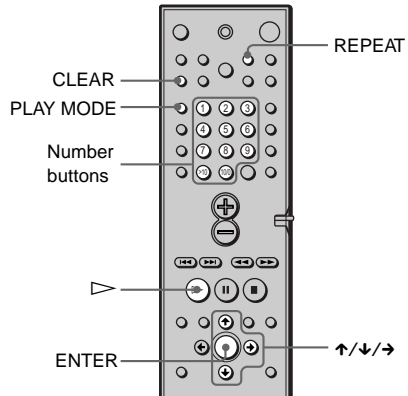

- 1** In stop mode, press PLAY MODE repeatedly until "PROGRAM" appears on the front panel display.

The programming display appears on the TV screen.

"TRACK" is displayed when you play a VIDEO CD, SACD, or CD.

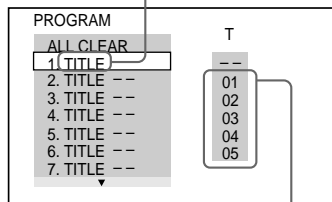

Titles or tracks recorded on a disc

continued

## 2 Press →.

The cursor moves to the title or track (in this case, “01”).

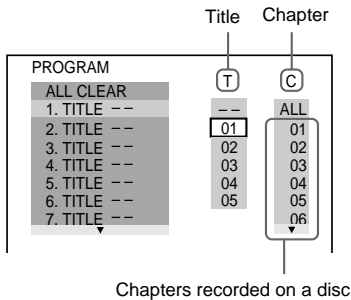

## 3 Select the title, chapter, or track you want to programme.

### ■ When playing a DVD

For example, select chapter “03” of title “02.”

Press ↑/↓ or the number buttons to select “02” under “T,” then press ENTER.

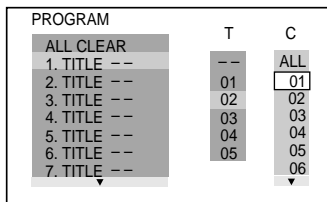

Next, press ↑/↓ or the number buttons to select “03” under “C,” then press ENTER.

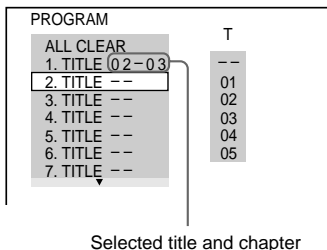

### ■ When playing a VIDEO CD, SACD, or CD

For example, select track “02.”

Press ↑/↓ or the number buttons to select “02” under “T,” then press ENTER.

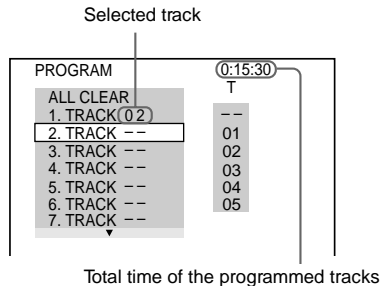

## 4 To programme other titles, chapters, or tracks, repeat Steps 2 to 3.

The programmed titles, chapters, and tracks are displayed in the selected order.

## 5 Press ▷ to start Programme Play.

Programme Play begins.

When the programme ends, you can restart the same programme again by pressing ▷.

### To return to normal play

Press CLEAR during playback.

### To turn off the programme menu

In stop mode, press PLAY MODE to turn off the programme menu.

### To change the programme

1 In Step 2, select the programme number of the title, chapter, or track you want to change using ↑/↓ or the number buttons, and press →.

2 Follow Step 3 for new programming.

### To cancel the programmed order

To cancel all the titles, chapters, or tracks in the programmed order, press **↑**, and select "ALL CLEAR" in Step 2. To cancel the selected programme, select the programme using **↑/↓** in Step 2, then press **CLEAR**, or select "--" in Step 3, then press **ENTER**.

 You can do Repeat Play of the programmed titles, chapters, or tracks. Press **REPEAT**, or set "REPEAT" to on in the Control Menu display during Programme Play.

#### Note

The number of titles, chapters, or tracks displayed are the same number of titles, chapters, or tracks recorded on a disc.

## Playing in random order

(Shuffle Play)   

You can have the system "shuffle" titles, chapters, or tracks and play them in random order. Subsequent "shuffling" may produce a different playing order.

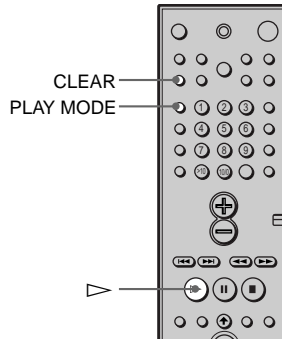

**1** In stop mode, press **PLAY MODE** repeatedly until "SHUFFLE" appears on the front panel display.

**2** Press .

### To return to normal play

In stop mode, press **PLAY MODE** twice, or during playback, press **CLEAR** to return to normal play.

#### Notes

- Shuffle Play is cancelled when:
  - you open or close the disc tray
  - you turn the power off
  - you change the function
- You may not be able to do Shuffle Play depending on the DVD.

# Playing repeatedly (Repeat Play)

Play) **DVD** **VIDEO CD** **SACD CD**

You can play all the titles/tracks or a single title/chapter/track on a disc.

In Shuffle or Programme Play mode, the system repeats the titles or tracks in the shuffled or programmed order.

You cannot perform Repeat Play during PBC playback of VIDEO CDs (page 34).

You may not be able to perform Repeat Play depending on the DVD.

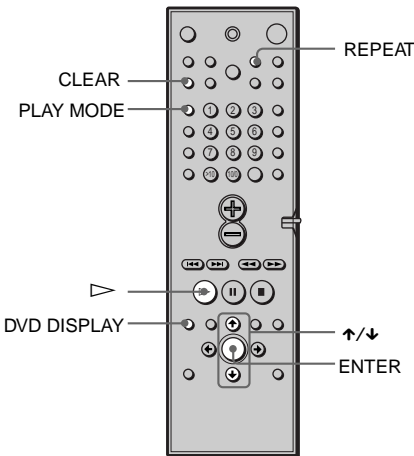

**1** Press **DVD DISPLAY**.  
The Control Menu appears.

**2** Press **↑/↓** to select  (**REPEAT**) then press **ENTER**.  
If you do not select “OFF,” the indicator of the “REPEAT” lights in green.

**3** Select the Repeat Play setting.

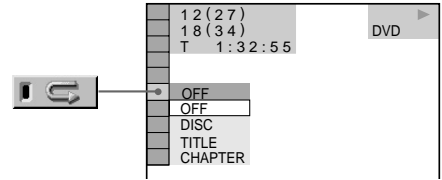

## When playing a DVD and when Programme Play is set to OFF

- **OFF**: does not play repeatedly.
- **DISC**: repeats all the titles.
- **TITLE**: repeats the current title on a disc.
- **CHAPTER**: repeats the current chapter.

## When playing a VIDEO CD/SACD/CD and when Programme Play is set to OFF

- **OFF**: does not play repeatedly.
- **DISC**: repeats all the tracks on a disc.
- **TRACK**: repeats the current track

## When Programme Play is set to ON

- **OFF**: does not play repeatedly.
- **ON**: repeats Programme Play.

## To cancel Repeat Play

Press **CLEAR**.

### You can set Repeat Play during stop mode

After selecting the “REPEAT” item, press **▷**.  
The system starts Repeat Play.

### You can quickly display the “REPEAT” status

Press **REPEAT** on the remote.

## **Note**

Repeat play is cancelled when:

- you turn the power off.
- you change the function.

## Searching for a Particular Point on a Disc (Scan, Slow-motion Play)



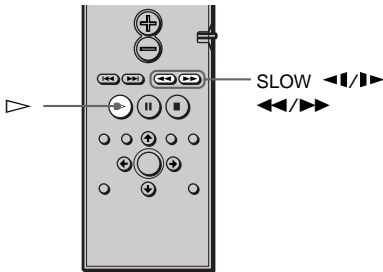

You can locate a particular point on a disc quickly by monitoring the picture or playing back slowly.





### Note

Depending on the DVD/VIDEO CD, you may not be able to do some of the operations described.



## Locating a point quickly by playing a disc in fast forward or fast reverse (Scan)







Press  or  while playing a disc. When you find the point you want, press  to return to normal speed. Each time you press  or  during scan, the playback speed changes. Three speeds are available. With each press the indication changes as follows:

Playback direction



 (DVD/SACD/CD only) →  → 



Opposite direction

 (DVD only) →  → 



The / playback speed is about twice the normal speed. The / playback speed is faster than /.

## Watching frame by frame (Slow-motion play)



You can use this function only for DVDs or VIDEO CDs. Press  or  when the system is in the pause mode. To return to the normal speed, press .





Each time you press  or  during Slow-motion play, the playback speed changes. Two speeds are available. With each press the indication changes as follows:

Playback direction

SLOW 2  ↔ SLOW 1 

Opposite direction (DVD only)

SLOW 2  ↔ SLOW 1 

The SLOW 2 /SLOW 2  playback speed is slower than SLOW 1 /SLOW 1 .

# Searching for a Title/ Chapter/Track/Index/ Scene



You can search a DVD disc by title or chapter, and you can search a VIDEO CD or CD by track, index, or scene. As titles and tracks are assigned unique numbers on the disc, you can select the desired one by entering its number. Or, you can search for a scene using the time code. (TIME SEARCH)

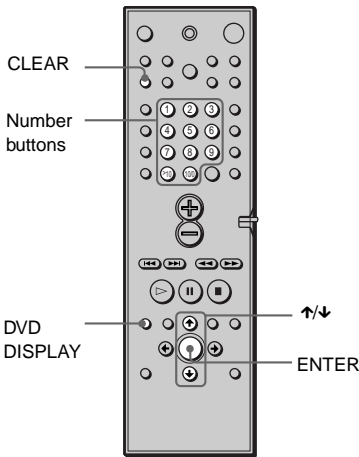

**1** Press DVD DISPLAY.  
The Control Menu appears.

**2** Press  $\uparrow/\downarrow$  to select the search method.

■ When playing a DVD

(TITLE), (CHAPTER), or (TIME/TEXT)  
Select TIME/TEXT for TIME SEARCH.

■ When playing a VIDEO CD

(TRACK) or (INDEX)

■ When playing a VIDEO CD with PBC Playback

(SCENE)

■ When playing a SACD/CD

(TRACK) or (INDEX)

Example: when you select (CHAPTER)

“\*\* (\*\*)” is selected (\*\* refers to a number).

The number in parentheses indicates the total number of titles, chapters, tracks, indexes, or scenes.

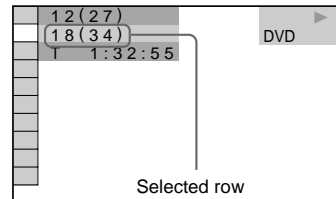

**3** Press ENTER.

“\*\* (\*\*)” changes to “— (\*\*)”.

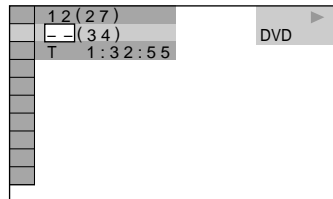

**4** Press  $\uparrow/\downarrow$  or the number buttons to select the title, chapter, track, index, or scene number you want to search.

**If you make a mistake**

Cancel the number by pressing CLEAR, then select another number.

**5** Press ENTER.

The system starts playback from the selected number.



**To turn off the Control Menu**

Press DVD DISPLAY repeatedly until the Control Menu is turned off.

**To search for a scene using the time code (TIME SEARCH) (DVD only)**

- 1** In Step 2, select  (TIME/TEXT).  
“T \*\*:\*\*:\*\*” (playing time of the current title) is selected.
- 2** Press ENTER.  
“T \*\*:\*\*:\*\*” changes to “T --:--:--.”
- 3** Input the time code using the number buttons, then press ENTER.  
For example, to find the scene at 2 hours, 10 minutes, and 20 seconds after the beginning, just enter “2:10:20.”

**Note**

The title, chapter or track number displayed is the same number recorded on the disc.

## Viewing the Playing Time and Remaining Time on the Front Panel Display



You can check information about the disc, such as the remaining time, total number of titles of a DVD, or tracks of a SACD, CD, or VIDEO CD, using the front panel display (page 11).

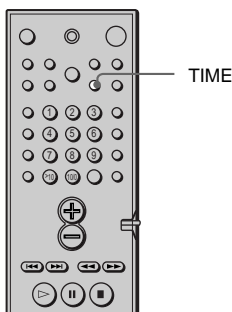

### Press TIME.

Each time you press TIME while playing the disc, the display changes as shown in the following charts.

### When playing a DVD

Playing time and number of the current title

TITLE	CHAPTER	H	M	S
1	2	10	3	24

Remaining time of the current title

TITLE	CHAPTER	H	M	S
1	2	-	11	536

Playing time and number of the current chapter

CHAPTER	H	M	S
2	02	23	0

Remaining time of the current chapter

CHAPTER	H	M	S
2	-	01	320

Text

SONY HITS/
------------

### When playing a VIDEO CD (without PBC functions), SACD, or CD

Playing time and current track number

TRACK	INDEX	M	S
2	1	22	5

Remaining time of the current track

TRACK	INDEX	M	S
2	1	-	150

Playing time of the disc

M	S
32	12

Remaining time of the disc

M	S
-	2018

Text

SONY HITS/
------------

When playing VIDEO CDs with PBC functions, the scene number and the playing time are displayed.

The playing time and remaining time of the current chapter, title, track, scene, or disc will also appear on your TV screen. See the following section “Checking the Playing Time and Remaining Time” for instructions on how to read this information.

## Notes

- While playing SACD, the index indicator does not appear on the front panel display.
- Depending on the type of disc being played and the playing mode, the disc information may not be displayed.

# Checking the Playing Time and Remaining Time



You can check the playing time and remaining time of the current title, chapter, or track, and the total playing time or remaining time of the disc. Also, you can check the DVD/CD/SACD text recorded on the disc.

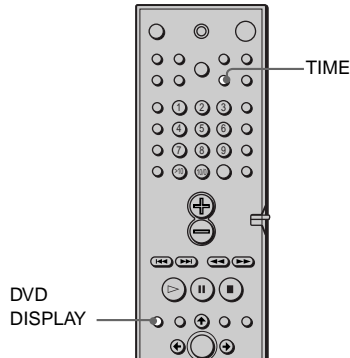

## 1 Press DVD DISPLAY during playback.

The Control Menu appears.

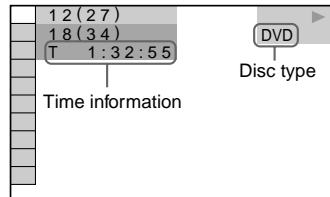

## 2 Press TIME repeatedly to change the time information.

The display and the kinds of time that you can change depend on the disc you are playing.

### ■ When playing a DVD

- T \*\*:\*\*:\*\*  
Playing time of the current title
- T-\*\*:\*\*:\*\*  
Remaining time of the current title
- C \*\*:\*\*:\*\*  
Playing time of the current chapter
- C-\*\*:\*\*:\*\*  
Remaining time of the current chapter

### ■ When playing a VIDEO CD (with PBC functions)

- \*\*:\*\*:\*\*  
Playing time of the current scene

### ■ When playing a VIDEO CD (without PBC functions), SACD, or CD

- T \*\*:\*\*:\*\*  
Playing time of the current track
- T-\*\*:\*\*:\*\*  
Remaining time of the current track
- D \*\*:\*\*:\*\*  
Playing time of the current disc
- D-\*\*:\*\*:\*\*  
Remaining time of the current disc

💡 If the DVD/CD/SACD text does not fit on a single line, you can see the entire text by scrolling it across the front display.

💡 You can select the time and text by pressing TIME.

#### Notes

- Only letters of the alphabet can be displayed.
- This system can only display the first level of DVD/CD/SACD text, such as the disc name or title.
- In SACD playback, the system can only display a limited number of characters. Also, depending on the disc, all text characters are not displayed.

---

### To turn off the Control Menu

Press DVD DISPLAY repeatedly until the Control Menu is turned off.

### Checking the DVD/CD/SACD text

Press TIME repeatedly in Step 2 to display the text recorded on the DVD/CD/SACD. The DVD/CD/SACD text appears only when the text is recorded on the disc. You cannot change the text.

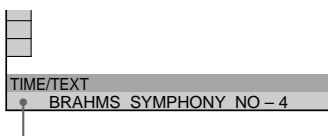

DVD/CD/SACD text

# Changing the Sound



If a DVD is recorded with multilingual tracks, you can select the language you want while playing the DVD.

If the DVD is recorded in multiple audio formats (PCM, Dolby Digital, MPEG audio, or DTS), you can select the audio format you want while playing the DVD.

With stereo CDs or VIDEO CDs, you can select the sound from the right or left channel and listen to the sound of the selected channel through both the right and left speakers. (In this case, the sound loses its stereo effect.) For example, when playing a disc containing a song with the vocals on the right channel and the instruments on the left channel, you can select the left channel and hear only the instruments from both speakers.

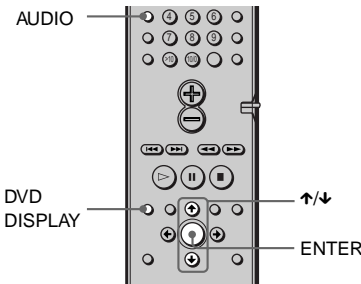

**1** Press DVD DISPLAY during playback. The Control Menu is displayed.

**2** Press  $\uparrow/\downarrow$  to select **AUDIO**, then ENTER. The options for AUDIO appear.

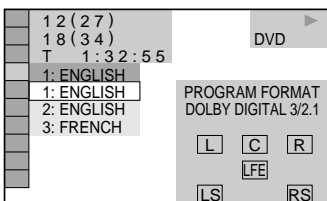

**3** Press  $\uparrow/\downarrow$  to select the desired audio signal.

**When playing a DVD**

Depending on the DVD, the choice of language varies.

When 4 digits are displayed, they represent the language code. Refer to the language code list on page 79 to see which language the code represents. When the same language is displayed two or more times, the DVD is recorded in multiple audio formats.

**When playing a VIDEO CD, or CD**

The default setting is underlined.

- STEREO: The standard stereo sound
- 1/L: The sound of the left channel (monaural)
- 2/R: The sound of the right channel (monaural)

**When playing a SACD**

In stop mode, depending on the SACD, the choice of settings varies.

- MULTI: The disc has multi-channel playback area
- 2CH: The disc has the 2 channel playback area.
- CD: When you want to play the disc as a conventional CD.

**Note**

Not all discs give you the three choices above when in SACD playback. It all depends on the layer configuration of the SACD to be played.

**4** Press ENTER.

**To turn off the Control Menu**

Press DVD DISPLAY repeatedly until the Control Menu is turned off.

You can select AUDIO directly by pressing AUDIO. Each time you press the button, the item changes.

**Notes**

- For discs not in multiple audio format, you cannot change the sound.
- During DVD playback, the sound may change automatically.

## Displaying the audio information of the disc

When you select “AUDIO,” the channels being played are displayed on the screen. For example, in Dolby Digital format, multiple signals ranging from monaural to 5.1 channel signals can be recorded on a DVD. Depending on the DVD, the number of recorded channels may differ.

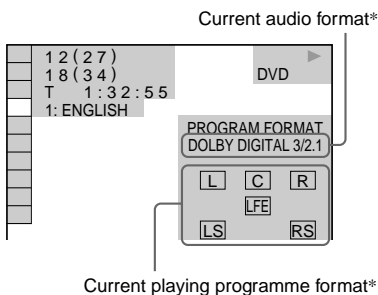

\*“PCM,” “MPEG,” “DTS,” or “DOLBY DIGITAL” is displayed. For “DOLBY DIGITAL,” the channels in the playing track are displayed numerically as follows:

For Dolby Digital 5.1 ch:

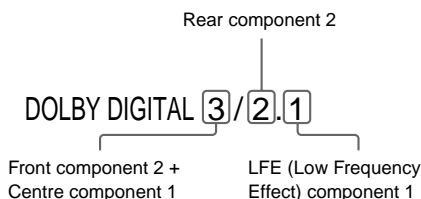

\*\*The letters in the programme format display mean the following sound component:

- L: Front (left)
- R : Front (right)
- C : Centre
- LS : Rear (left)
- RS : Rear (right)
- S : Rear (monaural): The rear component of the Dolby Surround processed signal and the Dolby Digital signal.
- LFE : LFE (Low Frequency Effect)

The display examples are as follows:

- PCM (stereo)



- Dolby Surround

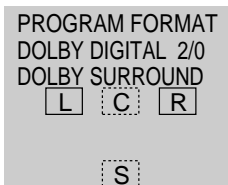

- Dolby Digital 5.1ch

When an LFE signal component is output, “LFE” is enclosed in a solid line. When an LFE signal component is not output, “LFE” is enclosed in a broken line.

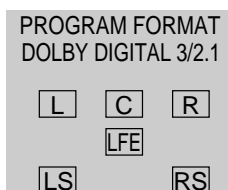

- DTS

“LFE” is always enclosed in a solid line regardless of the LFE signal component being output.

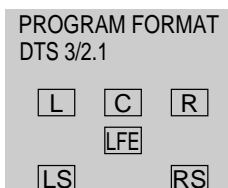

### Notes

- When the signal contains rear signal components such as LS, RS, or S, the Surround effect is enhanced (page 47).
- If you play MPEG AUDIO sound tracks, the system outputs PCM (stereo) signals.

# Selecting a Sound Field



You can enjoy surround sound simply by selecting one of the pre-programmed sound fields according to the programme you want to listen to. Surround sound can be applied to DVD, VIDEO CD, and CD playback.

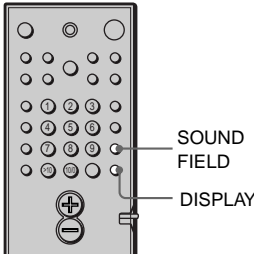

Press **SOUND FIELD** repeatedly until the sound field you want appears on the front panel display.

You can also use **SOUND FIELD** on the system to select the pre-programmed sound fields.

### To check the current sound field

Press **DISPLAY** repeatedly.  
 Each time you press **DISPLAY**, the front panel display switches as follows:  
 remaining or playing time → sound field  
 → remaining or playing time

### The system memorises the last sound field selected for each function mode (Sound Field Link)

Whenever you select a function such as **DVD** or **TUNER**, the sound field that was last applied to the function is automatically applied again. For example, if you listen to **DVD** with **HALL** as the sound field, then change to another function, and then return to **DVD**, **HALL** will be applied again. With the tuner, sound fields are memorised separately for all preset stations.

### You can identify the encoding format of programme software by looking at its packaging

- Dolby Digital discs are labelled with the logo.
- Dolby Surround encoded programmes are labelled with the logo.
- DTS Digital Surround discs are marked with **DTS**.

### Note

When you play sound tracks with 96 kHz sampling frequency, the output signals will be converted to 48 kHz (sampling frequency).

### CINEMA STUDIO EX A\*

Reproduces the sound characteristics of the Sony Pictures Entertainment’s classic editing studio using the 3D sound imaging of **V. MULTI DIMENSION** (page 48) to create 5 sets of virtual speakers surrounding the listener from a single pair of actual rear speakers.

This is a standard mode, great for watching most movies.

### CINEMA STUDIO EX B\*

Reproduces the sound characteristics of the Sony Pictures Entertainment’s mixing studio using the 3D sound imaging of **V. MULTI DIMENSION** (page 48) to create 5 sets of virtual speakers surrounding the listener from a single pair of actual rear speakers.

This mode is ideal for watching science-fiction or action movies with lots of sound effects.

### CINEMA STUDIO EX C\*

Reproduces the sound characteristics of the Sony Pictures Entertainment’s BGM recording studio using the 3D sound imaging of **V. MULTI DIMENSION** (page 48) to create 5 sets of virtual speakers surrounding the listener from a single pair of actual rear speakers.

This mode is ideal for watching musicals or classic films where music is featured in the soundtrack.

\*“**VIRTUAL**” sound field: Sound field with virtual speakers.

continued

## V. MULTI DIMENSION\*

### (Virtual Multi Dimension)

Uses 3D sound imaging to create an array of virtual rear speakers positioned higher than the listener from a single pair of actual rear speakers. This mode creates 5 sets of virtual speakers surrounding the listener at approximately a 30° angle of elevation.

SIDE

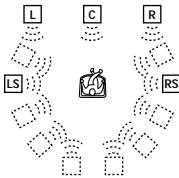

BEHIND

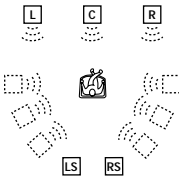

## V. SEMI-M. DIMENSION\*

### (Virtual Semi Multi Dimension)

Uses 3D sound imaging to create virtual rear speakers from the sound of the front speakers without using actual rear speakers. This mode creates 5 sets of virtual speakers surrounding the listener at a 30° angle of elevation.

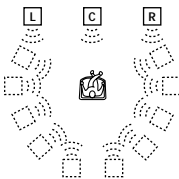

## SMALL HALL

Reproduces the acoustics of a small rectangular concert hall. Ideal for soft acoustic sounds.

## LARGE HALL

Reproduces the acoustics of a large rectangular concert hall. Ideal for soft acoustic sounds.

## JAZZ CLUB

Reproduces the acoustics of a jazz club.

## LIVE HOUSE

Reproduces the acoustics of a 300-seat live house. Great for rock or pop music.

## GAME

Obtains maximum audio impact from video game software.

Be sure to set the game machine to stereo mode when using game software with stereo sound capabilities.

## AUTO FORMAT DECODE

Automatically detects the type of audio signal being input (Dolby Digital, DTS, Dolby Pro Logic, or standard 2 channel stereo) and performs the proper decoding if necessary. This mode presents the sound as it was recorded/encoded, without adding any effects.

You can use this mode as a reference.

## NORMAL SURROUND

Software with multichannel surround audio signals is played according to the way it was recorded.

Software with 2 channel audio signals, is decoded with Dolby Pro Logic to create surround effects.

## 2 CH STEREO

Outputs the sound from the front left and right speakers and subwoofer. Standard two channel (stereo) sources completely bypass the sound field processing. Multi channel surround formats are downmixed to two channels.

This allows you to play any source using only the front left and right speakers and subwoofer.



## HEADPHONE THEATER\*

When you connect your headphone to the PHONES jack of the system, the HEADPHONE THEATER mode allows you to experience a theatre like environment while listening through a pair of headphones. This mode is very effective with 5.1 ch discreet signal sources like Dolby Digital and DTS. Selecting any Sound Field selections (except AUTO FORMAT DECODE or 2 CH STEREO) enables the mode.

\*“VIRTUAL” sound field: Sound field with virtual speakers.

### Notes

- The effects provided by the virtual speakers may cause increased noise in the playback signal.
- When listening to sound fields that employ the virtual speakers, you will not be able to hear any sound coming directly from the rear speakers.
- If you select AUTO FORMAT DECODE or 2 CH STEREO when the headphones are connected, 2 channel stereo is output. If any other sound field is selected, it is automatically changed to the HEADPHONE THEATER mode.

## Adjusting the level parameters



The level menu contains parameters that let you adjust the balance and speaker volumes of each speaker (page 27).

- 1** Start playing a programme source encoded with multichannel surround sound.
- 2** Press AMP MENU repeatedly on the remote.  
♪ LEVEL appears on the front panel display.
- 3** Sit in your listening position and select the item to be adjusted using ↑/↓.
- 4** Adjust the volume level using ←/→. The adjusted value will appear on the front panel display. If you do not operate the remote for a few seconds, the value turned off and is stored in the system.

## Adjustable parameters for each sound field

	FRONT BAL.	REAR BAL.	REAR LEVEL	CENTER LEVEL	WOOFER LEVEL
CINEMA STUDIO EX A	●	●	●	●	●
CINEMA STUDIO EX B	●	●	●	●	●
CINEMA STUDIO EX C	●	●	●	●	●
V. MULTI DIMENSION	●	●	●	●	●
V. SEMI-M. DIMENSION	●			●	●
SMALL HALL	●	●	●	●	●
LARGE HALL	●	●	●	●	●
JAZZ CLUB	●	●	●	●	●
LIVE HOUSE	●	●	●	●	●
GAME	●	●	●	●	●
AUTO FORMAT DECODE	●	●	●	●	●
NORMAL SURROUND	●	●	●	●	●
2 CH STEREO	●				●
HEADPHONE THEATER	●				

## Changing the Angles

If various angles (multi-angles) for a scene are recorded on the DVD, "ANGLE" appears in the front panel display. This means that you can change the viewing angle.

For example, while playing a scene of a train in motion, you can display the view from either the front of the train, the left window of the train, or from the right window without having the train's movement interrupted.

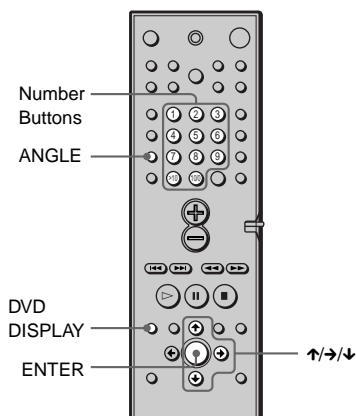

- 1 Press DVD DISPLAY during playback.

The Control Menu appears.

- 2 Press  $\uparrow/\downarrow$  to select  (ANGLE).

The angle number appears.

The number in parentheses indicates the total number of angles.

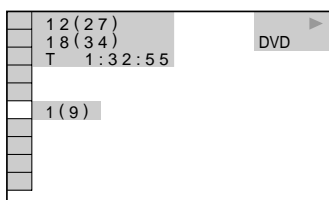

- 3 Press  $\rightarrow$  or ENTER.  
The angle number changes to "-."

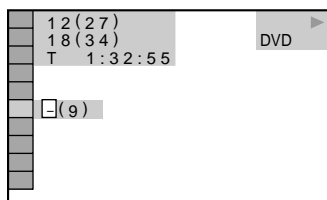

- 4 Select the angle number using the number buttons or  $\uparrow/\downarrow$ , then press ENTER.

The angle is changed to the selected angle.

### To turn off the Control Menu

Press DVD DISPLAY repeatedly until the Control Menu is turned off.

 You can select the angle directly by pressing ANGLE. Each time you press the button, the angle changes.

### Note

Depending on the DVD, you may not be able to change the angles, even if multi-angles are recorded on the DVD.

# Displaying the Subtitles



If subtitles are recorded on the discs, you can turn the subtitles on and off while playing. If multilingual subtitles are recorded on the disc, you can change the subtitle language while playing, or turn the subtitles on or off whenever you want. For example, you can select the language you want to practice and turn the subtitles on for better understanding.

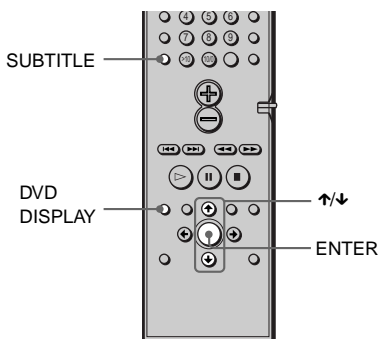

## 1 Press DVD DISPLAY during playback.

The Control Menu appears.

## 2 Press $\uparrow/\downarrow$ to select (SUBTITLE), then press ENTER.

The options for SUBTITLE appear.

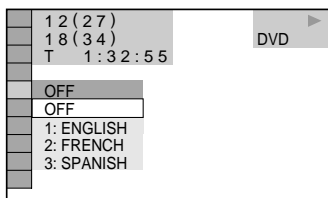

## 3 Press $\uparrow/\downarrow$ to select the language.

Depending on the DVD, the choice of language varies.

When 4 digits are displayed, they indicate the language code. Refer to the language code list on page 79 to see which language the code represents.

## 4 Press ENTER.

### To cancel the SUBTITLE setting

Select "OFF" in Step 3.

### To turn off the Control Menu

Press DVD DISPLAY repeatedly until the Control Menu is turned off.

 You can select SUBTITLE directly by pressing SUBTITLE. Each time you press the button, the item changes.

### Note

Depending on the DVD, you may not be able to change the subtitles even if multilingual subtitles are recorded on it.

# Checking the Play Information (ADVANCED)

You can check information such as the bit rate or the disc layer that is being played. While playing a disc, an approximate bit rate of the playback picture is always displayed as Mbps (Mega bit per second) and the audio as kbps (kilo bit per second).

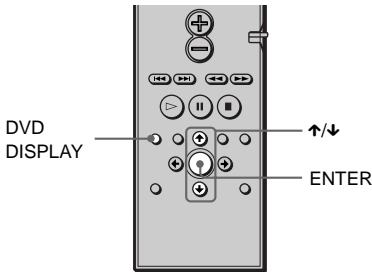

**1** Press DVD DISPLAY during playback.

The Control Menu is displayed.

**2** Press  $\uparrow/\downarrow$  to select  (ADVANCED), then press ENTER.

The options for ADVANCED appear.

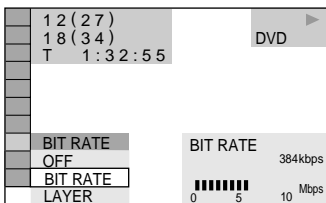

**3** Press  $\uparrow/\downarrow$  to select items. For each item, please refer to “Displays of each item.”

- BIT RATE: displays the bit rate.
- LAYER: displays the layer and the pick-up point.

**4** Press ENTER.

**To close the ADVANCED window**

Select “OFF” in Step 3.

**To turn off the Control Menu**

Press DVD DISPLAY repeatedly until the Control Menu is turned off.

## Displays of each item

By pressing DVD DISPLAY repeatedly, you can display either “BIT RATE” or “LAYER,” whichever was selected in “ADVANCED.”

### BIT RATE

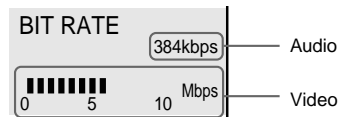

When playing MPEG audio sound tracks

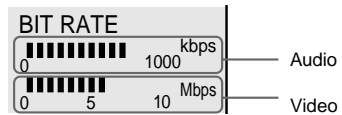

Bit rate refers to the amount of video/audio data per second in a disc. The higher the bit rate, the larger the amount of data. When the bit rate level is high, there is a large amount of data. However, this does not always mean that you can get higher quality pictures or sounds.

### LAYER

Appears when the DVD has dual layers



Indicates the approximate point where the disc is playing.

If it is a dual-layer DVD, the system indicates which layer is being read (“Layer 0” or “Layer 1”).

For details on the layers, see page 75 (DVD).

## Locking Discs (CUSTOM PARENTAL CONTROL, PARENTAL CONTROL)

You can set two kinds of playback restrictions for a disc.

- Custom Parental Control  
You can set the playback restrictions so that the system will not play inappropriate discs.
- Parental Control  
Playback of some DVDs can be limited according to a predetermined level such as the age of the users.

The same password is used for both Parental Control and Custom Parental Control.

### Custom Parental Control



You can set the same Custom Parental Control password for up to 50 discs. When you set the fifty-first-disc, the playback restriction for the first disc is cancelled.

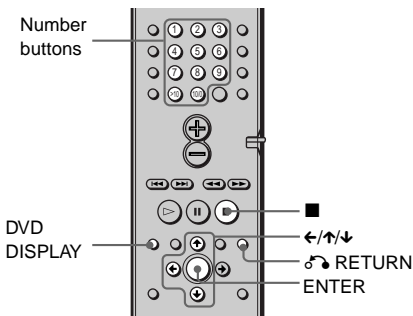

- 1 Insert the disc you want to lock.**  
If the disc is playing, press ■ to stop playback.
- 2 In stop mode, press DVD DISPLAY.**  
The Control Menu appears.

- 3 Press ↑/↓ to select**  (CUSTOM PARENTAL CONTROL), then press ENTER.  
“CUSTOM PARENTAL CONTROL” is selected.

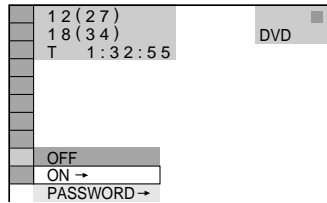

- 4 Press ↑/↓ to select “ON →,” then press ENTER.**

#### ■When you have not entered a password

The display for registering a new password appears.

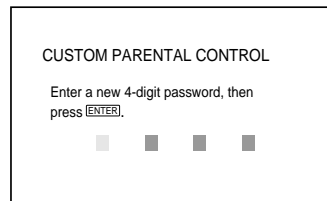

Enter a 4-digit password by using the number buttons, then press ENTER. The display for confirming the password appears.

#### ■When you have already registered a password

The display for entering the password appears.

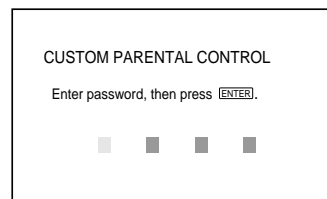

- 
- 5** Enter or re-enter your 4-digit password by using the number buttons, then press ENTER.  
“Custom parental control is set.” appears and then the screen returns to the Control Menu display.

**If you make a mistake entering your password**

Press ← before you press ENTER and input the correct number.

---

**If you make a mistake**

Press ↶ RETURN, then start from Step 3 again.

**To turn off the Control Menu**

Press ↶ RETURN, then press DVD DISPLAY repeatedly until the Control Menu is turned off.

**To turn off the Custom Parental Control function**

- 1** In Step 4, select “OFF →,” then press ENTER.
- 2** Enter your 4-digit password using the number buttons, then press ENTER.

**To change the password**

- 1** In Step 4, press ↑/↓ to select “PASSWORD →,” then press ENTER.  
The display for entering the password appears.
- 2** Enter your 4-digit password using the number buttons, then press ENTER.
- 3** Enter a new 4-digit password using the number buttons, then press ENTER.
- 4** To confirm your password, re-enter it using the number buttons, then press ENTER.

---

**Playing the disc for which Custom Parental Control is set**

---

- 1** Insert the disc for which Custom Parental Control is set.  
The CUSTOM PARENTAL CONTROL display appears.

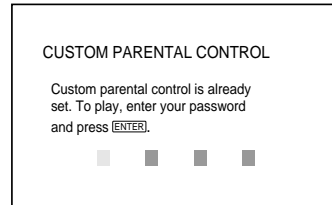

- 2** Enter your 4-digit password using the number buttons, then press ENTER.  
The system is ready for playback.
- 

 If you forget your password, enter the 6-digit number “199703” using the number buttons when the CUSTOM PARENTAL CONTROL display asks you for your password, then press ENTER. The display will ask you to enter a new 4-digit password.

---

**Limiting playback for children (Parental Control) DVD**

---

Playback of some DVDs can be limited according to a predetermined level such as the age of the users. The “Parental Control” function allows you to set a playback limitation level.

A scene that is limited is not played, or it is replaced by a different scene.

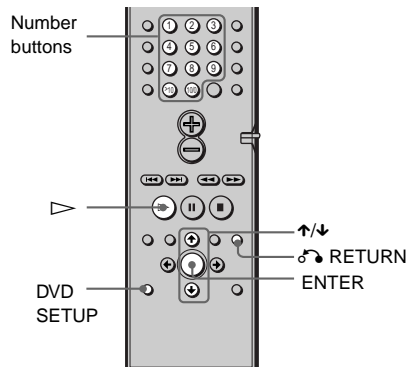

**1** In stop mode, press DVD SETUP.  
The Setup Display appears.

**2** Press  $\uparrow/\downarrow$  to select "CUSTOM SETUP,"  
then press ENTER.  
"CUSTOM SETUP" is displayed.

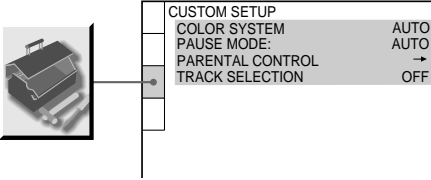

**4** Enter or re-enter your password using  
the number buttons, then press ENTER.  
The display for setting the playback  
limitation level and changing the  
password appears.

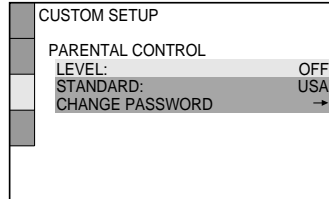

**3** Press  $\uparrow/\downarrow$  to select "PARENTAL  
CONTROL →," then press ENTER.

**■ If you have not entered a  
password**

The display for registering a new  
password appears.

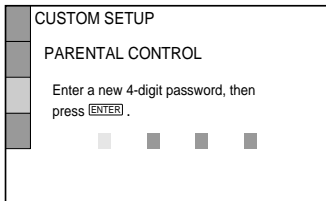

Enter a 4-digit password using the  
number buttons, then press ENTER.  
The display for confirming the password  
appears.

**■ When you have already  
registered a password**

The display for entering the password  
appears.

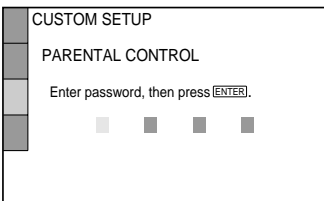

**5** Press  $\uparrow/\downarrow$  to select "STANDARD," then  
press ENTER.  
The selection items for "STANDARD"  
are displayed.

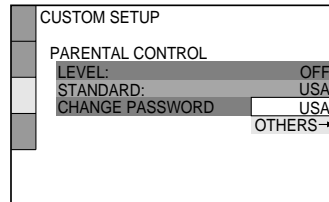

**6** Press  $\uparrow/\downarrow$  to select a geographic area  
as the playback limitation level, then  
press ENTER.  
The area is selected.  
If you select "OTHERS →," select and  
enter the standard code in the table on  
page 57 using the number buttons.

## 7 Press ENTER.

The selection items for “LEVEL” are displayed.

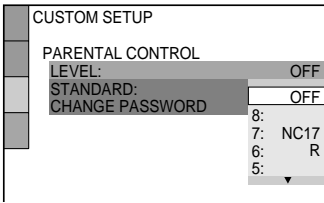

## 8 Select the level you want using $\uparrow/\downarrow$ , then press ENTER.

Parental Control setting is complete.

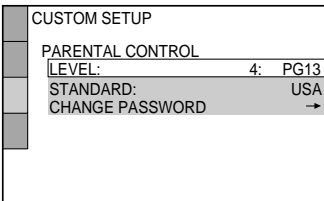

The lower the value, the more strict the limitation.

### If you make a mistake

Press  $\leftarrow$  RETURN to go back to the previous screen.

### To turn off the Setup Display

Press DVD SETUP repeatedly until the Setup Display is turned off.

### To turn off the Parental Control function and play the DVD after entering your password

Set “LEVEL” to “OFF” in Step 8.

### To change the password

**1** In Step 5, select “CHANGE PASSWORD  $\rightarrow$ ” using  $\downarrow$ , then press ENTER.

The display for entering the password appears.

**2** Follow Step 3 to enter a new password.

## Playing the disc for which Parental Control is set

**1** Insert the disc and press  $\triangleright$ .

The PARENTAL CONTROL display appears.

**2** Enter your 4-digit password using the number buttons, then press ENTER.

The system starts playback.

 If you forget your password, remove the disc and repeat Step 1 to 5 of “Limiting playback for children.” When you are asked to enter your password, enter “199703” using the number buttons, then press ENTER. The display will ask you to enter a new 4-digit password. After you enter a new 4-digit password in Step 3, replace the disc in the system and press  $\triangleright$ . When the PARENTAL CONTROL display appears, enter your new password.

### Notes

- When you play DVDs which do not have the Parental Control function, playback cannot be limited on this system.
- Depending on the DVD, you may be asked to change the parental control level while playing the disc. In this case, enter your password, then change the level. If the Resume Play mode is cancelled, the level returns to the original level.



## Area Code

<b>Standard</b>	<b>Code number</b>	<b>Standard</b>	<b>Code number</b>
Argentina	2044	Korea	2304
Australia	2047	Malaysia	2363
Austria	2046	Mexico	2362
Belgium	2057	Netherlands	2376
Brazil	2070	New Zealand	2390
Canada	2079	Norway	2379
Chile	2090	Pakistan	2427
China	2092	Philippines	2424
Denmark	2115	Portugal	2436
Finland	2165	Russia	2489
France	2174	Singapore	2501
Germany	2109	Spain	2149
Hong Kong	2219	Sweden	2499
India	2248	Switzerland	2086
Indonesia	2238	Taiwan	2543
Italy	2254	Thailand	2528
Japan	2276	United Kingdom	2184

## Controlling the TV with the Supplied Remote

By adjusting the remote signal, you can control your TV with the supplied remote.

### Notes

- If you enter a new code number, the code number previously entered will be erased.
- When you replace the batteries of the remote, the code number may be reset to the default (SONY) setting. Reset the appropriate code number.

### Controlling TVs with the remote

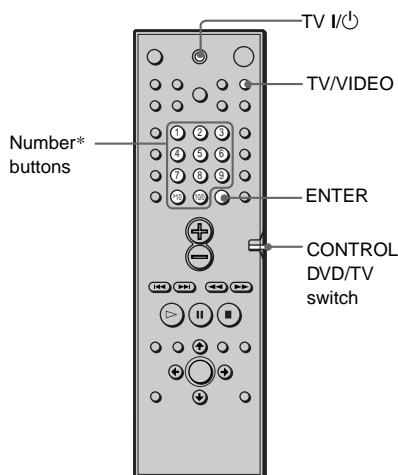

Press and hold TV I/O while entering your TV's manufacturer's code (see the table) using the number buttons and press ENTER. Then release TV I/O.

### Code numbers of controllable TVs

If more than one code number is listed, try entering them one at a time until you find the one that works with your TV.

## TV

Manufacturer	Code number
DAEWOO	002, 004, 005, 006, 007, 015
FISHER	008
GOLDSTAR	002, 003, 011, 012, 015, 034
DRUNDIG	017, 034
HITACHI	002, 013, 014, 015
ITT/NOKIA	021, 022
JVC	016
MAGNAVOX	002, 003, 018
MITSUBISHI/MGA	002, 003, 019
NEC	002, 003, 020
PANASONIC	009, 024
PHILIPS	015, 018
PIONEER	009, 025, 026, 040
RCA/PROSCAN	002, 010, 027, 028, 029
SAMSUNG	002, 003, 015, 031, 032, 033, 034
SANYO	008, 044, 045, 046
SHARP	035
SONY	001
TELEFUNKEN	023, 036, 037, 038
THOMSON	030, 037, 039
TOSHIBA	035, 040, 041
ZENITH	042, 043

## CATV

Manufacturer	Code number
SONY	101
JERROLD/GI	102, 103, 104, 105, 106, 107, 108, 109, 119, 131
SCIENTIFIC ATLANTA	110, 111, 112
PIONEER	115, 116
HAMLIN/REGAL	123, 124, 125, 126, 127
OAK	128, 129, 130
ZENITH	113, 114
TOCOM	117, 118, 131
PANASONIC	120, 121, 122

## Controlling the TV

You can control your TV using the buttons below.

By pressing	You can
TV I/O	Turn the TV on or off.
TV/VIDEO	Switch the TV's input source between the TV and other input sources.

## Switching between TV and DVD

Using the CONTROL DVD/TV switch, you can switch the remote signal between control of the TV and control of the DVD unit. When you watch the DVD, ensure that you have the CONTROL DVD/TV switch set to DVD.

The table below shows the buttons that are affected by the CONTROL DVD/TV switch.

Button	DVD	TV
1~9,** >10, 10/0	Standard number button function for DVD.	Regardless of the number button pressed, the channel advances in numerical order.
ENTER	Standard enter function for DVD.	Skips to channel 12.
◀◀	Standard preceding title, chapter skip function for DVD.	CH -
▶▶	Standard forward title, chapter skip for DVD.	CH +
⊕	VOL +	VOL +
⊖	VOL -	VOL -

### Note

Depending on the TV, you may not be able to control your TV or to use some of the buttons above.

\* Use the number buttons only to enter the code number of controllable TVs.

\*\* For double digit number, press >10, then the number. (For example, press >10, then 2 and 5 for entering 25.)

## Watching the Video or other Unit

You can use VCRs or other units connected to the VIDEO 1 or VIDEO 2 jacks. Refer to the operation manual supplied with the unit for farther information on the operation.

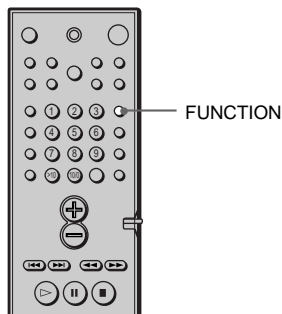

Press **FUNCTION** repeatedly until **VIDEO 1** or **VIDEO 2** that you connected the unit to appears on the front panel display.

Each time you press **FUNCTION**, the mode of the system changes in the following sequence.

DVD → VIDEO 1 → VIDEO 2 →  
TUNER → DVD...

# Listening to the Radio

Preset radio stations in the system's memory first (see "Presetting Radio Stations" on page 29).

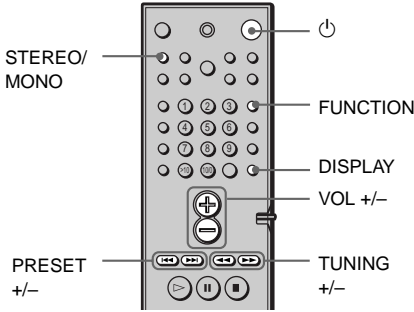

- 1 Press FUNCTION repeatedly until TUNER appears on the front panel display.**

The last received station is tuned in.

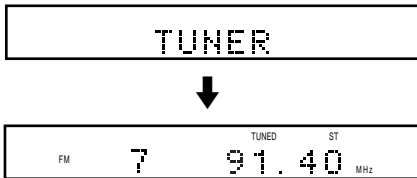

- 2 Press PRESET + or PRESET - repeatedly to select the preset station you want.**

Each time you press the button, the system tunes in one preset station.



- 3 Adjust the volume by pressing VOL +/-.**

## To turn off the radio



Press .

## To listen to non-preset radio stations

Use manual or automatic tuning in Step 2.

For manual tuning, press  or 

(TUNING + or -) on the remote repeatedly.

For automatic tuning, press and hold  or  (TUNING + or -) on the remote.

## If an FM programme is noisy

Press STEREO/MONO on the remote so that "MONO" appears on the front panel display. There will be no stereo effect, but the reception will improve. Press the button again to restore the stereo effect.

## To improve reception

Reorient the supplied antennas.

## To check the frequency or sound field

Press DISPLAY repeatedly.

Each time you press DISPLAY, the front panel display changes as follows:

index name of the station → frequency →

sound field → index name of the station

# Using the Radio Data System (RDS)

(Only for the European models)

## What is the Radio Data System?

Radio Data System (RDS) is a broadcasting service that allows radio stations to send additional information along with the regular programme signal. This tuner offers convenient RDS features such as station name display. RDS is available only for FM stations.\*

### Note

RDS may not work properly if the station you are tuned to is not transmitting the RDS signal properly, or if the signal strength is weak.

\* Not all FM stations provide RDS service, nor do they provide the same type of services. If you are not familiar with the RDS system, check with your local radio stations for details on RDS services in your area.

## Receiving RDS broadcasts

Simply select a station from the FM band. When you tune in a station that provides RDS services, the station name appears in the display.

### To check the RDS information

Each time you press DISPLAY, the display changes as follows:

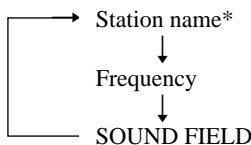

\* If the RDS broadcast is not received, the station name may not appear in the display.

# Naming Preset Stations

You can enter a name of up to 8 characters for preset stations. These names (for example, "XYZ") appear in the system's front panel display when a station is selected.

Note that no more than one name can be entered for each preset station.

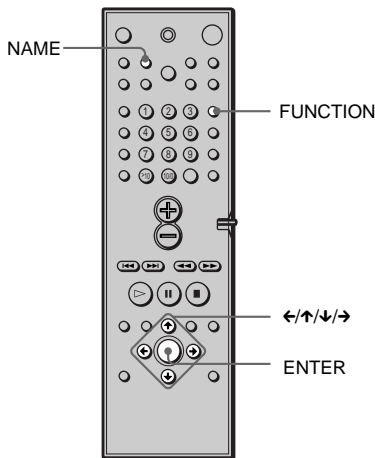

**1** Press **FUNCTION** repeatedly until **TUNER** appears on the front panel display.

The last station you received is tuned in.

Each time you press **FUNCTION**, the mode of the system changes in the following sequence:

DVD → VIDEO 1 → VIDEO 2 → TUNER → DVD...

**2** Tune in the preset station you want to create an index name for.

If you are not familiar with how to tune in preset stations, see "Listening to the Radio" on page 60.

continued

---

**3** Press NAME.

---

**4** Create an index name by using the cursor buttons:

Press ↓/↑ to select a character, then press → to move the cursor to the next position.

**If you make a mistake**

Press ← or → repeatedly until the character to be changed flashes, then press ↓/↑ to select the right character.

---

**5** Press ENTER.

---

**To assign index names to other stations**

Repeat Steps 2 to 5.

# Using the Setup Display



By using the Setup Display, you can make various adjustments to items such as picture and sound. You can also set a language for the subtitles and the Setup Display, among other things. For details on each Setup Display item, see page 64-70. For an overall list of Setup Display items, see page 80.

## How to use the Setup Display

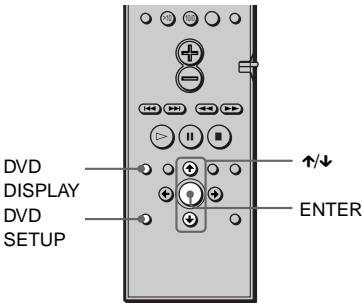

- 1** In stop mode, press DVD DISPLAY. The Control Menu appears. If you press DVD SETUP, you can go to Step 3 directly.
- 2** Press  $\uparrow/\downarrow$  to select  (SETUP), then press ENTER. The options for SETUP appear.

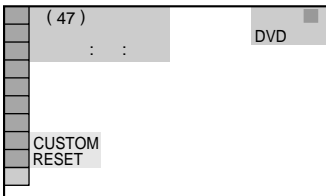

- 3** Press  $\uparrow/\downarrow$  to select "CUSTOM," then press ENTER. The Setup Display appears.

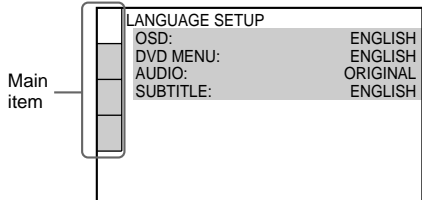

- 4** Press  $\uparrow/\downarrow$  to select the setup item from the displayed list: "LANGUAGE SETUP," "SCREEN SETUP," "CUSTOM SETUP," and "SPEAKER SETUP." Then press ENTER. The selected Setup item appears. Example: "SCREEN SETUP"

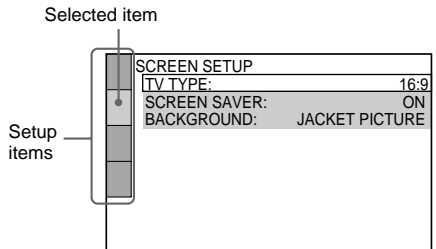

- 5** Select an item using  $\uparrow/\downarrow$ , then press ENTER.  
The options for the selected item appear.  
Example: “TV TYPE”

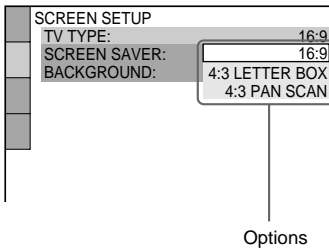

- 6** Select a setting using  $\uparrow/\downarrow$ , then press ENTER.  
The setting is selected and setup is complete.  
Example: “4:3 PAN SCAN”

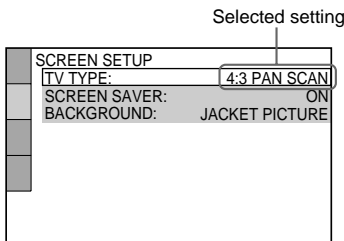

### To turn off the Setup Display

Press DVD SETUP or DVD DISPLAY repeatedly until the Setup Display is turned off.

 If you select “RESET” in Step 2, you can reset all of the “SETUP” settings on page 80 (except for PARENTAL CONTROL) to the default settings. After you select “RESET” and press ENTER, select “YES” to reset the settings (it takes a few seconds to complete), or select “NO” and press ENTER to return to the Control Menu. Do not press POWER or  $\text{\textcircled{P}}$  when resetting the system.

## Setting the Display or Sound Track Language (LANGUAGE SETUP)



“LANGUAGE SETUP” allows you to set various languages for the on-screen display or sound track.

Select “LANGUAGE SETUP” in the Setup Display. For details on using the display, see “Using the Setup Display” (page 63).

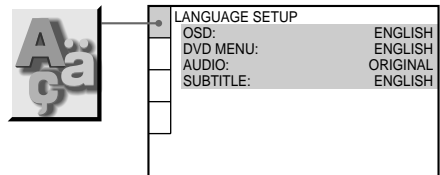

### ■ OSD (On-Screen Display)

Switches the display language on the screen. Selects the language from the displayed list.

### ■ DVD MENU (DVD only)

Selects the desired language for the DVD menu.

### ■ AUDIO (DVD only)

Switches the language of the sound track. Selects the language from the displayed list. When you select “ORIGINAL,” the language given priority in the disc is selected.

### ■ SUBTITLE (DVD only)

Switches the language of the subtitle. Selects the language from the displayed list. When you select “AUDIO FOLLOW,” the language for the subtitles changes according to the language you selected for the sound track.



 If you select “OTHERS →” in “DVD MENU,” “SUBTITLE,” or “AUDIO,” select and enter the language code from the list using the number buttons (page 79).

After you have made a selection, the language code (4 digits) is displayed the next time you select “OTHERS →.”

**Note**

If you select a language that is not recorded on the DVD, one of the recorded languages will be automatically selected (except for the “OSD”).

## Settings for the Display

(SCREEN SETUP) **DVD** **VIDEO CD** **SACD CD**

Choose settings according to the TV to be connected.

Select “SCREEN SETUP” in the Setup Display. For details on using the display, see “Using the Setup Display” (page 63).

The default settings are underlined.

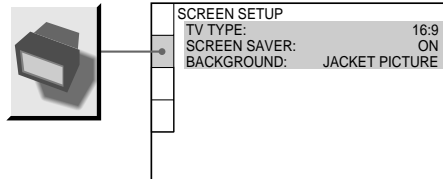

### ■ TV TYPE (DVD only)

Selects the aspect ratio of the connected TV (4:3 standard or wide).

The default settings vary, depending on the country model.

16:9	Select this when you connect a wide-screen TV or a TV with a wide mode function.
4:3 LETTER BOX	Select this when you connect a 4:3 screen TV. Displays a wide picture with bands on the upper and lower portions of the screen.
4:3 PAN SCAN	Select this when you connect a 4:3 screen TV. Automatically displays the wide picture on the entire screen and cuts off the portions that do not fit.

16:9

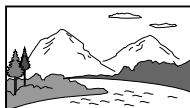

4:3 LETTER BOX



4:3 PAN SCAN



### Note

Depending on the DVD, “4:3 LETTER BOX” may be selected automatically instead of “4:3 PAN SCAN” or vice versa.

### SCREEN SAVER

Turns the screen saver on and off so that the screen saver image appears when you leave the system in pause or stop mode for 15 minutes, or when you play back a CD for more than 15 minutes. The screen saver will help prevent your display device from becoming damaged (ghosting). Press  $\blacktriangleright$  to turn off the screen saver.

ON	Turns on the screen saver.
OFF	Turns off the screen saver.

### BACKGROUND

Selects the background colour or picture on the TV screen in stop mode or while playing a CD.

JACKET PICTURE	The jacket picture (still picture) appears in the background, but only when the jacket picture is already recorded on the disc (CD-EXTRA, etc.). If the disc does not contain a jacket picture, the “GRAPHICS” picture appears.
GRAPHICS	A preset picture stored in the system appears in the background.
BLUE	The background colour is blue.
BLACK	The background colour is black.

## Custom Settings (CUSTOM

SETUP) DVD

VIDEO CD

SACD CD

Allows setting up Parental Control and other settings.

Select “CUSTOM SETUP” in the Setup Display. For details on using the display, see “Using the Setup Display” (page 63). The default settings are underlined.

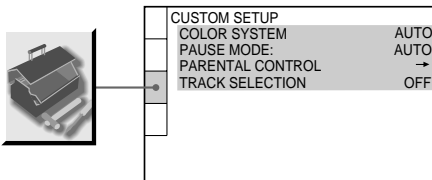

### COLOR SYSTEM for VIDEO CD playback (Asian models and Australian models only)

Select the colour system when you play a VIDEO CD.

AUTO	Outputs the video signal in the system of the disc, either PAL or NTSC. If your TV uses a DUAL system, select AUTO.
PAL	Changes the video signal of an NTSC disc and output in the PAL system.
NTSC	Changes the video signal of a PAL disc and outputs it in the NTSC system.

### Notes

- You cannot change the colour system of the disc itself.
- On Asian models or Australian models, you can change the colour system of this unit according to the connected TV. See page 23.

## ■ PAUSE MODE (DVD only)

Selects the picture in pause mode.

<u>AUTO</u>	The picture, including subjects that move dynamically, is output with no jitter. Normally select this position.
FRAME	The picture, including subjects that do not move dynamically, is output in high resolution.

## ■ PARENTAL CONTROL → (DVD only)

Sets a password and playback limitation level for DVDs with playback limitation for children. For details, see “Limiting playback for children (Parental Control)” (page 54).

## ■ TRACK SELECTION (DVD only)

Gives the sound track having the highest number of channels priority when you play a DVD on which multiple audio formats (PCM, MPEG audio, DTS, or Dolby Digital format) are recorded.

<u>OFF</u>	No priority given.
AUTO	Priority given.

## Notes

- When you set the item to “AUTO,” the language may change. The “TRACK SELECTION” setting has higher priority than the “AUDIO” settings in “LANGUAGE SETUP” (page 64).
- If PCM, DTS, MPEG audio, and Dolby Digital sound tracks have the same number of channels, the system selects PCM, DTS, Dolby Digital, and MPEG audio sound tracks in this order.
- Depending on the DVD, the audio channel with priority may be predetermined. In this case, you cannot give priority to the DTS, Dolby Digital, or MPEG audio format by selecting “AUTO.”

# Settings for the Speakers (SPEAKER SETUP)

To obtain the best possible surround sound, set the size of the speakers you have connected and their distance from your listening position. Then use the test tone to adjust the volume and the balance of the speakers to the same level.

Select “SPEAKER SETUP” in the setup display. For details, see “Using the Setup Display” (page 63).

The default settings are underlined.

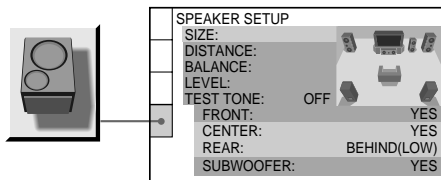

## To return to the default setting

Select the item, then press CLEAR.

## ■ SIZE

When you do not connect centre or rear speakers, or move the rear speakers, set the parameters for CENTER and REAR. Since the front speaker and subwoofer settings are fixed, you cannot change them. The default settings are underlined.

- FRONT
  - YES
- CENTER
  - YES: Normally select this.
  - NONE: Select this if no centre speaker is used.

• REAR

— BEHIND (LOW), BEHIND (HIGH), SIDE (LOW), SIDE (HIGH): Specify the position and height to implement the Digital Cinema Surround modes in the “Virtual Multi Dimension” sound field (page 48) properly.

— NONE: Select this if no rear speaker is used.

• SUBWOOFER

— YES

**Notes**

- When you select an item, the sound cuts off for a moment.
- Depending on the settings of other speakers, the subwoofer may output excessive sound.

**Specifying the rear speaker position and height**

If you select anything other than “NONE” in “REAR,” specify the position and height of the rear speakers. The default setting is underlined.

<u>BEHIND (LOW)</u>	Select this if the rear speakers are located in section <b>B</b> and <b>D</b> .
BEHIND (HIGH)	Select this if the rear speakers are located in section <b>B</b> and <b>C</b> .
SIDE (LOW)	Select this if the rear speakers are located in section <b>A</b> and <b>D</b> .
SIDE (HIGH)	Select this if the rear speakers are located in section <b>A</b> and <b>C</b> .

These parameters are not available when “REAR” is set to “NONE.”

Position diagram

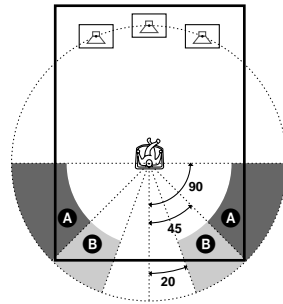

Height diagram

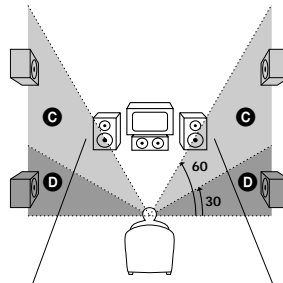

■ DISTANCE

The default distance setting for the speakers in relation to the listening position is shown below.

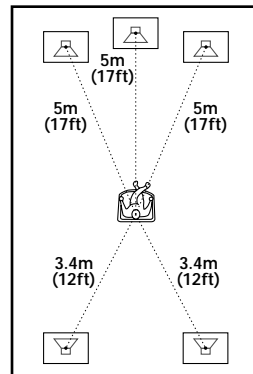

Be sure to change the value in the Setup Display when you move the speakers. The default adjustments are in parentheses.

FRONT (5m/17ft)	Front speaker distance from the listening position can be set in 0.2 meter (1 ft) increments from 1 to 15 meters (3 to 50 feet).
CENTER (5m/17ft)	Centre speaker distance can be moved up to 1.6 meters (5 ft) forward closer to the listening position, in 0.2 meter (1 ft) increments.
REAR (3.4m/12ft)	Rear speaker distance can be moved up to 4.6 meters (15 ft) closer to your listening position from the front speaker position, in 0.2 meter (1 ft) increments.

### Notes

- In SPEAKER SETUP, the North American model's OSD displays both metric and imperial measurements. The other model's displays metric measurements only. The manual also shows both.
- When you set the distance, the sound cuts off for a moment.
- If each of the front or rear speakers are not placed at an equal distance from your listening position, set the distance according to the closest speaker.
- Do not place the rear speakers farther away from your listening position than the front speakers.

### BALANCE

You can vary the balance of the left and right speakers as follows. Be sure to set "TEST TONE" to "ON" for easy adjustment. The default adjustments are in parentheses.

FRONT (CENTRE)	Adjust the balance between the front left and right speakers (You can adjust from centre 6 steps left or right).
REAR (CENTRE)	Adjust the balance between the rear left and right speakers (You can adjust from centre 6 steps left or right).

### LEVEL

You can vary the level of each speaker as follows. Be sure to set "TEST TONE" to "ON" for easy adjustment. The default adjustments are in parentheses.

CENTER (0dB)	Adjusts the level of the centre speaker (-6dB to +6dB, 1dB increments).
REAR (0dB)	Adjusts the level of the rear speakers (-6dB to +6dB, 1dB increments).
SUBWOOFER (0dB)	Adjusts the level of the subwoofer (-6dB to +6dB, 1dB increments).

### To adjust the volume of all the speakers at one time

Use the VOLUME control.

### TEST TONE

The speakers will emit a test tone to adjust "BALANCE" and "LEVEL."

OFF	The test tone is not emitted from the speakers.
ON	The test tone is emitted from each speaker in sequence while adjusting balance or level. When you select one of the "SPEAKER SETUP" items, the test tone is emitted from both left and right speakers simultaneously.

## Adjusting the speaker volume and level

- 1** After you stop playback, select "SPEAKER SETUP" after pressing DVD SETUP in the Setup Display.

---
- 2** Select "TEST TONE" and set "TEST TONE" to "ON."  
You will hear the test tone from each speaker in sequence.

---
- 3** From your listening position, select "BALANCE" or "LEVEL" and adjust the value of "BALANCE" and "LEVEL" using  $\uparrow/\downarrow$ .  
The test tone is emitted from both left and right speakers simultaneously.

---
- 4** Select "TEST TONE" and set "TEST TONE" to "OFF" to turn off the test tone.

---

### Note

When you adjust the speaker settings, the sound cuts off for a moment.

## Troubleshooting

If you experience any of the following difficulties while using the system, use this troubleshooting guide to help remedy the problem before requesting repairs. Should any problem persist, consult your nearest Sony dealer.

### Power

#### The power is not turned on.

- ➔ Check that the AC power cord (mains lead) is connected securely.

### Picture

#### There is no picture.

- ➔ The connecting cords are not connected securely.
- ➔ The connecting cords are damaged.
- ➔ The system is not connected to the correct TV input jack (page 22).
- ➔ The video input on the TV is not set so that you can view pictures from the system.

#### Picture noise appears.

- ➔ The disc is dirty or flawed.
- ➔ If the picture output from your system goes through your VCR to get to your TV, the copy-protection signal applied to some DVD programmes could affect picture quality. If you still experience problems even when you connect your system directly to your TV, try connecting your system to your TV's S video input (page 22).

#### Even though you set the aspect ratio in "TV TYPE" of "SCREEN SETUP," the picture does not fill the screen.

- ➔ The aspect ratio of the disc is fixed on your DVD.

#### The picture is black and white.

- ➔ Depending on the TV, the picture on the screen becomes black and white when you play a disc recorded in the NTSC colour system.

### Sound

#### There is no sound.

- ➔ The connecting cord is not connected securely.
- ➔ The connecting cord is damaged.
- ➔ Press MUTING on the remote if "MUTING ON" is displayed on the front panel display.
- ➔ The protective device on the system has been activated because of a short circuit. Turn off the system, eliminate the short-circuit problem and turn on the power again.
- ➔ The audio connecting cord is damaged. Replace it with a new one.
- ➔ The system is in pause mode or in Slow-motion Play mode. Press ▷ to return to normal play mode.
- ➔ Fast forward or fast reverse is performed. Press ▷ to return to normal play mode.
- ➔ Check the speaker settings (pages 24, 67).

#### The left and right sounds are unbalanced or reversed.

- ➔ Check that the speakers and components are connected correctly and securely.
- ➔ Adjust the front balance parameter in the LEVEL menu (pages 27, 67).

#### Severe hum or noise is heard.

- ➔ Check that the speakers and components are connected securely.
- ➔ Check that the connecting cords are away from a transformer or motor, and at least 3 meters (10 feet) away from a TV set or fluorescent light.
- ➔ Move your TV away from the audio components.
- ➔ The plugs and jacks are dirty. Wipe them with a cloth slightly moistened with alcohol.
- ➔ Clean the disc.

---

### **The sound loses stereo effect when you play a VIDEO CD, or a CD.**

- ➔ Set "AUDIO" to "STEREO" in the Control Menu display (page 45).
- ➔ Make sure you connect the system appropriately.

---

### **The surround effect is difficult to hear when you are playing a Dolby Digital sound track.**

- ➔ Make sure the sound field function is on (page 47).
- ➔ Check the speaker connections and settings (pages 24, 67).
- ➔ Depending on the DVD, the output signal may not be the entire 5.1 channel but monaural or stereo even if the sound track is recorded in Dolby Digital format.

---

### **The surround effect is difficult to hear when you are playing a Dolby Digital or MPEG audio sound track.**

- ➔ Check the speaker connections and setting (pages 24, 67).
- ➔ Depending on the DVD, the output signal may not be the entire 5.1 channels. It may be monaural or stereo even if the sound track is recorded in Dolby Digital or MPEG audio format.

---

### **The sound comes from the centre speaker only.**

- ➔ Depending on the disc, the sound may come from the centre speaker only.

---

### **No sound is heard from the centre speaker.**

- ➔ Make sure the sound field function is on (page 47).
- ➔ Select a sound field containing the word "cinema" or "virtual" (page 47).

---

### **No sound or only a very low-level sound is heard from the rear speakers.**

- ➔ Make sure the sound field function is on (page 47).
- ➔ Select a sound field containing the word "cinema" or "virtual" (page 47).

## **Operation**

---

### **Radio stations cannot be tuned in.**

- ➔ Check that the antennas are connected securely. Adjust the antennas and connect an external antenna if necessary.
- ➔ The signal strength of the stations is too weak (when tuning in with automatic tuning). Use direct tuning.
- ➔ No stations have been preset or the preset stations have been cleared (when tuning by scanning preset stations). Preset the stations (page 29).
- ➔ Press DISPLAY so that the frequency appears in the display.

---

### **The remote does not function.**

- ➔ There are obstacles between the remote and the system.
- ➔ The distance between the remote and the system is too far.
- ➔ The remote is not pointed at the remote sensor on the system.
- ➔ The batteries in the remote are weak.

---

### **The disc does not play.**

- ➔ There is no disc inside.
- ➔ The disc is turned over.  
Insert the disc with the playback side facing down on the disc tray.
- ➔ The disc is skewed.
- ➔ The system cannot play CD-ROMs, etc. (page 8).
- ➔ The region code on the DVD does not match the system.
- ➔ Moisture has condensed inside the system.  
Remove the disc and leave the system turned on for about half an hour (page 4).



---

### **The disc does not start playing from the beginning.**

- ➔ Programme Play, Shuffle Play, or Repeat Play has been selected (pages 35, 37, 38). Press CLEAR to cancel these functions before playing a disc.
- ➔ Resume Play has been selected. During stop, press ■ on the system or the remote and then start DVD playback (page 32).
- ➔ The title, DVD or PBC menu automatically appears on the TV screen.

---

### **The system starts playing the disc automatically.**

- ➔ The DVD features an auto playback function.

---

### **Playback stops automatically.**

- ➔ Some discs may contain an auto pause signal. While playing such a disc, the system stops playback at the auto pause signal.

---

### **You cannot perform some functions such as Stop, Search, Slow-motion Play, Repeat Play, Shuffle Play, or Programme Play.**

- ➔ Depending on the disc, you may not be able to do some of the operations above. See the operating manual that comes with the disc.

---

### **Messages do not appear on the screen in the language you want.**

- ➔ In the Setup Display, select the desired language for the on-screen display in “OSD” under “LANGUAGE SETUP” (page 64).

---

### **The language for the sound track cannot be changed.**

- ➔ Multilingual tracks are not recorded on the DVD being played.
- ➔ The DVD prohibits changing the language for the sound track.

---

### **The subtitle language cannot be changed.**

- ➔ Multilingual subtitles are not recorded on the DVD being played.
- ➔ The DVD prohibits changing the subtitles.

---

### **The subtitle cannot be turned off.**

- ➔ The DVD prohibits turning off subtitles.

---

### **The angles cannot be changed.**

- ➔ Multi-angles are not recorded on the DVD being played. The angle can be changed only when the “ANGLE” indicator lights up on the front panel display.
- ➔ The DVD prohibits changing the angles.

---

### **The system does not operate properly.**

- ➔ If static electricity, etc., causes the system to operate abnormally, press POWER on the system to turn the system off and then on again.

---

### **Nothing is displayed on the front panel display.**

- ➔ Press DIMMER on the remote.

---

### **A 5-character service number is displayed on the screen and on the front panel display.**

- ➔ The self-diagnosis function was activated. (See the table on page 74.)

---

### **The disc tray does not open and “LOCKED” appears on the front panel display.**

- ➔ Contact your Sony dealer or local authorized Sony service facility.

---

### **“PROTECT” appears on the front panel display.**

- ➔ The speaker protection circuit is in function. Check the speaker connections.

---

## Self-diagnosis Function

(When letters/numbers appear in the display)

When the self-diagnosis function is activated to prevent the system from malfunctioning. In this case a five-character service number (e.g., C 13 00) with a combination of a letter and digits appears on the screen and the front panel display. Refer to the following table.

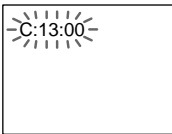

---

First three characters of the service number	Cause and/or Corrective Action
C 13	The disc is dirty. ➔ Clean the disc with a soft cloth (page 9).
C 31	The disc is not inserted correctly. ➔ Re-insert the disc correctly.
E XX (xx is a number)	To prevent a malfunction, the system has performed the self-diagnosis function. ➔ Contact your nearest Sony dealer or local authorized Sony service facility and give the 5-character service number. Example: E 61 10

---

---

## Glossary

### Bit rate

Value indicating the amount of video data compressed in a DVD per second. The unit is Mbps (Mega bit per second). 1 Mbps indicates that the data per second is 1,000,000 bits. The higher the bit rate is, the larger the amount of data. However, this does not always mean that you can get higher quality pictures.

---

### Chapter

Sections of a picture or a music piece on a DVD that are smaller than titles. A title is composed of several chapters. Each chapter is assigned a chapter number enabling you to locate the chapter you want.

---

### Digital Cinema Sound (DCS)

This is the generic name of the surround sound produced by digital signal processing technology developed by Sony. Unlike previous surround sound fields mainly directed at the reproduction of music, Digital Cinema Sound is designed specifically for the enjoyment of movies.

---

### Dolby Digital

This sound format for movie theaters is more advanced than Dolby Pro Logic Surround. In this format, the rear speakers output stereo sound with an expanded frequency range and a subwoofer channel for deep bass is independently provided. This format is also called "5.1" because the subwoofer channel is counted as 0.1 channel (since it functions only when a deep bass effect is needed). All six channels in this format are recorded separately to realize superior channel separation. Furthermore, since all the signals are processed digitally, less signal degradation occurs.

---

## Dolby Pro Logic Surround

As one method of decoding Dolby Surround, Dolby Pro Logic Surround produces four channels from two-channel sound. Compared with the former Dolby Surround system, Dolby Pro Logic Surround reproduces left-to-right panning more naturally and localizes sounds more precisely. To take full advantage of Dolby Pro Logic Surround, you should have one pair of rear speakers and a centre speaker. The rear speakers output monaural sound.

---

## DTS

Digital audio compression technology that the Digital Theater Systems, Inc. developed. This technology conforms to 5.1-channel surround. The rear channel is stereo and there is discrete subwoofer channel in this format. DTS provides the same 5.1 discrete channels of high quality digital audio. The good channel separation is realized because the all channel data is recorded discrete and processed in digital.

---

## DVD

A disc that contains up to 8 hours of moving pictures even though its diameter is the same as a CD.

The data capacity of a single-layer and single-sided DVD, at 4.7 GB (Giga Byte), is 7 times that of a CD. Furthermore, the data capacity of a dual-layer and single-sided DVD is 8.5 GB, a single-layer and double-sided DVD 9.4 GB, and a dual-layer and double-sided DVD 17 GB.

The picture data uses the MPEG 2 format, one of the worldwide standards of digital compression technology. The picture data is compressed to about 1/40 of its original size. The DVD also uses the variable rate coding technology that changes the data to be allocated according to the status of the picture.

The audio data is recorded in Dolby Digital as well as in PCM, allowing you to enjoy more real audio presence.

Furthermore, various advanced functions such as the multi-angle, multilingual, and Parental Control functions are provided with the DVD.

---

## Multi-angle function

Various angles, or viewpoints of the video camera, for a scene are recorded on some DVDs.

---

## Multilingual function

Several languages for the sound or subtitles in a picture are recorded on some DVDs.

---

## Parental Control

A function of the DVD to limit playback of the disc by the age of the users according to the limitation level in each country. The limitation varies from disc to disc; when it is activated, playback is completely prohibited, violent scenes are skipped or replaced with other scenes and so on.

---

## Playback Control (PBC)

Signals encoded on VIDEO CDs (Version 2.0) to control playback.

By using menu screens recorded on VIDEO CDs with PBC functions, you can enjoy playing simple interactive programmes, programmes with search functions, and so on.

---

## Region Code

This system is used to protect copyrights. A region number is allocated on each DVD system or DVD disc according to the sales region. Each region code is shown on the system as well as on the disc packaging. The system can play the discs that match its region code. The system can also play discs with the “” mark. Even when the region code is not shown on the DVD, the region limit may still be activated.

---

**Title**

The longest sections of a picture or a music piece on a DVD; a movie, etc., for a picture piece on video software; or an album, etc., for a music piece on an audio software. Each title is assigned a title number enabling you to locate the title you want.

---

**Track**

Sections of a picture or a music piece on a CD or VIDEO CD. Each track is assigned a track number enabling you to locate the track you want.

---

**VIDEO CD**

A compact disc that contains moving pictures.

The picture data uses the MPEG 1 format, one of the worldwide standards of digital compression technology. The picture data is compressed to about 1/140 of its original size. Consequently, a 12 cm VIDEO CD can contain up to 74 minutes of moving pictures. VIDEO CDs also contain compact audio data. Sounds outside the range of human hearing are compressed while the sounds we can hear are not compressed. VIDEO CDs can hold 6 times the audio information of conventional audio CDs.

There are 2 versions of VIDEO CDs.

- Version 1.1: You can play only moving pictures and sounds.
- Version 2.0: You can play high-resolution still pictures and enjoy PBC functions.

This system conforms to both versions.

---

**Super Audio CD (SACD)**

This audio format is based upon the current audio CD standards but includes a greater amount of information which provides higher quality sound. There are three types of discs: single layer, double layer and hybrid discs. The hybrid disc contains both standard audio CD and Super Audio CD information.

# Specifications

## AUDIO POWER SPECIFICATIONS

### POWER OUTPUT AND TOTAL HARMONIC DISTORTION:

With 6 ohm loads, both channels driven, from 120 – 10,000 Hz; rated 40 watts per channel minimum RMS power, with no more than 10 % total harmonic distortion from 250 milliwatts to rated output.

### Amplifier section

Stereo mode 40 W + 40 W (6 ohms at 1 kHz, THD 10 %)  
Surround mode Front: 40 W + 40 W  
Center\*: 40 W  
Rear\*: 40 W + 40 W (6 ohms at 1 kHz, THD 10 %)  
Subwoofer\*: 80 W (3 ohms at 100 Hz, THD 10 %)

\* Depending on the sound field settings and the source, there may be no sound output.

Inputs (Analog) VIDEO 1, 2:  
Sensitivity: 150 mV  
Impedance: 50 kilohms  
Inputs (Digital) VIDEO 2 (optical):  
Sensitivity: –  
Outputs (Analog) VIDEO 1 (AUDIO OUT):  
Voltage: 2 V  
Impedance: 1 kilohms  
PHONES:  
Accepts low- and high-impedance headphones  
Outputs (Digital) DIGITAL OUT (CD)  
Sensitivity: –

## SACD/DVD system

Laser Semiconductor laser  
(SACD:  $\lambda = 650$  nm)  
(CD:  $\lambda = 780$  nm)  
Emission duration: continuous  
Signal format system NTSC or NTSC/PAL  
Frequency response (at 2 CH STEREO mode)  
DVD (PCM): 2 Hz to 22 kHz ( $\pm 1.0$  dB)  
CD: 2 Hz to 20 kHz ( $\pm 1.0$  dB)  
Signal-to-noise ratio More than 80 dB (VIDEO 1 (AUDIO) connectors only)  
Harmonic distortion Less than 0.03 %

## FM tuner section

System PLL quartz-locked digital synthesizer system  
North American model: 87.5 – 108.0 MHz (100 kHz step)  
Other models: 87.5 – 108.0 MHz (50 kHz step)  
Antenna FM wire antenna  
Antenna terminals 75 ohms, unbalanced  
Intermediate frequency 10.7 MHz

## AM tuner section

System Tuner section:  
PLL quartz-locked digital synthesizer system

Tuning range	
North American model:	530 – 1,710 kHz (with the interval set at 10 kHz) 531 – 1,710 kHz (with the interval set at 9 kHz)
European, Middle Eastern, and Philipinne models:	531 – 1,602 kHz (with the interval set at 9 kHz)
Other models:	531 – 1,602 kHz (with the interval set at 9 kHz) 530 – 1,710 kHz (with the interval set at 10 kHz)
Antenna	Loop antenna

## Video section

Inputs	Video: 1 Vp-p 75 ohms
Outputs	Video: 1 Vp-p 75 ohms S-video: Y: 1 Vp-p 75 ohms C: 0.286 Vp-p 75 ohms

## Speakers

### Front

Speaker system	Bass reflex
Speaker unit	70 mm (2 <sup>7</sup> / <sub>8</sub> inches) dia. cone type, 15 mm ( <sup>5</sup> / <sub>8</sub> inches) dia. balance dome
Rated impedance	6 ohms
Dimensions (approx.)	100 × 100 × 110 mm (4 × 4 × 4 <sup>3</sup> / <sub>8</sub> inches) (w/h/d)
Mass (approx.)	0.86 kg (2 lb 9 oz)

### Centre/Rear

Speaker system	Bass reflex
Speaker unit	70 mm (2 <sup>7</sup> / <sub>8</sub> inches) dia. cone type
Rated impedance	6 ohms
Dimensions (approx.)	100 × 100 × 110 mm (4 × 4 × 4 <sup>3</sup> / <sub>8</sub> inches) (w/h/d)
Mass (approx.)	0.85 kg (2 lb 6 oz)

### Subwoofer

Speaker system	Bass reflex
Speaker unit	180 mm (7 <sup>1</sup> / <sub>8</sub> inches) dia. cone type
Rated impedance	3 ohms
Dimensions (approx.)	200 × 390 × 355 mm (7 <sup>7</sup> / <sub>8</sub> × 15 <sup>3</sup> / <sub>8</sub> × 14 inches) (w/h/d)
Mass (approx.)	6.4 kg (14 lb 13 oz)

## General

Power requirements	
North American model:	120 V AC, 60 Hz
European model:	220 – 240 V AC, 50/60 Hz
Australian and Asian models:	220 – 240 V AC, 50/60 Hz
Mexican model:	120 V AC, 60 Hz
Chinese model:	220 V AC, 50/60 Hz
Taiwan model:	110 – 120 V AC, 50/60 Hz
Other models:	110 – 240 V/220 – 240 V AC, 50/60 Hz
Power consumption	98 W (120 V AC) 98 W (230 V AC)
Dimensions (approx.)	355 × 70 × 378 mm (14 × 2 <sup>7</sup> / <sub>8</sub> × 15 inches) (w/h/d) incl. projecting parts
Mass (approx.)	4.0 kg (9 lb 8 oz)
Operating temperature	5°C to 35°C (41°F to 95°F)
Operating humidity	5 % to 90 %
Supplied accessories	See page 16.

Design and specifications are subject to change without notice.

# Language Code List

For details, see pages 45, 51, 65.

The language spellings conform to the ISO 639: 1988 (E/F) standard.

Code Language	Code Language	Code Language	Code Language
1027 Afar	1183 Irish	1347 Maori	1507 Samoan
1028 Abkhazian	1186 Scots Gaelic	1349 Macedonian	1508 Shona
1032 Afrikaans	1194 Galician	1350 Malayalam	1509 Somali
1039 Amharic	1196 Guarani	1352 Mongolian	1511 Albanian
1044 Arabic	1203 Gujarati	1353 Moldavian	1512 Serbian
1045 Assamese	1209 Hausa	1356 Marathi	1513 Siswati
1051 Aymara	1217 Hindi	1357 Malay	1514 Sesotho
1052 Azerbaijani	1226 Croatian	1358 Maltese	1515 Sundanese
1053 Bashkir	1229 Hungarian	1363 Burmese	1516 Swedish
1057 Byelorussian	1233 Armenian	1365 Nauru	1517 Swahili
1059 Bulgarian	1235 Interlingua	1369 Nepali	1521 Tamil
1060 Bihari	1239 Interlingue	1376 Dutch	1525 Telugu
1061 Bislama	1245 Inupiak	1379 Norwegian	1527 Tajik
1066 Bengali; Bangla	1248 Indonesian	1393 Occitan	1528 Thai
1067 Tibetan	1253 Icelandic	1403 (Afan)Oromo	1529 Tigrinya
1070 Breton	1254 Italian	1408 Oriya	1531 Turkmen
1079 Catalan	1257 Hebrew	1417 Punjabi	1532 Tagalog
1093 Corsican	1261 Japanese	1428 Polish	1534 Setswana
1097 Czech	1269 Yiddish	1435 Pashto; Pushto	1535 Tonga
1103 Welsh	1283 Javanese	1436 Portuguese	1538 Turkish
1105 Danish	1287 Georgian	1463 Quechua	1539 Tsonga
1109 German	1297 Kazakh	1481 Rhaeto- Romance	1540 Tatar
1130 Bhutani	1298 Greenlandic	1482 Kirundi	1543 Twi
1142 Greek	1299 Cambodian	1483 Romanian	1557 Ukrainian
1144 English	1300 Kannada	1489 Russian	1564 Urdu
1145 Esperanto	1301 Korean	1489 Russian	1572 Uzbek
1149 Spanish	1305 Kashmiri	1491 Kinyarwanda	1581 Vietnamese
1150 Estonian	1307 Kurdish	1495 Sanskrit	1587 Volapük
1151 Basque	1311 Kirghiz	1498 Sindhi	1613 Wolof
1157 Persian	1313 Latin	1501 Sangho	1632 Xhosa
1165 Finnish	1326 Lingala	1502 Serbo-Croatian	1665 Yoruba
1166 Fiji	1327 Laothian	1503 Singhalese	1684 Chinese
1171 Faroese	1332 Lithuanian	1505 Slovak	1697 Zulu
1174 French	1334 Latvian; Lettish	1506 Slovenian	
1181 Frisian	1345 Malagasy		1703 Not specified

# DVD Setup Menu List

You can set the following items with the DVD setup menu.  
The order of the displayed items may be different from the actual display.

## LANGUAGE SETUP

- OSD — (Select the language you want to use from the displayed language list.)
- DVD MENU — (Select the language you want to use from the displayed language list.)
- AUDIO — (Select the language you want to use from the displayed language list. When you select ORIGINAL, you can enjoy the language given priority on the disc.)
- SUBTITLE — (Select the language you want to use from the displayed language list. When you select AUDIO FOLLOW, the setting is automatically switched to the language selected in AUDIO.)

## CUSTOM SETUP

- COLOR SYSTEM\* — AUTO
  - PAL
  - NTSC
- PAUSE MODE — AUTO
  - FRAME
- PARENTAL CONTROL — LEVEL — OFF
  - 8.
  - 7. NC17
  - 6. R
  - 5.
  - 4. PG13
  - 3. PG
  - 2.
  - 1. G
- STANDARD — USA
  - OTHERS
- CHANGE PASSWORD
- TRACK SELECTION — OFF
  - AUTO

## SCREEN SETUP

- TV TYPE — 16:9
  - 4:3 LETTER BOX
  - 4:3 PAN SCAN
- SCREEN SAVER — ON
  - OFF
- BACKGROUND — JACKET
  - PICTURE
  - GRAPHICS
  - BLUE
  - BLACK

## SPEAKER SETUP

- SIZE — FRONT — YES
  - CENTER — YES
    - NONE
  - REAR — BEHIND — LOW
    - HIGH
  - SIDE — LOW
    - HIGH
  - NONE
- SUBWOOFER — YES
- DISTANCE\*\* — FRONT — 1m ~15m/  
3ft ~ 50ft
  - CENTER — 0m ~15m/  
0ft ~ 50ft
  - REAR — 0m ~15m/  
0ft ~ 50ft
- BALANCE — FRONT — 6 steps left or right
  - REAR — 6 steps left or right
- LEVEL — CENTER — -6 dB ~ +6 dB
  - REAR — -6 dB ~ +6 dB
  - SUBWOOFER — -6 dB ~ +6 dB
- TEST TONE — OFF
  - ON

\* Only for Asian models and Australian models.

\*\* In SPEAKER SETUP, the North American model's OSD displays both metric and imperial measurements. The other model's displays metric measurements only. The manual also shows both.



# Index

## Numerics

16:9 65  
4:3 LETTER BOX 65  
4:3 PAN SCAN 65

## A

ADVANCED 52  
AMP MENU 25  
ANGLE 50  
Antenna Hookups 20  
AUDIO 45, 64

## B

BACKGROUND 66  
BALANCE 27, 69  
BAND 29  
Batteries 17  
Bit rate 52, 74

## C

CD 31  
CHAPTER 40  
Chapter 7, 74  
Continuous play  
  CD/VIDEO SACD CD  
  DVD 31  
Control Menu 14  
CUSTOM PARENTAL  
CONTROL 53  
COLOR SYSTEM 66  
CUSTOM SETUP 66

## D

DIMMER 28  
DISTANCE 69  
Dolby Digital 75  
Dolby Pro Logic Surround 74  
DTS 75  
DVD 33, 75  
DVD MENU 33, 64

## F

Front Panel 10  
Fast forward 39  
Fast reverse 39  
Front panel display 11

## H

Handling discs 9

## I

INDEX 40  
Index 7

## L

LANGUAGE SETUP 64  
LEVEL 28, 70  
Locating  
  a specific Point  
  by watching the TV screen 39

## M

MEMORY 29  
Multi-angle function 50  
Multilingual function 45  
MUTING 32

## N

NAME 61

## O

On-screen display  
  Control Menu display 14  
  Setup Display 63  
OSD 64

## P

PARENTAL CONTROL 54, 67,  
75  
PAUSE MODE 67  
PBC Playback 34, 75  
PLAY MODE 35  
Preset Station 29, 60  
Programme Play 35

## Q

Quick Overview 16

## R

Radio 60  
RDS 61  
Rear Panel 12  
Region code 8, 75  
Remote 13, 58  
REPEAT 38  
RESET 64  
Resume Play 32

## S

SACD 76  
S VIDEO 22  
Scan 39  
SCENE 40  
Scene 7  
SCREEN SAVER 66  
SCREEN SETUP 65  
SHUFFLE 37  
Shuffle Play 37  
SIZE 67  
Slow-motion Play 39  
Sound Field 47  
SPEAKER SETUP 67  
Speaker System Hookup 17  
SUBTITLE 51, 64

## T

TEST TONE 70  
TIME SEARCH 41  
TIME 42  
TIME/TEXT 41  
TITLE 33, 40  
Title 7, 76  
Title menu 33  
TRACK 40  
Track 7, 76  
TRACK SELECTION 67  
Troubleshooting 71  
TV and Video Component  
  Hookups 22  
TV TYPE 65

## U

Usable discs 7

## V

VIDEO CD 34, 76







## Free Manuals Download Website

<http://myh66.com>

<http://usermanuals.us>

<http://www.somanuals.com>

<http://www.4manuals.cc>

<http://www.manual-lib.com>

<http://www.404manual.com>

<http://www.luxmanual.com>

<http://aubethermostatmanual.com>

Golf course search by state

<http://golfingnear.com>

Email search by domain

<http://emailbydomain.com>

Auto manuals search

<http://auto.somanuals.com>

TV manuals search

<http://tv.somanuals.com>