

Inside cover

These user's setup instructions cover typical user environments. The on-screen messages may differ depending on the level of your hardware and software. In some cases you may need to vary the setup procedures.

For more information, refer to your computer or operating system manuals or consult your system administrator or dealer.

Ces instructions de configuration d'exploitation s'appliquent aux environnements d'utilisation types. Les messages affichés à l'écran peuvent varier en fonction du niveau de votre matériel et de vos logiciels informatiques. Dans certains cas, vous pouvez être amenés à changer de procédures de configuration.

Pour de plus amples informations à ce sujet, veuillez vous reporter aux manuels de votre ordinateur et de votre système d'exploitation, ou consultez l'administrateur de votre système ou votre revendeur.

Diese Einstellungsanweisungen durch den Benutzer gelten für typische Betriebsumgebungen. Die Bildschirmmeldungen können je nach Art der verwendeten Hardware und Software auch anders lauten. In einigen Fällen müssen die Einstellungsschritte unter Umständen abgeändert werden.

Weitere Informationen finden Sie im Computer- oder Betriebssystemhandbuch, oder wenden Sie sich an Ihren Systemadministrator oder Fachhändler.

En estas instrucciones de configuración se describen entornos de usuarios típicos. Los mensajes en pantalla, pueden diferir según sea el nivel del hardware y del software. En algunos casos, necesitará seguir otros procedimientos para la configuración.

Para obtener más información, puede consultar los manuales del ordenador o del sistema operativo o ponerse en contacto con el administrador del sistema o con el distribuidor.

Queste istruzioni di configurazione per l'utente coprono gli ambienti operativi comuni. I messaggi che appaiono sul video possono differire a seconda dell'hardware e del software utilizzati. In alcuni casi potrebbe essere necessario variare le procedure di configurazione.

Per ulteriori informazioni, fare riferimento ai manuali del computer o del sistema operativo, o consultare il proprio amministratore di sistema o il concessionario.

 **DANGER**

To avoid electric shock hazard:

- The product is supplied with a grounded plug and power cord which should be used to connect to the AC supply.
- The power cord should only be used with a properly wired and grounded power outlet.
- Any equipment to which this product is attached must also be connected to a properly wired and grounded outlet.
- Do not remove the covers.
- The product does not incorporate an AC power switch. To isolate the monitor from the electrical supply, you must remove the plug from the power outlet. The power outlet should be easily accessible.
- Do not connect or disconnect this product during an electrical storm.
- Always use the AC adapter supplied with the monitor.

Handling:

- Handle this product with care when moving it.
- The panel should not be operated in a horizontal position.
- The fluorescent lamp used in the Liquid Crystal Display assembly contains a small quantity of mercury (less than 50 milligrams). For environmental reasons this product should not be disposed of into landfill. It must be disposed of as required by local ordinances or regulations.
- The Liquid Crystal Display assembly is made of glass and can break as a result of rough handling or dropping. This may lead under some circumstances to a small quantity of the liquid crystal material being exposed. Avoid contact with this material as it is an irritant. Should this material come into contact with eyes, hands, etc., the area should be washed with water for at least 15 minutes; medical care should be obtained if any symptoms are present after washing.

 **DANGER**

Pour éviter tout risque d'électrocution :

- Le produit est livré avec un cordon d'alimentation et une prise de terre à utiliser pour le branchement sur le secteur (VCA).
- Le cordon d'alimentation ne doit être branché que sur une prise électrique correctement câblée et mise à la terre.
- Tous les matériels auxquels ce produit est raccordé doivent également être branchés sur une prise électrique correctement câblée et mise à la terre.
- Ne pas enlever les capots de protection.
- Le produit ne possède aucun interrupteur de courant électrique (VCA). Pour isoler le moniteur de l'alimentation électrique, débrancher la fiche de la prise électrique. La prise électrique doit être facilement accessible.
- Ne pas brancher ou débrancher ce produit pendant un orage électrique.
- Toujours utiliser l'adaptateur électrique (VCA) fourni avec le moniteur.

Manipulation :

- Manipuler ce produit avec précaution pour le déplacer.
- Le panneau ne doit pas être utilisé en position horizontale.
- La lampe fluorescente de l'écran à cristaux liquides contient une faible quantité de mercure (moins de 50 milligrammes). Pour protéger l'environnement, ce produit ne doit pas être jeté dans une décharge. Il doit être éliminé conformément aux réglementations locales.
- L'écran à cristaux liquides est en verre. Il peut donc se briser en cas de chute ou de mauvaise manipulation. Si l'écran est brisé, une faible quantité de cristaux liquides risque de se répandre. Éviter tout contact avec cette matière irritante. Si des cristaux liquides rentrent en contact avec les yeux, les mains, etc., il faut alors laver cette zone avec de l'eau pendant au moins 15 minutes. Si des symptômes apparaissent après le lavage des zones concernées, contacter un médecin.

**GEFAHRENHINWEISE****Um der Gefahr eines elektrischen Schlags vorzubeugen:**

- Das Gerät wird mit einem geerdeten Stecker und Netzkabel geliefert, das zum Anschluß an die Wechselstromversorgung verwendet werden sollte.
- Das Netzkabel darf nur an eine ordnungsgemäß verkabelte und geerdete Steckdose angeschlossen werden.
- Alle Geräte, an die dieses Produkt angeschlossen ist, müssen ebenfalls an eine ordnungsgemäß verkabelte und geerdete Steckdose angeschlossen sein.
- Die Gehäusedeckel dürfen nicht entfernt werden.
- Das Gerät besitzt keinen Hauptschalter. Um die Stromversorgung zum Monitor zu unterbrechen, müssen Sie den Stecker aus der Steckdose ziehen. Die Steckdose sollte leicht zugänglich sein.
- Das Gerät darf während eines Gewitters nicht ein- oder ausgeschaltet werden.
- Verwenden Sie nur das im Lieferumfang des Monitors enthaltene Netzteil.

Handhabung:

- Seien Sie vorsichtig, wenn Sie das Gerät bewegen.
- Das Bedienfeld darf nicht bedient werden, wenn der Monitor auf der Seite liegt.
- Die in der LCD-Baugruppe verwendete Leuchtstofflampe enthält eine geringe Menge Quecksilber (unter 50 mg). Aus Umweltschutzgründen darf dieses Gerät nicht auf eine Mülldeponie gebracht werden, sondern muß gemäß den örtlichen Vorschriften und Verordnungen entsorgt werden.
- Die LCD-Baugruppe besteht aus Glas, das bei unsanfter Handhabung oder Fallenlassen des Geräts zerbrechen kann. In diesem Fall tritt unter Umständen eine geringe Menge flüssiges Quecksilber aus. Vermeiden Sie den Kontakt mit dieser Substanz, da es sich um einen Reizstoff handelt. Sollten Ihre Augen, Hände usw. damit in Berührung kommen, waschen Sie den betroffenen Bereich mindestens 15 Minuten mit Wasser aus. Wenn nach dem Auswaschen noch Beschwerden festzustellen sind, sollte ein Arzt zu Rate gezogen werden.

GEVAAR

Voor het vermijden van elektrische schokken:

- Dit product wordt geleverd met een voedingskabel voorzien van een geaarde stekker. Voor aansluiting op het lichtnet dient deze voedingskabel gebruikt te worden.
- De voedingskabel dient alleen gebruikt te worden in een stopcontact dat correct bedraad en geaard is.
- Alle apparatuur waar dit product op aangesloten is dient eveneens op een correct bedraad en geaard stopcontact aangesloten te zijn.
- Demonteer niet de dekplaten.
- Dit product is niet voorzien van een netschakelaar. Scheid de monitor van de netspanning door de stekker uit het stopcontact te nemen. Het stopcontact dient goed toegankelijk te zijn.
- Dit product niet tijdens onweer aansluiten of loskoppelen.
- Gebruik altijd de wisselspanningsadapter die bij de monitor meegeleverd is.

Hoe met het product omgegaan moet worden:

- Ga bij verplaatsingen voorzichtig met dit product om.
- Het bedieningspaneel mag niet in horizontale stand bediend worden.
- De fluorescerende lamp in het LCD-samenstel bevat een kleine hoeveelheid kwik (minder dan 50 mg). In verband met milieueisen mag dit product niet als normaal afval gestort worden. Men dient het te verwijderen volgens ter plaatse geldende regels en verordeningen.

Doordat het LCD-samenstel van glas gemaakt is kan het bij ruwe behandeling of als men het laat vallen, breken. In sommige omstandigheden kan dit tot gevolg hebben dat het vloeibare-kristalmateriaal vrijkomt. Vermijd contact met dit materiaal aangezien het irritaties kan veroorzaken. Als het materiaal in contact komt met ogen, handen, enz., dan moeten deze gedurende minstens 15 minuten met water gespoeld worden; als er na het spoelen nog steeds symptomen aanwezig zijn dient er medische hulp ingeroepen te worden.

PELIGRO

Para evitar el riesgo de descargas eléctricas:

- El producto se suministra con un enchufe con conexión a tierra y con un cable de alimentación para conectar al suministro de corriente alterna.
- Conecte el cable de alimentación sólo a un tomacorrientes con el cableado y conexión a tierra correctos.
- Este producto deberá conectarse a un equipo que esté también conectado a un tomacorrientes con el cableado y conexión a tierra correctos.
- No retire las cubiertas.
- En este producto no se incorpora un interruptor para alimentación de corriente alterna. Para aislar el monitor del suministro de energía eléctrica, desconéctelo del tomacorrientes. Asegúrese de utilizar una toma eléctrica de fácil acceso.
- No conecte o desconecte este producto durante una tormenta eléctrica.
- Utilice siempre el adaptador de corriente alterna que se suministra con el monitor.

Manipulación:

- Al mover el producto, hágalo con cuidado.
- El panel no debe ponerse en funcionamiento si se encuentra en posición horizontal.
- La lámpara fluorescente que se utiliza en la pantalla de cristal líquido (LCD) contiene una pequeña cantidad de mercurio (menos de 50 miligramos). No lo tire junto a basuras que se depositan en vertederos; hacerlo, podría resultar nocivo para el medio ambiente. Tenga en cuenta la normativa local en cuanto a eliminación de desechos.
- La pantalla de cristal líquido (LCD) es de cristal y puede romperse como resultado de un trato brusco o de una caída. Podría suceder que una pequeña cantidad del material de cristal líquido quedase al descubierto. Este material es irritante; evite tocarlo. Asegúrese de evitar el contacto de sus ojos, manos, etc., con el líquido. Si el líquido toca alguna de estas partes, lave el área afectada con agua corriente durante 15 minutos como mínimo y, luego, consulte a un médico.

**PERICOLO****Per evitare rischi di scosse elettriche:**

- Il prodotto è dotato di una spina e di un cavo di alimentazione con messa a terra che dovranno essere utilizzati per il collegamento all'alimentazione CA.
- Il cavo di alimentazione dovrà essere utilizzato esclusivamente con una presa elettrica adeguatamente cablata e con messa a terra.
- Si dovrà utilizzare una presa adeguatamente cablata e con messa a terra anche per eventuali apparecchiature alle quali il prodotto sia collegato.
- Non smontare le coperture.
- L'apparecchiatura non incorpora un interruttore dell'alimentazione CA. Per isolare il monitor dall'alimentazione elettrica è necessario staccare la spina dalla presa elettrica. La presa elettrica dovrà essere facilmente accessibile.
- Non collegare o scollegare il prodotto durante una tempesta elettrica.
- Utilizzare sempre l'adattatore CA fornito con il monitor.

Note di impiego:

- Maneggiare con cura il prodotto per spostarlo.
- Il monitor non deve essere utilizzato in posizione orizzontale.
- La lampada fluorescente installata nel display a cristalli liquidi (LCD) contiene una piccola quantità di mercurio (meno di 50 milligrammi). Pertanto, per ragioni dettate dalla tutela dell'ambiente, non utilizzare le normali discariche per lo smaltimento del prodotto ma attenersi ai regolamenti e alle ordinanze locali.
- Il display a cristalli liquidi è di vetro e, se lasciato cadere o non maneggiato con cautela, può rompersi. Ciò potrebbe causare in certe condizioni la fuoriuscita di una piccola quantità della sostanza che compone i cristalli liquidi. Evitare il contatto con tale sostanza perché è irritante. Se la sostanza dovesse venire a contatto con occhi, mani, ecc., risciacquare la parte interessata con acqua per almeno 15 minuti. Se, dopo aver risciacquato la parte, si avvertono eventuali sintomi, consultare un medico.

PERIGO

Para evitar o perigo de choques eléctricos:

- O produto é fornecido com uma ficha com massa e um cabo eléctrico que deverá ser utilizado para ligar à alimentação CA.
- O cabo eléctrico deve ser apenas utilizado com uma tomada devidamente electrificada e ligada à massa.
- Qualquer equipamento a que este produto se encontre ligado também tem que estar ligado a uma tomada devidamente electrificada e ligada à massa.
- Não tire as coberturas.
- O produto não possui um interruptor CA. Para isolar o monitor da alimentação eléctrica, tem que tirar a ficha da tomada. A tomada deverá estar num local de acesso fácil.
- Não ligue nem desligue este produto durante uma trovoadas.
- Utilize sempre o adaptador CA fornecido com o monitor.

Manuseamento:

- Manuseie este produto com cuidado quando o deslocar.
- O painel não deverá ser utilizado numa posição horizontal.
- A luz fluorescente utilizada no conjunto do visor de cristais líquidos (LCD) contém uma pequena quantidade de mercúrio (menos de 50 miligramas). Por razões de ordem ambiental este produto não pode ser eliminado num aterro sanitário. Terá que ser eliminado de acordo com as disposições e regulamentos locais.
- O conjunto do visor de cristais líquidos (LCD) é feito de vidro e pode partir-se se for tratado com falta de cuidado ou se cair. Estas situações, em certas circunstâncias, podem levar à exposição de uma pequena quantidade de cristais líquidos. Evite o contacto com este material porque se trata de um produto irritante. Se este material entrar em contacto com os olhos, mãos, etc., a área deverá ser lavada com água durante pelo menos 15 minutos; se, após, a lavagem detectar algum sintoma deverá consultar um médico.

FARE

Sådan undgås risiko for elektrisk stød:

- Dette produkt leveres med et jordstik og en netledning, som skal bruges ved tilslutning til strømnettet.
- Netledningen må kun bruges i en korrekt jordet og tilsluttet stikkontakt.
- Alt udstyr, som dette produkt tilsluttes til, skal også være tilsluttet en korrekt jordforbundet og tilsluttet stikkontakt.
- Dækslerne må ikke fjernes.
- Produktet har ingen strømafbryder. Hvis skærmen skal isoleres fra den elektriske strømkilde, skal stikket tages ud af stikkontakten. Stikkontakten skal være umiddelbart inden for rækkevidde.
- Tilslut og frakobl ikke dette produkt i tordenvejr.
- Benyt altid den vekselstrømsadapter, der fulgte med skærmen.

Håndtering:

- Behandl produktet forsigtigt, når det flyttes.
- Panelet må ikke betjenes i vandret stilling.
- Den fluorescerede pære i LCD-skærmen indeholder et mindre kvantum kviksølv (under 50 mg). Af hensyn til miljøet bør dette produkt ikke bortskaffes på en losseplads. Det skal bortskaffes i henhold til lokale love og regulativer.
- LCD-skærmen består af glas, der kan gå itu, hvis den behandles uforsigtigt eller tabes. Dette kan i visse tilfælde medføre udslip af en mindre mængde flydende krystaller. Undgå kontakt med dette materiale, da det kan give anledning til irritation. Hvis dette materiale kommer i kontakt med øjne, hænder osv. bør området skylles med vand i mindst 15 minutter. Kontakt lægen i tilfælde af symptomer efter skylningen.

ADVARSEL

Slik unngår du risiko for elektrisk støt:

- Produktet er utstyrt med et jordet støpsel og en jordet strømledning som skal brukes til å koble det til strømtilførselen.
- Strømledningen bør bare brukes i en riktig montert og jordet stikkontakt.
- Alt utstyr som dette produktet kobles sammen med, må også kobles til en riktig montert og jordet kontakt.
- Ta ikke av dekselet.
- Produktet har ingen strømbryter. Når du vil bryte strømtilførselen, må du ta ut støpselet fra kontakten. Kontakten bør være lett tilgjengelig.
- Koble ikke til eller fra produktet i tordenvær.
- Bruk alltid vekselstrømsadapteren som følger med skjermen.

Håndtering:

- Vær forsiktig når du flytter produktet.
- Panelet bør ikke brukes i vannrett stilling.
- Lysstoffrøret som er brukt i LCD-enheten, inneholder en liten mengde kvikksølv (mindre enn 50 gram). Av miljøhensyn må dette produktet ikke kastes i naturen, men må behandles som spesialavfall i henhold til lokale lover og regler.
- LCD-enheten består av glass som kan knuses hvis den behandles uforsiktig eller faller i bakken. I noen tilfeller kan dette føre til at litt av LCD-væsken renner ut. Unngå å komme i kontakt med materialet, da det kan forårsake irritasjoner. Hvis materialet kommer i kontakt med øynene, hendene e.l., bør det utsatte området skylles med vann i minst 15 minutter. Oppsøk lege hvis det fortsatt vises symptomer på irritasjon etter vask.

VARNING

Så här undviker du risk för elektriska stötar:

- Produkten är försedd med en jordad stickpropp och sladd för anslutning till eluttag.
- Nätssladden ska bara anslutas till ett korrekt installerat jordat eluttag.

- All utrustning som sammankopplas med denna produkt måste också anslutas till ett korrekt installerat jordat eluttag.
- Ta inte bort kåporna.
- Produkten är inte försedd med nätströmbrytare. Om du vill koppla bort skärmen från elnätet måste du dra ut stickproppen ur eluttaget. Eluttaget ska vara lättåtkomligt.
- Undvika att ansluta eller koppla bort produkten under åskväder.
- Använd alltid nätadaptern som följde med skärmen.

Hantering:

- Hantera produkten varsamt när du flyttar den.
- Panelen får inte användas i horisontellt läge.
- Lampan som används i LCD-enheten innehåller en liten mängd kvicksilver (mindre än 50 milligram). Av miljöskäl får den inte kasseras som vanligt avfall, utan måste kasseras enligt lokala förordningar och regler.
- LCD-enheten är tillverkad av glas och kan gå sönder om den utsätts för ovarsam hantering eller tappas i golvet. Detta kan under vissa omständigheter leda till att en liten mängd av flytande kristall (LCD)-materialet frigörs. Undvik kontakt med detta material eftersom det kan orsaka irritation. Om materialet skulle komma i kontakt med ögon, händer m m ska området spolras med vatten i minst 15 minuter; uppsök läkare om du har symptom efter spolningen.

⚠ VAROITUS

Sähköiskuvaaran välttäminen:

- Tuotteen mukana toimitetaan maadoitettu pistoke ja liitäntäjohto, joita pitäisi käyttää vaihtovirtasyöttöön kytkettäessä.
- Liitäntäjohton saa kytkeä vain asianmukaisesti johdotettuun ja maadoitettuun pistorasiaan.
- Kaikki laitteet, joihin tämä tuote liitetään, on myös kytkettävä asianmukaisesti johdotettuun ja maadoitettuun pistorasiaan.
- Älä poista suojakansia.
- Laitteessa ei ole vaihtovirtakatkaisijaa. Pistoke on poistettava pistorasiasta monitorin sähkövirran syötön katkaisemiseksi. Pistorasian pitäisi olla helposti käsiksi päästävässä paikassa.
- Älä kytke tuotetta päälle tai päältä ukonilmalla.
- Käytä aina monitorin mukana toimitettua vaihtovirta-adapteria.

Käsittely:

- Käsittele tuotetta varovasti siirtäessäsi sitä.
- Paneelia ei saa käyttää vaakasuorassa asennossa.
- Nestekidenäytössä käytetty loistelamppu sisältää pienen määrän elohopeaa (alle 50 milligrammaa). Ympäristönsuojeluyistä tätä tuotetta ei saa toimittaa kaatopaikalle, vaan se on hävitettävä paikallisten säännösten ja määräysten mukaisesti.

- Nestekidenäyttö on tehty lasista, ja se voi rikkoutua kovakouraisesti käsiteltäessä tai pudotettaessa. Joissakin olosuhteissa tällöin voi päästä vapaaksi pieniä määriä nestekideainetta. Vältä koskettamasta tätä ainetta, sillä se aiheuttaa ärsytystä. Jos aine pääsee kosketuksiin silmien, käsien ym. kanssa, aluetta pitää huuhdella vedellä vähintään 15 minuutin ajan; jos huuhtelun jälkeen havaitaan ärsytysoireita, on käännyttävä lääkärin puoleen.

KINΔYΝΟΣ

Για την αποφυγή κινδύνου ηλεκτροπληξίας:

- Το προϊόν αυτό είναι εφοδιασμένο με ένα γειωμένο φως και ηλεκτρικό καλώδιο τα οποία πρέπει να χρησιμοποιούνται για τη σύνδεση στην παροχή εναλλασσόμενου ρεύματος (AC).
- Το ηλεκτρικό καλώδιο θα πρέπει να συνδέεται μόνο σε πρίζες με κατάλληλη καλωδίωση και γείωση.
- Οι συσκευές στις οποίες θα συνδεθεί αυτό το προϊόν πρέπει επίσης να συνδέονται σε πρίζα με κατάλληλη καλωδίωση και γείωση.
- Μην αφαιρείτε τα καλύμματα.
- Το προϊόν δεν περιλαμβάνει ενσωματωμένο διακόπτη εναλλασσόμενου ρεύματος (AC). Για να απομονώσετε την οθόνη από την παροχή ρεύματος, πρέπει να αφαιρέσετε το φως από την πρίζα. Η πρίζα πρέπει να βρίσκεται σε σημείο εύκολα προσπελάσιμο.
- Μη συνδέετε ή αποσυνδέετε το προϊόν κατά τη διάρκεια ηλεκτροθύελλας.
- Να χρησιμοποιείτε πάντοτε τον προσαρμογέα AC που υπάρχει στη συσκευασία της οθόνης.

Χειρισμός:

- Ο χειρισμός του προϊόντος κατά τη μεταφορά του πρέπει να γίνεται με προσοχή.
- Η οθόνη δεν πρέπει να λειτουργεί σε οριζόντια θέση.
- Ο λαμπτήρας φθορισμού στην οθόνη υγρών κρυστάλλων (LCD) περιέχει μικρή ποσότητα υδραργύρου (λιγότερο από 50 mg). Για λόγους προστασίας περιβάλλοντος, το προϊόν αυτό δεν πρέπει να απορρίπτεται σε χωματερές. Κατά την απόρριχτή του πρέπει να ακολουθούνται οι κατά τόπους ισχύουσες σχετικές διατάξεις ή κανονισμοί.
- Η διάταξη της οθόνης υγρών κρυστάλλων αποτελείται από γυαλί και μπορεί να σπάσει σε περίπτωση βίαιου χειρισμού ή πτώσης. Σε μερικές περιπτώσεις, αυτό μπορεί να έχει ως αποτέλεσμα την έκθεση μικρής ποσότητας των υγρών κρυστάλλων. Αποφύγετε την επαφή με το υλικό αυτό γιατί πρόκειται για ερεθιστική ουσία. Εάν το υλικό έρθει σε επαφή με τα μάτια, τα χέρια κλπ, ξεπλύνετε την περιοχή με νερό για τουλάχιστον 15 λεπτά και συμβουλευτείτε ένα γιατρό αν κάποια συμπτώματα επιμένουν μετά το πλύσιμο.

TEHLİKE

Elektrik çarpması tehlikesinden kaçınmak için:

- Cihaz, elektrik bağlantısı için topraklanmış fişli bir elektrik kablosuyla birlikte gönderilmiştir.
- Elektrik kablosunun fişi, elektrik ve toprak bağlantıları usulüne uygun olarak yapılmış bir prize takılmalıdır.
- Bu cihazın bağlanacağı diğer tüm cihazlar da elektrik ve toprak bağlantıları usulüne uygun olarak yapılmış prize takılmış olmalıdır.
- Kapakları çıkarmayınız.
- Bu cihazda elektriği açma-kapama düğmesi yoktur. Monitörün elektrikle bağlantısını kesmek için fişini prizden çekmeniz gereklidir. Priz, kolayca erişilebilecek bir yerde olmalıdır.
- Bu cihazı elektriksiz fırtına sırasında prize takmayınız veya prizden çıkarmayınız.
- Daima monitörünüzle birlikte gönderilen elektrik adaptörünü kullanınız.

Kaldırma:

- Bu cihazı taşıırken dikkatli olunuz.
- Panel yatay konumda çalıştırılmamalıdır.
- LCD ekranın içindeki floresan lamba az miktarda (50 mg'den az) cıva içerir. Çevre kirlenmesine meydan vermemek için bu ürün şehir çöplüğüne atılmamalıdır. Yerel yönetmeliklerde belirtilen şekilde yok edilmelidir.
- LCD ekran birimi camdan yapılmıştır ve özenle taşınmadığı ya da düşürüldüğü takdirde kırılabilir. Bu, bazı durumlarda az miktarda sıvı kristal maddesinin açığa çıkmasına neden olabilir. Bu madde tahriş edici olduğu için ona dokunmayınız. Bu madde cildinize, ellerinize vb temas ederse, etkilenen yer 15 dakika akar su altında yıkanmalıdır; yıkadıktan sonra da belirtiler devam ederse tıbbi yardım istenmelidir.

First Edition (JUN 1999)

This publication could contain technical inaccuracies or typographical errors. Changes are made periodically to the information herein; these changes will be made in later editions. IBM may make improvements and/or changes in the product(s) and/or program(s) at any time.

It is possible that this publication may contain reference to, or information about, IBM products (machines and programs), programming, or services that are not announced in your country.

Requests for copies of this publication and for technical information about IBM products should be made to your IBM Authorized Dealer or IBM Retailer.

No part of this publication may be reproduced or distributed in any form or by any means without prior permission in writing from the International Business Machines Corporation.

© Copyright International Business Machines Corporation 1998. All rights reserved.

Notices

References in this publication to IBM products, programs, or services do not imply that IBM intends to make these available in all countries in which IBM operates. Any reference to an IBM product, program or service is not intended to state or imply that only IBM's product, program, or service may be used. Any functionally equivalent product, program, or service that does not infringe any of IBM's intellectual property rights or other legally protectable rights may be used instead of the IBM product, program, or service. Evaluation and verification of operation in conjunction with other products, programs, or services, except those expressly designated by IBM, are the user's responsibility.

IBM may have patents or pending patent applications covering subject matter in this document. The furnishing of this document does not give you any license to these patents.

Trademarks

The following terms, used in this publication, are trademarks or service marks of the IBM Corporation in the United States or other countries:

IBM HelpCenter

ENERGY STAR is a U.S. registered mark.

Windows 95 and 98 are Trademarks of Microsoft

Table of Contents

Introduction	
Features.....	A1
Important Precautions	
On Installation.....	A2
On Cleaning.....	A2
On Repacking.....	A2
Connecting the Monitor	
Connect to any IBM PC.....	A3
Connect to an APPLE Macintosh System.....	A4
Setup Diskette for Windows 95/98	
Monitor Installation Disk for Windows® 95/98.....	A5
Location and Function of Controls	
Front View.....	A6
Rear View.....	A6
On Screen Display (OSD) Control Adjustment	A7
Control Panel Function	A7
On Screen Display (OSD) Selection and Adjustment	A9
Video Memory Modes	
Factory Preset Timing Signal Chart.....	A12
Factory Preset modes.....	A13
User Modes.....	A14
Recalling Display Modes.....	A14
Power Management System	
Power Consumption.....	A15
MPR II, Self Diagnostics and DDC	
Low Radiation Compliance (MPR II).....	A16
Self Diagnostics.....	A16
DDC (Display Data Channel).....	A16
Troubleshooting and Further Help	
Troubleshooting.....	A17
Further Help.....	A18
Specifications	
Specifications.....	A19
Compliances	A21
Environmental Labelling of Personal Computers	See back of manual
Warranty	See back of manual

Introduction

The 9483 Flat Panel Monitor has an active matrix TFT (Thin-Film Transistor) LCD (Liquid Crystal Display).

This monitor is designed for use in small working areas or for those who need more working space on the desk.

Features

The 9483 is a 15.1-inch (15.1 inches viewable) intelligent Microprocessor based monitor.

The microprocessor-based 9483 monitor will automatically lock onto the popular VESA standard video modes and to the MAC video modes as defined on pages A12 and A13 of this guide.

Screen images are easily adjusted via the digital controls and OSD(On Screen Display).

It supports resolutions up to 1024x768, and has a wide viewing angle of ± 60 degrees horizontal and ± 45 degrees vertical.

The monitor is shipped with 14 factory pre-programmed video modes that are permanently resident. In addition, there are 4 user-storable modes, for a total of 18 memory modes.

Important Precautions

On Installation

1. Do not allow anything to rest upon or roll over the power cord, and do not place the monitor where the power cord is subject to damage.
2. Do not use this monitor near water such as near a bathtub, washbowl, kitchen sink, laundry tub, in a wet basement, or near a swimming pool.
3. Monitors are provided with ventilation openings in the cabinet to allow the release of heat generated during operation. If these openings are blocked, built-up heat can cause failures which may result in a fire hazard. Therefore, NEVER:
 - Block the bottom ventilation slots by placing the monitor on a bed, sofa, rug, etc.
 - Place the monitor in a built-in enclosure unless proper ventilation is provided.
 - Cover the openings with cloth or other material.
 - Place the monitor near or over a radiator or heat source.
4. Do not rub or strike the Active Matrix LCD with anything hard as this may scratch, mar, or damage the Active Matrix LCD permanently.
5. Do not press the LCD screen with your finger for a long time as this may incur some afterimages.
6. The LCD contains over 2,300,000 thin-film transistors (TFTs). A small number of missing, discolored, or lighted dots on the screen this is an intrinsic characteristic of TFT LCD technology and is not an LCD defect. If there is a problem with the LCD, contact your IBM representative.
7. Optimum performance of your 9483 is achieved at 1024x768@60Hz. Other modes should be used for diagnostic & setup purpose only.

On Cleaning

- Unplug the monitor before cleaning the face of the LCD Screen.
- Dust the monitor by wiping the screen and the cabinet with a soft, clean cloth. If the screen requires additional cleaning, use a clean, damp cloth.
- Do not use liquid cleaners, solvents or abrasives to clean this product.

On Repacking

- Do not throw away the carton and packing materials. They make an ideal container in which to transport the unit. When shipping the unit to another location, repack it in its original material.

Connecting the Monitor

On the back of the monitor are two plug-in connections; one for the AC power cord, and the other is for the signal cable from the video card.

Connect to any IBM PC

- 1** Power off both the monitor and PC.
- 2** Connect the 15-pin VGA connector of the supplied signal cable to the output VGA video connector on the PC and the matching input connector on the rear of the monitor. The connectors will mate only one way. If you cannot attach the cable easily, turn the connector upside down and try again. When mated, tighten the thumbscrews to secure the connection.
- 3** Connect the plug from the AC-DC adapter into the connector on the display unit. **1** Connect one end of the AC power cord into the AC-DC adapter. **2** Plug the other end into a properly grounded AC outlet. **3**
- 4** Power ON the PC, then the monitor.
- 5** If you see the **Check Signal Cable** message, check the signal cable and connectors.
- 6** After using the system, power OFF the monitor, then the PC.

Note : If you see the "Outside Range Limits" message, check to make sure your system is set to one of the factory preset modes.(See pages A12 and A13)

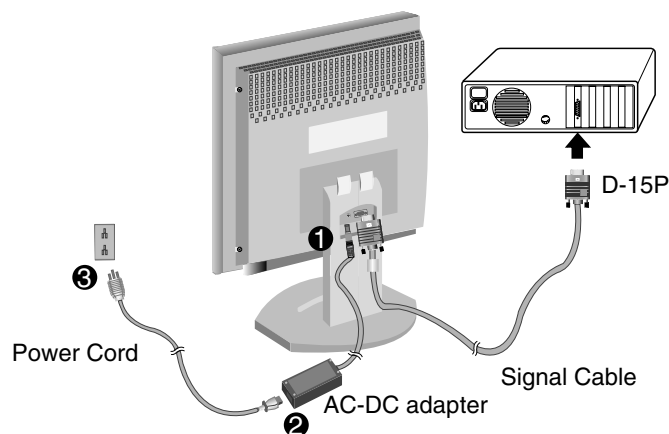

A3

Connecting the Monitor

Connect to an APPLE Macintosh System

Figure shows the connection to an Apple Macintosh, using a separately purchased adapter. For more information on adapter requirements, contact your IBM authorized dealer for PartNumber 96G2694.

- 1** Power OFF both the monitor and the MAC.
- 2** Locate the appropriate MAC to VGA adapter block at your local computer store. This adapter changes the high density 3 row 15 pin VGA connector to the correct 15 pin 2 row connection to mate with your MAC. Attach the other end of the signal cable to the side of the adapter block with 3 rows.
- 3** Connect the attached adapter block/signal cable to the video output on your MAC.
- 4** Connect the plug from the AC-DC adapter into the connector on the display unit. **1** Connect one end of the AC power cord into the AC-DC adapter. **2** Plug the other end into a properly grounded AC outlet. **3**
- 5** Power ON the MAC, then the monitor.
- 6** If you see the **Check Signal Cable** message, check the signal cable and connectors.
- 7** After using the system, power OFF the monitor, then the MAC.

Note : If you see the "Outside Range Limits" message, check to make sure your system is set to one of the factory preset modes.(See pages A12 and A13)

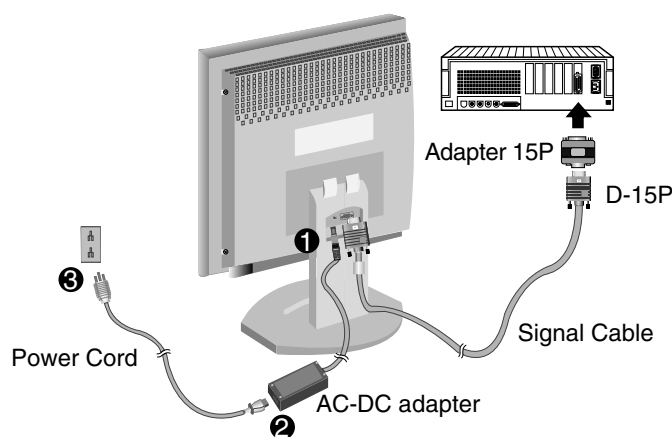

A4

Setup Diskette for Windows 95/98

Monitor Installation Disk for Windows® 95/98

To use the Plug and Play feature in Windows 95 or Windows 98, files should be loaded from the IBM color LCD Monitor Installation diskette as follow:

- 1** Ensure that the monitor is connected correctly.
- 2** Turn on the monitor and then the system unit. Allow the system to boot into windows 95 or 98. The Operating system's Plug and Play code may advise you that your system hardware has changed. If this is the case, it means that it has detected your new monitor for the first time.
- 3** Open the **Display Properties** windows by clicking on **Start, Setting, Control Panel** and then double clicking on the **Display** icon.
- 4** Select the **settings** tab.
- 5** Select the **Change Display type** button.
- 6** Select the **Change Monitor Type** button.
- 7** Insert the setup diskette into drive A: and select the **Have Disk** button.
- 8** Select **OK**.
- 9** Choose IBM 9483 monitor and select OK.
The files will be copied from the diskette to your hard drive.
- 10** If the selected model name is correct, Close all open windows and take the disk out from the disk drive.
- 11** Restart the system to activate the setting.

Note: On LCD monitors, unlike CRTs, a faster refresh rate does not improve display quality. IBM recommends using 1024 x 768 at a refresh rate of 60Hz.

Windows 95 and 98 are Registered Trademarks of Microsoft Inc.

Location and Function of Controls

Front View

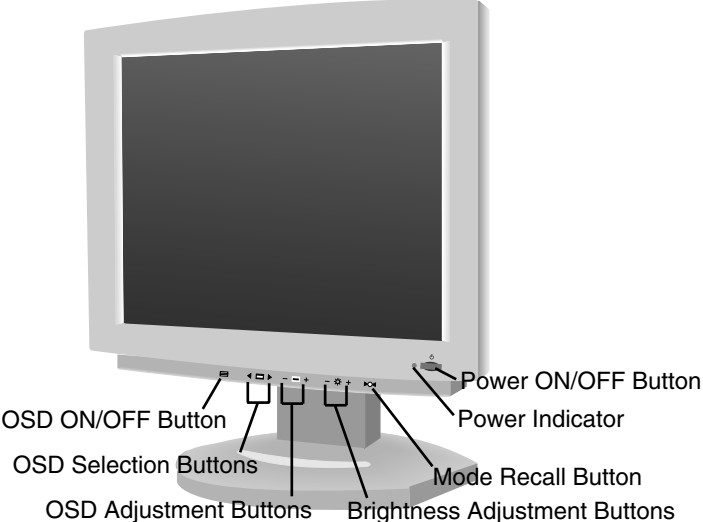

Rear View

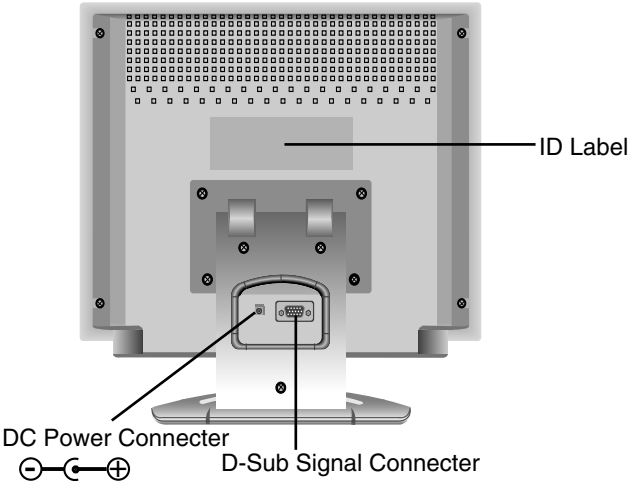

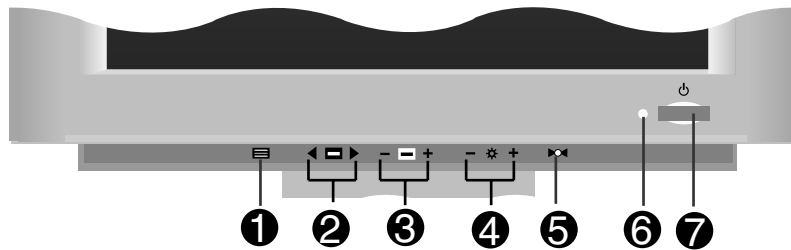

On Screen Display(OSD) Control Adjustment

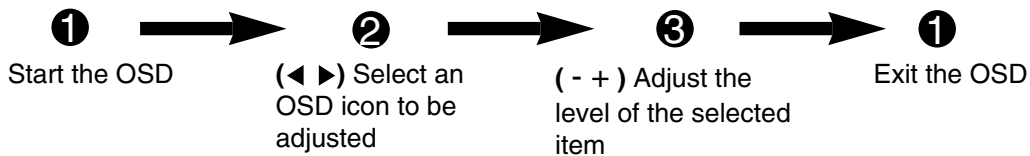

Control Panel Function

Buttons on the underside of the monitor allow you to adjust the image easily through an OSD menu. As you choose controls, the selected icon shows you what the chosen control will do. These pictures give you immediate understanding of the controls. The following is a description of use for each button.

- 1** **OSD ON/OFF Button** ()
Use this button to start and exit from the On Screen Display (OSD).
- 2** **OSD Selection Buttons** (◀ ▶)
Use these buttons for selecting (highlighting) an OSD icon to be adjusted.
- 3** **OSD Adjustment Buttons** (- +)
Use these buttons for adjusting the level of the selected item.
- 4** **Brightness Adjustment Buttons** (☀)
Use these buttons for adjusting the brightness of screen.

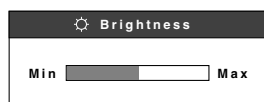

Control Panel Function

⑤ Mode Recall Button (▶○◀)

If the monitor is operating in a factory preset mode, this control will reset the image to the factory preset mode.

If the monitor is operating in a user mode, this control has no effect.

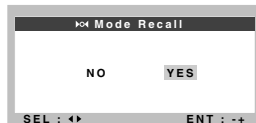

⑥ Power Indicator (○)

This Indicator lights up green when the monitor operates normally.

If the monitor is in DPM (Energy Saving) mode (stand-by/ suspend/power off), this indicator color changes to amber.







⑦ Power ON/OFF Button ()

This button is used to turn the monitor ON and OFF.

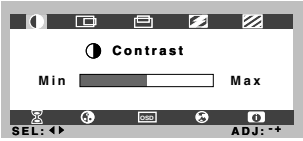
On Screen Display (OSD) Selection and Adjustment

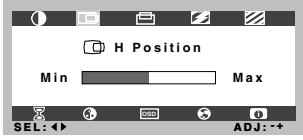
You were introduced to the procedure of selection and adjusting an item using the OSD system.

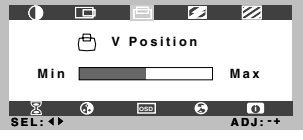
Listed below are the icons, icon names, and icon descriptions of the items that are shown on the Menu.

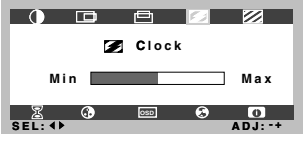
OSD Adjust	Description
 <p>Contrast</p> 	To adjust the display to the contrast desired.
 <p>H Position</p> 	<p>To move picture image left and right.</p> <ul style="list-style-type: none"> - Moves the screen image left. + Moves the screen image right.
 <p>V Position</p> 	<p>To move image up and down.</p> <ul style="list-style-type: none"> - Moves the screen image down. + Moves the screen image up.
 <p>Clock</p> 	<p>To minimize any vertical bars or stripes visible on the screen background. The horizontal screen size will also change.</p>





NOTE :

- To obtain the optimum performance from your new monitor it may be necessary to perform fine adjustments of "Clock" and "Clock Phase" controls. This may require to be done on the first usage of a mode to eliminate vertical bars and horizontal noise respectively.

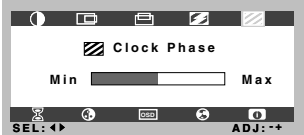

- Optimum mode is 1024 x 768 @ 60Hz

Use of 50% grey background is not recommended.

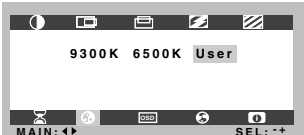
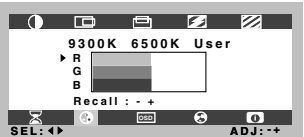
On Screen Display (OSD) Selection and Adjustment

OSD Adjust	Description
<p> Clock Phase</p> 	<p>To adjust the focus of the display. This item allows you to remove any horizontal noise and clear or sharpen the image of characters.</p>
<p> OSD Time</p> 	<p>To select OSD display duration time. (5 - 100 seconds)</p>
<p> Color Select</p>  	<p>To select color temperature, 9300K/ 6500K and USER.</p> <p>9300K : Slightly bluish white. 6500K : Warm-white tone, similar to white paper or daylight. This temperature is good for video-image display. This is the default setting for your monitor.</p> <p>Select the desired color temperature or select user to set your own color levels.</p> <p>To adjust USER, select the + button. Allow for specific adjustments to Red, Green, Blue (R/G/B) and (Color) Recall. Select the Recall to reset the color to the default setting.</p>

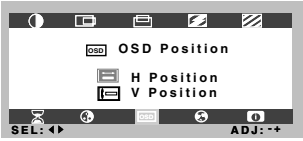
On Screen Display (OSD) Selection and Adjustment

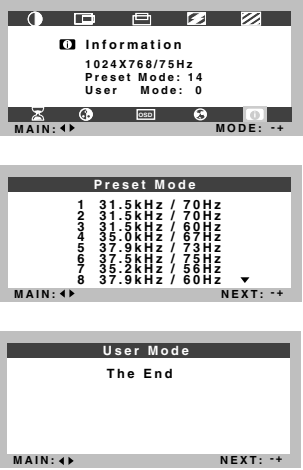
OSD Adjust	Description
<p>OSD OSD Position</p> 	<p>This item gives access to 2 elements : Horizontal position and Vertical position. Press the select button to select the desired item to change. To correct OSD image's Horizontal position and Vertical position. Horizontal position : To move image right and left. Vertical position : To move image up and down.</p>
<p>Language Select</p> 	<p>To choose the language in which the control names are displayed. OSD Menus are available in five language : English, German, French, Spanish, and Italian.</p>
<p>Information</p> 	<p>To inform users of preset and user mode data.</p>

Video Memory Modes

The monitor has 18 memory locations for display modes, 14 of which are factory preset to popular video modes.

Factory Preset Timing Signal Chart

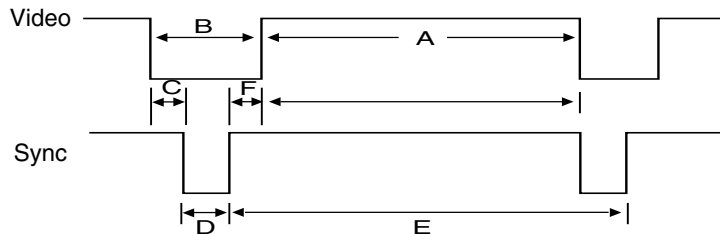

		Mode1	Mode2	Mode3	Mode4	Mode5	Mode6	Mode7	Symbol	
H O R I Z O N T A L	Polarity	+	-	-	-	-	-	+		
	Frequency	kHz	31.468	31.468	31.469	35.00	37.861	37.50	35.156	
	Total Period	pixels	800	900	800	864	832	840	1024	E
	Data Period	pixels	640	720	640	640	640	640	800	A
	Blanking	pixels	160	180	160	224	192	200	224	B
	Front Porch	pixels	16	17	16	64	24	16	24	C
	Pulse Width	pixels	96	108	96	64	40	64	72	D
	Back Porch	pixels	48	55	48	96	128	120	128	F
V E R T I C A L	Polarity	-	+	-	-	-	-	+		
	Frequency	Hz	70	70	60	66.67	72.8	75.0	56.25	
	Total Period	lines	449	449	525	525	520	500	625	E
	Data Period	lines	350	400	480	480	480	480	600	A
	Blanking	lines	99	49	45	45	40	20	25	B
	Front Porch	lines	37	13	10	3	9	1	1	C
	Pulse Width	lines	2	2	2	3	3	3	2	D
	Back Porch	lines	60	34	33	39	28	16	22	F
Resolution		640 x350	720 x400 (Text)	640 x480	640 x480	640 x480	640 x480	800 x600		
Recall		YES	YES	YES	YES	YES	YES	YES		

Note : Timings are as detailed in VESA "Display Monitor Timing Specification". Version 1.0, Revision 0.7, Dated 12/18/96.

Factory Preset Modes

		Mode8	Mode9	Mode10	Mode11	Mode12	Mode13	Mode14	Symbol	
H O R I Z O N T A L	Polarity	+	+	+	-	-	-	+		
	Frequency	kHz	37.879	48.077	46.875	49.725	48.363	56.476	60.023	
	Total Period	pixels	1056	1040	1056	1152	1344	1328	1312	E
	Data Period	pixels	800	800	800	832	1024	1024	1024	A
	Blanking	pixels	256	240	256	320	320	304	288	B
	Front Porch	pixels	40	56	16	32	24	24	16	C
	Pulse Width	pixels	128	120	80	64	136	136	96	D
	Back Porch	pixels	88	64	160	224	160	144	176	F
V E R T I C A L	Polarity	+	+	+	-	-	-	+		
	Frequency	Hz	60.3	72.188	75.0	74.55	60.0	70.0	75.0	
	Total Period	lines	628	666	625	667	806	806	800	E
	Data Period	lines	600	600	600	624	768	768	768	A
	Blanking	lines	28	66	25	43	38	38	32	B
	Front Porch	lines	1	37	1	1	3	3	1	C
	Pulse Width	lines	4	6	3	3	6	6	3	D
	Back Porch	lines	23	23	21	39	29	29	28	F
Resolution		800 x600	800 x600	800 x600	832 x624 (MAC)	1024 x768	1024 x768	1024 x768		
Recall		YES	YES	YES	YES	YES	YES	YES		

Note : Timings are as detailed in VESA "Display Monitor Timing Specification". Version 1.0, Revision 0.7, Dated 12/18/96.

User Modes

Modes 15-18 are empty and can accept new video data. If the monitor detects a new video mode that has not been present before or is not one of the preset modes, it stores the new mode automatically in one of the empty modes starting with mode 15.

If you use the 4 blank modes and still have more new video modes, the monitor replaces the information in the user modes starting with mode 15.

Recalling Display Modes

When your monitor detects a mode it has seen before, it automatically recalls the image settings you may have made the last time you used that mode.

You may, however, manually force a recall of each of the 14 preset modes by pressing the Recall button. All preset modes are automatically recalled as the monitor senses the incoming signal.

The ability to recall the preset modes is dependent on the signal coming from your PC's video card or system. If this signal does not match any of the factory modes, the monitor automatically sets itself to display the image.

Power Management System

This monitor incorporates new circuitry for lowering energy usage during idle time, following the Display Power Management Signalling (DPMS) guide lines of the Video Electronics Standards Association (VESA), as an Energy Star Partner, IBM has determined that this product meets the Energy Star guidelines for energy efficiency.

For the power savings feature to operate, the monitor must be used with a PC having power saving circuitry. The monitor has three power-saving states, and the power saving operation is indicated by the power indicator on the front panel. When the power indicator is green, operation is normal. When the power indicator is amber, the monitor is in a power saving mode.

If the power indicator is amber, press the power button to turn on the monitor. If the power indicator is amber and you wish to use the PC again, move your mouse pointer or touch a keyboard button. When the monitor is not in use, save energy by turning it off.

Power Consumption

Mode	H.Sync	V.Sync	Video	Power Consumption	LED Color
Normal(Max.)	On	On	Normal	≤ 36W	Green
Stand-by	Off	On	Off	≤ 5W	Amber
Suspend	On	Off	Off	≤ 5W	Amber
Power off	Off	Off	Off	≤ 5W	Amber

Low Radiation Compliance (MPR II)

This monitor meets one of the strictest guidelines available today for low radiation emissions, offering the user extra shielding and an anti-static screen coating. These guidelines, set forth by a government agency in Sweden, limit the amount of emission allowed in the Extremely Low Frequency (ELF) and Very Low Frequency (VLF) electromagnetic range.

Self Diagnostics

This monitor can sense when there is a possible problem present and informs you of this condition by presenting you with a **SELF DIAGNOSTICS** OSD. This OSD may pop up when it is **ON** but no signal is detected. In this case the message **Check Signal Cable** will be highlighted, alerting you to check the signal cable connections.



DDC (Display Data Channel)

DDC is a communication channel over which the monitor automatically informs the host system (PC) about its capabilities. This monitor has DDC function; DDC2B carries out uni-directional communication between the PC and the monitor. Under these situations, the PC sends display data to the monitor but not commands to control the monitor settings.

- NOTE :**
- PC must support DDC functions to do this.
 - Some older computer systems are not compatible with the DDC standard. If your monitor is displaying a monochrome image or the wrong resolution, you need to change to a DDC compatible VGA card.

Troubleshooting

Any horizontal noise appearing in any image or characters are not clearly portrayed.

- The input signal data has not been optimized for the current operating mode. (Adjust the CLOCK PHASE by using the OSD function.)

Check Signal Cable message.

- The signal cable is not connected.

Outside Range Limits message appears.

Picture is blank.

- The frequency of the signal from the video card is outside the operating range of the monitor.
 - * Use the graphics board's utility software to change the frequency setting (Refer to the manual for graphics board).
 - * You can change the setup to the supported resolution using the Windows 95/98 **Safety Mode** (Press the F8 key during booting the system.) or see User Manual for equivalent messages in other relevant Operating Systems.

The power LED is illuminated amber.

- Display power management mode.
- There is no active signal coming from the PC.
- The signal cable is not fastened securely.
- Check the computer power and graphics adapter configuration.

The image on the SCREEN is not centered.

- Image adjustment has not been performed for current mode. Select H position, V position and Clock via OSD and adjust to desired position.

The monitor does not enter the power saving off mode (Amber).

- Computer video signal is not VESA DPMS standard. Either the PC or the video controller card is not using the VESA DPMS power management function.

Noise in 50% Grey Background might sometimes be difficult to totally eliminate using Clock & Clock Phase Controls.

- Slight variations in timing from system unit's graphics sub-system. [Via Desktop change background pattern to solid colour].

Further Help

If you are unable to correct the problem yourself, you may seek further help as follows:

Call IBM HELPCENTER.

In the US call 1-800-772-2227

In Canada call 1-800-565-3344

In other countries, contact your dealer, retailer, or other IBM authorized servicer.

Before calling, please have available as much of the following information as possible:

1. Type, model and serial number from the label on the back of your monitor.
2. Purchase receipt.
3. Description of problem.
4. Computer type and model.
5. System configuration(hardware fitted etc.).
6. System BIOS version number.
7. Operating System and version number.
8. Display driver version number.

If possible, stay by your computer system. Your technical support representative might want to go through the problem with you during the call.

EMEA HelpDesk

This service is open Monday through Friday during normal business hours. IBM may change the availability of this service without any further notice.

Austria	01-54658-5060
Belgium	02-714-3515 (French)
Belgium	02-714-3570 (Vlaams)
Denmark	03-525-0291
Finland	9-22-931840
France	01-6932-4040
Germany	069-6654-9040
Ireland	01-8159202
Italy	02-482-75040
Luxembourg	298-977-5063
Netherlands	020-504-0501
Norway	2-305-3240
Portugal	01-7915147
	02-2071147
Spain	01-662-4916
Sweden	08-751-5227
Switzerland	0848-805252
UK	01475-555055

Specifications

Sync Signal type

Type	H. sync	V.sync
Separate sync	H. sync	V. sync

Signal Connector Pin Assignment

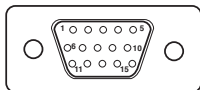

Pin	Separate Sync	Pin	Separate Sync
1	Red	9	NC
2	Green	10	Ground
3	Blue	11	Ground
4	Ground	12	SDA
5	Self-Test	13	Horizontal Sync
6	Red Ground	14	Vertical Sync
7	Green Ground	15	SCL
8	Blue Ground		

AC-DC Adapter

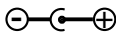
Input	AC 100-240V, 50-60Hz, 81-120VA, 1.2A
Out put	DC 24V 1.5A 

Use only the AC-DC adapter supplied with the monitor.

Specifications

Display	
Type	15.1inch (38.36cm) Flat Panel Active matrix-TFT LCD, Anti-Glare coating
Viewable Size	15.1inch (38.36cm)
Pixel pitch	0.3 x 0.3mm
True color	16.7million
Sync Input	
Horizontal Freq.	Refer to pages A12 and A13 for mode timing parameters
Vertical Freq.	Refer to pages A12 and A13 for mode timing parameters
Input form	Separate, TTL, Positive/Negative
Signal input	15 pin D-Sub connector
Video Input	
Display Area	307 x 230mm
Input Form	Separate, RGB Analog, 0.7Vp-p/75ohm, Positive
Resolution	XGA 1024 x 768/ 75Hz max
Power Input	DC 24V 1.2A
Dimensions (WxDxH)	15.95 x 7.17 x 14.25inch / 405 x 182 x 362mm
Weight (net)	5.4kg / 11.9lbs
Tilt Range	
Down	5°
Up	30°
Environment	
Operating condition	
Temperature	10°C to 35°C
Humidity	10% to 80% non-condensing
Storage condition	
Temperature	-20°C to 60°C
Humidity	5% to 95% non-condensing

Information in this document is subject to change without notice and does not represent a commitment on the part of IBM.

A20

Compliances

Federal Communications Commission (FCC) Statement

This equipment has been tested and found to comply with the limits for a Class B digital device, pursuant to Part 15 of the FCC Rules. These limits are designed to provide reasonable protection against harmful interference in a residential installation. This equipment generates, uses, and can radiate radio frequency energy and, if not installed and used in accordance with the instructions, may cause harmful interference to radio communications. However, there is no guarantee that interference will not occur in a particular installation. If this equipment does cause harmful interference to radio or television reception, which can be determined by turning the equipment off and on, the user is encouraged to try to correct the interference by one or more of the following measures:

- Reorient or relocate the receiving antenna.
- Increase the separation between the equipment and receiver.
- Connect the equipment into an outlet on a circuit different from that to which the receiver is connected.
- Consult an IBM authorized dealer or service representative for help.

Properly shielded and grounded cables and connectors must be used in order to meet FCC emission limits. Proper cables and connectors are available from IBM authorized dealers. IBM is not responsible for any radio or television interference caused by using other than recommended cables and connectors or by unauthorized changes or modifications to this equipment. Unauthorized changes or modifications could void the user's authority to operate the equipment.

Power Cords

For your safety, IBM provides a power cord with a grounded attachment plug to use with this IBM product. To avoid electrical shock, always use the power cord and plug with a properly grounded power outlet.

IBM power cords used in the United States and Canada are listed by the Underwriters Laboratories (UL) and certified by the Canadian Standards Association (CSA).

For units intended to be operated at 115 volts: Use a UL listed and CSA certified cord set consisting of a minimum 18 AWG, type SVT or SJT, three conductor cord, a maximum of 4.5 meters (15 feet) in length and a parallel blade, grounding type attachment plug rated 15 amperes, 125 volts.

For units intended to be operated at 230 volts (U.S. use): Use a UL listed and CSA certified cord set consisting of a minimum 18 AWG, type SVT or SJT, three conductor cord, a maximum of 4.5 meters (15 feet) in length and a tandem blade, grounding type attachment plug rated 15 amperes 250 volts.

For units intended to be operated at 230 volts (outside the U.S.): Use a cord set with a grounding type attachment plug rated 13 amperes (minimum), 250 volts. The cord set should be marked <HAR> and have the appropriate safety approvals for the country in which the equipment will be installed.



As an ENERGY STAR® Partner, IBM Corporation has determined that this product meets the ENERGY STAR guidelines for energy efficiency.

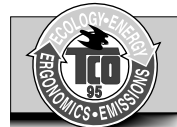

This monitor complies with TCO'95 guidelines.

MPRII

This product complies with Swedish National Council for Metrology (MPR) standards issued in December 1990 (MPRII) for very low frequency (VLF) and extremely low frequency (ELF).

Hinweise

Gemäß der Amtsblätter des BMPT Nr. 61/1991 und 6/1992 wird der Betreiber darauf aufmerksam gemacht, dass die von ihm mit diesem Gerät zusammengestellte Anlage auch den technischen Bestimmungen dieser Amtsblätter genügen muss.

Aus ergonomischen Gründen wird empfohlen, die Grundfarbe Blau nicht auf dunklem Untergrund zu verwenden (schlechte Erkennbarkeit, Augenbelastung bei zu geringem Zeichenkontrast).

Aus ergonomischen Gründen sollten nur Darstellungen auf dunklem Hintergrund bei Vertikalfrequenzen ab 60 Hz (ohne Zeilensprung) benutzt werden.

Die Konvergenz des Bildes kann sich aufgrund des Magnetfeldes am Ort der Aufstellung aus der korrekten Grundeinstellung verändern. Zur Korrektur empfiehlt es sich deshalb, die Regler an der Frontseite für H STAT und V STAT so einzustellen, daß die getrennt sichbaren Farblinien für Rot, Grün und Blau bei z.B. der Darstellung eines Buchstabens zur Deckung (Konvergenz) gelangen. Siehe hierzu auch die Erklärungen zu H STAT und V STAT.

Industry Canada Compliance Statement

This Class B digital apparatus meets the requirements of the Canadian Interference-Causing Equipment Regulations.

Cet appareil numérique de la classe B respecte toutes les exigences du Règlement sur le matériel brouilleur du Canada.

European Union (EU) Statement

This product has been tested and found to comply with the limits for Class B Information Technology Equipment according to CISPR 22 / European Standard EN 55022. The limits for Class B equipment were derived for typical residential environments to provide reasonable protection against interference with licensed communication devices.

Properly shielded and grounded cables and connectors must be used in order to reduce the potential for causing interference to radio and TV communications and to other electrical or electronic equipment. Such cables and connectors are available from IBM authorised dealers.

In accordance with EN 50082-1 1992, Performance Criterion A., it should be noted that in the presence of certain electromagnetic fields, some screen jitter may be observed.

æ u dgÆQ' K§ ´ç~
- u" A æ æ u iz n "» %n □ç~gp†ÆØ « æ u j~Z n - d
gÆQh~ I~ % æ u dgÆQ' K§fc ivCCI j K ~□L • B
' A{ u WI Ae rW M@ ~†gp "Ø~ A MÆQ . ~"Ø-~" L • B
]~†ç L ç ~> †ç B
x {»i }j A L "çß@~†fi"~ {•Ø-~"°fl~• - A , fl~> †ç B
! ' gEXC[x X^ h Ltfl A L O E " -†Æ~çØ@ d,, It A -†
E~çØP[u • ~O ~' s~> †ç B

Environmental Labelling of Personal Computers



Congratulations! You have just purchased a TCO'95 approved and labelled product! Your choice has provided you with a product developed for professional use. Your purchase has also contributed to reducing the burden on the environment and to the further development of environmentally-adapted electronic products.

Why do we have environmentally-labelled computers?

In many countries, environmental labelling has become an established method for encouraging the adaptation of goods and services to the environment.

The main problem as far as computers and other electronic equipment are concerned is that environmentally harmful substances are used both in the products and during their manufacture. Since it has not been possible so far for the majority of electronic equipment to be recycled in a satisfactory way, most of these potentially damaging substances sooner or later enter Nature.

There are also other characteristics of a computer, such as energy consumption levels, that are important from both the working and natural environment viewpoints. Since all types of conventional electricity generation have a negative effect on the environment (acidic- and climatic-influencing emissions, radioactive waste, etc.), it is vital to conserve energy. Electronic equipment in offices consumes an enormous amount of energy, since it is often routinely left running continuously.

What does labelling involve?

This product meets the requirements for the TCO'95 scheme, which provides for international environmental labelling of personal computers. The labelling scheme was developed as a joint effort by the TCO (The Swedish Confederation of Professional Employees), Naturkyddsföreningen (The Swedish Society for Nature Conservation), and NUTEK (The National Board for Industrial and Technical Development in Sweden), and SEMKO AB (an international certification agency).

Environmental Labelling of Personal Computers

The requirements cover a wide range of issues: environment, ergonomics, usability, emission of electrical and magnetic fields, energy consumption and electrical and fire safety.

The environmental demands concern, among other things, restriction on the presence and use of heavy metals, brominated and chlorinated flame retardants, CFCs (freons), and chlorinated solvents. The product must be prepared for recycling, and the manufacturer is obliged to have an environmental plan, which must be adhered to in each country where the company implements its operational policy.

The energy requirements include a demand that the computer and/or display, after a certain period of inactivity, shall reduce its power consumption to a lower level, in one or more stages. The length of time to reactivate the computer shall be reasonable for the user.

Labelled products must meet strict environmental demands, for example, in respect of the reduction of electric and magnetic fields, along with physical and visual ergonomics and good usability.

The following is a brief summary of the environmental requirements met by this product. The complete environmental criteria document may be ordered from:

TCO Development Unit
Linnegatan 14, S-11494 Stockholm, Sweden
FAX +46-8 782 92 07
E-mail (Internet): development@tco.se

Current information regarding TCO'95 approved and labelled products may also be obtained on the Internet using the address:

<http://www.tco-info.com/>

TCO'95 is a co-operative project between:



Naturskydds
föreningen



NUTEK

Närings- och teknikutvecklingsverket

SEMKO

TCO'95 Environmental Requirements

Brominated flame retardants are present in printed circuit boards, cabling, casings, and housings, and are added to delay the spread of fire. Up to 30% of the plastic in a computer casing can consist of flame-retardant substances. These are related to another group of environmental toxins, PCBs, and are suspected of giving rise to similar harm, including reproductive damage in fish-eating birds and mammals. Flame retardants have been found in human blood, and researchers fear that they can disturb fetus development.

Bio-accumulative¹ TCO'95 demands require that plastic components weighing more than 25 grams must not contain flame retardants with organically bound chlorine or bromine.

Lead can be found in picture tubes, display screens, solder, and capacitors. Lead damages the nervous system and in higher doses causes lead poisoning. The relevant bio-accumulative TCO'95 requirement permits the inclusion of lead, as no replacement has yet been developed.

Cadmium is present in rechargeable batteries and in the color-generating layers of certain computer displays. Cadmium damages the nervous system and is toxic in high doses. The relevant bio-accumulative TCO'95 requirement states that batteries may not contain more than 25 ppm (parts per million) of cadmium. The color-generating layers of display screens must not contain any cadmium.

Mercury is sometimes found in batteries, relays and switches. Mercury damages the nervous system and is toxic in high doses.

TCO'95 requirement states that batteries may not contain more than 25 ppm (parts per million) of mercury. It also demands that no mercury is present in any of the electrical or electronics components concerned with the display unit. Mercury is, for the time being, permitted in the back light system of flat panel monitors as there today is no commercially available alternative. TCO aims on removing this exception when a mercury free alternative is available.

CFCs (freons) are sometimes used for washing printed circuit boards and in the manufacture of expanded foam for packaging. CFCs break down ozone and thereby damage the ozone layer in the atmosphere, causing increased reception on Earth of ultra-violet light with consequent increased risks of skin cancer (malignant melanoma). The relevant TCO'95 requirement: Neither CFCs nor HCFCs may be used during the manufacture of the product or its packaging.

Environmental Labelling of Personal Computers

Shipping Package

The packaging material can be recycled, or you can save it to return the monitor to a service center for repair or disposal.

CFC Compounds in Distribution Packaging

Cushioning material used for shipping finished monitors are not manufactured with nor do they contain any CFC compounds.

Design for Disassembly/Recycling

These monitors have been designed for easy end-of-life disassembly and recycling. Fasteners are generally of the same type for efficient disassembly. Components made of different materials can be easily separated and plastics have been identified using international symbols to aid in recycling.

Monitor Disposal

WARNING

If you need to dispose of a monitor, ask a qualified service representative for the proper procedure.

Warranty

Statement of Limited Warranty

The warranties provided by IBM in this Statement of Limited Warranty apply only to Machines you originally purchase for your use, and not for resale, from IBM or your reseller. The term "Machine" means an IBM machine, its features, conversions, upgrades, elements, or accessories, or any combination of them. Unless IBM specifies otherwise, the following warranties apply only in the country where you acquire the Machine. If you have any questions, contact IBM or your reseller.

Machine:	9483
Warranty Period*:	Three years
*Contact your place of purchase for warranty service information.	

Production Status

Each Machine is manufactured from new parts, or new and used parts. In some cases, the Machine may not be new and may have been previously installed. Regardless of the Machine's production status, IBM's warranty terms apply.

The IBM Warranty for Machines

IBM warrants that each Machine 1) is free from defects in materials and workmanship and 2) conforms to IBM's Official Published Specifications. The warranty period for a Machine is a specified, fixed period commencing on its Date of Installation. The date on your receipt is the Date of Installation, unless IBM or your reseller informs you otherwise.

During the warranty period IBM or your reseller, if authorized by IBM, will provide warranty service under the type of service designated for the Machine and will manage and install engineering changes that apply to the Machine.

For IBM or your reseller to provide warranty service for a feature, conversion, or upgrade, IBM or your reseller may require that the Machine on which it is installed be 1) for certain Machines, the designated, serial-numbered Machine and 2) at an engineering-change level compatible with the feature, conversion, or upgrade. Many of these transactions involve the removal of parts and their return to IBM. You represent that all removed parts are genuine and unaltered. A part that replaces a removed part will assume the warranty service status of the replaced part.

If a Machine does not function as warranted during the warranty period, IBM or your reseller will repair it or replace it with one that is at least functionally equivalent, without charge. The replacement may not be new, but will be in good working order. If IBM or your reseller is unable to repair or replace the Machine, you may return it to your place of purchase and your money will be refunded.

If you transfer a Machine to another user, warranty service is available to that user for the remainder of the warranty period. You should give your proof of purchase and this Statement to that user. However, for Machines which have a life-time warranty, this warranty is not transferable.

Warranty Service

To obtain warranty service for the Machine, you should contact your reseller or call IBM. In the United States, call IBM at 1-800-772-2227. In Canada, call IBM at 1-800-565-3344. You may be required to present proof of purchase.

IBM or your reseller will provide certain types of repair and exchange service, either at your location or at IBM's or your reseller's service center, to restore a Machine to good working order.

When a type of service involves the exchange of a Machine or part, the item IBM or your reseller replaces becomes its property and the replacement becomes yours. You represent that all removed items are genuine and unaltered. The replacement may not be new, but will be in good working order and at least functionally equivalent to the item replaced. The replacement assumes the warranty service status of the replaced item. Before IBM or your reseller exchanges a Machine or part, you agree to remove all features, parts, options, alterations, and attachments not under warranty service. You also agree to ensure that the Machine is free of any legal obligations or restrictions that prevent its exchange.

Warranty

You agree to:

1. obtain authorization from the owner to have IBM or your reseller service a Machine that you do not own; and
2. where applicable, before service is provided -
 - a) follow the problem determination, problem analysis, and service request procedures that IBM or your reseller provide,
 - b) secure all programs, data, and funds contained in a Machine, and
 - c) inform IBM or your reseller of changes in a Machine's location.

IBM is responsible for loss of, or damage to, your Machine while it is 1) in IBM's possession or 2) in transit in those cases where IBM is responsible for the transportation charges.

Extent of Warranty

IBM does not warrant uninterrupted or error-free operation of a Machine.

The warranties may be voided by misuse, accident, modification, unsuitable physical or operating environment, improper maintenance by you, removal or alteration of Machine or parts identification labels, or failure caused by a product for which IBM is not responsible.

THESE WARRANTIES REPLACE ALL OTHER WARRANTIES OR CONDITIONS, EXPRESS OR IMPLIED, INCLUDING, BUT NOT LIMITED TO, THE IMPLIED WARRANTIES OR CONDITIONS OF MERCHANTABILITY AND FITNESS FOR A PARTICULAR PURPOSE. THESE WARRANTIES GIVE YOU SPECIFIC LEGAL RIGHTS AND YOU MAY ALSO HAVE OTHER RIGHTS WHICH VARY FROM JURISDICTION TO JURISDICTION. SOME JURISDICTIONS DO NOT ALLOW THE EXCLUSION OR LIMITATION OF EXPRESS OR IMPLIED WARRANTIES, SO THE ABOVE EXCLUSION OR LIMITATION MAY NOT APPLY TO YOU. IN THAT EVENT SUCH WARRANTIES ARE LIMITED IN DURATION TO THE WARRANTY PERIOD. NO WARRANTIES APPLY AFTER THAT PERIOD.

Limitation of Liability

Circumstances may arise where, because of a default on IBM's part or other liability you are entitled to recover damages from IBM. In each such instance, regardless of the basis on which you are entitled to claim damages from IBM (including fundamental breach, negligence, misrepresentation, or other contract or tort claim), IBM is liable only for:

1. damages for bodily injury (including death) and damage to real property and tangible personal property; and
2. the amount of any other actual direct damages or loss, up to the greater of U.S. \$100,000 or the charges (if recurring, 12 months' charges apply) for the Machine that is the subject of the claim.

UNDER NO CIRCUMSTANCES IS IBM LIABLE FOR ANY OF THE FOLLOWING: 1) THIRD-PARTY CLAIMS AGAINST YOU FOR LOSSES OR DAMAGES (OTHER THAN THOSE UNDER THE FIRST ITEM LISTED ABOVE); 2) LOSS OF, OR DAMAGE TO, YOUR RECORDS OR DATA; OR 3) SPECIAL, INCIDENTAL, OR INDIRECT DAMAGES OR FOR ANY ECONOMIC CONSEQUENTIAL DAMAGES (INCLUDING LOST PROFITS OR SAVINGS), EVEN IF IBM OR YOUR RESELLER IS INFORMED OF THEIR POSSIBILITY. SOME JURISDICTIONS DO NOT ALLOW THE EXCLUSION OR LIMITATION OF INCIDENTAL OR CONSEQUENTIAL DAMAGES, SO THE ABOVE EXCLUSION OR LIMITATION MAY NOT APPLY TO YOU.

- For European warranty terms and conditions refer to enclosed IBM warranty statement Part Number 72H9623.
- Référez-vous à la garantie IBM N° de référence 72H9623 pour les conditions de garantie européennes.
- Die europäischen Garantiebedingungen finden Sie in der beigefügten IBM-Gewährleistungserklärung. Teilenummer 72H9623.
- Los términos y condiciones de las garantías en Europa se recogen en la declaración de garantía adjunta numero de pieza IBM 72H9623.
- Per le condizioni e i termini di garanzia relativi ai paesi europei, consultare l'apposita dichiarazione IBM (numero di matricola 72H9623).

Free Manuals Download Website

<http://myh66.com>

<http://usermanuals.us>

<http://www.somanuals.com>

<http://www.4manuals.cc>

<http://www.manual-lib.com>

<http://www.404manual.com>

<http://www.luxmanual.com>

<http://aubethermostatmanual.com>

Golf course search by state

<http://golfingnear.com>

Email search by domain

<http://emailbydomain.com>

Auto manuals search

<http://auto.somanuals.com>

TV manuals search

<http://tv.somanuals.com>